



RVI

Catalogue Reference

WEWELER-COLAERT

tel. +32 57 346 222 / +32 57 346 227

fax. +32 57 346 208

Beneluxlaan 1-3 B 8970 Poperinge - Belgium

info@colaert.be



RVI

- 1 -Index types
- 2 -Info
- 3 -Vormen - formes -
shapes - Formen
- 4 Catalogus - catalogue
Katalog
- 5 -Toebehoren -
accessoires

Alle gegevens vermeld in deze catalogus werden zorgvuldig verzameld . Wij kunnen geen schadevergoedingen aanvaarden voor eventuele foutieve weergaven .

Toutes les données ont été assemblées soigneusement . Nous ne pouvons pas accepter des recours en indemnisation résultants d'une faute d'inadvertance commise lors de l'établissement du catalogue .

All data were carefully compiled . We cannot accept any claims for compensation due to errors inadvertently made in this catalogue .

Alle Daten wurden sorgfältig erarbeitet . Ersatzansprüche aufgrund von Angaben in diesem Katalog können nicht anerkannt werden .

NL Afkortingen

Voor	: voorveer
A/H	: achter-/hoofdveer+hulpveer
Achter	: achterveer
H	: hulpveer
Bladen	: aantal bladen
BR	: breedte
B	: lengte voor
C	: lengte achter
D1	: busdiam voor
D2	: busdiam achter
R	: oog zonder bus
D....	: draadbus
N....	: nylonbus
P....	: shackle pin
S....	: silentbloc
PH	: pijlhoogte
PAK	: pakketdikte

F Abbreviations

Voor	: ressort avant
A/H	: ressort principal/arrière+auxiliaire
Achter	: ressort arrière
H	: ressort auxiliaire
Lames	: nombre de lames
LRG	: largeur
B	: longueur avant
C	: longueur arrière
D1	: diamètre intérieur des douilles, av.
D2	: diamètre intérieur des douilles, ar.
R	: rouleau sans douille
D....	: rouleau avec bague filetée
N....	: rouleau avec bague nylon
P....	: shackle pin
S....	: silentbloc
FL	: flèche à vide
EP	: épaisseur du paquet

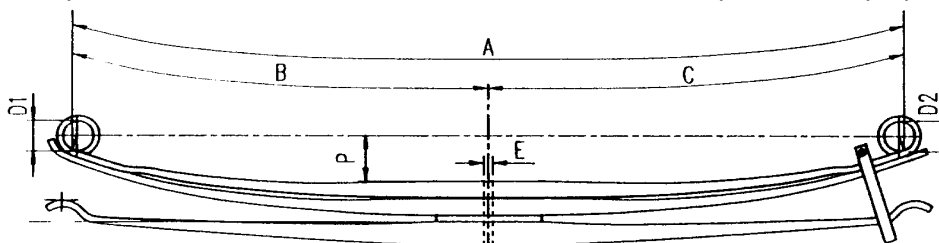

GB Abbreviations

Voor	: front spring
A/H	: main/rear spring+helper
Achter	: rear spring
H	: helper
Leaves	: number of leaves
WID	: width
B	: length front
C	: length rear
D1	: inside diam of front bushes
D2	: inside diam of rear bushes
R	: eye without bush
D....	: threaded bushing
N....	: nylon bushing
P....	: shackle pin
S....	: silentbloc
FA	: free arch
TH	: total height

D Kurzbezeichnungen

Voor	: Vorderfeder
A/H	: Hinter-/Hauptfeder+Zusatzfeder
Achter	: Hinterfeder
H	: Zusatzfeder
Blatt.	: Blattzahl
BR	: Breite
B	: Länge vorne
C	: Länge hinten
D1	: Büchsen diam innen vorne
D2	: Büchsen diam innen hinten
R	: Rolle ohne Büchsen
D....	: Gewinde Büchsen
N....	: Nylon Büchsen
P....	: Shackle pin
S....	: Silentbloc
SP	: Sprengung unbelastet
PAK	: Paketdicke

A01

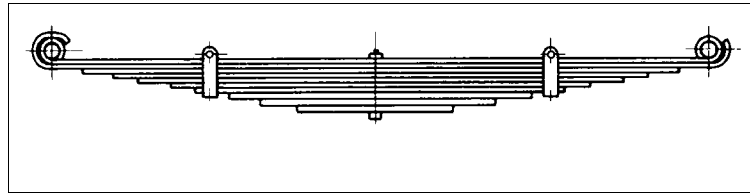

A01.61

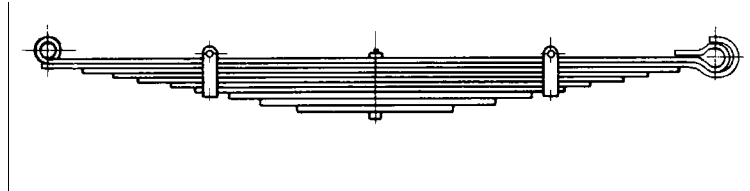

A01.62

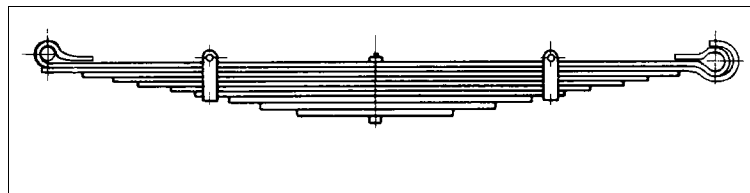

A01.71

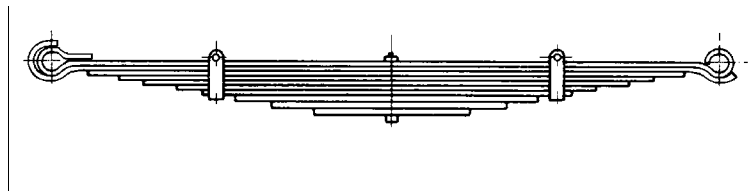

A01A

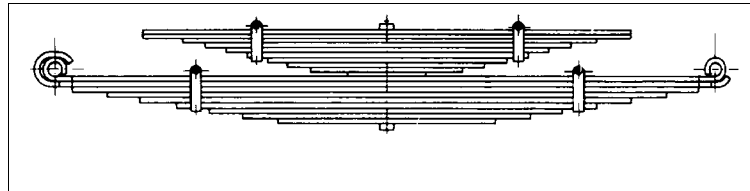

A01B

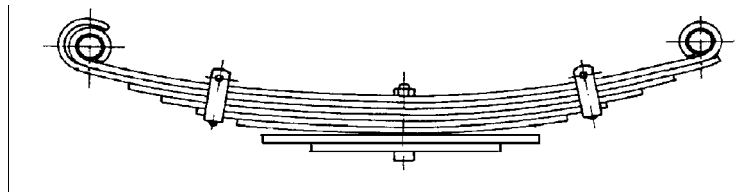

A03

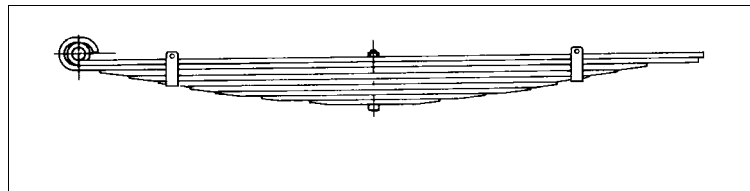

A03.71

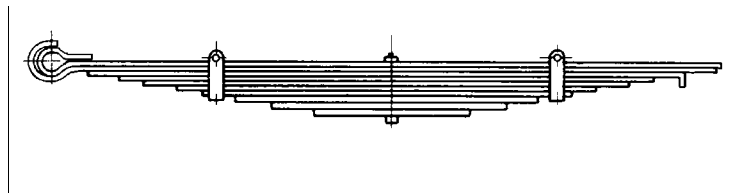

A03A

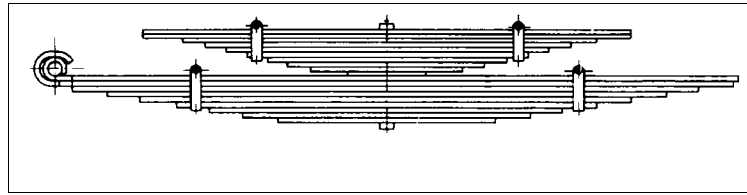

A03B

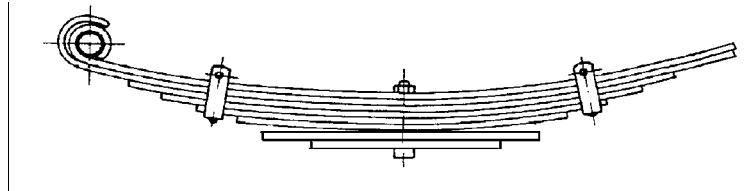

A03t

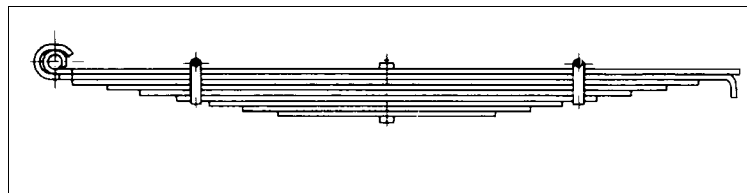

A03tA

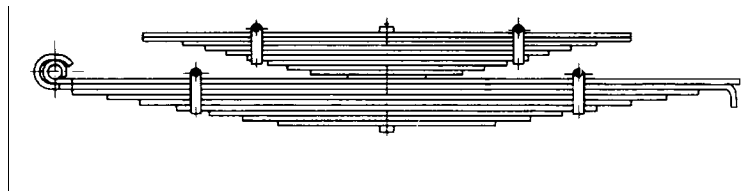

A03tB

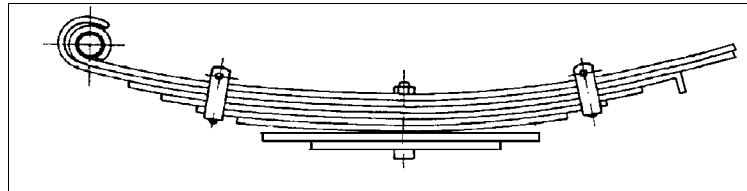

A08

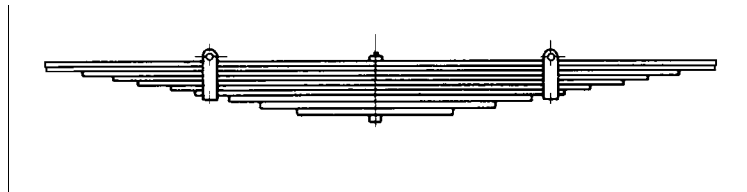

A08R

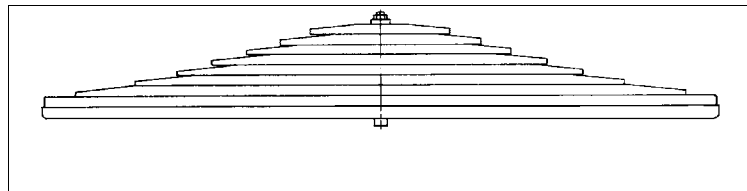

A08tt

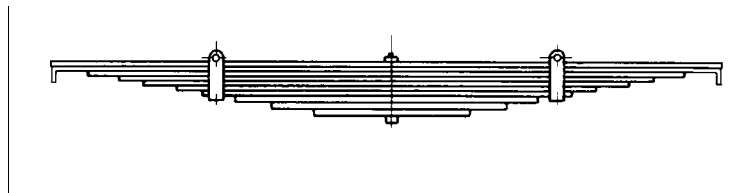

A10R

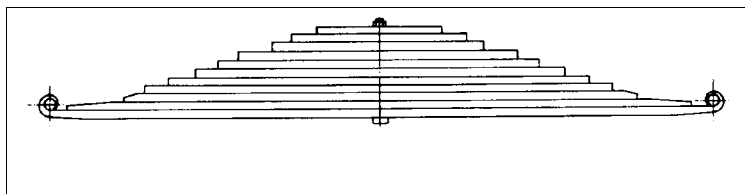

F01

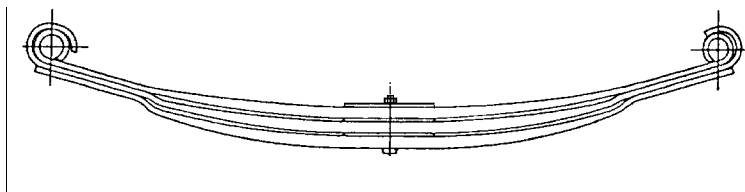

F01.10

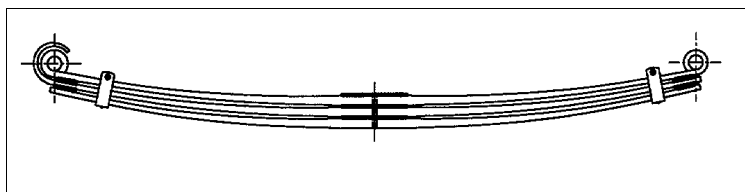

F01.60

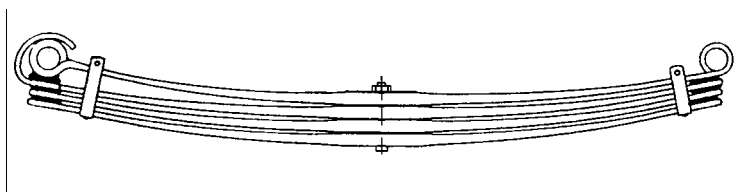

F01.70

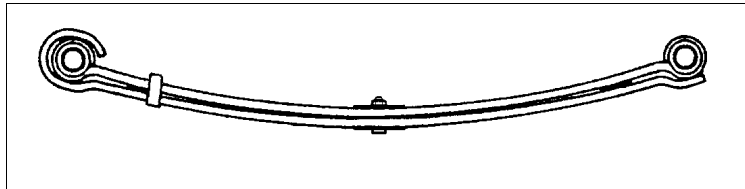

F01A

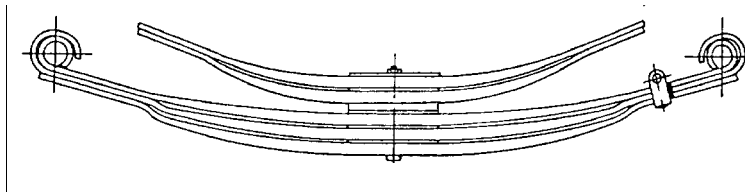

F01B

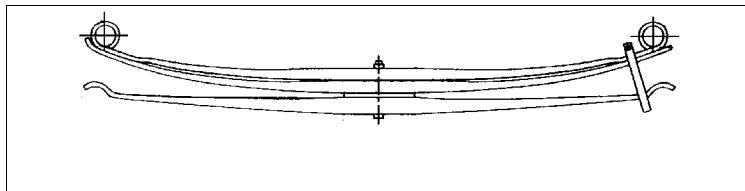

F01B.70

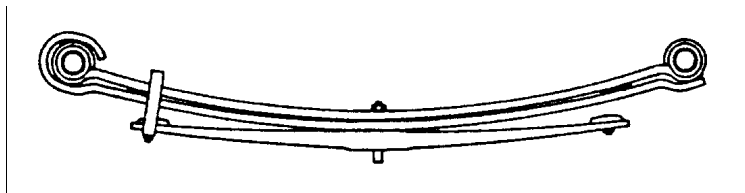

F03

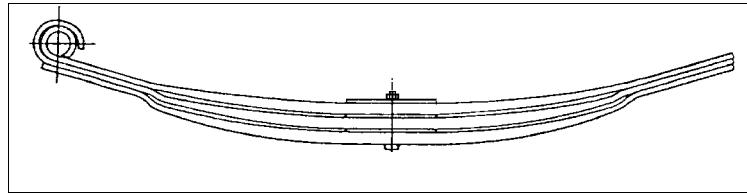

F03.02

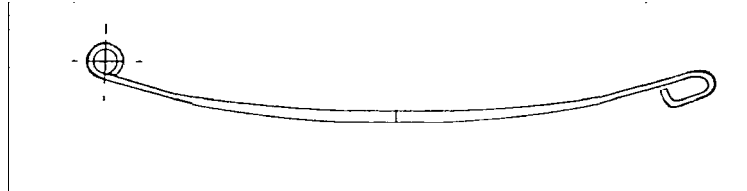

F03.10

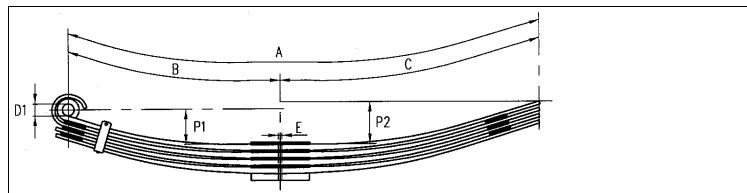

F03A

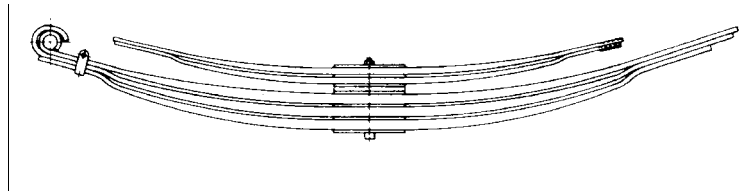

F03B

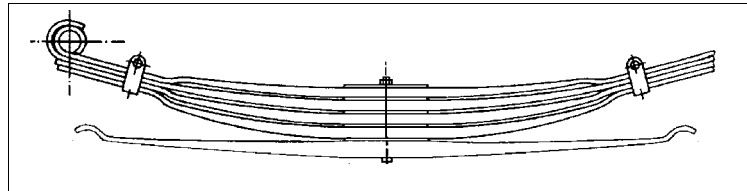

F03t

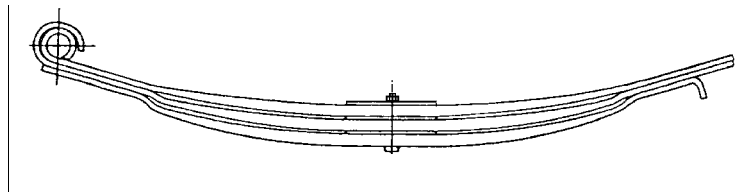

F08

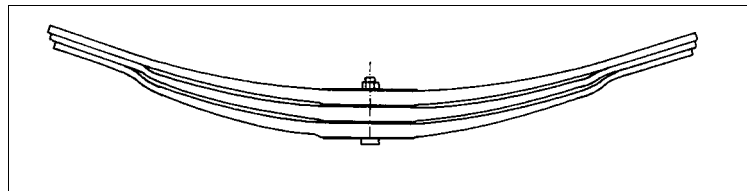

F08R

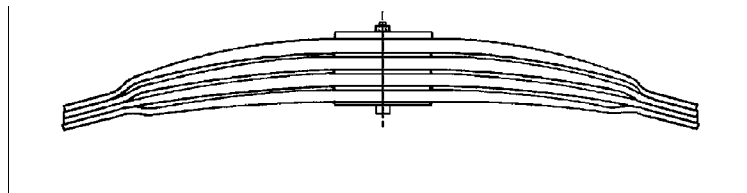

F74.31

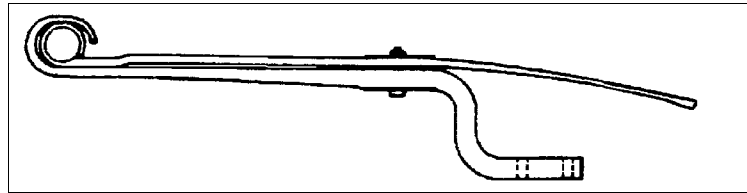

LK1214.1

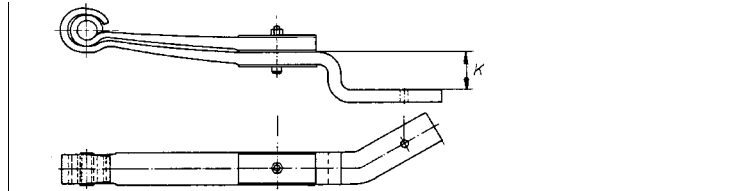

LK4154

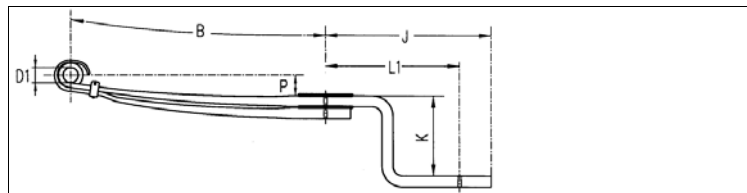

LK4528

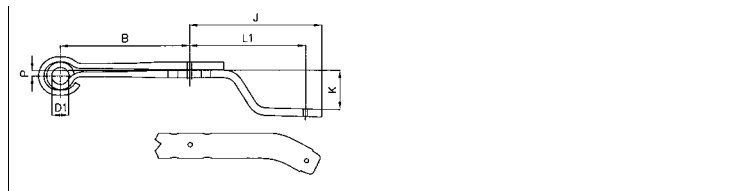

LR0211.1

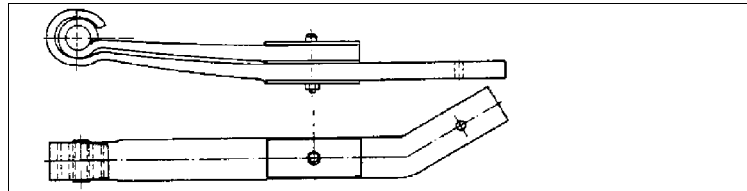

LR2250

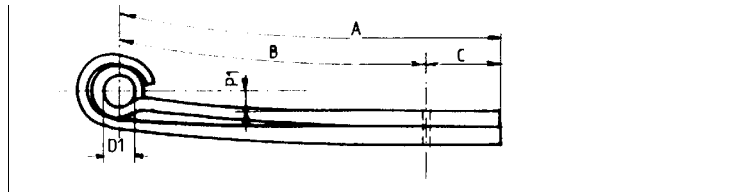

LR7710

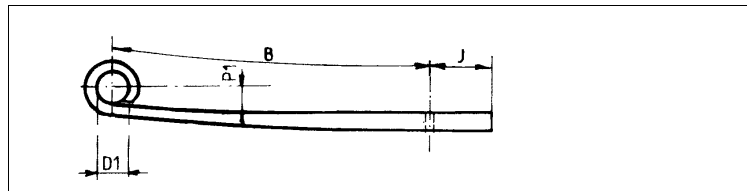

Index types

Serie

RVI

--- K	380K
	440K
	500K
	560K
	600KB
	610K6
	770KB
	770KB6SP
	880K
	880KB
	881KB
	950KB
	950KBT6
AE-MAGNUM	AE 380 4x2
	AE 380 6x2
	AE 380 6x4
	AE 385TI
	AE 385TI 4x2
	AE 385TI 6x2
	AE 385TI 6x4
	AE 390 4x2
	AE 390 6x2

Index types

Serie

RVI

AE-MAGNUM

AE 420TI

AE 420TI 4x2

AE 420TI 6x2

AE 420TI 6x4

AE 430 4x2

AE 430 6x2

AE 430 6x4

AE 470 6x4

AE 500 4x2

AE 500 6x2

AE 500 6x4

AE 520 4x2

AE 520 6x2

AE 520 6x4

AE 560 4x2

AE 560 6x2

AE 560 6x4

B-MESSENGER

B 70

B 80

B 90

B 90 4x4

B110

Index types

Serie

RVI

B-MESSENGER

B120

C

C210 4x2

C230 4x2

C230 4x4

C260 4x2

C260 4x4

C260 6x4

C280 4x2

C280 4x4

C280 6x4

C290 4x2

C290 4x4

C290 6x4

C300 4x2

C300 4x4

C300 6x4

C340TI 4x2

C340TI 4x4

C340TI 6x4

CBH

CBH280 4x2

CBH280 6x4

CBH280 6x6

Index types

Serie

RVI

CBH CBH320 6x4

CBH320 6x6

CBH340 4x2

CBH340 6x4

CBH340 6x6

CBH350 6x4

CBH350 6x6

CBH380 6x4

CBH380 6x6

CBH385 6x4

CBH385 6x6

CLM CLM240

CLM280 4x2

CLM320 4x2

CLM340 4x2

CLM350 4x2

CLM380 4x2

CLM385 4x2

CLR CLR220 4x2

CLR220 4x4

CLR230 4x2

CLR230 4x4

Index types

Serie

RVI

G	G170
	G200
	G210
	G220
	G230
	G230SP
	G230TI
	G260
	G270
	G270 6x2
	G270 8x4
	G280
	G280 6x2
	G280 8x4
	G290
	G300
	G300 6x2
	G300 6x4
	G300 8x4
	G320
	G330
	G330 6x2

Index types

Serie

RVI

G G330 8x4

G340TI

G340TI 4x2

G340TI 4x4

G340TI 6x2

G340TI 6x4

G340TI 8x4

G340TI 6x6

GB GB191

GB231

GBH GBH12 6x4

GBH12 6x6

GBH260 6x4

GBH260 6x6

GBH280 6x4

GBH280 6x6

GC GC190

GC191

GC231

GF GF191

GF231

GL GL750

Index types

Serie

RVI

GLC	GLC190
-----	--------

GLM	GLM280
-----	--------

GLR	GLR160
-----	--------

	GLR190
--	--------

	GLR200
--	--------

	GLR230 4x2
--	------------

	GLR230 4x4
--	------------

	GLR250
--	--------

GR	GR190
----	-------

	GR191
--	-------

	GR200
--	-------

	GR205
--	-------

	GR205A
--	--------

	GR205B
--	--------

	GR231
--	-------

	GR250
--	-------

	GR250A
--	--------

	GR260
--	-------

	GR280
--	-------

	GR280A
--	--------

	GR280B
--	--------

	GR280T
--	--------

Index types

Serie

RVI

GR GR305

GR320

GR320B

GR350

GRH GRH235 6x4

GRH235R 6x4

GRH305 6x4

GRH350 6x4

KERAX KER 4x2

KER 6x4

KER 8x4

MASCOTT 3,5 T CABINE

3,5 T CABINE SURBAISSEE

5,5 T FOURGON

5,5-6,5 T

5,5-6,5 T CABINE

MASCOTT2 3,5 - 5,0 T

3,5 T SURBAISSEE

5,5 - 6,0 T

MASTER OLD ALL

MASTER 1997 2,8 T

3,3 - 3,5 T

Index types

Serie

RVI

MASTER 1997 MONOLAME

PNEUM

VERHOOGD

MASTER2 2003 2,8 T

3,3 - 3,5 T

MONOLAME

PNEUM

VERHOOGD

MIDLINER-C CE160

MIDLINER-M M 140

M 150

M 160

M 180

M 180FPT

M 200

M 210

M 230

M 230TI

M 250

ME160

ME180

MIDLINER-S S 90-09

Index types

Serie

RVI

MIDLINER-S S 100-06/07/08

S 100-09

S 110

S 120

S 130-06/08/09

S 130-11

S 130-13

S 130-14

S 135

S 140

S 150

S 150-06/08/09

S 150-11

S 150-13

S 150-14

S 160

S 170

S 170 4x4

S 170-11

S 170-13

S 180

S 210

Index types

Serie

RVI

MIDLINER-S

S 220

SE160

SE180

MIDLUM

MI41B1

MI41B2

MI42B1

MI42B2

MI42B3

MI42B4

MI43B2

MI43C1

MI43C2

MI43E1

MI43E2

MI43T

MI43V

MI44C1

MI44C2

MI44D2

MI44D3

MI44T

MI44V

Index types

Serie

RVI

MIDLUM

MI45D2

MI45D3

MI45E2

PREMIUM

PR 4x2

PR 6x2

PR 6x2/4

TR 4x2

R

R 310 4x2

R 310 6x4

R 310T 4x2

R 310TD 4x2

R 340TI 4x2

R 340TI 6x2

R 350 6x4

R 350 4x2

R 350 6x2

R 370 4x2

R 370 6x2

R 370 6x4

R 370T 4x2

R 380 4x2

R 380 6x2

Index types

Serie

RVI

R	R 380 6x4
	R 385TI 4x2
	R 385TI 6x2
	R 385TI 6x4
	R 390 4x2
	R 390 6x2
	R 390 6x4
	R 390T 4x2
	R 420 4x2
	R 420 6x2
	R 420 6x4
	R 420T 4x2
	R 420TI 4x2
	R 420TI 6x2
	R 420TI 6x4
	R 6X4TS 4x2
	R 6X4TS 6x2
	R 6X4TS 6x4
	RI 357 4x2
	RI 357 6x2
	RI 357 6x4

TRAFFIC

ALL

BESTELNR N° COMMANDE ORDER NR BESTELNR	BR LRG WID BR	BLADEN LAMES LEAVES BLATT.	B	C	D1	D2	PH FL FA SP	PAK EP TH PAK	DETAIL	MOD	OPMERKINGEN REMARQUES REMARKS BEMERKUNGEN
---	------------------------	-------------------------------------	---	---	----	----	----------------------	------------------------	--------	-----	--

SERIE : ---K

380K

voor-avant-front-Vorne

A064T019ZA75	60	10	550	670	20	20				A01	
A064T027ZA75	60	9/3	670	670	20	20				A01	
A064T031ZA75	60	8/3	700	700	20	20				A01	

achter-arrière-rear-Hinten

A064T012ZA75											
A064T004ZA76	75	8/6	700	700	25	25				A01A	
A064T004ZA75	75	8	700	700	25	25				A01	
A064T004HA80	75	6	515	515	--	--				A08	

440K

voor-avant-front-Vorne

A064T027ZA75	60	9/3	670	670	20	20				A01	
A064T031ZA75	60	8/3	700	700	20	20				A01	

achter-arrière-rear-Hinten

A064T012ZA75											
--------------	--	--	--	--	--	--	--	--	--	--	--

500K

voor-avant-front-Vorne

A124T125ZA75	60	2/11	630	675	20	20		106	2/9+11/8	A01	
A064T029ZA75	60	11/1	670	670	20	20				A01	

achter-arrière-rear-Hinten

A064T010ZA75											
A064T014ZA75											

BESTELNR N° COMMANDE ORDER NR BESTELNR	BR LRG WID BR	BLADEN LAMES LEAVES BLATT.	B	C	D1	D2	PH FL FA SP	PAK EP TH PAK	DETAIL	MOD	OPMERKINGEN REMARKS BEMERKUNGEN
---	------------------------	-------------------------------------	---	---	----	----	----------------------	------------------------	--------	-----	---------------------------------------

SERIE : --- K

560K

voor-avant-front-Vorne

A064T029ZA75	60	11/1	670	670	20	20					A01
--------------	----	------	-----	-----	----	----	--	--	--	--	-----

achter-arrière-rear-Hinten

A064T014ZA75											
--------------	--	--	--	--	--	--	--	--	--	--	--

600KB

voor-avant-front-Vorne

A124T105ZA75	75	8	750	750	22	22	135	87	1/12+5/11+2/10		A01
--------------	----	---	-----	-----	----	----	-----	----	----------------	--	-----

achter-arrière-rear-Hinten

	A124T106ZA76	75	9/2P/7	700	850	28	--				A03A
A	A124T106ZA75	75	9	700	850	28	--				A03
H	A124T106HA80	75	7/2P	580	580	--	--				A08

770KB

voor-avant-front-Vorne

A124T107ZA75	75	6/1	700	700	38	38		76	6/11+1/10		A01
A124T079ZA75	75	8	750	750	22	22	125	88	2/12+4/11+2/10		A01

achter-arrière-rear-Hinten

	A124T110ZA76	75	6/2P/9/1	700	850	28	--		167	6/11+2P/10+9/8+	A03A
A	A124T110ZA75	75	9	700	850	28	--				A03
H	A124T108HA80	75	7/2P	580	580	--	--				A08
	A124T108ZA76	75	10/P/9	700	850	38	--		181	10/10+P/9+9/8	A03A
A	A124T108ZA75	75	11	700	850	38	--				A03
H	A124T108HA80	75	7/2P	580	580	--	--				A08

BESTELNR N° COMMANDE ORDER NR BESTELNR	BR LRG WID BR	BLADEN LAMES LEAVES BLATT.	B	C	D1	D2	PH FL FA SP	PAK EP TH PAK	DETAIL	MOD	OPMERKINGEN REMARQUES REMARKS BEMERKUNGEN
---	------------------------	-------------------------------------	---	---	----	----	----------------------	------------------------	--------	-----	--

SERIE : --- K**770KB6SP****voor-avant-front-Vorne**

A124T113ZA75	75	8/P	750	750	22	22		100	1/12+4/11+3/10+	A01
--------------	----	-----	-----	-----	----	----	--	-----	-----------------	-----

achter-arrière-rear-Hinten

A	A124T112ZA76	75	6/2/P/11	700	850	28	--		183	6/11+2/10+P/9+1	A03A
	A124T110ZA75	75	9	700	850	28	--				A03
H	A124T112HA80	75	10/P	580	580	--	--				A08

880K**voor-avant-front-Vorne**

A124T107ZA75	75	6/1	700	700	38	38		76	6/11+1/10	A01
--------------	----	-----	-----	-----	----	----	--	----	-----------	-----

achter-arrière-rear-Hinten

A	A124T112ZA76	75	6/2/P/11	700	850	28	--		183	6/11+2/10+P/9+1	A03A
	A124T110ZA75	75	9	700	850	28	--				A03
H	A124T112HA80	75	10/P	580	580	--	--				A08

880KB**voor-avant-front-Vorne**

A124T079ZA75	75	8	750	750	22	22	125	88	2/12+4/11+2/10	A01
--------------	----	---	-----	-----	----	----	-----	----	----------------	-----

achter-arrière-rear-Hinten

A	A124T112ZA76	75	6/2/P/11	700	850	28	--		183	6/11+2/10+P/9+1	A03A
	A124T110ZA75	75	9	700	850	28	--				A03
H	A124T112HA80	75	10/P	580	580	--	--				A08

881KB**voor-avant-front-Vorne**

A124T079ZA75	75	8	750	750	22	22	125	88	2/12+4/11+2/10	A01
--------------	----	---	-----	-----	----	----	-----	----	----------------	-----

achter-arrière-rear-Hinten

A	A124T084ZA76	75	9/P/8	700	850	28	--	112	179		A03A
	A124T084ZA75	75	9	700	850	28	--	112	98	8/11+1/10	A03
H	A124T084HA80	75	8/P	580	580	--	--	102	81	8/9+P/9	A08

BESTELNR N° COMMANDE ORDER NR BESTELLNR	BR LRG WID BR	BLADEN LAMES LEAVES BLATT.	B	C	D1	D2	PH FL FA SP	PAK EP TH PAK	DETAIL	MOD	OPMERKINGEN REMARQUES REMARKS BEMERKUNGEN
--	------------------------	-------------------------------------	---	---	----	----	----------------------	------------------------	--------	-----	--

SERIE : ---K

950KB

voor-avant-front-Vorne

A124T113ZA75	75	8/P	750	750	22	22		100	1/12+4/11+3/10+	A01
--------------	----	-----	-----	-----	----	----	--	-----	-----------------	-----

achter-arrière-rear-Hinten

	A124T114ZA76	90	9/9	750	920	24	--		162	1/12+6/10+2/9+9/	A03A
A	A124T114ZA75	90	9	750	920	24	--				A03
H	A124T114HA80	90	9	640	670	--	--				A08

950KBT6

voor-avant-front-Vorne

A124T113ZA75	75	8/P	750	750	22	22		100	1/12+4/11+3/10+	A01
--------------	----	-----	-----	-----	----	----	--	-----	-----------------	-----

achter-arrière-rear-Hinten

	A124T068ZA76	90	10/9	825	995	24	--	230	174	1/12+9/10+9/8	A03A
A	A124T068ZA75	90	10	825	995	24	--	230	102	1/12+9/10	A03
H	A124T068HA80	90	9	710	710	--	--	130	72	9/8	A08

BESTELNR N° COMMANDE ORDER NR BESTELLNR	BR LRG WID BR	BLADEN LAMES LEAVES BLATT.	B	C	D1	D2	PH FL FA SP	PAK EP TH PAK	DETAIL	MOD	OPMERKINGEN REMARQUES REMARKS BEMERKUNGEN
--	------------------------	-------------------------------------	---	---	----	----	----------------------	------------------------	--------	-----	--

SERIE : AE-MAGNUM

AE 380 4x2

Truck - Porteur - Rigid

voor-avant-front-Vorne

F023T101ZA75	90	1	960	1115	20	20	156	43	1/43	F01
F023T061ZA75	90	2	937	1093	20	20	125	70	2/32	F01.10
F023T099ZA75	90	2	937	1093	20	20		74	2/34	F01.10

achter-arrière-rear-Hinten

	F023T154ZA76	90	2/1	905	1035	20	--	190	109	2/34+1/32+P/	F03A
A	F023T154ZA75	90	2	905	1035	20	--	190	74	2/34	F03
H	F023T154HA80	90	1	740	680	--	--	150	35	1/32	F08

Trekker - Tracteur - Tractor

voor-avant-front-Vorne

F023T061ZA75	90	2	937	1093	20	20	125	70	2/32	F01.10
F023T103ZA75	90	2	937	1093	20	20		66	2/30	F01.10
F023T105ZA75	90	2	937	1093	20	20		66	2/30	F01.10
F023T077ZA75	90	2	937	1093	20	20	170	66	2/30	F01.10

achter-arrière-rear-Hinten

F023T088ZA75	90	3	905	905	20	20	148	102	3/30	F01
F023T172ZA75	90	3	905	905	20	20	140	105	3/32	F01.10
F023T282ZR75	100	2	612	465	S30	--	5	98	2/46	LK1214. Passengers side
F023T282ZL75	100	2	612	465	S30	--	5	98	2/46	LK1214. Drivers side
F023T156ZL75	100	2	612	465	S30	--	5	98	2/46	LK1214. Drivers side
F023T156ZR75	100	2	612	465	S30	--	5	98	2/46	LK1214. Passengers side

BESTELNR N° COMMANDE ORDER NR BESTELNR	BR LRG WID BR	BLADEN LAMES LEAVES BLATT.	B	C	D1	D2	PH FL FA SP	PAK EP TH PAK	DETAIL	MOD	OPMERKINGEN REMARQUES REMARKS BEMERKUNGEN
---	------------------------	-------------------------------------	---	---	----	----	----------------------	------------------------	--------	-----	--

SERIE : AE-MAGNUM

AE 380 6x2

Truck - Porteur - Rigid

voor-avant-front-Vorne

F023T101ZA75	90	1	960	1115	20	20	156	43	1/43	F01
F023T099ZA75	90	2	937	1093	20	20		74	2/34	F01.10
F023T061ZA75	90	2	937	1093	20	20	125	70	2/32	F01.10

achter-arrière-rear-Hinten

A	F023T154ZA76	90	2/1	905	1035	20	--	190	109	2/34+1/32+P/	F03A
	F023T154ZA75	90	2	905	1035	20	--	190	74	2/34	F03
H	F023T154HA80	90	1	740	680	--	--	150	35	1/32	F08
	F023T174ZA75	0	2	0	0		--		0		LR2250 Lenker
	F023T176ZA75	0	2	0	0		--		0		LR2250 Lenker

Trekker - Tracteur - Tractor

voor-avant-front-Vorne

F023T105ZA75	90	2	937	1093	20	20		66	2/30	F01.10
F023T061ZA75	90	2	937	1093	20	20	125	70	2/32	F01.10
F023T077ZA75	90	2	937	1093	20	20	170	66	2/30	F01.10
F023T103ZA75	90	2	937	1093	20	20		66	2/30	F01.10

achter-arrière-rear-Hinten

F023T174ZA75	0	2	0	0		--		0		LR2250 Lenker
F023T176ZA75	0	2	0	0		--		0		LR2250 Lenker

AE 380 6x4

Truck - Porteur - Rigid

voor-avant-front-Vorne

F023T099ZA75	90	2	937	1093	20	20		74	2/34	F01.10
F023T061ZA75	90	2	937	1093	20	20	125	70	2/32	F01.10

achter-arrière-rear-Hinten

A124T170ZA70	100	7/P	745	745	--	--	30	150	7/20+P/10	A08R
F023T178ZA75	80	2	480	575	S25	--		0		F03t Silentbloc
F023T164ZA75	80	2	480	575	S25	--	86	61	2/26	F03t Silentbloc

BESTELNR N° COMMANDE ORDER NR BESTELLNR	BR LRG WID BR	BLADEN LAMES LEAVES BLATT.	B	C	D1	D2	PH FL FA SP	PAK EP TH PAK	DETAIL	MOD	OPMERKINGEN REMARQUES REMARKS BEMERKUNGEN
--	------------------------	-------------------------------------	---	---	----	----	----------------------	------------------------	--------	-----	--

SERIE : AE-MAGNUM

AE 385TI

Trekker - Tracteur - Tractor

voor-avant-front-Vorne

F023T061ZA75	90	2	937	1093	20	20	125	70	2/32	F01.10
F023T079ZA75	90	2	937	1093	20	20		70	2/32	F01.10
F023T105ZA75	90	2	937	1093	20	20		66	2/30	F01.10
F023T077ZA75	90	2	937	1093	20	20	170	66	2/30	F01.10

achter-arrière-rear-Hinten

F023T172ZA75	90	3	905	905	20	20	140	105	3/32	F01.10
F023T156ZL75	100	2	612	465	S30	--	5	98	2/46	LK1214. Drivers side
F023T282ZL75	100	2	612	465	S30	--	5	98	2/46	LK1214. Drivers side
F023T282ZR75	100	2	612	465	S30	--	5	98	2/46	LK1214. Passengers side
F023T156ZR75	100	2	612	465	S30	--	5	98	2/46	LK1214. Passengers side
F023T174ZA75	0	2	0	0		--		0		LR2250 Lenker
F023T176ZA75	0	2	0	0		--		0		LR2250 Lenker

BESTELNR N° COMMANDE ORDER NR BESTELLNR	BR LRG WID BR	BLADEN LAMES LEAVES BLATT.	B	C	D1	D2	PH FL FA SP	PAK EP TH PAK	DETAIL	MOD	OPMERKINGEN REMARQUES REMARKS BEMERKUNGEN
--	------------------------	-------------------------------------	---	---	----	----	----------------------	------------------------	--------	-----	--

SERIE : AE-MAGNUM

AE 385TI 4x2

Truck - Porteur - Rigid

voor-avant-front-Vorne

F023T101ZA75	90	1	960	1115	20	20	156	43	1/43	F01
F023T061ZA75	90	2	937	1093	20	20	125	70	2/32	F01.10
F023T099ZA75	90	2	937	1093	20	20		74	2/34	F01.10

achter-arrière-rear-Hinten

	F023T154ZA76	90	2/1	905	1035	20	--	190	109	2/34+1/32+P/	F03A
A	F023T154ZA75	90	2	905	1035	20	--	190	74	2/34	F03
H	F023T154HA80	90	1	740	680	--	--	150	35	1/32	F08

Trekker - Tracteur - Tractor

voor-avant-front-Vorne

F023T061ZA75	90	2	937	1093	20	20	125	70	2/32	F01.10
F023T103ZA75	90	2	937	1093	20	20		66	2/30	F01.10
F023T105ZA75	90	2	937	1093	20	20		66	2/30	F01.10
F023T077ZA75	90	2	937	1093	20	20	170	66	2/30	F01.10

achter-arrière-rear-Hinten

F023T088ZA75	90	3	905	905	20	20	148	102	3/30	F01
F023T172ZA75	90	3	905	905	20	20	140	105	3/32	F01.10
F023T282ZR75	100	2	612	465	S30	--	5	98	2/46	LK1214. Passengers side
F023T156ZR75	100	2	612	465	S30	--	5	98	2/46	LK1214. Passengers side
F023T156ZL75	100	2	612	465	S30	--	5	98	2/46	LK1214. Drivers side
F023T282ZL75	100	2	612	465	S30	--	5	98	2/46	LK1214. Drivers side

BESTELNR N° COMMANDE ORDER NR BESTELNR	BR LRG WID BR	BLADEN LAMES LEAVES BLATT.	B	C	D1	D2	PH FL FA SP	PAK EP TH PAK	DETAIL	MOD	OPMERKINGEN REMARQUES REMARKS BEMERKUNGEN
---	------------------------	-------------------------------------	---	---	----	----	----------------------	------------------------	--------	-----	--

SERIE : AE-MAGNUM

AE 385TI 6x2

Truck - Porteur - Rigid

voor-avant-front-Vorne

F023T101ZA75	90	1	960	1115	20	20	156	43	1/43	F01
F023T061ZA75	90	2	937	1093	20	20	125	70	2/32	F01.10
F023T099ZA75	90	2	937	1093	20	20		74	2/34	F01.10

achter-arrière-rear-Hinten

A	F023T154ZA76	90	2/1	905	1035	20	--	190	109	2/34+1/32+P/	F03A
	F023T154ZA75	90	2	905	1035	20	--	190	74	2/34	F03
H	F023T154HA80	90	1	740	680	--	--	150	35	1/32	F08
	F023T174ZA75	0	2	0	0		--		0		LR2250 Lenker
	F023T176ZA75	0	2	0	0		--		0		LR2250 Lenker

Trekker - Tracteur - Tractor

voor-avant-front-Vorne

F023T103ZA75	90	2	937	1093	20	20		66	2/30	F01.10
F023T077ZA75	90	2	937	1093	20	20	170	66	2/30	F01.10
F023T105ZA75	90	2	937	1093	20	20		66	2/30	F01.10
F023T061ZA75	90	2	937	1093	20	20	125	70	2/32	F01.10

achter-arrière-rear-Hinten

F023T174ZA75	0	2	0	0		--		0		LR2250 Lenker
F023T176ZA75	0	2	0	0		--		0		LR2250 Lenker

AE 385TI 6x4

Truck - Porteur - Rigid

voor-avant-front-Vorne

F023T061ZA75	90	2	937	1093	20	20	125	70	2/32	F01.10
F023T099ZA75	90	2	937	1093	20	20		74	2/34	F01.10

achter-arrière-rear-Hinten

A124T170ZA70	100	7/P	745	745	--	--	30	150	7/20+P/10	A08R
F023T164ZA75	80	2	480	575	S25	--	86	61	2/26	F03t Silentbloc
F023T178ZA75	80	2	480	575	S25	--		0		F03t Silentbloc

BESTELNR N° COMMANDE ORDER NR BESTELNR	BR LRG WID BR	BLADEN LAMES LEAVES BLATT.	B	C	D1	D2	PH FL FA SP	PAK EP TH PAK	DETAIL	MOD	OPMERKINGEN REMARQUES REMARKS BEMERKUNGEN
---	------------------------	-------------------------------------	---	---	----	----	----------------------	------------------------	--------	-----	--

SERIE : AE-MAGNUM

AE 390 4x2

Truck - Porteur - Rigid

voor-avant-front-Vorne

F023T101ZA75	90	1	960	1115	20	20	156	43	1/43	F01
F023T079ZA75	90	2	937	1093	20	20		70	2/32	F01.10
F023T061ZA75	90	2	937	1093	20	20	125	70	2/32	F01.10

achter-arrière-rear-Hinten

A	F023T154ZA76	90	2/1	905	1035	20	--	190	109	2/34+1/32+P/	F03A
	F023T154ZA75	90	2	905	1035	20	--	190	74	2/34	F03
H	F023T154HA80	90	1	740	680	--	--	150	35	1/32	F08
	F023T282ZR75	100	2	612	465	S30	--	5	98	2/46	LK1214. Passengers side
	F023T156ZR75	100	2	612	465	S30	--	5	98	2/46	LK1214. Passengers side
	F023T156ZL75	100	2	612	465	S30	--	5	98	2/46	LK1214. Drivers side
	F023T282ZL75	100	2	612	465	S30	--	5	98	2/46	LK1214. Drivers side

Trekker - Tracteur - Tractor

voor-avant-front-Vorne

F023T061ZA75	90	2	937	1093	20	20	125	70	2/32	F01.10
F023T105ZA75	90	2	937	1093	20	20		66	2/30	F01.10
F023T079ZA75	90	2	937	1093	20	20		70	2/32	F01.10
F023T077ZA75	90	2	937	1093	20	20	170	66	2/30	F01.10

achter-arrière-rear-Hinten

F023T172ZA75	90	3	905	905	20	20	140	105	3/32	F01.10
F023T282ZL75	100	2	612	465	S30	--	5	98	2/46	LK1214. Drivers side
F023T156ZL75	100	2	612	465	S30	--	5	98	2/46	LK1214. Drivers side
F023T156ZR75	100	2	612	465	S30	--	5	98	2/46	LK1214. Passengers side
F023T282ZR75	100	2	612	465	S30	--	5	98	2/46	LK1214. Passengers side

BESTELNR N° COMMANDE ORDER NR BESTELNR	BR LRG WID BR	BLADEN LAMES LEAVES BLATT.	B	C	D1	D2	PH FL FA SP	PAK EP TH PAK	DETAIL	MOD	OPMERKINGEN REMARQUES REMARKS BEMERKUNGEN
---	------------------------	-------------------------------------	---	---	----	----	----------------------	------------------------	--------	-----	--

SERIE : AE-MAGNUM

AE 390 6x2

Truck - Porteur - Rigid

voor-avant-front-Vorne

F023T101ZA75	90	1	960	1115	20	20	156	43	1/43	F01
F023T099ZA75	90	2	937	1093	20	20		74	2/34	F01.10
F023T079ZA75	90	2	937	1093	20	20		70	2/32	F01.10
F023T061ZA75	90	2	937	1093	20	20	125	70	2/32	F01.10

achter-arrière-rear-Hinten

A	F023T154ZA76	90	2/1	905	1035	20	--	190	109	2/34+1/32+P/	F03A
	F023T154ZA75	90	2	905	1035	20	--	190	74	2/34	F03
H	F023T154HA80	90	1	740	680	--	--	150	35	1/32	F08
	F023T282ZR75	100	2	612	465	S30	--	5	98	2/46	LK1214. Passengers side
	F023T156ZL75	100	2	612	465	S30	--	5	98	2/46	LK1214. Drivers side
	F023T156ZR75	100	2	612	465	S30	--	5	98	2/46	LK1214. Passengers side
	F023T282ZL75	100	2	612	465	S30	--	5	98	2/46	LK1214. Drivers side
	F023T176ZA75	0	2	0	0		--		0		LR2250 Lenker
	F023T174ZA75	0	2	0	0		--		0		LR2250 Lenker

AE 420TI

Trekker - Tracteur - Tractor

voor-avant-front-Vorne

F023T061ZA75	90	2	937	1093	20	20	125	70	2/32	F01.10
F023T105ZA75	90	2	937	1093	20	20		66	2/30	F01.10
F023T079ZA75	90	2	937	1093	20	20		70	2/32	F01.10
F023T077ZA75	90	2	937	1093	20	20	170	66	2/30	F01.10

achter-arrière-rear-Hinten

F023T172ZA75	90	3	905	905	20	20	140	105	3/32	F01.10
F023T282ZL75	100	2	612	465	S30	--	5	98	2/46	LK1214. Drivers side
F023T156ZR75	100	2	612	465	S30	--	5	98	2/46	LK1214. Passengers side
F023T156ZL75	100	2	612	465	S30	--	5	98	2/46	LK1214. Drivers side
F023T282ZR75	100	2	612	465	S30	--	5	98	2/46	LK1214. Passengers side
F023T176ZA75	0	2	0	0		--		0		LR2250 Lenker
F023T174ZA75	0	2	0	0		--		0		LR2250 Lenker

BESTELNR N° COMMANDE ORDER NR BESTELNR	BR LRG WID BR	BLADEN LAMES LEAVES BLATT.	B	C	D1	D2	PH FL FA SP	PAK EP TH PAK	DETAIL	MOD	OPMERKINGEN REMARQUES REMARKS BEMERKUNGEN
---	------------------------	-------------------------------------	---	---	----	----	----------------------	------------------------	--------	-----	--

SERIE : AE-MAGNUM

AE 420TI 4x2

Truck - Porteur - Rigid

voor-avant-front-Vorne

F023T101ZA75	90	1	960	1115	20	20	156	43	1/43	F01
F023T061ZA75	90	2	937	1093	20	20	125	70	2/32	F01.10
F023T099ZA75	90	2	937	1093	20	20		74	2/34	F01.10
F023T079ZA75	90	2	937	1093	20	20		70	2/32	F01.10

achter-arrière-rear-Hinten

A	F023T154ZA76	90	2/1	905	1035	20	--	190	109	2/34+1/32+P/	F03A
	F023T154ZA75	90	2	905	1035	20	--	190	74	2/34	F03
H	F023T154HA80	90	1	740	680	--	--	150	35	1/32	F08
	F023T156ZL75	100	2	612	465	S30	--	5	98	2/46	LK1214. Drivers side
	F023T156ZR75	100	2	612	465	S30	--	5	98	2/46	LK1214. Passengers side
	F023T282ZL75	100	2	612	465	S30	--	5	98	2/46	LK1214. Drivers side
	F023T282ZR75	100	2	612	465	S30	--	5	98	2/46	LK1214. Passengers side

Trekker - Tracteur - Tractor

voor-avant-front-Vorne

F023T061ZA75	90	2	937	1093	20	20	125	70	2/32	F01.10
F023T105ZA75	90	2	937	1093	20	20		66	2/30	F01.10
F023T103ZA75	90	2	937	1093	20	20		66	2/30	F01.10
F023T079ZA75	90	2	937	1093	20	20		70	2/32	F01.10
F023T077ZA75	90	2	937	1093	20	20	170	66	2/30	F01.10

achter-arrière-rear-Hinten

F023T088ZA75	90	3	905	905	20	20	148	102	3/30	F01
F023T172ZA75	90	3	905	905	20	20	140	105	3/32	F01.10
F023T282ZL75	100	2	612	465	S30	--	5	98	2/46	LK1214. Drivers side
F023T156ZR75	100	2	612	465	S30	--	5	98	2/46	LK1214. Passengers side
F023T156ZL75	100	2	612	465	S30	--	5	98	2/46	LK1214. Drivers side
F023T282ZR75	100	2	612	465	S30	--	5	98	2/46	LK1214. Passengers side

BESTELNR N° COMMANDE ORDER NR BESTELNR	BR LRG WID BR	BLADEN LAMES LEAVES BLATT.	B	C	D1	D2	PH FL FA SP	PAK EP TH PAK	DETAIL	MOD	OPMERKINGEN REMARKS BEMERKUNGEN
---	------------------------	-------------------------------------	---	---	----	----	----------------------	------------------------	--------	-----	---------------------------------------

SERIE : AE-MAGNUM

AE 420TI 6x2

Truck - Porteur - Rigid

voor-avant-front-Vorne

F023T101ZA75	90	1	960	1115	20	20	156	43	1/43	F01
F023T061ZA75	90	2	937	1093	20	20	125	70	2/32	F01.10
F023T079ZA75	90	2	937	1093	20	20		70	2/32	F01.10
F023T099ZA75	90	2	937	1093	20	20		74	2/34	F01.10

achter-arrière-rear-Hinten

A	F023T154ZA76	90	2/1	905	1035	20	--	190	109	2/34+1/32+P/	F03A
	F023T154ZA75	90	2	905	1035	20	--	190	74	2/34	F03
H	F023T154HA80	90	1	740	680	--	--	150	35	1/32	F08
	F023T282ZL75	100	2	612	465	S30	--	5	98	2/46	LK1214. Drivers side
	F023T282ZR75	100	2	612	465	S30	--	5	98	2/46	LK1214. Passengers side
	F023T156ZR75	100	2	612	465	S30	--	5	98	2/46	LK1214. Passengers side
	F023T156ZL75	100	2	612	465	S30	--	5	98	2/46	LK1214. Drivers side
	F023T176ZA75	0	2	0	0		--		0		LR2250 Lenker
	F023T174ZA75	0	2	0	0		--		0		LR2250 Lenker

Trekker - Tracteur - Tractor

voor-avant-front-Vorne

F023T061ZA75	90	2	937	1093	20	20	125	70	2/32	F01.10
F023T105ZA75	90	2	937	1093	20	20		66	2/30	F01.10
F023T103ZA75	90	2	937	1093	20	20		66	2/30	F01.10
F023T079ZA75	90	2	937	1093	20	20		70	2/32	F01.10
F023T077ZA75	90	2	937	1093	20	20	170	66	2/30	F01.10

achter-arrière-rear-Hinten

F023T156ZR75	100	2	612	465	S30	--	5	98	2/46	LK1214. Passengers side
F023T156ZL75	100	2	612	465	S30	--	5	98	2/46	LK1214. Drivers side
F023T282ZR75	100	2	612	465	S30	--	5	98	2/46	LK1214. Passengers side
F023T282ZL75	100	2	612	465	S30	--	5	98	2/46	LK1214. Drivers side
F023T176ZA75	0	2	0	0		--		0		LR2250 Lenker
F023T174ZA75	0	2	0	0		--		0		LR2250 Lenker

BESTELNR N° COMMANDE ORDER NR BESTELNR	BR LRG WID BR	BLADEN LAMES LEAVES BLATT.	B	C	D1	D2	PH FL FA SP	PAK EP TH PAK	DETAIL	MOD	OPMERKINGEN REMARQUES REMARKS BEMERKUNGEN
---	------------------------	-------------------------------------	---	---	----	----	----------------------	------------------------	--------	-----	--

SERIE : AE-MAGNUM

AE 420TI 6x4

Truck - Porteur - Rigid

voor-avant-front-Vorne

F023T061ZA75	90	2	937	1093	20	20	125	70	2/32	F01.10
--------------	----	---	-----	------	----	----	-----	----	------	--------

achter-arrière-rear-Hinten

F023T178ZA75	80	2	480	575	S25	--		0		F03t	Silentbloc
F023T164ZA75	80	2	480	575	S25	--	86	61	2/26	F03t	Silentbloc

Trekker - Tracteur - Tractor

voor-avant-front-Vorne

F023T061ZA75	90	2	937	1093	20	20	125	70	2/32	F01.10
F023T079ZA75	90	2	937	1093	20	20		70	2/32	F01.10
F023T099ZA75	90	2	937	1093	20	20		74	2/34	F01.10

achter-arrière-rear-Hinten

A124T170ZA70	100	7/P	745	745	--	--	30	150	7/20+P/10	A08R
--------------	-----	-----	-----	-----	----	----	----	-----	-----------	------

BESTELNR N° COMMANDE ORDER NR BESTELNR	BR LRG WID BR	BLADEN LAMES LEAVES BLATT.	B	C	D1	D2	PH FL FA SP	PAK EP TH PAK	DETAIL	MOD	OPMERKINGEN REMARKS REMARKS BEMERKUNGEN
---	------------------------	-------------------------------------	---	---	----	----	----------------------	------------------------	--------	-----	--

SERIE : AE-MAGNUM

AE 430 4x2

Truck - Porteur - Rigid

voor-avant-front-Vorne

F023T101ZA75	90	1	960	1115	20	20	156	43	1/43	F01
F023T061ZA75	90	2	937	1093	20	20	125	70	2/32	F01.10
F023T079ZA75	90	2	937	1093	20	20		70	2/32	F01.10

achter-arrière-rear-Hinten

A	F023T154ZA76	90	2/1	905	1035	20	--	190	109	2/34+1/32+P/	F03A
	F023T154ZA75	90	2	905	1035	20	--	190	74	2/34	F03
H	F023T154HA80	90	1	740	680	--	--	150	35	1/32	F08
	F023T282ZR75	100	2	612	465	S30	--	5	98	2/46	LK1214. Passengers side
	F023T156ZR75	100	2	612	465	S30	--	5	98	2/46	LK1214. Passengers side
	F023T156ZL75	100	2	612	465	S30	--	5	98	2/46	LK1214. Drivers side
	F023T282ZL75	100	2	612	465	S30	--	5	98	2/46	LK1214. Drivers side

Trekker - Tracteur - Tractor

voor-avant-front-Vorne

F023T079ZA75	90	2	937	1093	20	20		70	2/32	F01.10
F023T105ZA75	90	2	937	1093	20	20		66	2/30	F01.10
F023T077ZA75	90	2	937	1093	20	20	170	66	2/30	F01.10
F023T061ZA75	90	2	937	1093	20	20	125	70	2/32	F01.10

achter-arrière-rear-Hinten

F023T172ZA75	90	3	905	905	20	20	140	105	3/32	F01.10
F023T282ZL75	100	2	612	465	S30	--	5	98	2/46	LK1214. Drivers side
F023T156ZR75	100	2	612	465	S30	--	5	98	2/46	LK1214. Passengers side
F023T156ZL75	100	2	612	465	S30	--	5	98	2/46	LK1214. Drivers side
F023T282ZR75	100	2	612	465	S30	--	5	98	2/46	LK1214. Passengers side

BESTELNR N° COMMANDE ORDER NR BESTELNR	BR LRG WID BR	BLADEN LAMES LEAVES BLATT.	B	C	D1	D2	PH FL FA SP	PAK EP TH PAK	DETAIL	MOD	OPMERKINGEN REMARQUES REMARKS BEMERKUNGEN
---	------------------------	-------------------------------------	---	---	----	----	----------------------	------------------------	--------	-----	--

SERIE : AE-MAGNUM

AE 430 6x2

Truck - Porteur - Rigid

voor-avant-front-Vorne

F023T101ZA75	90	1	960	1115	20	20	156	43	1/43	F01
F023T099ZA75	90	2	937	1093	20	20		74	2/34	F01.10
F023T061ZA75	90	2	937	1093	20	20	125	70	2/32	F01.10
F023T079ZA75	90	2	937	1093	20	20		70	2/32	F01.10

achter-arrière-rear-Hinten

A	F023T154ZA76	90	2/1	905	1035	20	--	190	109	2/34+1/32+P/	F03A
	F023T154ZA75	90	2	905	1035	20	--	190	74	2/34	F03
H	F023T154HA80	90	1	740	680	--	--	150	35	1/32	F08
	F023T156ZR75	100	2	612	465	S30	--	5	98	2/46	LK1214. Passengers side
	F023T156ZL75	100	2	612	465	S30	--	5	98	2/46	LK1214. Drivers side
	F023T282ZL75	100	2	612	465	S30	--	5	98	2/46	LK1214. Drivers side
	F023T282ZR75	100	2	612	465	S30	--	5	98	2/46	LK1214. Passengers side
	F023T174ZA75	0	2	0	0		--		0		LR2250 Lenker
	F023T176ZA75	0	2	0	0		--		0		LR2250 Lenker

AE 430 6x4

Trekker - Tracteur - Tractor

voor-avant-front-Vorne

F023T079ZA75	90	2	937	1093	20	20		70	2/32	F01.10
--------------	----	---	-----	------	----	----	--	----	------	--------

achter-arrière-rear-Hinten

A124T170ZA70	100	7/P	745	745	--	--	30	150	7/20+P/10	A08R
--------------	-----	-----	-----	-----	----	----	----	-----	-----------	------

AE 470 6x4

Trekker - Tracteur - Tractor

voor-avant-front-Vorne

F023T079ZA75	90	2	937	1093	20	20		70	2/32	F01.10
--------------	----	---	-----	------	----	----	--	----	------	--------

achter-arrière-rear-Hinten

A124T170ZA70	100	7/P	745	745	--	--	30	150	7/20+P/10	A08R
--------------	-----	-----	-----	-----	----	----	----	-----	-----------	------

BESTELNR N° COMMANDE ORDER NR BESTELLNR	BR LRG WID BR	BLADEN LAMES LEAVES BLATT.	B	C	D1	D2	PH FL FA SP	PAK EP TH PAK	DETAIL	MOD	OPMERKINGEN REMARQUES REMARKS BEMERKUNGEN
--	------------------------	-------------------------------------	---	---	----	----	----------------------	------------------------	--------	-----	--

SERIE : AE-MAGNUM

AE 500 4x2

Truck - Porteur - Rigid

voor-avant-front-Vorne

F023T101ZA75	90	1	960	1115	20	20	156	43	1/43	F01
F023T061ZA75	90	2	937	1093	20	20	125	70	2/32	F01.10
F023T099ZA75	90	2	937	1093	20	20		74	2/34	F01.10

achter-arrière-rear-Hinten

	F023T154ZA76	90	2/1	905	1035	20	--	190	109	2/34+1/32+P/	F03A
A	F023T154ZA75	90	2	905	1035	20	--	190	74	2/34	F03
H	F023T154HA80	90	1	740	680	--	--	150	35	1/32	F08

Trekker - Tracteur - Tractor

voor-avant-front-Vorne

F023T061ZA75	90	2	937	1093	20	20	125	70	2/32	F01.10
F023T105ZA75	90	2	937	1093	20	20		66	2/30	F01.10
F023T103ZA75	90	2	937	1093	20	20		66	2/30	F01.10
F023T077ZA75	90	2	937	1093	20	20	170	66	2/30	F01.10

achter-arrière-rear-Hinten

F023T088ZA75	90	3	905	905	20	20	148	102	3/30	F01
F023T172ZA75	90	3	905	905	20	20	140	105	3/32	F01.10
F023T156ZR75	100	2	612	465	S30	--	5	98	2/46	LK1214. Passengers side
F023T156ZL75	100	2	612	465	S30	--	5	98	2/46	LK1214. Drivers side
F023T282ZL75	100	2	612	465	S30	--	5	98	2/46	LK1214. Drivers side
F023T282ZR75	100	2	612	465	S30	--	5	98	2/46	LK1214. Passengers side

BESTELNR N° COMMANDE ORDER NR BESTELNR	BR LRG WID BR	BLADEN LAMES LEAVES BLATT.	B	C	D1	D2	PH FL FA SP	PAK EP TH PAK	DETAIL	MOD	OPMERKINGEN REMARQUES REMARKS BEMERKUNGEN
---	------------------------	-------------------------------------	---	---	----	----	----------------------	------------------------	--------	-----	--

SERIE : AE-MAGNUM

AE 500 6x2

Truck - Porteur - Rigid

voor-avant-front-Vorne

F023T101ZA75	90	1	960	1115	20	20	156	43	1/43	F01
F023T061ZA75	90	2	937	1093	20	20	125	70	2/32	F01.10
F023T099ZA75	90	2	937	1093	20	20		74	2/34	F01.10

achter-arrière-rear-Hinten

	F023T154ZA76	90	2/1	905	1035	20	--	190	109	2/34+1/32+P/	F03A
A	F023T154ZA75	90	2	905	1035	20	--	190	74	2/34	F03
H	F023T154HA80	90	1	740	680	--	--	150	35	1/32	F08
	F023T174ZA75	0	2	0	0		--		0		LR2250 Lenker
	F023T176ZA75	0	2	0	0		--		0		LR2250 Lenker

Trekker - Tracteur - Tractor

voor-avant-front-Vorne

F023T077ZA75	90	2	937	1093	20	20	170	66	2/30	F01.10
F023T105ZA75	90	2	937	1093	20	20		66	2/30	F01.10
F023T103ZA75	90	2	937	1093	20	20		66	2/30	F01.10
F023T061ZA75	90	2	937	1093	20	20	125	70	2/32	F01.10

achter-arrière-rear-Hinten

F023T174ZA75	0	2	0	0		--		0		LR2250 Lenker
F023T176ZA75	0	2	0	0		--		0		LR2250 Lenker

BESTELNR N° COMMANDE ORDER NR BESTELLNR	BR LRG WID BR	BLADEN LAMES LEAVES BLATT.	B	C	D1	D2	PH FL FA SP	PAK EP TH PAK	DETAIL	MOD	OPMERKINGEN REMARQUES REMARKS BEMERKUNGEN
--	------------------------	-------------------------------------	---	---	----	----	----------------------	------------------------	--------	-----	--

SERIE : AE-MAGNUM

AE 500 6x4

Truck - Porteur - Rigid

voor-avant-front-Vorne

F023T061ZA75	90	2	937	1093	20	20	125	70	2/32	F01.10
--------------	----	---	-----	------	----	----	-----	----	------	--------

achter-arrière-rear-Hinten

F023T164ZA75	80	2	480	575	S25	--	86	61	2/26	F03t	Silentbloc
F023T178ZA75	80	2	480	575	S25	--		0		F03t	Silentbloc

Trekker - Tracteur - Tractor

voor-avant-front-Vorne

F023T099ZA75	90	2	937	1093	20	20		74	2/34	F01.10
F023T061ZA75	90	2	937	1093	20	20	125	70	2/32	F01.10

achter-arrière-rear-Hinten

A124T170ZA70	100	7/P	745	745	--	--	30	150	7/20+P/10	A08R
--------------	-----	-----	-----	-----	----	----	----	-----	-----------	------

BESTELNR N° COMMANDE ORDER NR BESTELLNR	BR LRG WID BR	BLADEN LAMES LEAVES BLATT.	B	C	D1	D2	PH FL FA SP	PAK EP TH PAK	DETAIL	MOD	OPMERKINGEN REMARQUES REMARKS BEMERKUNGEN
--	------------------------	-------------------------------------	---	---	----	----	----------------------	------------------------	--------	-----	--

SERIE : AE-MAGNUM

AE 520 4x2

Truck - Porteur - Rigid

voor-avant-front-Vorne

F023T101ZA75	90	1	960	1115	20	20	156	43	1/43	F01
F023T099ZA75	90	2	937	1093	20	20		74	2/34	F01.10
F023T061ZA75	90	2	937	1093	20	20	125	70	2/32	F01.10

achter-arrière-rear-Hinten

	F023T154ZA76	90	2/1	905	1035	20	--	190	109	2/34+1/32+P/	F03A
A	F023T154ZA75	90	2	905	1035	20	--	190	74	2/34	F03
H	F023T154HA80	90	1	740	680	--	--	150	35	1/32	F08

Trekker - Tracteur - Tractor

voor-avant-front-Vorne

F023T061ZA75	90	2	937	1093	20	20	125	70	2/32	F01.10
F023T105ZA75	90	2	937	1093	20	20		66	2/30	F01.10
F023T103ZA75	90	2	937	1093	20	20		66	2/30	F01.10
F023T077ZA75	90	2	937	1093	20	20	170	66	2/30	F01.10

achter-arrière-rear-Hinten

F023T088ZA75	90	3	905	905	20	20	148	102	3/30	F01
F023T172ZA75	90	3	905	905	20	20	140	105	3/32	F01.10
F023T282ZL75	100	2	612	465	S30	--	5	98	2/46	LK1214. Drivers side
F023T282ZR75	100	2	612	465	S30	--	5	98	2/46	LK1214. Passengers side
F023T156ZR75	100	2	612	465	S30	--	5	98	2/46	LK1214. Passengers side
F023T156ZL75	100	2	612	465	S30	--	5	98	2/46	LK1214. Drivers side

BESTELNR N° COMMANDE ORDER NR BESTELNR	BR LRG WID BR	BLADEN LAMES LEAVES BLATT.	B	C	D1	D2	PH FL FA SP	PAK EP TH PAK	DETAIL	MOD	OPMERKINGEN REMARQUES REMARKS BEMERKUNGEN
---	------------------------	-------------------------------------	---	---	----	----	----------------------	------------------------	--------	-----	--

SERIE : AE-MAGNUM

AE 520 6x2

Truck - Porteur - Rigid

voor-avant-front-Vorne

F023T101ZA75	90	1	960	1115	20	20	156	43	1/43	F01
F023T061ZA75	90	2	937	1093	20	20	125	70	2/32	F01.10
F023T099ZA75	90	2	937	1093	20	20		74	2/34	F01.10

achter-arrière-rear-Hinten

	F023T154ZA76	90	2/1	905	1035	20	--	190	109	2/34+1/32+P/	F03A
A	F023T154ZA75	90	2	905	1035	20	--	190	74	2/34	F03
H	F023T154HA80	90	1	740	680	--	--	150	35	1/32	F08
	F023T174ZA75	0	2	0	0		--		0		LR2250 Lenker
	F023T176ZA75	0	2	0	0		--		0		LR2250 Lenker

Trekker - Tracteur - Tractor

voor-avant-front-Vorne

F023T061ZA75	90	2	937	1093	20	20	125	70	2/32	F01.10
F023T077ZA75	90	2	937	1093	20	20	170	66	2/30	F01.10
F023T103ZA75	90	2	937	1093	20	20		66	2/30	F01.10
F023T105ZA75	90	2	937	1093	20	20		66	2/30	F01.10

achter-arrière-rear-Hinten

F023T174ZA75	0	2	0	0		--		0		LR2250 Lenker
F023T176ZA75	0	2	0	0		--		0		LR2250 Lenker

BESTELNR N° COMMANDE ORDER NR BESTELLNR	BR LRG WID BR	BLADEN LAMES LEAVES BLATT.	B	C	D1	D2	PH FL FA SP	PAK EP TH PAK	DETAIL	MOD	OPMERKINGEN REMARQUES REMARKS BEMERKUNGEN
--	------------------------	-------------------------------------	---	---	----	----	----------------------	------------------------	--------	-----	--

SERIE : AE-MAGNUM

AE 520 6x4

Truck - Porteur - Rigid

voor-avant-front-Vorne

F023T061ZA75	90	2	937	1093	20	20	125	70	2/32	F01.10
--------------	----	---	-----	------	----	----	-----	----	------	--------

achter-arrière-rear-Hinten

F023T164ZA75	80	2	480	575	S25	--	86	61	2/26	F03t	Silentbloc
F023T178ZA75	80	2	480	575	S25	--		0		F03t	Silentbloc

Trekker - Tracteur - Tractor

voor-avant-front-Vorne

F023T061ZA75	90	2	937	1093	20	20	125	70	2/32	F01.10
F023T099ZA75	90	2	937	1093	20	20		74	2/34	F01.10

achter-arrière-rear-Hinten

A124T170ZA70	100	7/P	745	745	--	--	30	150	7/20+P/10	A08R
--------------	-----	-----	-----	-----	----	----	----	-----	-----------	------

BESTELNR N° COMMANDE ORDER NR BESTELNR	BR LRG WID BR	BLADEN LAMES LEAVES BLATT.	B	C	D1	D2	PH FL FA SP	PAK EP TH PAK	DETAIL	MOD	OPMERKINGEN REMARQUES REMARKS BEMERKUNGEN
---	------------------------	-------------------------------------	---	---	----	----	----------------------	------------------------	--------	-----	--

SERIE : AE-MAGNUM

AE 560 4x2

Truck - Porteur - Rigid

voor-avant-front-Vorne

F023T101ZA75	90	1	960	1115	20	20	156	43	1/43	F01
F023T061ZA75	90	2	937	1093	20	20	125	70	2/32	F01.10
F023T079ZA75	90	2	937	1093	20	20		70	2/32	F01.10

achter-arrière-rear-Hinten

A	F023T154ZA76	90	2/1	905	1035	20	--	190	109	2/34+1/32+P/	F03A
	F023T154ZA75	90	2	905	1035	20	--	190	74	2/34	F03
H	F023T154HA80	90	1	740	680	--	--	150	35	1/32	F08
	F023T156ZL75	100	2	612	465	S30	--	5	98	2/46	LK1214. Drivers side
	F023T156ZR75	100	2	612	465	S30	--	5	98	2/46	LK1214. Passengers side
	F023T282ZR75	100	2	612	465	S30	--	5	98	2/46	LK1214. Passengers side
	F023T282ZL75	100	2	612	465	S30	--	5	98	2/46	LK1214. Drivers side

Trekker - Tracteur - Tractor

voor-avant-front-Vorne

F023T061ZA75	90	2	937	1093	20	20	125	70	2/32	F01.10
F023T105ZA75	90	2	937	1093	20	20		66	2/30	F01.10
F023T077ZA75	90	2	937	1093	20	20	170	66	2/30	F01.10
F023T079ZA75	90	2	937	1093	20	20		70	2/32	F01.10

achter-arrière-rear-Hinten

F023T172ZA75	90	3	905	905	20	20	140	105	3/32	F01.10
F023T282ZL75	100	2	612	465	S30	--	5	98	2/46	LK1214. Drivers side
F023T282ZR75	100	2	612	465	S30	--	5	98	2/46	LK1214. Passengers side
F023T156ZR75	100	2	612	465	S30	--	5	98	2/46	LK1214. Passengers side
F023T156ZL75	100	2	612	465	S30	--	5	98	2/46	LK1214. Drivers side

BESTELNR N° COMMANDE ORDER NR BESTELNR	BR LRG WID BR	BLADEN LAMES LEAVES BLATT.	B	C	D1	D2	PH FL FA SP	PAK EP TH PAK	DETAIL	MOD	OPMERKINGEN REMARQUES REMARKS BEMERKUNGEN
---	------------------------	-------------------------------------	---	---	----	----	----------------------	------------------------	--------	-----	--

SERIE : AE-MAGNUM

AE 560 6x2

Truck - Porteur - Rigid

voor-avant-front-Vorne

F023T101ZA75	90	1	960	1115	20	20	156	43	1/43	F01
F023T061ZA75	90	2	937	1093	20	20	125	70	2/32	F01.10
F023T099ZA75	90	2	937	1093	20	20		74	2/34	F01.10
F023T079ZA75	90	2	937	1093	20	20		70	2/32	F01.10

achter-arrière-rear-Hinten

A	F023T154ZA76	90	2/1	905	1035	20	--	190	109	2/34+1/32+P/	F03A
	F023T154ZA75	90	2	905	1035	20	--	190	74	2/34	F03
H	F023T154HA80	90	1	740	680	--	--	150	35	1/32	F08
	F023T156ZL75	100	2	612	465	S30	--	5	98	2/46	LK1214. Drivers side
	F023T282ZR75	100	2	612	465	S30	--	5	98	2/46	LK1214. Passengers side
	F023T282ZL75	100	2	612	465	S30	--	5	98	2/46	LK1214. Drivers side
	F023T156ZR75	100	2	612	465	S30	--	5	98	2/46	LK1214. Passengers side
	F023T176ZA75	0	2	0	0		--		0		LR2250 Lenker
	F023T174ZA75	0	2	0	0		--		0		LR2250 Lenker

Trekker - Tracteur - Tractor

voor-avant-front-Vorne

F023T061ZA75	90	2	937	1093	20	20	125	70	2/32	F01.10
F023T105ZA75	90	2	937	1093	20	20		66	2/30	F01.10
F023T079ZA75	90	2	937	1093	20	20		70	2/32	F01.10
F023T077ZA75	90	2	937	1093	20	20	170	66	2/30	F01.10

achter-arrière-rear-Hinten

F023T156ZL75	100	2	612	465	S30	--	5	98	2/46	LK1214. Drivers side
F023T282ZL75	100	2	612	465	S30	--	5	98	2/46	LK1214. Drivers side
F023T156ZR75	100	2	612	465	S30	--	5	98	2/46	LK1214. Passengers side
F023T282ZR75	100	2	612	465	S30	--	5	98	2/46	LK1214. Passengers side
F023T176ZA75	0	2	0	0		--		0		LR2250 Lenker
F023T174ZA75	0	2	0	0		--		0		LR2250 Lenker

BESTELNR N° COMMANDE ORDER NR BESTELLNR	BR LRG WID BR	BLADEN LAMES LEAVES BLATT.	B	C	D1	D2	PH FL FA SP	PAK EP TH PAK	DETAIL	MOD	OPMERKINGEN REMARQUES REMARKS BEMERKUNGEN
--	------------------------	-------------------------------------	---	---	----	----	----------------------	------------------------	--------	-----	--

SERIE : AE-MAGNUM

AE 560 6x4

Trekker - Tracteur - Tractor

voor-avant-front-Vorne

F023T079ZA75	90	2	937	1093	20	20		70	2/32	F01.10
--------------	----	---	-----	------	----	----	--	----	------	--------

achter-arrière-rear-Hinten

A124T170ZA70	100	7/P	745	745	--	--	30	150	7/20+P/10	A08R
--------------	-----	-----	-----	-----	----	----	----	-----	-----------	------

BESTELNR N° COMMANDE ORDER NR BESTELNR	BR LRG WID BR	BLADEN LAMES LEAVES BLATT.	B	C	D1	D2	PH FL FA SP	PAK EP TH PAK	DETAIL	MOD	OPMERKINGEN REMARKS REMARKS BEMERKUNGEN
---	------------------------	-------------------------------------	---	---	----	----	----------------------	------------------------	--------	-----	--

SERIE : B-MESSENGER

B 80

Truck - Porteur - Rigid

voor-avant-front-Vorne

F023T127ZA75	60	2/P	700	820	S16	S16		66	2/20+P/20	F01
F023T161ZA75	60	2/P	700	820	S16	S16	168	66	2/18+P/21	F01

achter-arrière-rear-Hinten

F023T068ZA75	60	3	775	775	S16	S16	167	69	3/19	F01
F023T072ZA75	60	3	775	775	S16	S16	162	69	3/19	F01
F023T138ZA75	60	2/1	775	775	S16	S16	182	73	1/16+1/13+1/35	F01B
F023T140ZA75	60	2/1	775	775	S16	S16		68	2/13+1/31	F01B

B 90

Truck - Porteur - Rigid

achter-arrière-rear-Hinten

F023T066ZA75	60	3	775	775	S16	S16	197	69	3/19	F01
F023T068ZA75	60	3	775	775	S16	S16	167	69	3/19	F01
F023T140ZA75	60	2/1	775	775	S16	S16		68	2/13+1/31	F01B

B 90 4x4

Truck - Porteur - Rigid

achter-arrière-rear-Hinten

F023T068ZA75	60	3	775	775	S16	S16	167	69	3/19	F01
F023T066ZA75	60	3	775	775	S16	S16	197	69	3/19	F01

BESTELNR N° COMMANDE ORDER NR BESTELNR	BR LRG WID BR	BLADEN LAMES LEAVES BLATT.	B	C	D1	D2	PH FL FA SP	PAK EP TH PAK	DETAIL	MOD	OPMERKINGEN REMARQUES REMARKS BEMERKUNGEN
---	------------------------	-------------------------------------	---	---	----	----	----------------------	------------------------	--------	-----	--

SERIE : B-MESSENGER

B110

Truck - Porteur - Rigid

voor-avant-front-Vorne

F023T161ZA75	60	2/P	700	820	S16	S16	168	66	2/18+P/21	F01
F023T127ZA75	60	2/P	700	820	S16	S16		66	2/20+P/20	F01

achter-arrière-rear-Hinten

F023T068ZA75	60	3	775	775	S16	S16	167	69	3/19	F01
F023T072ZA75	60	3	775	775	S16	S16	162	69	3/19	F01
F023T140ZA75	60	2/1	775	775	S16	S16		68	2/13+1/31	F01B
F023T138ZA75	60	2/1	775	775	S16	S16	182	73	1/16+1/13+1/35	F01B

B120

Truck - Porteur - Rigid

voor-avant-front-Vorne

F023T127ZA75	60	2/P	700	820	S16	S16		66	2/20+P/20	F01
F023T161ZA75	60	2/P	700	820	S16	S16	168	66	2/18+P/21	F01

achter-arrière-rear-Hinten

F023T068ZA75	60	3	775	775	S16	S16	167	69	3/19	F01
F023T072ZA75	60	3	775	775	S16	S16	162	69	3/19	F01
F023T138ZA75	60	2/1	775	775	S16	S16	182	73	1/16+1/13+1/35	F01B
F023T140ZA75	60	2/1	775	775	S16	S16		68	2/13+1/31	F01B

BESTELNR N° COMMANDE ORDER NR BESTELNR	BR LRG WID BR	BLADEN LAMES LEAVES BLATT.	B	C	D1	D2	PH FL FA SP	PAK EP TH PAK	DETAIL	MOD	OPMERKINGEN REMARKS REMARKS BEMERKUNGEN
---	------------------------	-------------------------------------	---	---	----	----	----------------------	------------------------	--------	-----	--

SERIE : C**C210 4x2****Truck - Porteur - Rigid****voor-avant-front-Vorne**

A124T153ZA75	90	9	820	820	36	36	115	119	1/15+8/13	A01
A124T271ZA75	90	9	820	820	36	36	142	111	1/15+8/12	A01

achter-arrière-rear-Hinten

A	A124T286ZA76	90	8/P/10	825	670	36	36		227	8/14+10/10+1/15	A01A
A	A124T286ZA75	90	8	825	670	36	36		112	8/14	A01
H	A124T286HA80	90	10/P	650	530				115	10/10+P/15	A08
A	A124T156ZA76	90	9/P/7	825	1000	36	--	115	222	9/14+8/12	A03A
A	A124T156ZA75	90	9	825	1000	36	--	115	126	9/14	A03
H	A124T156HA80	90	7/P	650	650	--	--	63	96	7/12+P/12	A08

C230 4x2**Truck - Porteur - Rigid****voor-avant-front-Vorne**

A124T153ZA75	90	9	820	820	36	36	115	119	1/15+8/13	A01
A124T271ZA75	90	9	820	820	36	36	142	111	1/15+8/12	A01

achter-arrière-rear-Hinten

A	A124T286ZA76	90	8/P/10	825	670	36	36		227	8/14+10/10+1/15	A01A
A	A124T286ZA75	90	8	825	670	36	36		112	8/14	A01
H	A124T286HA80	90	10/P	650	530				115	10/10+P/15	A08
A	A124T156ZA76	90	9/P/7	825	1000	36	--	115	222	9/14+8/12	A03A
A	A124T156ZA75	90	9	825	1000	36	--	115	126	9/14	A03
H	A124T156HA80	90	7/P	650	650	--	--	63	96	7/12+P/12	A08

C230 4x4**Truck - Porteur - Rigid****voor-avant-front-Vorne**

A124T273ZA75	90	10	820	820	36	36		126	2/15+8/12	A01
--------------	----	----	-----	-----	----	----	--	-----	-----------	-----

achter-arrière-rear-Hinten

A	A124T156ZA76	90	9/P/7	825	1000	36	--	115	222	9/14+8/12	A03A
A	A124T156ZA75	90	9	825	1000	36	--	115	126	9/14	A03
H	A124T156HA80	90	7/P	650	650	--	--	63	96	7/12+P/12	A08

BESTELNR N° COMMANDE ORDER NR BESTELLNR	BR LRG WID BR	BLADEN LAMES LEAVES BLATT.	B	C	D1	D2	PH FL FA SP	PAK EP TH PAK	DETAIL	MOD	OPMERKINGEN REMARQUES REMARKS BEMERKUNGEN
--	------------------------	-------------------------------------	---	---	----	----	----------------------	------------------------	--------	-----	--

SERIE : C

C260 4x2

Truck - Porteur - Rigid

voor-avant-front-Vorne

A124T153ZA75	90	9	820	820	36	36	115	119	1/15+8/13	A01
A124T271ZA75	90	9	820	820	36	36	142	111	1/15+8/12	A01

achter-arrière-rear-Hinten

A	A124T286ZA76	90	8/P/10	825	670	36	36		227	8/14+10/10+1/15	A01A
H	A124T286ZA75	90	8	825	670	36	36		112	8/14	A01
H	A124T286HA80	90	10/P	650	530				115	10/10+P/15	A08
A	A124T156ZA76	90	9/P/7	825	1000	36	--	115	222	9/14+8/12	A03A
H	A124T156ZA75	90	9	825	1000	36	--	115	126	9/14	A03
H	A124T156HA80	90	7/P	650	650	--	--	63	96	7/12+P/12	A08

Trekker - Tracteur - Tractor

voor-avant-front-Vorne

A124T153ZA75	90	9	820	820	36	36	115	119	1/15+8/13	A01
A124T271ZA75	90	9	820	820	36	36	142	111	1/15+8/12	A01
F023T043ZA75	90	4	820	820	36	36	217	105	4/18+P/18	F01

achter-arrière-rear-Hinten

A	A124T286ZA76	90	8/P/10	825	670	36	36		227	8/14+10/10+1/15	A01A
H	A124T286ZA75	90	8	825	670	36	36		112	8/14	A01
H	A124T286HA80	90	10/P	650	530				115	10/10+P/15	A08
A	A124T156ZA76	90	9/P/7	825	1000	36	--	115	222	9/14+8/12	A03A
H	A124T156ZA75	90	9	825	1000	36	--	115	126	9/14	A03
H	A124T156HA80	90	7/P	650	650	--	--	63	96	7/12+P/12	A08
	F023T062ZA75	90	4	825	1000	36	--	135	119	4/26	F03

BESTELNR N° COMMANDE ORDER NR BESTELNR	BR LRG WID BR	BLADEN LAMES LEAVES BLATT.	B	C	D1	D2	PH FL FA SP	PAK EP TH PAK	DETAIL	MOD	OPMERKINGEN REMARQUES REMARKS BEMERKUNGEN
---	------------------------	-------------------------------------	---	---	----	----	----------------------	------------------------	--------	-----	--

SERIE : C**C260 4x4****Truck - Porteur - Rigid****voor-avant-front-Vorne**

A124T293ZA75	90	10	820	820	36	36		134	2/15+8/13	A01
--------------	----	----	-----	-----	----	----	--	-----	-----------	-----

achter-arrière-rear-Hinten

A	A124T286ZA76	90	8/P/10	825	670	36	36		227	8/14+10/10+1/15	A01A
	A124T286ZA75	90	8	825	670	36	36		112	8/14	A01
H	A124T286HA80	90	10/P	650	530				115	10/10+P/15	A08
A	A124T156ZA76	90	9/P/7	825	1000	36	--	115	222	9/14+8/12	A03A
	A124T156ZA75	90	9	825	1000	36	--	115	126	9/14	A03
H	A124T156HA80	90	7/P	650	650	--	--	63	96	7/12+P/12	A08

Trekker - Tracteur - Tractor**voor-avant-front-Vorne**

A124T293ZA75	90	10	820	820	36	36		134	2/15+8/13	A01
--------------	----	----	-----	-----	----	----	--	-----	-----------	-----

achter-arrière-rear-Hinten

A	A124T286ZA76	90	8/P/10	825	670	36	36		227	8/14+10/10+1/15	A01A
	A124T286ZA75	90	8	825	670	36	36		112	8/14	A01
H	A124T286HA80	90	10/P	650	530				115	10/10+P/15	A08
A	A124T156ZA76	90	9/P/7	825	1000	36	--	115	222	9/14+8/12	A03A
	A124T156ZA75	90	9	825	1000	36	--	115	126	9/14	A03
H	A124T156HA80	90	7/P	650	650	--	--	63	96	7/12+P/12	A08
	F023T062ZA75	90	4	825	1000	36	--	135	119	4/26	F03

C260 6x4**Truck - Porteur - Rigid****voor-avant-front-Vorne**

A124T153ZA75	90	9	820	820	36	36	115	119	1/15+8/13	A01
--------------	----	---	-----	-----	----	----	-----	-----	-----------	-----

achter-arrière-rear-Hinten

A124T082ZA70	100	7/P	755	755	--	--	53	175	7/23.5+P/10	A08R
--------------	-----	-----	-----	-----	----	----	----	-----	-------------	------

BESTELNR N° COMMANDE ORDER NR BESTELNR	BR LRG WID BR	BLADEN LAMES LEAVES BLATT.	B	C	D1	D2	PH FL FA SP	PAK EP TH PAK	DETAIL	MOD	OPMERKINGEN REMARQUES REMARKS BEMERKUNGEN
---	------------------------	-------------------------------------	---	---	----	----	----------------------	------------------------	--------	-----	--

SERIE : C

C280 4x2

Truck - Porteur - Rigid

voor-avant-front-Vorne

A124T153ZA75	90	9	820	820	36	36	115	119	1/15+8/13	A01
A124T271ZA75	90	9	820	820	36	36	142	111	1/15+8/12	A01

achter-arrière-rear-Hinten

A	A124T286ZA76	90	8/P/10	825	670	36	36		227	8/14+10/10+1/15	A01A
H	A124T286ZA75	90	8	825	670	36	36		112	8/14	A01
H	A124T286HA80	90	10/P	650	530				115	10/10+P/15	A08
A	A124T156ZA76	90	9/P/7	825	1000	36	--	115	222	9/14+8/12	A03A
H	A124T156ZA75	90	9	825	1000	36	--	115	126	9/14	A03
H	A124T156HA80	90	7/P	650	650	--	--	63	96	7/12+P/12	A08

Trekker - Tracteur - Tractor

voor-avant-front-Vorne

F023T043ZA75	90	4	820	820	36	36	217	105	4/18+P/18	F01
--------------	----	---	-----	-----	----	----	-----	-----	-----------	-----

achter-arrière-rear-Hinten

F023T062ZA75	90	4	825	1000	36	--	135	119	4/26	F03
--------------	----	---	-----	------	----	----	-----	-----	------	-----

C280 4x4

Truck - Porteur - Rigid

voor-avant-front-Vorne

A124T273ZA75	90	10	820	820	36	36		126	2/15+8/12	A01
--------------	----	----	-----	-----	----	----	--	-----	-----------	-----

achter-arrière-rear-Hinten

A	A124T156ZA76	90	9/P/7	825	1000	36	--	115	222	9/14+8/12	A03A
H	A124T156ZA75	90	9	825	1000	36	--	115	126	9/14	A03
H	A124T156HA80	90	7/P	650	650	--	--	63	96	7/12+P/12	A08

BESTELNR N° COMMANDE ORDER NR BESTELNR	BR LRG WID BR	BLADEN LAMES LEAVES BLATT.	B	C	D1	D2	PH FL FA SP	PAK EP TH PAK	DETAIL	MOD	OPMERKINGEN REMARKS BEMERKUNGEN
---	------------------------	-------------------------------------	---	---	----	----	----------------------	------------------------	--------	-----	---------------------------------------

SERIE : C**C280 6x4****Truck - Porteur - Rigid****voor-avant-front-Vorne**

A124T153ZA75	90	9	820	820	36	36	115	119	1/15+8/13	A01
F023T057ZA75	90	3	820	820	36	36		0		F01

achter-arrière-rear-Hinten

A124T152ZA70	100	9/P	745	745	--	--	15	208	9/22+P/10	A08R
A124T082ZA70	100	7/P	755	755	--	--	53	175	7/23.5+P/10	A08R

C290 4x2**Truck - Porteur - Rigid****voor-avant-front-Vorne**

A124T153ZA75	90	9	820	820	36	36	115	119	1/15+8/13	A01
A124T271ZA75	90	9	820	820	36	36	142	111	1/15+8/12	A01

achter-arrière-rear-Hinten

A	A124T286ZA76	90	8/P/10	825	670	36	36		227	8/14+10/10+1/15	A01A
A	A124T286ZA75	90	8	825	670	36	36		112	8/14	A01
H	A124T286HA80	90	10/P	650	530				115	10/10+P/15	A08
A	A124T156ZA76	90	9/P/7	825	1000	36	--	115	222	9/14+8/12	A03A
A	A124T156ZA75	90	9	825	1000	36	--	115	126	9/14	A03
H	A124T156HA80	90	7/P	650	650	--	--	63	96	7/12+P/12	A08

Trekker - Tracteur - Tractor**voor-avant-front-Vorne**

A124T271ZA75	90	9	820	820	36	36	142	111	1/15+8/12	A01
A124T153ZA75	90	9	820	820	36	36	115	119	1/15+8/13	A01
F023T043ZA75	90	4	820	820	36	36	217	105	4/18+P/18	F01

achter-arrière-rear-Hinten

A	A124T286ZA76	90	8/P/10	825	670	36	36		227	8/14+10/10+1/15	A01A
A	A124T286ZA75	90	8	825	670	36	36		112	8/14	A01
H	A124T286HA80	90	10/P	650	530				115	10/10+P/15	A08
A	A124T156ZA76	90	9/P/7	825	1000	36	--	115	222	9/14+8/12	A03A
A	A124T156ZA75	90	9	825	1000	36	--	115	126	9/14	A03
H	A124T156HA80	90	7/P	650	650	--	--	63	96	7/12+P/12	A08
	F023T062ZA75	90	4	825	1000	36	--	135	119	4/26	F03

BESTELNR N° COMMANDE ORDER NR BESTELNR	BR LRG WID BR	BLADEN LAMES LEAVES BLATT.	B	C	D1	D2	PH FL FA SP	PAK EP TH PAK	DETAIL	MOD	OPMERKINGEN REMARQUES REMARKS BEMERKUNGEN
---	------------------------	-------------------------------------	---	---	----	----	----------------------	------------------------	--------	-----	--

SERIE : C**C290 4x4****Truck - Porteur - Rigid****voor-avant-front-Vorne**

A124T293ZA75	90	10	820	820	36	36		134	2/15+8/13	A01
--------------	----	----	-----	-----	----	----	--	-----	-----------	-----

achter-arrière-rear-Hinten

A	A124T286ZA76	90	8/P/10	825	670	36	36		227	8/14+10/10+1/15	A01A
A	A124T286ZA75	90	8	825	670	36	36		112	8/14	A01
H	A124T286HA80	90	10/P	650	530				115	10/10+P/15	A08
A	A124T156ZA76	90	9/P/7	825	1000	36	--	115	222	9/14+8/12	A03A
A	A124T156ZA75	90	9	825	1000	36	--	115	126	9/14	A03
H	A124T156HA80	90	7/P	650	650	--	--	63	96	7/12+P/12	A08

Trekker - Tracteur - Tractor**voor-avant-front-Vorne**

A124T293ZA75	90	10	820	820	36	36		134	2/15+8/13	A01
--------------	----	----	-----	-----	----	----	--	-----	-----------	-----

achter-arrière-rear-Hinten

A	A124T286ZA76	90	8/P/10	825	670	36	36		227	8/14+10/10+1/15	A01A
A	A124T286ZA75	90	8	825	670	36	36		112	8/14	A01
H	A124T286HA80	90	10/P	650	530				115	10/10+P/15	A08
A	A124T156ZA76	90	9/P/7	825	1000	36	--	115	222	9/14+8/12	A03A
A	A124T156ZA75	90	9	825	1000	36	--	115	126	9/14	A03
H	A124T156HA80	90	7/P	650	650	--	--	63	96	7/12+P/12	A08
	F023T062ZA75	90	4	825	1000	36	--	135	119	4/26	F03

C290 6x4**Truck - Porteur - Rigid****voor-avant-front-Vorne**

A124T153ZA75	90	9	820	820	36	36	115	119	1/15+8/13	A01
--------------	----	---	-----	-----	----	----	-----	-----	-----------	-----

achter-arrière-rear-Hinten

A124T152ZA70	100	9/P	745	745	--	--	15	208	9/22+P/10	A08R
--------------	-----	-----	-----	-----	----	----	----	-----	-----------	------

BESTELNR N° COMMANDE ORDER NR BESTELNR	BR LRG WID BR	BLADEN LAMES LEAVES BLATT.	B	C	D1	D2	PH FL FA SP	PAK EP TH PAK	DETAIL	MOD	OPMERKINGEN REMARQUES REMARKS BEMERKUNGEN
---	------------------------	-------------------------------------	---	---	----	----	----------------------	------------------------	--------	-----	--

SERIE : C**C300 4x2****Truck - Porteur - Rigid****voor-avant-front-Vorne**

A124T153ZA75	90	9	820	820	36	36	115	119	1/15+8/13	A01
A124T271ZA75	90	9	820	820	36	36	142	111	1/15+8/12	A01

achter-arrière-rear-Hinten

A	A124T286ZA76	90	8/P/10	825	670	36	36		227	8/14+10/10+1/15	A01A
H	A124T286ZA75	90	8	825	670	36	36		112	8/14	A01
H	A124T286HA80	90	10/P	650	530				115	10/10+P/15	A08
A	A124T156ZA76	90	9/P/7	825	1000	36	--	115	222	9/14+8/12	A03A
H	A124T156ZA75	90	9	825	1000	36	--	115	126	9/14	A03
H	A124T156HA80	90	7/P	650	650	--	--	63	96	7/12+P/12	A08

Trekker - Tracteur - Tractor**voor-avant-front-Vorne**

F023T043ZA75	90	4	820	820	36	36	217	105	4/18+P/18	F01
--------------	----	---	-----	-----	----	----	-----	-----	-----------	-----

achter-arrière-rear-Hinten

F023T062ZA75	90	4	825	1000	36	--	135	119	4/26	F03
--------------	----	---	-----	------	----	----	-----	-----	------	-----

C300 4x4**Truck - Porteur - Rigid****voor-avant-front-Vorne**

A124T273ZA75	90	10	820	820	36	36		126	2/15+8/12	A01
--------------	----	----	-----	-----	----	----	--	-----	-----------	-----

achter-arrière-rear-Hinten

A	A124T156ZA76	90	9/P/7	825	1000	36	--	115	222	9/14+8/12	A03A
H	A124T156ZA75	90	9	825	1000	36	--	115	126	9/14	A03
H	A124T156HA80	90	7/P	650	650	--	--	63	96	7/12+P/12	A08

BESTELNR N° COMMANDE ORDER NR BESTELNR	BR LRG WID BR	BLADEN LAMES LEAVES BLATT.	B	C	D1	D2	PH FL FA SP	PAK EP TH PAK	DETAIL	MOD	OPMERKINGEN REMARQUES REMARKS BEMERKUNGEN
---	------------------------	-------------------------------------	---	---	----	----	----------------------	------------------------	--------	-----	--

SERIE : C**C300 6x4****Truck - Porteur - Rigid****voor-avant-front-Vorne**

A124T153ZA75	90	9	820	820	36	36	115	119	1/15+8/13	A01
F023T057ZA75	90	3	820	820	36	36		0		F01

achter-arrière-rear-Hinten

A124T152ZA70	100	9/P	745	745	--	--	15	208	9/22+P/10	A08R
A124T082ZA70	100	7/P	755	755	--	--	53	175	7/23.5+P/10	A08R

C340TI 4x2**Truck - Porteur - Rigid****voor-avant-front-Vorne**

A124T153ZA75	90	9	820	820	36	36	115	119	1/15+8/13	A01
A124T271ZA75	90	9	820	820	36	36	142	111	1/15+8/12	A01

achter-arrière-rear-Hinten

A124T286ZA76	90	8/P/10	825	670	36	36		227	8/14+10/10+1/15	A01A
A124T286ZA75	90	8	825	670	36	36		112	8/14	A01
A124T286HA80	90	10/P	650	530				115	10/10+P/15	A08
A124T156ZA76	90	9/P/7	825	1000	36	--	115	222	9/14+8/12	A03A
A124T156ZA75	90	9	825	1000	36	--	115	126	9/14	A03
A124T156HA80	90	7/P	650	650	--	--	63	96	7/12+P/12	A08

Trekker - Tracteur - Tractor**voor-avant-front-Vorne**

F023T043ZA75	90	4	820	820	36	36	217	105	4/18+P/18	F01
--------------	----	---	-----	-----	----	----	-----	-----	-----------	-----

achter-arrière-rear-Hinten

F023T062ZA75	90	4	825	1000	36	--	135	119	4/26	F03
--------------	----	---	-----	------	----	----	-----	-----	------	-----

BESTELNR N° COMMANDE ORDER NR BESTELNR	BR LRG WID BR	BLADEN LAMES LEAVES BLATT.	B	C	D1	D2	PH FL FA SP	PAK EP TH PAK	DETAIL	MOD	OPMERKINGEN REMARQUES REMARKS BEMERKUNGEN
---	------------------------	-------------------------------------	---	---	----	----	----------------------	------------------------	--------	-----	--

SERIE : C**C340TI 4x4****Truck - Porteur - Rigid****voor-avant-front-Vorne**

A124T273ZA75	90	10	820	820	36	36		126	2/15+8/12	A01
--------------	----	----	-----	-----	----	----	--	-----	-----------	-----

achter-arrière-rear-Hinten

	A124T156ZA76	90	9/P/7	825	1000	36	--	115	222	9/14+8/12	A03A
A	A124T156ZA75	90	9	825	1000	36	--	115	126	9/14	A03
H	A124T156HA80	90	7/P	650	650	--	--	63	96	7/12+P/12	A08

C340TI 6x4**Truck - Porteur - Rigid****voor-avant-front-Vorne**

A124T153ZA75	90	9	820	820	36	36	115	119	1/15+8/13	A01
F023T057ZA75	90	3	820	820	36	36		0		F01

achter-arrière-rear-Hinten

A124T152ZA70	100	9/P	745	745	--	--	15	208	9/22+P/10	A08R
A124T082ZA70	100	7/P	755	755	--	--	53	175	7/23.5+P/10	A08R

BESTELNR N° COMMANDE ORDER NR BESTELNR	BR LRG WID BR	BLADEN LAMES LEAVES BLATT.	B	C	D1	D2	PH FL FA SP	PAK EP TH PAK	DETAIL	MOD	OPMERKINGEN REMARKS REMARKS BEMERKUNGEN
---	------------------------	-------------------------------------	---	---	----	----	----------------------	------------------------	--------	-----	--

SERIE : CBH**CBH280 4x2****Truck - Porteur - Rigid****voor-avant-front-Vorne**

A124T157ZA75	90	14	700	820	28	--	113	142	1/12+13/10	A03t
A124T155ZA75	90	15	700	820	28	--	89	138	1/12+14/9	A03t

achter-arrière-rear-Hinten

A	A124T180ZA76	100	11/P/5	775	925	32	--	128	200		A03A
H	A124T180ZA75	100	11	775	925	32	--	128	134	1/14+10/12	A03
H	A124T180HA80	100	5/P	610	610	--	--	106	66	5/11+P/11	A08
A	A124T238ZA76	100	11/P/9	775	960	32	--		244		A03A
H	A124T238ZA75	100	11	775	960	32	--		134	1/14+10/12	A03
H	A124T238HA80	100	9/P	610	610	--	--		110	9/11+P/11	A08

CBH280 6x4**Truck - Porteur - Rigid****voor-avant-front-Vorne**

A124T157ZA75	90	14	700	820	28	--	113	142	1/12+13/10	A03t
A124T155ZA75	90	15	700	820	28	--	89	138	1/12+14/9	A03t

achter-arrière-rear-Hinten

A124T152ZA70	100	9/P	745	745	--	--	15	208	9/22+P/10	A08R
--------------	-----	-----	-----	-----	----	----	----	-----	-----------	------

Trekker - Tracteur - Tractor**voor-avant-front-Vorne**

A124T157ZA75	90	14	700	820	28	--	113	142	1/12+13/10	A03t
A124T155ZA75	90	15	700	820	28	--	89	138	1/12+14/9	A03t

achter-arrière-rear-Hinten

A124T152ZA70	100	9/P	745	745	--	--	15	208	9/22+P/10	A08R
--------------	-----	-----	-----	-----	----	----	----	-----	-----------	------

BESTELNR N° COMMANDE ORDER NR BESTELNR	BR LRG WID BR	BLADEN LAMES LEAVES BLATT.	B	C	D1	D2	PH FL FA SP	PAK EP TH PAK	DETAIL	MOD	OPMERKINGEN REMARQUES REMARKS BEMERKUNGEN
---	------------------------	-------------------------------------	---	---	----	----	----------------------	------------------------	--------	-----	--

SERIE : CBH**CBH280 6x6****Truck - Porteur - Rigid****voor-avant-front-Vorne**

A124T157ZA75	90	14	700	820	28	--	113	142	1/12+13/10	A03t
A124T155ZA75	90	15	700	820	28	--	89	138	1/12+14/9	A03t

achter-arrière-rear-Hinten

A124T152ZA70	100	9/P	745	745	--	--	15	208	9/22+P/10	A08R
--------------	-----	-----	-----	-----	----	----	----	-----	-----------	------

CBH320 6x4**Truck - Porteur - Rigid****voor-avant-front-Vorne**

A124T157ZA75	90	14	700	820	28	--	113	142	1/12+13/10	A03t
A124T275ZA75	90	14	700	820	28	--	89	142	1/13+13/10	A03t
A124T155ZA75	90	15	700	820	28	--	89	138	1/12+14/9	A03t

achter-arrière-rear-Hinten

A	A124T310ZA76	100	13/P/11	775	960	32	--	192	303	1/14+12/12+11/11	A03A
	A124T310ZA75	100	13	775	960	32	--	192	158	1/14+12/12	A03
H	A124T310HA80	100	11/P	610	610			48	135	11/11+P/24	A08
	A124T294ZA70	100	9/P	770	770	--	--	15	208	9/22+P/10	A08R

CBH320 6x6**Truck - Porteur - Rigid****voor-avant-front-Vorne**

A124T157ZA75	90	14	700	820	28	--	113	142	1/12+13/10	A03t
A124T275ZA75	90	14	700	820	28	--	89	142	1/13+13/10	A03t
A124T155ZA75	90	15	700	820	28	--	89	138	1/12+14/9	A03t

achter-arrière-rear-Hinten

A	A124T310ZA76	100	13/P/11	775	960	32	--	192	303	1/14+12/12+11/11	A03A
	A124T310ZA75	100	13	775	960	32	--	192	158	1/14+12/12	A03
H	A124T310HA80	100	11/P	610	610			48	135	11/11+P/24	A08
	A124T294ZA70	100	9/P	770	770	--	--	15	208	9/22+P/10	A08R

BESTELNR N° COMMANDE ORDER NR BESTELNR	BR LRG WID BR	BLADEN LAMES LEAVES BLATT.	B	C	D1	D2	PH FL FA SP	PAK EP TH PAK	DETAIL	MOD	OPMERKINGEN REMARKS REMARKS BEMERKUNGEN
---	------------------------	-------------------------------------	---	---	----	----	----------------------	------------------------	--------	-----	--

SERIE : CBH**CBH340 4x2****Truck - Porteur - Rigid****voor-avant-front-Vorne**

A124T157ZA75	90	14	700	820	28	--	113	142	1/12+13/10	A03t
A124T155ZA75	90	15	700	820	28	--	89	138	1/12+14/9	A03t

achter-arrière-rear-Hinten

A	A124T180ZA76	100	11/P/5	775	925	32	--	128	200		A03A
H	A124T180ZA75	100	11	775	925	32	--	128	134	1/14+10/12	A03
H	A124T180HA80	100	5/P	610	610	--	--	106	66	5/11+P/11	A08
A	A124T238ZA76	100	11/P/9	775	960	32	--		244		A03A
H	A124T238ZA75	100	11	775	960	32	--		134	1/14+10/12	A03
H	A124T238HA80	100	9/P	610	610	--	--		110	9/11+P/11	A08

CBH340 6x4**Truck - Porteur - Rigid****voor-avant-front-Vorne**

A124T157ZA75	90	14	700	820	28	--	113	142	1/12+13/10	A03t
A124T155ZA75	90	15	700	820	28	--	89	138	1/12+14/9	A03t

achter-arrière-rear-Hinten

A124T152ZA70	100	9/P	745	745	--	--	15	208	9/22+P/10	A08R
--------------	-----	-----	-----	-----	----	----	----	-----	-----------	------

Trekker - Tracteur - Tractor**voor-avant-front-Vorne**

A124T157ZA75	90	14	700	820	28	--	113	142	1/12+13/10	A03t
A124T155ZA75	90	15	700	820	28	--	89	138	1/12+14/9	A03t

achter-arrière-rear-Hinten

A124T152ZA70	100	9/P	745	745	--	--	15	208	9/22+P/10	A08R
--------------	-----	-----	-----	-----	----	----	----	-----	-----------	------

BESTELNR N° COMMANDE ORDER NR BESTELNR	BR LRG WID BR	BLADEN LAMES LEAVES BLATT.	B	C	D1	D2	PH FL FA SP	PAK EP TH PAK	DETAIL	MOD	OPMERKINGEN REMARQUES REMARKS BEMERKUNGEN
---	------------------------	-------------------------------------	---	---	----	----	----------------------	------------------------	--------	-----	--

SERIE : CBH**CBH340 6x6****Truck - Porteur - Rigid****voor-avant-front-Vorne**

A124T157ZA75	90	14	700	820	28	--	113	142	1/12+13/10	A03t
A124T155ZA75	90	15	700	820	28	--	89	138	1/12+14/9	A03t

achter-arrière-rear-Hinten

A124T152ZA70	100	9/P	745	745	--	--	15	208	9/22+P/10	A08R
--------------	-----	-----	-----	-----	----	----	----	-----	-----------	------

CBH350 6x4**Truck - Porteur - Rigid****voor-avant-front-Vorne**

A124T157ZA75	90	14	700	820	28	--	113	142	1/12+13/10	A03t
A124T155ZA75	90	15	700	820	28	--	89	138	1/12+14/9	A03t

achter-arrière-rear-Hinten

A124T152ZA70	100	9/P	745	745	--	--	15	208	9/22+P/10	A08R
--------------	-----	-----	-----	-----	----	----	----	-----	-----------	------

Trekker - Tracteur - Tractor**voor-avant-front-Vorne**

A124T157ZA75	90	14	700	820	28	--	113	142	1/12+13/10	A03t
A124T155ZA75	90	15	700	820	28	--	89	138	1/12+14/9	A03t

achter-arrière-rear-Hinten

A124T152ZA70	100	9/P	745	745	--	--	15	208	9/22+P/10	A08R
--------------	-----	-----	-----	-----	----	----	----	-----	-----------	------

CBH350 6x6**Truck - Porteur - Rigid****voor-avant-front-Vorne**

A124T157ZA75	90	14	700	820	28	--	113	142	1/12+13/10	A03t
A124T155ZA75	90	15	700	820	28	--	89	138	1/12+14/9	A03t

achter-arrière-rear-Hinten

A124T152ZA70	100	9/P	745	745	--	--	15	208	9/22+P/10	A08R
--------------	-----	-----	-----	-----	----	----	----	-----	-----------	------

BESTELNR N° COMMANDE ORDER NR BESTELLNR	BR LRG WID BR	BLADEN LAMES LEAVES BLATT.	B	C	D1	D2	PH FL FA SP	PAK EP TH PAK	DETAIL	MOD	OPMERKINGEN REMARQUES REMARKS BEMERKUNGEN
--	------------------------	-------------------------------------	---	---	----	----	----------------------	------------------------	--------	-----	--

SERIE : CBH**CBH380 6x4****Truck - Porteur - Rigid****voor-avant-front-Vorne**

A124T157ZA75	90	14	700	820	28	--	113	142	1/12+13/10	A03t
A124T155ZA75	90	15	700	820	28	--	89	138	1/12+14/9	A03t

achter-arrière-rear-Hinten

A124T152ZA70	100	9/P	745	745	--	--	15	208	9/22+P/10	A08R
--------------	-----	-----	-----	-----	----	----	----	-----	-----------	------

Trekker - Tracteur - Tractor**voor-avant-front-Vorne**

A124T157ZA75	90	14	700	820	28	--	113	142	1/12+13/10	A03t
A124T155ZA75	90	15	700	820	28	--	89	138	1/12+14/9	A03t

achter-arrière-rear-Hinten

A124T152ZA70	100	9/P	745	745	--	--	15	208	9/22+P/10	A08R
--------------	-----	-----	-----	-----	----	----	----	-----	-----------	------

CBH380 6x6**Truck - Porteur - Rigid****voor-avant-front-Vorne**

A124T157ZA75	90	14	700	820	28	--	113	142	1/12+13/10	A03t
A124T155ZA75	90	15	700	820	28	--	89	138	1/12+14/9	A03t

achter-arrière-rear-Hinten

A124T152ZA70	100	9/P	745	745	--	--	15	208	9/22+P/10	A08R
--------------	-----	-----	-----	-----	----	----	----	-----	-----------	------

BESTELNR N° COMMANDE ORDER NR BESTELNR	BR LRG WID BR	BLADEN LAMES LEAVES BLATT.	B	C	D1	D2	PH FL FA SP	PAK EP TH PAK	DETAIL	MOD	OPMERKINGEN REMARQUES REMARKS BEMERKUNGEN
---	------------------------	-------------------------------------	---	---	----	----	----------------------	------------------------	--------	-----	--

SERIE : CBH

CBH385 6x4

Truck - Porteur - Rigid

voor-avant-front-Vorne

A124T275ZA75	90	14	700	820	28	--	89	142	1/13+13/10	A03t
A124T157ZA75	90	14	700	820	28	--	113	142	1/12+13/10	A03t
A124T155ZA75	90	15	700	820	28	--	89	138	1/12+14/9	A03t

achter-arrière-rear-Hinten

A	A124T310ZA76	100	13/P/11	775	960	32	--	192	303	1/14+12/12+11/11	A03A
	A124T310ZA75	100	13	775	960	32	--	192	158	1/14+12/12	A03
H	A124T310HA80	100	11/P	610	610			48	135	11/11+P/24	A08
	A124T294ZA70	100	9/P	770	770	--	--	15	208	9/22+P/10	A08R

CBH385 6x6

Truck - Porteur - Rigid

voor-avant-front-Vorne

A124T157ZA75	90	14	700	820	28	--	113	142	1/12+13/10	A03t
A124T275ZA75	90	14	700	820	28	--	89	142	1/13+13/10	A03t
A124T155ZA75	90	15	700	820	28	--	89	138	1/12+14/9	A03t

achter-arrière-rear-Hinten

A	A124T310ZA76	100	13/P/11	775	960	32	--	192	303	1/14+12/12+11/11	A03A
	A124T310ZA75	100	13	775	960	32	--	192	158	1/14+12/12	A03
H	A124T310HA80	100	11/P	610	610			48	135	11/11+P/24	A08
	A124T294ZA70	100	9/P	770	770	--	--	15	208	9/22+P/10	A08R

BESTELNR N° COMMANDE ORDER NR BESTELNR	BR LRG WID BR	BLADEN LAMES LEAVES BLATT.	B	C	D1	D2	PH FL FA SP	PAK EP TH PAK	DETAIL	MOD	OPMERKINGEN REMARQUES REMARKS BEMERKUNGEN
---	------------------------	-------------------------------------	---	---	----	----	----------------------	------------------------	--------	-----	--

SERIE : CLM

CLM240

Truck - Porteur - Rigid

voor-avant-front-Vorne

A124T157ZA75	90	14	700	820	28	--	113	142	1/12+13/10	A03t
A124T155ZA75	90	15	700	820	28	--	89	138	1/12+14/9	A03t

achter-arrière-rear-Hinten

A	A124T180ZA76	100	11/P/5	775	925	32	--	128	200		A03A
A	A124T180ZA75	100	11	775	925	32	--	128	134	1/14+10/12	A03
H	A124T180HA80	100	5/P	610	610	--	--	106	66	5/11+P/11	A08

CLM280 4x2

Truck - Porteur - Rigid

voor-avant-front-Vorne

A124T155ZA75	90	15	700	820	28	--	89	138	1/12+14/9	A03t
--------------	----	----	-----	-----	----	----	----	-----	-----------	------

achter-arrière-rear-Hinten

A	A124T180ZA76	100	11/P/5	775	925	32	--	128	200		A03A
A	A124T180ZA75	100	11	775	925	32	--	128	134	1/14+10/12	A03
H	A124T180HA80	100	5/P	610	610	--	--	106	66	5/11+P/11	A08
A	A124T238ZA76	100	11/P/9	775	960	32	--		244		A03A
A	A124T238ZA75	100	11	775	960	32	--		134	1/14+10/12	A03
H	A124T238HA80	100	9/P	610	610	--	--		110	9/11+P/11	A08

Trekker - Tracteur - Tractor

voor-avant-front-Vorne

A124T155ZA75	90	15	700	820	28	--	89	138	1/12+14/9	A03t
--------------	----	----	-----	-----	----	----	----	-----	-----------	------

achter-arrière-rear-Hinten

A	A124T180ZA76	100	11/P/5	775	925	32	--	128	200		A03A
A	A124T180ZA75	100	11	775	925	32	--	128	134	1/14+10/12	A03
H	A124T180HA80	100	5/P	610	610	--	--	106	66	5/11+P/11	A08
A	A124T238ZA76	100	11/P/9	775	960	32	--		244		A03A
A	A124T238ZA75	100	11	775	960	32	--		134	1/14+10/12	A03
H	A124T238HA80	100	9/P	610	610	--	--		110	9/11+P/11	A08

BESTELNR N° COMMANDE ORDER NR BESTELNR	BR LRG WID BR	BLADEN LAMES LEAVES BLATT.	B	C	D1	D2	PH FL FA SP	PAK EP TH PAK	DETAIL	MOD	OPMERKINGEN REMARQUES REMARKS BEMERKUNGEN
---	------------------------	-------------------------------------	---	---	----	----	----------------------	------------------------	--------	-----	--

SERIE : CLM

CLM320 4x2

Truck - Porteur - Rigid

voor-avant-front-Vorne

A124T155ZA75	90	15	700	820	28	--	89	138	1/12+14/9	A03t
--------------	----	----	-----	-----	----	----	----	-----	-----------	------

achter-arrière-rear-Hinten

A	A124T180ZA76	100	11/P/5	775	925	32	--	128	200		A03A
H	A124T180ZA75	100	11	775	925	32	--	128	134	1/14+10/12	A03
H	A124T180HA80	100	5/P	610	610	--	--	106	66	5/11+P/11	A08
A	A124T238ZA76	100	11/P/9	775	960	32	--		244		A03A
H	A124T238ZA75	100	11	775	960	32	--		134	1/14+10/12	A03
H	A124T238HA80	100	9/P	610	610	--	--		110	9/11+P/11	A08
A	A124T310ZA76	100	13/P/11	775	960	32	--	192	303	1/14+12/12+11/11	A03A
H	A124T310ZA75	100	13	775	960	32	--	192	158	1/14+12/12	A03
H	A124T310HA80	100	11/P	610	610			48	135	11/11+P/24	A08

CLM340 4x2

Truck - Porteur - Rigid

voor-avant-front-Vorne

A124T155ZA75	90	15	700	820	28	--	89	138	1/12+14/9	A03t
--------------	----	----	-----	-----	----	----	----	-----	-----------	------

achter-arrière-rear-Hinten

A	A124T180ZA76	100	11/P/5	775	925	32	--	128	200		A03A
H	A124T180ZA75	100	11	775	925	32	--	128	134	1/14+10/12	A03
H	A124T180HA80	100	5/P	610	610	--	--	106	66	5/11+P/11	A08
A	A124T238ZA76	100	11/P/9	775	960	32	--		244		A03A
H	A124T238ZA75	100	11	775	960	32	--		134	1/14+10/12	A03
H	A124T238HA80	100	9/P	610	610	--	--		110	9/11+P/11	A08

Trekker - Tracteur - Tractor

voor-avant-front-Vorne

A124T155ZA75	90	15	700	820	28	--	89	138	1/12+14/9	A03t
--------------	----	----	-----	-----	----	----	----	-----	-----------	------

achter-arrière-rear-Hinten

A	A124T180ZA76	100	11/P/5	775	925	32	--	128	200		A03A
H	A124T180ZA75	100	11	775	925	32	--	128	134	1/14+10/12	A03
H	A124T180HA80	100	5/P	610	610	--	--	106	66	5/11+P/11	A08
A	A124T238ZA76	100	11/P/9	775	960	32	--		244		A03A
H	A124T238ZA75	100	11	775	960	32	--		134	1/14+10/12	A03
H	A124T238HA80	100	9/P	610	610	--	--		110	9/11+P/11	A08

BESTELNR N° COMMANDE ORDER NR BESTELNR	BR LRG WID BR	BLADEN LAMES LEAVES BLATT.	B	C	D1	D2	PH FL FA SP	PAK EP TH PAK	DETAIL	MOD	OPMERKINGEN REMARQUES REMARKS BEMERKUNGEN
---	------------------------	-------------------------------------	---	---	----	----	----------------------	------------------------	--------	-----	--

SERIE : CLM

CLM350 4x2

Truck - Porteur - Rigid

voor-avant-front-Vorne

A124T155ZA75	90	15	700	820	28	--	89	138	1/12+14/9	A03t
--------------	----	----	-----	-----	----	----	----	-----	-----------	------

achter-arrière-rear-Hinten

	A124T180ZA76	100	11/P/5	775	925	32	--	128	200		A03A
A	A124T180ZA75	100	11	775	925	32	--	128	134	1/14+10/12	A03
H	A124T180HA80	100	5/P	610	610	--	--	106	66	5/11+P/11	A08
	A124T238ZA76	100	11/P/9	775	960	32	--		244		A03A
A	A124T238ZA75	100	11	775	960	32	--		134	1/14+10/12	A03
H	A124T238HA80	100	9/P	610	610	--	--		110	9/11+P/11	A08

Trekker - Tracteur - Tractor

voor-avant-front-Vorne

A124T155ZA75	90	15	700	820	28	--	89	138	1/12+14/9	A03t
--------------	----	----	-----	-----	----	----	----	-----	-----------	------

achter-arrière-rear-Hinten

	A124T180ZA76	100	11/P/5	775	925	32	--	128	200		A03A
A	A124T180ZA75	100	11	775	925	32	--	128	134	1/14+10/12	A03
H	A124T180HA80	100	5/P	610	610	--	--	106	66	5/11+P/11	A08
	A124T238ZA76	100	11/P/9	775	960	32	--		244		A03A
A	A124T238ZA75	100	11	775	960	32	--		134	1/14+10/12	A03
H	A124T238HA80	100	9/P	610	610	--	--		110	9/11+P/11	A08

BESTELNR N° COMMANDE ORDER NR BESTELNR	BR LRG WID BR	BLADEN LAMES LEAVES BLATT.	B	C	D1	D2	PH FL FA SP	PAK EP TH PAK	DETAIL	MOD	OPMERKINGEN REMARQUES REMARKS BEMERKUNGEN
---	------------------------	-------------------------------------	---	---	----	----	----------------------	------------------------	--------	-----	--

SERIE : CLM

CLM380 4x2

Truck - Porteur - Rigid

voor-avant-front-Vorne

A124T155ZA75	90	15	700	820	28	--	89	138	1/12+14/9	A03t
--------------	----	----	-----	-----	----	----	----	-----	-----------	------

achter-arrière-rear-Hinten

A	A124T180ZA76	100	11/P/5	775	925	32	--	128	200		A03A
A	A124T180ZA75	100	11	775	925	32	--	128	134	1/14+10/12	A03
H	A124T180HA80	100	5/P	610	610	--	--	106	66	5/11+P/11	A08
A	A124T238ZA76	100	11/P/9	775	960	32	--		244		A03A
A	A124T238ZA75	100	11	775	960	32	--		134	1/14+10/12	A03
H	A124T238HA80	100	9/P	610	610	--	--		110	9/11+P/11	A08

Trekker - Tracteur - Tractor

voor-avant-front-Vorne

A124T155ZA75	90	15	700	820	28	--	89	138	1/12+14/9	A03t
--------------	----	----	-----	-----	----	----	----	-----	-----------	------

achter-arrière-rear-Hinten

A	A124T180ZA76	100	11/P/5	775	925	32	--	128	200		A03A
A	A124T180ZA75	100	11	775	925	32	--	128	134	1/14+10/12	A03
H	A124T180HA80	100	5/P	610	610	--	--	106	66	5/11+P/11	A08
A	A124T238ZA76	100	11/P/9	775	960	32	--		244		A03A
A	A124T238ZA75	100	11	775	960	32	--		134	1/14+10/12	A03
H	A124T238HA80	100	9/P	610	610	--	--		110	9/11+P/11	A08

CLM385 4x2

Truck - Porteur - Rigid

voor-avant-front-Vorne

A124T155ZA75	90	15	700	820	28	--	89	138	1/12+14/9	A03t
--------------	----	----	-----	-----	----	----	----	-----	-----------	------

achter-arrière-rear-Hinten

A	A124T180ZA76	100	11/P/5	775	925	32	--	128	200		A03A
A	A124T180ZA75	100	11	775	925	32	--	128	134	1/14+10/12	A03
H	A124T180HA80	100	5/P	610	610	--	--	106	66	5/11+P/11	A08
A	A124T238ZA76	100	11/P/9	775	960	32	--		244		A03A
A	A124T238ZA75	100	11	775	960	32	--		134	1/14+10/12	A03
H	A124T238HA80	100	9/P	610	610	--	--		110	9/11+P/11	A08
A	A124T310ZA76	100	13/P/11	775	960	32	--	192	303	1/14+12/12+11/11	A03A
A	A124T310ZA75	100	13	775	960	32	--	192	158	1/14+12/12	A03
H	A124T310HA80	100	11/P	610	610			48	135	11/11+P/24	A08

BESTELNR N° COMMANDE ORDER NR BESTELNR	BR LRG WID BR	BLADEN LAMES LEAVES BLATT.	B	C	D1	D2	PH FL FA SP	PAK EP TH PAK	DETAIL	MOD	OPMERKINGEN REMARKS REMARKS BEMERKUNGEN
---	------------------------	-------------------------------------	---	---	----	----	----------------------	------------------------	--------	-----	--

SERIE : CLR

CLR220 4x2

Truck - Porteur - Rigid

voor-avant-front-Vorne

A124T271ZA75	90	9	820	820	36	36	142	111	1/15+8/12	A01
A124T153ZA75	90	9	820	820	36	36	115	119	1/15+8/13	A01

achter-arrière-rear-Hinten

A	A124T286ZA76	90	8/P/10	825	670	36	36		227	8/14+10/10+1/15	A01A
	A124T286ZA75	90	8	825	670	36	36		112	8/14	A01
H	A124T286HA80	90	10/P	650	530				115	10/10+P/15	A08
A	A124T156ZA76	90	9/P/7	825	1000	36	--	115	222	9/14+8/12	A03A
	A124T156ZA75	90	9	825	1000	36	--	115	126	9/14	A03
H	A124T156HA80	90	7/P	650	650	--	--	63	96	7/12+P/12	A08

CLR220 4x4

Truck - Porteur - Rigid

voor-avant-front-Vorne

A124T273ZA75	90	10	820	820	36	36		126	2/15+8/12	A01
A124T293ZA75	90	10	820	820	36	36		134	2/15+8/13	A01

achter-arrière-rear-Hinten

A	A124T286ZA76	90	8/P/10	825	670	36	36		227	8/14+10/10+1/15	A01A
	A124T286ZA75	90	8	825	670	36	36		112	8/14	A01
H	A124T286HA80	90	10/P	650	530				115	10/10+P/15	A08
A	A124T156ZA76	90	9/P/7	825	1000	36	--	115	222	9/14+8/12	A03A
	A124T156ZA75	90	9	825	1000	36	--	115	126	9/14	A03
H	A124T156HA80	90	7/P	650	650	--	--	63	96	7/12+P/12	A08

BESTELNR N° COMMANDE ORDER NR BESTELNR	BR LRG WID BR	BLADEN LAMES LEAVES BLATT.	B	C	D1	D2	PH FL FA SP	PAK EP TH PAK	DETAIL	MOD	OPMERKINGEN REMARKS REMARKS BEMERKUNGEN
---	------------------------	-------------------------------------	---	---	----	----	----------------------	------------------------	--------	-----	--

SERIE : CLR**CLR230 4x2****Truck - Porteur - Rigid****voor-avant-front-Vorne**

A124T271ZA75	90	9	820	820	36	36	142	111	1/15+8/12	A01
A124T153ZA75	90	9	820	820	36	36	115	119	1/15+8/13	A01

achter-arrière-rear-Hinten

A	A124T286ZA76	90	8/P/10	825	670	36	36		227	8/14+10/10+1/15	A01A
	A124T286ZA75	90	8	825	670	36	36		112	8/14	A01
H	A124T286HA80	90	10/P	650	530				115	10/10+P/15	A08
A	A124T156ZA76	90	9/P/7	825	1000	36	--	115	222	9/14+8/12	A03A
	A124T156ZA75	90	9	825	1000	36	--	115	126	9/14	A03
H	A124T156HA80	90	7/P	650	650	--	--	63	96	7/12+P/12	A08

CLR230 4x4**Truck - Porteur - Rigid****voor-avant-front-Vorne**

A124T273ZA75	90	10	820	820	36	36		126	2/15+8/12	A01
--------------	----	----	-----	-----	----	----	--	-----	-----------	-----

achter-arrière-rear-Hinten

A	A124T156ZA76	90	9/P/7	825	1000	36	--	115	222	9/14+8/12	A03A
	A124T156ZA75	90	9	825	1000	36	--	115	126	9/14	A03
H	A124T156HA80	90	7/P	650	650	--	--	63	96	7/12+P/12	A08

BESTELNR N° COMMANDE ORDER NR BESTELNR	BR LRG WID BR	BLADEN LAMES LEAVES BLATT.	B	C	D1	D2	PH FL FA SP	PAK EP TH PAK	DETAIL	MOD	OPMERKINGEN REMARQUES REMARKS BEMERKUNGEN
---	------------------------	-------------------------------------	---	---	----	----	----------------------	------------------------	--------	-----	--

SERIE : G**G170****Truck - Porteur - Rigid****voor-avant-front-Vorne**

A124T283ZA75	75	9	820	820	28	28	180	99	9/11	A01
A124T281ZA75	75	9	820	820	28	28	160	99	9/11	A01
A124T285ZA75	75	10	820	820	28	28	145	120	10/12	A01
A124T149ZA75	90	10	820	820	28	28	160	110	10/11	A01
A124T151ZA75	90	10	820	820	28	28	170	110	10/11	A01
A124T143ZA75	90	10	820	820	28	28	160	120	1/14+8/12+1/10	A01
A124T083ZA75	90	10	820	820	28	28	190	110	10/11	A01
F023T107ZA75	90	2/P/P	820	820	28	28	165	96	2/24+P/12+P/30	F01
F023T041ZA75	90	3/P	820	820	28	28	185	93	3/22+P/18	F01.10 glijdop/pastille

achter-arrière-rear-Hinten

A124T230ZA75	90	9/P	825	995	32	--	64	140	9/14+P/14	A03
A124T304ZA75	90	9	825	1000	32	--	140	126	9/14	A03
A124T306ZA75	90	11	825	1000	32	--	140	154	11/14	A03
A124T302ZA76	90	9/10	825	995	32	--	216	189	1/12+7/11+1/10+1	A03A
A124T302ZA75	90	9	825	995	32	--	216	99	1/12+7/11+1/10	A03
A124T302HA80	90	8/2P	695	725	--	--	147	90	8/9+2P/9	A08
A124T226ZA76	90	12/11	825	995	32	--	176	252		A03A
A124T226ZA75	90	12	825	995	32	--	176	142	1/16+8/12+3/10	A03
A124T226HA80	90	11	710	710	--	--	75	110	11/10	A08
A124T172ZA76	90	11/10	825	1000	32	--	215	200		A03A
A124T172ZA75	90	11	825	1000	32	--	215	110	1/12+1/11+6/10+3	A03
A124T172HA80	90	10	695	715	--	--	110	90	10/9	A08
A124T174ZA76	90	11/10	825	1000	32	--	145	201		A03A
A124T174ZA75	90	11	825	1000	32	--	145	111	2/12+6/10+3/9	A03
A124T174HA80	90	10	695	715	--	--	70	90	10/9	A08
F023T166ZA76	90	2/P/1	825	1000	32	--	141	109	2/28+1/28+P/	F03A
F023T166ZA75	90	2/P	825	1000	32	--	141	78	2/28+P/13	F03
F023T166HA80	90	1	700	700	--	--	115	28	1/28	F08
F023T100ZA76	90	3/1	825	1000	32	--	140	120	3/25+1/30	F03A
F023T100ZA75	90	3	825	1000	32	--	140	87	3/25	F03
F023T100HA80	90	1	700	700	--	--	110	33	1/30	F08
F023T122ZA75	100	2	860	1015	S24	--	(23)	78	1/18+1/60	F74.31 Lenker

BESTELNR N° COMMANDE ORDER NR BESTELLNR	BR LRG WID BR	BLADEN LAMES LEAVES BLATT.	B	C	D1	D2	PH FL FA SP	PAK EP TH PAK	DETAIL	MOD	OPMERKINGEN REMARKS BEMERKUNGEN
--	------------------------	-------------------------------------	---	---	----	----	----------------------	------------------------	--------	-----	---------------------------------------

SERIE : G

G200

Truck - Porteur - Rigid

voor-avant-front-Vorne

A124T083ZA75	90	10	820	820	28	28	190	110	10/11	A01	
A124T267ZA75	90	10	820	820	28	20	160	124	1/14+8/12+1/10	A01	
A124T143ZA75	90	10	820	820	28	28	160	120	1/14+8/12+1/10	A01	
A124T151ZA75	90	10	820	820	28	28	170	110	10/11	A01	
A124T269ZA75	90	10	820	820	28	20		110	10/11	A01	
A124T265ZA75	90	10	820	820	28	20	190	110	10/11	A01	
F023T109ZA75	90	2/P	820	820	28	20		93	2/24+P/40	F01.10	
F023T055ZA75	90	3/P	820	820	28	20	185	93	3/22+P/18	F01.10	glijdop/pastille
F023T053ZA75	90	3/P	820	820	28	20	165	93	3/23+P/15	F01.10	glijdop/pastille

achter-arrière-rear-Hinten

A	A124T302ZA76	90	9/10	825	995	32	--	216	189	1/12+7/11+1/10+1	A03A	
A	A124T302ZA75	90	9	825	995	32	--	216	99	1/12+7/11+1/10	A03	
H	A124T302HA80	90	8/2P	695	725	--	--	147	90	8/9+2P/9	A08	
A	A124T172ZA76	90	11/10	825	1000	32	--	215	200		A03A	
A	A124T172ZA75	90	11	825	1000	32	--	215	110	1/12+1/11+6/10+3	A03	
H	A124T172HA80	90	10	695	715	--	--	110	90	10/9	A08	
A	A124T168ZA76	100	8/2P/5	825	1000	32	--	158	200		A03A	
A	A124T168ZA75	100	8	825	1000	32	--	158	112	8/14	A03	
H	A124T168HA80	100	5/2P	650	650	--	--	75	88	5/12+2P/14	A08	
A	A124T086ZA76	100	8/P/10	825	1000	32	--	158	215		A03A	
A	A124T086ZA75	100	8	825	1000	32	--	158	105	1/14+7/13	A03	
H	A124T086HA80	100	10/P	650	650	--	--	95	110	10/10+P/10	A08	
A	F023T166ZA76	90	2/P/1	825	1000	32	--	141	109	2/28+1/28+P/	F03A	
A	F023T166ZA75	90	2/P	825	1000	32	--	141	78	2/28+P/13	F03	
H	F023T166HA80	90	1	700	700	--	--	115	28	1/28	F08	
A	F023T100ZA76	90	3/1	825	1000	32	--	140	120	3/25+1/30	F03A	
A	F023T100ZA75	90	3	825	1000	32	--	140	87	3/25	F03	
H	F023T100HA80	90	1	700	700	--	--	110	33	1/30	F08	
A	F023T054ZA76	100	3/P/1	825	1000	32	--	155	138	3/26+1/28+P/20	F03A	
A	F023T054ZA75	100	3	825	1000	32	--	155	87	3/26	F03	
H	F023T054HA80	100	1/P	670	670	--	--	140	51	1/28+P/20	F08	
A	F023T060ZA76	100	3/P/1	825	1000	32	--	155	139	3/26+1/29+P/20	F03A	
A	F023T054ZA75	100	3	825	1000	32	--	155	87	3/26	F03	
H	F023T060HA80	100	1/P	670	670	--	--	150	52	1/29+P/20	F08	
	F023T122ZA75	100	2	860	1015	S24	--	(23)	78	1/18+1/60	F74.31	Lenker

BESTELNR N° COMMANDE ORDER NR BESTELNR	BR LRG WID BR	BLADEN LAMES LEAVES BLATT.	B	C	D1	D2	PH FL FA SP	PAK EP TH PAK	DETAIL	MOD	OPMERKINGEN REMARQUES REMARKS BEMERKUNGEN
---	------------------------	-------------------------------------	---	---	----	----	----------------------	------------------------	--------	-----	--

SERIE : G**G210****Truck - Porteur - Rigid****voor-avant-front-Vorne**

A124T083ZA75	90	10	820	820	28	28	190	110	10/11	A01	
A124T143ZA75	90	10	820	820	28	28	160	120	1/14+8/12+1/10	A01	
A124T269ZA75	90	10	820	820	28	20		110	10/11	A01	
A124T267ZA75	90	10	820	820	28	20	160	124	1/14+8/12+1/10	A01	
A124T151ZA75	90	10	820	820	28	28	170	110	10/11	A01	
A124T149ZA75	90	10	820	820	28	28	160	110	10/11	A01	
F023T107ZA75	90	2/P/P	820	820	28	28	165	96	2/24+P/12+P/30	F01	
F023T109ZA75	90	2/P	820	820	28	20		93	2/24+P/40	F01.10	
F023T055ZA75	90	3/P	820	820	28	20	185	93	3/22+P/18	F01.10	glijdop/pastille
F023T053ZA75	90	3/P	820	820	28	20	165	93	3/23+P/15	F01.10	glijdop/pastille
F023T041ZA75	90	3/P	820	820	28	28	185	93	3/22+P/18	F01.10	glijdop/pastille
F023T039ZA75	90	3/P	820	820	28	28	165	93	3/23+P/15	F01.10	glijdop/pastille

BESTELNR N° COMMANDE ORDER NR BESTELLNR	BR LRG WID BR	BLADEN LAMES LEAVES BLATT.	B	C	D1	D2	PH FL FA SP	PAK EP TH PAK	DETAIL	MOD	OPMERKINGEN REMARKS BEMERKUNGEN
--	------------------------	-------------------------------------	---	---	----	----	----------------------	------------------------	--------	-----	---------------------------------------

SERIE : G**G210****achter-arrière-rear-Hinten**

A	A124T228ZA76	90	8/2P/5	825	815	32	--	194	198	8/14+6/12+1/14	A03A
A	A124T228ZA75	90	8	825	815	32	--	194	112	8/14	A03
H	A124T228HA80	90	5/2P	650	465	--	--	71	86	5/12+P/12+P/14	A08
A	A124T302ZA76	90	9/10	825	995	32	--	216	189	1/12+7/11+1/10+1	A03A
A	A124T302ZA75	90	9	825	995	32	--	216	99	1/12+7/11+1/10	A03
H	A124T302HA80	90	8/2P	695	725	--	--	147	90	8/9+2P/9	A08
A	A124T226ZA76	90	12/11	825	995	32	--	176	252		A03A
A	A124T226ZA75	90	12	825	995	32	--	176	142	1/16+8/12+3/10	A03
H	A124T226HA80	90	11	710	710	--	--	75	110	11/10	A08
A	A124T174ZA76	90	11/10	825	1000	32	--	145	201		A03A
A	A124T174ZA75	90	11	825	1000	32	--	145	111	2/12+6/10+3/9	A03
H	A124T174HA80	90	10	695	715	--	--	70	90	10/9	A08
A	A124T172ZA76	90	11/10	825	1000	32	--	215	200		A03A
A	A124T172ZA75	90	11	825	1000	32	--	215	110	1/12+1/11+6/10+3	A03
H	A124T172HA80	90	10	695	715	--	--	110	90	10/9	A08
A	A124T176ZA76	100	8/2P/5	825	815	32	--	140	196		A03A
A	A124T176ZA75	100	8	825	815	32	--	140	112	8/14	A03
H	A124T176HA80	100	5/2P	645	475	--	--	55	84	5/12+2P/12	A08
A	A124T168ZA76	100	8/2P/5	825	1000	32	--	158	200		A03A
A	A124T168ZA75	100	8	825	1000	32	--	158	112	8/14	A03
H	A124T168HA80	100	5/2P	650	650	--	--	75	88	5/12+2P/14	A08
A	A124T166ZA76	100	9/2P/6	825	1000	32	--	80	238	9/14+6/14+2P/14	A03A
A	A124T166ZA75	100	9	825	1000	32	--	80	126	9/14	A03
H	A124T166HA80	100	6/2P	650	650	--	--	47	112	6/14+2P/14	A08
A	A124T086ZA76	100	8/P/10	825	1000	32	--	158	215		A03A
A	A124T086ZA75	100	8	825	1000	32	--	158	105	1/14+7/13	A03
H	A124T086HA80	100	10/P	650	650	--	--	95	110	10/10+P/10	A08
A	F023T166ZA76	90	2/P/1	825	1000	32	--	141	109	2/28+1/28+P/	F03A
A	F023T166ZA75	90	2/P	825	1000	32	--	141	78	2/28+P/13	F03
H	F023T166HA80	90	1	700	700	--	--	115	28	1/28	F08
A	F023T168ZA76	90	3/P/1	825	1000	32	--		140	3/26+1/30+P/	F03A
A	F023T168ZA75	90	3	825	1000	32	--		90	3/26	F03
H	F023T168HA80	90	1	650	650	--	--	126	30	1/30	F08
A	F023T100ZA76	90	3/1	825	1000	32	--	140	120	3/25+1/30	F03A
A	F023T100ZA75	90	3	825	1000	32	--	140	87	3/25	F03
H	F023T100HA80	90	1	700	700	--	--	110	33	1/30	F08
A	F023T060ZA76	100	3/P/1	825	1000	32	--	155	139	3/26+1/29+P/20	F03A
A	F023T054ZA75	100	3	825	1000	32	--	155	87	3/26	F03
H	F023T060HA80	100	1/P	670	670	--	--	150	52	1/29+P/20	F08
A	F023T054ZA76	100	3/P/1	825	1000	32	--	155	138	3/26+1/28+P/20	F03A
A	F023T054ZA75	100	3	825	1000	32	--	155	87	3/26	F03
H	F023T054HA80	100	1/P	670	670	--	--	140	51	1/28+P/20	F08
	F023T122ZA75	100	2	860	1015	S24	--	(23)	78	1/18+1/60	F74.31 Lenker

BESTELNR N° COMMANDE ORDER NR BESTELNR	BR LRG WID BR	BLADEN LAMES LEAVES BLATT.	B	C	D1	D2	PH FL FA SP	PAK EP TH PAK	DETAIL	MOD	OPMERKINGEN REMARQUES REMARKS BEMERKUNGEN
---	------------------------	-------------------------------------	---	---	----	----	----------------------	------------------------	--------	-----	--

SERIE : G

G210

Trekker - Tracteur - Tractor

voor-avant-front-Vorne

F023T031ZA75	90	2/P/W	870	870	28	28	170	102	2/25+P/25+W	F01.10	glijdop/pastille
F023T033ZA75	90	3	870	870	28	28	195	93	3/21+W	F01.10	glijdop/pastille

achter-arrière-rear-Hinten

F023T058ZA75	90	4/P	825	1000	32	--	160	145	4/26+P/26	F03	
F023T122ZA75	100	2	860	1015	S24	--	(23)	78	1/18+1/60	F74.31	Lenker

G220

Truck - Porteur - Rigid

voor-avant-front-Vorne

A124T143ZA75	90	10	820	820	28	28	160	120	1/14+8/12+1/10	A01	
A124T267ZA75	90	10	820	820	28	20	160	124	1/14+8/12+1/10	A01	

achter-arrière-rear-Hinten

	A124T228ZA76	90	8/2P/5	825	815	32	--	194	198	8/14+6/12+1/14	A03A
A	A124T228ZA75	90	8	825	815	32	--	194	112	8/14	A03
H	A124T228HA80	90	5/2P	650	465	--	--	71	86	5/12+P/12+P/14	A08
	A124T176ZA76	100	8/2P/5	825	815	32	--	140	196		A03A
A	A124T176ZA75	100	8	825	815	32	--	140	112	8/14	A03
H	A124T176HA80	100	5/2P	645	475	--	--	55	84	5/12+2P/12	A08

BESTELNR N° COMMANDE ORDER NR BESTELLNR	BR LRG WID BR	BLADEN LAMES LEAVES BLATT.	B	C	D1	D2	PH FL FA SP	PAK EP TH PAK	DETAIL	MOD	OPMERKINGEN REMARQUES REMARKS BEMERKUNGEN
--	------------------------	-------------------------------------	---	---	----	----	----------------------	------------------------	--------	-----	--

SERIE : G**G230****Truck - Porteur - Rigid****voor-avant-front-Vorne**

A124T281ZA75	75	9	820	820	28	28	160	99	9/11	A01	
A124T083ZA75	90	10	820	820	28	28	190	110	10/11	A01	
A124T143ZA75	90	10	820	820	28	28	160	120	1/14+8/12+1/10	A01	
A124T149ZA75	90	10	820	820	28	28	160	110	10/11	A01	
A124T289ZA75	90	10	820	820	28	20	160	110	10/11	A01	
A124T151ZA75	90	10	820	820	28	28	170	110	10/11	A01	
F023T107ZA75	90	2/P/P	820	820	28	28	165	96	2/24+P/12+P/30	F01	
F023T041ZA75	90	3/P	820	820	28	28	185	93	3/22+P/18	F01.10	glijdop/pastille
F023T039ZA75	90	3/P	820	820	28	28	165	93	3/23+P/15	F01.10	glijdop/pastille

BESTELNR N° COMMANDE ORDER NR BESTELNR	BR LRG WID BR	BLADEN LAMES LEAVES BLATT.	B	C	D1	D2	PH FL FA SP	PAK EP TH PAK	DETAIL	MOD	OPMERKINGEN REMARQUES REMARKS BEMERKUNGEN
---	------------------------	-------------------------------------	---	---	----	----	----------------------	------------------------	--------	-----	--

SERIE : G

G230

achter-arrière-rear-Hinten

	A124T230ZA75	90	9/P	825	995	32	--	64	140	9/14+P/14	A03	
A	A124T228ZA76	90	8/2P/5	825	815	32	--	194	198	8/14+6/12+1/14	A03A	
	A124T228ZA75	90	8	825	815	32	--	194	112	8/14	A03	
H	A124T228HA80	90	5/2P	650	465	--	--	71	86	5/12+P/12+P/14	A08	
A	A124T226ZA76	90	12/11	825	995	32	--	176	252		A03A	
	A124T226ZA75	90	12	825	995	32	--	176	142	1/16+8/12+3/10	A03	
H	A124T226HA80	90	11	710	710	--	--	75	110	11/10	A08	
A	A124T172ZA76	90	11/10	825	1000	32	--	215	200		A03A	
	A124T172ZA75	90	11	825	1000	32	--	215	110	1/12+1/11+6/10+3	A03	
H	A124T172HA80	90	10	695	715	--	--	110	90	10/9	A08	
A	A124T174ZA76	90	11/10	825	1000	32	--	145	201		A03A	
	A124T174ZA75	90	11	825	1000	32	--	145	111	2/12+6/10+3/9	A03	
H	A124T174HA80	90	10	695	715	--	--	70	90	10/9	A08	
A	A124T176ZA76	100	8/2P/5	825	815	32	--	140	196		A03A	
	A124T176ZA75	100	8	825	815	32	--	140	112	8/14	A03	
H	A124T176HA80	100	5/2P	645	475	--	--	55	84	5/12+2P/12	A08	
A	A124T168ZA76	100	8/2P/5	825	1000	32	--	158	200		A03A	
	A124T168ZA75	100	8	825	1000	32	--	158	112	8/14	A03	
H	A124T168HA80	100	5/2P	650	650	--	--	75	88	5/12+2P/14	A08	
A	A124T166ZA76	100	9/2P/6	825	1000	32	--	80	238	9/14+6/14+2P/14	A03A	
	A124T166ZA75	100	9	825	1000	32	--	80	126	9/14	A03	
H	A124T166HA80	100	6/2P	650	650	--	--	47	112	6/14+2P/14	A08	
A	A124T086ZA76	100	8/P/10	825	1000	32	--	158	215		A03A	
	A124T086ZA75	100	8	825	1000	32	--	158	105	1/14+7/13	A03	
H	A124T086HA80	100	10/P	650	650	--	--	95	110	10/10+P/10	A08	
A	F023T168ZA76	90	3/P/1	825	1000	32	--		140	3/26+1/30+P/	F03A	
	F023T168ZA75	90	3	825	1000	32	--		90	3/26	F03	
H	F023T168HA80	90	1	650	650	--	--	126	30	1/30	F08	
A	F023T100ZA76	90	3/1	825	1000	32	--	140	120	3/25+1/30	F03A	
	F023T100ZA75	90	3	825	1000	32	--	140	87	3/25	F03	
H	F023T100HA80	90	1	700	700	--	--	110	33	1/30	F08	
A	F023T054ZA76	100	3/P/1	825	1000	32	--	155	138	3/26+1/28+P/20	F03A	
	F023T054ZA75	100	3	825	1000	32	--	155	87	3/26	F03	
H	F023T054HA80	100	1/P	670	670	--	--	140	51	1/28+P/20	F08	
A	F023T060ZA76	100	3/P/1	825	1000	32	--	155	139	3/26+1/29+P/20	F03A	
	F023T054ZA75	100	3	825	1000	32	--	155	87	3/26	F03	
H	F023T060HA80	100	1/P	670	670	--	--	150	52	1/29+P/20	F08	
	F023T122ZA75	100	2	860	1015	S24	--	(23)	78	1/18+1/60	F74.31	Lenker

BESTELNR N° COMMANDE ORDER NR BESTELNR	BR LRG WID BR	BLADEN LAMES LEAVES BLATT.	B	C	D1	D2	PH FL FA SP	PAK EP TH PAK	DETAIL	MOD	OPMERKINGEN REMARQUES REMARKS BEMERKUNGEN
---	------------------------	-------------------------------------	---	---	----	----	----------------------	------------------------	--------	-----	--

SERIE : G**G230****Trekker - Tracteur - Tractor****voor-avant-front-Vorne**

F023T031ZA75	90	2/P/W	870	870	28	28	170	102	2/25+P/25+W	F01.10	glijdop/pastille
F023T033ZA75	90	3	870	870	28	28	195	93	3/21+W	F01.10	glijdop/pastille

achter-arrière-rear-Hinten

F023T058ZA75	90	4/P	825	1000	32	--	160	145	4/26+P/26	F03	
F023T122ZA75	100	2	860	1015	S24	--	(23)	78	1/18+1/60	F74.31	Lenker

G230SP**Truck - Porteur - Rigid****voor-avant-front-Vorne**

A124T281ZA75	75	9	820	820	28	28	160	99	9/11	A01	
F023T107ZA75	90	2/P/P	820	820	28	28	165	96	2/24+P/12+P/30	F01	

achter-arrière-rear-Hinten

A124T230ZA75	90	9/P	825	995	32	--	64	140	9/14+P/14	A03	
--------------	----	-----	-----	-----	----	----	----	-----	-----------	-----	--

BESTELNR N° COMMANDE ORDER NR BESTELLNR	BR LRG WID BR	BLADEN LAMES LEAVES BLATT.	B	C	D1	D2	PH FL FA SP	PAK EP TH PAK	DETAIL	MOD	OPMERKINGEN REMARKS BEMERKUNGEN
--	------------------------	-------------------------------------	---	---	----	----	----------------------	------------------------	--------	-----	---------------------------------------

SERIE : G

G230TI

Truck - Porteur - Rigid

voor-avant-front-Vorne

A124T269ZA75	90	10	820	820	28	20		110	10/11	A01	
A124T267ZA75	90	10	820	820	28	20	160	124	1/14+8/12+1/10	A01	
A124T265ZA75	90	10	820	820	28	20	190	110	10/11	A01	
A124T151ZA75	90	10	820	820	28	28	170	110	10/11	A01	
A124T143ZA75	90	10	820	820	28	28	160	120	1/14+8/12+1/10	A01	
A124T083ZA75	90	10	820	820	28	28	190	110	10/11	A01	
F023T109ZA75	90	2/P	820	820	28	20		93	2/24+P/40	F01.10	
F023T053ZA75	90	3/P	820	820	28	20	165	93	3/23+P/15	F01.10	glijdop/pastille
F023T055ZA75	90	3/P	820	820	28	20	185	93	3/22+P/18	F01.10	glijdop/pastille

achter-arrière-rear-Hinten

A	A124T302ZA76	90	9/10	825	995	32	--	216	189	1/12+7/11+1/10+1	A03A	
A	A124T302ZA75	90	9	825	995	32	--	216	99	1/12+7/11+1/10	A03	
H	A124T302HA80	90	8/2P	695	725	--	--	147	90	8/9+2P/9	A08	
A	A124T172ZA76	90	11/10	825	1000	32	--	215	200		A03A	
A	A124T172ZA75	90	11	825	1000	32	--	215	110	1/12+1/11+6/10+3	A03	
H	A124T172HA80	90	10	695	715	--	--	110	90	10/9	A08	
A	A124T168ZA76	100	8/2P/5	825	1000	32	--	158	200		A03A	
A	A124T168ZA75	100	8	825	1000	32	--	158	112	8/14	A03	
H	A124T168HA80	100	5/2P	650	650	--	--	75	88	5/12+2P/14	A08	
A	A124T086ZA76	100	8/P/10	825	1000	32	--	158	215		A03A	
A	A124T086ZA75	100	8	825	1000	32	--	158	105	1/14+7/13	A03	
H	A124T086HA80	100	10/P	650	650	--	--	95	110	10/10+P/10	A08	
A	F023T166ZA76	90	2/P/1	825	1000	32	--	141	109	2/28+1/28+P/	F03A	
A	F023T166ZA75	90	2/P	825	1000	32	--	141	78	2/28+P/13	F03	
H	F023T166HA80	90	1	700	700	--	--	115	28	1/28	F08	
A	F023T100ZA76	90	3/1	825	1000	32	--	140	120	3/25+1/30	F03A	
A	F023T100ZA75	90	3	825	1000	32	--	140	87	3/25	F03	
H	F023T100HA80	90	1	700	700	--	--	110	33	1/30	F08	
A	F023T054ZA76	100	3/P/1	825	1000	32	--	155	138	3/26+1/28+P/20	F03A	
A	F023T054ZA75	100	3	825	1000	32	--	155	87	3/26	F03	
H	F023T054HA80	100	1/P	670	670	--	--	140	51	1/28+P/20	F08	
A	F023T060ZA76	100	3/P/1	825	1000	32	--	155	139	3/26+1/29+P/20	F03A	
A	F023T054ZA75	100	3	825	1000	32	--	155	87	3/26	F03	
H	F023T060HA80	100	1/P	670	670	--	--	150	52	1/29+P/20	F08	
	F023T122ZA75	100	2	860	1015	S24	--	(23)	78	1/18+1/60	F74.31	Lenker

BESTELNR N° COMMANDE ORDER NR BESTELLNR	BR LRG WID BR	BLADEN LAMES LEAVES BLATT.	B	C	D1	D2	PH FL FA SP	PAK EP TH PAK	DETAIL	MOD	OPMERKINGEN REMARQUES REMARKS BEMERKUNGEN
--	------------------------	-------------------------------------	---	---	----	----	----------------------	------------------------	--------	-----	--

SERIE : G

G260

Truck - Porteur - Rigid

voor-avant-front-Vorne

A124T283ZA75	75	9	820	820	28	28	180	99	9/11	A01
A124T281ZA75	75	9	820	820	28	28	160	99	9/11	A01
A124T285ZA75	75	10	820	820	28	28	145	120	10/12	A01
A124T143ZA75	90	10	820	820	28	28	160	120	1/14+8/12+1/10	A01
A124T083ZA75	90	10	820	820	28	28	190	110	10/11	A01
A124T149ZA75	90	10	820	820	28	28	160	110	10/11	A01
A124T151ZA75	90	10	820	820	28	28	170	110	10/11	A01
F023T107ZA75	90	2/P/P	820	820	28	28	165	96	2/24+P/12+P/30	F01
F023T041ZA75	90	3/P	820	820	28	28	185	93	3/22+P/18	F01.10 glijdop/pastille
F023T039ZA75	90	3/P	820	820	28	28	165	93	3/23+P/15	F01.10 glijdop/pastille

BESTELNR N° COMMANDE ORDER NR BESTELLNR	BR LRG WID BR	BLADEN LAMES LEAVES BLATT.	B	C	D1	D2	PH FL FA SP	PAK EP TH PAK	DETAIL	MOD	OPMERKINGEN REMARKS REMARKS BEMERKUNGEN
--	------------------------	-------------------------------------	---	---	----	----	----------------------	------------------------	--------	-----	--

SERIE : G**G260****achter-arrière-rear-Hinten**

	A124T230ZA75	90	9/P	825	995	32	--	64	140	9/14+P/14	A03	
A	A124T302ZA76	90	9/10	825	995	32	--	216	189	1/12+7/11+1/10+1	A03A	
H	A124T302ZA75	90	9	825	995	32	--	216	99	1/12+7/11+1/10	A03	
H	A124T302HA80	90	8/2P	695	725	--	--	147	90	8/9+2P/9	A08	
A	A124T226ZA76	90	12/11	825	995	32	--	176	252		A03A	
H	A124T226ZA75	90	12	825	995	32	--	176	142	1/16+8/12+3/10	A03	
H	A124T226HA80	90	11	710	710	--	--	75	110	11/10	A08	
A	A124T172ZA76	90	11/10	825	1000	32	--	215	200		A03A	
H	A124T172ZA75	90	11	825	1000	32	--	215	110	1/12+1/11+6/10+3	A03	
H	A124T172HA80	90	10	695	715	--	--	110	90	10/9	A08	
A	A124T174ZA76	90	11/10	825	1000	32	--	145	201		A03A	
H	A124T174ZA75	90	11	825	1000	32	--	145	111	2/12+6/10+3/9	A03	
H	A124T174HA80	90	10	695	715	--	--	70	90	10/9	A08	
A	A124T168ZA76	100	8/2P/5	825	1000	32	--	158	200		A03A	
H	A124T168ZA75	100	8	825	1000	32	--	158	112	8/14	A03	
H	A124T168HA80	100	5/2P	650	650	--	--	75	88	5/12+2P/14	A08	
A	A124T166ZA76	100	9/2P/6	825	1000	32	--	80	238	9/14+6/14+2P/14	A03A	
H	A124T166ZA75	100	9	825	1000	32	--	80	126	9/14	A03	
H	A124T166HA80	100	6/2P	650	650	--	--	47	112	6/14+2P/14	A08	
A	A124T086ZA76	100	8/P/10	825	1000	32	--	158	215		A03A	
H	A124T086ZA75	100	8	825	1000	32	--	158	105	1/14+7/13	A03	
H	A124T086HA80	100	10/P	650	650	--	--	95	110	10/10+P/10	A08	
	A124T082ZA70	100	7/P	755	755	--	--	53	175	7/23.5+P/10	A08R	
A	F023T166ZA76	90	2/P/1	825	1000	32	--	141	109	2/28+1/28+P/	F03A	
H	F023T166ZA75	90	2/P	825	1000	32	--	141	78	2/28+P/13	F03	
H	F023T166HA80	90	1	700	700	--	--	115	28	1/28	F08	
A	F023T100ZA76	90	3/1	825	1000	32	--	140	120	3/25+1/30	F03A	
H	F023T100ZA75	90	3	825	1000	32	--	140	87	3/25	F03	
H	F023T100HA80	90	1	700	700	--	--	110	33	1/30	F08	
A	F023T168ZA76	90	3/P/1	825	1000	32	--		140	3/26+1/30+P/	F03A	
H	F023T168ZA75	90	3	825	1000	32	--		90	3/26	F03	
H	F023T168HA80	90	1	650	650	--	--	126	30	1/30	F08	
A	F023T060ZA76	100	3/P/1	825	1000	32	--	155	139	3/26+1/29+P/20	F03A	
H	F023T054ZA75	100	3	825	1000	32	--	155	87	3/26	F03	
H	F023T060HA80	100	1/P	670	670	--	--	150	52	1/29+P/20	F08	
A	F023T054ZA76	100	3/P/1	825	1000	32	--	155	138	3/26+1/28+P/20	F03A	
H	F023T054ZA75	100	3	825	1000	32	--	155	87	3/26	F03	
H	F023T054HA80	100	1/P	670	670	--	--	140	51	1/28+P/20	F08	
	F023T122ZA75	100	2	860	1015	S24	--	(23)	78	1/18+1/60	F74.31	Lenker
	F023T148ZA75	100	2	520	370	S30	--	15	132	2/33	Z	Lenker

BESTELNR N° COMMANDE ORDER NR BESTELNR	BR LRG WID BR	BLADEN LAMES LEAVES BLATT.	B	C	D1	D2	PH FL FA SP	PAK EP TH PAK	DETAIL	MOD	OPMERKINGEN REMARQUES REMARKS BEMERKUNGEN
---	------------------------	-------------------------------------	---	---	----	----	----------------------	------------------------	--------	-----	--

SERIE : G

G260

Trekker - Tracteur - Tractor

voor-avant-front-Vorne

A124T287ZA75	90	9	820	820	28	28	205	92	1/12+8/10	A01	
A124T143ZA75	90	10	820	820	28	28	160	120	1/14+8/12+1/10	A01	
A124T183ZA75	90	7	870	870	28	28	172	98	7/14	A01	
F023T023ZA75	90	3/P	825	825	28	28	185	92	3/20+P/20	F01	
F023T035ZA75	90	3/W	825	825	28	28	195	93	3/20+W	F01.10	glijdop/pastille
F023T037ZA75	90	2/P/W	865	865	28	20	174	99	2/25+P/25+W	F01.10	glijdop/pastille
F023T031ZA75	90	2/P/W	870	870	28	28	170	102	2/25+P/25+W	F01.10	glijdop/pastille
F023T045ZA75	90	3/W	870	870	28	20	197	93	3/21+W	F01.10	glijdop/pastille
F023T033ZA75	90	3	870	870	28	28	195	93	3/21+W	F01.10	glijdop/pastille

achter-arrière-rear-Hinten

	A124T232ZA75	90	11	825	1000	36	--	150	154	11/14	A03	
	A124T290ZA76	90	9/P/P/7	825	1000	36	--	115	257		A03A	
A	A124T290ZA75	90	9/P	825	1000	36	--	115	161	9/14+P/35	A03	
H	A124T290HA80	90	7/P	650	650	--	--	63	96	7/12+P/12	A08	
	F023T184ZA75	80	4/P	825	1000	36	--	135	145	4/26+P/	F03	
	F023T058ZA75	90	4/P	825	1000	32	--	160	145	4/26+P/26	F03	
	F023T052ZA75	90	4/P	825	1000	36	--	155	145	4/26+P/26	F03	
	F023T182ZA75	90	4/P	825	1000	32	--	134	132	4/24+P/	F03	
	F023T050ZA75	90	5	825	1000	36	--	160	140	5/25	F03	
	F023T122ZA75	100	2	860	1015	S24	--	(23)	78	1/18+1/60	F74.31	Lenker

BESTELNR N° COMMANDE ORDER NR BESTELNR	BR LRG WID BR	BLADEN LAMES LEAVES BLATT.	B	C	D1	D2	PH FL FA SP	PAK EP TH PAK	DETAIL	MOD	OPMERKINGEN REMARQUES REMARKS BEMERKUNGEN
---	------------------------	-------------------------------------	---	---	----	----	----------------------	------------------------	--------	-----	--

SERIE : G**G270****Truck - Porteur - Rigid****voor-avant-front-Vorne**

A124T281ZA75	75	9	820	820	28	28	160	99	9/11	A01	
A124T083ZA75	90	10	820	820	28	28	190	110	10/11	A01	
A124T149ZA75	90	10	820	820	28	28	160	110	10/11	A01	
A124T269ZA75	90	10	820	820	28	20		110	10/11	A01	
A124T267ZA75	90	10	820	820	28	20	160	124	1/14+8/12+1/10	A01	
A124T151ZA75	90	10	820	820	28	28	170	110	10/11	A01	
A124T289ZA75	90	10	820	820	28	20	160	110	10/11	A01	
A124T143ZA75	90	10	820	820	28	28	160	120	1/14+8/12+1/10	A01	
A124T265ZA75	90	10	820	820	28	20	190	110	10/11	A01	
F023T107ZA75	90	2/P/P	820	820	28	28	165	96	2/24+P/12+P/30	F01	
F023T109ZA75	90	2/P	820	820	28	20		93	2/24+P/40	F01.10	
F023T053ZA75	90	3/P	820	820	28	20	165	93	3/23+P/15	F01.10	glijdop/pastille
F023T041ZA75	90	3/P	820	820	28	28	185	93	3/22+P/18	F01.10	glijdop/pastille
F023T039ZA75	90	3/P	820	820	28	28	165	93	3/23+P/15	F01.10	glijdop/pastille
F023T055ZA75	90	3/P	820	820	28	20	185	93	3/22+P/18	F01.10	glijdop/pastille

BESTELNR N° COMMANDE ORDER NR BESTELNR	BR LRG WID BR	BLADEN LAMES LEAVES BLATT.	B	C	D1	D2	PH FL FA SP	PAK EP TH PAK	DETAIL	MOD	OPMERKINGEN REMARKS BEMERKUNGEN
---	------------------------	-------------------------------------	---	---	----	----	----------------------	------------------------	--------	-----	---------------------------------------

SERIE : G

G270

achter-arrière-rear-Hinten

	A124T230ZA75	90	9/P	825	995	32	--	64	140	9/14+P/14	A03	
A	A124T302ZA76	90	9/10	825	995	32	--	216	189	1/12+7/11+1/10+1	A03A	
	A124T302ZA75	90	9	825	995	32	--	216	99	1/12+7/11+1/10	A03	
H	A124T302HA80	90	8/2P	695	725	--	--	147	90	8/9+2P/9	A08	
A	A124T172ZA76	90	11/10	825	1000	32	--	215	200		A03A	
	A124T172ZA75	90	11	825	1000	32	--	215	110	1/12+1/11+6/10+3	A03	
H	A124T172HA80	90	10	695	715	--	--	110	90	10/9	A08	
A	A124T176ZA76	100	8/2P/5	825	815	32	--	140	196		A03A	
	A124T176ZA75	100	8	825	815	32	--	140	112	8/14	A03	
H	A124T176HA80	100	5/2P	645	475	--	--	55	84	5/12+2P/12	A08	
A	A124T168ZA76	100	8/2P/5	825	1000	32	--	158	200		A03A	
	A124T168ZA75	100	8	825	1000	32	--	158	112	8/14	A03	
H	A124T168HA80	100	5/2P	650	650	--	--	75	88	5/12+2P/14	A08	
A	A124T086ZA76	100	8/P/10	825	1000	32	--	158	215		A03A	
	A124T086ZA75	100	8	825	1000	32	--	158	105	1/14+7/13	A03	
H	A124T086HA80	100	10/P	650	650	--	--	95	110	10/10+P/10	A08	
	A124T082ZA70	100	7/P	755	755	--	--	53	175	7/23.5+P/10	A08R	
A	F023T166ZA76	90	2/P/1	825	1000	32	--	141	109	2/28+1/28+P/	F03A	
	F023T166ZA75	90	2/P	825	1000	32	--	141	78	2/28+P/13	F03	
H	F023T166HA80	90	1	700	700	--	--	115	28	1/28	F08	
A	F023T100ZA76	90	3/1	825	1000	32	--	140	120	3/25+1/30	F03A	
	F023T100ZA75	90	3	825	1000	32	--	140	87	3/25	F03	
H	F023T100HA80	90	1	700	700	--	--	110	33	1/30	F08	
A	F023T060ZA76	100	3/P/1	825	1000	32	--	155	139	3/26+1/29+P/20	F03A	
	F023T054ZA75	100	3	825	1000	32	--	155	87	3/26	F03	
H	F023T060HA80	100	1/P	670	670	--	--	150	52	1/29+P/20	F08	
A	F023T054ZA76	100	3/P/1	825	1000	32	--	155	138	3/26+1/28+P/20	F03A	
	F023T054ZA75	100	3	825	1000	32	--	155	87	3/26	F03	
H	F023T054HA80	100	1/P	670	670	--	--	140	51	1/28+P/20	F08	
	F023T122ZA75	100	2	860	1015	S24	--	(23)	78	1/18+1/60	F74.31	Lenker
	F023T148ZA75	100	2	520	370	S30	--	15	132	2/33	Z	Lenker

BESTELNR N° COMMANDE ORDER NR BESTELNR	BR LRG WID BR	BLADEN LAMES LEAVES BLATT.	B	C	D1	D2	PH FL FA SP	PAK EP TH PAK	DETAIL	MOD	OPMERKINGEN REMARQUES REMARKS BEMERKUNGEN
---	------------------------	-------------------------------------	---	---	----	----	----------------------	------------------------	--------	-----	--

SERIE : G**G270****Trekker - Tracteur - Tractor****voor-avant-front-Vorne**

A124T263ZA75	90	7	820	820	28	20		98	7/14		A01
A124T183ZA75	90	7	870	870	28	28	172	98	7/14		A01
F023T053ZA75	90	3/P	820	820	28	20	165	93	3/23+P/15	F01.10	glijdop/pastille
F023T037ZA75	90	2/P/W	865	865	28	20	174	99	2/25+P/25+W	F01.10	glijdop/pastille
F023T111ZA75	90	3/W	870	870	28	20	125	93	3/21+W	F01.10	glijdop/pastille
F023T115ZA75	90	3/W	870	870	28	20				F01.10	
F023T045ZA75	90	3/W	870	870	28	20	197	93	3/21+W	F01.10	glijdop/pastille

achter-arrière-rear-Hinten

A	A124T290ZA76	90	9/P/P/7	825	1000	36	--	115	257		A03A
	A124T290ZA75	90	9/P	825	1000	36	--	115	161	9/14+P/35	A03
H	A124T290HA80	90	7/P	650	650	--	--	63	96	7/12+P/12	A08
	F023T058ZA75	90	4/P	825	1000	32	--	160	145	4/26+P/26	F03
	F023T188ZA75	90	4/P	825	1000	32	--		142	4/26+P/26	F03 glijdop/pastille
	F023T052ZA75	90	4/P	825	1000	36	--	155	145	4/26+P/26	F03
	F023T182ZA75	90	4/P	825	1000	32	--	134	132	4/24+P/	F03
	F023T026ZA75	90	4/P	825	1000	36	--	155	145	4/26+P/26	F03
	F023T050ZA75	90	5	825	1000	36	--	160	140	5/25	F03
	F023T118ZA75	90	4/P	825	1000	36	--	155	142	4/26+P/26	F03.10 glijdop/pastille
	F023T122ZA75	100	2	860	1015	S24	--	(23)	78	1/18+1/60	F74.31 Lenker

BESTELNR N° COMMANDE ORDER NR BESTELNR	BR LRG WID BR	BLADEN LAMES LEAVES BLATT.	B	C	D1	D2	PH FL FA SP	PAK EP TH PAK	DETAIL	MOD	OPMERKINGEN REMARQUES REMARKS BEMERKUNGEN
---	------------------------	-------------------------------------	---	---	----	----	----------------------	------------------------	--------	-----	--

SERIE : G

G270 6x2

Truck - Porteur - Rigid

voor-avant-front-Vorne

A124T295ZA75	90	7/P	820	820	28	20		120	8/15	A01	
A124T267ZA75	90	10	820	820	28	20	160	124	1/14+8/12+1/10	A01	
A124T143ZA75	90	10	820	820	28	28	160	120	1/14+8/12+1/10	A01	
F023T117ZA75	90	3/W	820	820	28	20				F01	
F023T053ZA75	90	3/P	820	820	28	20	165	93	3/23+P/15	F01.10	glijdop/pastille

achter-arrière-rear-Hinten

	A124T086ZA76	100	8/P/10	825	1000	32	--	158	215		A03A
A	A124T086ZA75	100	8	825	1000	32	--	158	105	1/14+7/13	A03
H	A124T086HA80	100	10/P	650	650	--	--	95	110	10/10+P/10	A08
	F023T060ZA76	100	3/P/1	825	1000	32	--	155	139	3/26+1/29+P/20	F03A
A	F023T054ZA75	100	3	825	1000	32	--	155	87	3/26	F03
H	F023T060HA80	100	1/P	670	670	--	--	150	52	1/29+P/20	F08
	F023T054ZA76	100	3/P/1	825	1000	32	--	155	138	3/26+1/28+P/20	F03A
A	F023T054ZA75	100	3	825	1000	32	--	155	87	3/26	F03
H	F023T054HA80	100	1/P	670	670	--	--	140	51	1/28+P/20	F08
	F023T122ZA75	100	2	860	1015	S24	--	(23)	78	1/18+1/60	F74.31 Lenker

G270 8x4

Truck - Porteur - Rigid

voor-avant-front-Vorne

A124T143ZA75	90	10	820	820	28	28	160	120	1/14+8/12+1/10	A01	
F023T069ZA75	90	3/P	820	820	28	20	165	120	3/23+P/39	F01.10	

BESTELNR N° COMMANDE ORDER NR BESTELNR	BR LRG WID BR	BLADEN LAMES LEAVES BLATT.	B	C	D1	D2	PH FL FA SP	PAK EP TH PAK	DETAIL	MOD	OPMERKINGEN REMARQUES REMARKS BEMERKUNGEN
---	------------------------	-------------------------------------	---	---	----	----	----------------------	------------------------	--------	-----	--

SERIE : G**G280****Truck - Porteur - Rigid****voor-avant-front-Vorne**

A124T269ZA75	90	10	820	820	28	20		110	10/11		A01
A124T083ZA75	90	10	820	820	28	28	190	110	10/11		A01
A124T265ZA75	90	10	820	820	28	20	190	110	10/11		A01
A124T151ZA75	90	10	820	820	28	28	170	110	10/11		A01
A124T267ZA75	90	10	820	820	28	20	160	124	1/14+8/12+1/10		A01
A124T143ZA75	90	10	820	820	28	28	160	120	1/14+8/12+1/10		A01
F023T107ZA75	90	2/P/P	820	820	28	28	165	96	2/24+P/12+P/30		F01
F023T109ZA75	90	2/P	820	820	28	20		93	2/24+P/40		F01.10
F023T055ZA75	90	3/P	820	820	28	20	185	93	3/22+P/18		F01.10 glijdop/pastille
F023T053ZA75	90	3/P	820	820	28	20	165	93	3/23+P/15		F01.10 glijdop/pastille
F023T041ZA75	90	3/P	820	820	28	28	185	93	3/22+P/18		F01.10 glijdop/pastille
F023T039ZA75	90	3/P	820	820	28	28	165	93	3/23+P/15		F01.10 glijdop/pastille

BESTELNR N° COMMANDE ORDER NR BESTELNR	BR LRG WID BR	BLADEN LAMES LEAVES BLATT.	B	C	D1	D2	PH FL FA SP	PAK EP TH PAK	DETAIL	MOD	OPMERKINGEN REMARKS REMARKS BEMERKUNGEN
---	------------------------	-------------------------------------	---	---	----	----	----------------------	------------------------	--------	-----	--

SERIE : G

G280

achter-arrière-rear-Hinten

	A124T302ZA76	90	9/10	825	995	32	--	216	189	1/12+7/11+1/10+1	A03A	
A	A124T302ZA75	90	9	825	995	32	--	216	99	1/12+7/11+1/10	A03	
H	A124T302HA80	90	8/2P	695	725	--	--	147	90	8/9+2P/9	A08	
	A124T172ZA76	90	11/10	825	1000	32	--	215	200		A03A	
A	A124T172ZA75	90	11	825	1000	32	--	215	110	1/12+1/11+6/10+3	A03	
H	A124T172HA80	90	10	695	715	--	--	110	90	10/9	A08	
	A124T168ZA76	100	8/2P/5	825	1000	32	--	158	200		A03A	
A	A124T168ZA75	100	8	825	1000	32	--	158	112	8/14	A03	
H	A124T168HA80	100	5/2P	650	650	--	--	75	88	5/12+2P/14	A08	
	A124T086ZA76	100	8/P/10	825	1000	32	--	158	215		A03A	
A	A124T086ZA75	100	8	825	1000	32	--	158	105	1/14+7/13	A03	
H	A124T086HA80	100	10/P	650	650	--	--	95	110	10/10+P/10	A08	
	A124T082ZA70	100	7/P	755	755	--	--	53	175	7/23.5+P/10	A08R	
	F023T166ZA76	90	2/P/1	825	1000	32	--	141	109	2/28+1/28+P/	F03A	
A	F023T166ZA75	90	2/P	825	1000	32	--	141	78	2/28+P/13	F03	
H	F023T166HA80	90	1	700	700	--	--	115	28	1/28	F08	
	F023T100ZA76	90	3/1	825	1000	32	--	140	120	3/25+1/30	F03A	
A	F023T100ZA75	90	3	825	1000	32	--	140	87	3/25	F03	
H	F023T100HA80	90	1	700	700	--	--	110	33	1/30	F08	
	F023T060ZA76	100	3/P/1	825	1000	32	--	155	139	3/26+1/29+P/20	F03A	
A	F023T054ZA75	100	3	825	1000	32	--	155	87	3/26	F03	
H	F023T060HA80	100	1/P	670	670	--	--	150	52	1/29+P/20	F08	
	F023T054ZA76	100	3/P/1	825	1000	32	--	155	138	3/26+1/28+P/20	F03A	
A	F023T054ZA75	100	3	825	1000	32	--	155	87	3/26	F03	
H	F023T054HA80	100	1/P	670	670	--	--	140	51	1/28+P/20	F08	
	F023T122ZA75	100	2	860	1015	S24	--	(23)	78	1/18+1/60	F74.31	Lenker
	F023T148ZA75	100	2	520	370	S30	--	15	132	2/33	Z	Lenker

BESTELNR N° COMMANDE ORDER NR BESTELNR	BR LRG WID BR	BLADEN LAMES LEAVES BLATT.	B	C	D1	D2	PH FL FA SP	PAK EP TH PAK	DETAIL	MOD	OPMERKINGEN REMARQUES REMARKS BEMERKUNGEN
---	------------------------	-------------------------------------	---	---	----	----	----------------------	------------------------	--------	-----	--

SERIE : G**G280****Trekker - Tracteur - Tractor****voor-avant-front-Vorne**

A124T263ZA75	90	7	820	820	28	20		98	7/14	A01	
A124T183ZA75	90	7	870	870	28	28	172	98	7/14	A01	
F023T053ZA75	90	3/P	820	820	28	20	165	93	3/23+P/15	F01.10	glijdop/pastille
F023T037ZA75	90	2/P/W	865	865	28	20	174	99	2/25+P/25+W	F01.10	glijdop/pastille
F023T115ZA75	90	3/W	870	870	28	20				F01.10	
F023T111ZA75	90	3/W	870	870	28	20	125	93	3/21+W	F01.10	glijdop/pastille
F023T045ZA75	90	3/W	870	870	28	20	197	93	3/21+W	F01.10	glijdop/pastille

achter-arrière-rear-Hinten

A	A124T290ZA76	90	9/P/P/7	825	1000	36	--	115	257		A03A
	A124T290ZA75	90	9/P	825	1000	36	--	115	161	9/14+P/35	A03
H	A124T290HA80	90	7/P	650	650	--	--	63	96	7/12+P/12	A08
	F023T052ZA75	90	4/P	825	1000	36	--	155	145	4/26+P/26	F03
	F023T026ZA75	90	4/P	825	1000	36	--	155	145	4/26+P/26	F03
	F023T188ZA75	90	4/P	825	1000	32	--		142	4/26+P/26	F03 glijdop/pastille
	F023T182ZA75	90	4/P	825	1000	32	--	134	132	4/24+P/	F03
	F023T058ZA75	90	4/P	825	1000	32	--	160	145	4/26+P/26	F03
	F023T050ZA75	90	5	825	1000	36	--	160	140	5/25	F03
	F023T118ZA75	90	4/P	825	1000	36	--	155	142	4/26+P/26	F03.10 glijdop/pastille
	F023T122ZA75	100	2	860	1015	S24	--	(23)	78	1/18+1/60	F74.31 Lenker

BESTELNR N° COMMANDE ORDER NR BESTELNR	BR LRG WID BR	BLADEN LAMES LEAVES BLATT.	B	C	D1	D2	PH FL FA SP	PAK EP TH PAK	DETAIL	MOD	OPMERKINGEN REMARQUES REMARKS BEMERKUNGEN
---	------------------------	-------------------------------------	---	---	----	----	----------------------	------------------------	--------	-----	--

SERIE : G**G280 6x2****Truck - Porteur - Rigid****voor-avant-front-Vorne**

A124T295ZA75	90	7/P	820	820	28	20		120	8/15	A01	
A124T143ZA75	90	10	820	820	28	28	160	120	1/14+8/12+1/10	A01	
A124T267ZA75	90	10	820	820	28	20	160	124	1/14+8/12+1/10	A01	
F023T117ZA75	90	3/W	820	820	28	20				F01	
F023T053ZA75	90	3/P	820	820	28	20	165	93	3/23+P/15	F01.10	glijdop/pastille

achter-arrière-rear-Hinten

	A124T086ZA76	100	8/P/10	825	1000	32	--	158	215		A03A
A	A124T086ZA75	100	8	825	1000	32	--	158	105	1/14+7/13	A03
H	A124T086HA80	100	10/P	650	650	--	--	95	110	10/10+P/10	A08
	F023T054ZA76	100	3/P/1	825	1000	32	--	155	138	3/26+1/28+P/20	F03A
A	F023T054ZA75	100	3	825	1000	32	--	155	87	3/26	F03
H	F023T054HA80	100	1/P	670	670	--	--	140	51	1/28+P/20	F08
	F023T060ZA76	100	3/P/1	825	1000	32	--	155	139	3/26+1/29+P/20	F03A
A	F023T054ZA75	100	3	825	1000	32	--	155	87	3/26	F03
H	F023T060HA80	100	1/P	670	670	--	--	150	52	1/29+P/20	F08
	F023T122ZA75	100	2	860	1015	S24	--	(23)	78	1/18+1/60	F74.31 Lenker

G280 8x4**Truck - Porteur - Rigid****voor-avant-front-Vorne**

A124T143ZA75	90	10	820	820	28	28	160	120	1/14+8/12+1/10	A01	
F023T069ZA75	90	3/P	820	820	28	20	165	120	3/23+P/39	F01.10	

BESTELNR N° COMMANDE ORDER NR BESTELLNR	BR LRG WID BR	BLADEN LAMES LEAVES BLATT.	B	C	D1	D2	PH FL FA SP	PAK EP TH PAK	DETAIL	MOD	OPMERKINGEN REMARQUES REMARKS BEMERKUNGEN
--	------------------------	-------------------------------------	---	---	----	----	----------------------	------------------------	--------	-----	--

SERIE : G

G290

Truck - Porteur - Rigid

voor-avant-front-Vorne

A124T083ZA75	90	10	820	820	28	28	190	110	10/11	A01	
A124T143ZA75	90	10	820	820	28	28	160	120	1/14+8/12+1/10	A01	
A124T149ZA75	90	10	820	820	28	28	160	110	10/11	A01	
A124T151ZA75	90	10	820	820	28	28	170	110	10/11	A01	
F023T107ZA75	90	2/P/P	820	820	28	28	165	96	2/24+P/12+P/30	F01	
F023T039ZA75	90	3/P	820	820	28	28	165	93	3/23+P/15	F01.10	glijdop/pastille
F023T041ZA75	90	3/P	820	820	28	28	185	93	3/22+P/18	F01.10	glijdop/pastille

BESTELNR N° COMMANDE ORDER NR BESTELNR	BR LRG WID BR	BLADEN LAMES LEAVES BLATT.	B	C	D1	D2	PH FL FA SP	PAK EP TH PAK	DETAIL	MOD	OPMERKINGEN REMARKS BEMERKUNGEN
---	------------------------	-------------------------------------	---	---	----	----	----------------------	------------------------	--------	-----	---------------------------------------

SERIE : G

G290

achter-arrière-rear-Hinten

	A124T226ZA76	90	12/11	825	995	32	--	176	252		A03A	
A	A124T226ZA75	90	12	825	995	32	--	176	142	1/16+8/12+3/10	A03	
H	A124T226HA80	90	11	710	710	--	--	75	110	11/10	A08	
	A124T174ZA76	90	11/10	825	1000	32	--	145	201		A03A	
A	A124T174ZA75	90	11	825	1000	32	--	145	111	2/12+6/10+3/9	A03	
H	A124T174HA80	90	10	695	715	--	--	70	90	10/9	A08	
	A124T172ZA76	90	11/10	825	1000	32	--	215	200		A03A	
A	A124T172ZA75	90	11	825	1000	32	--	215	110	1/12+1/11+6/10+3	A03	
H	A124T172HA80	90	10	695	715	--	--	110	90	10/9	A08	
	A124T168ZA76	100	8/2P/5	825	1000	32	--	158	200		A03A	
A	A124T168ZA75	100	8	825	1000	32	--	158	112	8/14	A03	
H	A124T168HA80	100	5/2P	650	650	--	--	75	88	5/12+2P/14	A08	
	A124T166ZA76	100	9/2P/6	825	1000	32	--	80	238	9/14+6/14+2P/14	A03A	
A	A124T166ZA75	100	9	825	1000	32	--	80	126	9/14	A03	
H	A124T166HA80	100	6/2P	650	650	--	--	47	112	6/14+2P/14	A08	
	A124T086ZA76	100	8/P/10	825	1000	32	--	158	215		A03A	
A	A124T086ZA75	100	8	825	1000	32	--	158	105	1/14+7/13	A03	
H	A124T086HA80	100	10/P	650	650	--	--	95	110	10/10+P/10	A08	
	A124T082ZA70	100	7/P	755	755	--	--	53	175	7/23.5+P/10	A08R	
	F023T100ZA76	90	3/1	825	1000	32	--	140	120	3/25+1/30	F03A	
A	F023T100ZA75	90	3	825	1000	32	--	140	87	3/25	F03	
H	F023T100HA80	90	1	700	700	--	--	110	33	1/30	F08	
	F023T168ZA76	90	3/P/1	825	1000	32	--		140	3/26+1/30+P/	F03A	
A	F023T168ZA75	90	3	825	1000	32	--		90	3/26	F03	
H	F023T168HA80	90	1	650	650	--	--	126	30	1/30	F08	
	F023T060ZA76	100	3/P/1	825	1000	32	--	155	139	3/26+1/29+P/20	F03A	
A	F023T054ZA75	100	3	825	1000	32	--	155	87	3/26	F03	
H	F023T060HA80	100	1/P	670	670	--	--	150	52	1/29+P/20	F08	
	F023T054ZA76	100	3/P/1	825	1000	32	--	155	138	3/26+1/28+P/20	F03A	
A	F023T054ZA75	100	3	825	1000	32	--	155	87	3/26	F03	
H	F023T054HA80	100	1/P	670	670	--	--	140	51	1/28+P/20	F08	
	F023T122ZA75	100	2	860	1015	S24	--	(23)	78	1/18+1/60	F74.31	Lenker
	F023T148ZA75	100	2	520	370	S30	--	15	132	2/33	Z	Lenker

BESTELNR N° COMMANDE ORDER NR BESTELNR	BR LRG WID BR	BLADEN LAMES LEAVES BLATT.	B	C	D1	D2	PH FL FA SP	PAK EP TH PAK	DETAIL	MOD	OPMERKINGEN REMARQUES REMARKS BEMERKUNGEN
---	------------------------	-------------------------------------	---	---	----	----	----------------------	------------------------	--------	-----	--

SERIE : G

G290

Trekker - Tracteur - Tractor

voor-avant-front-Vorne

A124T287ZA75	90	9	820	820	28	28	205	92	1/12+8/10	A01	
A124T143ZA75	90	10	820	820	28	28	160	120	1/14+8/12+1/10	A01	
A124T183ZA75	90	7	870	870	28	28	172	98	7/14	A01	
F023T023ZA75	90	3/P	825	825	28	28	185	92	3/20+P/20	F01	
F023T035ZA75	90	3/W	825	825	28	28	195	93	3/20+W	F01.10	glijdop/pastille
F023T037ZA75	90	2/P/W	865	865	28	20	174	99	2/25+P/25+W	F01.10	glijdop/pastille
F023T031ZA75	90	2/P/W	870	870	28	28	170	102	2/25+P/25+W	F01.10	glijdop/pastille
F023T045ZA75	90	3/W	870	870	28	20	197	93	3/21+W	F01.10	glijdop/pastille
F023T033ZA75	90	3	870	870	28	28	195	93	3/21+W	F01.10	glijdop/pastille

achter-arrière-rear-Hinten

	A124T232ZA75	90	11	825	1000	36	--	150	154	11/14	A03	
	A124T290ZA76	90	9/P/P/7	825	1000	36	--	115	257		A03A	
A	A124T290ZA75	90	9/P	825	1000	36	--	115	161	9/14+P/35	A03	
H	A124T290HA80	90	7/P	650	650	--	--	63	96	7/12+P/12	A08	
	F023T184ZA75	80	4/P	825	1000	36	--	135	145	4/26+P/	F03	
	F023T052ZA75	90	4/P	825	1000	36	--	155	145	4/26+P/26	F03	
	F023T058ZA75	90	4/P	825	1000	32	--	160	145	4/26+P/26	F03	
	F023T050ZA75	90	5	825	1000	36	--	160	140	5/25	F03	
	F023T122ZA75	100	2	860	1015	S24	--	(23)	78	1/18+1/60	F74.31	Lenker

BESTELNR N° COMMANDE ORDER NR BESTELNR	BR LRG WID BR	BLADEN LAMES LEAVES BLATT.	B	C	D1	D2	PH FL FA SP	PAK EP TH PAK	DETAIL	MOD	OPMERKINGEN REMARQUES REMARKS BEMERKUNGEN
---	------------------------	-------------------------------------	---	---	----	----	----------------------	------------------------	--------	-----	--

SERIE : G**G300****Truck - Porteur - Rigid****voor-avant-front-Vorne**

A124T083ZA75	90	10	820	820	28	28	190	110	10/11	A01	
A124T143ZA75	90	10	820	820	28	28	160	120	1/14+8/12+1/10	A01	
A124T151ZA75	90	10	820	820	28	28	170	110	10/11	A01	
A124T269ZA75	90	10	820	820	28	20		110	10/11	A01	
A124T267ZA75	90	10	820	820	28	20	160	124	1/14+8/12+1/10	A01	
A124T265ZA75	90	10	820	820	28	20	190	110	10/11	A01	
F023T107ZA75	90	2/P/P	820	820	28	28	165	96	2/24+P/12+P/30	F01	
F023T109ZA75	90	2/P	820	820	28	20		93	2/24+P/40	F01.10	
F023T039ZA75	90	3/P	820	820	28	28	165	93	3/23+P/15	F01.10	glijdop/pastille
F023T053ZA75	90	3/P	820	820	28	20	165	93	3/23+P/15	F01.10	glijdop/pastille
F023T041ZA75	90	3/P	820	820	28	28	185	93	3/22+P/18	F01.10	glijdop/pastille
F023T055ZA75	90	3/P	820	820	28	20	185	93	3/22+P/18	F01.10	glijdop/pastille

BESTELNR N° COMMANDE ORDER NR BESTELNR	BR LRG WID BR	BLADEN LAMES LEAVES BLATT.	B	C	D1	D2	PH FL FA SP	PAK EP TH PAK	DETAIL	MOD	OPMERKINGEN REMARKS REMARKS BEMERKUNGEN
---	------------------------	-------------------------------------	---	---	----	----	----------------------	------------------------	--------	-----	--

SERIE : G

G300

achter-arrière-rear-Hinten

	A124T302ZA76	90	9/10	825	995	32	--	216	189	1/12+7/11+1/10+1	A03A	
A	A124T302ZA75	90	9	825	995	32	--	216	99	1/12+7/11+1/10	A03	
H	A124T302HA80	90	8/2P	695	725	--	--	147	90	8/9+2P/9	A08	
	A124T172ZA76	90	11/10	825	1000	32	--	215	200		A03A	
A	A124T172ZA75	90	11	825	1000	32	--	215	110	1/12+1/11+6/10+3	A03	
H	A124T172HA80	90	10	695	715	--	--	110	90	10/9	A08	
	A124T168ZA76	100	8/2P/5	825	1000	32	--	158	200		A03A	
A	A124T168ZA75	100	8	825	1000	32	--	158	112	8/14	A03	
H	A124T168HA80	100	5/2P	650	650	--	--	75	88	5/12+2P/14	A08	
	A124T086ZA76	100	8/P/10	825	1000	32	--	158	215		A03A	
A	A124T086ZA75	100	8	825	1000	32	--	158	105	1/14+7/13	A03	
H	A124T086HA80	100	10/P	650	650	--	--	95	110	10/10+P/10	A08	
	A124T082ZA70	100	7/P	755	755	--	--	53	175	7/23.5+P/10	A08R	
	F023T166ZA76	90	2/P/1	825	1000	32	--	141	109	2/28+1/28+P/	F03A	
A	F023T166ZA75	90	2/P	825	1000	32	--	141	78	2/28+P/13	F03	
H	F023T166HA80	90	1	700	700	--	--	115	28	1/28	F08	
	F023T100ZA76	90	3/1	825	1000	32	--	140	120	3/25+1/30	F03A	
A	F023T100ZA75	90	3	825	1000	32	--	140	87	3/25	F03	
H	F023T100HA80	90	1	700	700	--	--	110	33	1/30	F08	
	F023T060ZA76	100	3/P/1	825	1000	32	--	155	139	3/26+1/29+P/20	F03A	
A	F023T054ZA75	100	3	825	1000	32	--	155	87	3/26	F03	
H	F023T060HA80	100	1/P	670	670	--	--	150	52	1/29+P/20	F08	
	F023T054ZA76	100	3/P/1	825	1000	32	--	155	138	3/26+1/28+P/20	F03A	
A	F023T054ZA75	100	3	825	1000	32	--	155	87	3/26	F03	
H	F023T054HA80	100	1/P	670	670	--	--	140	51	1/28+P/20	F08	
	F023T122ZA75	100	2	860	1015	S24	--	(23)	78	1/18+1/60	F74.31	Lenker
	F023T148ZA75	100	2	520	370	S30	--	15	132	2/33	Z	Lenker

BESTELNR N° COMMANDE ORDER NR BESTELNR	BR LRG WID BR	BLADEN LAMES LEAVES BLATT.	B	C	D1	D2	PH FL FA SP	PAK EP TH PAK	DETAIL	MOD	OPMERKINGEN REMARQUES REMARKS BEMERKUNGEN
---	------------------------	-------------------------------------	---	---	----	----	----------------------	------------------------	--------	-----	--

SERIE : G

G300

Trekker - Tracteur - Tractor

voor-avant-front-Vorne

A124T263ZA75	90	7	820	820	28	20		98	7/14	A01	
A124T183ZA75	90	7	870	870	28	28	172	98	7/14	A01	
F023T053ZA75	90	3/P	820	820	28	20	165	93	3/23+P/15	F01.10	glijdop/pastille
F023T037ZA75	90	2/P/W	865	865	28	20	174	99	2/25+P/25+W	F01.10	glijdop/pastille
F023T045ZA75	90	3/W	870	870	28	20	197	93	3/21+W	F01.10	glijdop/pastille
F023T115ZA75	90	3/W	870	870	28	20				F01.10	
F023T111ZA75	90	3/W	870	870	28	20	125	93	3/21+W	F01.10	glijdop/pastille

achter-arrière-rear-Hinten

A	A124T290ZA76	90	9/P/P/7	825	1000	36	--	115	257		A03A
	A124T290ZA75	90	9/P	825	1000	36	--	115	161	9/14+P/35	A03
H	A124T290HA80	90	7/P	650	650	--	--	63	96	7/12+P/12	A08
	F023T052ZA75	90	4/P	825	1000	36	--	155	145	4/26+P/26	F03
	F023T188ZA75	90	4/P	825	1000	32	--		142	4/26+P/26	F03 glijdop/pastille
	F023T182ZA75	90	4/P	825	1000	32	--	134	132	4/24+P/	F03
	F023T058ZA75	90	4/P	825	1000	32	--	160	145	4/26+P/26	F03
	F023T026ZA75	90	4/P	825	1000	36	--	155	145	4/26+P/26	F03
	F023T050ZA75	90	5	825	1000	36	--	160	140	5/25	F03
	F023T118ZA75	90	4/P	825	1000	36	--	155	142	4/26+P/26	F03.10 glijdop/pastille
	F023T122ZA75	100	2	860	1015	S24	--	(23)	78	1/18+1/60	F74.31 Lenker

BESTELNR N° COMMANDE ORDER NR BESTELNR	BR LRG WID BR	BLADEN LAMES LEAVES BLATT.	B	C	D1	D2	PH FL FA SP	PAK EP TH PAK	DETAIL	MOD	OPMERKINGEN REMARQUES REMARKS BEMERKUNGEN
---	------------------------	-------------------------------------	---	---	----	----	----------------------	------------------------	--------	-----	--

SERIE : G

G300 6x2

Truck - Porteur - Rigid

voor-avant-front-Vorne

A124T295ZA75	90	7/P	820	820	28	20		120	8/15	A01	
A124T143ZA75	90	10	820	820	28	28	160	120	1/14+8/12+1/10	A01	
A124T267ZA75	90	10	820	820	28	20	160	124	1/14+8/12+1/10	A01	
F023T117ZA75	90	3/W	820	820	28	20				F01	
F023T053ZA75	90	3/P	820	820	28	20	165	93	3/23+P/15	F01.10	glijdop/pastille

achter-arrière-rear-Hinten

A124T086ZA76	100	8/P/10	825	1000	32	--	158	215		A03A	
A124T086ZA75	100	8	825	1000	32	--	158	105	1/14+7/13	A03	
A124T086HA80	100	10/P	650	650	--	--	95	110	10/10+P/10	A08	
F023T060ZA76	100	3/P/1	825	1000	32	--	155	139	3/26+1/29+P/20	F03A	
F023T054ZA75	100	3	825	1000	32	--	155	87	3/26	F03	
F023T060HA80	100	1/P	670	670	--	--	150	52	1/29+P/20	F08	
F023T054ZA76	100	3/P/1	825	1000	32	--	155	138	3/26+1/28+P/20	F03A	
F023T054ZA75	100	3	825	1000	32	--	155	87	3/26	F03	
F023T054HA80	100	1/P	670	670	--	--	140	51	1/28+P/20	F08	
F023T122ZA75	100	2	860	1015	S24	--	(23)	78	1/18+1/60	F74.31	Lenker

G300 6x4

Truck - Porteur - Rigid

voor-avant-front-Vorne

A124T277ZA75	90	8	820	820	28	20		120	8/15	A01	
A124T279ZA75	90	8	820	820	28	20		120	8/15	A01	
F023T065ZA75	90	3	820	820	28	20	130	84	3/25	F01.10	

achter-arrière-rear-Hinten

A124T082ZA70	100	7/P	755	755	--	--	53	175	7/23.5+P/10	A08R	
A124T292ZA70	100	9/P	790	790	--	--	64	235	9/25+P/10	A08R	
F023T094ZA70	100	3	785	785	--	--	60	136	3/38	F08R	

BESTELNR N° COMMANDE ORDER NR BESTELLNR	BR LRG WID BR	BLADEN LAMES LEAVES BLATT.	B	C	D1	D2	PH FL FA SP	PAK EP TH PAK	DETAIL	MOD	OPMERKINGEN REMARQUES REMARKS BEMERKUNGEN
--	------------------------	-------------------------------------	---	---	----	----	----------------------	------------------------	--------	-----	--

SERIE : G**G300 8x4****Truck - Porteur - Rigid****voor-avant-front-Vorne**

A124T277ZA75	90	8	820	820	28	20		120	8/15	A01
A124T143ZA75	90	10	820	820	28	28	160	120	1/14+8/12+1/10	A01
F023T065ZA75	90	3	820	820	28	20	130	84	3/25	F01.10
F023T069ZA75	90	3/P	820	820	28	20	165	120	3/23+P/39	F01.10

achter-arrière-rear-Hinten

A124T082ZA70	100	7/P	755	755	--	--	53	175	7/23.5+P/10	A08R
A124T292ZA70	100	9/P	790	790	--	--	64	235	9/25+P/10	A08R
A124T300ZA70	100	11/P	880	880	--	--		285	11/25+P/10	A08R
F023T094ZA70	100	3	785	785	--	--	60	136	3/38	F08R

BESTELNR N° COMMANDE ORDER NR BESTELNR	BR LRG WID BR	BLADEN LAMES LEAVES BLATT.	B	C	D1	D2	PH FL FA SP	PAK EP TH PAK	DETAIL	MOD	OPMERKINGEN REMARQUES REMARKS BEMERKUNGEN
---	------------------------	-------------------------------------	---	---	----	----	----------------------	------------------------	--------	-----	--

SERIE : G**G320****Truck - Porteur - Rigid****voor-avant-front-Vorne**

A124T083ZA75	90	10	820	820	28	28	190	110	10/11	A01	
A124T143ZA75	90	10	820	820	28	28	160	120	1/14+8/12+1/10	A01	
F023T039ZA75	90	3/P	820	820	28	28	165	93	3/23+P/15	F01.10	glijdop/pastille
F023T041ZA75	90	3/P	820	820	28	28	185	93	3/22+P/18	F01.10	glijdop/pastille

achter-arrière-rear-Hinten

A	A124T168ZA76	100	8/P/5	825	1000	32	--	158	200		A03A
	A124T168ZA75	100	8	825	1000	32	--	158	112	8/14	A03
H	A124T168HA80	100	5/2P	650	650	--	--	75	88	5/12+2P/14	A08
A	A124T086ZA76	100	8/P/10	825	1000	32	--	158	215		A03A
	A124T086ZA75	100	8	825	1000	32	--	158	105	1/14+7/13	A03
H	A124T086HA80	100	10/P	650	650	--	--	95	110	10/10+P/10	A08
A	F023T054ZA76	100	3/P/1	825	1000	32	--	155	138	3/26+1/28+P/20	F03A
	F023T054ZA75	100	3	825	1000	32	--	155	87	3/26	F03
H	F023T054HA80	100	1/P	670	670	--	--	140	51	1/28+P/20	F08
A	F023T060ZA76	100	3/P/1	825	1000	32	--	155	139	3/26+1/29+P/20	F03A
	F023T054ZA75	100	3	825	1000	32	--	155	87	3/26	F03
H	F023T060HA80	100	1/P	670	670	--	--	150	52	1/29+P/20	F08
	F023T122ZA75	100	2	860	1015	S24	--	(23)	78	1/18+1/60	F74.31 Lenker

Trekker - Tracteur - Tractor**voor-avant-front-Vorne**

A124T183ZA75	90	7	870	870	28	28	172	98	7/14	A01	
F023T037ZA75	90	2/P/W	865	865	28	20	174	99	2/25+P/25+W	F01.10	glijdop/pastille
F023T045ZA75	90	3/W	870	870	28	20	197	93	3/21+W	F01.10	glijdop/pastille

achter-arrière-rear-Hinten

A	A124T290ZA76	90	9/P/P/7	825	1000	36	--	115	257		A03A
	A124T290ZA75	90	9/P	825	1000	36	--	115	161	9/14+P/35	A03
H	A124T290HA80	90	7/P	650	650	--	--	63	96	7/12+P/12	A08
	F023T052ZA75	90	4/P	825	1000	36	--	155	145	4/26+P/26	F03
	F023T122ZA75	100	2	860	1015	S24	--	(23)	78	1/18+1/60	F74.31 Lenker

BESTELNR N° COMMANDE ORDER NR BESTELLNR	BR LRG WID BR	BLADEN LAMES LEAVES BLATT.	B	C	D1	D2	PH FL FA SP	PAK EP TH PAK	DETAIL	MOD	OPMERKINGEN REMARQUES REMARKS BEMERKUNGEN
--	------------------------	-------------------------------------	---	---	----	----	----------------------	------------------------	--------	-----	--

SERIE : G

G330

Truck - Porteur - Rigid

voor-avant-front-Vorne

A124T143ZA75	90	10	820	820	28	28	160	120	1/14+8/12+1/10	A01	
A124T151ZA75	90	10	820	820	28	28	170	110	10/11	A01	
A124T265ZA75	90	10	820	820	28	20	190	110	10/11	A01	
A124T083ZA75	90	10	820	820	28	28	190	110	10/11	A01	
A124T267ZA75	90	10	820	820	28	20	160	124	1/14+8/12+1/10	A01	
A124T269ZA75	90	10	820	820	28	20		110	10/11	A01	
F023T107ZA75	90	2/P/P	820	820	28	28	165	96	2/24+P/12+P/30	F01	
F023T109ZA75	90	2/P	820	820	28	20		93	2/24+P/40	F01.10	
F023T041ZA75	90	3/P	820	820	28	28	185	93	3/22+P/18	F01.10	glijdop/pastille
F023T039ZA75	90	3/P	820	820	28	28	165	93	3/23+P/15	F01.10	glijdop/pastille
F023T055ZA75	90	3/P	820	820	28	20	185	93	3/22+P/18	F01.10	glijdop/pastille
F023T053ZA75	90	3/P	820	820	28	20	165	93	3/23+P/15	F01.10	glijdop/pastille

BESTELNR N° COMMANDE ORDER NR BESTELNR	BR LRG WID BR	BLADEN LAMES LEAVES BLATT.	B	C	D1	D2	PH FL FA SP	PAK EP TH PAK	DETAIL	MOD	OPMERKINGEN REMARKS REMARKS BEMERKUNGEN
---	------------------------	-------------------------------------	---	---	----	----	----------------------	------------------------	--------	-----	--

SERIE : G

G330

achter-arrière-rear-Hinten

	A124T302ZA76	90	9/10	825	995	32	--	216	189	1/12+7/11+1/10+1	A03A	
A	A124T302ZA75	90	9	825	995	32	--	216	99	1/12+7/11+1/10	A03	
H	A124T302HA80	90	8/2P	695	725	--	--	147	90	8/9+2P/9	A08	
	A124T172ZA76	90	11/10	825	1000	32	--	215	200		A03A	
A	A124T172ZA75	90	11	825	1000	32	--	215	110	1/12+1/11+6/10+3	A03	
H	A124T172HA80	90	10	695	715	--	--	110	90	10/9	A08	
	A124T168ZA76	100	8/2P/5	825	1000	32	--	158	200		A03A	
A	A124T168ZA75	100	8	825	1000	32	--	158	112	8/14	A03	
H	A124T168HA80	100	5/2P	650	650	--	--	75	88	5/12+2P/14	A08	
	A124T086ZA76	100	8/P/10	825	1000	32	--	158	215		A03A	
A	A124T086ZA75	100	8	825	1000	32	--	158	105	1/14+7/13	A03	
H	A124T086HA80	100	10/P	650	650	--	--	95	110	10/10+P/10	A08	
	A124T082ZA70	100	7/P	755	755	--	--	53	175	7/23.5+P/10	A08R	
	F023T166ZA76	90	2/P/1	825	1000	32	--	141	109	2/28+1/28+P/	F03A	
A	F023T166ZA75	90	2/P	825	1000	32	--	141	78	2/28+P/13	F03	
H	F023T166HA80	90	1	700	700	--	--	115	28	1/28	F08	
	F023T100ZA76	90	3/1	825	1000	32	--	140	120	3/25+1/30	F03A	
A	F023T100ZA75	90	3	825	1000	32	--	140	87	3/25	F03	
H	F023T100HA80	90	1	700	700	--	--	110	33	1/30	F08	
	F023T054ZA76	100	3/P/1	825	1000	32	--	155	138	3/26+1/28+P/20	F03A	
A	F023T054ZA75	100	3	825	1000	32	--	155	87	3/26	F03	
H	F023T054HA80	100	1/P	670	670	--	--	140	51	1/28+P/20	F08	
	F023T060ZA76	100	3/P/1	825	1000	32	--	155	139	3/26+1/29+P/20	F03A	
A	F023T054ZA75	100	3	825	1000	32	--	155	87	3/26	F03	
H	F023T060HA80	100	1/P	670	670	--	--	150	52	1/29+P/20	F08	
	F023T122ZA75	100	2	860	1015	S24	--	(23)	78	1/18+1/60	F74.31	Lenker
	F023T148ZA75	100	2	520	370	S30	--	15	132	2/33	Z	Lenker

BESTELNR N° COMMANDE ORDER NR BESTELNR	BR LRG WID BR	BLADEN LAMES LEAVES BLATT.	B	C	D1	D2	PH FL FA SP	PAK EP TH PAK	DETAIL	MOD	OPMERKINGEN REMARQUES REMARKS BEMERKUNGEN
---	------------------------	-------------------------------------	---	---	----	----	----------------------	------------------------	--------	-----	--

SERIE : G

G330

Trekker - Tracteur - Tractor

voor-avant-front-Vorne

A124T263ZA75	90	7	820	820	28	20		98	7/14	A01	
A124T183ZA75	90	7	870	870	28	28	172	98	7/14	A01	
F023T053ZA75	90	3/P	820	820	28	20	165	93	3/23+P/15	F01.10	glijdop/pastille
F023T037ZA75	90	2/P/W	865	865	28	20	174	99	2/25+P/25+W	F01.10	glijdop/pastille
F023T045ZA75	90	3/W	870	870	28	20	197	93	3/21+W	F01.10	glijdop/pastille
F023T111ZA75	90	3/W	870	870	28	20	125	93	3/21+W	F01.10	glijdop/pastille
F023T115ZA75	90	3/W	870	870	28	20				F01.10	

achter-arrière-rear-Hinten

A	A124T290ZA76	90	9/P/P/7	825	1000	36	--	115	257		A03A
	A124T290ZA75	90	9/P	825	1000	36	--	115	161	9/14+P/35	A03
H	A124T290HA80	90	7/P	650	650	--	--	63	96	7/12+P/12	A08
	F023T188ZA75	90	4/P	825	1000	32	--		142	4/26+P/26	F03 glijdop/pastille
	F023T182ZA75	90	4/P	825	1000	32	--	134	132	4/24+P/	F03
	F023T052ZA75	90	4/P	825	1000	36	--	155	145	4/26+P/26	F03
	F023T026ZA75	90	4/P	825	1000	36	--	155	145	4/26+P/26	F03
	F023T058ZA75	90	4/P	825	1000	32	--	160	145	4/26+P/26	F03
	F023T050ZA75	90	5	825	1000	36	--	160	140	5/25	F03
	F023T118ZA75	90	4/P	825	1000	36	--	155	142	4/26+P/26	F03.10 glijdop/pastille
	F023T122ZA75	100	2	860	1015	S24	--	(23)	78	1/18+1/60	F74.31 Lenker

BESTELNR N° COMMANDE ORDER NR BESTELNR	BR LRG WID BR	BLADEN LAMES LEAVES BLATT.	B	C	D1	D2	PH FL FA SP	PAK EP TH PAK	DETAIL	MOD	OPMERKINGEN REMARQUES REMARKS BEMERKUNGEN
---	------------------------	-------------------------------------	---	---	----	----	----------------------	------------------------	--------	-----	--

SERIE : G

G330 6x2

Truck - Porteur - Rigid

voor-avant-front-Vorne

A124T295ZA75	90	7/P	820	820	28	20		120	8/15	A01	
A124T267ZA75	90	10	820	820	28	20	160	124	1/14+8/12+1/10	A01	
A124T143ZA75	90	10	820	820	28	28	160	120	1/14+8/12+1/10	A01	
F023T117ZA75	90	3/W	820	820	28	20				F01	
F023T053ZA75	90	3/P	820	820	28	20	165	93	3/23+P/15	F01.10	glijdop/pastille

achter-arrière-rear-Hinten

	A124T086ZA76	100	8/P/10	825	1000	32	--	158	215		A03A
A	A124T086ZA75	100	8	825	1000	32	--	158	105	1/14+7/13	A03
H	A124T086HA80	100	10/P	650	650	--	--	95	110	10/10+P/10	A08
	F023T060ZA76	100	3/P/1	825	1000	32	--	155	139	3/26+1/29+P/20	F03A
A	F023T054ZA75	100	3	825	1000	32	--	155	87	3/26	F03
H	F023T060HA80	100	1/P	670	670	--	--	150	52	1/29+P/20	F08
	F023T054ZA76	100	3/P/1	825	1000	32	--	155	138	3/26+1/28+P/20	F03A
A	F023T054ZA75	100	3	825	1000	32	--	155	87	3/26	F03
H	F023T054HA80	100	1/P	670	670	--	--	140	51	1/28+P/20	F08
	F023T122ZA75	100	2	860	1015	S24	--	(23)	78	1/18+1/60	F74.31 Lenker

G330 8x4

Truck - Porteur - Rigid

voor-avant-front-Vorne

A124T143ZA75	90	10	820	820	28	28	160	120	1/14+8/12+1/10	A01	
F023T069ZA75	90	3/P	820	820	28	20	165	120	3/23+P/39	F01.10	

BESTELNR N° COMMANDE ORDER NR BESTELNR	BR LRG WID BR	BLADEN LAMES LEAVES BLATT.	B	C	D1	D2	PH FL FA SP	PAK EP TH PAK	DETAIL	MOD	OPMERKINGEN REMARQUES REMARKS BEMERKUNGEN
---	------------------------	-------------------------------------	---	---	----	----	----------------------	------------------------	--------	-----	--

SERIE : G**G340TI****Truck - Porteur - Rigid****voor-avant-front-Vorne**

A124T269ZA75	90	10	820	820	28	20		110	10/11	A01	
A124T267ZA75	90	10	820	820	28	20	160	124	1/14+8/12+1/10	A01	
A124T265ZA75	90	10	820	820	28	20	190	110	10/11	A01	
A124T151ZA75	90	10	820	820	28	28	170	110	10/11	A01	
A124T143ZA75	90	10	820	820	28	28	160	120	1/14+8/12+1/10	A01	
A124T083ZA75	90	10	820	820	28	28	190	110	10/11	A01	
F023T107ZA75	90	2/P/P	820	820	28	28	165	96	2/24+P/12+P/30	F01	
F023T109ZA75	90	2/P	820	820	28	20		93	2/24+P/40	F01.10	
F023T055ZA75	90	3/P	820	820	28	20	185	93	3/22+P/18	F01.10	glijdop/pastille
F023T053ZA75	90	3/P	820	820	28	20	165	93	3/23+P/15	F01.10	glijdop/pastille
F023T041ZA75	90	3/P	820	820	28	28	185	93	3/22+P/18	F01.10	glijdop/pastille
F023T039ZA75	90	3/P	820	820	28	28	165	93	3/23+P/15	F01.10	glijdop/pastille

BESTELNR N° COMMANDE ORDER NR BESTELNR	BR LRG WID BR	BLADEN LAMES LEAVES BLATT.	B	C	D1	D2	PH FL FA SP	PAK EP TH PAK	DETAIL	MOD	OPMERKINGEN REMARKS REMARKS BEMERKUNGEN
---	------------------------	-------------------------------------	---	---	----	----	----------------------	------------------------	--------	-----	--

SERIE : G

G340TI

achter-arrière-rear-Hinten

	A124T302ZA76	90	9/10	825	995	32	--	216	189	1/12+7/11+1/10+1	A03A	
A	A124T302ZA75	90	9	825	995	32	--	216	99	1/12+7/11+1/10	A03	
H	A124T302HA80	90	8/2P	695	725	--	--	147	90	8/9+2P/9	A08	
	A124T172ZA76	90	11/10	825	1000	32	--	215	200		A03A	
A	A124T172ZA75	90	11	825	1000	32	--	215	110	1/12+1/11+6/10+3	A03	
H	A124T172HA80	90	10	695	715	--	--	110	90	10/9	A08	
	A124T168ZA76	100	8/2P/5	825	1000	32	--	158	200		A03A	
A	A124T168ZA75	100	8	825	1000	32	--	158	112	8/14	A03	
H	A124T168HA80	100	5/2P	650	650	--	--	75	88	5/12+2P/14	A08	
	A124T086ZA76	100	8/P/10	825	1000	32	--	158	215		A03A	
A	A124T086ZA75	100	8	825	1000	32	--	158	105	1/14+7/13	A03	
H	A124T086HA80	100	10/P	650	650	--	--	95	110	10/10+P/10	A08	
	A124T082ZA70	100	7/P	755	755	--	--	53	175	7/23.5+P/10	A08R	
	F023T166ZA76	90	2/P/1	825	1000	32	--	141	109	2/28+1/28+P/	F03A	
A	F023T166ZA75	90	2/P	825	1000	32	--	141	78	2/28+P/13	F03	
H	F023T166HA80	90	1	700	700	--	--	115	28	1/28	F08	
	F023T100ZA76	90	3/1	825	1000	32	--	140	120	3/25+1/30	F03A	
A	F023T100ZA75	90	3	825	1000	32	--	140	87	3/25	F03	
H	F023T100HA80	90	1	700	700	--	--	110	33	1/30	F08	
	F023T060ZA76	100	3/P/1	825	1000	32	--	155	139	3/26+1/29+P/20	F03A	
A	F023T054ZA75	100	3	825	1000	32	--	155	87	3/26	F03	
H	F023T060HA80	100	1/P	670	670	--	--	150	52	1/29+P/20	F08	
	F023T054ZA76	100	3/P/1	825	1000	32	--	155	138	3/26+1/28+P/20	F03A	
A	F023T054ZA75	100	3	825	1000	32	--	155	87	3/26	F03	
H	F023T054HA80	100	1/P	670	670	--	--	140	51	1/28+P/20	F08	
	F023T122ZA75	100	2	860	1015	S24	--	(23)	78	1/18+1/60	F74.31	Lenker
	F023T148ZA75	100	2	520	370	S30	--	15	132	2/33	Z	Lenker

BESTELNR N° COMMANDE ORDER NR BESTELNR	BR LRG WID BR	BLADEN LAMES LEAVES BLATT.	B	C	D1	D2	PH FL FA SP	PAK EP TH PAK	DETAIL	MOD	OPMERKINGEN REMARQUES REMARKS BEMERKUNGEN
---	------------------------	-------------------------------------	---	---	----	----	----------------------	------------------------	--------	-----	--

SERIE : G**G340TI****Trekker - Tracteur - Tractor****voor-avant-front-Vorne**

A124T263ZA75	90	7	820	820	28	20		98	7/14	A01	
A124T183ZA75	90	7	870	870	28	28	172	98	7/14	A01	
F023T053ZA75	90	3/P	820	820	28	20	165	93	3/23+P/15	F01.10	glijdop/pastille
F023T037ZA75	90	2/P/W	865	865	28	20	174	99	2/25+P/25+W	F01.10	glijdop/pastille
F023T045ZA75	90	3/W	870	870	28	20	197	93	3/21+W	F01.10	glijdop/pastille
F023T115ZA75	90	3/W	870	870	28	20				F01.10	
F023T111ZA75	90	3/W	870	870	28	20	125	93	3/21+W	F01.10	glijdop/pastille

achter-arrière-rear-Hinten

A	A124T290ZA76	90	9/P/P/7	825	1000	36	--	115	257		A03A
	A124T290ZA75	90	9/P	825	1000	36	--	115	161	9/14+P/35	A03
H	A124T290HA80	90	7/P	650	650	--	--	63	96	7/12+P/12	A08
	F023T182ZA75	90	4/P	825	1000	32	--	134	132	4/24+P/	F03
	F023T188ZA75	90	4/P	825	1000	32	--		142	4/26+P/26	F03 glijdop/pastille
	F023T026ZA75	90	4/P	825	1000	36	--	155	145	4/26+P/26	F03
	F023T058ZA75	90	4/P	825	1000	32	--	160	145	4/26+P/26	F03
	F023T052ZA75	90	4/P	825	1000	36	--	155	145	4/26+P/26	F03
	F023T050ZA75	90	5	825	1000	36	--	160	140	5/25	F03
	F023T118ZA75	90	4/P	825	1000	36	--	155	142	4/26+P/26	F03.10 glijdop/pastille
	F023T122ZA75	100	2	860	1015	S24	--	(23)	78	1/18+1/60	F74.31 Lenker

G340TI 4x2**Trekker - Tracteur - Tractor****voor-avant-front-Vorne**

F023T045ZA75	90	3/W	870	870	28	20	197	93	3/21+W	F01.10	glijdop/pastille
--------------	----	-----	-----	-----	----	----	-----	----	--------	--------	------------------

achter-arrière-rear-Hinten

F023T186ZA75	90	3/P	0	0	20	20		0		F01	glijdop/pastille
--------------	----	-----	---	---	----	----	--	---	--	-----	------------------

BESTELNR N° COMMANDE ORDER NR BESTELLNR	BR LRG WID BR	BLADEN LAMES LEAVES BLATT.	B	C	D1	D2	PH FL FA SP	PAK EP TH PAK	DETAIL	MOD	OPMERKINGEN REMARQUES REMARKS BEMERKUNGEN
--	------------------------	-------------------------------------	---	---	----	----	----------------------	------------------------	--------	-----	--

SERIE : G

G340TI 4x4

Trekker - Tracteur - Tractor

voor-avant-front-Vorne

F023T053ZA75	90	3/P	820	820	28	20	165	93	3/23+P/15	F01.10	glijdop/pastille
--------------	----	-----	-----	-----	----	----	-----	----	-----------	--------	------------------

achter-arrière-rear-Hinten

F023T050ZA75	90	5	825	1000	36	--	160	140	5/25	F03	
--------------	----	---	-----	------	----	----	-----	-----	------	-----	--

G340TI 6x2

Truck - Porteur - Rigid

voor-avant-front-Vorne

A124T295ZA75	90	7/P	820	820	28	20		120	8/15	A01	
A124T267ZA75	90	10	820	820	28	20	160	124	1/14+8/12+1/10	A01	
A124T143ZA75	90	10	820	820	28	28	160	120	1/14+8/12+1/10	A01	
F023T117ZA75	90	3/W	820	820	28	20				F01	
F023T053ZA75	90	3/P	820	820	28	20	165	93	3/23+P/15	F01.10	glijdop/pastille

achter-arrière-rear-Hinten

	A124T086ZA76	100	8/P/10	825	1000	32	--	158	215		A03A	
A	A124T086ZA75	100	8	825	1000	32	--	158	105	1/14+7/13	A03	
H	A124T086HA80	100	10/P	650	650	--	--	95	110	10/10+P/10	A08	
	F023T060ZA76	100	3/P/1	825	1000	32	--	155	139	3/26+1/29+P/20	F03A	
A	F023T054ZA75	100	3	825	1000	32	--	155	87	3/26	F03	
H	F023T060HA80	100	1/P	670	670	--	--	150	52	1/29+P/20	F08	
	F023T054ZA76	100	3/P/1	825	1000	32	--	155	138	3/26+1/28+P/20	F03A	
A	F023T054ZA75	100	3	825	1000	32	--	155	87	3/26	F03	
H	F023T054HA80	100	1/P	670	670	--	--	140	51	1/28+P/20	F08	
	F023T122ZA75	100	2	860	1015	S24	--	(23)	78	1/18+1/60	F74.31	Lenker

BESTELNR N° COMMANDE ORDER NR BESTELNR	BR LRG WID BR	BLADEN LAMES LEAVES BLATT.	B	C	D1	D2	PH FL FA SP	PAK EP TH PAK	DETAIL	MOD	OPMERKINGEN REMARKS BEMERKUNGEN
---	------------------------	-------------------------------------	---	---	----	----	----------------------	------------------------	--------	-----	---------------------------------------

SERIE : G**G340TI 6x4****Truck - Porteur - Rigid****voor-avant-front-Vorne**

A124T277ZA75	90	8	820	820	28	20		120	8/15	A01
A124T279ZA75	90	8	820	820	28	20		120	8/15	A01
F023T065ZA75	90	3	820	820	28	20	130	84	3/25	F01.10

achter-arrière-rear-Hinten

A124T082ZA70	100	7/P	755	755	--	--	53	175	7/23.5+P/10	A08R
A124T292ZA70	100	9/P	790	790	--	--	64	235	9/25+P/10	A08R
F023T094ZA70	100	3	785	785	--	--	60	136	3/38	F08R

G340TI 8x4**Truck - Porteur - Rigid****voor-avant-front-Vorne**

A124T277ZA75	90	8	820	820	28	20		120	8/15	A01
A124T143ZA75	90	10	820	820	28	28	160	120	1/14+8/12+1/10	A01
F023T069ZA75	90	3/P	820	820	28	20	165	120	3/23+P/39	F01.10
F023T065ZA75	90	3	820	820	28	20	130	84	3/25	F01.10

achter-arrière-rear-Hinten

A124T082ZA70	100	7/P	755	755	--	--	53	175	7/23.5+P/10	A08R
A124T292ZA70	100	9/P	790	790	--	--	64	235	9/25+P/10	A08R
A124T300ZA70	100	11/P	880	880	--	--		285	11/25+P/10	A08R
F023T094ZA70	100	3	785	785	--	--	60	136	3/38	F08R

G340TI 6x6**Truck - Porteur - Rigid****voor-avant-front-Vorne**

A124T279ZA75	90	8	820	820	28	20		120	8/15	A01
--------------	----	---	-----	-----	----	----	--	-----	------	-----

achter-arrière-rear-Hinten

A124T292ZA70	100	9/P	790	790	--	--	64	235	9/25+P/10	A08R
--------------	-----	-----	-----	-----	----	----	----	-----	-----------	------

BESTELNR N° COMMANDE ORDER NR BESTELLNR	BR LRG WID BR	BLADEN LAMES LEAVES BLATT.	B	C	D1	D2	PH FL FA SP	PAK EP TH PAK	DETAIL	MOD	OPMERKINGEN REMARQUES REMARKS BEMERKUNGEN
--	------------------------	-------------------------------------	---	---	----	----	----------------------	------------------------	--------	-----	--

SERIE : GB

GB191

voor-avant-front-Vorne

A124T059ZA75	75	9/P	820	820	22	22	185	114	2/12+6/11+1/10+	A01
A124T285ZA75	75	10	820	820	28	28	145	120	10/12	A01

achter-arrière-rear-Hinten

	A124T218ZA75	90	9	825	995	32	--	50	126	9/14	A03
	A124T064ZA76	90	9/8	825	995	24	--	216	171	1/12+7/11+1/10+8	A03A
A	A124T064ZA75	90	9	825	995	24	--	216	99	1/12+7/11+1/10	A03
H	A124T064HA80	90	8	710	710	--	--	140	72	8/9	A08

GB231

voor-avant-front-Vorne

A124T059ZA75	75	9/P	820	820	22	22	185	114	2/12+6/11+1/10+	A01
A124T285ZA75	75	10	820	820	28	28	145	120	10/12	A01

achter-arrière-rear-Hinten

	A124T218ZA75	90	9	825	995	32	--	50	126	9/14	A03
	A124T064ZA76	90	9/8	825	995	24	--	216	171	1/12+7/11+1/10+8	A03A
A	A124T064ZA75	90	9	825	995	24	--	216	99	1/12+7/11+1/10	A03
H	A124T064HA80	90	8	710	710	--	--	140	72	8/9	A08

BESTELNR N° COMMANDE ORDER NR BESTELNR	BR LRG WID BR	BLADEN LAMES LEAVES BLATT.	B	C	D1	D2	PH FL FA SP	PAK EP TH PAK	DETAIL	MOD	OPMERKINGEN REMARKS BEMERKUNGEN
---	------------------------	-------------------------------------	---	---	----	----	----------------------	------------------------	--------	-----	---------------------------------------

SERIE : GBH

GBH12 6x4

voor-avant-front-Vorne

A124T027ZB75	90	15	700	820	28	--	80	139	1/13+14/9	A03t	
A124T155ZA75	90	15	700	820	28	--	89	138	1/12+14/9	A03t	
A124T021ZB75	90	C/17	700	870	28	--	125	146	C/8+1/10+16/8	A03t	

achter-arrière-rear-Hinten

A124T150ZA70	100	9/P	745	745	--	--	15	208	9/22+P/10	A08R	
A124T152ZA70	100	9/P	745	745	--	--	15	208	9/22+P/10	A08R	
A124T032ZB70	120	8	740	740	--	--	0	160	8/20	A08R	dut
A124T022ZB70	120	8	740	740	--	--	0	160	8/20	A08R	tb
A124T022ZA70	120	8	740	740	--	--	0	160	8/20	A08R	dut

GBH12 6x6

voor-avant-front-Vorne

A124T027ZB75	90	15	700	820	28	--	80	139	1/13+14/9	A03t	
A124T155ZA75	90	15	700	820	28	--	89	138	1/12+14/9	A03t	
A124T021ZB75	90	C/17	700	870	28	--	125	146	C/8+1/10+16/8	A03t	

achter-arrière-rear-Hinten

A124T150ZA70	100	9/P	745	745	--	--	15	208	9/22+P/10	A08R	
A124T152ZA70	100	9/P	745	745	--	--	15	208	9/22+P/10	A08R	
A124T022ZA70	120	8	740	740	--	--	0	160	8/20	A08R	dut
A124T022ZB70	120	8	740	740	--	--	0	160	8/20	A08R	tb
A124T032ZB70	120	8	740	740	--	--	0	160	8/20	A08R	dut

BESTELNR N° COMMANDE ORDER NR BESTELNR	BR LRG WID BR	BLADEN LAMES LEAVES BLATT.	B	C	D1	D2	PH FL FA SP	PAK EP TH PAK	DETAIL	MOD	OPMERKINGEN REMARQUES REMARKS BEMERKUNGEN
---	------------------------	-------------------------------------	---	---	----	----	----------------------	------------------------	--------	-----	--

SERIE : GBH

GBH260 6x4

voor-avant-front-Vorne

A124T027ZB75	90	15	700	820	28	--	80	139	1/13+14/9	A03t	
A124T155ZA75	90	15	700	820	28	--	89	138	1/12+14/9	A03t	
A124T021ZB75	90	C/17	700	870	28	--	125	146	C/8+1/10+16/8	A03t	

achter-arrière-rear-Hinten

A124T152ZA70	100	9/P	745	745	--	--	15	208	9/22+P/10	A08R	
A124T150ZA70	100	9/P	745	745	--	--	15	208	9/22+P/10	A08R	
A124T022ZA70	120	8	740	740	--	--	0	160	8/20	A08R	dut
A124T022ZB70	120	8	740	740	--	--	0	160	8/20	A08R	tb
A124T032ZB70	120	8	740	740	--	--	0	160	8/20	A08R	dut

GBH260 6x6

voor-avant-front-Vorne

A124T027ZB75	90	15	700	820	28	--	80	139	1/13+14/9	A03t	
A124T155ZA75	90	15	700	820	28	--	89	138	1/12+14/9	A03t	
A124T021ZB75	90	C/17	700	870	28	--	125	146	C/8+1/10+16/8	A03t	

achter-arrière-rear-Hinten

A124T150ZA70	100	9/P	745	745	--	--	15	208	9/22+P/10	A08R	
A124T152ZA70	100	9/P	745	745	--	--	15	208	9/22+P/10	A08R	
A124T032ZB70	120	8	740	740	--	--	0	160	8/20	A08R	dut
A124T022ZB70	120	8	740	740	--	--	0	160	8/20	A08R	tb
A124T022ZA70	120	8	740	740	--	--	0	160	8/20	A08R	dut

BESTELNR N° COMMANDE ORDER NR BESTELNR	BR LRG WID BR	BLADEN LAMES LEAVES BLATT.	B	C	D1	D2	PH FL FA SP	PAK EP TH PAK	DETAIL	MOD	OPMERKINGEN REMARKS BEMERKUNGEN
---	------------------------	-------------------------------------	---	---	----	----	----------------------	------------------------	--------	-----	---------------------------------------

SERIE : GBH

GBH280 6x4

voor-avant-front-Vorne

A124T155ZA75	90	15	700	820	28	--	89	138	1/12+14/9	A03t	
A124T027ZB75	90	15	700	820	28	--	80	139	1/13+14/9	A03t	
A124T021ZB75	90	C/17	700	870	28	--	125	146	C/8+1/10+16/8	A03t	

achter-arrière-rear-Hinten

A124T152ZA70	100	9/P	745	745	--	--	15	208	9/22+P/10	A08R	
A124T150ZA70	100	9/P	745	745	--	--	15	208	9/22+P/10	A08R	
A124T032ZB70	120	8	740	740	--	--	0	160	8/20	A08R	dut
A124T022ZA70	120	8	740	740	--	--	0	160	8/20	A08R	dut
A124T022ZB70	120	8	740	740	--	--	0	160	8/20	A08R	tb

GBH280 6x6

voor-avant-front-Vorne

A124T155ZA75	90	15	700	820	28	--	89	138	1/12+14/9	A03t	
A124T027ZB75	90	15	700	820	28	--	80	139	1/13+14/9	A03t	
A124T021ZB75	90	C/17	700	870	28	--	125	146	C/8+1/10+16/8	A03t	

achter-arrière-rear-Hinten

A124T150ZA70	100	9/P	745	745	--	--	15	208	9/22+P/10	A08R	
A124T152ZA70	100	9/P	745	745	--	--	15	208	9/22+P/10	A08R	
A124T022ZA70	120	8	740	740	--	--	0	160	8/20	A08R	dut
A124T022ZB70	120	8	740	740	--	--	0	160	8/20	A08R	tb
A124T032ZB70	120	8	740	740	--	--	0	160	8/20	A08R	dut

BESTELNR N° COMMANDE ORDER NR BESTELNR	BR LRG WID BR	BLADEN LAMES LEAVES BLATT.	B	C	D1	D2	PH FL FA SP	PAK EP TH PAK	DETAIL	MOD	OPMERKINGEN REMARKS BEMERKUNGEN
---	------------------------	-------------------------------------	---	---	----	----	----------------------	------------------------	--------	-----	---------------------------------------

SERIE : GC

GC190

voor-avant-front-Vorne

A124T083ZA75	90	10	820	820	28	28	190	110	10/11	A01
A124T143ZA75	90	10	820	820	28	28	160	120	1/14+8/12+1/10	A01
A124T075ZA75	90	10	820	820	28	28	181	118	9/12+1/10	A01
A124T037ZA75	90	10	820	820	28	28	245	106	1/12+4/11+5/10	A01

achter-arrière-rear-Hinten

A124T216ZA75	90	13	825	800	32	--	87	156	13/12	A03
A124T218ZA75	90	9	825	995	32	--	50	126	9/14	A03
A124T050ZA76	90	11/2P/10	825	1000	32	--	245	220		A03A
A124T050ZA75	90	11/2P	825	1000	32	--	245	130	1/12+1/11+6/10+3	A03
A124T050HA80	90	10	695	715	--	--	110	90	10/9	A08

GC191

voor-avant-front-Vorne

A124T037ZA75	90	10	820	820	28	28	245	106	1/12+4/11+5/10	A01
A124T075ZA75	90	10	820	820	28	28	181	118	9/12+1/10	A01
A124T083ZA75	90	10	820	820	28	28	190	110	10/11	A01
A124T143ZA75	90	10	820	820	28	28	160	120	1/14+8/12+1/10	A01

achter-arrière-rear-Hinten

A124T216ZA75	90	13	825	800	32	--	87	156	13/12	A03
A124T218ZA75	90	9	825	995	32	--	50	126	9/14	A03
A124T050ZA76	90	11/2P/10	825	1000	32	--	245	220		A03A
A124T050ZA75	90	11/2P	825	1000	32	--	245	130	1/12+1/11+6/10+3	A03
A124T050HA80	90	10	695	715	--	--	110	90	10/9	A08

BESTELNR N° COMMANDE ORDER NR BESTELNR	BR LRG WID BR	BLADEN LAMES LEAVES BLATT.	B	C	D1	D2	PH FL FA SP	PAK EP TH PAK	DETAIL	MOD	OPMERKINGEN REMARKS REMARKS BEMERKUNGEN
---	------------------------	-------------------------------------	---	---	----	----	----------------------	------------------------	--------	-----	--

SERIE : GC

GC231

voor-avant-front-Vorne

A124T037ZA75	90	10	820	820	28	28	245	106	1/12+4/11+5/10	A01
A124T083ZA75	90	10	820	820	28	28	190	110	10/11	A01
A124T075ZA75	90	10	820	820	28	28	181	118	9/12+1/10	A01
A124T143ZA75	90	10	820	820	28	28	160	120	1/14+8/12+1/10	A01

achter-arrière-rear-Hinten

A124T216ZA75	90	13	825	800	32	--	87	156	13/12	A03
A124T218ZA75	90	9	825	995	32	--	50	126	9/14	A03
A124T050ZA76	90	11/2P/10	825	1000	32	--	245	220		A03A
A124T050ZA75	90	11/2P	825	1000	32	--	245	130	1/12+1/11+6/10+3	A03
A124T050HA80	90	10	695	715	--	--	110	90	10/9	A08

BESTELNR N° COMMANDE ORDER NR BESTELNR	BR LRG WID BR	BLADEN LAMES LEAVES BLATT.	B	C	D1	D2	PH FL FA SP	PAK EP TH PAK	DETAIL	MOD	OPMERKINGEN REMARKS BEMERKUNGEN
---	------------------------	-------------------------------------	---	---	----	----	----------------------	------------------------	--------	-----	---------------------------------------

SERIE : GF

GF191

voor-avant-front-Vorne

A124T037ZA75	90	10	820	820	28	28	245	106	1/12+4/11+5/10	A01
A124T143ZA75	90	10	820	820	28	28	160	120	1/14+8/12+1/10	A01
A124T075ZA75	90	10	820	820	28	28	181	118	9/12+1/10	A01
A124T083ZA75	90	10	820	820	28	28	190	110	10/11	A01

achter-arrière-rear-Hinten

A124T216ZA75	90	13	825	800	32	--	87	156	13/12	A03
A124T218ZA75	90	9	825	995	32	--	50	126	9/14	A03
A124T050ZA76	90	11/2P/10	825	1000	32	--	245	220		A03A
A124T050ZA75	90	11/2P	825	1000	32	--	245	130	1/12+1/11+6/10+3	A03
A124T050HA80	90	10	695	715	--	--	110	90	10/9	A08

GF231

voor-avant-front-Vorne

A124T075ZA75	90	10	820	820	28	28	181	118	9/12+1/10	A01
A124T143ZA75	90	10	820	820	28	28	160	120	1/14+8/12+1/10	A01
A124T083ZA75	90	10	820	820	28	28	190	110	10/11	A01
A124T037ZA75	90	10	820	820	28	28	245	106	1/12+4/11+5/10	A01

achter-arrière-rear-Hinten

A124T216ZA75	90	13	825	800	32	--	87	156	13/12	A03
A124T218ZA75	90	9	825	995	32	--	50	126	9/14	A03
A124T050ZA76	90	11/2P/10	825	1000	32	--	245	220		A03A
A124T050ZA75	90	11/2P	825	1000	32	--	245	130	1/12+1/11+6/10+3	A03
A124T050HA80	90	10	695	715	--	--	110	90	10/9	A08

BESTELNR N° COMMANDE ORDER NR BESTELLNR	BR LRG WID BR	BLADEN LAMES LEAVES BLATT.	B	C	D1	D2	PH FL FA SP	PAK EP TH PAK	DETAIL	MOD	OPMERKINGEN REMARQUES REMARKS BEMERKUNGEN
--	------------------------	-------------------------------------	---	---	----	----	----------------------	------------------------	--------	-----	--

SERIE : GL

GL750

voor-avant-front-Vorne

A124T089ZA75	75	10/P	675	675	22	22	145	100	10/10+P/5	A01
--------------	----	------	-----	-----	----	----	-----	-----	-----------	-----

achter-arrière-rear-Hinten

	A124T090ZA76	75	10/P/10	700	850	28	--	95	193		A03A
A	A124T090ZA75	75	9/P	700	850	28	28	95	90		A03
H	A124T090HA80	75	10/P	580	580	--	--				A08

BESTELNR N° COMMANDE ORDER NR BESTELLNR	BR LRG WID BR	BLADEN LAMES LEAVES BLATT.	B	C	D1	D2	PH FL FA SP	PAK EP TH PAK	DETAIL	MOD	OPMERKINGEN REMARQUES REMARKS BEMERKUNGEN
--	------------------------	-------------------------------------	---	---	----	----	----------------------	------------------------	--------	-----	--

SERIE : GLC

GLC190

voor-avant-front-Vorne

A124T093ZA75	90	9	820	820	28	28	190	101		A01
--------------	----	---	-----	-----	----	----	-----	-----	--	-----

achter-arrière-rear-Hinten

	A124T094ZA76	90	10/2P/P/10	825	995	32	--	136		A03A
A	A124T094ZA75	90	10/2P	825	995	32	--	136		A03
H	A124T094HA80	90	10/P	710	710	--	--	88	100	A08

BESTELNR N° COMMANDE ORDER NR BESTELLNR	BR LRG WID BR	BLADEN LAMES LEAVES BLATT.	B	C	D1	D2	PH FL FA SP	PAK EP TH PAK	DETAIL	MOD	OPMERKINGEN REMARQUES REMARKS BEMERKUNGEN
--	------------------------	-------------------------------------	---	---	----	----	----------------------	------------------------	--------	-----	--

SERIE : GLM

GLM280

voor-avant-front-Vorne

A124T155ZA75	90	15	700	820	28	--	89	138	1/12+14/9	A03t
--------------	----	----	-----	-----	----	----	----	-----	-----------	------

achter-arrière-rear-Hinten

	A124T180ZA76	100	11/P/5	775	925	32	--	128	200		A03A
A	A124T180ZA75	100	11	775	925	32	--	128	134	1/14+10/12	A03
H	A124T180HA80	100	5/P	610	610	--	--	106	66	5/11+P/11	A08
	A124T238ZA76	100	11/P/9	775	960	32	--		244		A03A
A	A124T238ZA75	100	11	775	960	32	--		134	1/14+10/12	A03
H	A124T238HA80	100	9/P	610	610	--	--		110	9/11+P/11	A08

BESTELNR N° COMMANDE ORDER NR BESTELNR	BR LRG WID BR	BLADEN LAMES LEAVES BLATT.	B	C	D1	D2	PH FL FA SP	PAK EP TH PAK	DETAIL	MOD	OPMERKINGEN REMARQUES REMARKS BEMERKUNGEN
---	------------------------	-------------------------------------	---	---	----	----	----------------------	------------------------	--------	-----	--

SERIE : GLR**GLR160****voor-avant-front-Vorne**

A124T033ZA75	90	11	675	675	28	28	185	99	11/9	A01
A124T051ZA75	90	13	675	675	28	28	215	117	13/9	A01

achter-arrière-rear-Hinten

A	A124T076ZA76	90	16/P/9	705	705	28	28	150	240		A01A
A	A124T076ZA75	90	C/15	705	705	28	28	150	160	C/10+15/10	A01
H	A124T076HA80	90	9/P	500	500	--	--	38	80	9/8+P/8	A08

GLR190**voor-avant-front-Vorne**

A124T075ZA75	90	10	820	820	28	28	181	118	9/12+1/10	A01
A124T143ZA75	90	10	820	820	28	28	160	120	1/14+8/12+1/10	A01

achter-arrière-rear-Hinten

A	A124T086ZA76	100	8/P/10	825	1000	32	--	158	215		A03A
A	A124T086ZA75	100	8	825	1000	32	--	158	105	1/14+7/13	A03
H	A124T086HA80	100	10/P	650	650	--	--	95	110	10/10+P/10	A08
A	A124T162ZA76	100	8/P/10	825	1000	32	--	160	226		A03A
A	A124T162ZA75	100	8	825	1000	32	--	160	116	8/14	A03
H	A124T162HA80	100	10/P	650	650	--	--	104	110	10/10+P/10	A08

GLR200**voor-avant-front-Vorne**

A124T033ZA75	90	11	675	675	28	28	185	99	11/9	A01
A124T051ZA75	90	13	675	675	28	28	215	117	13/9	A01
A124T071ZA75	90	C/16	700	870	28	--	195	138	C/8+1/10+15/8	A03

achter-arrière-rear-Hinten

A	A124T076ZA76	90	16/P/9	705	705	28	28	150	240		A01A
A	A124T076ZA75	90	C/15	705	705	28	28	150	160	C/10+15/10	A01
H	A124T076HA80	90	9/P	500	500	--	--	38	80	9/8+P/8	A08
A	A124T076ZB76	90	16/P/10	705	705	28	28	150	240		A01A
A	A124T076ZA75	90	C/15	705	705	28	28	150	160	C/10+15/10	A01
H	A124T076HB80	90	10/P	500	500	--	--	35	88	10/8+P/8	A08

BESTELNR N° COMMANDE ORDER NR BESTELNR	BR LRG WID BR	BLADEN LAMES LEAVES BLATT.	B	C	D1	D2	PH FL FA SP	PAK EP TH PAK	DETAIL	MOD	OPMERKINGEN REMARQUES REMARKS BEMERKUNGEN
---	------------------------	-------------------------------------	---	---	----	----	----------------------	------------------------	--------	-----	--

SERIE : GLR**GLR230 4x2****voor-avant-front-Vorne**

A124T075ZA75	90	10	820	820	28	28	181	118	9/12+1/10	A01
A124T143ZA75	90	10	820	820	28	28	160	120	1/14+8/12+1/10	A01

achter-arrière-rear-Hinten

A	A124T162ZA76	100	8/P/10	825	1000	32	--	160	226		A03A
A	A124T162ZA75	100	8	825	1000	32	--	160	116	8/14	A03
H	A124T162HA80	100	10/P	650	650	--	--	104	110	10/10+P/10	A08
A	A124T086ZA76	100	8/P/10	825	1000	32	--	158	215		A03A
A	A124T086ZA75	100	8	825	1000	32	--	158	105	1/14+7/13	A03
H	A124T086HA80	100	10/P	650	650	--	--	95	110	10/10+P/10	A08

GLR230 4x4**voor-avant-front-Vorne**

A124T075ZA75	90	10	820	820	28	28	181	118	9/12+1/10	A01
A124T143ZA75	90	10	820	820	28	28	160	120	1/14+8/12+1/10	A01

achter-arrière-rear-Hinten

A	A124T086ZA76	100	8/P/10	825	1000	32	--	158	215		A03A
A	A124T086ZA75	100	8	825	1000	32	--	158	105	1/14+7/13	A03
H	A124T086HA80	100	10/P	650	650	--	--	95	110	10/10+P/10	A08
A	A124T162ZA76	100	8/P/10	825	1000	32	--	160	226		A03A
A	A124T162ZA75	100	8	825	1000	32	--	160	116	8/14	A03
H	A124T162HA80	100	10/P	650	650	--	--	104	110	10/10+P/10	A08

BESTELNR N° COMMANDE ORDER NR BESTELLNR	BR LRG WID BR	BLADEN LAMES LEAVES BLATT.	B	C	D1	D2	PH FL FA SP	PAK EP TH PAK	DETAIL	MOD	OPMERKINGEN REMARQUES REMARKS BEMERKUNGEN
--	------------------------	-------------------------------------	---	---	----	----	----------------------	------------------------	--------	-----	--

SERIE : GLR

GLR250

voor-avant-front-Vorne

A124T033ZA75	90	11	675	675	28	28	185	99	11/9	A01
A124T051ZA75	90	13	675	675	28	28	215	117	13/9	A01
A124T071ZA75	90	C/16	700	870	28	--	195	138	C/8+1/10+15/8	A03

achter-arrière-rear-Hinten

	A124T076ZA76	90	16/P/9	705	705	28	28	150	240		A01A
A	A124T076ZA75	90	C/15	705	705	28	28	150	160	C/10+15/10	A01
H	A124T076HA80	90	9/P	500	500	--	--	38	80	9/8+P/8	A08
	A124T076ZB76	90	16/P/10	705	705	28	28	150	240		A01A
A	A124T076ZA75	90	C/15	705	705	28	28	150	160	C/10+15/10	A01
H	A124T076HB80	90	10/P	500	500	--	--	35	88	10/8+P/8	A08

BESTELNR N° COMMANDE ORDER NR BESTELNR	BR LRG WID BR	BLADEN LAMES LEAVES BLATT.	B	C	D1	D2	PH FL FA SP	PAK EP TH PAK	DETAIL	MOD	OPMERKINGEN REMARQUES REMARKS BEMERKUNGEN
---	------------------------	-------------------------------------	---	---	----	----	----------------------	------------------------	--------	-----	--

SERIE : GR**GR190****voor-avant-front-Vorne**

A124T037ZA75	90	10	820	820	28	28	245	106	1/12+4/11+5/10	A01
A124T075ZA75	90	10	820	820	28	28	181	118	9/12+1/10	A01
A124T083ZA75	90	10	820	820	28	28	190	110	10/11	A01

achter-arrière-rear-Hinten

	A124T158ZA75	100	13	825	800	32	--	30	182	13/14	A03
	A124T222ZA76	100	8/2P/5	825	815	32		123	198		A03A
A	A124T222ZA75	100	8	825	815	32	--	123	112	8/14	A03
H	A124T222HA80	100	5/2P	650	465	--	--	73	86	5/12+P/12+P/14	A08
	A124T066ZA76	100	8/2P/5	825	1000	32	--	210	200	8/14+5/12+2P/14	A03A
A	A124T066ZA75	100	8	825	1000	32	--	210	112	8/14	A03
H	A124T066HA80	100	5/2P	650	650	--	--	120	88	5/12+2P/14	A08
	A124T224ZA76	100	9/P/6	825	1000	32	--	55	232		A03A
A	A124T224ZA75	100	9	825	1000	32	--	55	126	9/14	A03
H	A124T224HA80	100	6/P	650	650	--	--	25	96	6/14+P/12	A08
	A124T220ZA76	100	8/P/9	825	1000	32	--	169	225	8/14+9/11+P/11	A03A
A	A124T220ZA75	100	8	825	1000	32	--	169	112	8/14	A03
H	A124T220HA80	100	9/P	650	650	--	--	95	113	9/11+P/14	A08

BESTELNR N° COMMANDE ORDER NR BESTELNR	BR LRG WID BR	BLADEN LAMES LEAVES BLATT.	B	C	D1	D2	PH FL FA SP	PAK EP TH PAK	DETAIL	MOD	OPMERKINGEN REMARKS REMARKS BEMERKUNGEN
---	------------------------	-------------------------------------	---	---	----	----	----------------------	------------------------	--------	-----	--

SERIE : GR

GR191

voor-avant-front-Vorne

A124T083ZA75	90	10	820	820	28	28	190	110	10/11	A01
A124T075ZA75	90	10	820	820	28	28	181	118	9/12+1/10	A01
A124T037ZA75	90	10	820	820	28	28	245	106	1/12+4/11+5/10	A01

achter-arrière-rear-Hinten

A124T158ZA75	100	13	825	800	32	--	30	182	13/14	A03
A124T222ZA76	100	8/2P/5	825	815	32	--	123	198		A03A
A124T222ZA75	100	8	825	815	32	--	123	112	8/14	A03
A124T222HA80	100	5/2P	650	465	--	--	73	86	5/12+P/12+P/14	A08
A124T066ZA76	100	8/2P/5	825	1000	32	--	210	200	8/14+5/12+2P/14	A03A
A124T066ZA75	100	8	825	1000	32	--	210	112	8/14	A03
A124T066HA80	100	5/2P	650	650	--	--	120	88	5/12+2P/14	A08
A124T224ZA76	100	9/P/6	825	1000	32	--	55	232		A03A
A124T224ZA75	100	9	825	1000	32	--	55	126	9/14	A03
A124T224HA80	100	6/P	650	650	--	--	25	96	6/14+P/12	A08
A124T220ZA76	100	8/P/9	825	1000	32	--	169	225	8/14+9/11+P/11	A03A
A124T220ZA75	100	8	825	1000	32	--	169	112	8/14	A03
A124T220HA80	100	9/P	650	650	--	--	95	113	9/11+P/14	A08

GR200

voor-avant-front-Vorne

A124T067ZA75	90	13	775	775	28	28	220	119	2/10+11/9	A01
--------------	----	----	-----	-----	----	----	-----	-----	-----------	-----

achter-arrière-rear-Hinten

A124T074ZA76	90	C/11/5	800	800	32	32	157	204		A01A
A124T074ZA75	90	C/11	800	800	32	32	157	144	C/10+1/14+10/12	A01
A124T074HA80	90	5	595	595	--	--	100	60	5/12	A08

BESTELNR N° COMMANDE ORDER NR BESTELNR	BR LRG WID BR	BLADEN LAMES LEAVES BLATT.	B	C	D1	D2	PH FL FA SP	PAK EP TH PAK	DETAIL	MOD	OPMERKINGEN REMARQUES REMARKS BEMERKUNGEN
---	------------------------	-------------------------------------	---	---	----	----	----------------------	------------------------	--------	-----	--

SERIE : GR

GR205

voor-avant-front-Vorne

A124T043ZA75	100	13	825	825	32	32	245	118	1/10+12/9	A01
--------------	-----	----	-----	-----	----	----	-----	-----	-----------	-----

achter-arrière-rear-Hinten

A	A124T054ZA76	100	8/P/5	825	1000	32	--	225	184	8/14+5/12+P/12	A03A
A	A124T054ZA75	100	8	825	1000	32	--	225	112	8/14	A03
H	A124T054HA80	100	5/P	665	665	--	--	132	72	5/12+P/12	A08

GR205A

voor-avant-front-Vorne

A124T067ZA75	90	13	775	775	28	28	220	119	2/10+11/9	A01
--------------	----	----	-----	-----	----	----	-----	-----	-----------	-----

achter-arrière-rear-Hinten

A	A124T074ZA76	90	C/11/5	800	800	32	32	157	204		A01A
A	A124T074ZA75	90	C/11	800	800	32	32	157	144	C/10+1/14+10/12	A01
H	A124T074HA80	90	5	595	595	--	--	100	60	5/12	A08

GR205B

voor-avant-front-Vorne

A124T067ZA75	90	13	775	775	28	28	220	119	2/10+11/9	A01
--------------	----	----	-----	-----	----	----	-----	-----	-----------	-----

achter-arrière-rear-Hinten

A	A124T074ZA76	90	C/11/5	800	800	32	32	157	204		A01A
A	A124T074ZA75	90	C/11	800	800	32	32	157	144	C/10+1/14+10/12	A01
H	A124T074HA80	90	5	595	595	--	--	100	60	5/12	A08

BESTELNR N° COMMANDE ORDER NR BESTELNR	BR LRG WID BR	BLADEN LAMES LEAVES BLATT.	B	C	D1	D2	PH FL FA SP	PAK EP TH PAK	DETAIL	MOD	OPMERKINGEN REMARKS REMARKS BEMERKUNGEN
---	------------------------	-------------------------------------	---	---	----	----	----------------------	------------------------	--------	-----	--

SERIE : GR

GR231

voor-avant-front-Vorne

A124T037ZA75	90	10	820	820	28	28	245	106	1/12+4/11+5/10	A01
A124T075ZA75	90	10	820	820	28	28	181	118	9/12+1/10	A01
A124T083ZA75	90	10	820	820	28	28	190	110	10/11	A01

achter-arrière-rear-Hinten

A124T158ZA75	100	13	825	800	32	--	30	182	13/14	A03
A124T222ZA76	100	8/2P/5	825	815	32	--	123	198		A03A
A124T222ZA75	100	8	825	815	32	--	123	112	8/14	A03
A124T222HA80	100	5/2P	650	465	--	--	73	86	5/12+P/12+P/14	A08
A124T066ZA76	100	8/2P/5	825	1000	32	--	210	200	8/14+5/12+2P/14	A03A
A124T066ZA75	100	8	825	1000	32	--	210	112	8/14	A03
A124T066HA80	100	5/2P	650	650	--	--	120	88	5/12+2P/14	A08
A124T224ZA76	100	9/P/6	825	1000	32	--	55	232		A03A
A124T224ZA75	100	9	825	1000	32	--	55	126	9/14	A03
A124T224HA80	100	6/P	650	650	--	--	25	96	6/14+P/12	A08
A124T220ZA76	100	8/P/9	825	1000	32	--	169	225	8/14+9/11+P/11	A03A
A124T220ZA75	100	8	825	1000	32	--	169	112	8/14	A03
A124T220HA80	100	9/P	650	650	--	--	95	113	9/11+P/14	A08

GR250

voor-avant-front-Vorne

A124T067ZA75	90	13	775	775	28	28	220	119	2/10+11/9	A01
--------------	----	----	-----	-----	----	----	-----	-----	-----------	-----

achter-arrière-rear-Hinten

A124T074ZA76	90	C/11/5	800	800	32	32	157	204		A01A
A124T074ZA75	90	C/11	800	800	32	32	157	144	C/10+1/14+10/12	A01
A124T074HA80	90	5	595	595	--	--	100	60	5/12	A08

BESTELNR N° COMMANDE ORDER NR BESTELNR	BR LRG WID BR	BLADEN LAMES LEAVES BLATT.	B	C	D1	D2	PH FL FA SP	PAK EP TH PAK	DETAIL	MOD	OPMERKINGEN REMARQUES REMARKS BEMERKUNGEN
---	------------------------	-------------------------------------	---	---	----	----	----------------------	------------------------	--------	-----	--

SERIE : GR

GR250A

voor-avant-front-Vorne

A124T067ZA75	90	13	775	775	28	28	220	119	2/10+11/9	A01
--------------	----	----	-----	-----	----	----	-----	-----	-----------	-----

achter-arrière-rear-Hinten

A	A124T074ZA76	90	C/11/5	800	800	32	32	157	204		A01A
A	A124T074ZA75	90	C/11	800	800	32	32	157	144	C/10+1/14+10/12	A01
H	A124T074HA80	90	5	595	595	--	--	100	60	5/12	A08

GR260

voor-avant-front-Vorne

A124T043ZA75	100	13	825	825	32	32	245	118	1/10+12/9	A01
--------------	-----	----	-----	-----	----	----	-----	-----	-----------	-----

achter-arrière-rear-Hinten

A	A124T054ZA76	100	8/P/5	825	1000	32	--	225	184	8/14+5/12+P/12	A03A
A	A124T054ZA75	100	8	825	1000	32	--	225	112	8/14	A03
H	A124T054HA80	100	5/P	665	665	--	--	132	72	5/12+P/12	A08

GR280

voor-avant-front-Vorne

A124T043ZA75	100	13	825	825	32	32	245	118	1/10+12/9	A01
A124T099ZA75	100	13	825	825	32	32	240	119	1/11+12/9	A01

achter-arrière-rear-Hinten

A	A124T054ZA76	100	8/P/5	825	1000	32	--	225	184	8/14+5/12+P/12	A03A
A	A124T054ZA75	100	8	825	1000	32	--	225	112	8/14	A03
H	A124T054HA80	100	5/P	665	665	--	--	132	72	5/12+P/12	A08

BESTELNR N° COMMANDE ORDER NR BESTELNR	BR LRG WID BR	BLADEN LAMES LEAVES BLATT.	B	C	D1	D2	PH FL FA SP	PAK EP TH PAK	DETAIL	MOD	OPMERKINGEN REMARQUES REMARKS BEMERKUNGEN
---	------------------------	-------------------------------------	---	---	----	----	----------------------	------------------------	--------	-----	--

SERIE : GR**GR280A****voor-avant-front-Vorne**

A124T043ZA75	100	13	825	825	32	32	245	118	1/10+12/9	A01
--------------	-----	----	-----	-----	----	----	-----	-----	-----------	-----

achter-arrière-rear-Hinten

A	A124T054ZA76	100	8/P/5	825	1000	32	--	225	184	8/14+5/12+P/12	A03A
	A124T054ZA75	100	8	825	1000	32	--	225	112	8/14	A03
H	A124T054HA80	100	5/P	665	665	--	--	132	72	5/12+P/12	A08

GR280B**voor-avant-front-Vorne**

A124T043ZA75	100	13	825	825	32	32	245	118	1/10+12/9	A01
--------------	-----	----	-----	-----	----	----	-----	-----	-----------	-----

achter-arrière-rear-Hinten

A	A124T054ZA76	100	8/P/5	825	1000	32	--	225	184	8/14+5/12+P/12	A03A
	A124T054ZA75	100	8	825	1000	32	--	225	112	8/14	A03
H	A124T054HA80	100	5/P	665	665	--	--	132	72	5/12+P/12	A08

GR280T**voor-avant-front-Vorne**

A124T099ZA75	100	13	825	825	32	32	240	119	1/11+12/9	A01
A124T043ZA75	100	13	825	825	32	32	245	118	1/10+12/9	A01

achter-arrière-rear-Hinten

A	A124T070ZA76	100	12/P/5	875	1050	32	--	95	228	12/13+5/12+P/12	A03A
	A124T070ZA75	100	12	875	1000	32	--	95	156	12/13	A03
H	A124T070HA80	100	5/P	665	665	--	--	55	72	5/12+P/12	A08

BESTELNR N° COMMANDE ORDER NR BESTELLNR	BR LRG WID BR	BLADEN LAMES LEAVES BLATT.	B	C	D1	D2	PH FL FA SP	PAK EP TH PAK	DETAIL	MOD	OPMERKINGEN REMARKS REMARKS BEMERKUNGEN
--	------------------------	-------------------------------------	---	---	----	----	----------------------	------------------------	--------	-----	--

SERIE : GR**GR305****voor-avant-front-Vorne**

A124T099ZA75	100	13	825	825	32	32	240	119	1/11+12/9	A01
A124T043ZA75	100	13	825	825	32	32	245	118	1/10+12/9	A01

achter-arrière-rear-Hinten

A	A124T054ZA76	100	8/P/5	825	1000	32	--	225	184	8/14+5/12+P/12	A03A
	A124T054ZA75	100	8	825	1000	32	--	225	112	8/14	A03
H	A124T054HA80	100	5/P	665	665	--	--	132	72	5/12+P/12	A08

GR320**voor-avant-front-Vorne**

A124T043ZA75	100	13	825	825	32	32	245	118	1/10+12/9	A01
--------------	-----	----	-----	-----	----	----	-----	-----	-----------	-----

achter-arrière-rear-Hinten

A124T024ZB75	100	12	875	1050	32	--	200	156	12/13	A03
--------------	-----	----	-----	------	----	----	-----	-----	-------	-----

GR320B**voor-avant-front-Vorne**

A124T043ZA75	100	13	825	825	32	32	245	118	1/10+12/9	A01
A124T099ZA75	100	13	825	825	32	32	240	119	1/11+12/9	A01

achter-arrière-rear-Hinten

A	A124T054ZA76	100	8/P/5	825	1000	32	--	225	184	8/14+5/12+P/12	A03A
	A124T054ZA75	100	8	825	1000	32	--	225	112	8/14	A03
H	A124T054HA80	100	5/P	665	665	--	--	132	72	5/12+P/12	A08

BESTELNR N° COMMANDE ORDER NR BESTELLNR	BR LRG WID BR	BLADEN LAMES LEAVES BLATT.	B	C	D1	D2	PH FL FA SP	PAK EP TH PAK	DETAIL	MOD	OPMERKINGEN REMARQUES REMARKS BEMERKUNGEN
--	------------------------	-------------------------------------	---	---	----	----	----------------------	------------------------	--------	-----	--

SERIE : GR

GR350

voor-avant-front-Vorne

A124T043ZA75	100	13	825	825	32	32	245	118	1/10+12/9	A01
A124T099ZA75	100	13	825	825	32	32	240	119	1/11+12/9	A01

achter-arrière-rear-Hinten

A	A124T054ZA76	100	8/P/5	825	1000	32	--	225	184	8/14+5/12+P/12	A03A
	A124T054ZA75	100	8	825	1000	32	--	225	112	8/14	A03
H	A124T054HA80	100	5/P	665	665	--	--	132	72	5/12+P/12	A08

BESTELNR N° COMMANDE ORDER NR BESTELLNR	BR LRG WID BR	BLADEN LAMES LEAVES BLATT.	B	C	D1	D2	PH FL FA SP	PAK EP TH PAK	DETAIL	MOD	OPMERKINGEN REMARQUES REMARKS BEMERKUNGEN
--	------------------------	-------------------------------------	---	---	----	----	----------------------	------------------------	--------	-----	--

SERIE : GRH**GRH235 6x4****voor-avant-front-Vorne**

A124T143ZA75	90	10	820	820	28	28	160	120	1/14+8/12+1/10	A01
--------------	----	----	-----	-----	----	----	-----	-----	----------------	-----

achter-arrière-rear-Hinten

A124T082ZA70	100	7/P	755	755	--	--	53	175	7/23.5+P/10	A08R
--------------	-----	-----	-----	-----	----	----	----	-----	-------------	------

GRH235R 6x4**voor-avant-front-Vorne**

A124T143ZA75	90	10	820	820	28	28	160	120	1/14+8/12+1/10	A01
--------------	----	----	-----	-----	----	----	-----	-----	----------------	-----

achter-arrière-rear-Hinten

A124T082ZA70	100	7/P	755	755	--	--	53	175	7/23.5+P/10	A08R
--------------	-----	-----	-----	-----	----	----	----	-----	-------------	------

GRH305 6x4**voor-avant-front-Vorne**

A124T043ZA75	100	13	825	825	32	32	245	118	1/10+12/9	A01
A124T099ZA75	100	13	825	825	32	32	240	119	1/11+12/9	A01

GRH350 6x4**voor-avant-front-Vorne**

A124T043ZA75	100	13	825	825	32	32	245	118	1/10+12/9	A01
A124T099ZA75	100	13	825	825	32	32	240	119	1/11+12/9	A01

BESTELNR N° COMMANDE ORDER NR BESTELNR	BR LRG WID BR	BLADEN LAMES LEAVES BLATT.	B	C	D1	D2	PH FL FA SP	PAK EP TH PAK	DETAIL	MOD	OPMERKINGEN REMARQUES REMARKS BEMERKUNGEN
---	------------------------	-------------------------------------	---	---	----	----	----------------------	------------------------	--------	-----	--

SERIE : KERAX**KER 4x2****Truck - Porteur - Rigid****voor-avant-front-Vorne**

A124T277ZA75	90	8	820	820	28	20		120	8/15	A01
F023T065ZA75	90	3	820	820	28	20	130	84	3/25	F01.10

achter-arrière-rear-Hinten

A	A124T298ZA76	90	8/10	825	670	36	36		212	8/14+10/10	A01A
	A124T298ZA75	90	8	0	0	36	36		112	8/14	A01
H	A124T298HA80	90	10	0	0	--	--		100	10/10	A08
A	A124T156ZA76	90	9/P/7	825	1000	36	--	115	222	9/14+8/12	A03A
	A124T156ZA75	90	9	825	1000	36	--	115	126	9/14	A03
H	A124T156HA80	90	7/P	650	650	--	--	63	96	7/12+P/12	A08
	F023T180ZA75	90	4	825	1000	36	--	132	120	4/28	F03

Trekker - Tracteur - Tractor**voor-avant-front-Vorne**

A124T277ZA75	90	8	820	820	28	20		120	8/15	A01
F023T065ZA75	90	3	820	820	28	20	130	84	3/25	F01.10

achter-arrière-rear-Hinten

A	A124T156ZA76	90	9/P/7	825	1000	36	--	115	222	9/14+8/12	A03A
	A124T156ZA75	90	9	825	1000	36	--	115	126	9/14	A03
H	A124T156HA80	90	7/P	650	650	--	--	63	96	7/12+P/12	A08
	F023T180ZA75	90	4	825	1000	36	--	132	120	4/28	F03

BESTELNR N° COMMANDE ORDER NR BESTELNR	BR LRG WID BR	BLADEN LAMES LEAVES BLATT.	B	C	D1	D2	PH FL FA SP	PAK EP TH PAK	DETAIL	MOD	OPMERKINGEN REMARQUES REMARKS BEMERKUNGEN
---	------------------------	-------------------------------------	---	---	----	----	----------------------	------------------------	--------	-----	--

SERIE : KERAX**KER 6x4****Truck - Porteur - Rigid****voor-avant-front-Vorne**

A124T277ZA75	90	8	820	820	28	20		120	8/15	A01
A124T279ZA75	90	8	820	820	28	20		120	8/15	A01
F023T065ZA75	90	3	820	820	28	20	130	84	3/25	F01.10

achter-arrière-rear-Hinten

A124T082ZA70	100	7/P	755	755	--	--	53	175	7/23.5+P/10	A08R
A124T292ZA70	100	9/P	790	790	--	--	64	235	9/25+P/10	A08R
F023T094ZA70	100	3	785	785	--	--	60	136	3/38	F08R

Trekker - Tracteur - Tractor**voor-avant-front-Vorne**

A124T279ZA75	90	8	820	820	28	20		120	8/15	A01
--------------	----	---	-----	-----	----	----	--	-----	------	-----

achter-arrière-rear-Hinten

A124T292ZA70	100	9/P	790	790	--	--	64	235	9/25+P/10	A08R
--------------	-----	-----	-----	-----	----	----	----	-----	-----------	------

KER 8x4**Truck - Porteur - Rigid****voor-avant-front-Vorne**

A124T277ZA75	90	8	820	820	28	20		120	8/15	A01
F023T065ZA75	90	3	820	820	28	20	130	84	3/25	F01.10

achter-arrière-rear-Hinten

A124T082ZA70	100	7/P	755	755	--	--	53	175	7/23.5+P/10	A08R
A124T292ZA70	100	9/P	790	790	--	--	64	235	9/25+P/10	A08R
A124T300ZA70	100	11/P	880	880	--	--		285	11/25+P/10	A08R
F023T094ZA70	100	3	785	785	--	--	60	136	3/38	F08R

BESTELNR N° COMMANDE ORDER NR BESTELNR	BR LRG WID BR	BLADEN LAMES LEAVES BLATT.	B	C	D1	D2	PH FL FA SP	PAK EP TH PAK	DETAIL	MOD	OPMERKINGEN REMARQUES REMARKS BEMERKUNGEN
---	------------------------	-------------------------------------	---	---	----	----	----------------------	------------------------	--------	-----	--

SERIE : MASCOTT**3,5 T CABINE****voor-avant-front-Vorne**

F023T137ZA75	60	2	700	820	S16	S16		0			F01.10
--------------	----	---	-----	-----	-----	-----	--	---	--	--	--------

achter-arrière-rear-Hinten

F023T204ZA75	60	1/P	782	775	S16	S16		0	1/28+P/24	F01	Silentbloc
F023T208ZA75	60	1/1	782	775	S16	S16		0	1/20+1/32	F01	Silentbloc
F023T206ZA75	60	2/1	775	775	S16	S16		0	1/14+1/13+1/32	F01.10	
F023T140ZA75	60	2/1	775	775	S16	S16		68	2/13+1/31	F01B	
F023T258ZA75	60	1/1	820	820	S16	S16		0	1/23+1/34	F01B.70	

3,5 T CABINE SURBAISSEE**voor-avant-front-Vorne**

F023T139ZA75	60	2	700	820	S16	S16		0			F01.10
--------------	----	---	-----	-----	-----	-----	--	---	--	--	--------

achter-arrière-rear-Hinten

F023T202ZA75	60	3	775	775	S16	S16		0			F01.10
--------------	----	---	-----	-----	-----	-----	--	---	--	--	--------

5,5 T FOURGON**voor-avant-front-Vorne**

F023T129ZA75	60	2	700	820	S16	S16		0			F01.10
--------------	----	---	-----	-----	-----	-----	--	---	--	--	--------

achter-arrière-rear-Hinten

F023T206ZA75	60	2/1	775	775	S16	S16		0	1/14+1/13+1/32	F01.10	
--------------	----	-----	-----	-----	-----	-----	--	---	----------------	--------	--

5,5-6,5 T**achter-arrière-rear-Hinten**

F023T278ZA75	60	1/1	820	820	S16	S16	155	65	1/23+1/38	F01B.70	
--------------	----	-----	-----	-----	-----	-----	-----	----	-----------	---------	--

BESTELNR N° COMMANDE ORDER NR BESTELNR	BR LRG WID BR	BLADEN LAMES LEAVES BLATT.	B	C	D1	D2	PH FL FA SP	PAK EP TH PAK	DETAIL	MOD	OPMERKINGEN REMARQUES REMARKS BEMERKUNGEN
---	------------------------	-------------------------------------	---	---	----	----	----------------------	------------------------	--------	-----	--

SERIE : MASCOTT

5,5-6,5 T CABINE

voor-avant-front-Vorne

F023T131ZA75	60	2	700	820	S16	S16		0			F01.10
--------------	----	---	-----	-----	-----	-----	--	---	--	--	--------

achter-arrière-rear-Hinten

F023T138ZA75	60	2/1	775	775	S16	S16	182	73	1/16+1/13+1/35		F01B
F023T274ZA75	60	3	820	820	S16	S16					F01B.70

BESTELNR N° COMMANDE ORDER NR BESTELLNR	BR LRG WID BR	BLADEN LAMES LEAVES BLATT.	B	C	D1	D2	PH FL FA SP	PAK EP TH PAK	DETAIL	MOD	OPMERKINGEN REMARQUES REMARKS BEMERKUNGEN
--	------------------------	-------------------------------------	---	---	----	----	----------------------	------------------------	--------	-----	--

SERIE : MASCOTT2**3,5 - 5,0 T****achter-arrière-rear-Hinten**

F023T258ZA75	60	1/1	820	820	S16	S16		0	1/23+1/34	F01B.70
--------------	----	-----	-----	-----	-----	-----	--	---	-----------	---------

3,5 T SURBAISSEE**achter-arrière-rear-Hinten**

F023T276ZA75	60	1/1	820	820	S16	S16		0		F01B.70
--------------	----	-----	-----	-----	-----	-----	--	---	--	---------

5,5 - 6,0 T**achter-arrière-rear-Hinten**

F023T278ZA75	60	1/1	820	820	S16	S16	155	65	1/23+1/38	F01B.70
--------------	----	-----	-----	-----	-----	-----	-----	----	-----------	---------

BESTELNR N° COMMANDE ORDER NR BESTELNR	BR LRG WID BR	BLADEN LAMES LEAVES BLATT.	B	C	D1	D2	PH FL FA SP	PAK EP TH PAK	DETAIL	MOD	OPMERKINGEN REMARQUES REMARKS BEMERKUNGEN
---	------------------------	-------------------------------------	---	---	----	----	----------------------	------------------------	--------	-----	--

SERIE : MASTER

OLD ALL

achter-arrière-rear-Hinten

F023T070ZA75	70	1	685	685	S22	S16	90	23	1/23	F01
F023T142ZA75	70	2	685	685	S22	S16	116	36	2/16	F01.10
F023T028ZA75	70	1/1	685	685	S22	S16	175	33	1/14+1/19	F01B

BESTELNR N° COMMANDE ORDER NR BESTELNR	BR LRG WID BR	BLADEN LAMES LEAVES BLATT.	B	C	D1	D2	PH FL FA SP	PAK EP TH PAK	DETAIL	MOD	OPMERKINGEN REMARQUES REMARKS BEMERKUNGEN
---	------------------------	-------------------------------------	---	---	----	----	----------------------	------------------------	--------	-----	--

SERIE : MASTER 1997**2,8 T****achter-arrière-rear-Hinten**

F023T250ZA75	70	1	710	710	40	40	90	30	1/30	F01.70	Plastic
F023T262ZA75	70	1	715	715	S14	S16	127	18	1/18	F01.70	

3,3 - 3,5 T**achter-arrière-rear-Hinten**

F023T250ZA75	70	1	710	710	40	40	90	30	1/30	F01.70	Plastic
F023T196ZA75	70	2	715	715	S14	S16	106	36	1/14+1/21	F01B	

MONOLAME**achter-arrière-rear-Hinten**

F023T194ZA75	70	1	715	715	S14	S16	100	22	1/22	F01.70	
--------------	----	---	-----	-----	-----	-----	-----	----	------	--------	--

PNEUM**achter-arrière-rear-Hinten**

F023T260ZA75	70	1	715	715	S16	S14	80/88	18	1/15	F01.70	
--------------	----	---	-----	-----	-----	-----	-------	----	------	--------	--

VERHOOGD**achter-arrière-rear-Hinten**

F023T268ZA75	70	2	715	715	S14	S16		36	1/14+1/21	F01B	
--------------	----	---	-----	-----	-----	-----	--	----	-----------	------	--

BESTELNR N° COMMANDE ORDER NR BESTELNR	BR LRG WID BR	BLADEN LAMES LEAVES BLATT.	B	C	D1	D2	PH FL FA SP	PAK EP TH PAK	DETAIL	MOD	OPMERKINGEN REMARQUES REMARKS BEMERKUNGEN
---	------------------------	-------------------------------------	---	---	----	----	----------------------	------------------------	--------	-----	--

SERIE : MASTER2 2003**2,8 T****achter-arrière-rear-Hinten**

F023T250ZA75	70	1	710	710	40	40	90	30	1/30	F01.70	Plastic
F023T262ZA75	70	1	715	715	S14	S16	127	18	1/18	F01.70	

3,3 - 3,5 T**achter-arrière-rear-Hinten**

F023T250ZA75	70	1	710	710	40	40	90	30	1/30	F01.70	Plastic
F023T268ZA75	70	2	715	715	S14	S16		36	1/14+1/21	F01B	
F023T196ZA75	70	2	715	715	S14	S16	106	36	1/14+1/21	F01B	

MONOLAME**achter-arrière-rear-Hinten**

F023T270ZA75	70	1	715	715	S14	S16		19	1/19	F01.70	
F023T272ZA75	70	1	715	715	S14	S16		22	1/22	F01.70	
F023T194ZA75	70	1	715	715	S14	S16	100	22	1/22	F01.70	

PNEUM**achter-arrière-rear-Hinten**

F023T260ZA75	70	1	715	715	S16	S14	80/88	18	1/15	F01.70	
--------------	----	---	-----	-----	-----	-----	-------	----	------	--------	--

VERHOOGD**achter-arrière-rear-Hinten**

F023T268ZA75	70	2	715	715	S14	S16		36	1/14+1/21	F01B	
--------------	----	---	-----	-----	-----	-----	--	----	-----------	------	--

BESTELNR N° COMMANDE ORDER NR BESTELNR	BR LRG WID BR	BLADEN LAMES LEAVES BLATT.	B	C	D1	D2	PH FL FA SP	PAK EP TH PAK	DETAIL	MOD	OPMERKINGEN REMARQUES REMARKS BEMERKUNGEN
---	------------------------	-------------------------------------	---	---	----	----	----------------------	------------------------	--------	-----	--

SERIE : MIDLINER-M

M 140

Truck - Porteur - Rigid

voor-avant-front-Vorne

F023T051ZA75	80	2	1000	1155	S16	--	115	70	2/32	F03	Silentbloc
F023T049ZA75	80	1	1000	1055	S16	--	120	38	1/38	F03.02	Silentbloc

achter-arrière-rear-Hinten

F023T108ZA75	80	2/P	795	705	S20	--	100	127	2/31+P/59	F03	Silentbloc
F023T098ZA75	80	2/1/P	900	1060	S20	--	155	127	2/24+1/35+P/35	F03B	Silentbloc
F023T096ZA75	80	2/1/P	900	1060	S20	--	155	127	2/24+1/35+P/35	F03B	Silentbloc
F023T116ZA75	80	2/1/P	900	1060	S20	--	142	127	2/32+1/40+P/14	F03B	Silentbloc
F023T110ZA75	0	1	0	0		--		0	0	Z	

Trekker - Tracteur - Tractor

voor-avant-front-Vorne

F023T051ZA75	80	2	1000	1155	S16	--	115	70	2/32	F03	Silentbloc
F023T049ZA75	80	1	1000	1055	S16	--	120	38	1/38	F03.02	Silentbloc

achter-arrière-rear-Hinten

F023T108ZA75	80	2/P	795	705	S20	--	100	127	2/31+P/59	F03	Silentbloc
F023T096ZA75	80	2/1/P	900	1060	S20	--	155	127	2/24+1/35+P/35	F03B	Silentbloc
F023T098ZA75	80	2/1/P	900	1060	S20	--	155	127	2/24+1/35+P/35	F03B	Silentbloc
F023T116ZA75	80	2/1/P	900	1060	S20	--	142	127	2/32+1/40+P/14	F03B	Silentbloc
F023T110ZA75	0	1	0	0		--		0	0	Z	

BESTELNR N° COMMANDE ORDER NR BESTELNR	BR LRG WID BR	BLADEN LAMES LEAVES BLATT.	B	C	D1	D2	PH FL FA SP	PAK EP TH PAK	DETAIL	MOD	OPMERKINGEN REMARQUES REMARKS BEMERKUNGEN
---	------------------------	-------------------------------------	---	---	----	----	----------------------	------------------------	--------	-----	--

SERIE : MIDLINER-M

M 150

Truck - Porteur - Rigid

voor-avant-front-Vorne

F023T091ZA75	80	2	1000	855	S20	--		54	2/24+2P/3	F03	Silentbloc
F023T051ZA75	80	2	1000	1155	S16	--	115	70	2/32	F03	Silentbloc
F023T087ZA75	80	1/P	1000	1050	S16	--		65	1/40+P/22+P/3	F03.02	Silentbloc
F023T049ZA75	80	1	1000	1055	S16	--	120	38	1/38	F03.02	Silentbloc
F023T093ZA75	80	2	1000	855	S20	--		54	2/24+2P/3	F03.10	glijdop/pastille
F023T089ZA75	80	2	1000	1155	S16	--		66	2/30	F03.10	
F023T097ZA75	80	2	1000	1155	S16	--		66	2/30+2P/3	F03.10	glijdop/pastille

achter-arrière-rear-Hinten

F023T108ZA75	80	2/P	795	705	S20	--	100	127	2/31+P/59	F03	Silentbloc
F023T114ZA76	80	2/2/P	900	1060	S20	--		188	2/35+2/27+P	F03A	Silentbloc
F023T162ZA75	80	2/1/P	900	960	S20	--		117	2/28+1/36+P/25	F03B	Silentbloc
F023T116ZA75	80	2/1/P	900	1060	S20	--	142	127	2/32+1/40+P/14	F03B	Silentbloc
F023T096ZA75	80	2/1/P	900	1060	S20	--	155	127	2/24+1/35+P/35	F03B	Silentbloc
F023T112ZA75	80	2/1/P	900	1060	S20	--		128	2/26+1/37+P/30	F03B	Silentbloc
F023T110ZA75	0	1	0	0		--		0	0	Z	

BESTELNR N° COMMANDE ORDER NR BESTELNR	BR LRG WID BR	BLADEN LAMES LEAVES BLATT.	B	C	D1	D2	PH FL FA SP	PAK EP TH PAK	DETAIL	MOD	OPMERKINGEN REMARQUES REMARKS BEMERKUNGEN
---	------------------------	-------------------------------------	---	---	----	----	----------------------	------------------------	--------	-----	--

SERIE : MIDLINER-M

M 160

Truck - Porteur - Rigid

voor-avant-front-Vorne

F023T051ZA75	80	2	1000	1155	S16	--	115	70	2/32	F03	Silentbloc
F023T049ZA75	80	1	1000	1055	S16	--	120	38	1/38	F03.02	Silentbloc

achter-arrière-rear-Hinten

F023T108ZA75	80	2/P	795	705	S20	--	100	127	2/31+P/59	F03	Silentbloc
F023T116ZA75	80	2/1/P	900	1060	S20	--	142	127	2/32+1/40+P/14	F03B	Silentbloc
F023T096ZA75	80	2/1/P	900	1060	S20	--	155	127	2/24+1/35+P/35	F03B	Silentbloc
F023T098ZA75	80	2/1/P	900	1060	S20	--	155	127	2/24+1/35+P/35	F03B	Silentbloc
F023T110ZA75	0	1	0	0		--		0	0	Z	

Trekker - Tracteur - Tractor

voor-avant-front-Vorne

F023T051ZA75	80	2	1000	1155	S16	--	115	70	2/32	F03	Silentbloc
F023T049ZA75	80	1	1000	1055	S16	--	120	38	1/38	F03.02	Silentbloc

achter-arrière-rear-Hinten

F023T108ZA75	80	2/P	795	705	S20	--	100	127	2/31+P/59	F03	Silentbloc
F023T098ZA75	80	2/1/P	900	1060	S20	--	155	127	2/24+1/35+P/35	F03B	Silentbloc
F023T096ZA75	80	2/1/P	900	1060	S20	--	155	127	2/24+1/35+P/35	F03B	Silentbloc
F023T116ZA75	80	2/1/P	900	1060	S20	--	142	127	2/32+1/40+P/14	F03B	Silentbloc
F023T110ZA75	0	1	0	0		--		0	0	Z	

BESTELNR N° COMMANDE ORDER NR BESTELNR	BR LRG WID BR	BLADEN LAMES LEAVES BLATT.	B	C	D1	D2	PH FL FA SP	PAK EP TH PAK	DETAIL	MOD	OPMERKINGEN REMARQUES REMARKS BEMERKUNGEN
---	------------------------	-------------------------------------	---	---	----	----	----------------------	------------------------	--------	-----	--

SERIE : MIDLINER-M

M 180

Truck - Porteur - Rigid

voor-avant-front-Vorne

F023T075ZA75	80	2	1000	1155	S16	--		66	2/30+2P/3	F03	Silentbloc
F023T095ZA75	80	2	1000	1155	S16	--		66	2/30	F03	glijdop/pastille
F023T087ZA75	80	1/P	1000	1050	S16	--		65	1/40+P/22+P/3	F03.02	Silentbloc
F023T049ZA75	80	1	1000	1055	S16	--	120	38	1/38	F03.02	Silentbloc
F023T089ZA75	80	2	1000	1155	S16	--		66	2/30	F03.10	
F023T097ZA75	80	2	1000	1155	S16	--		66	2/30+2P/3	F03.10	glijdop/pastille

achter-arrière-rear-Hinten

F023T108ZA75	80	2/P	795	705	S20	--	100	127	2/31+P/59	F03	Silentbloc
F023T114ZA76	80	2/2/P	900	1060	S20	--		188	2/35+2/27+P	F03A	Silentbloc
F023T162ZA75	80	2/1/P	900	960	S20	--		117	2/28+1/36+P/25	F03B	Silentbloc
F023T112ZA75	80	2/1/P	900	1060	S20	--		128	2/26+1/37+P/30	F03B	Silentbloc
F023T096ZA75	80	2/1/P	900	1060	S20	--	155	127	2/24+1/35+P/35	F03B	Silentbloc
F023T116ZA75	80	2/1/P	900	1060	S20	--	142	127	2/32+1/40+P/14	F03B	Silentbloc
F023T110ZA75	0	1	0	0		--		0	0	Z	

M 180FPT

Truck - Porteur - Rigid

voor-avant-front-Vorne

A025T087ZA75	80	8	785	915	25	--		113	5/13+3/16	A03t	
A025T061ZA75	80	7/2/P	785	950	25	--	152	108	7/10+2/11+P/16	A03tB	
A025T061AA75	80	7/2/2P	785	950	25	--	152	116	7/10+2/11+P/16+	A03tB	

achter-arrière-rear-Hinten

A025T108ZA75	80	9	800	935	30	--		126	9/14	A03t	
A025T110ZA75	80	9	800	935	30	--		126	9/14	A03t	
A025T082ZA76	80	9/10	800	935	30	--	126	236		A03tA	
A025T082ZA75	80	9	800	935	30	--	126	126	9/14	A03t	
A025T082HA80	80	10	690	690	--	--	81	110	10/11	A08	
A025T090ZA76	80	9/10	800	935	30	--	126	234	1/12+8/14+10/11	A03tA	
A025T090ZA75	80	9	800	935	30	--	126	124	1/12+8/14	A03t	
A025T090HA80	80	10	690	690	--	--	81	110	10/11	A08	

BESTELNR N° COMMANDE ORDER NR BESTELNR	BR LRG WID BR	BLADEN LAMES LEAVES BLATT.	B	C	D1	D2	PH FL FA SP	PAK EP TH PAK	DETAIL	MOD	OPMERKINGEN REMARQUES REMARKS BEMERKUNGEN
---	------------------------	-------------------------------------	---	---	----	----	----------------------	------------------------	--------	-----	--

SERIE : MIDLINER-M

M 200

Truck - Porteur - Rigid

voor-avant-front-Vorne

F023T075ZA75	80	2	1000	1155	S16	--		66	2/30+2P/3	F03	Silentbloc
--------------	----	---	------	------	-----	----	--	----	-----------	-----	------------

achter-arrière-rear-Hinten

F023T114ZA76	80	2/2/P	900	1060	S20	--		188	2/35+2/27+P	F03A	Silentbloc
--------------	----	-------	-----	------	-----	----	--	-----	-------------	------	------------

F023T112ZA75	80	2/1/P	900	1060	S20	--		128	2/26+1/37+P/30	F03B	Silentbloc
--------------	----	-------	-----	------	-----	----	--	-----	----------------	------	------------

M 210

Truck - Porteur - Rigid

voor-avant-front-Vorne

F023T075ZA75	80	2	1000	1155	S16	--		66	2/30+2P/3	F03	Silentbloc
--------------	----	---	------	------	-----	----	--	----	-----------	-----	------------

F023T095ZA75	80	2	1000	1155	S16	--		66	2/30	F03	glijdop/pastille
--------------	----	---	------	------	-----	----	--	----	------	-----	------------------

F023T087ZA75	80	1/P	1000	1050	S16	--		65	1/40+P/22+P/3	F03.02	Silentbloc
--------------	----	-----	------	------	-----	----	--	----	---------------	--------	------------

F023T049ZA75	80	1	1000	1055	S16	--	120	38	1/38	F03.02	Silentbloc
--------------	----	---	------	------	-----	----	-----	----	------	--------	------------

F023T089ZA75	80	2	1000	1155	S16	--		66	2/30	F03.10	
--------------	----	---	------	------	-----	----	--	----	------	--------	--

F023T097ZA75	80	2	1000	1155	S16	--		66	2/30+2P/3	F03.10	glijdop/pastille
--------------	----	---	------	------	-----	----	--	----	-----------	--------	------------------

achter-arrière-rear-Hinten

F023T108ZA75	80	2/P	795	705	S20	--	100	127	2/31+P/59	F03	Silentbloc
--------------	----	-----	-----	-----	-----	----	-----	-----	-----------	-----	------------

F023T114ZA76	80	2/2/P	900	1060	S20	--		188	2/35+2/27+P	F03A	Silentbloc
--------------	----	-------	-----	------	-----	----	--	-----	-------------	------	------------

F023T162ZA75	80	2/1/P	900	960	S20	--		117	2/28+1/36+P/25	F03B	Silentbloc
--------------	----	-------	-----	-----	-----	----	--	-----	----------------	------	------------

F023T112ZA75	80	2/1/P	900	1060	S20	--		128	2/26+1/37+P/30	F03B	Silentbloc
--------------	----	-------	-----	------	-----	----	--	-----	----------------	------	------------

F023T096ZA75	80	2/1/P	900	1060	S20	--	155	127	2/24+1/35+P/35	F03B	Silentbloc
--------------	----	-------	-----	------	-----	----	-----	-----	----------------	------	------------

F023T116ZA75	80	2/1/P	900	1060	S20	--	142	127	2/32+1/40+P/14	F03B	Silentbloc
--------------	----	-------	-----	------	-----	----	-----	-----	----------------	------	------------

F023T110ZA75	0	1	0	0		--		0	0	Z	
--------------	---	---	---	---	--	----	--	---	---	---	--

M 230

Truck - Porteur - Rigid

voor-avant-front-Vorne

F023T075ZA75	80	2	1000	1155	S16	--		66	2/30+2P/3	F03	Silentbloc
--------------	----	---	------	------	-----	----	--	----	-----------	-----	------------

achter-arrière-rear-Hinten

F023T114ZA76	80	2/2/P	900	1060	S20	--		188	2/35+2/27+P	F03A	Silentbloc
--------------	----	-------	-----	------	-----	----	--	-----	-------------	------	------------

F023T112ZA75	80	2/1/P	900	1060	S20	--		128	2/26+1/37+P/30	F03B	Silentbloc
--------------	----	-------	-----	------	-----	----	--	-----	----------------	------	------------

BESTELNR N° COMMANDE ORDER NR BESTELNR	BR LRG WID BR	BLADEN LAMES LEAVES BLATT.	B	C	D1	D2	PH FL FA SP	PAK EP TH PAK	DETAIL	MOD	OPMERKINGEN REMARQUES REMARKS BEMERKUNGEN
---	------------------------	-------------------------------------	---	---	----	----	----------------------	------------------------	--------	-----	--

SERIE : MIDLINER-M**M 230TI****Truck - Porteur - Rigid****voor-avant-front-Vorne**

F023T095ZA75	80	2	1000	1155	S16	--		66	2/30	F03	glijdop/pastille
F023T075ZA75	80	2	1000	1155	S16	--		66	2/30+2P/3	F03	Silentbloc
F023T087ZA75	80	1/P	1000	1050	S16	--		65	1/40+P/22+P/3	F03.02	Silentbloc
F023T049ZA75	80	1	1000	1055	S16	--	120	38	1/38	F03.02	Silentbloc
F023T097ZA75	80	2	1000	1155	S16	--		66	2/30+2P/3	F03.10	glijdop/pastille
F023T089ZA75	80	2	1000	1155	S16	--		66	2/30	F03.10	

achter-arrière-rear-Hinten

F023T108ZA75	80	2/P	795	705	S20	--	100	127	2/31+P/59	F03	Silentbloc
F023T114ZA76	80	2/2/P	900	1060	S20	--		188	2/35+2/27+P	F03A	Silentbloc
F023T162ZA75	80	2/1/P	900	960	S20	--		117	2/28+1/36+P/25	F03B	Silentbloc
F023T112ZA75	80	2/1/P	900	1060	S20	--		128	2/26+1/37+P/30	F03B	Silentbloc
F023T096ZA75	80	2/1/P	900	1060	S20	--	155	127	2/24+1/35+P/35	F03B	Silentbloc
F023T116ZA75	80	2/1/P	900	1060	S20	--	142	127	2/32+1/40+P/14	F03B	Silentbloc
F023T110ZA75	0	1	0	0		--		0	0	Z	

Trekker - Tracteur - Tractor**voor-avant-front-Vorne**

F023T087ZA75	80	1/P	1000	1050	S16	--		65	1/40+P/22+P/3	F03.02	Silentbloc
F023T049ZA75	80	1	1000	1055	S16	--	120	38	1/38	F03.02	Silentbloc
F023T097ZA75	80	2	1000	1155	S16	--		66	2/30+2P/3	F03.10	glijdop/pastille
F023T089ZA75	80	2	1000	1155	S16	--		66	2/30	F03.10	

achter-arrière-rear-Hinten

F023T108ZA75	80	2/P	795	705	S20	--	100	127	2/31+P/59	F03	Silentbloc
F023T114ZA76	80	2/2/P	900	1060	S20	--		188	2/35+2/27+P	F03A	Silentbloc
F023T162ZA75	80	2/1/P	900	960	S20	--		117	2/28+1/36+P/25	F03B	Silentbloc
F023T096ZA75	80	2/1/P	900	1060	S20	--	155	127	2/24+1/35+P/35	F03B	Silentbloc
F023T112ZA75	80	2/1/P	900	1060	S20	--		128	2/26+1/37+P/30	F03B	Silentbloc
F023T116ZA75	80	2/1/P	900	1060	S20	--	142	127	2/32+1/40+P/14	F03B	Silentbloc
F023T110ZA75	0	1	0	0		--		0	0	Z	

BESTELNR N° COMMANDE ORDER NR BESTELNR	BR LRG WID BR	BLADEN LAMES LEAVES BLATT.	B	C	D1	D2	PH FL FA SP	PAK EP TH PAK	DETAIL	MOD	OPMERKINGEN REMARQUES REMARKS BEMERKUNGEN
---	------------------------	-------------------------------------	---	---	----	----	----------------------	------------------------	--------	-----	--

SERIE : MIDLINER-M

M 250

Truck - Porteur - Rigid

voor-avant-front-Vorne

F023T095ZA75	80	2	1000	1155	S16	--		66	2/30	F03	glijdop/pastille
F023T075ZA75	80	2	1000	1155	S16	--		66	2/30+2P/3	F03	Silentbloc
F023T087ZA75	80	1/P	1000	1050	S16	--		65	1/40+P/22+P/3	F03.02	Silentbloc
F023T049ZA75	80	1	1000	1055	S16	--	120	38	1/38	F03.02	Silentbloc
F023T097ZA75	80	2	1000	1155	S16	--		66	2/30+2P/3	F03.10	glijdop/pastille
F023T089ZA75	80	2	1000	1155	S16	--		66	2/30	F03.10	

achter-arrière-rear-Hinten

F023T108ZA75	80	2/P	795	705	S20	--	100	127	2/31+P/59	F03	Silentbloc
F023T114ZA76	80	2/2/P	900	1060	S20	--		188	2/35+2/27+P	F03A	Silentbloc
F023T162ZA75	80	2/1/P	900	960	S20	--		117	2/28+1/36+P/25	F03B	Silentbloc
F023T112ZA75	80	2/1/P	900	1060	S20	--		128	2/26+1/37+P/30	F03B	Silentbloc
F023T096ZA75	80	2/1/P	900	1060	S20	--	155	127	2/24+1/35+P/35	F03B	Silentbloc
F023T116ZA75	80	2/1/P	900	1060	S20	--	142	127	2/32+1/40+P/14	F03B	Silentbloc
F023T110ZA75	0	1	0	0		--		0	0	Z	

ME160

Truck - Porteur - Rigid

voor-avant-front-Vorne

A025T085ZA75	80	7	785	915	25	--		0		A03t	
A025T083ZA75	80	4/3/P	785	915	25	--		108	4/13+3/16+P/8	A03tB	

achter-arrière-rear-Hinten

	A025T082ZA76	80	9/10	800	935	30	--	126	236		A03tA
A	A025T082ZA75	80	9	800	935	30	--	126	126	9/14	A03t
H	A025T082HA80	80	10	690	690	--	--	81	110	10/11	A08
	A025T090ZA76	80	9/10	800	935	30	--	126	234	1/12+8/14+10/11	A03tA
A	A025T090ZA75	80	9	800	935	30	--	126	124	1/12+8/14	A03t
H	A025T090HA80	80	10	690	690	--	--	81	110	10/11	A08

BESTELNR N° COMMANDE ORDER NR BESTELLNR	BR LRG WID BR	BLADEN LAMES LEAVES BLATT.	B	C	D1	D2	PH FL FA SP	PAK EP TH PAK	DETAIL	MOD	OPMERKINGEN REMARKES REMARKS BEMERKUNGEN
--	------------------------	-------------------------------------	---	---	----	----	----------------------	------------------------	--------	-----	---

SERIE : MIDLINER-M**ME180****Truck - Porteur - Rigid****voor-avant-front-Vorne**

A025T085ZA75	80	7	785	915	25	--		0		A03t
A025T083ZA75	80	4/3/P	785	915	25	--		108	4/13+3/16+P/8	A03tB

achter-arrière-rear-Hinten

	A025T082ZA76	80	9/10	800	935	30	--	126	236		A03tA
A	A025T082ZA75	80	9	800	935	30	--	126	126	9/14	A03t
H	A025T082HA80	80	10	690	690	--	--	81	110	10/11	A08
	A025T090ZA76	80	9/10	800	935	30	--	126	234	1/12+8/14+10/11	A03tA
A	A025T090ZA75	80	9	800	935	30	--	126	124	1/12+8/14	A03t
H	A025T090HA80	80	10	690	690	--	--	81	110	10/11	A08

BESTELNR N° COMMANDE ORDER NR BESTELNR	BR LRG WID BR	BLADEN LAMES LEAVES BLATT.	B	C	D1	D2	PH FL FA SP	PAK EP TH PAK	DETAIL	MOD	OPMERKINGEN REMARQUES REMARKS BEMERKUNGEN
---	------------------------	-------------------------------------	---	---	----	----	----------------------	------------------------	--------	-----	--

SERIE : MIDLINER-S**S 90-09****Truck - Porteur - Rigid****voor-avant-front-Vorne**

A025T079ZA75	70	8	785	920	22	--		104	4/12+4/14	A03t
A025T049ZA75	70	6/2	780	940	22	--	220	84	6/10+2/12	A03tB
A025T049AA75	70	6/2/P	780	940	22	--	220	96	6/10+2/12+P/12	A03tB

achter-arrière-rear-Hinten

A025T112ZA75	70	8/2P	700	570	D25	--		116	8/12+2/10	A03t
A025T084ZA76	70	8/P/7	700	850	25	--	135	168	8/12+7/9+P/9	A03tA
A025T084ZA75	70	8	700	850	25	--	135	96	8/12	A03t
A025T084HA80	70	7/P	575	575	--	--	98	72	7/9+P/9	A08

S 100-06/07/08**Truck - Porteur - Rigid****voor-avant-front-Vorne**

A025T081ZA75	70	6	785	935	22	--		78	3/12+3/14	A03t
A124T159ZA75	70	4/2	785	950	22	--	184	64	4/10+2/12	A03tB
A124T159AA75	70	2/4/P	785	950	22	--		74	4/10+2/12+P/10	A03tB

achter-arrière-rear-Hinten

A025T112ZA75	70	8/2P	700	570	D25	--		116	8/12+2/10	A03t
A025T100ZA75	70	9	700	880	25	--		116	5/12+4/14	A03t
A025T104ZA75	70	5/4	700	860	25	--	151	97	5/9+4/13	A03tB
A124T182ZA75	70	6/4	700	880	25	--	130	116	6/10+4/14	A03tB

S 100-09**Truck - Porteur - Rigid****voor-avant-front-Vorne**

A025T079ZA75	70	8	785	920	22	--		104	4/12+4/14	A03t
--------------	----	---	-----	-----	----	----	--	-----	-----------	------

achter-arrière-rear-Hinten

A025T084ZA76	70	8/P/7	700	850	25	--	135	168	8/12+7/9+P/9	A03tA
A025T084ZA75	70	8	700	850	25	--	135	96	8/12	A03t
A025T084HA80	70	7/P	575	575	--	--	98	72	7/9+P/9	A08

BESTELNR N° COMMANDE ORDER NR BESTELNR	BR LRG WID BR	BLADEN LAMES LEAVES BLATT.	B	C	D1	D2	PH FL FA SP	PAK EP TH PAK	DETAIL	MOD	OPMERKINGEN REMARKS REMARKS BEMERKUNGEN
---	------------------------	-------------------------------------	---	---	----	----	----------------------	------------------------	--------	-----	--

SERIE : MIDLINER-S**S 110****Truck - Porteur - Rigid****voor-avant-front-Vorne**

A124T159ZA75	70	4/2	785	950	22	--	184	64	4/10+2/12	A03tB
--------------	----	-----	-----	-----	----	----	-----	----	-----------	-------

achter-arrière-rear-Hinten

A025T112ZA75	70	8/2P	700	570	D25	--		116	8/12+2/10	A03t
A025T104ZA75	70	5/4	700	860	25	--	151	97	5/9+4/13	A03tB
A124T182ZA75	70	6/4	700	880	25	--	130	116	6/10+4/14	A03tB

S 120**Truck - Porteur - Rigid****voor-avant-front-Vorne**

A025T079ZA75	70	8	785	920	22	--		104	4/12+4/14	A03t
A124T159AA75	70	2/4/P	785	950	22	--		74	4/10+2/12+P/10	A03tB
A124T159ZA75	70	4/2	785	950	22	--	184	64	4/10+2/12	A03tB
F023T071ZA75	70	2/P	785	945	22	--	145	53	2/20+P/7	F03.10 glijdop/pastille
F023T059ZA75	70	2	785	945	22	--	160	53	2/22	F03.10 glijdop/pastille

achter-arrière-rear-Hinten

	A025T102ZA75	70	8/2P	700	570	25	--		116	8/12+2P/10	A03t
	A025T084ZA76	70	8/P/7	700	850	25	--	135	168	8/12+7/9+P/9	A03tA
A	A025T084ZA75	70	8	700	850	25	--	135	96	8/12	A03t
H	A025T084HA80	70	7/P	575	575	--	--	98	72	7/9+P/9	A08
	A025T104ZA75	70	5/4	700	860	25	--	151	97	5/9+4/13	A03tB
	A124T182ZA75	70	6/4	700	880	25	--	130	116	6/10+4/14	A03tB
	F023T104ZA75	70	2/P	700	860	25	--	120	119	2/25+P/60	F03.10 glijdop/pastille
	F023T102ZA75	70	2/P	700	860	25	--		100	2/23+P/54	F03.10 glijdop/pastille
	F023T086ZA76	70	2/P/2	700	860	25	--	116	141		F03A glijdop/pastille
A	F023T086ZA75	70	2/P	700	860	25	--	116	99	2/23+P/44	F03.10 glijdop/pastille
H	F023T086HA80	70	2	575	575	--	--	90	42	2/18	F08

BESTELNR N° COMMANDE ORDER NR BESTELNR	BR LRG WID BR	BLADEN LAMES LEAVES BLATT.	B	C	D1	D2	PH FL FA SP	PAK EP TH PAK	DETAIL	MOD	OPMERKINGEN REMARKS REMARKS BEMERKUNGEN
---	------------------------	-------------------------------------	---	---	----	----	----------------------	------------------------	--------	-----	--

SERIE : MIDLINER-S**S 130-06/08/09****Truck - Porteur - Rigid****voor-avant-front-Vorne**

A025T079ZA75	70	8	785	920	22	--		104	4/12+4/14	A03t
A025T049ZA75	70	6/2	780	940	22	--	220	84	6/10+2/12	A03tB
A025T049AA75	70	6/2/P	780	940	22	--	220	96	6/10+2/12+P/12	A03tB

achter-arrière-rear-Hinten

A025T112ZA75	70	8/2P	700	570	D25	--		116	8/12+2/10	A03t
A025T084ZA76	70	8/P/7	700	850	25	--	135	168	8/12+7/9+P/9	A03tA
A025T084ZA75	70	8	700	850	25	--	135	96	8/12	A03t
A025T084HA80	70	7/P	575	575	--	--	98	72	7/9+P/9	A08

S 130-11**Truck - Porteur - Rigid****voor-avant-front-Vorne**

A025T071ZA75	80	8	780	950	25	--	194	80	8/10	A03t
A025T071AA75	80	8/2P	780	950	25	--	155	110	8/10+2P/15	A03t
A025T083ZA75	80	4/3/P	785	915	25	--		108	4/13+3/16+P/8	A03tB

achter-arrière-rear-Hinten

A025T096ZA75	80	10/2P	710	800	30	--	70	168	10/14+2P/14	A03t
A025B016ZA75	80	8/7P	800	990	30	--	165	114	1/10+6/8+1/7+7P/	A03t
A025T086ZA76	80	9/2P/8	800	935	30	--	148	236		A03tA
A025T086ZA75	80	9	800	935	30	--	148	126	9/14	A03t
A025T086HA80	80	8/2P	690	690	--	--	85	110	8/11+2P/11	A08
A025B030ZA76	80	6/4P/5/5P	800	935	30	--		192	6/12+4P/10+5/8+	A03tA
F023T106ZA75	80	1	825	120	30	--		50	1/50	LR7710

BESTELNR N° COMMANDE ORDER NR BESTELNR	BR LRG WID BR	BLADEN LAMES LEAVES BLATT.	B	C	D1	D2	PH FL FA SP	PAK EP TH PAK	DETAIL	MOD	OPMERKINGEN REMARQUES REMARKS BEMERKUNGEN
---	------------------------	-------------------------------------	---	---	----	----	----------------------	------------------------	--------	-----	--

SERIE : MIDLINER-S**S 130-13****Truck - Porteur - Rigid****voor-avant-front-Vorne**

A025T083ZA75	80	4/3/P	785	915	25	--		108	4/13+3/16+P/8	A03tB
A025T061ZA75	80	7/2/P	785	950	25	--	152	108	7/10+2/11+P/16	A03tB
A025T061AA75	80	7/2/2P	785	950	25	--	152	116	7/10+2/11+P/16+	A03tB

achter-arrière-rear-Hinten

A025T096ZA75	80	10/2P	710	800	30	--	70	168	10/14+2P/14	A03t
A025B016ZA75	80	8/7P	800	990	30	--	165	114	1/10+6/8+1/7+7P/	A03t
A025T082ZA76	80	9/10	800	935	30	--	126	236		A03tA
A025T082ZA75	80	9	800	935	30	--	126	126	9/14	A03t
A025T082HA80	80	10	690	690	--	--	81	110	10/11	A08
A025B030ZA76	80	6/4P/5/5P	800	935	30	--		192	6/12+4P/10+5/8+	A03tA
F023T106ZA75	80	1	825	120	30	--		50	1/50	LR7710

S 130-14**Truck - Porteur - Rigid****voor-avant-front-Vorne**

A025T083ZA75	80	4/3/P	785	915	25	--		108	4/13+3/16+P/8	A03tB
--------------	----	-------	-----	-----	----	----	--	-----	---------------	-------

achter-arrière-rear-Hinten

A025T096ZA75	80	10/2P	710	800	30	--	70	168	10/14+2P/14	A03t
A025B016ZA75	80	8/7P	800	990	30	--	165	114	1/10+6/8+1/7+7P/	A03t
A025B030ZA76	80	6/4P/5/5P	800	935	30	--		192	6/12+4P/10+5/8+	A03tA
F023T106ZA75	80	1	825	120	30	--		50	1/50	LR7710

BESTELNR N° COMMANDE ORDER NR BESTELNR	BR LRG WID BR	BLADEN LAMES LEAVES BLATT.	B	C	D1	D2	PH FL FA SP	PAK EP TH PAK	DETAIL	MOD	OPMERKINGEN REMARKS BEMERKUNGEN
---	------------------------	-------------------------------------	---	---	----	----	----------------------	------------------------	--------	-----	---------------------------------------

SERIE : MIDLINER-S**S 135****Truck - Porteur - Rigid****voor-avant-front-Vorne**

A025T079ZA75	70	8	785	920	22	--		104	4/12+4/14	A03t	
F023T059ZA75	70	2	785	945	22	--	160	53	2/22	F03.10	glijdop/pastille
F023T083ZA75	70	2	785	945	22	--	185	53	2/22	F03.10	glijdop/pastille

achter-arrière-rear-Hinten

A025T102ZA75	70	8/2P	700	570	25	--		116	8/12+2P/10	A03t	
A025T084ZA76	70	8/P/7	700	850	25	--	135	168	8/12+7/9+P/9	A03tA	
A025T084ZA75	70	8	700	850	25	--	135	96	8/12	A03t	
A025T084HA80	70	7/P	575	575	--	--	98	72	7/9+P/9	A08	
F023T102ZA75	70	2/P	700	860	25	--		100	2/23+P/54	F03.10	glijdop/pastille
F023T104ZA75	70	2/P	700	860	25	--	120	119	2/25+P/60	F03.10	glijdop/pastille
F023T086ZA76	70	2/P/2	700	860	25	--	116	141		F03A	glijdop/pastille
F023T086ZA75	70	2/P	700	860	25	--	116	99	2/23+P/44	F03.10	glijdop/pastille
F023T086HA80	70	2	575	575	--	--	90	42	2/18	F08	

S 140**Truck - Porteur - Rigid****voor-avant-front-Vorne**

F023T071ZA75	70	2/P	785	945	22	--	145	53	2/20+P/7	F03.10	glijdop/pastille
--------------	----	-----	-----	-----	----	----	-----	----	----------	--------	------------------

achter-arrière-rear-Hinten

A025T104ZA75	70	5/4	700	860	25	--	151	97	5/9+4/13	A03tB	
A124T182ZA75	70	6/4	700	880	25	--	130	116	6/10+4/14	A03tB	
F023T102ZA75	70	2/P	700	860	25	--		100	2/23+P/54	F03.10	glijdop/pastille
F023T104ZA75	70	2/P	700	860	25	--	120	119	2/25+P/60	F03.10	glijdop/pastille

BESTELNR N° COMMANDE ORDER NR BESTELNR	BR LRG WID BR	BLADEN LAMES LEAVES BLATT.	B	C	D1	D2	PH FL FA SP	PAK EP TH PAK	DETAIL	MOD	OPMERKINGEN REMARKS BEMERKUNGEN
---	------------------------	-------------------------------------	---	---	----	----	----------------------	------------------------	--------	-----	---------------------------------------

SERIE : MIDLINER-S**S 150****Truck - Porteur - Rigid****voor-avant-front-Vorne**

A025T079ZA75	70	8	785	920	22	--		104	4/12+4/14	A03t	
F023T083ZA75	70	2	785	945	22	--	185	53	2/22	F03.10	glijdop/pastille
F023T059ZA75	70	2	785	945	22	--	160	53	2/22	F03.10	glijdop/pastille

achter-arrière-rear-Hinten

A025T102ZA75	70	8/2P	700	570	25	--		116	8/12+2P/10	A03t	
A025T084ZA76	70	8/P/7	700	850	25	--	135	168	8/12+7/9+P/9	A03tA	
A025T084ZA75	70	8	700	850	25	--	135	96	8/12	A03t	
A025T084HA80	70	7/P	575	575	--	--	98	72	7/9+P/9	A08	
F023T104ZA75	70	2/P	700	860	25	--	120	119	2/25+P/60	F03.10	glijdop/pastille
F023T102ZA75	70	2/P	700	860	25	--		100	2/23+P/54	F03.10	glijdop/pastille
F023T086ZA76	70	2/P/2	700	860	25	--	116	141		F03A	glijdop/pastille
F023T086ZA75	70	2/P	700	860	25	--	116	99	2/23+P/44	F03.10	glijdop/pastille
F023T086HA80	70	2	575	575	--	--	90	42	2/18	F08	

S 150-06/08/09**Truck - Porteur - Rigid****voor-avant-front-Vorne**

A025T079ZA75	70	8	785	920	22	--		104	4/12+4/14	A03t	
A025T049ZA75	70	6/2	780	940	22	--	220	84	6/10+2/12	A03tB	
A025T049AA75	70	6/2/P	780	940	22	--	220	96	6/10+2/12+P/12	A03tB	

achter-arrière-rear-Hinten

A025T112ZA75	70	8/2P	700	570	D25	--		116	8/12+2/10	A03t	
A025T084ZA76	70	8/P/7	700	850	25	--	135	168	8/12+7/9+P/9	A03tA	
A025T084ZA75	70	8	700	850	25	--	135	96	8/12	A03t	
A025T084HA80	70	7/P	575	575	--	--	98	72	7/9+P/9	A08	

BESTELNR N° COMMANDE ORDER NR BESTELNR	BR LRG WID BR	BLADEN LAMES LEAVES BLATT.	B	C	D1	D2	PH FL FA SP	PAK EP TH PAK	DETAIL	MOD	OPMERKINGEN REMARKS REMARKS BEMERKUNGEN
---	------------------------	-------------------------------------	---	---	----	----	----------------------	------------------------	--------	-----	--

SERIE : MIDLINER-S**S 150-11****Truck - Porteur - Rigid****voor-avant-front-Vorne**

A025T071ZA75	80	8	780	950	25	--	194	80	8/10	A03t
A025T071AA75	80	8/2P	780	950	25	--	155	110	8/10+2P/15	A03t
A025T083ZA75	80	4/3/P	785	915	25	--		108	4/13+3/16+P/8	A03tB

achter-arrière-rear-Hinten

A025T096ZA75	80	10/2P	710	800	30	--	70	168	10/14+2P/14	A03t
A025B016ZA75	80	8/7P	800	990	30	--	165	114	1/10+6/8+1/7+7P/	A03t
A025B030ZA76	80	6/4P/5/5P	800	935	30	--		192	6/12+4P/10+5/8+	A03tA
A025T086ZA76	80	9/2P/8	800	935	30	--	148	236		A03tA
A025T086ZA75	80	9	800	935	30	--	148	126	9/14	A03t
A025T086HA80	80	8/2P	690	690	--	--	85	110	8/11+2P/11	A08
F023T106ZA75	80	1	825	120	30	--		50	1/50	LR7710

S 150-13**Truck - Porteur - Rigid****voor-avant-front-Vorne**

A025T083ZA75	80	4/3/P	785	915	25	--		108	4/13+3/16+P/8	A03tB
A025T061ZA75	80	7/2P	785	950	25	--	152	108	7/10+2/11+P/16	A03tB
A025T061AA75	80	7/2/2P	785	950	25	--	152	116	7/10+2/11+P/16+	A03tB

achter-arrière-rear-Hinten

A025T096ZA75	80	10/2P	710	800	30	--	70	168	10/14+2P/14	A03t
A025B016ZA75	80	8/7P	800	990	30	--	165	114	1/10+6/8+1/7+7P/	A03t
A025B030ZA76	80	6/4P/5/5P	800	935	30	--		192	6/12+4P/10+5/8+	A03tA
A025T082ZA76	80	9/10	800	935	30	--	126	236		A03tA
A025T082ZA75	80	9	800	935	30	--	126	126	9/14	A03t
A025T082HA80	80	10	690	690	--	--	81	110	10/11	A08
F023T106ZA75	80	1	825	120	30	--		50	1/50	LR7710

BESTELNR N° COMMANDE ORDER NR BESTELNR	BR LRG WID BR	BLADEN LAMES LEAVES BLATT.	B	C	D1	D2	PH FL FA SP	PAK EP TH PAK	DETAIL	MOD	OPMERKINGEN REMARQUES REMARKS BEMERKUNGEN
---	------------------------	-------------------------------------	---	---	----	----	----------------------	------------------------	--------	-----	--

SERIE : MIDLINER-S

S 150-14

Truck - Porteur - Rigid

voor-avant-front-Vorne

A025T083ZA75	80	4/3/P	785	915	25	--		108	4/13+3/16+P/8	A03tB
--------------	----	-------	-----	-----	----	----	--	-----	---------------	-------

achter-arrière-rear-Hinten

A025T096ZA75	80	10/2P	710	800	30	--	70	168	10/14+2P/14	A03t
A025B016ZA75	80	8/7P	800	990	30	--	165	114	1/10+6/8+1/7+7P/	A03t
A025B030ZA76	80	6/4P/5/5P	800	935	30	--		192	6/12+4P/10+5/8+	A03tA
F023T106ZA75	80	1	825	120	30	--		50	1/50	LR7710

S 160

Truck - Porteur - Rigid

voor-avant-front-Vorne

A025T079ZA75	70	8	785	920	22	--		104	4/12+4/14	A03t
F023T059ZA75	70	2	785	945	22	--	160	53	2/22	F03.10 glijdop/pastille

achter-arrière-rear-Hinten

	A025T084ZA76	70	8/P/7	700	850	25	--	135	168	8/12+7/9+P/9	A03tA
A	A025T084ZA75	70	8	700	850	25	--	135	96	8/12	A03t
H	A025T084HA80	70	7/P	575	575	--	--	98	72	7/9+P/9	A08
	F023T086ZA76	70	2/P/2	700	860	25	--	116	141		F03A glijdop/pastille
A	F023T086ZA75	70	2/P	700	860	25	--	116	99	2/23+P/44	F03.10 glijdop/pastille
H	F023T086HA80	70	2	575	575	--	--	90	42	2/18	F08

BESTELNR N° COMMANDE ORDER NR BESTELNR	BR LRG WID BR	BLADEN LAMES LEAVES BLATT.	B	C	D1	D2	PH FL FA SP	PAK EP TH PAK	DETAIL	MOD	OPMERKINGEN REMARKS BEMERKUNGEN
---	------------------------	-------------------------------------	---	---	----	----	----------------------	------------------------	--------	-----	---------------------------------------

SERIE : MIDLINER-S**S 170****Truck - Porteur - Rigid****voor-avant-front-Vorne**

A025T083ZA75	80	4/3/P	785	915	25	--		108	4/13+3/16+P/8	A03tB
A025T061ZA75	80	7/2/P	785	950	25	--	152	108	7/10+2/11+P/16	A03tB
A025T061AA75	80	7/2/2P	785	950	25	--	152	116	7/10+2/11+P/16+	A03tB

achter-arrière-rear-Hinten

A025T096ZA75	80	10/2P	710	800	30	--	70	168	10/14+2P/14	A03t
A025T082ZA76	80	9/10	800	935	30	--	126	236		A03tA
A025T082ZA75	80	9	800	935	30	--	126	126	9/14	A03t
A025T082HA80	80	10	690	690	--	--	81	110	10/11	A08
F023T106ZA75	80	1	825	120	30	--		50	1/50	LR7710

Trekker - Tracteur - Tractor**voor-avant-front-Vorne**

A025T071ZA75	80	8	780	950	25	--	194	80	8/10	A03t
F023T085ZA75	80	3/P	785	940	25	--		102	3/18+2P/18+4P/3	F03t

achter-arrière-rear-Hinten

A025T106ZA76	80	7/6/P	800	935	30	--		198	7/14+6/10+4P/10	A03tA
A025T056ZA75	80	8/5	800	990	30	--	165	168	8/11+5/16	A03tB
F023T144ZA76	80	4/P/P/4	800	940	30	--	185	212		F03A
F023T144ZA75	80	4/P	800	940	30	--	185	133	4/20+P/38	F03
F023T144HA80	80	4/P	690	690	--	--	105	109	4/14+P/38	F08
F023T106ZA75	80	1	825	120	30	--		50	1/50	LR7710

S 170 4x4**Truck - Porteur - Rigid****voor-avant-front-Vorne**

A025T087ZA75	80	8	785	915	25	--		113	5/13+3/16	A03t
--------------	----	---	-----	-----	----	----	--	-----	-----------	------

achter-arrière-rear-Hinten

A025T090ZA76	80	9/10	800	935	30	--	126	234	1/12+8/14+10/11	A03tA
A025T090ZA75	80	9	800	935	30	--	126	124	1/12+8/14	A03t
A025T090HA80	80	10	690	690	--	--	81	110	10/11	A08
A025T082ZA76	80	9/10	800	935	30	--	126	236		A03tA
A025T082ZA75	80	9	800	935	30	--	126	126	9/14	A03t
A025T082HA80	80	10	690	690	--	--	81	110	10/11	A08

BESTELNR N° COMMANDE ORDER NR BESTELNR	BR LRG WID BR	BLADEN LAMES LEAVES BLATT.	B	C	D1	D2	PH FL FA SP	PAK EP TH PAK	DETAIL	MOD	OPMERKINGEN REMARKS BEMERKUNGEN
---	------------------------	-------------------------------------	---	---	----	----	----------------------	------------------------	--------	-----	---------------------------------------

SERIE : MIDLINER-S**S 170-11****Truck - Porteur - Rigid****voor-avant-front-Vorne**

A025T071ZA75	80	8	780	950	25	--	194	80	8/10	A03t
A025T071AA75	80	8/2P	780	950	25	--	155	110	8/10+2P/15	A03t
A025T083ZA75	80	4/3/P	785	915	25	--		108	4/13+3/16+P/8	A03tB

achter-arrière-rear-Hinten

A025T096ZA75	80	10/2P	710	800	30	--	70	168	10/14+2P/14	A03t
A025B016ZA75	80	8/7P	800	990	30	--	165	114	1/10+6/8+1/7+7P/	A03t
A025B030ZA76	80	6/4P/5/5P	800	935	30	--		192	6/12+4P/10+5/8+	A03tA
A025T086ZA76	80	9/2P/8	800	935	30	--	148	236		A03tA
A025T086ZA75	80	9	800	935	30	--	148	126	9/14	A03t
A025T086HA80	80	8/2P	690	690	--	--	85	110	8/11+2P/11	A08
F023T106ZA75	80	1	825	120	30	--		50	1/50	LR7710

S 170-13**Truck - Porteur - Rigid****voor-avant-front-Vorne**

A025T083ZA75	80	4/3/P	785	915	25	--		108	4/13+3/16+P/8	A03tB
A025T061ZA75	80	7/2P	785	950	25	--	152	108	7/10+2/11+P/16	A03tB
A025T061AA75	80	7/2/2P	785	950	25	--	152	116	7/10+2/11+P/16+	A03tB

achter-arrière-rear-Hinten

A025T096ZA75	80	10/2P	710	800	30	--	70	168	10/14+2P/14	A03t
A025B016ZA75	80	8/7P	800	990	30	--	165	114	1/10+6/8+1/7+7P/	A03t
A025B030ZA76	80	6/4P/5/5P	800	935	30	--		192	6/12+4P/10+5/8+	A03tA
A025T082ZA76	80	9/10	800	935	30	--	126	236		A03tA
A025T082ZA75	80	9	800	935	30	--	126	126	9/14	A03t
A025T082HA80	80	10	690	690	--	--	81	110	10/11	A08
F023T106ZA75	80	1	825	120	30	--		50	1/50	LR7710

BESTELNR N° COMMANDE ORDER NR BESTELNR	BR LRG WID BR	BLADEN LAMES LEAVES BLATT.	B	C	D1	D2	PH FL FA SP	PAK EP TH PAK	DETAIL	MOD	OPMERKINGEN REMARKS BEMERKUNGEN
---	------------------------	-------------------------------------	---	---	----	----	----------------------	------------------------	--------	-----	---------------------------------------

SERIE : MIDLINER-S

S 180

Truck - Porteur - Rigid

voor-avant-front-Vorne

A025T079ZA75	70	8	785	920	22	--		104	4/12+4/14	A03t	
F023T059ZA75	70	2	785	945	22	--	160	53	2/22	F03.10	glijdop/pastille
F023T083ZA75	70	2	785	945	22	--	185	53	2/22	F03.10	glijdop/pastille

achter-arrière-rear-Hinten

A	A025T084ZA76	70	8/P/7	700	850	25	--	135	168	8/12+7/9+P/9	A03tA
A	A025T084ZA75	70	8	700	850	25	--	135	96	8/12	A03t
H	A025T084HA80	70	7/P	575	575	--	--	98	72	7/9+P/9	A08
	F023T102ZA75	70	2/P	700	860	25	--		100	2/23+P/54	F03.10 glijdop/pastille
	F023T104ZA75	70	2/P	700	860	25	--	120	119	2/25+P/60	F03.10 glijdop/pastille
	F023T086ZA76	70	2/P/2	700	860	25	--	116	141		F03A glijdop/pastille
A	F023T086ZA75	70	2/P	700	860	25	--	116	99	2/23+P/44	F03.10 glijdop/pastille
H	F023T086HA80	70	2	575	575	--	--	90	42	2/18	F08

S 210

Truck - Porteur - Rigid

voor-avant-front-Vorne

A025T079ZA75	70	8	785	920	22	--		104	4/12+4/14	A03t	
F023T083ZA75	70	2	785	945	22	--	185	53	2/22	F03.10	glijdop/pastille
F023T059ZA75	70	2	785	945	22	--	160	53	2/22	F03.10	glijdop/pastille

achter-arrière-rear-Hinten

A	A025T084ZA76	70	8/P/7	700	850	25	--	135	168	8/12+7/9+P/9	A03tA
A	A025T084ZA75	70	8	700	850	25	--	135	96	8/12	A03t
H	A025T084HA80	70	7/P	575	575	--	--	98	72	7/9+P/9	A08
	F023T104ZA75	70	2/P	700	860	25	--	120	119	2/25+P/60	F03.10 glijdop/pastille
	F023T102ZA75	70	2/P	700	860	25	--		100	2/23+P/54	F03.10 glijdop/pastille
	F023T086ZA76	70	2/P/2	700	860	25	--	116	141		F03A glijdop/pastille
A	F023T086ZA75	70	2/P	700	860	25	--	116	99	2/23+P/44	F03.10 glijdop/pastille
H	F023T086HA80	70	2	575	575	--	--	90	42	2/18	F08

BESTELNR N° COMMANDE ORDER NR BESTELNR	BR LRG WID BR	BLADEN LAMES LEAVES BLATT.	B	C	D1	D2	PH FL FA SP	PAK EP TH PAK	DETAIL	MOD	OPMERKINGEN REMARQUES REMARKS BEMERKUNGEN
---	------------------------	-------------------------------------	---	---	----	----	----------------------	------------------------	--------	-----	--

SERIE : MIDLINER-S

S 220

Truck - Porteur - Rigid

voor-avant-front-Vorne

A025T083ZA75	80	4/3/P	785	915	25	--		108	4/13+3/16+P/8	A03tB
A025T061ZA75	80	7/2/P	785	950	25	--	152	108	7/10+2/11+P/16	A03tB
A025T061AA75	80	7/2/2P	785	950	25	--	152	116	7/10+2/11+P/16+	A03tB

achter-arrière-rear-Hinten

A025T096ZA75	80	10/2P	710	800	30	--	70	168	10/14+2P/14	A03t
A025T082ZA76	80	9/10	800	935	30	--	126	236		A03tA
A025T082ZA75	80	9	800	935	30	--	126	126	9/14	A03t
A025T082HA80	80	10	690	690	--	--	81	110	10/11	A08
F023T106ZA75	80	1	825	120	30	--		50	1/50	LR7710

Trekker - Tracteur - Tractor

voor-avant-front-Vorne

A025T071ZA75	80	8	780	950	25	--	194	80	8/10	A03t
F023T085ZA75	80	3/P	785	940	25	--		102	3/18+2P/18+4P/3	F03t

achter-arrière-rear-Hinten

A025T106ZA76	80	7/6/P	800	935	30	--		198	7/14+6/10+4P/10	A03tA
A025T056ZA75	80	8/5	800	990	30	--	165	168	8/11+5/16	A03tB
F023T144ZA76	80	4/P/P/4	800	940	30	--	185	212		F03A
F023T144ZA75	80	4/P	800	940	30	--	185	133	4/20+P/38	F03
F023T144HA80	80	4/P	690	690	--	--	105	109	4/14+P/38	F08
F023T106ZA75	80	1	825	120	30	--		50	1/50	LR7710

BESTELNR N° COMMANDE ORDER NR BESTELLNR	BR LRG WID BR	BLADEN LAMES LEAVES BLATT.	B	C	D1	D2	PH FL FA SP	PAK EP TH PAK	DETAIL	MOD	OPMERKINGEN REMARQUES REMARKS BEMERKUNGEN
--	------------------------	-------------------------------------	---	---	----	----	----------------------	------------------------	--------	-----	--

SERIE : MIDLUM

MI41B1

Truck - Porteur - Rigid

achter-arrière-rear-Hinten

F023T214ZA75	70	3/1	0	0	25	--		0		F03B
--------------	----	-----	---	---	----	----	--	---	--	------

MI41B2

Truck - Porteur - Rigid

achter-arrière-rear-Hinten

F023T214ZA75	70	3/1	0	0	25	--		0		F03B
--------------	----	-----	---	---	----	----	--	---	--	------

MI42B1

Truck - Porteur - Rigid

voor-avant-front-Vorne

F023T145ZA75	0	1	870	870	S	S		0		F01	Silentbloc
F023T143ZA75	0	2	870	870	S	S		0		F01	Silentbloc
F023T141ZA75	70	1/P	870	870	S16	S16	155	73	28+P/40	F01	Silentbloc
F023T157ZA75	70	1/P	870	870	S16	S16				F01	

achter-arrière-rear-Hinten

F023T246ZA70											
F023T248ZA75											
F023T220ZA75	70	2	0	0	25	--		0		F03	
F023T212ZA75	70	3	0	0	25	--		0		F03	
F023T210ZA75	70	2	700	860	25	--	155/145	54	2/24	F03	
F023T218ZA75	70	3/1	0	0	25	--		0		F03B	

BESTELNR N° COMMANDE ORDER NR BESTELNR	BR LRG WID BR	BLADEN LAMES LEAVES BLATT.	B	C	D1	D2	PH FL FA SP	PAK EP TH PAK	DETAIL	MOD	OPMERKINGEN REMARQUES REMARKS BEMERKUNGEN
---	------------------------	-------------------------------------	---	---	----	----	----------------------	------------------------	--------	-----	--

SERIE : MIDLUM

MI42B2

Truck - Porteur - Rigid

voor-avant-front-Vorne

F023T145ZA75	0	1	870	870	S	S		0		F01	Silentbloc
F023T143ZA75	0	2	870	870	S	S		0		F01	Silentbloc
F023T157ZA75	70	1/P	870	870	S16	S16				F01	

achter-arrière-rear-Hinten

F023T246ZA70											
F023T248ZA75											
F023T220ZA75	70	2	0	0	25	--		0		F03	
F023T212ZA75	70	3	0	0	25	--		0		F03	
F023T210ZA75	70	2	700	860	25	--	155/145	54	2/24	F03	
F023T218ZA75	70	3/1	0	0	25	--		0		F03B	

MI42B3

Truck - Porteur - Rigid

voor-avant-front-Vorne

F023T145ZA75	0	1	870	870	S	S		0		F01	Silentbloc
--------------	---	---	-----	-----	---	---	--	---	--	-----	------------

achter-arrière-rear-Hinten

F023T244ZA70											
F023T246ZA70											
F023T248ZA75											
F023T252ZA75	70	2	800	800	S20.5	S20.5	82	64	2/30	F01.60	Silentbloc
F023T220ZA75	70	2	0	0	25	--		0		F03	
F023T212ZA75	70	3	0	0	25	--		0		F03	
F023T214ZA75	70	3/1	0	0	25	--		0		F03B	
F023T218ZA75	70	3/1	0	0	25	--		0		F03B	

BESTELNR N° COMMANDE ORDER NR BESTELNR	BR LRG WID BR	BLADEN LAMES LEAVES BLATT.	B	C	D1	D2	PH FL FA SP	PAK EP TH PAK	DETAIL	MOD	OPMERKINGEN REMARKS BEMERKUNGEN
---	------------------------	-------------------------------------	---	---	----	----	----------------------	------------------------	--------	-----	---------------------------------------

SERIE : MIDLUM**MI42B4****Truck - Porteur - Rigid****achter-arrière-rear-Hinten**

F023T246ZA70											
F023T244ZA70											
F023T248ZA75											
F023T220ZA75	70	2	0	0	25	--		0			F03
F023T212ZA75	70	3	0	0	25	--		0			F03
F023T210ZA75	70	2	700	860	25	--	155/145	54	2/24		F03
F023T214ZA75	70	3/1	0	0	25	--		0			F03B

MI43B2**Truck - Porteur - Rigid****achter-arrière-rear-Hinten**

F023T210ZA75	70	2	700	860	25	--	155/145	54	2/24		F03
--------------	----	---	-----	-----	----	----	---------	----	------	--	-----

MI43C1**Truck - Porteur - Rigid****voor-avant-front-Vorne**

F023T147ZA75	0	2	1000	1000	S	S		0			F01	Silentbloc
F023T149ZA75	80	2	1000	1000	S16	S16	140	71	2/32		F01	Silentbloc

achter-arrière-rear-Hinten

F023T244ZA70												
F023T248ZA75												
F023T216ZA75	80	2/1	0	0	S20	--		0			F03B	Silentbloc

MI43C2**Truck - Porteur - Rigid****voor-avant-front-Vorne**

F023T147ZA75	0	2	1000	1000	S	S		0			F01	Silentbloc
F023T149ZA75	80	2	1000	1000	S16	S16	140	71	2/32		F01	Silentbloc

achter-arrière-rear-Hinten

F023T256ZA75	80	2/1	900	1060	S20	--	130	112	2/32+1/40		F03B	Silentbloc
--------------	----	-----	-----	------	-----	----	-----	-----	-----------	--	------	------------

BESTELNR N° COMMANDE ORDER NR BESTELNR	BR LRG WID BR	BLADEN LAMES LEAVES BLATT.	B	C	D1	D2	PH FL FA SP	PAK EP TH PAK	DETAIL	MOD	OPMERKINGEN REMARQUES REMARKS BEMERKUNGEN
---	------------------------	-------------------------------------	---	---	----	----	----------------------	------------------------	--------	-----	--

SERIE : MIDLUM

MI43E1

Truck - Porteur - Rigid

voor-avant-front-Vorne

F023T149ZA75	80	2	1000	1000	S16	S16	140	71	2/32	F01	Silentbloc
--------------	----	---	------	------	-----	-----	-----	----	------	-----	------------

achter-arrière-rear-Hinten

F023T222ZA75	80	2/1	0	0	S20	--		0		F03B	Silentbloc
--------------	----	-----	---	---	-----	----	--	---	--	------	------------

MI43E2

Truck - Porteur - Rigid

voor-avant-front-Vorne

F023T149ZA75	80	2	1000	1000	S16	S16	140	71	2/32	F01	Silentbloc
--------------	----	---	------	------	-----	-----	-----	----	------	-----	------------

MI43T

Truck - Porteur - Rigid

achter-arrière-rear-Hinten

F023T244ZA70											
--------------	--	--	--	--	--	--	--	--	--	--	--

F023T248ZA75											
--------------	--	--	--	--	--	--	--	--	--	--	--

MI43V

Truck - Porteur - Rigid

voor-avant-front-Vorne

F023T149ZA75	80	2	1000	1000	S16	S16	140	71	2/32	F01	Silentbloc
--------------	----	---	------	------	-----	-----	-----	----	------	-----	------------

MI44C1

Truck - Porteur - Rigid

voor-avant-front-Vorne

F023T147ZA75	0	2	1000	1000	S	S		0		F01	Silentbloc
--------------	---	---	------	------	---	---	--	---	--	-----	------------

F023T123ZA75	80	1/P	1000	1000	S16	S16	140	72	1/37+P/30	F01	
--------------	----	-----	------	------	-----	-----	-----	----	-----------	-----	--

achter-arrière-rear-Hinten

F023T246ZA70											
--------------	--	--	--	--	--	--	--	--	--	--	--

F023T248ZA75											
--------------	--	--	--	--	--	--	--	--	--	--	--

F023T216ZA75	80	2/1	0	0	S20	--		0		F03B	Silentbloc
--------------	----	-----	---	---	-----	----	--	---	--	------	------------

F023T232ZA75	80	2/1	900	1060	S20	--	230	92	2/24+1/35	F03B	Silentbloc
--------------	----	-----	-----	------	-----	----	-----	----	-----------	------	------------

BESTELNR N° COMMANDE ORDER NR BESTELNR	BR LRG WID BR	BLADEN LAMES LEAVES BLATT.	B	C	D1	D2	PH FL FA SP	PAK EP TH PAK	DETAIL	MOD	OPMERKINGEN REMARQUES REMARKS BEMERKUNGEN
---	------------------------	-------------------------------------	---	---	----	----	----------------------	------------------------	--------	-----	--

SERIE : MIDLUM

MI44C2

Truck - Porteur - Rigid

voor-avant-front-Vorne

F023T147ZA75	0	2	1000	1000	S	S		0		F01	Silentbloc
F023T151ZA75	80	1/2P	1000	1000	S16	S16	154	89	1/39+P/15+P/30	F01	Silentbloc
F023T123ZA75	80	1/P	1000	1000	S16	S16	140	72	1/37+P/30	F01	
F023T153ZA75	80	2	1000	1000	S16	S16		0		F01	Silentbloc

achter-arrière-rear-Hinten

F023T246ZA70											
F023T248ZA75											
F023T244ZA70											
F023T230ZA75	0	2	0	0				0		F03	
F023T228ZA75	0	2	0	0				0		F03	
F023T226ZA75	0	2	0	0				0		F03	
F023T232ZA75	80	2/1	900	1060	S20	--	230	92	2/24+1/35	F03B	Silentbloc
F023T298ZA75	80	3	900	1060	S20	--	92	122	2/35+1/43	F03B	

MI44D2

Truck - Porteur - Rigid

voor-avant-front-Vorne

F023T149ZA75	80	2	1000	1000	S16	S16	140	71	2/32	F01	Silentbloc
--------------	----	---	------	------	-----	-----	-----	----	------	-----	------------

MI44D3

Truck - Porteur - Rigid

achter-arrière-rear-Hinten

F023T230ZA75	0	2	0	0				0		F03	
F023T298ZA75	80	3	900	1060	S20	--	92	122	2/35+1/43	F03B	

BESTELNR N° COMMANDE ORDER NR BESTELNR	BR LRG WID BR	BLADEN LAMES LEAVES BLATT.	B	C	D1	D2	PH FL FA SP	PAK EP TH PAK	DETAIL	MOD	OPMERKINGEN REMARQUES REMARKS BEMERKUNGEN
---	------------------------	-------------------------------------	---	---	----	----	----------------------	------------------------	--------	-----	--

SERIE : MIDLUM**MI44T****Truck - Porteur - Rigid****voor-avant-front-Vorne**

F023T151ZA75	80	1/2P	1000	1000	S16	S16	154	89	1/39+P/15+P/30	F01	Silentbloc
--------------	----	------	------	------	-----	-----	-----	----	----------------	-----	------------

achter-arrière-rear-Hinten

F023T244ZA70											
F023T248ZA75											
F023T228ZA75	0	2	0	0				0		F03	

MI44V**Truck - Porteur - Rigid****voor-avant-front-Vorne**

F023T123ZA75	80	1/P	1000	1000	S16	S16	140	72	1/37+P/30	F01	
F023T151ZA75	80	1/2P	1000	1000	S16	S16	154	89	1/39+P/15+P/30	F01	Silentbloc
F023T153ZA75	80	2	1000	1000	S16	S16		0		F01	Silentbloc

achter-arrière-rear-Hinten

F023T238ZA75	80	2	0	0	S20	--		0		F03	Silentbloc
F023T240ZA75	80	2	0	0	S20	--		0		F03	Silentbloc
F023T234ZA75	80	2	820	720	S20	--	172	65	2/30	F03	

MI45D2**Truck - Porteur - Rigid****voor-avant-front-Vorne**

F023T149ZA75	80	2	1000	1000	S16	S16	140	71	2/32	F01	Silentbloc
--------------	----	---	------	------	-----	-----	-----	----	------	-----	------------

achter-arrière-rear-Hinten

F023T228ZA75	0	2	0	0				0		F03	
F023T236ZA75	80	2/1	0	0	S20	--		0		F03B	Silentbloc
F023T242ZA75	80	2/1	0	0	S20	--		0		F03B	Silentbloc

BESTELNR N° COMMANDE ORDER NR BESTELNR	BR LRG WID BR	BLADEN LAMES LEAVES BLATT.	B	C	D1	D2	PH FL FA SP	PAK EP TH PAK	DETAIL	MOD	OPMERKINGEN REMARQUES REMARKS BEMERKUNGEN
---	------------------------	-------------------------------------	---	---	----	----	----------------------	------------------------	--------	-----	--

SERIE : MIDLUM**MI45D3****Truck - Porteur - Rigid****voor-avant-front-Vorne**

F023T155ZA75	0	2	0	0				0			F01
--------------	---	---	---	---	--	--	--	---	--	--	-----

achter-arrière-rear-Hinten

F023T228ZA75	0	2	0	0				0			F03
--------------	---	---	---	---	--	--	--	---	--	--	-----

F023T230ZA75	0	2	0	0				0			F03
--------------	---	---	---	---	--	--	--	---	--	--	-----

F023T236ZA75	80	2/1	0	0	S20	--		0			F03B	Silentbloc
--------------	----	-----	---	---	-----	----	--	---	--	--	------	------------

F023T298ZA75	80	3	900	1060	S20	--	92	122	2/35+1/43		F03B	
--------------	----	---	-----	------	-----	----	----	-----	-----------	--	------	--

MI45E2**Truck - Porteur - Rigid****voor-avant-front-Vorne**

F023T149ZA75	80	2	1000	1000	S16	S16	140	71	2/32		F01	Silentbloc
--------------	----	---	------	------	-----	-----	-----	----	------	--	-----	------------

achter-arrière-rear-Hinten

F023T242ZA75	80	2/1	0	0	S20	--		0			F03B	Silentbloc
--------------	----	-----	---	---	-----	----	--	---	--	--	------	------------

BESTELNR N° COMMANDE ORDER NR BESTELNR	BR LRG WID BR	BLADEN LAMES LEAVES BLATT.	B	C	D1	D2	PH FL FA SP	PAK EP TH PAK	DETAIL	MOD	OPMERKINGEN REMARQUES REMARKS BEMERKUNGEN
---	------------------------	-------------------------------------	---	---	----	----	----------------------	------------------------	--------	-----	--

SERIE : PREMIUM**PR 4x2****Truck - Porteur - Rigid****voor-avant-front-Vorne**

F023T081ZA75	90	1	990	1115	20	20	180	43	1/43	F01
F023T077ZA75	90	2	937	1093	20	20	170	66	2/30	F01.10
F023T079ZA75	90	2	937	1093	20	20		70	2/32	F01.10

achter-arrière-rear-Hinten

A124T296ZA75	90	13	905	815	20	--	40	198	8/16+5/14	A03
F023T154ZA76	90	2/1	905	1035	20	--	190	109	2/34+1/32+P/	F03A
A F023T154ZA75	90	2	905	1035	20	--	190	74	2/34	F03
H F023T154HA80	90	1	740	680	--	--	150	35	1/32	F08
F023T192ZA75	90	2/1/P	905	1020	20	--	120	107	1/30+1/31+1/36+	F03B
F023T282ZL75	100	2	612	465	S30	--	5	98	2/46	LK1214. Drivers side
F023T282ZR75	100	2	612	465	S30	--	5	98	2/46	LK1214. Passengers side
F023T156ZL75	100	2	612	465	S30	--	5	98	2/46	LK1214. Drivers side
F023T156ZR75	100	2	612	465	S30	--	5	98	2/46	LK1214. Passengers side
F023T160ZR75	100	2	610	425	S30	--	6	100	2/46	LR0211. Lenker
F023T160ZL75	100	2	610	425	S30	--	6	100	2/46	LR0211. Lenker

PR 6x2**Truck - Porteur - Rigid****voor-avant-front-Vorne**

F023T081ZA75	90	1	990	1115	20	20	180	43	1/43	F01
F023T079ZA75	90	2	937	1093	20	20		70	2/32	F01.10

achter-arrière-rear-Hinten

F023T156ZR75	100	2	612	465	S30	--	5	98	2/46	LK1214. Passengers side
F023T282ZL75	100	2	612	465	S30	--	5	98	2/46	LK1214. Drivers side
F023T282ZR75	100	2	612	465	S30	--	5	98	2/46	LK1214. Passengers side
F023T156ZL75	100	2	612	465	S30	--	5	98	2/46	LK1214. Drivers side

BESTELNR N° COMMANDE ORDER NR BESTELNR	BR LRG WID BR	BLADEN LAMES LEAVES BLATT.	B	C	D1	D2	PH FL FA SP	PAK EP TH PAK	DETAIL	MOD	OPMERKINGEN REMARQUES REMARKS BEMERKUNGEN
---	------------------------	-------------------------------------	---	---	----	----	----------------------	------------------------	--------	-----	--

SERIE : PREMIUM**PR 6x2/4****Truck - Porteur - Rigid****voor-avant-front-Vorne**

F023T079ZA75	90	2	937	1093	20	20		70	2/32		F01.10
--------------	----	---	-----	------	----	----	--	----	------	--	--------

achter-arrière-rear-Hinten

F023T284ZL75	100	2	510	590	S30	--	-16	66	2/30		LK4528 Lenker
F023T190ZR75	100	2	510	590	S30	--	-16	66	2/30		LK4528 Lenker
F023T190ZL75	100	2	510	590	S30	--	-16	66	2/30		LK4528 Lenker
F023T284ZR75	100	2	510	590	S30	--	-16	66	2/30		LK4528 Lenker

TR 4x2**Trekker - Tracteur - Tractor****voor-avant-front-Vorne**

F023T081ZA75	90	1	990	1115	20	20	180	43	1/43		F01
F023T077ZA75	90	2	937	1093	20	20	170	66	2/30		F01.10
F023T079ZA75	90	2	937	1093	20	20		70	2/32		F01.10

achter-arrière-rear-Hinten

F023T130ZA75	90	3	905	905	20	20	140	105	3/32		F01
F023T158ZA75	90	3	905	905	20	20	150	102	3/30		F01.10
F023T282ZL75	100	2	612	465	S30	--	5	98	2/46		LK1214. Drivers side
F023T156ZR75	100	2	612	465	S30	--	5	98	2/46		LK1214. Passengers side
F023T156ZL75	100	2	612	465	S30	--	5	98	2/46		LK1214. Drivers side
F023T282ZR75	100	2	612	465	S30	--	5	98	2/46		LK1214. Passengers side

BESTELNR N° COMMANDE ORDER NR BESTELNR	BR LRG WID BR	BLADEN LAMES LEAVES BLATT.	B	C	D1	D2	PH FL FA SP	PAK EP TH PAK	DETAIL	MOD	OPMERKINGEN REMARQUES REMARKS BEMERKUNGEN
---	------------------------	-------------------------------------	---	---	----	----	----------------------	------------------------	--------	-----	--

SERIE : R

R 310 4x2

Truck - Porteur - Rigid

voor-avant-front-Vorne

A124T099ZA75	100	13	825	825	32	32	240	119	1/11+12/9	A01
F023T021ZA75	100	3/P/P	825	825	32	32	200	110	3/22+P/16+P/16	F01
F023T021ZB75	100	4/P/P	825	825	32	32	200	135	4/22+P/16+P/16	F01

achter-arrière-rear-Hinten

A124T054ZA76	100	8/P/5	825	1000	32	--	225	184	8/14+5/12+P/12	A03A
A124T054ZA75	100	8	825	1000	32	--	225	112	8/14	A03
A124T054HA80	100	5/P	665	665	--	--	132	72	5/12+P/12	A08
A124T154ZA70	100	3	760	760	--	--	25	24	3/8	A08

R 310 6x4

Truck - Porteur - Rigid

voor-avant-front-Vorne

A124T099ZA75	100	13	825	825	32	32	240	119	1/11+12/9	A01
F023T021ZA75	100	3/P/P	825	825	32	32	200	110	3/22+P/16+P/16	F01
F023T021ZB75	100	4/P/P	825	825	32	32	200	135	4/22+P/16+P/16	F01

achter-arrière-rear-Hinten

A124T170ZA70	100	7/P	745	745	--	--	30	150	7/20+P/10	A08R
A124T152ZA70	100	9/P	745	745	--	--	15	208	9/22+P/10	A08R
A124T150ZA70	100	9/P	745	745	--	--	15	208	9/22+P/10	A08R

BESTELNR N° COMMANDE ORDER NR BESTELNR	BR LRG WID BR	BLADEN LAMES LEAVES BLATT.	B	C	D1	D2	PH FL FA SP	PAK EP TH PAK	DETAIL	MOD	OPMERKINGEN REMARKS BEMERKUNGEN
---	------------------------	-------------------------------------	---	---	----	----	----------------------	------------------------	--------	-----	---------------------------------------

SERIE : R**R 310T 4x2****Trekker - Tracteur - Tractor****voor-avant-front-Vorne**

A124T123ZA75	100	12	825	825	32	32	260	110	1/11+11/9	A01
A124T099ZA75	100	13	825	825	32	32	240	119	1/11+12/9	A01
F023T021ZA75	100	3/P/P	825	825	32	32	200	110	3/22+P/16+P/16	F01
F023T021ZB75	100	4/P/P	825	825	32	32	200	135	4/22+P/16+P/16	F01

achter-arrière-rear-Hinten

A124T148ZA75	100	12	875	1050	32	--	175	156	12/13	A03
A124T070ZA76	100	12/P/5	875	1050	32	--	95	228	12/13+5/12+P/12	A03A
A124T070ZA75	100	12	875	1000	32	--	95	156	12/13	A03
A124T070HA80	100	5/P	665	665	--	--	55	72	5/12+P/12	A08
A124T154ZA70	100	3	760	760	--	--	25	24	3/8	A08
F023T022ZA75	100	4/P	875	1050	32	--	135	155	4/27+P/27	F03

R 310TD 4x2**Trekker - Tracteur - Tractor****voor-avant-front-Vorne**

A124T123ZA75	100	12	825	825	32	32	260	110	1/11+11/9	A01
A124T099ZA75	100	13	825	825	32	32	240	119	1/11+12/9	A01
F023T021ZA75	100	3/P/P	825	825	32	32	200	110	3/22+P/16+P/16	F01
F023T021ZB75	100	4/P/P	825	825	32	32	200	135	4/22+P/16+P/16	F01

achter-arrière-rear-Hinten

A124T148ZA75	100	12	875	1050	32	--	175	156	12/13	A03
A124T070ZA76	100	12/P/5	875	1050	32	--	95	228	12/13+5/12+P/12	A03A
A124T070ZA75	100	12	875	1000	32	--	95	156	12/13	A03
A124T070HA80	100	5/P	665	665	--	--	55	72	5/12+P/12	A08
A124T154ZA70	100	3	760	760	--	--	25	24	3/8	A08
F023T022ZA75	100	4/P	875	1050	32	--	135	155	4/27+P/27	F03

BESTELNR N° COMMANDE ORDER NR BESTELNR	BR LRG WID BR	BLADEN LAMES LEAVES BLATT.	B	C	D1	D2	PH FL FA SP	PAK EP TH PAK	DETAIL	MOD	OPMERKINGEN REMARQUES REMARKS BEMERKUNGEN
---	------------------------	-------------------------------------	---	---	----	----	----------------------	------------------------	--------	-----	--

SERIE : R

R 340TI 4x2

Truck - Porteur - Rigid

voor-avant-front-Vorne

A124T145ZA75	100	13	825	825	32	32	208	119	1/11+12/9	A01
A124T099ZA75	100	13	825	825	32	32	240	119	1/11+12/9	A01
A124T291ZA75	100	17	825	825	32	32		220	1/11+16/9	A01
F023T047ZA75	100	3/P/P	825	825	32	32	200	110	3/22+P/16+P/16	F01
F023T021ZB75	100	4/P/P	825	825	32	32	200	135	4/22+P/16+P/16	F01

achter-arrière-rear-Hinten

	A124T054ZA76	100	8/P/5	825	1000	32	--	225	184	8/14+5/12+P/12	A03A
A	A124T054ZA75	100	8	825	1000	32	--	225	112	8/14	A03
H	A124T054HA80	100	5/P	665	665	--	--	132	72	5/12+P/12	A08
	F023T076ZA76	100	3/1	825	1000	32	--	170	128	3/26+1/28+P/	F03A
A	F023T076ZA75	100	3	825	1000	32	--	170	90	3/26	F03
H	F023T076HA80	100	1	670	670	--	--	130	31	1/28	F08
	F023T074ZA76	100	3/1	825	1000	32	--	160	121	3/26+1/28+P/	F03A
A	F023T074ZA75	100	3	825	1000	32	--	160	90	3/26	F03
H	F023T074HA80	100	1	675	675	--	--	120	28	1/28	F08
	F023T122ZA75	100	2	860	1015	S24	--	(23)	78	1/18+1/60	F74.31 Lenker

BESTELNR N° COMMANDE ORDER NR BESTELNR	BR LRG WID BR	BLADEN LAMES LEAVES BLATT.	B	C	D1	D2	PH FL FA SP	PAK EP TH PAK	DETAIL	MOD	OPMERKINGEN REMARQUES REMARKS BEMERKUNGEN
---	------------------------	-------------------------------------	---	---	----	----	----------------------	------------------------	--------	-----	--

SERIE : R**R 340TI 4x2****Trekker - Tracteur - Tractor****voor-avant-front-Vorne**

A124T123ZA75	100	12	825	825	32	32	260	110	1/11+11/9	A01
A124T099ZA75	100	13	825	825	32	32	240	119	1/11+12/9	A01
A124T145ZA75	100	13	825	825	32	32	208	119	1/11+12/9	A01
A124T291ZA75	100	17	825	825	32	32		220	1/11+16/9	A01
F023T047ZA75	100	3/P/P	825	825	32	32	200	110	3/22+P/16+P/16	F01
F023T021ZB75	100	4/P/P	825	825	32	32	200	135	4/22+P/16+P/16	F01

achter-arrière-rear-Hinten

A124T148ZA75	100	12	875	1050	32	--	175	156	12/13	A03
A124T070ZA76	100	12/P/5	875	1050	32	--	95	228	12/13+5/12+P/12	A03A
A124T070ZA75	100	12	875	1000	32	--	95	156	12/13	A03
A124T070HA80	100	5/P	665	665	--	--	55	72	5/12+P/12	A08
A124T154ZA70	100	3	760	760	--	--	25	24	3/8	A08
F023T048ZA75	100	4/P	875	1050	32	--	135	155	4/27+P/27	F03
F023T092ZA75	100	4/P	875	1050	32	--	135	155	4/27+P/27	F03.10 glijdop/pastille
F023T122ZA75	100	2	860	1015	S24	--	(23)	78	1/18+1/60	F74.31 Lenker

R 340TI 6x2**Truck - Porteur - Rigid****voor-avant-front-Vorne**

A124T099ZA75	100	13	825	825	32	32	240	119	1/11+12/9	A01
A124T145ZA75	100	13	825	825	32	32	208	119	1/11+12/9	A01
A124T291ZA75	100	17	825	825	32	32		220	1/11+16/9	A01
F023T047ZA75	100	3/P/P	825	825	32	32	200	110	3/22+P/16+P/16	F01
F023T021ZB75	100	4/P/P	825	825	32	32	200	135	4/22+P/16+P/16	F01

achter-arrière-rear-Hinten

A124T054ZA76	100	8/P/5	825	1000	32	--	225	184	8/14+5/12+P/12	A03A
A124T054ZA75	100	8	825	1000	32	--	225	112	8/14	A03
A124T054HA80	100	5/P	665	665	--	--	132	72	5/12+P/12	A08
F023T074ZA76	100	3/1	825	1000	32	--	160	121	3/26+1/28+P/	F03A
F023T074ZA75	100	3	825	1000	32	--	160	90	3/26	F03
F023T074HA80	100	1	675	675	--	--	120	28	1/28	F08
F023T122ZA75	100	2	860	1015	S24	--	(23)	78	1/18+1/60	F74.31 Lenker

BESTELNR N° COMMANDE ORDER NR BESTELLNR	BR LRG WID BR	BLADEN LAMES LEAVES BLATT.	B	C	D1	D2	PH FL FA SP	PAK EP TH PAK	DETAIL	MOD	OPMERKINGEN REMARQUES REMARKS BEMERKUNGEN
--	------------------------	-------------------------------------	---	---	----	----	----------------------	------------------------	--------	-----	--

SERIE : R**R 350 6x4****Truck - Porteur - Rigid****voor-avant-front-Vorne**

A124T145ZA75	100	13	825	825	32	32	208	119	1/11+12/9	A01
A124T099ZA75	100	13	825	825	32	32	240	119	1/11+12/9	A01

achter-arrière-rear-Hinten

A124T170ZA70	100	7/P	745	745	--	--	30	150	7/20+P/10	A08R
A124T152ZA70	100	9/P	745	745	--	--	15	208	9/22+P/10	A08R

BESTELNR N° COMMANDE ORDER NR BESTELNR	BR LRG WID BR	BLADEN LAMES LEAVES BLATT.	B	C	D1	D2	PH FL FA SP	PAK EP TH PAK	DETAIL	MOD	OPMERKINGEN REMARQUES REMARKS BEMERKUNGEN
---	------------------------	-------------------------------------	---	---	----	----	----------------------	------------------------	--------	-----	--

SERIE : R**R 350 4x2****Truck - Porteur - Rigid****voor-avant-front-Vorne**

A124T145ZA75	100	13	825	825	32	32	208	119	1/11+12/9	A01
A124T099ZA75	100	13	825	825	32	32	240	119	1/11+12/9	A01
A124T291ZA75	100	17	825	825	32	32		220	1/11+16/9	A01
F023T047ZA75	100	3/P/P	825	825	32	32	200	110	3/22+P/16+P/16	F01
F023T021ZB75	100	4/P/P	825	825	32	32	200	135	4/22+P/16+P/16	F01

achter-arrière-rear-Hinten

A124T054ZA76	100	8/P/5	825	1000	32	--	225	184	8/14+5/12+P/12	A03A
A124T054ZA75	100	8	825	1000	32	--	225	112	8/14	A03
A124T054HA80	100	5/P	665	665	--	--	132	72	5/12+P/12	A08
F023T074ZA76	100	3/1	825	1000	32	--	160	121	3/26+1/28+P/	F03A
F023T074ZA75	100	3	825	1000	32	--	160	90	3/26	F03
F023T074HA80	100	1	675	675	--	--	120	28	1/28	F08
F023T122ZA75	100	2	860	1015	S24	--	(23)	78	1/18+1/60	F74.31 Lenker

Trekker - Tracteur - Tractor**voor-avant-front-Vorne**

A124T123ZA75	100	12	825	825	32	32	260	110	1/11+11/9	A01
A124T099ZA75	100	13	825	825	32	32	240	119	1/11+12/9	A01
A124T145ZA75	100	13	825	825	32	32	208	119	1/11+12/9	A01
A124T291ZA75	100	17	825	825	32	32		220	1/11+16/9	A01
F023T047ZA75	100	3/P/P	825	825	32	32	200	110	3/22+P/16+P/16	F01
F023T021ZB75	100	4/P/P	825	825	32	32	200	135	4/22+P/16+P/16	F01

achter-arrière-rear-Hinten

A124T148ZA75	100	12	875	1050	32	--	175	156	12/13	A03
A124T070ZA76	100	12/P/5	875	1050	32	--	95	228	12/13+5/12+P/12	A03A
A124T070ZA75	100	12	875	1000	32	--	95	156	12/13	A03
A124T070HA80	100	5/P	665	665	--	--	55	72	5/12+P/12	A08
A124T154ZA70	100	3	760	760	--	--	25	24	3/8	A08
F023T048ZA75	100	4/P	875	1050	32	--	135	155	4/27+P/27	F03
F023T122ZA75	100	2	860	1015	S24	--	(23)	78	1/18+1/60	F74.31 Lenker

BESTELNR N° COMMANDE ORDER NR BESTELNR	BR LRG WID BR	BLADEN LAMES LEAVES BLATT.	B	C	D1	D2	PH FL FA SP	PAK EP TH PAK	DETAIL	MOD	OPMERKINGEN REMARQUES REMARKS BEMERKUNGEN
---	------------------------	-------------------------------------	---	---	----	----	----------------------	------------------------	--------	-----	--

SERIE : R

R 350 6x2

Truck - Porteur - Rigid

voor-avant-front-Vorne

A124T099ZA75	100	13	825	825	32	32	240	119	1/11+12/9	A01
A124T145ZA75	100	13	825	825	32	32	208	119	1/11+12/9	A01
A124T291ZA75	100	17	825	825	32	32		220	1/11+16/9	A01
F023T047ZA75	100	3/P/P	825	825	32	32	200	110	3/22+P/16+P/16	F01
F023T021ZB75	100	4/P/P	825	825	32	32	200	135	4/22+P/16+P/16	F01

achter-arrière-rear-Hinten

A	A124T054ZA76	100	8/P/5	825	1000	32	--	225	184	8/14+5/12+P/12	A03A
A	A124T054ZA75	100	8	825	1000	32	--	225	112	8/14	A03
H	A124T054HA80	100	5/P	665	665	--	--	132	72	5/12+P/12	A08
A	F023T074ZA76	100	3/1	825	1000	32	--	160	121	3/26+1/28+P/	F03A
A	F023T074ZA75	100	3	825	1000	32	--	160	90	3/26	F03
H	F023T074HA80	100	1	675	675	--	--	120	28	1/28	F08
	F023T122ZA75	100	2	860	1015	S24	--	(23)	78	1/18+1/60	F74.31 Lenker

R 370 4x2

Truck - Porteur - Rigid

voor-avant-front-Vorne

A124T099ZA75	100	13	825	825	32	32	240	119	1/11+12/9	A01
A124T145ZA75	100	13	825	825	32	32	208	119	1/11+12/9	A01
A124T291ZA75	100	17	825	825	32	32		220	1/11+16/9	A01
F023T047ZA75	100	3/P/P	825	825	32	32	200	110	3/22+P/16+P/16	F01
F023T021ZB75	100	4/P/P	825	825	32	32	200	135	4/22+P/16+P/16	F01

achter-arrière-rear-Hinten

A	A124T054ZA76	100	8/P/5	825	1000	32	--	225	184	8/14+5/12+P/12	A03A
A	A124T054ZA75	100	8	825	1000	32	--	225	112	8/14	A03
H	A124T054HA80	100	5/P	665	665	--	--	132	72	5/12+P/12	A08
	A124T308ZA76	100	9/2P/P/5	825	1000	32	--		226	9/14+2P/14+6/12	A03A
A	F023T074ZA76	100	3/1	825	1000	32	--	160	121	3/26+1/28+P/	F03A
A	F023T074ZA75	100	3	825	1000	32	--	160	90	3/26	F03
H	F023T074HA80	100	1	675	675	--	--	120	28	1/28	F08
	F023T122ZA75	100	2	860	1015	S24	--	(23)	78	1/18+1/60	F74.31 Lenker

BESTELNR N° COMMANDE ORDER NR BESTELNR	BR LRG WID BR	BLADEN LAMES LEAVES BLATT.	B	C	D1	D2	PH FL FA SP	PAK EP TH PAK	DETAIL	MOD	OPMERKINGEN REMARKS REMARKS BEMERKUNGEN
---	------------------------	-------------------------------------	---	---	----	----	----------------------	------------------------	--------	-----	--

SERIE : R

R 370 6x2

Truck - Porteur - Rigid

voor-avant-front-Vorne

A124T099ZA75	100	13	825	825	32	32	240	119	1/11+12/9	A01
A124T145ZA75	100	13	825	825	32	32	208	119	1/11+12/9	A01
A124T291ZA75	100	17	825	825	32	32		220	1/11+16/9	A01
F023T047ZA75	100	3/P/P	825	825	32	32	200	110	3/22+P/16+P/16	F01
F023T021ZB75	100	4/P/P	825	825	32	32	200	135	4/22+P/16+P/16	F01

achter-arrière-rear-Hinten

A	A124T054ZA76	100	8/P/5	825	1000	32	--	225	184	8/14+5/12+P/12	A03A
A	A124T054ZA75	100	8	825	1000	32	--	225	112	8/14	A03
H	A124T054HA80	100	5/P	665	665	--	--	132	72	5/12+P/12	A08
	A124T308ZA76	100	9/2P/P/5	825	1000	32	--		226	9/14+2P/14+6/12	A03A
A	F023T074ZA76	100	3/1	825	1000	32	--	160	121	3/26+1/28+P/	F03A
A	F023T074ZA75	100	3	825	1000	32	--	160	90	3/26	F03
H	F023T074HA80	100	1	675	675	--	--	120	28	1/28	F08
	F023T122ZA75	100	2	860	1015	S24	--	(23)	78	1/18+1/60	F74.31 Lenker

R 370 6x4

Truck - Porteur - Rigid

voor-avant-front-Vorne

A124T099ZA75	100	13	825	825	32	32	240	119	1/11+12/9	A01
A124T145ZA75	100	13	825	825	32	32	208	119	1/11+12/9	A01

achter-arrière-rear-Hinten

A124T170ZA70	100	7/P	745	745	--	--	30	150	7/20+P/10	A08R
A124T152ZA70	100	9/P	745	745	--	--	15	208	9/22+P/10	A08R

BESTELNR N° COMMANDE ORDER NR BESTELLNR	BR LRG WID BR	BLADEN LAMES LEAVES BLATT.	B	C	D1	D2	PH FL FA SP	PAK EP TH PAK	DETAIL	MOD	OPMERKINGEN REMARQUES REMARKS BEMERKUNGEN
--	------------------------	-------------------------------------	---	---	----	----	----------------------	------------------------	--------	-----	--

SERIE : R**R 370T 4x2****Trekker - Tracteur - Tractor****voor-avant-front-Vorne**

A124T123ZA75	100	12	825	825	32	32	260	110	1/11+11/9	A01
A124T145ZA75	100	13	825	825	32	32	208	119	1/11+12/9	A01
A124T099ZA75	100	13	825	825	32	32	240	119	1/11+12/9	A01
A124T291ZA75	100	17	825	825	32	32		220	1/11+16/9	A01
F023T047ZA75	100	3/P/P	825	825	32	32	200	110	3/22+P/16+P/16	F01
F023T021ZB75	100	4/P/P	825	825	32	32	200	135	4/22+P/16+P/16	F01

achter-arrière-rear-Hinten

	A124T148ZA75	100	12	875	1050	32	--	175	156	12/13	A03
	A124T070ZA76	100	12/P/5	875	1050	32	--	95	228	12/13+5/12+P/12	A03A
A	A124T070ZA75	100	12	875	1000	32	--	95	156	12/13	A03
H	A124T070HA80	100	5/P	665	665	--	--	55	72	5/12+P/12	A08
	A124T154ZA70	100	3	760	760	--	--	25	24	3/8	A08
	F023T048ZA75	100	4/P	875	1050	32	--	135	155	4/27+P/27	F03
	F023T122ZA75	100	2	860	1015	S24	--	(23)	78	1/18+1/60	F74.31 Lenker

BESTELNR N° COMMANDE ORDER NR BESTELNR	BR LRG WID BR	BLADEN LAMES LEAVES BLATT.	B	C	D1	D2	PH FL FA SP	PAK EP TH PAK	DETAIL	MOD	OPMERKINGEN REMARQUES REMARKS BEMERKUNGEN
---	------------------------	-------------------------------------	---	---	----	----	----------------------	------------------------	--------	-----	--

SERIE : R

R 380 4x2

Truck - Porteur - Rigid

voor-avant-front-Vorne

A124T099ZA75	100	13	825	825	32	32	240	119	1/11+12/9	A01
A124T145ZA75	100	13	825	825	32	32	208	119	1/11+12/9	A01
A124T291ZA75	100	17	825	825	32	32		220	1/11+16/9	A01
F023T047ZA75	100	3/P/P	825	825	32	32	200	110	3/22+P/16+P/16	F01
F023T021ZB75	100	4/P/P	825	825	32	32	200	135	4/22+P/16+P/16	F01

achter-arrière-rear-Hinten

A124T054ZA76	100	8/P/5	825	1000	32	--	225	184	8/14+5/12+P/12	A03A
A124T054ZA75	100	8	825	1000	32	--	225	112	8/14	A03
A124T054HA80	100	5/P	665	665	--	--	132	72	5/12+P/12	A08
F023T074ZA76	100	3/1	825	1000	32	--	160	121	3/26+1/28+P/	F03A
F023T074ZA75	100	3	825	1000	32	--	160	90	3/26	F03
F023T074HA80	100	1	675	675	--	--	120	28	1/28	F08
F023T122ZA75	100	2	860	1015	S24	--	(23)	78	1/18+1/60	F74.31 Lenker

Trekker - Tracteur - Tractor

voor-avant-front-Vorne

A124T123ZA75	100	12	825	825	32	32	260	110	1/11+11/9	A01
A124T099ZA75	100	13	825	825	32	32	240	119	1/11+12/9	A01
A124T145ZA75	100	13	825	825	32	32	208	119	1/11+12/9	A01
A124T291ZA75	100	17	825	825	32	32		220	1/11+16/9	A01
F023T047ZA75	100	3/P/P	825	825	32	32	200	110	3/22+P/16+P/16	F01
F023T021ZB75	100	4/P/P	825	825	32	32	200	135	4/22+P/16+P/16	F01

achter-arrière-rear-Hinten

A124T148ZA75	100	12	875	1050	32	--	175	156	12/13	A03
A124T070ZA76	100	12/P/5	875	1050	32	--	95	228	12/13+5/12+P/12	A03A
A124T070ZA75	100	12	875	1000	32	--	95	156	12/13	A03
A124T070HA80	100	5/P	665	665	--	--	55	72	5/12+P/12	A08
A124T154ZA70	100	3	760	760	--	--	25	24	3/8	A08
F023T048ZA75	100	4/P	875	1050	32	--	135	155	4/27+P/27	F03
F023T122ZA75	100	2	860	1015	S24	--	(23)	78	1/18+1/60	F74.31 Lenker

BESTELNR N° COMMANDE ORDER NR BESTELNR	BR LRG WID BR	BLADEN LAMES LEAVES BLATT.	B	C	D1	D2	PH FL FA SP	PAK EP TH PAK	DETAIL	MOD	OPMERKINGEN REMARQUES REMARKS BEMERKUNGEN
---	------------------------	-------------------------------------	---	---	----	----	----------------------	------------------------	--------	-----	--

SERIE : R**R 380 6x2****Truck - Porteur - Rigid****voor-avant-front-Vorne**

A124T099ZA75	100	13	825	825	32	32	240	119	1/11+12/9	A01
A124T145ZA75	100	13	825	825	32	32	208	119	1/11+12/9	A01
A124T291ZA75	100	17	825	825	32	32		220	1/11+16/9	A01
F023T047ZA75	100	3/P/P	825	825	32	32	200	110	3/22+P/16+P/16	F01
F023T021ZB75	100	4/P/P	825	825	32	32	200	135	4/22+P/16+P/16	F01

achter-arrière-rear-Hinten

A124T054ZA76	100	8/P/5	825	1000	32	--	225	184	8/14+5/12+P/12	A03A
A124T054ZA75	100	8	825	1000	32	--	225	112	8/14	A03
A124T054HA80	100	5/P	665	665	--	--	132	72	5/12+P/12	A08
F023T074ZA76	100	3/1	825	1000	32	--	160	121	3/26+1/28+P/	F03A
F023T074ZA75	100	3	825	1000	32	--	160	90	3/26	F03
F023T074HA80	100	1	675	675	--	--	120	28	1/28	F08
F023T122ZA75	100	2	860	1015	S24	--	(23)	78	1/18+1/60	F74.31 Lenker

R 380 6x4**Truck - Porteur - Rigid****voor-avant-front-Vorne**

A124T145ZA75	100	13	825	825	32	32	208	119	1/11+12/9	A01
A124T099ZA75	100	13	825	825	32	32	240	119	1/11+12/9	A01

achter-arrière-rear-Hinten

A124T170ZA70	100	7/P	745	745	--	--	30	150	7/20+P/10	A08R
A124T152ZA70	100	9/P	745	745	--	--	15	208	9/22+P/10	A08R

Trekker - Tracteur - Tractor**voor-avant-front-Vorne**

A124T145ZA75	100	13	825	825	32	32	208	119	1/11+12/9	A01
A124T099ZA75	100	13	825	825	32	32	240	119	1/11+12/9	A01

achter-arrière-rear-Hinten

A124T170ZA70	100	7/P	745	745	--	--	30	150	7/20+P/10	A08R
A124T152ZA70	100	9/P	745	745	--	--	15	208	9/22+P/10	A08R

BESTELNR N° COMMANDE ORDER NR BESTELNR	BR LRG WID BR	BLADEN LAMES LEAVES BLATT.	B	C	D1	D2	PH FL FA SP	PAK EP TH PAK	DETAIL	MOD	OPMERKINGEN REMARKS BEMERKUNGEN
---	------------------------	-------------------------------------	---	---	----	----	----------------------	------------------------	--------	-----	---------------------------------------

SERIE : R

R 385TI 4x2

Truck - Porteur - Rigid

voor-avant-front-Vorne

A124T099ZA75	100	13	825	825	32	32	240	119	1/11+12/9	A01
A124T145ZA75	100	13	825	825	32	32	208	119	1/11+12/9	A01
F023T047ZA75	100	3/P/P	825	825	32	32	200	110	3/22+P/16+P/16	F01
F023T021ZB75	100	4/P/P	825	825	32	32	200	135	4/22+P/16+P/16	F01

achter-arrière-rear-Hinten

A	A124T054ZA76	100	8/P/5	825	1000	32	--	225	184	8/14+5/12+P/12	A03A
H	A124T054ZA75	100	8	825	1000	32	--	225	112	8/14	A03
H	A124T054HA80	100	5/P	665	665	--	--	132	72	5/12+P/12	A08
A	F023T076ZA76	100	3/1	825	1000	32	--	170	128	3/26+1/28+P/	F03A
H	F023T076ZA75	100	3	825	1000	32	--	170	90	3/26	F03
H	F023T076HA80	100	1	670	670	--	--	130	31	1/28	F08
	F023T122ZA75	100	2	860	1015	S24	--	(23)	78	1/18+1/60	F74.31 Lenker

Trekker - Tracteur - Tractor

voor-avant-front-Vorne

A124T123ZA75	100	12	825	825	32	32	260	110	1/11+11/9	A01
A124T145ZA75	100	13	825	825	32	32	208	119	1/11+12/9	A01
A124T099ZA75	100	13	825	825	32	32	240	119	1/11+12/9	A01
F023T047ZA75	100	3/P/P	825	825	32	32	200	110	3/22+P/16+P/16	F01
F023T021ZB75	100	4/P/P	825	825	32	32	200	135	4/22+P/16+P/16	F01

achter-arrière-rear-Hinten

A	A124T148ZA75	100	12	875	1050	32	--	175	156	12/13	A03
H	A124T070ZA76	100	12/P/5	875	1050	32	--	95	228	12/13+5/12+P/12	A03A
H	A124T070ZA75	100	12	875	1000	32	--	95	156	12/13	A03
H	A124T070HA80	100	5/P	665	665	--	--	55	72	5/12+P/12	A08
	F023T092ZA75	100	4/P	875	1050	32	--	135	155	4/27+P/27	F03.10 glijdop/pastille
	F023T122ZA75	100	2	860	1015	S24	--	(23)	78	1/18+1/60	F74.31 Lenker

BESTELNR N° COMMANDE ORDER NR BESTELNR	BR LRG WID BR	BLADEN LAMES LEAVES BLATT.	B	C	D1	D2	PH FL FA SP	PAK EP TH PAK	DETAIL	MOD	OPMERKINGEN REMARKS BEMERKUNGEN
---	------------------------	-------------------------------------	---	---	----	----	----------------------	------------------------	--------	-----	---------------------------------------

SERIE : R**R 385TI 6x2****Truck - Porteur - Rigid****voor-avant-front-Vorne**

A124T099ZA75	100	13	825	825	32	32	240	119	1/11+12/9	A01
A124T145ZA75	100	13	825	825	32	32	208	119	1/11+12/9	A01
F023T047ZA75	100	3/P/P	825	825	32	32	200	110	3/22+P/16+P/16	F01
F023T021ZB75	100	4/P/P	825	825	32	32	200	135	4/22+P/16+P/16	F01

achter-arrière-rear-Hinten

A124T054ZA76	100	8/P/5	825	1000	32	--	225	184	8/14+5/12+P/12	A03A
A124T054ZA75	100	8	825	1000	32	--	225	112	8/14	A03
A124T054HA80	100	5/P	665	665	--	--	132	72	5/12+P/12	A08
F023T122ZA75	100	2	860	1015	S24	--	(23)	78	1/18+1/60	F74.31 Lenker

R 385TI 6x4**Truck - Porteur - Rigid****voor-avant-front-Vorne**

A124T099ZA75	100	13	825	825	32	32	240	119	1/11+12/9	A01
A124T145ZA75	100	13	825	825	32	32	208	119	1/11+12/9	A01
F023T047ZA75	100	3/P/P	825	825	32	32	200	110	3/22+P/16+P/16	F01
F023T021ZB75	100	4/P/P	825	825	32	32	200	135	4/22+P/16+P/16	F01

achter-arrière-rear-Hinten

A124T170ZA70	100	7/P	745	745	--	--	30	150	7/20+P/10	A08R
A124T152ZA70	100	9/P	745	745	--	--	15	208	9/22+P/10	A08R

Trekker - Tracteur - Tractor**voor-avant-front-Vorne**

A124T145ZA75	100	13	825	825	32	32	208	119	1/11+12/9	A01
A124T099ZA75	100	13	825	825	32	32	240	119	1/11+12/9	A01
F023T047ZA75	100	3/P/P	825	825	32	32	200	110	3/22+P/16+P/16	F01
F023T021ZB75	100	4/P/P	825	825	32	32	200	135	4/22+P/16+P/16	F01

achter-arrière-rear-Hinten

A124T170ZA70	100	7/P	745	745	--	--	30	150	7/20+P/10	A08R
A124T152ZA70	100	9/P	745	745	--	--	15	208	9/22+P/10	A08R
A124T294ZA70	100	9/P	770	770	--	--	15	208	9/22+P/10	A08R

BESTELNR N° COMMANDE ORDER NR BESTELNR	BR LRG WID BR	BLADEN LAMES LEAVES BLATT.	B	C	D1	D2	PH FL FA SP	PAK EP TH PAK	DETAIL	MOD	OPMERKINGEN REMARQUES REMARKS BEMERKUNGEN
---	------------------------	-------------------------------------	---	---	----	----	----------------------	------------------------	--------	-----	--

SERIE : R**R 390 4x2****Truck - Porteur - Rigid****voor-avant-front-Vorne**

A124T099ZA75	100	13	825	825	32	32	240	119	1/11+12/9	A01
A124T145ZA75	100	13	825	825	32	32	208	119	1/11+12/9	A01
A124T291ZA75	100	17	825	825	32	32		220	1/11+16/9	A01
F023T047ZA75	100	3/P/P	825	825	32	32	200	110	3/22+P/16+P/16	F01
F023T021ZB75	100	4/P/P	825	825	32	32	200	135	4/22+P/16+P/16	F01

achter-arrière-rear-Hinten

A	A124T054ZA76	100	8/P/5	825	1000	32	--	225	184	8/14+5/12+P/12	A03A
H	A124T054ZA75	100	8	825	1000	32	--	225	112	8/14	A03
H	A124T054HA80	100	5/P	665	665	--	--	132	72	5/12+P/12	A08
	A124T308ZA76	100	9/2P/P/5	825	1000	32	--		226	9/14+2P/14+6/12	A03A
A	F023T074ZA76	100	3/1	825	1000	32	--	160	121	3/26+1/28+P/	F03A
H	F023T074ZA75	100	3	825	1000	32	--	160	90	3/26	F03
H	F023T074HA80	100	1	675	675	--	--	120	28	1/28	F08
	F023T122ZA75	100	2	860	1015	S24	--	(23)	78	1/18+1/60	F74.31 Lenker

R 390 6x2**Truck - Porteur - Rigid****voor-avant-front-Vorne**

A124T099ZA75	100	13	825	825	32	32	240	119	1/11+12/9	A01
A124T145ZA75	100	13	825	825	32	32	208	119	1/11+12/9	A01
A124T291ZA75	100	17	825	825	32	32		220	1/11+16/9	A01
F023T047ZA75	100	3/P/P	825	825	32	32	200	110	3/22+P/16+P/16	F01
F023T021ZB75	100	4/P/P	825	825	32	32	200	135	4/22+P/16+P/16	F01

achter-arrière-rear-Hinten

A	A124T054ZA76	100	8/P/5	825	1000	32	--	225	184	8/14+5/12+P/12	A03A
H	A124T054ZA75	100	8	825	1000	32	--	225	112	8/14	A03
H	A124T054HA80	100	5/P	665	665	--	--	132	72	5/12+P/12	A08
	A124T308ZA76	100	9/2P/P/5	825	1000	32	--		226	9/14+2P/14+6/12	A03A
A	F023T074ZA76	100	3/1	825	1000	32	--	160	121	3/26+1/28+P/	F03A
H	F023T074ZA75	100	3	825	1000	32	--	160	90	3/26	F03
H	F023T074HA80	100	1	675	675	--	--	120	28	1/28	F08
	F023T122ZA75	100	2	860	1015	S24	--	(23)	78	1/18+1/60	F74.31 Lenker

BESTELNR N° COMMANDE ORDER NR BESTELNR	BR LRG WID BR	BLADEN LAMES LEAVES BLATT.	B	C	D1	D2	PH FL FA SP	PAK EP TH PAK	DETAIL	MOD	OPMERKINGEN REMARKS REMARKS BEMERKUNGEN
---	------------------------	-------------------------------------	---	---	----	----	----------------------	------------------------	--------	-----	--

SERIE : R**R 390 6x4****Truck - Porteur - Rigid****voor-avant-front-Vorne**

A124T099ZA75	100	13	825	825	32	32	240	119	1/11+12/9	A01
A124T145ZA75	100	13	825	825	32	32	208	119	1/11+12/9	A01

achter-arrière-rear-Hinten

A124T170ZA70	100	7/P	745	745	--	--	30	150	7/20+P/10	A08R
A124T152ZA70	100	9/P	745	745	--	--	15	208	9/22+P/10	A08R

Trekker - Tracteur - Tractor**voor-avant-front-Vorne**

A124T099ZA75	100	13	825	825	32	32	240	119	1/11+12/9	A01
A124T145ZA75	100	13	825	825	32	32	208	119	1/11+12/9	A01

achter-arrière-rear-Hinten

A124T170ZA70	100	7/P	745	745	--	--	30	150	7/20+P/10	A08R
A124T152ZA70	100	9/P	745	745	--	--	15	208	9/22+P/10	A08R

R 390T 4x2**Trekker - Tracteur - Tractor****voor-avant-front-Vorne**

A124T123ZA75	100	12	825	825	32	32	260	110	1/11+11/9	A01
A124T099ZA75	100	13	825	825	32	32	240	119	1/11+12/9	A01
A124T145ZA75	100	13	825	825	32	32	208	119	1/11+12/9	A01
A124T291ZA75	100	17	825	825	32	32		220	1/11+16/9	A01
F023T047ZA75	100	3/P/P	825	825	32	32	200	110	3/22+P/16+P/16	F01
F023T021ZB75	100	4/P/P	825	825	32	32	200	135	4/22+P/16+P/16	F01

achter-arrière-rear-Hinten

A124T148ZA75	100	12	875	1050	32	--	175	156	12/13	A03	
A124T070ZA76	100	12/P/5	875	1050	32	--	95	228	12/13+5/12+P/12	A03A	
A124T070ZA75	100	12	875	1000	32	--	95	156	12/13	A03	
A124T070HA80	100	5/P	665	665	--	--	55	72	5/12+P/12	A08	
A124T154ZA70	100	3	760	760	--	--	25	24	3/8	A08	
F023T048ZA75	100	4/P	875	1050	32	--	135	155	4/27+P/27	F03	
F023T122ZA75	100	2	860	1015	S24	--	(23)	78	1/18+1/60	F74.31	Lenker

BESTELNR N° COMMANDE ORDER NR BESTELNR	BR LRG WID BR	BLADEN LAMES LEAVES BLATT.	B	C	D1	D2	PH FL FA SP	PAK EP TH PAK	DETAIL	MOD	OPMERKINGEN REMARKS BEMERKUNGEN
---	------------------------	-------------------------------------	---	---	----	----	----------------------	------------------------	--------	-----	---------------------------------------

SERIE : R**R 420 4x2****Truck - Porteur - Rigid****voor-avant-front-Vorne**

A124T099ZA75	100	13	825	825	32	32	240	119	1/11+12/9	A01
A124T145ZA75	100	13	825	825	32	32	208	119	1/11+12/9	A01
A124T291ZA75	100	17	825	825	32	32		220	1/11+16/9	A01
F023T047ZA75	100	3/P/P	825	825	32	32	200	110	3/22+P/16+P/16	F01
F023T021ZB75	100	4/P/P	825	825	32	32	200	135	4/22+P/16+P/16	F01

achter-arrière-rear-Hinten

A	A124T054ZA76	100	8/P/5	825	1000	32	--	225	184	8/14+5/12+P/12	A03A
	A124T054ZA75	100	8	825	1000	32	--	225	112	8/14	A03
H	A124T054HA80	100	5/P	665	665	--	--	132	72	5/12+P/12	A08
	A124T308ZA76	100	9/2P/P/5	825	1000	32	--		226	9/14+2P/14+6/12	A03A
A	F023T074ZA76	100	3/1	825	1000	32	--	160	121	3/26+1/28+P/	F03A
	F023T074ZA75	100	3	825	1000	32	--	160	90	3/26	F03
H	F023T074HA80	100	1	675	675	--	--	120	28	1/28	F08
	F023T122ZA75	100	2	860	1015	S24	--	(23)	78	1/18+1/60	F74.31 Lenker

Trekker - Tracteur - Tractor**voor-avant-front-Vorne**

A124T123ZA75	100	12	825	825	32	32	260	110	1/11+11/9	A01
A124T145ZA75	100	13	825	825	32	32	208	119	1/11+12/9	A01
A124T099ZA75	100	13	825	825	32	32	240	119	1/11+12/9	A01
A124T291ZA75	100	17	825	825	32	32		220	1/11+16/9	A01
F023T047ZA75	100	3/P/P	825	825	32	32	200	110	3/22+P/16+P/16	F01
F023T021ZB75	100	4/P/P	825	825	32	32	200	135	4/22+P/16+P/16	F01

achter-arrière-rear-Hinten

A	A124T148ZA75	100	12	875	1050	32	--	175	156	12/13	A03
	A124T070ZA76	100	12/P/5	875	1050	32	--	95	228	12/13+5/12+P/12	A03A
H	A124T070ZA75	100	12	875	1000	32	--	95	156	12/13	A03
	A124T070HA80	100	5/P	665	665	--	--	55	72	5/12+P/12	A08
	A124T154ZA70	100	3	760	760	--	--	25	24	3/8	A08
	F023T048ZA75	100	4/P	875	1050	32	--	135	155	4/27+P/27	F03
	F023T122ZA75	100	2	860	1015	S24	--	(23)	78	1/18+1/60	F74.31 Lenker

BESTELNR N° COMMANDE ORDER NR BESTELNR	BR LRG WID BR	BLADEN LAMES LEAVES BLATT.	B	C	D1	D2	PH FL FA SP	PAK EP TH PAK	DETAIL	MOD	OPMERKINGEN REMARQUES REMARKS BEMERKUNGEN
---	------------------------	-------------------------------------	---	---	----	----	----------------------	------------------------	--------	-----	--

SERIE : R

R 420 6x2

Truck - Porteur - Rigid

voor-avant-front-Vorne

A124T099ZA75	100	13	825	825	32	32	240	119	1/11+12/9	A01
A124T145ZA75	100	13	825	825	32	32	208	119	1/11+12/9	A01
A124T291ZA75	100	17	825	825	32	32		220	1/11+16/9	A01
F023T047ZA75	100	3/P/P	825	825	32	32	200	110	3/22+P/16+P/16	F01
F023T021ZB75	100	4/P/P	825	825	32	32	200	135	4/22+P/16+P/16	F01

achter-arrière-rear-Hinten

A124T054ZA76	100	8/P/5	825	1000	32	--	225	184	8/14+5/12+P/12	A03A
A124T054ZA75	100	8	825	1000	32	--	225	112	8/14	A03
A124T054HA80	100	5/P	665	665	--	--	132	72	5/12+P/12	A08
A124T308ZA76	100	9/2P/P/5	825	1000	32	--		226	9/14+2P/14+6/12	A03A
F023T074ZA76	100	3/1	825	1000	32	--	160	121	3/26+1/28+P/	F03A
F023T074ZA75	100	3	825	1000	32	--	160	90	3/26	F03
F023T074HA80	100	1	675	675	--	--	120	28	1/28	F08
F023T122ZA75	100	2	860	1015	S24	--	(23)	78	1/18+1/60	F74.31 Lenker

R 420 6x4

Truck - Porteur - Rigid

voor-avant-front-Vorne

A124T099ZA75	100	13	825	825	32	32	240	119	1/11+12/9	A01
A124T145ZA75	100	13	825	825	32	32	208	119	1/11+12/9	A01

achter-arrière-rear-Hinten

A124T170ZA70	100	7/P	745	745	--	--	30	150	7/20+P/10	A08R
A124T152ZA70	100	9/P	745	745	--	--	15	208	9/22+P/10	A08R

Trekker - Tracteur - Tractor

voor-avant-front-Vorne

A124T099ZA75	100	13	825	825	32	32	240	119	1/11+12/9	A01
A124T145ZA75	100	13	825	825	32	32	208	119	1/11+12/9	A01

achter-arrière-rear-Hinten

A124T170ZA70	100	7/P	745	745	--	--	30	150	7/20+P/10	A08R
A124T152ZA70	100	9/P	745	745	--	--	15	208	9/22+P/10	A08R

BESTELNR N° COMMANDE ORDER NR BESTELLNR	BR LRG WID BR	BLADEN LAMES LEAVES BLATT.	B	C	D1	D2	PH FL FA SP	PAK EP TH PAK	DETAIL	MOD	OPMERKINGEN REMARQUES REMARKS BEMERKUNGEN
--	------------------------	-------------------------------------	---	---	----	----	----------------------	------------------------	--------	-----	--

SERIE : R

R 420T 4x2

Trekker - Tracteur - Tractor

voor-avant-front-Vorne

A124T123ZA75	100	12	825	825	32	32	260	110	1/11+11/9	A01
A124T099ZA75	100	13	825	825	32	32	240	119	1/11+12/9	A01
A124T145ZA75	100	13	825	825	32	32	208	119	1/11+12/9	A01
A124T291ZA75	100	17	825	825	32	32		220	1/11+16/9	A01
F023T047ZA75	100	3/P/P	825	825	32	32	200	110	3/22+P/16+P/16	F01
F023T021ZB75	100	4/P/P	825	825	32	32	200	135	4/22+P/16+P/16	F01

achter-arrière-rear-Hinten

	A124T148ZA75	100	12	875	1050	32	--	175	156	12/13	A03
	A124T070ZA76	100	12/P/5	875	1050	32	--	95	228	12/13+5/12+P/12	A03A
A	A124T070ZA75	100	12	875	1000	32	--	95	156	12/13	A03
H	A124T070HA80	100	5/P	665	665	--	--	55	72	5/12+P/12	A08
	A124T154ZA70	100	3	760	760	--	--	25	24	3/8	A08
	F023T048ZA75	100	4/P	875	1050	32	--	135	155	4/27+P/27	F03
	F023T122ZA75	100	2	860	1015	S24	--	(23)	78	1/18+1/60	F74.31 Lenker

BESTELNR N° COMMANDE ORDER NR BESTELNR	BR LRG WID BR	BLADEN LAMES LEAVES BLATT.	B	C	D1	D2	PH FL FA SP	PAK EP TH PAK	DETAIL	MOD	OPMERKINGEN REMARKS BEMERKUNGEN
---	------------------------	-------------------------------------	---	---	----	----	----------------------	------------------------	--------	-----	---------------------------------------

SERIE : R**R 420TI 4x2****Truck - Porteur - Rigid****voor-avant-front-Vorne**

A124T099ZA75	100	13	825	825	32	32	240	119	1/11+12/9	A01
A124T145ZA75	100	13	825	825	32	32	208	119	1/11+12/9	A01
F023T047ZA75	100	3/P/P	825	825	32	32	200	110	3/22+P/16+P/16	F01
F023T021ZB75	100	4/P/P	825	825	32	32	200	135	4/22+P/16+P/16	F01

achter-arrière-rear-Hinten

A	A124T054ZA76	100	8/P/5	825	1000	32	--	225	184	8/14+5/12+P/12	A03A
	A124T054ZA75	100	8	825	1000	32	--	225	112	8/14	A03
H	A124T054HA80	100	5/P	665	665	--	--	132	72	5/12+P/12	A08
A	F023T076ZA76	100	3/1	825	1000	32	--	170	128	3/26+1/28+P/	F03A
	F023T076ZA75	100	3	825	1000	32	--	170	90	3/26	F03
H	F023T076HA80	100	1	670	670	--	--	130	31	1/28	F08
	F023T122ZA75	100	2	860	1015	S24	--	(23)	78	1/18+1/60	F74.31 Lenker

Trekker - Tracteur - Tractor**voor-avant-front-Vorne**

A124T123ZA75	100	12	825	825	32	32	260	110	1/11+11/9	A01
A124T099ZA75	100	13	825	825	32	32	240	119	1/11+12/9	A01
A124T145ZA75	100	13	825	825	32	32	208	119	1/11+12/9	A01
F023T047ZA75	100	3/P/P	825	825	32	32	200	110	3/22+P/16+P/16	F01
F023T021ZB75	100	4/P/P	825	825	32	32	200	135	4/22+P/16+P/16	F01

achter-arrière-rear-Hinten

A124T148ZA75	100	12	875	1050	32	--	175	156	12/13	A03	
A	A124T070ZA76	100	12/P/5	875	1050	32	--	95	228	12/13+5/12+P/12	A03A
	A124T070ZA75	100	12	875	1000	32	--	95	156	12/13	A03
H	A124T070HA80	100	5/P	665	665	--	--	55	72	5/12+P/12	A08
	F023T092ZA75	100	4/P	875	1050	32	--	135	155	4/27+P/27	F03.10 glijdop/pastille
	F023T122ZA75	100	2	860	1015	S24	--	(23)	78	1/18+1/60	F74.31 Lenker

BESTELNR N° COMMANDE ORDER NR BESTELNR	BR LRG WID BR	BLADEN LAMES LEAVES BLATT.	B	C	D1	D2	PH FL FA SP	PAK EP TH PAK	DETAIL	MOD	OPMERKINGEN REMARKS BEMERKUNGEN
---	------------------------	-------------------------------------	---	---	----	----	----------------------	------------------------	--------	-----	---------------------------------------

SERIE : R**R 420TI 6x2****Truck - Porteur - Rigid****voor-avant-front-Vorne**

A124T145ZA75	100	13	825	825	32	32	208	119	1/11+12/9	A01
A124T099ZA75	100	13	825	825	32	32	240	119	1/11+12/9	A01
F023T047ZA75	100	3/P/P	825	825	32	32	200	110	3/22+P/16+P/16	F01
F023T021ZB75	100	4/P/P	825	825	32	32	200	135	4/22+P/16+P/16	F01

achter-arrière-rear-Hinten

A124T054ZA76	100	8/P/5	825	1000	32	--	225	184	8/14+5/12+P/12	A03A
A124T054ZA75	100	8	825	1000	32	--	225	112	8/14	A03
A124T054HA80	100	5/P	665	665	--	--	132	72	5/12+P/12	A08
F023T122ZA75	100	2	860	1015	S24	--	(23)	78	1/18+1/60	F74.31 Lenker

R 420TI 6x4**Truck - Porteur - Rigid****voor-avant-front-Vorne**

A124T099ZA75	100	13	825	825	32	32	240	119	1/11+12/9	A01
A124T145ZA75	100	13	825	825	32	32	208	119	1/11+12/9	A01
F023T047ZA75	100	3/P/P	825	825	32	32	200	110	3/22+P/16+P/16	F01
F023T021ZB75	100	4/P/P	825	825	32	32	200	135	4/22+P/16+P/16	F01

achter-arrière-rear-Hinten

A124T170ZA70	100	7/P	745	745	--	--	30	150	7/20+P/10	A08R
A124T152ZA70	100	9/P	745	745	--	--	15	208	9/22+P/10	A08R

Trekker - Tracteur - Tractor**voor-avant-front-Vorne**

A124T099ZA75	100	13	825	825	32	32	240	119	1/11+12/9	A01
A124T145ZA75	100	13	825	825	32	32	208	119	1/11+12/9	A01
F023T047ZA75	100	3/P/P	825	825	32	32	200	110	3/22+P/16+P/16	F01
F023T021ZB75	100	4/P/P	825	825	32	32	200	135	4/22+P/16+P/16	F01

achter-arrière-rear-Hinten

A124T170ZA70	100	7/P	745	745	--	--	30	150	7/20+P/10	A08R
A124T152ZA70	100	9/P	745	745	--	--	15	208	9/22+P/10	A08R
A124T294ZA70	100	9/P	770	770	--	--	15	208	9/22+P/10	A08R

BESTELNR N° COMMANDE ORDER NR BESTELNR	BR LRG WID BR	BLADEN LAMES LEAVES BLATT.	B	C	D1	D2	PH FL FA SP	PAK EP TH PAK	DETAIL	MOD	OPMERKINGEN REMARKS BEMERKUNGEN
---	------------------------	-------------------------------------	---	---	----	----	----------------------	------------------------	--------	-----	---------------------------------------

SERIE : R**R 6X4TS 4x2****Truck - Porteur - Rigid****voor-avant-front-Vorne**

A124T145ZA75	100	13	825	825	32	32	208	119	1/11+12/9	A01
A124T099ZA75	100	13	825	825	32	32	240	119	1/11+12/9	A01
F023T047ZA75	100	3/P/P	825	825	32	32	200	110	3/22+P/16+P/16	F01
F023T021ZB75	100	4/P/P	825	825	32	32	200	135	4/22+P/16+P/16	F01

achter-arrière-rear-Hinten

A	A124T054ZA76	100	8/P/5	825	1000	32	--	225	184	8/14+5/12+P/12	A03A
	A124T054ZA75	100	8	825	1000	32	--	225	112	8/14	A03
H	A124T054HA80	100	5/P	665	665	--	--	132	72	5/12+P/12	A08
A	F023T076ZA76	100	3/1	825	1000	32	--	170	128	3/26+1/28+P/	F03A
	F023T076ZA75	100	3	825	1000	32	--	170	90	3/26	F03
H	F023T076HA80	100	1	670	670	--	--	130	31	1/28	F08
	F023T122ZA75	100	2	860	1015	S24	--	(23)	78	1/18+1/60	F74.31 Lenker

Trekker - Tracteur - Tractor**voor-avant-front-Vorne**

A124T123ZA75	100	12	825	825	32	32	260	110	1/11+11/9	A01
A124T145ZA75	100	13	825	825	32	32	208	119	1/11+12/9	A01
A124T099ZA75	100	13	825	825	32	32	240	119	1/11+12/9	A01
F023T047ZA75	100	3/P/P	825	825	32	32	200	110	3/22+P/16+P/16	F01
F023T021ZB75	100	4/P/P	825	825	32	32	200	135	4/22+P/16+P/16	F01

achter-arrière-rear-Hinten

A124T148ZA75	100	12	875	1050	32	--	175	156	12/13	A03	
A	A124T070ZA76	100	12/P/5	875	1050	32	--	95	228	12/13+5/12+P/12	A03A
	A124T070ZA75	100	12	875	1000	32	--	95	156	12/13	A03
H	A124T070HA80	100	5/P	665	665	--	--	55	72	5/12+P/12	A08
	F023T092ZA75	100	4/P	875	1050	32	--	135	155	4/27+P/27	F03.10 glijdop/pastille
	F023T122ZA75	100	2	860	1015	S24	--	(23)	78	1/18+1/60	F74.31 Lenker

BESTELNR N° COMMANDE ORDER NR BESTELNR	BR LRG WID BR	BLADEN LAMES LEAVES BLATT.	B	C	D1	D2	PH FL FA SP	PAK EP TH PAK	DETAIL	MOD	OPMERKINGEN REMARKS BEMERKUNGEN
---	------------------------	-------------------------------------	---	---	----	----	----------------------	------------------------	--------	-----	---------------------------------------

SERIE : R**R 6X4TS 6x2****Truck - Porteur - Rigid****voor-avant-front-Vorne**

A124T099ZA75	100	13	825	825	32	32	240	119	1/11+12/9	A01
A124T145ZA75	100	13	825	825	32	32	208	119	1/11+12/9	A01
F023T047ZA75	100	3/P/P	825	825	32	32	200	110	3/22+P/16+P/16	F01
F023T021ZB75	100	4/P/P	825	825	32	32	200	135	4/22+P/16+P/16	F01

achter-arrière-rear-Hinten

A124T054ZA76	100	8/P/5	825	1000	32	--	225	184	8/14+5/12+P/12	A03A
A124T054ZA75	100	8	825	1000	32	--	225	112	8/14	A03
A124T054HA80	100	5/P	665	665	--	--	132	72	5/12+P/12	A08
F023T122ZA75	100	2	860	1015	S24	--	(23)	78	1/18+1/60	F74.31 Lenker

R 6X4TS 6x4**Truck - Porteur - Rigid****voor-avant-front-Vorne**

A124T099ZA75	100	13	825	825	32	32	240	119	1/11+12/9	A01
A124T145ZA75	100	13	825	825	32	32	208	119	1/11+12/9	A01
F023T047ZA75	100	3/P/P	825	825	32	32	200	110	3/22+P/16+P/16	F01
F023T021ZB75	100	4/P/P	825	825	32	32	200	135	4/22+P/16+P/16	F01

achter-arrière-rear-Hinten

A124T170ZA70	100	7/P	745	745	--	--	30	150	7/20+P/10	A08R
A124T152ZA70	100	9/P	745	745	--	--	15	208	9/22+P/10	A08R

Trekker - Tracteur - Tractor**voor-avant-front-Vorne**

A124T099ZA75	100	13	825	825	32	32	240	119	1/11+12/9	A01
A124T145ZA75	100	13	825	825	32	32	208	119	1/11+12/9	A01
F023T047ZA75	100	3/P/P	825	825	32	32	200	110	3/22+P/16+P/16	F01
F023T021ZB75	100	4/P/P	825	825	32	32	200	135	4/22+P/16+P/16	F01

achter-arrière-rear-Hinten

A124T170ZA70	100	7/P	745	745	--	--	30	150	7/20+P/10	A08R
A124T152ZA70	100	9/P	745	745	--	--	15	208	9/22+P/10	A08R
A124T294ZA70	100	9/P	770	770	--	--	15	208	9/22+P/10	A08R

BESTELNR N° COMMANDE ORDER NR BESTELNR	BR LRG WID BR	BLADEN LAMES LEAVES BLATT.	B	C	D1	D2	PH FL FA SP	PAK EP TH PAK	DETAIL	MOD	OPMERKINGEN REMARQUES REMARKS BEMERKUNGEN
---	------------------------	-------------------------------------	---	---	----	----	----------------------	------------------------	--------	-----	--

SERIE : R**RI 357 4x2****Truck - Porteur - Rigid****voor-avant-front-Vorne**

A124T099ZA75	100	13	825	825	32	32	240	119	1/11+12/9	A01
A124T145ZA75	100	13	825	825	32	32	208	119	1/11+12/9	A01
A124T291ZA75	100	17	825	825	32	32		220	1/11+16/9	A01
F023T047ZA75	100	3/P/P	825	825	32	32	200	110	3/22+P/16+P/16	F01
F023T021ZB75	100	4/P/P	825	825	32	32	200	135	4/22+P/16+P/16	F01

achter-arrière-rear-Hinten

A124T054ZA76	100	8/P/5	825	1000	32	--	225	184	8/14+5/12+P/12	A03A
A124T054ZA75	100	8	825	1000	32	--	225	112	8/14	A03
A124T054HA80	100	5/P	665	665	--	--	132	72	5/12+P/12	A08
F023T074ZA76	100	3/1	825	1000	32	--	160	121	3/26+1/28+P/	F03A
F023T074ZA75	100	3	825	1000	32	--	160	90	3/26	F03
F023T074HA80	100	1	675	675	--	--	120	28	1/28	F08
F023T122ZA75	100	2	860	1015	S24	--	(23)	78	1/18+1/60	F74.31 Lenker

Trekker - Tracteur - Tractor**voor-avant-front-Vorne**

A124T123ZA75	100	12	825	825	32	32	260	110	1/11+11/9	A01
A124T099ZA75	100	13	825	825	32	32	240	119	1/11+12/9	A01
A124T145ZA75	100	13	825	825	32	32	208	119	1/11+12/9	A01
A124T291ZA75	100	17	825	825	32	32		220	1/11+16/9	A01
F023T047ZA75	100	3/P/P	825	825	32	32	200	110	3/22+P/16+P/16	F01
F023T021ZB75	100	4/P/P	825	825	32	32	200	135	4/22+P/16+P/16	F01

achter-arrière-rear-Hinten

A124T148ZA75	100	12	875	1050	32	--	175	156	12/13	A03
A124T070ZA76	100	12/P/5	875	1050	32	--	95	228	12/13+5/12+P/12	A03A
A124T070ZA75	100	12	875	1000	32	--	95	156	12/13	A03
A124T070HA80	100	5/P	665	665	--	--	55	72	5/12+P/12	A08
A124T154ZA70	100	3	760	760	--	--	25	24	3/8	A08
F023T048ZA75	100	4/P	875	1050	32	--	135	155	4/27+P/27	F03
F023T122ZA75	100	2	860	1015	S24	--	(23)	78	1/18+1/60	F74.31 Lenker

BESTELNR N° COMMANDE ORDER NR BESTELNR	BR LRG WID BR	BLADEN LAMES LEAVES BLATT.	B	C	D1	D2	PH FL FA SP	PAK EP TH PAK	DETAIL	MOD	OPMERKINGEN REMARQUES REMARKS BEMERKUNGEN
---	------------------------	-------------------------------------	---	---	----	----	----------------------	------------------------	--------	-----	--

SERIE : R**RI 357 6x2****Truck - Porteur - Rigid****voor-avant-front-Vorne**

A124T099ZA75	100	13	825	825	32	32	240	119	1/11+12/9	A01
A124T145ZA75	100	13	825	825	32	32	208	119	1/11+12/9	A01
A124T291ZA75	100	17	825	825	32	32		220	1/11+16/9	A01
F023T047ZA75	100	3/P/P	825	825	32	32	200	110	3/22+P/16+P/16	F01
F023T021ZB75	100	4/P/P	825	825	32	32	200	135	4/22+P/16+P/16	F01

achter-arrière-rear-Hinten

A124T054ZA76	100	8/P/5	825	1000	32	--	225	184	8/14+5/12+P/12	A03A
A124T054ZA75	100	8	825	1000	32	--	225	112	8/14	A03
A124T054HA80	100	5/P	665	665	--	--	132	72	5/12+P/12	A08
F023T074ZA76	100	3/1	825	1000	32	--	160	121	3/26+1/28+P/	F03A
F023T074ZA75	100	3	825	1000	32	--	160	90	3/26	F03
F023T074HA80	100	1	675	675	--	--	120	28	1/28	F08
F023T122ZA75	100	2	860	1015	S24	--	(23)	78	1/18+1/60	F74.31 Lenker

RI 357 6x4**Truck - Porteur - Rigid****voor-avant-front-Vorne**

A124T099ZA75	100	13	825	825	32	32	240	119	1/11+12/9	A01
A124T145ZA75	100	13	825	825	32	32	208	119	1/11+12/9	A01

achter-arrière-rear-Hinten

A124T170ZA70	100	7/P	745	745	--	--	30	150	7/20+P/10	A08R
A124T152ZA70	100	9/P	745	745	--	--	15	208	9/22+P/10	A08R

Trekker - Tracteur - Tractor**voor-avant-front-Vorne**

A124T099ZA75	100	13	825	825	32	32	240	119	1/11+12/9	A01
A124T145ZA75	100	13	825	825	32	32	208	119	1/11+12/9	A01

achter-arrière-rear-Hinten

A124T170ZA70	100	7/P	745	745	--	--	30	150	7/20+P/10	A08R
A124T152ZA70	100	9/P	745	745	--	--	15	208	9/22+P/10	A08R

BESTELNR N° COMMANDE ORDER NR BESTELNR	BR LRG WID BR	BLADEN LAMES LEAVES BLATT.	B	C	D1	D2	PH FL FA SP	PAK EP TH PAK	DETAIL	MOD	OPMERKINGEN REMARQUES REMARKS BEMERKUNGEN
---	------------------------	-------------------------------------	---	---	----	----	----------------------	------------------------	--------	-----	--

SERIE : TRAFFIC

ALL

achter-arrière-rear-Hinten

F023T078ZA75	70	1	630	630	S14	R34	110	16	1/16	F01
F023T124ZA75	70	1	635	635	S14	R34	102	17	1/17	F01
F023T136ZA75	70	2	635	635	S22	R34	117	33	2/15	F01.10
F023T056ZA75	70	2	635	635	S14	R34	120	29	2/13	F01.10



DIAM	DR	BESTELNUMMER N° DE CDE ORDER NUMBER BESTELLNR	B(1)	B(2)	L(1)	L(2)	HD(1)	HD(2)	PL	OPMERKINGEN REMARQUES REMARKS BEMERKUNGEN
------	----	--	------	------	------	------	-------	-------	----	--

Vorm* : B05

(*) Vorm : Forme/Shape/Form

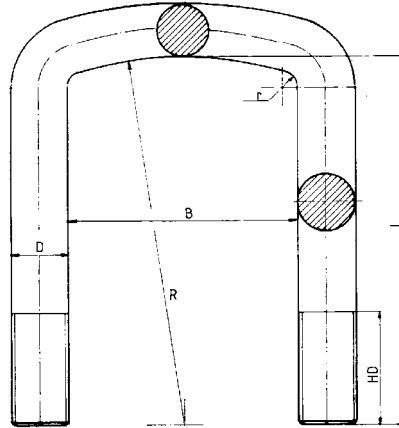

14.0	M14*1.5	B124M14A017	79		105		65			RVI
14.0	M14*1.5	B124M14A019	86	78	130		60			RVI
18.0	M18*1.5	B124M18A032	162		270		60			RVI
20.0	M20*2.5	B124M20A003	93		197		55			RVI
	M20*2.5	B124M20A035	93		214		55		B124M20A040	RVI
	M20*2.5	B124M20A040	93		226		100			RVI
	M20*2.5	B124M20A030	93		255		80			RVI
	M20*2.5	B124M20A053	93		285		75			RVI
	M20*2.5	B124M20A028	93		310		75			RVI
	M20*2.5	B124M20A011	93		400		75			RVI
20.0	M20*2.5	B124M20A017	102		195		60			RVI
	M20*2.5	B124M20A046	102		350		100			RVI
20.0	M20*2.5	B124M20A026	103		220		100			RVI
	M20*2.5	B124M20A023	103		285		100			RVI
22.0	M22*2.5	B124M22A001	93		420		80			RVI
24.0	M24*2	B124M24A005	93		475		80			RVI
27.0	M27*2	B124M27A005	103		485		180			RVI



DIAM	DR	BESTELNUMMER N° DE CDE ORDER NUMBER BESTELLNR	B(1)	B(2)	L(1)	L(2)	HD(1)	HD(2)	PL	OPMERKINGEN REMARQUES REMARKS BEMERKUNGEN
------	----	--	------	------	------	------	-------	-------	----	--

Vorm* : B05

(*) *Vorm : Forme/Shape/Form*

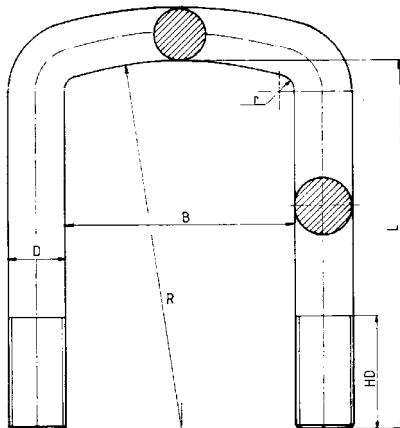



DIAM	DR	BESTELNUMMER N° DE CDE ORDER NUMBER BESTELLNR	B(1)	B(2)	L(1)	L(2)	HD(1)	HD(2)	PL	OPMERKINGEN REMARQUES REMARKS BEMERKUNGEN
------	----	--	------	------	------	------	-------	-------	----	--

Vorm* : B09

(*) *Vorm : Forme/Shape/Form*

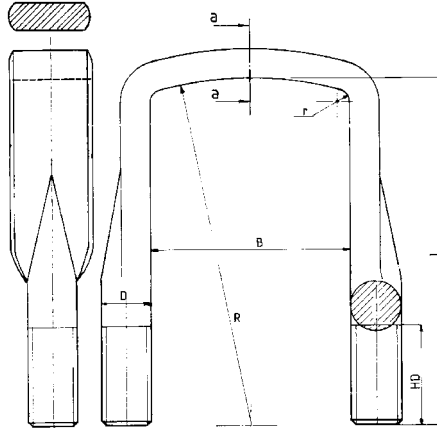

20.0	M20*1.5	B025M20B013	82		341	70	130			RVI
	M20*1.5	B025M20B003	82		390	70	130			RVI
	M20*1.5	B025M20B009	82		505	90				RVI
24.0	M24*2	B124M24B003	92		410	65				RVI
	M24*2	B124M24B005	92		465	65				RVI
24.0	M24*2	B025M24B001	101		460	120				RVI



DIAM	DR	BESTELNUMMER N° DE CDE ORDER NUMBER BESTELLNR	B(1)	B(2)	L(1)	L(2)	HD(1)	HD(2)	PL	OPMERKINGEN REMARQUES REMARKS BEMERKUNGEN
------	----	--	------	------	------	------	-------	-------	----	--

Vorm* : B15

(*) Vorm : Forme/Shape/Form

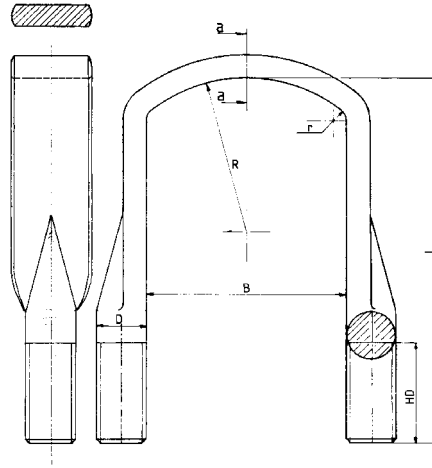

24.0	M24*2	B124M24B010	92		388		80	80		RVI
	M24*2	B124M24B011	92		428		80	80		RVI
	M24*2	B124M24B015	92		490		80	140		RVI
24.0	M24*2	B124M24B014	101		415		80	80		RVI
27.0	M27*2	B124M27B015	92		527		70			RVI
27.0	M27*2	B124M27B005	101		445		70			RVI
	M27*2	B124M27B007	101		470		70			RVI
	M27*2	B124M27B008	101		490		70			RVI
	M27*2	B124M27B009	101		505		70			RVI
	M27*2	B124M27B001	101		520		70			RVI
	M27*2	B124M27B013	101		540		70			RVI
	M27*2	B124M27B010	101		560		70			RVI
	M27*2	B124M27B022	101		630		150			RVI
30.0	M30*2	B124M30B001	121		408		70			RVI



DIAM	DR	BESTELNUMMER N° DE CDE ORDER NUMBER BESTELLNR	B(1)	B(2)	L(1)	L(2)	HD(1)	HD(2)	PL	OPMERKINGEN REMARQUES REMARKS BEMERKUNGEN
------	----	--	------	------	------	------	-------	-------	----	--

Vorm* : B16

(*) *Vorm : Forme/Shape/Form*

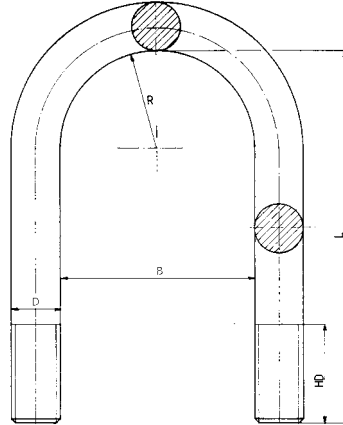

12.0	M12*1.5	B124M12A003	66		170		80			RVI
20.0	M20*1.5	B124M20A047	92		200		60			RVI
	M20*1.5	B124M20A049	92		245		80			RVI
	M20*1.5	B124M20A050	92		280		80			RVI
	M20*1.5	B124M20A052	92		325		80			RVI



DIAM	DR	BESTELNUMMER N° DE CDE ORDER NUMBER BESTELLNR	B(1)	B(2)	L(1)	L(2)	HD(1)	HD(2)	PL	OPMERKINGEN REMARQUES REMARKS BEMERKUNGEN
------	----	--	------	------	------	------	-------	-------	----	--

Vorm* : B18

(*) *Vorm : Forme/Shape/Form*

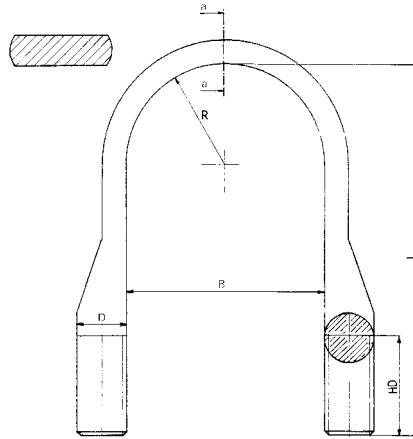

24.0	M24*2	B124M24B013	102		295		80		130		RVI
	M24*2	B124M24B001	102		380		80		130	B124M24B009	RVI
	M24*2	B124M24B009	102		380		140		130		RVI
	M24*2	B124M24B008	102		440		100		130		RVI
27.0	M27*2	B124M27B018	102		415		120		230		RVI



	Vorm	Dia	B(1)	B(2)	L(1)	L(2)	HD1	HD2
A025B003ZA75	Veerstrop ; Bride ; U Bolt ; Federbride :							
	B025M20A006	B05 20.0	102		210		70	
A025B005ZA75	Veerstrop ; Bride ; U Bolt ; Federbride :							
	B025M20A006	B05 20.0	102		210		70	
A025B006ZA75	Veerstrop ; Bride ; U Bolt ; Federbride :							
	B025M20A002	B16 20.0	118		290		70	
A025B007ZA75	Veerstrop ; Bride ; U Bolt ; Federbride :							
	B025M20A006	B05 20.0	102		210		70	
A025B008ZA75	Veerstrop ; Bride ; U Bolt ; Federbride :							
	B025M20A002	B16 20.0	118		290		70	
A025B009ZA75	Pen ; Axe ; Pin ; Bolzen :							
	C234274	in D						
	C234275	in B en C						
A025B010ZA75	Veerstrop ; Bride ; U Bolt ; Federbride :							
	B025M20A002	B16 20.0	118		290		70	
A025B016ZA75	Veerstrop ; Bride ; U Bolt ; Federbride :							
	B025M20B007	B09 20.0	82		350		55	
	Pen ; Axe ; Pin ; Bolzen :							
	YC061P24092	in B						
A025B030ZA76	Veerstrop ; Bride ; U Bolt ; Federbride :							
	B025M20B005	B09 20.0	82		438		55	
	Pen ; Axe ; Pin ; Bolzen :							
	YC061P24092	in B						
A025T036ZA75	Veerstrop ; Bride ; U Bolt ; Federbride :							
	B025M18A016	B01 18.0	72		316		55	
A025T049AA75	Veerstrop ; Bride ; U Bolt ; Federbride :							
	B025M16A011	B01 16.0	72		172		55	
	Pen ; Axe ; Pin ; Bolzen :							
	YC124C401161	in B						



	Vorm	Dia	B(1)	B(2)	L(1)	L(2)	HD1	HD2
A025T049ZA75	Veerstrop ; Bride ; U Bolt ; Federbride :							
	B025M16A009	B01	16.0	72		156		55
	Pen ; Axe ; Pin ; Bolzen :		YC124C401161 in B					
A025T056ZA75	Veerstrop ; Bride ; U Bolt ; Federbride :							
	B025M20B004	B09	20.0	82		427		55
	Pen ; Axe ; Pin ; Bolzen :		YC061P24092 in B					
A025T061AA75	Veerstrop ; Bride ; U Bolt ; Federbride :							
	B124M18A024	B05	18.0	82		220		70
	Pen ; Axe ; Pin ; Bolzen :		YC124C401162 in B					
A025T061ZA75	Veerstrop ; Bride ; U Bolt ; Federbride :							
	B124M18A013	B05	18.0	82		210		70
	Pen ; Axe ; Pin ; Bolzen :		YC124C401162 in B					
A025T071AA75	Veerstrop ; Bride ; U Bolt ; Federbride :							
	B124M18A013	B05	18.0	82		210		70
	Pen ; Axe ; Pin ; Bolzen :		YC124C401162 in B					
A025T071ZA75	Veerstrop ; Bride ; U Bolt ; Federbride :							
	B124M18A023	B05	18.0	82		200		70
	Pen ; Axe ; Pin ; Bolzen :		YC124C401162 in B					
A025T079ZA75	Veerstrop ; Bride ; U Bolt ; Federbride :							
	B025M16A011	B01	16.0	72		172		55
	Pen ; Axe ; Pin ; Bolzen :		YC124C401161 in B					
A025T081ZA75	Veerstrop ; Bride ; U Bolt ; Federbride :							
	B025M16A011	B01	16.0	72		172		55
	Pen ; Axe ; Pin ; Bolzen :		YC124C401161 in B					
A025T082ZA76	Veerstrop ; Bride ; U Bolt ; Federbride :							
	B025M20B009	B09	20.0	82		505		90
	Pen ; Axe ; Pin ; Bolzen :		YC061P24092 in B					



	Vorm	Dia	B(1)	B(2)	L(1)	L(2)	HD1	HD2
A025T083ZA75	Veerstrop ; Bride ; U Bolt ; Federbride :							
	B124M18A013	B05	18.0	82		210		70
	Pen ; Axe ; Pin ; Bolzen :							
	YC124C401162	in B						
A025T084ZA76	Veerstrop ; Bride ; U Bolt ; Federbride :							
	B124M18A019	B01	18.0	72		381		55
	Pen ; Axe ; Pin ; Bolzen :							
	YC061P24080	in B						
A025T085ZA75	Veerstrop ; Bride ; U Bolt ; Federbride :							
	B025M20A007	B05	20.0	83		194		70
	Pen ; Axe ; Pin ; Bolzen :							
	YC124C401161	in B						
A025T086ZA76	Veerstrop ; Bride ; U Bolt ; Federbride :							
	B025M20B009	B09	20.0	82		505		90
	Pen ; Axe ; Pin ; Bolzen :							
	YC061P24092	in B						
A025T087ZA75	Veerstrop ; Bride ; U Bolt ; Federbride :							
	B025M20A007	B05	20.0	83		194		70
	Pen ; Axe ; Pin ; Bolzen :							
	YC124C401161	in B						
A025T090ZA76	Veerstrop ; Bride ; U Bolt ; Federbride :							
	B025M20B009	B09	20.0	82		505		90
A025T096ZA75	Veerstrop ; Bride ; U Bolt ; Federbride :							
	B025M20B004	B09	20.0	82		427		55
	Pen ; Axe ; Pin ; Bolzen :							
	YC061P24092	in B						
A025T098ZA75	Veerstrop ; Bride ; U Bolt ; Federbride :							
	B124M18A017	B01	18.0	72		301		55
	B124M18A018	B01	18.0	72		316		55
	B025M18A016	B01	18.0	72		316		55
	Pen ; Axe ; Pin ; Bolzen :							
	YC061P24080	in B						
A025T100ZA75	Veerstrop ; Bride ; U Bolt ; Federbride :							
	B025M20B012	B09	20.0	82		310		70
	Pen ; Axe ; Pin ; Bolzen :							
	YC061P24080	in B						



	Vorm	Dia	B(1)	B(2)	L(1)	L(2)	HD1	HD2
A025T102ZA75	<i>Veerstrop ; Bride ; U Bolt ; Federbride :</i>							
	B124M18A018	B01	18.0	72		316		55
	B025M18A016	B01	18.0	72		316		55
	<i>Pen ; Axe ; Pin ; Bolzen :</i>							
	YC061P24080	in B						
A025T104ZA75	<i>Veerstrop ; Bride ; U Bolt ; Federbride :</i>							
	B124M18A015	B01	18.0	72		282		55
	<i>Pen ; Axe ; Pin ; Bolzen :</i>							
	YC061P24080	in B						
A025T106ZA76	<i>Veerstrop ; Bride ; U Bolt ; Federbride :</i>							
	B025M20B008	B09	20.0	82		472		55
	<i>Pen ; Axe ; Pin ; Bolzen :</i>							
	YC061P24092	in B						
A025T108ZA75	<i>Veerstrop ; Bride ; U Bolt ; Federbride :</i>							
	B025M20B003	B09	20.0	82		390		70
A025T110ZA75	<i>Veerstrop ; Bride ; U Bolt ; Federbride :</i>							
	B025M20B003	B09	20.0	82		390		70
A124T021ZB75	<i>Pen ; Axe ; Pin ; Bolzen :</i>							
	YC124C401138	GBH in B						
A124T022ZA70	<i>Veerstrop ; Bride ; U Bolt ; Federbride :</i>							
	B124M30B001	B15	30.0	121		408		70
A124T022ZB70	<i>Veerstrop ; Bride ; U Bolt ; Federbride :</i>							
	B124M30B001	B15	30.0	121		408		70
A124T024ZB75	<i>Veerstrop ; Bride ; U Bolt ; Federbride :</i>							
	B124M27B005	B15	27.0	101		445		70
	<i>Pen ; Axe ; Pin ; Bolzen :</i>							
	YC124C401132	in B						
A124T027ZB75	<i>Pen ; Axe ; Pin ; Bolzen :</i>							
	YC124C401138	GBH in B						
A124T032ZB70	<i>Veerstrop ; Bride ; U Bolt ; Federbride :</i>							
	B124M30B001	B15	30.0	121		408		70



	Vorm	Dia	B(1)	B(2)	L(1)	L(2)	HD1	HD2
A124T033ZA75	Veerstrop ; Bride ; U Bolt ; Federbride :							
	B124M20A003	B05	20.0	93		197	55	
A124T037ZA75	Veerstrop ; Bride ; U Bolt ; Federbride :							
	B124M20A040	B05	20.0	93		226	100	
	Pen ; Axe ; Pin ; Bolzen :							
	YC124C401138	in B en C						
A124T043ZA75	Veerstrop ; Bride ; U Bolt ; Federbride :							
	B124M20A017	B05	20.0	102		195	60	
	Pen ; Axe ; Pin ; Bolzen :							
	YC124C401132	bout in B en C						
A124T050ZA76	Veerstrop ; Bride ; U Bolt ; Federbride :							
	B124M24A005	B05	24.0	93		475	80	
A124T051ZA75	Veerstrop ; Bride ; U Bolt ; Federbride :							
	B124M20A003	B05	20.0	93		197	55	
A124T054ZA76	Veerstrop ; Bride ; U Bolt ; Federbride :							
	B124M27B008	B15	27.0	101		490	70	
	Pen ; Axe ; Pin ; Bolzen :							
	YC124C401134	in B						
A124T054ZC76	Veerstrop ; Bride ; U Bolt ; Federbride :							
	B124M27B001	B15	27.0	101		520	70	
	Pen ; Axe ; Pin ; Bolzen :							
	YC124C401134	bout in B						
A124T057ZA75	Veerstrop ; Bride ; U Bolt ; Federbride :							
	B124M20A040	B05	20.0	93		226	100	
	Pen ; Axe ; Pin ; Bolzen :							
	YC124C401138	bout in B en C						
A124T059ZA75	Veerstrop ; Bride ; U Bolt ; Federbride :							
	B124M18A006	B05	18.0	77		200	50	
A124T064ZA76	Veerstrop ; Bride ; U Bolt ; Federbride :							
	B124M24A003	B05	24.0	93		430	80	



	Vorm	Dia	B(1)	B(2)	L(1)	L(2)	HD1	HD2	
A124T066ZA76	<i>Veerstrop ; Bride ; U Bolt ; Federbride :</i>								
	B124M27B008	B15	27.0	101		490		70	
<i>Pen ; Axe ; Pin ; Bolzen :</i>									
YC124C401132		bout in B							
A124T067ZA75	<i>Veerstrop ; Bride ; U Bolt ; Federbride :</i>								
	B124M20A003	B05	20.0	93		197		55	
<i>Pen ; Axe ; Pin ; Bolzen :</i>									
YC124C401133		bout in B en C							
A124T068ZA76	<i>Veerstrop ; Bride ; U Bolt ; Federbride :</i>								
	B124M20A011	B05	20.0	93		400		75	
A124T070ZA76	<i>Veerstrop ; Bride ; U Bolt ; Federbride :</i>								
	B124M27B008	B15	27.0	101		490		70	
	B124M27B001	B15	27.0	101		520		70	
	B124M27B014	B15	27.0	101		590		70	
<i>Pen ; Axe ; Pin ; Bolzen :</i>									
YC124C401134		in B							
A124T071ZA75	<i>Veerstrop ; Bride ; U Bolt ; Federbride :</i>								
	B124M20A005	B05	20.0	93		240		55	
A124T074ZA76	<i>Veerstrop ; Bride ; U Bolt ; Federbride :</i>								
	B124M24A004	B05	24.0	93		450		80	
<i>Pen ; Axe ; Pin ; Bolzen :</i>									
YC124C401133		bout in B en C							
A124T075ZA75	<i>Veerstrop ; Bride ; U Bolt ; Federbride :</i>								
	B124M20A040	B05	20.0	93		226		100	
	B124M20A010	B05	20.0	93		385		75	
A124T079ZA75	<i>Veerstrop ; Bride ; U Bolt ; Federbride :</i>								
	B124M16A005	B05	16.0	77		145		50	
A124T082ZA70	<i>Veerstrop ; Bride ; U Bolt ; Federbride :</i>								
	B124M24A006	B05	24.0	102		306		80	
	B124M24B002	B18	24.0	102		335		80	



Vorm Dia B(1) B(2) L(1) L(2) HD1 HD2

A124T083ZA75 *Veerstrop ; Bride ; U Bolt ; Federbride :*

B124M20A001	B05	20.0	93		180		55	
B124M20A002	B05	20.0	93		189		55	
B124M20A003	B05	20.0	93		197		55	
B124M20A035	B05	20.0	93		214		55	
B124M20A004	B05	20.0	93		220		60	
B124M20A040	B05	20.0	93		226		100	

Pen ; Axe ; Pin ; Bolzen :

YC124C401131	in B, C en D
YC124C401138	in B (links)

A124T083ZB75 *Veerstrop ; Bride ; U Bolt ; Federbride :*

B124M20A003	B05	20.0	93		197		55	
B124M20A040	B05	20.0	93		226		100	
B124M20A005	B05	20.0	93		240		55	

Pen ; Axe ; Pin ; Bolzen :

YC124C401131	in B en C
--------------	-----------

A124T086ZA76 *Veerstrop ; Bride ; U Bolt ; Federbride :*

B124M27B001	B15	27.0	101		520		70	
-------------	-----	------	-----	--	-----	--	----	--

Pen ; Axe ; Pin ; Bolzen :

YC124C401134	in B
--------------	------

A124T089ZA75 *Veerstrop ; Bride ; U Bolt ; Federbride :*

B124M16A007	B05	16.0	77		175		65	
-------------	-----	------	----	--	-----	--	----	--

A124T093ZA75 *Veerstrop ; Bride ; U Bolt ; Federbride :*

B124M20A002	B05	20.0	93		189		55	
-------------	-----	------	----	--	-----	--	----	--

A124T094ZA76 *Veerstrop ; Bride ; U Bolt ; Federbride :*

B124M24B007	B09	24.0	92		535		65	
-------------	-----	------	----	--	-----	--	----	--

A124T099ZA75 *Veerstrop ; Bride ; U Bolt ; Federbride :*

B124M20A017	B05	20.0	102		195		60	
B124M20A023	B05	20.0	103		285		100	

Pen ; Axe ; Pin ; Bolzen :

YC124C401132	in B en C
YC124C401141	in D

A124T105ZA75 *Veerstrop ; Bride ; U Bolt ; Federbride :*

B124M16A005	B05	16.0	77		145		50	
-------------	-----	------	----	--	-----	--	----	--

A124T107ZA75 *Veerstrop ; Bride ; U Bolt ; Federbride :*

B124M16A004	B05	16.0	77		135		50	
B124M16A005	B05	16.0	77		145		50	



	Vorm	Dia	B(1)	B(2)	L(1)	L(2)	HD1	HD2
A124T112ZA76 <i>Veerstrop ; Bride ; U Bolt ; Federbride :</i>	B124M22A006	B05	22.0	77		395		60
A124T113ZA75 <i>Veerstrop ; Bride ; U Bolt ; Federbride :</i>	B124M18A002	B05	18.0	77		156		50
	B124M18A005	B05	18.0	77		185		50
A124T114ZA76 <i>Veerstrop ; Bride ; U Bolt ; Federbride :</i>	B124M20A011	B05	20.0	93		400		75
A124T123ZA75 <i>Veerstrop ; Bride ; U Bolt ; Federbride :</i>	B124M20A017	B05	20.0	102		195		60
	B124M20A023	B05	20.0	103		285		100
<i>Pen ; Axe ; Pin ; Bolzen :</i>								
	YC124C401132	in B en C						
	YC124C401141	in D						
A124T143ZA75 <i>Veerstrop ; Bride ; U Bolt ; Federbride :</i>	B124M20A003	B05	20.0	93		197		55
	B124M20A035	B05	20.0	93		214		55
	B124M20A005	B05	20.0	93		240		55
<i>Pen ; Axe ; Pin ; Bolzen :</i>								
	YC124C401131	in B, C en D						
	YC124C401138	in B (links)						
A124T145ZA75 <i>Veerstrop ; Bride ; U Bolt ; Federbride :</i>	B124M20A017	B05	20.0	102		195		60
	B124M20A023	B05	20.0	103		285		100
<i>Pen ; Axe ; Pin ; Bolzen :</i>								
	YC124C401132	bout in B en C						
	YC124C401141	bout in D						
A124T148ZA75 <i>Veerstrop ; Bride ; U Bolt ; Federbride :</i>	B124M27B005	B15	27.0	101		445		70
	B124M27B007	B15	27.0	101		470		70
	B124M27B008	B15	27.0	101		490		70
	B124M27B001	B15	27.0	101		520		70
<i>Pen ; Axe ; Pin ; Bolzen :</i>								
	YC124C401134	in B						



Vorm Dia B(1) B(2) L(1) L(2) HD1 HD2

A124T149ZA75 *Veerstrop ; Bride ; U Bolt ; Federbride :*

B124M20A001	B05	20.0	93		180		55	
B124M20A003	B05	20.0	93		197		55	
B124M20A035	B05	20.0	93		214		55	
B124M20A040	B05	20.0	93		226		100	

Pen ; Axe ; Pin ; Bolzen :

YC124C401131	in B, C en D
YC124C401138	in B (links)

A124T150ZA70 *Veerstrop ; Bride ; U Bolt ; Federbride :*

B124M24B001	B18	24.0	102		380		80	
--------------------	-----	------	-----	--	-----	--	----	--

A124T151ZA75 *Veerstrop ; Bride ; U Bolt ; Federbride :*

B124M20A001	B05	20.0	93		180		55	
B124M20A003	B05	20.0	93		197		55	
B124M20A035	B05	20.0	93		214		55	
B124M20A040	B05	20.0	93		226		100	

Pen ; Axe ; Pin ; Bolzen :

YC124C401131	in B, C en D
YC124C401138	in B (links)

A124T152ZA70 *Veerstrop ; Bride ; U Bolt ; Federbride :*

B124M24B001	B18	24.0	102		380		80	
B124M27B018	B18	27.0	102		415		120	

A124T153ZA75 *Veerstrop ; Bride ; U Bolt ; Federbride :*

B124M20A040	B05	20.0	93		226		100	
--------------------	-----	------	----	--	-----	--	-----	--

Pen ; Axe ; Pin ; Bolzen :

YC124C401147	in B, C en D
--------------	--------------

A124T154ZA70 *Veerstrop ; Bride ; U Bolt ; Federbride :*

B124M27B001	B15	27.0	101		520		70	
-------------	-----	------	-----	--	-----	--	----	--

A124T155ZA75 *Veerstrop ; Bride ; U Bolt ; Federbride :*

B124M20A035	B05	20.0	93		214		55	
B124M20A030	B05	20.0	93		255		80	
B124M20A028	B05	20.0	93		310		75	
B124M20A055	B05	20.0	93		310		75	

Pen ; Axe ; Pin ; Bolzen :

YC124C401138	in B
YC124C401265	in B



Vorm Dia B(1) B(2) L(1) L(2) HD1 HD2

A124T156ZA76 *Veerstrop ; Bride ; U Bolt ; Federbride :*

B124M27B015	B15	27.0	92		527		70	
B124M27B019	B15	27.0	92		560			
B124M27B017	B15	27.0	92		560		70	

Pen ; Axe ; Pin ; Bolzen :

YC124C401147	in B
--------------	------

A124T157ZA75 *Veerstrop ; Bride ; U Bolt ; Federbride :*

B124M20A035	B05	20.0	93		214		55	
B124M20A030	B05	20.0	93		255		80	
B124M20A028	B05	20.0	93		310		75	
B124M20A055	B05	20.0	93		310		75	
B124M20A011	B05	20.0	93		400		75	

Pen ; Axe ; Pin ; Bolzen :

YC124C401265	in B
--------------	------

A124T158ZA75 *Veerstrop ; Bride ; U Bolt ; Federbride :*

B124M27B008	B15	27.0	101		490		70	
--------------------	-----	------	-----	--	-----	--	----	--

Pen ; Axe ; Pin ; Bolzen :

YC124C401132	in B
--------------	------

A124T159AA75 *Veerstrop ; Bride ; U Bolt ; Federbride :*

B025M16A009	B01	16.0	72		156		55	
-------------	-----	------	----	--	-----	--	----	--

Pen ; Axe ; Pin ; Bolzen :

YC124C401161	in B
--------------	------

A124T159ZA75 *Veerstrop ; Bride ; U Bolt ; Federbride :*

B025M16A009	B01	16.0	72		156		55	
-------------	-----	------	----	--	-----	--	----	--

Pen ; Axe ; Pin ; Bolzen :

YC124C401161	in B
--------------	------

A124T162ZA76 *Veerstrop ; Bride ; U Bolt ; Federbride :*

B124M27B001	B15	27.0	101		520		70	
-------------	-----	------	-----	--	-----	--	----	--

Pen ; Axe ; Pin ; Bolzen :

YC124C401132	in B
--------------	------

A124T164ZA75 *Veerstrop ; Bride ; U Bolt ; Federbride :*

B124M24A002	B05	24.0	93		415		80	
-------------	-----	------	----	--	-----	--	----	--

A124T166ZA76 *Veerstrop ; Bride ; U Bolt ; Federbride :*

B124M27B008	B15	27.0	101		490		70	
B124M27B013	B15	27.0	101		540		70	

Pen ; Axe ; Pin ; Bolzen :

YC124C401134	in B
--------------	------



	Vorm	Dia	B(1)	B(2)	L(1)	L(2)	HD1	HD2	
A124T168ZA76	<i>Veerstrop ; Bride ; U Bolt ; Federbride :</i>								
	B124M27B008	B15	27.0	101		490	70		
	<i>Pen ; Axe ; Pin ; Bolzen :</i>								
	YC124C401134	in B							
A124T168ZB76	<i>Veerstrop ; Bride ; U Bolt ; Federbride :</i>								
	B124M27B009	B15	27.0	101		505	70		
	<i>Pen ; Axe ; Pin ; Bolzen :</i>								
	YC124C401134	in B							
A124T170ZA70	<i>Veerstrop ; Bride ; U Bolt ; Federbride :</i>								
	B124M24B002	B18	24.0	102		335	80		
A124T172ZA76	<i>Veerstrop ; Bride ; U Bolt ; Federbride :</i>								
	B124M24B005	B09	24.0	92		465	65		
	<i>Pen ; Axe ; Pin ; Bolzen :</i>								
	YC124C401133	in B							
A124T172ZB76	<i>Veerstrop ; Bride ; U Bolt ; Federbride :</i>								
	B124M24B006	B09	24.0	92		505	65		
	<i>Pen ; Axe ; Pin ; Bolzen :</i>								
	YC124C401133	in B							
A124T174ZA76	<i>Veerstrop ; Bride ; U Bolt ; Federbride :</i>								
	B124M24B005	B09	24.0	92		465	65		
	<i>Pen ; Axe ; Pin ; Bolzen :</i>								
	YC124C401133	in B							
A124T176ZA76	<i>Veerstrop ; Bride ; U Bolt ; Federbride :</i>								
	B124M27B008	B15	27.0	101		490	70		
	<i>Pen ; Axe ; Pin ; Bolzen :</i>								
	YC124C401134	in B							
A124T178ZA75	<i>Pen ; Axe ; Pin ; Bolzen :</i>								
	YC124C401135	in B							
A124T180ZA76	<i>Veerstrop ; Bride ; U Bolt ; Federbride :</i>								
	B124M27B001	B15	27.0	101		520	70		
	<i>Pen ; Axe ; Pin ; Bolzen :</i>								
	YC124C401134	in B							



	Vorm	Dia	B(1)	B(2)	L(1)	L(2)	HD1	HD2
A124T182ZA75	<i>Veerstrop ; Bride ; U Bolt ; Federbride :</i>							
	B124M18A017	B01	18.0	72		301		55
A124T183ZA75	<i>Pen ; Axe ; Pin ; Bolzen :</i>							
	YC061P24080	in B						
A124T183ZA75	<i>Veerstrop ; Bride ; U Bolt ; Federbride :</i>							
	B124M20A001	B05	20.0	93		180		55
	B124M20A003	B05	20.0	93		197		55
	B124M20A035	B05	20.0	93		214		55
	B124M20A040	B05	20.0	93		226		100
A124T216ZA75	<i>Pen ; Axe ; Pin ; Bolzen :</i>							
	YC124C401131	in B, C en D						
A124T216ZA75	<i>Veerstrop ; Bride ; U Bolt ; Federbride :</i>							
	B124M24A002	B05	24.0	93		415		80
A124T220ZA76	<i>Pen ; Axe ; Pin ; Bolzen :</i>							
	YC124C401132	in B						
A124T220ZA76	<i>Veerstrop ; Bride ; U Bolt ; Federbride :</i>							
	B124M24B008	B18	24.0	102		440		100
A124T222ZA76	<i>Pen ; Axe ; Pin ; Bolzen :</i>							
	YC124C401132	in B						
A124T222ZA76	<i>Veerstrop ; Bride ; U Bolt ; Federbride :</i>							
	B124M27B008	B15	27.0	101		490		70
A124T224ZA76	<i>Pen ; Axe ; Pin ; Bolzen :</i>							
	YC124C401132	in B						
A124T224ZA76	<i>Veerstrop ; Bride ; U Bolt ; Federbride :</i>							
	B124M24B001	B18	24.0	102		380		80
A124T226ZA76	<i>Pen ; Axe ; Pin ; Bolzen :</i>							
	YC124C401133	in B						
A124T226ZA76	<i>Veerstrop ; Bride ; U Bolt ; Federbride :</i>							
	B124M24B006	B09	24.0	92		505		65
A124T228ZA76	<i>Pen ; Axe ; Pin ; Bolzen :</i>							
	YC124C401134	in B						
A124T228ZA76	<i>Veerstrop ; Bride ; U Bolt ; Federbride :</i>							
	B124M24B005	B09	24.0	92		465		65
A124T230ZA75	<i>Pen ; Axe ; Pin ; Bolzen :</i>							
	YC124C401133	in B						
A124T230ZA75	<i>Veerstrop ; Bride ; U Bolt ; Federbride :</i>							
	B124M24B003	B09	24.0	92		410		65



Vorm Dia B(1) B(2) L(1) L(2) HD1 HD2

A124T232ZA75 *Veerstrop ; Bride ; U Bolt ; Federbride :*

B124M24B004	B09	24.0	92		435		85	
-------------	-----	------	----	--	-----	--	----	--

Pen ; Axe ; Pin ; Bolzen :

YC124C401135	in B
--------------	------

A124T238ZA76 *Veerstrop ; Bride ; U Bolt ; Federbride :*

B124M27B010	B15	27.0	101		560		70	
-------------	-----	------	-----	--	-----	--	----	--

Pen ; Axe ; Pin ; Bolzen :

YC124C401134	in B
--------------	------

A124T261ZA75 *Veerstrop ; Bride ; U Bolt ; Federbride :*

B124M20A002	B05	20.0	93		189		55	
-------------	-----	------	----	--	-----	--	----	--

Pen ; Axe ; Pin ; Bolzen :

YC124C401147	in B en C
--------------	-----------

A124T263ZA75 *Veerstrop ; Bride ; U Bolt ; Federbride :*

B124M20A001	B05	20.0	93		180		55	
B124M20A040	B05	20.0	93		226		100	

Pen ; Axe ; Pin ; Bolzen :

YC124C401131	in B (rechts)
YC124C401138	in B (links)
YC124C401187	in C en D

A124T265ZA75 *Veerstrop ; Bride ; U Bolt ; Federbride :*

B124M20A003	B05	20.0	93		197		55	
B124M20A040	B05	20.0	93		226		100	

Pen ; Axe ; Pin ; Bolzen :

YC124C401131	in B (links)
YC124C401138	in B (rechts)
YC124C401187	in C en D

A124T267ZA75 *Veerstrop ; Bride ; U Bolt ; Federbride :*

B124M20A003	B05	20.0	93		197		55	
B124M20A040	B05	20.0	93		226		100	
B124M20A005	B05	20.0	93		240		55	

Pen ; Axe ; Pin ; Bolzen :

YC124C401131	in B (rechts)
YC124C401138	in B (links)
YC124C401187	in C en D

A124T269ZA75 *Veerstrop ; Bride ; U Bolt ; Federbride :*

B124M20A003	B05	20.0	93		197		55	
B124M20A040	B05	20.0	93		226		100	

Pen ; Axe ; Pin ; Bolzen :

YC124C401131	in B (links)
YC124C401138	in B (rechts)
YC124C401187	in C en D



Vorm Dia B(1) B(2) L(1) L(2) HD1 HD2

A124T271ZA75 *Veerstrop ; Bride ; U Bolt ; Federbride :*

B124M20A003	B05	20.0	93		197		55	
-------------	-----	------	----	--	-----	--	----	--

Pen ; Axe ; Pin ; Bolzen :

YC124C401147	in B, C en D
--------------	--------------

A124T273ZA75 *Veerstrop ; Bride ; U Bolt ; Federbride :*

B124M20A011	B05	20.0	93		400		75	
-------------	-----	------	----	--	-----	--	----	--

Pen ; Axe ; Pin ; Bolzen :

YC124C401147	in B, C en D
--------------	--------------

A124T275ZA75

Pen ; Axe ; Pin ; Bolzen :

YC124C401265	in B
--------------	------

A124T277ZA75 *Veerstrop ; Bride ; U Bolt ; Federbride :*

B124M20A035	B05	20.0	93		214		55	
-------------	-----	------	----	--	-----	--	----	--

Pen ; Axe ; Pin ; Bolzen :

YC124C401265	in B
YC124C401266	in C
YC124C401308	in C (Kit)

A124T279ZA75 *Veerstrop ; Bride ; U Bolt ; Federbride :*

B124M20A035	B05	20.0	93		214		55	
-------------	-----	------	----	--	-----	--	----	--

Pen ; Axe ; Pin ; Bolzen :

YC124C401265	in B
YC124C401266	in C
YC124C401308	in C (Kit)

A124T281ZA75 *Veerstrop ; Bride ; U Bolt ; Federbride :*

B124M18A004	B05	18.0	77		171		50	
B124M18A007	B05	18.0	77		215		50	

Pen ; Axe ; Pin ; Bolzen :

YC124C401131	in B, C en D
--------------	--------------

A124T283ZA75 *Veerstrop ; Bride ; U Bolt ; Federbride :*

B124M18A004	B05	18.0	77		171		50	
B124M18A007	B05	18.0	77		215		50	

Pen ; Axe ; Pin ; Bolzen :

YC124C401131	in B, C en D
--------------	--------------

A124T285ZA75 *Veerstrop ; Bride ; U Bolt ; Federbride :*

B124M18A006	B05	18.0	77		200		50	
B124M18A008	B05	18.0	77		225		50	

Pen ; Axe ; Pin ; Bolzen :

YC124C401131	in B, C en D
--------------	--------------



	Vorm	Dia	B(1)	B(2)	L(1)	L(2)	HD1	HD2	
A124T286ZA76	<i>Veerstrop ; Bride ; U Bolt ; Federbride :</i>								
	B124M27B015	B15	27.0	92		527		70	
A124T287ZA75	<i>Pen ; Axe ; Pin ; Bolzen :</i>								
	YC124C401147	in B, C en D							
A124T287ZA75	<i>Veerstrop ; Bride ; U Bolt ; Federbride :</i>								
	B124M20A001	B05	20.0	93		180		55	
	B124M20A035	B05	20.0	93		214		55	
A124T289ZA75	<i>Pen ; Axe ; Pin ; Bolzen :</i>								
	YC124C401131	in B, C en D							
A124T289ZA75	<i>Veerstrop ; Bride ; U Bolt ; Federbride :</i>								
	B124M20A001	B05	20.0	93		180		55	
	B124M20A003	B05	20.0	93		197		55	
	B124M20A040	B05	20.0	93		226		100	
A124T289ZA75	<i>Pen ; Axe ; Pin ; Bolzen :</i>								
	YC124C401131	in B (rechts)							
	YC124C401138	in B (links)							
	YC124C401187	in C en D							
A124T290ZA76	<i>Veerstrop ; Bride ; U Bolt ; Federbride :</i>								
	B124M24B007	B09	24.0	92		535		65	
	B124M27B017	B15	27.0	92		560		70	
A124T290ZA76	<i>Pen ; Axe ; Pin ; Bolzen :</i>								
	YC124C401135	in B							
A124T291ZA75	<i>Veerstrop ; Bride ; U Bolt ; Federbride :</i>								
	B124M20A032	B05	20.0	102		240		60	
	B124M20A020	B05	20.0	102		325		60	
A124T291ZA75	<i>Pen ; Axe ; Pin ; Bolzen :</i>								
	YC124C401132	in B en C							
	YC124C401141	in D							
A124T292ZA70	<i>Veerstrop ; Bride ; U Bolt ; Federbride :</i>								
	B124M27B018	B18	27.0	102		415		120	
A124T293ZA75	<i>Veerstrop ; Bride ; U Bolt ; Federbride :</i>								
	B124M20A011	B05	20.0	93		400		75	
A124T293ZA75	<i>Pen ; Axe ; Pin ; Bolzen :</i>								
	YC124C401147	in B, C en D							
A124T294ZA70	<i>Veerstrop ; Bride ; U Bolt ; Federbride :</i>								
	B124M27B018	B18	27.0	102		415		120	



	Vorm	Dia	B(1)	B(2)	L(1)	L(2)	HD1	HD2
A124T295ZA75	<i>Veerstrop ; Bride ; U Bolt ; Federbride :</i>							
	B124M20A003	B05	20.0	93		197		55
	<i>Pen ; Axe ; Pin ; Bolzen :</i>							
	YC124C401131	in B (links)						
	YC124C401138	in B (rechts)						
	YC124C401187	in C en D						
A124T296ZA75	<i>Veerstrop ; Bride ; U Bolt ; Federbride :</i>							
	B124M24B015	B15	24.0	92		490		80
	<i>Pen ; Axe ; Pin ; Bolzen :</i>							
	YC124C401234	in B						
A124T298ZA76	<i>Veerstrop ; Bride ; U Bolt ; Federbride :</i>							
	B124M27B015	B15	27.0	92		527		70
	<i>Pen ; Axe ; Pin ; Bolzen :</i>							
	YC124C401147	in B,C en D						
A124T300ZA70	<i>Veerstrop ; Bride ; U Bolt ; Federbride :</i>							
	B124M27B021	B15	27.0	101		460		90
A124T302ZA76	<i>Veerstrop ; Bride ; U Bolt ; Federbride :</i>							
	B124M24B004	B09	24.0	92		435		85
	<i>Pen ; Axe ; Pin ; Bolzen :</i>							
	YC124C401133	in B						
A124T304ZA75	<i>Veerstrop ; Bride ; U Bolt ; Federbride :</i>							
	B124M24B003	B09	24.0	92		410		65
	<i>Pen ; Axe ; Pin ; Bolzen :</i>							
	YC124C401133	in B						
A124T306ZA75	<i>Veerstrop ; Bride ; U Bolt ; Federbride :</i>							
	B124M24B003	B09	24.0	92		410		65
	<i>Pen ; Axe ; Pin ; Bolzen :</i>							
	YC124C401133	in B						
A124T308ZA76	<i>Veerstrop ; Bride ; U Bolt ; Federbride :</i>							
	B124M27B001	B15	27.0	101		520		70
	<i>Pen ; Axe ; Pin ; Bolzen :</i>							
	YC124C401134	in B						
A124T310ZA76	<i>Pen ; Axe ; Pin ; Bolzen :</i>							
	YC124C401134	in B						

Vorm Dia B(1) B(2) L(1) L(2) HD1 HD2

F023T021ZA75 *Veerstrop ; Bride ; U Bolt ; Federbride :*

B124M20A017	B05	20.0	102		195		60	
B124M20A023	B05	20.0	103		285		100	

Pen ; Axe ; Pin ; Bolzen :

YC124C401132	in B en C
YC124C401141	in D

F023T021ZB75 *Veerstrop ; Bride ; U Bolt ; Federbride :*

B124M20A017	B05	20.0	102		195		60	
B124M20A026	B05	20.0	103		220		100	
B124M20A023	B05	20.0	103		285		100	
B124M20A024	B05	20.0	102		310		80	

Pen ; Axe ; Pin ; Bolzen :

YC124C401132	in B en C
YC124C401141	in D

F023T022ZA75 *Veerstrop ; Bride ; U Bolt ; Federbride :*

B124M27B008	B15	27.0	101		490		70	
B124M27B001	B15	27.0	101		520		70	
B124M27B010	B15	27.0	101		560		70	

Pen ; Axe ; Pin ; Bolzen :

YC124C401134	in B
--------------	------

F023T023ZA75 *Veerstrop ; Bride ; U Bolt ; Federbride :*

B124M20A034	B05	20.0	93		170		55	
B124M20A001	B05	20.0	93		180		55	
B124M20A003	B05	20.0	93		197		55	
B124M20A035	B05	20.0	93		214		55	

Pen ; Axe ; Pin ; Bolzen :

YC124C401131	in B, C en D
--------------	--------------

F023T026ZA75 *Veerstrop ; Bride ; U Bolt ; Federbride :*

B124M24B005	B09	24.0	92		465		65	
-------------	-----	------	----	--	-----	--	----	--

Pen ; Axe ; Pin ; Bolzen :

YC124C401135	in B
--------------	------

F023T026ZB75 *Veerstrop ; Bride ; U Bolt ; Federbride :*

B124M24B005	B09	24.0	92		465		65	
B124M24B006	B09	24.0	92		505		65	

Pen ; Axe ; Pin ; Bolzen :

YC124C401135	in B
--------------	------

F023T031ZA75 *Veerstrop ; Bride ; U Bolt ; Federbride :*

B124M20A001	B05	20.0	93		180		55	
B124M20A035	B05	20.0	93		214		55	

Pen ; Axe ; Pin ; Bolzen :

YC124C401131	in B, C en D
--------------	--------------

Vorm Dia B(1) B(2) L(1) L(2) HD1 HD2

F023T033ZA75 *Veerstrop ; Bride ; U Bolt ; Federbride :*

B124M20A001	B05	20.0	93		180		55	
B124M20A035	B05	20.0	93		214		55	

Pen ; Axe ; Pin ; Bolzen :

YC124C401131	in B, C en D
--------------	--------------

F023T035ZA75 *Veerstrop ; Bride ; U Bolt ; Federbride :*

B124M20A034	B05	20.0	93		170		55	
B124M20A001	B05	20.0	93		180		55	
B124M20A003	B05	20.0	93		197		55	
B124M20A035	B05	20.0	93		214		55	

Pen ; Axe ; Pin ; Bolzen :

YC124C401131	in B, C en D
--------------	--------------

F023T037ZA75 *Veerstrop ; Bride ; U Bolt ; Federbride :*

B124M20A001	B05	20.0	93		180		55	
B124M20A035	B05	20.0	93		214		55	

Pen ; Axe ; Pin ; Bolzen :

YC124C401131	in B (links)
YC124C401138	in B (rechts)
YC124C401187	in C en D

F023T039ZA75 *Veerstrop ; Bride ; U Bolt ; Federbride :*

B124M20A034	B05	20.0	93		170		55	
B124M20A003	B05	20.0	93		197		55	

Pen ; Axe ; Pin ; Bolzen :

YC124C401131	in B, C en D
--------------	--------------

F023T041ZA75 *Veerstrop ; Bride ; U Bolt ; Federbride :*

B124M20A034	B05	20.0	93		170		55	
B124M20A003	B05	20.0	93		197		55	

Pen ; Axe ; Pin ; Bolzen :

YC124C401131	in B, C en D
--------------	--------------

F023T043ZA75 *Veerstrop ; Bride ; U Bolt ; Federbride :*

B124M20A001	B05	20.0	93		180		55	
B124M20A003	B05	20.0	93		197		55	
B124M20A035	B05	20.0	93		214		55	
B124M20A053	B05	20.0	93		285		75	

Pen ; Axe ; Pin ; Bolzen :

YC124C401147	in B, C en D
--------------	--------------



Vorm Dia B(1) B(2) L(1) L(2) HD1 HD2

F023T045ZA75 *Veerstrop ; Bride ; U Bolt ; Federbride :*

B124M20A001	B05	20.0	93		180		55	
B124M20A035	B05	20.0	93		214		55	

Pen ; Axe ; Pin ; Bolzen :

YC124C401131	in B (links)
YC124C401138	in B (rechts)
YC124C401187	in C en D

F023T047ZA75 *Veerstrop ; Bride ; U Bolt ; Federbride :*

B124M20A017	B05	20.0	102		195		60	
B124M20A023	B05	20.0	103		285		100	

Pen ; Axe ; Pin ; Bolzen :

YC124C401132	in B en C
YC124C401141	in D

F023T048ZA75 *Veerstrop ; Bride ; U Bolt ; Federbride :*

B124M27B008	B15	27.0	101		490		70	
B124M27B001	B15	27.0	101		520		70	
B124M27B010	B15	27.0	101		560		70	

Pen ; Axe ; Pin ; Bolzen :

YC124C401134	in B
--------------	------

F023T049ZA75 *Veerstrop ; Bride ; U Bolt ; Federbride :*

B025M20A007	B05	20.0	83		194		70	
B025M20A008	B05	20.0	83		263		70	

F023T049ZB75 *Veerstrop ; Bride ; U Bolt ; Federbride :*

B025M20A011	B05	20.0	83		290		70	
-------------	-----	------	----	--	-----	--	----	--

F023T050ZA75 *Veerstrop ; Bride ; U Bolt ; Federbride :*

B124M24B003	B09	24.0	92		410		65	
B124M24B005	B09	24.0	92		465		65	

Pen ; Axe ; Pin ; Bolzen :

YC124C401135	in B
--------------	------

F023T051ZA75 *Veerstrop ; Bride ; U Bolt ; Federbride :*

B025M20A009	B05	20.0	83		224		70	
B025M20A011	B05	20.0	83		290		70	

F023T052ZA75 *Veerstrop ; Bride ; U Bolt ; Federbride :*

B124M24B003	B09	24.0	92		410		65	
B124M24B005	B09	24.0	92		465		65	

Pen ; Axe ; Pin ; Bolzen :

YC124C401135	in B
--------------	------



Vorm Dia B(1) B(2) L(1) L(2) HD1 HD2

F023T052ZB75

Pen ; Axe ; Pin ; Bolzen :

YC124C401135	in B
--------------	------

F023T053ZA75

Veerstrop ; Bride ; U Bolt ; Federbride :

B124M20A001	B05	20.0
B124M20A040	B05	20.0
B124M20A030	B05	20.0

93		180		55	
93		226		100	
93		255		80	

Pen ; Axe ; Pin ; Bolzen :

YC124C401131	in B (rechts)
YC124C401138	in B (links)
YC124C401187	in C en D

F023T054ZA76

Veerstrop ; Bride ; U Bolt ; Federbride :

B124M27B007	B15	27.0
B124M27B013	B15	27.0

101		470		70	
101		540		70	

Pen ; Axe ; Pin ; Bolzen :

YC124C401134	in B
--------------	------

F023T055ZA75

Veerstrop ; Bride ; U Bolt ; Federbride :

B124M20A001	B05	20.0
B124M20A040	B05	20.0

93		180		55	
93		226		100	

Pen ; Axe ; Pin ; Bolzen :

YC124C401131	in B (rechts)
YC124C401138	in B (links)
YC124C401187	in C en D

F023T057ZA75

Veerstrop ; Bride ; U Bolt ; Federbride :

B124M20A003	B05	20.0
B124M20A053	B05	20.0

93		197		55	
93		285		75	

Pen ; Axe ; Pin ; Bolzen :

YC124C401147	in B, C en D
--------------	--------------

F023T058ZA75

Veerstrop ; Bride ; U Bolt ; Federbride :

B124M24B003	B09	24.0
B124M24B005	B09	24.0

92		410		65	
92		465		65	

Pen ; Axe ; Pin ; Bolzen :

YC124C401133	in B
--------------	------

F023T059ZA75

Veerstrop ; Bride ; U Bolt ; Federbride :

B025M16A009	B01	16.0
-------------	-----	------

72		156		55	
----	--	-----	--	----	--

Pen ; Axe ; Pin ; Bolzen :

YC124C401161	in B
--------------	------



Vorm Dia B(1) B(2) L(1) L(2) HD1 HD2

F023T060ZA76 *Veerstrop ; Bride ; U Bolt ; Federbride :*

B124M27B007	B15	27.0	101		470		70	
B124M27B013	B15	27.0	101		540		70	

Pen ; Axe ; Pin ; Bolzen :

YC124C401134	in B
--------------	------

F023T061ZA75 *Veerstrop ; Bride ; U Bolt ; Federbride :*

B124M20A048	B16	20.0	92		205		60	
B124M20A049	B16	20.0	92		245		80	
B124M20A051	B16	20.0	92		285		80	
B124M20A052	B16	20.0	92		325		80	

Pen ; Axe ; Pin ; Bolzen :

YC124C401187	in B, C en D
--------------	--------------

F023T062ZA75 *Veerstrop ; Bride ; U Bolt ; Federbride :*

B124M27B016	B15	27.0	92		410		70	
-------------	-----	------	----	--	-----	--	----	--

Pen ; Axe ; Pin ; Bolzen :

YC124C401147	in B
--------------	------

F023T065ZA75 *Veerstrop ; Bride ; U Bolt ; Federbride :*

B124M20A035	B05	20.0	93		214		55	
B124M20A053	B05	20.0	93		285		75	

Pen ; Axe ; Pin ; Bolzen :

YC124C401187	in C en D MAXTER
YC124C401187	in D
YC124C401265	in B
YC124C401266	in C
YC124C401266	in C en D
YC124C401308	in C (Kit)
YC124C401308	in C en D (Kit)

F023T066ZA75 *Veerstrop ; Bride ; U Bolt ; Federbride :*

B025M16A016	B01	16.0	62		124		36	
B124M16A016	B05	16.0	62		124		37	

F023T068ZA75 *Veerstrop ; Bride ; U Bolt ; Federbride :*

B025M16A016	B01	16.0	62		124		36	
B124M16A016	B05	16.0	62		124		37	

F023T069ZA75 *Veerstrop ; Bride ; U Bolt ; Federbride :*

B124M20A003	B05	20.0	93		197		55	
B124M20A030	B05	20.0	93		255		80	

Pen ; Axe ; Pin ; Bolzen :

YC124C401131	in B (links)
YC124C401138	in B (rechts)
YC124C401187	in C en D



Vorm Dia B(1) B(2) L(1) L(2) HD1 HD2

F023T071ZA75 *Veerstrop ; Bride ; U Bolt ; Federbride :*

B025M16A009	B01	16.0	72		156		55	
-------------	-----	------	----	--	-----	--	----	--

Pen ; Axe ; Pin ; Bolzen :

YC124C401161	in B
--------------	------

F023T072ZA75 *Veerstrop ; Bride ; U Bolt ; Federbride :*

B025M16A016	B01	16.0	62		124		36	
B124M16A014	B05	16.0	62					
B124M16A016	B05	16.0	62		124		37	

F023T074ZA76 *Veerstrop ; Bride ; U Bolt ; Federbride :*

B124M27B008	B15	27.0	101		490		70	
--------------------	-----	------	-----	--	-----	--	----	--

Pen ; Axe ; Pin ; Bolzen :

YC124C401134	in B
--------------	------

F023T075ZA75 *Veerstrop ; Bride ; U Bolt ; Federbride :*

B025M20A009	B05	20.0	83		224		70	
B025M20A011	B05	20.0	83		290		70	

F023T076ZA76 *Veerstrop ; Bride ; U Bolt ; Federbride :*

B124M27B008	B15	27.0	101		490		70	
--------------------	-----	------	-----	--	-----	--	----	--

Pen ; Axe ; Pin ; Bolzen :

YC124C401134	in B
--------------	------

F023T077ZA75 *Veerstrop ; Bride ; U Bolt ; Federbride :*

B124M20A047	B16	20.0	92		200		60	
B124M20A048	B16	20.0	92		205		60	
B124M20A050	B16	20.0	92		280		80	
B124M20A051	B16	20.0	92		285		80	

Pen ; Axe ; Pin ; Bolzen :

YC124C401187	in B, C, en D (L=160)
YC124C401228	Kit C401187
YC124C401231	in B (L=170)
YC124C401233	in C en D
YC124C401235	in B (L=180)
YC124C401309	
YC124C401310	

F023T077ZB75 *Veerstrop ; Bride ; U Bolt ; Federbride :*

B124M20A049	B16	20.0	92		245		80	
B124M20A052	B16	20.0	92		325		80	

Pen ; Axe ; Pin ; Bolzen :

YC124C401187	in B, C, en D
--------------	---------------



Vorm Dia B(1) B(2) L(1) L(2) HD1 HD2

F023T079ZA75 *Veerstrop ; Bride ; U Bolt ; Federbride :*

Vorm	Dia	B(1)	B(2)	L(1)	L(2)	HD1	HD2
B124M20A047	B16	20.0		92		200	60
B124M20A048	B16	20.0		92		205	60
B124M20A049	B16	20.0		92		245	80
B124M20A050	B16	20.0		92		280	80
B124M20A051	B16	20.0		92		285	80
B124M20A052	B16	20.0		92		325	80

Pen ; Axe ; Pin ; Bolzen :

YC124C401187	in B, C en D
YC124C401231	in B (L=170)
YC124C401233	in C en D
YC124C401235	in B (L=180)
YC124C401309	
YC124C401310	

F023T081ZA75

Pen ; Axe ; Pin ; Bolzen :

YC124C401231	in B (L=170)
YC124C401233	in C en D
YC124C401235	in B (L=180)
YC124C401309	
YC124C401310	

F023T083ZA75

Pen ; Axe ; Pin ; Bolzen :

YC124C401161	in B
--------------	------

F023T086ZA75

Veerstrop ; Bride ; U Bolt ; Federbride :

Vorm	Dia	B(1)	B(2)	L(1)	L(2)	HD1	HD2
B124M18A029	B05	18.0		72		355	65

Pen ; Axe ; Pin ; Bolzen :

YC061P24080	in B
-------------	------

F023T087ZA75

Veerstrop ; Bride ; U Bolt ; Federbride :

Vorm	Dia	B(1)	B(2)	L(1)	L(2)	HD1	HD2
B025M20A008	B05	20.0		83		263	70

F023T088ZA75

Veerstrop ; Bride ; U Bolt ; Federbride :

Vorm	Dia	B(1)	B(2)	L(1)	L(2)	HD1	HD2
B124M24B010	B15	24.0		92		388	80

Pen ; Axe ; Pin ; Bolzen :

YC124C401187	in B, C en D
--------------	--------------

F023T089ZA75

Veerstrop ; Bride ; U Bolt ; Federbride :

Vorm	Dia	B(1)	B(2)	L(1)	L(2)	HD1	HD2
B025M20A011	B05	20.0		83		290	70

F023T091ZA75

Veerstrop ; Bride ; U Bolt ; Federbride :

Vorm	Dia	B(1)	B(2)	L(1)	L(2)	HD1	HD2
B025M20A008	B05	20.0		83		263	70

Vorm Dia B(1) B(2) L(1) L(2) HD1 HD2

F023T092ZA75 *Veerstrop ; Bride ; U Bolt ; Federbride :*

Vorm	Dia	B(1)	B(2)	L(1)	L(2)	HD1	HD2		
B124M27B008	B15	27.0				101	490	70	
B124M27B001	B15	27.0				101	520	70	
B124M27B010	B15	27.0				101	560	70	

Pen ; Axe ; Pin ; Bolzen :

YC124C401134	in B
--------------	------

F023T093ZA75 *Veerstrop ; Bride ; U Bolt ; Federbride :*

Vorm	Dia	B(1)	B(2)	L(1)	L(2)	HD1	HD2		
B025M20A008	B05	20.0				83	263	70	

F023T094ZA70 *Veerstrop ; Bride ; U Bolt ; Federbride :*

Vorm	Dia	B(1)	B(2)	L(1)	L(2)	HD1	HD2		
B124M24B013	B18	24.0				102	295	80	

F023T095ZA75 *Veerstrop ; Bride ; U Bolt ; Federbride :*

Vorm	Dia	B(1)	B(2)	L(1)	L(2)	HD1	HD2		
B025M20A011	B05	20.0				83	290	70	

F023T096ZA75 *Veerstrop ; Bride ; U Bolt ; Federbride :*

Vorm	Dia	B(1)	B(2)	L(1)	L(2)	HD1	HD2		
B025M20B013	B09	20.0				82	341	70	

F023T097ZA75 *Veerstrop ; Bride ; U Bolt ; Federbride :*

Vorm	Dia	B(1)	B(2)	L(1)	L(2)	HD1	HD2		
B025M20A011	B05	20.0				83	290	70	

F023T098ZA75 *Veerstrop ; Bride ; U Bolt ; Federbride :*

Vorm	Dia	B(1)	B(2)	L(1)	L(2)	HD1	HD2		
B025M20B013	B09	20.0				82	341	70	
B025M20B011	B09	20.0				82	380	60	

F023T099ZA75 *Veerstrop ; Bride ; U Bolt ; Federbride :*

Vorm	Dia	B(1)	B(2)	L(1)	L(2)	HD1	HD2		
B124M20A048	B16	20.0				92	205	60	
B124M20A049	B16	20.0				92	245	80	
B124M20A051	B16	20.0				92	285	80	
B124M20A052	B16	20.0				92	325	80	

Pen ; Axe ; Pin ; Bolzen :

YC124C401187	in B, C en D
--------------	--------------

F023T100ZA76 *Veerstrop ; Bride ; U Bolt ; Federbride :*

Vorm	Dia	B(1)	B(2)	L(1)	L(2)	HD1	HD2		
B124M24B004	B09	24.0				92	435	85	

Pen ; Axe ; Pin ; Bolzen :

YC124C401133	in B
--------------	------

F023T101ZA75

Pen ; Axe ; Pin ; Bolzen :

YC124C401187	in B, C en D
--------------	--------------



	Vorm	Dia	B(1)	B(2)	L(1)	L(2)	HD1	HD2
F023T102ZA75	Veerstrop ; Bride ; U Bolt ; Federbride :							
	B124M18A027	B05 18.0	72		300		65	
	Pen ; Axe ; Pin ; Bolzen :							
	YC061P24080	in B						
F023T103ZA75	Veerstrop ; Bride ; U Bolt ; Federbride :							
	B124M20A048	B16 20.0	92		205		60	
	B124M20A051	B16 20.0	92		285		80	
	Pen ; Axe ; Pin ; Bolzen :							
	YC124C401187	in B, C en D						
F023T104ZA75	Veerstrop ; Bride ; U Bolt ; Federbride :							
	B124M18A028	B05 18.0	72		310		65	
	Pen ; Axe ; Pin ; Bolzen :							
	YC061P24080	in B						
F023T105ZA75	Veerstrop ; Bride ; U Bolt ; Federbride :							
	B124M20A048	B16 20.0	92		205		60	
	B124M20A049	B16 20.0	92		245		80	
	B124M20A051	B16 20.0	92		285		80	
	B124M20A052	B16 20.0	92		325		80	
	Pen ; Axe ; Pin ; Bolzen :							
	YC124C401187	in B, C en D						
F023T106ZA75	Pen ; Axe ; Pin ; Bolzen :							
	YC061P24092	in B						
F023T107ZA75	Veerstrop ; Bride ; U Bolt ; Federbride :							
	B124M20A034	B05 20.0	93		170		55	
	B124M20A035	B05 20.0	93		214		55	
	Pen ; Axe ; Pin ; Bolzen :							
	YC124C401131	in B, C en D						
F023T108ZA75	Veerstrop ; Bride ; U Bolt ; Federbride :							
	B025M20B011	B09 20.0	82		380		60	
F023T109ZA75	Veerstrop ; Bride ; U Bolt ; Federbride :							
	B124M20A001	B05 20.0	93		180		55	
	B124M20A040	B05 20.0	93		226		100	
	Pen ; Axe ; Pin ; Bolzen :							
	YC124C401131	in B (rechts)						
	YC124C401138	in B (links)						
	YC124C401187	in C en D						



	Vorm	Dia	B(1)	B(2)	L(1)	L(2)	HD1	HD2
F023T110ZA75	Veerstrop ; Bride ; U Bolt ; Federbride :							
	B025M24B010	B09	24.0	81		383	70	
F023T111ZA75	Veerstrop ; Bride ; U Bolt ; Federbride :							
	B124M20A001	B05	20.0	93		180	55	
	B124M20A040	B05	20.0	93		226	100	
	Pen ; Axe ; Pin ; Bolzen :							
	YC124C401131	in B (rechts)						
	YC124C401138	in B (links)						
	YC124C401187	in C en D						
F023T112ZA75	Veerstrop ; Bride ; U Bolt ; Federbride :							
	B025M20B013	B09	20.0	82		341	70	
	B025M20B003	B09	20.0	82		390	70	
F023T114ZA76	Veerstrop ; Bride ; U Bolt ; Federbride :							
	B025M20B011	B09	20.0	82		380	60	
	B025M20B015	B09	20.0	82		455	70	
F023T115ZA75	Veerstrop ; Bride ; U Bolt ; Federbride :							
	B124M20A034	B05	20.0	93		170	55	
	B124M20A001	B05	20.0	93		180	55	
	Pen ; Axe ; Pin ; Bolzen :							
	YC124C401131	in B (rechts)						
	YC124C401138	in B (links)						
	YC124C401187	in C en D						
F023T116ZA75	Veerstrop ; Bride ; U Bolt ; Federbride :							
	B025M20B013	B09	20.0	82		341	70	
F023T117ZA75	Veerstrop ; Bride ; U Bolt ; Federbride :							
	B124M20A035	B05	20.0	93		214	55	
	B124M20A030	B05	20.0	93		255	80	
	Pen ; Axe ; Pin ; Bolzen :							
	YC124C401131	in B (links)						
	YC124C401138	in B (rechts)						
	YC124C401187	in C en D						
F023T118ZA75	Veerstrop ; Bride ; U Bolt ; Federbride :							
	B124M24B005	B09	24.0	92		465	65	
	Pen ; Axe ; Pin ; Bolzen :							
	YC124C401135	in B						



Vorm Dia B(1) B(2) L(1) L(2) HD1 HD2

F023T122ZA75 *Veerstrop ; Bride ; U Bolt ; Federbride :*

Vorm	Dia	B(1)	B(2)	L(1)	L(2)	HD1	HD2		
B124M27B008	B15	27.0				101	490	70	
B124M27B001	B15	27.0				101	520	70	
B124M27B013	B15	27.0				101	540	70	
B124M27B010	B15	27.0				101	560	70	
B124M27B014	B15	27.0				101	590	70	

F023T128ZA70 *Veerstrop ; Bride ; U Bolt ; Federbride :*

B124M24B013	B18	24.0				102	295	80	
-------------	-----	------	--	--	--	-----	-----	----	--

F023T130ZA75 *Veerstrop ; Bride ; U Bolt ; Federbride :*

B124M24B010	B15	24.0				92	388	80	
-------------	-----	------	--	--	--	----	-----	----	--

Pen ; Axe ; Pin ; Bolzen :

YC124C401232	in C en D
YC124C401234	in B

F023T138ZA75 *Veerstrop ; Bride ; U Bolt ; Federbride :*

B124M16A014	B05	16.0				62			
-------------	-----	------	--	--	--	----	--	--	--

F023T140ZA75 *Veerstrop ; Bride ; U Bolt ; Federbride :*

B025M16A016	B01	16.0				62	124	36	
B124M16A014	B05	16.0				62			
B124M16A016	B05	16.0				62	124	37	

F023T144ZA76 *Veerstrop ; Bride ; U Bolt ; Federbride :*

B025M20B009	B09	20.0				82	505	90	
-------------	-----	------	--	--	--	----	-----	----	--

Pen ; Axe ; Pin ; Bolzen :

YC061P24092	in B
-------------	------

F023T148ZA75 *Veerstrop ; Bride ; U Bolt ; Federbride :*

B124M20A017	B05	20.0				102	195	60	
B124M20A026	B05	20.0				103	220	100	
B124M20A032	B05	20.0				102	240	60	

F023T154ZA76 *Veerstrop ; Bride ; U Bolt ; Federbride :*

B124M24B010	B15	24.0				92	388	80	
-------------	-----	------	--	--	--	----	-----	----	--

Pen ; Axe ; Pin ; Bolzen :

YC124C401187	in B
YC124C401234	in B

F023T156ZL75 *Veerstrop ; Bride ; U Bolt ; Federbride :*

B124M24B014	B15	24.0				101	415	80	
-------------	-----	------	--	--	--	-----	-----	----	--

Pen ; Axe ; Pin ; Bolzen :

YC124C401230	in B
--------------	------



	Vorm	Dia	B(1)	B(2)	L(1)	L(2)	HD1	HD2
F023T156ZR75	Veerstrop ; Bride ; U Bolt ; Federbride :							
	B124M24B014	B15	24.0	101		415	80	
	Pen ; Axe ; Pin ; Bolzen :							
	YC124C401230	in B						
F023T158ZA75	Veerstrop ; Bride ; U Bolt ; Federbride :							
	B124M24B010	B15	24.0	92		388	80	
	Pen ; Axe ; Pin ; Bolzen :							
	YC124C401232	in C en D						
	YC124C401234	in B						
F023T160ZL75	Veerstrop ; Bride ; U Bolt ; Federbride :							
	B124M24B014	B15	24.0	101		415	80	
	Pen ; Axe ; Pin ; Bolzen :							
	YC124C401230	in B						
F023T160ZR75	Veerstrop ; Bride ; U Bolt ; Federbride :							
	B124M24B014	B15	24.0	101		415	80	
	Pen ; Axe ; Pin ; Bolzen :							
	YC124C401230	in B						
F023T162ZA75	Veerstrop ; Bride ; U Bolt ; Federbride :							
	B025M20B013	B09	20.0	82		341	70	
F023T166ZA76	Veerstrop ; Bride ; U Bolt ; Federbride :							
	B124M24B003	B09	24.0	92		410	65	
	Pen ; Axe ; Pin ; Bolzen :							
	YC124C401133	in B						
F023T168ZA76	Veerstrop ; Bride ; U Bolt ; Federbride :							
	B124M24B005	B09	24.0	92		465	65	
	Pen ; Axe ; Pin ; Bolzen :							
	YC124C401134	in B						
F023T172ZA75	Veerstrop ; Bride ; U Bolt ; Federbride :							
	B124M24B010	B15	24.0	92		388	80	
	Pen ; Axe ; Pin ; Bolzen :							
	YC124C401187	in B, C en D						
F023T180ZA75	Veerstrop ; Bride ; U Bolt ; Federbride :							
	B124M27B020	B15	27.0	92				
	Pen ; Axe ; Pin ; Bolzen :							
	YC124C401147	in B						



	Vorm	Dia	B(1)	B(2)	L(1)	L(2)	HD1	HD2
F023T182ZA75	Veerstrop ; Bride ; U Bolt ; Federbride :							
	B124M24B004	B09	24.0	92		435		85
	Pen ; Axe ; Pin ; Bolzen :							
	YC124C401133	in B						
F023T184ZA75	Veerstrop ; Bride ; U Bolt ; Federbride :							
	B124M24B005	B09	24.0	92		465		65
	Pen ; Axe ; Pin ; Bolzen :							
	YC124C401135	in B						
F023T188ZA75	Veerstrop ; Bride ; U Bolt ; Federbride :							
	B124M24B005	B09	24.0	92		465		65
	Pen ; Axe ; Pin ; Bolzen :							
	YC124C401133	in B						
F023T190ZL75	Veerstrop ; Bride ; U Bolt ; Federbride :							
	B124M20A048	B16	20.0	92		205		60
	Pen ; Axe ; Pin ; Bolzen :							
	YC124C401230	in B						
F023T190ZR75	Veerstrop ; Bride ; U Bolt ; Federbride :							
	B124M20A048	B16	20.0	92		205		60
	Pen ; Axe ; Pin ; Bolzen :							
	YC124C401230	in B						
F023T192ZA75	Veerstrop ; Bride ; U Bolt ; Federbride :							
	B124M24B010	B15	24.0	92		388		80
	Pen ; Axe ; Pin ; Bolzen :							
	YC124C401234	in B						
F023T194ZA75	Veerstrop ; Bride ; U Bolt ; Federbride :							
	B124M14A016	B05	14.0	79		82		45
	B124M14A017	B05	14.0	79		105		65
F023T194ZB75	Veerstrop ; Bride ; U Bolt ; Federbride :							
	B124M14A017	B05	14.0	79		105		65
F023T194ZC75	Veerstrop ; Bride ; U Bolt ; Federbride :							
	B124M14A017	B05	14.0	79		105		65
F023T194ZD75	Veerstrop ; Bride ; U Bolt ; Federbride :							
	B124M14A017	B05	14.0	79		105		65



Vorm Dia B(1) B(2) L(1) L(2) HD1 HD2

F023T250ZA75 *Veerstrop ; Bride ; U Bolt ; Federbride :*

B124M14A018	B05	14.0	78	86	105		35	
-------------	-----	------	----	----	-----	--	----	--

F023T296ZA75 *Veerstrop ; Bride ; U Bolt ; Federbride :*

B124M16A015	B05	16.0	62		125		70	
-------------	-----	------	----	--	-----	--	----	--