



PATENTS & DESIGNS  
REGISTERED

## 1

### Produits d'origine constructeurs - OE spare parts per manufacturer

#### Originalersatzteile nach Fahrzeughersteller / Fahrzeugtyp

- |            |   |             |
|------------|---|-------------|
| <b>1.1</b> | <b>Camions / Cars et bus - Trucks / Coaches - LKW / Busse</b> ..... | <b>p.07</b> |
| <b>1.2</b> | <b>Remorques - Trailers - Anhänger / Auflieger</b> .....            | <b>p.79</b> |

## 2

### Produits standard - Standard products - Universalprodukte

- |            |  |              |
|------------|--|--------------|
| <b>2.1</b> | <b>Feux arrière - Rear lamps - Heckleuchten</b> .....  |              |
|            | Feux multifonction - Multifunction lamps - Mehrkammerleuchter  | <b>p.141</b> |
|            | Feux monofonction - Monofunction lamps - Einzelfunktionsleuchten                                     | <b>p.173</b> |
|            | Eclaireurs de plaque - Number plate lamps - Kennzeichenleuchten                                      | <b>p.176</b> |
| <b>2.2</b> | <b>Feux clignotants - Flasher lamps - Fahrtrichtungsanzeiger</b> .....                               |              |
|            | Face avant - Front face - Frontansicht   | <b>p.178</b> |
|            | Face latérale - Side face - Seitenansicht  | <b>p.183</b> |
|            | Face arrière - Rear face - Heckansicht   | <b>p.186</b> |
| <b>2.3</b> | <b>Feux de position - Position lamps - Positionsleuchten</b> .....                                   |              |
|            | Face avant - Front face - Frontansicht   | <b>p.187</b> |
|            | Face latérale - Side face - Seitenansicht  | <b>p.197</b> |
|            | Face arrière - Rear face - Heckansicht   | <b>p.207</b> |
| <b>2.4</b> | <b>Produits complémentaires - Complementary products - Ergänzende Produkte</b> .....                 |              |
|            | Signalisation passive - Warnin gproducts - Warnmarkierungen  | <b>p.213</b> |
|            | Eclairage intérieur - Dom lamps - Innenraumleuchter  | <b>p.218</b> |
|            | Eclairage extérieur - Working lamps - Arbeitsscheinwerfer  | <b>p.220</b> |
|            | Gyrophares - Rotating beacons - Rundumkennleuchter   | <b>p.222</b> |
|            | Alarmes et caméras - Back-up alarms and cameras - Rückfahrwarner und -videosysteme                   | <b>p.225</b> |
|            | Centrales et tempo - Flasher units and windscreen - Elektronische Blinkgeber und Zeitrelais          | <b>p.227</b> |
|            | Lampes - Bulbs - Glühlampen  | <b>p.228</b> |
|            | Rétroviseurs - Rear view mirrors - Rückspiegel   | <b>p.235</b> |
| <b>2.5</b> | <b>Electricité remorque - Electric products for trailers - Elektrik für Anhänger/Auflieger</b> ..... |              |
|            | Prises et cordons de liaison - Cables and plugs - Anschlusskabel und Steckverbindungen               | <b>p.244</b> |
|            | Câblage remorque - Trailers harnesses - Verkabelungsprodukte für Anhänger/Auflieger                  | <b>p.249</b> |

## 3

### Recherche produits - Products research - Produktsuche

- |            |   |              |
|------------|---|--------------|
| <b>3.1</b> | <b>Par liste de correspondance - By cross list - nach Hersteller-Nr.</b> .....          | <b>p.261</b> |
| <b>3.2</b> | <b>Par no. d'homologation - By homologation number - nach Homologationsnummer</b> ..... | <b>p.264</b> |
| <b>3.3</b> | <b>Par photo - By pictures - nach Abbildung</b> .....                                   | <b>p.265</b> |
| <b>3.4</b> | <b>Par référence - By part number - nach Artikelnummer</b> .....                        | <b>p.271</b> |

Ce catalogue n'est pas contractuel  
 This catalogue does not create any contractual tie  
 Die Informationen in diesem Katalog sind nicht bindend !  
 Wir behalten uns ausdrücklich vor, eventuelle Prospektangaben zu ändern



FOURNISSEUR DE PIÈCES D'ORIGINE DEPUIS PLUS DE 50 ANS  
 ORIGINAL EQUIPMENT SUPPLIER FOR MORE THAN 50 YEARS  
 HERSTELLER VON ORIGINALTEILEN SEIT ÜBER 50 JAHREN



**CONÇOIT**  
DESIGNS  
ENTWICKLUNG

**FABRIQUE**  
MANUFACTURES  
PRODUKTION

**COMMERCIALISE**  
DISTRIBUTES  
VERTIEB

Region	Sales Figures
Scandinavia	212
United Kingdom	228
Benelux	289
Germany	542
Poland	247
North Eastern Europe	400
Czech republic	208
Austria	173
France	1230
Switzerland	76
Italy	354
South Eastern Europe	355
Greece	53
Spain	215
Portugal	31

des produits de signalisation pour véhicules industriels dans le respect de la réglementation et de l'environnement



signalling products for industrial vehicles respecting the directives and the environment

von Produkten für die Beleuchtung von Nutzfahrzeugen unter Berücksichtigung der gesetzlichen Vorschriften und aktueller Umweltstandards



ORIGINAL QUALITY PARTS

## MISE EN GARDE SUR LES RISQUES JURIDIQUES DE LA CONTREFAÇON DES PIÈCES D'ORIGINE

Les **remplacements** ou **modifications** de composants autres que ceux montés et recommandés par le constructeur peuvent remettre en cause la sécurité des usagers de la route (diminution des performances photométriques).

**Ex : Le montage d'un cabochon adaptable sur un feu d'origine Vignal est interdit.**

Toute opération de ce type sur le matériel sera **à la charge entière de celui qui sera intervenu** et pourra **remettre en cause l'homologation du véhicule** délivrée par les autorités compétentes.  
Le fabricant dégage sa responsabilité réglementaire.

**La contrefaçon et la concurrence déloyale de pièces sont condamnées par la loi civile et pénale :**

- La contrefaçon engage la responsabilité civile et pénale du fabricant, du revendeur, voire dans certains cas de l'utilisateur des pièces de contrefaçon.
- La concurrence déloyale engage la responsabilité civile du fabricant et du revendeur de copies serviles; en tirant de cette opération un avantage injustifié, **il fausse les règles normales de la concurrence** et réalise de ce fait un **acte de parasitisme** en détournant le travail de recherche et de conception, ainsi que le savoir-faire des constructeurs.

## WARNING ON LEGAL RISKS OF ORIGINAL PARTS COPIES / FORGERY

The **remplacements** or **modifications** of components other than those assembled and recommended by the manufacturer can reduce the safety of the road users (reduction in the photometric performances).

**Ex : The assembly of an adaptable lens on an original lamp Vignal is prohibited.**

Any operation of this type on the material **will be judged as responsibility of who intervened** and will **compromise the homologation of the vehicle** delivered by the authorities.  
The manufacturer declines all responsibilities.

**The forgery and the unfair competition of original parts are condemned by the civil and penal law :**

- The forgery engages the civil and penal liability of the manufacturer and the retailer, even in certain cases of the user of the forgery parts.
- The unfair competition engages the civil liability of the manufacturer and the retailer of forged parts; by taking an unjustified advantage from this operation, the forgery **distorts the normal rules** of competition and carries out an **act of parasitism** by diverting the design and R&D task, as well as know-how of the manufacturers.

## HINWEIS AUF DIE RECHTLICHEN RISIKEN BEI FÜR VERWENDUNG VON NACHBAUTEILEN ANSTELLE VON ORIGINALERSATZTEILEN

Der **Austausch** oder die **Modifikation** von Teilen, die nicht in der Erstausrüstung montiert und vom Hersteller empfohlen wurden, können die Sicherheit der Verkehrsteilnehmer beeinträchtigen (Verringerung der lichttechnischen Leistung).

Beispiel: **Die Verwendung einer nachgebauten Lichtscheibe auf einer VIGNAL-Heckleuchte ist nicht zulässig.**

Jede Verwendung dieses Materials wird **zu Lasten des Verwenders** ausgelegt und kann die **Zulassung des Fahrzeugs durch die Zulassungsstellen in Frage stellen**.

Der Fahrzeughersteller entzieht die gesetzliche Gewährleistungspflicht.

**Die Fälschung (Nachbau) von Originalteilen und der unlautere Wettbewerb werden durch das Zivil- und Strafrecht verurteilt:**

- Die Fälschung (Nachbau) von Originalteilen zieht die zivil- und strafrechtliche Haftung des Herstellers, des Wiederverkäufers und in bestimmten Fällen auch des Benutzers nach sich.
- Der unlautere Wettbewerb zieht **die zivilrechtliche Haftung des Herstellers und des Wiederverkäufers von Nachbauteilen nach sich**; sie ziehen aus dieser Operation einen ungerechtfertigten Nutzen, und verfälschen die normalen Regeln des Wettbewerbs, indem sie die Forschungs- und Konzeptionsarbeit sowie das Know-How der Konstrukteure nutzen.



**Guide de lecture des pages "Produits d'origine constructeurs"**  
**User guide pages "OE spare parts per manufacturer"**  
**Hinweise zur Katalogbenutzung "Produkte nach Fahrzeugverwendung"**

Nom du véhicule  
Vehicle model  
Fahrzeugbezeichnung

Dates d'application  
Application dates  
Baujahr

**MIDLUM**

Report produits standard  
Reference to standard products  
Standardbezeichnung des Produkts

Type de véhicule  
Vehicle type  
Fahrzeugtyp

Type de connecteur  
Connector type  
Anschlussart

Nom du constructeur  
Manufacturer  
Fahrzeugbezeichnung

**RENAULT TRUCKS**

**Barre anti-encastrement  
Anti crash bar  
Unterfahrerschutz**

**119400 (RT 5001834560)** gauche - left - links  
**119410 (RT 5001834559)** droit - right - rechts

**LC5 p 45** --- 1999 -> 09/2005

**AMP 1.5** arrière rear connector Anschlussstecker hinten

**152020 (RT 5001846847)** EPP  
**152060 (RT 5001846849)** gauche - left - links  
**152030 (RT 5001846848)**  
**152070 (RT 5001846850)** EPP droit - right - rechts

--- 09/2005 ->

**152190 (RT 7420862038)** gauche - left - links  
**152200 (RT 7420862041)** droit - right - rechts

**052000 (RT 5010392231)** gauche - left - links  
**052000 (RT 5010392231)** droit - right - rechts

**152000 (RT 5001846843)**  
**152040 (RT 5001846845)** gauche - left - links  
**152010 (RT 5001846844)**  
**152050 (RT 5001846846)** droit - right - rechts

Fonctions supplémentaires  
Additional functions  
Zusatzfunktionen

- K Catadioptre triangulaire  
Triangular reflector  
Dreieckrückstrahler
- EPP Eclairage de plaque  
Number plate lamp  
Kennzeichenleuchte

**ORIGINAL QUALITY PARTS**

Référence Vignal  
Vignal p/n  
Art.-Nr. Vignal

Référence constructeur rechange  
Manufacturer p/n  
Art.-Nr. des Fahrzeugherstellers

Pour conduite à droite  
For Right-Hand drive  
Rechtssteuerung

Spécificité du produit  
Product specificity  
Besonderheit des Produkts

Symbole fonctions  
Functions symbol  
Funktionssymbole

**152030**  
(RT 5001846848)

**152070**  
(RT 5001846850)

**EPP**

droit - right - rechts

- K Catadioptre  
Reflector  
Rückstrahler
- FPL Feu de position latéral  
Side marker lamp  
Seitenmarkierungsleuchte
- EPP Eclairage de plaque  
Number plate lamp  
Kennzeichenleuchte
- ASR Alarme sonore de recul  
Back up alarm  
Rückfahrtsignalhorn
- T Catadioptre triangulaire  
Triangular reflector  
Dreieckrückstrahler
- SAM Système d'aide à la manoeuvre  
Manoeuvre helping system  
Manövriehilfsreflektor

## 1

**Produits d'origine constructeurs - OE spare parts per manufacturer****Originalersatzteile nach Fahrzeughersteller / Fahrzeugtyp****1.1 Camions / Cars et bus - Trucks / Coaches - LKW / Busse**

DAF .....	p.07
ERF .....	p.12
FODEN .....	p.13
HEULIEZ .....	p.14
IRISBUS .....	p.16
IVECO .....	p.23
MAN .....	p.29
MANITOU .....	p.32
MERCEDES .....	p.33
NISSAN .....	p.34
RENAULT AGRI .....	p.35
RENAULT TRUCKS .....	p.36
SANTANA .....	p.70
SCANIA .....	p.71
VOLKSWAGEN .....	p.72
VOLVO .....	p.73

**1.2 Remorques - Trailers - Anhänger / Auflieger**

ASCA .....	p.79
BENALU .....	p.85
BFG .....	p.88
CHEREAU .....	p.90
CODER .....	p.94
DOLL .....	p.96
ECOVAC .....	p.97
FELDBINDER .....	p.99
FLIEGL .....	p.101
FRUEHAUF .....	p.102
GUILLEN .....	p.104
INVEPE .....	p.105
KEMPF .....	p.106
LAMBERET .....	p.107
LECINENA .....	p.112
MAGYAR .....	p.114
MAISONNEUVE .....	p.116
MENCI .....	p.118
MONTENEGRO .....	p.119
NETAM FRUEHAUF .....	p.120
OMEF .....	p.122
PACTON .....	p.123
SAMRO .....	p.125
SCHWARZMUELLER .....	p.129
SOMMER .....	p.130
TABARRINI .....	p.132
TEKNOCAR .....	p.134
TITAN / KAISER BTK .....	p.135

# DAF

## DAF

**LC4**

p 157



→ 1993



**141640\***

**K** **EPP** (DAF 2922224)

gauche - left - links



**141640\***

(DAF 2922224) **EPP** **K**

droit - right - rechts



**040500**

**K** (DAF 0698603)

gauche - left - links



**040500**

(DAF 0698603) **K**

droit - right - rechts

## 65 - 75 - 85 - 95

**LC7**

p 153



→ 1993 → 1995



**168100**

**K** **FPL** **EPP** (DAF 1626319/1284213)

gauche - left - links



**168390**

(DAF 1626320/1284214) **K** **FPL** **EPP**

droit - right - rechts



**067500**

**K** (DAF 1272653)

gauche - left - links



**067500**

(DAF 1272653) **K**

droit - right - rechts

\* Silent blocs non fournis,  
voir ref. 001706 p.154

\*Silent blocs not supplied,  
see p/n 001706 p.154

\*Schwingungsdämpfer  
Art.-Nr. 001706 nicht im  
Lieferumfang, s. Seite 154

Fonctions supplémentaires  
Additional functions  
Zusatzfunktionen

**K** **Catadioptr**  
**Reflector**  
**Rückstrahler**

**FPL** **Feu de position latéral**  
**Side marker lamp**  
**Seitenmarkierungsleuchte**

**EPP** **Eclaireur de plaque**  
**Number plate lamp**  
**Kennzeichenleuchte**

CF / XF

DAF

LC7

p 153



1995 ->



1995 -> 2001



DAF  
arrière  
rear connector  
Anschlusstecker  
hinten



**167640**  
(DAF 1284211)

K EPP

gauche - left - links



**167630**  
(DAF 1284212)

K

droit - right - rechts



**168020**  
(DAF 1304789)

K FPL EPP

gauche - left - links



**168010**  
(DAF 1304788)

K FPL

droit - right - rechts



**168890**  
(DAF 1785562)

K FPL ASR

droit - right - rechts



2001 ->



AMP 1.5  
latéral  
side connector  
Anschlusstecker  
seitlich



**169160**  
(DAF 1625985)

K FPL EPP

gauche - left - links



**169170**  
(DAF 1625986)

K FPL

droit - right - rechts



**169380**  
(DAF 1785561)

K FPL ASR

droit - right - rechts



**067500**  
(DAF 1272653)

K

gauche - left - links



**067500**  
(DAF 1272653)

K

droit - right - rechts

Fonctions supplémentaires  
Additional functions  
Zusatzfunktionen

**K** Catadioptr  
Reflector  
Rückstrahler

**FPL** Feu de position latéral  
Side marker lamp  
Seitenmarkierungsleuchte

**EPP** Eclairer de plaque  
Number plate lamp  
Kennzeichenleuchte

08



DAF

CF / XF

ICDL07

p 183

-1993 ->



**109010**  
(DAF 1814096/1815754)

75 - 85 - XF - CF

FPL93

p 201

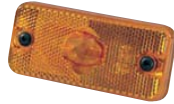

**193020**  
(DAF 1329718)



**001726**  
(DAF 1608352)

09

FPL93

p 191



**193200**  
(DAF 1653605)



**001726**  
(DAF 1608352)

**LF**

**DAF**

**LC5**

p 150



2001 ->

**AMP 1.5**  
latéral  
side connector  
Anschlussstecker  
seitlich



**152170**  
EPP K (DAF 1401713)

gauche - left - links



**152180**  
(DAF 1401731) K

droit - right - rechts



**052500**  
K (DAF 1451482)

gauche - left - links



**052500**  
(DAF 1451482) K

droit - right - rechts

**FE95**

p 195



**195010**  
(DAF 1403887)

gauche - left - links



**195010**  
(DAF 1403887)

droit - right - rechts

10

**ICDL94**

p 184



**119550**  
(DAF 1626101)



**001616**  
(DAF 1626102)

**FE02**

p 191



**102200**

Clippé - Clipped - Befestigung



**001726**  
(DAF 1608352)

Fonctions supplémentaires  
Additional functions  
Zusatzfunktionen

**K** Catadioptré  
Reflector  
Rückstrahler

**EPP** Eclaireur de plaque  
Number plate lamp  
Kennzeichenleuchte

DAF

LF

FPL93 p 201



**193020**  
(DAF 1329718)



**001726**  
(DAF 1608352)

EPP98 p 177



**196010**  
(DAF 0867930)

11

## ECT - ECM

LC7

p 153



DIN  
arrière  
rear connector  
Anschlusstecker  
hinten



**168100**

**K** **FPL** **EPP** (ERF 403721-0)

**K** **FPL** **168090**

gauche - left - links



**168090**

(ERF 404514-6) **K** **FPL**

**K** **FPL** **EPP** **168390**

droit - right - rechts



AMP 1.5  
latéral  
side connector  
Anschlusstecker  
seitlich



**169180**

**K** **FPL** (ERF 35-20416-9939)

gauche - left - links



**169280**

(ERF 35-204169922) **K** **FPL** **EPP**

droit - right - rechts



**K**

**067500**

gauche - left - links



**067500**

**K**

droit - right - rechts

SMD98

p 198



**198520**

(ERF 411804-2)

ICDL94

p 184



**119470**  
(ERF 411828-5)



**001616**

Fonctions supplémentaires  
Additional functions  
Zusatzfunktionen

**K** Catadioptr  
Reflector  
Rückstrahler

**FPL** Feu de position latéral  
Side marker lamp  
Seitenmarkierungsleuchte

**EPP** Eclaireur de plaque  
Number plate lamp  
Kennzeichenleuchte

ERF

12



**FODEN**

**ALPHA**

**LC7**

p 153



**DIN**  
arrière  
rear connector  
Anschlusstecker  
hinten



**168100**

**K FPL EPP** (FODEN 62-01143-000)

gauche - left - links



**168090**

(FODEN 62-01143-001) **K FPL**

droit - right - rechts



**K FPL**

**168090**

gauche - left - links



**168390**

**K FPL EPP**

droit - right - rechts



**PE**  
arrière  
rear connector  
Anschlusstecker  
hinten



**168340**

**K FPL EPP** (FODEN 62-01143-000)

gauche - left - links



**168270**

(FODEN 62-01143-001) **K FPL**

droit - right - rechts



**067500**

**K** (FODEN Y 058 701 02)

gauche - left - links



**067500**

(FODEN Y 058 701 02) **K**

droit - right - rechts

Fonctions supplémentaires  
Additional functions  
Zusatzfunktionen

**K** Catadioptr  
Reflector  
Rückstrahler

**FPL** Feu de position latéral  
Side marker lamp  
Seitenmarkierungsleuchte

**EPP** Eclairer de plaque  
Number plate lamp  
Kennzeichenleuchte

**EPP98**

p 177



**196010**

(FODEN 62-00109-000)

**GX**

**LC6**

p 156



PE  
arrière  
rear connector  
Anschlusstecker  
hinten



166500



066500



**LC7**

p 153



167150

(HEULIEZ 2773801/2870801)



067000

(HEULIEZ 3156201)

**FE81**

p 204



181000

(HEULIEZ 0190408700)



181050

(HEULIEZ 0190552400)

**FE79**

p 185



179240

(HEULIEZ 0190439000)



079040

Cabochon - Lens - Lichtscheibe

**C181**

p 179



118100

gauche - left - links



118100

droit - right - rechts

Fonctions supplémentaires  
Additional functions  
Zusatzfunktionen

Catadioptr  
Reflector  
Rückstrahler

**HEULIEZ**

HEULIEZ

GX

FE85 p 195



FE95 p 195



FPL93 p 201

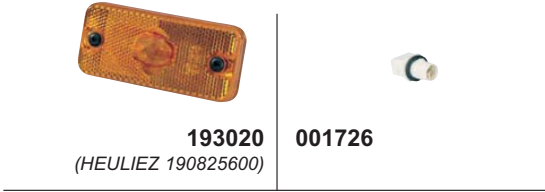

ICDL94 p 184

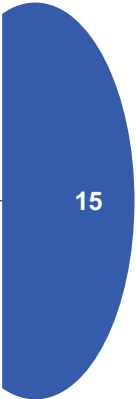

## R312 - R332

### LC4 p 157



### LC6 p 156



### LC7 p 153

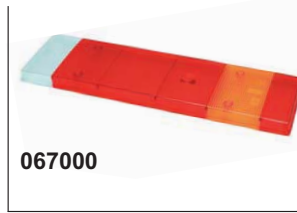

### FE81 p 204

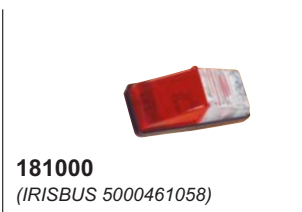

### FE79 p 203



Cabochon - Lens - Lichtscheibe

Fonctions supplémentaires  
Additional functions  
Zusatzfunktionen

K Catadioptré  
Reflector  
Rückstrahler

# IRISBUS

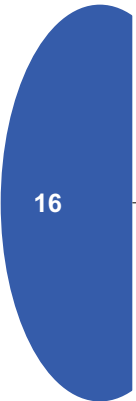



AGORA - CITELIS

LC7 p 153



gauche - left - links



droit - right - rechts

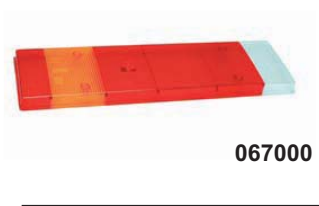

gauche - left - links

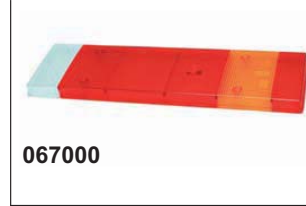

droit - right - rechts

C194 p 179



119400  
(IRISBUS 5001020317)

gauche - left - links



119410  
(IRISBUS 5001020318)

droit - right - rechts

ICDL94 p 184



119550  
(IRISBUS 5001020257)



001616  
(IRISBUS 5001834568)



001626  
(IRISBUS 5001837993)

FPL93 p 201



193020  
(IRISBUS 5010306792)



001726  
(IRISBUS 5001847589)

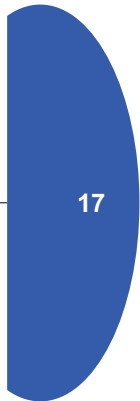

17

## AGORA - CITELIS

**SMD98** p 198



**198650**  
(IRISBUS 504217797)

**FE85** p 195



**185020**  
(IRISBUS 5010217022)



**185050**

**FE95** p 195



**195030**  
(IRISBUS 5001834505)



**195060**  
(IRISBUS 5001834576)

**BX868** p 176



**610091** C5W

# IRISBUS

IRISBUS

TRACER

2086 p 160



**20860705**  
(IRISBUS 7701025919)

gauche - left - links



**20860805**  
(IRISBUS 7701025921)

droit - right - rechts

FPL93 p 201

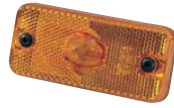

**193020**  
(IRISBUS 5010306792)



**001726**  
(IRISBUS 5001847589)

FE81 p 204



**181000**  
(IRISBUS 5000461058)



**181050**  
(IRISBUS 5000461059)

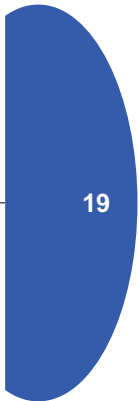

19

## ARES

### BD95



**195000**  
(IRISBUS 5010286898)



**001606**  
(IRISBUS 5001834564)

### FE95

p 195



**195030**  
(IRISBUS 5001834505)



**195060**  
(IRISBUS 5001834576)

### FM97

p 174



**197080**  
(IRISBUS 5010403075)



**197070**  
(IRISBUS 5010403076)

### ICDL94

p 184



**119550**  
(IRISBUS 5001020257)



**001616**  
(IRISBUS 5001834568)



**001626**  
(IRISBUS 5001837993)

### FPL93

p 201



**193020**  
(IRISBUS 5010306792)



**001726**  
(IRISBUS 5001847589)

# IRISBUS

## FR1

### FM91 *p 175*



Feu de recul  
Back up lamp  
Rückfahrleuchte



Feu de position  
Buck position lamp  
Schlussleuchte



Stop  
Stop  
Bremsleuchte



Feu clignotant arrière  
Back flasher lamp  
Hintere Blinkleuchte



Plafonnier  
Ceiling light  
Deckenleuchte



Feu de brouillard  
Fog lamp  
Nebelschlussleuchte

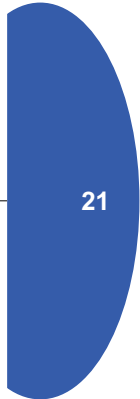

### C181 *p 179*



gauche - left - links

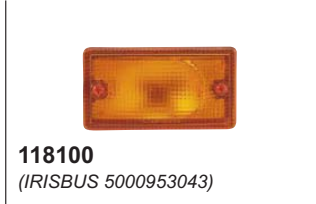

droit - right - rechts

### FE85 *p 195*



## ILIADE

# IRISBUS

### BD95



**195000**  
(IRISBUS 5010286898)



**001606**  
(IRISBUS 5001834564)

### C195

p 178



**119500**  
(IRISBUS 5010286903)

gauche - left - links



**119510**  
(IRISBUS 5010286904)

droit - right - rechts

### FE95

p 195



**195030**  
(IRISBUS 5001834505)



**195060**  
(IRISBUS 5001834576)

### ICDL94

p 184



**119550**  
(IRISBUS 5001020257)



**001616**  
(IRISBUS 5001834568)



**001626**  
(IRISBUS 5001837993)

### FPL93

p 201



**193020**  
(IRISBUS 5010306792)



**001726**  
(IRISBUS 5001847589)



IVECO

IVECO

680/688

p 170

-> 1990



EPP

680121

gauche - left - links



EPP

688621

gauche - left - links

725/726

p 161



K

EPP

725000

gauche - left - links



K

EPP

726770

gauche - left - links

DAILY

FPL93

p 201

-1996 ->



193020

(IVECO 500308514)



001726

LC7

p 153

-1996 -> 1999



IVECO  
arrière  
rear connector  
Anschlusstecker  
hinten



K

FPL

(IVECO 99463243)

gauche - left - links



168600

(IVECO 99463242)

K

FPL

droit - right - rechts



K

067500  
(IVECO 93161844)

gauche - left - links



067500

(IVECO 93161844)

K

droit - right - rechts

Fonctions supplémentaires  
Additional functions  
Zusatzfunktionen

K

Catadioptr  
Reflector  
Rückstrahler

FPL

Feu de position latéral  
Side marker lamp  
Seitenmarkierungsleuchte

EPP

Eclaireur de plaque  
Number plate lamp  
Kennzeichenleuchte

# DAILY

725 p 161



1999 -> 06/2006



**D11482**  
(IVECO 500356783)

gauche - left - links

AMP 1.5  
arrière  
rear connector  
Anschlusstecker  
hinten



**D11481**  
(IVECO 500356782)

droit - right - rechts



**D11480**

gauche - left - links



**D11479**

droit - right - rechts

725 p 161



06/2006->



**D12334**  
(IVECO 69500032)

gauche - left - links

AMP 1.5  
arrière  
rear connector  
Anschlusstecker  
hinten



**D12335**  
(IVECO 69500026)

droit - right - rechts



**D12336**  
(IVECO 42555132)

gauche - left - links



**D12337**  
(IVECO 42555131)

droit - right - rechts

# IVECO

Fonctions supplémentaires  
Additional functions  
Zusatzfunktionen

Catadioptré  
Reflector  
Rückstrahler

IVECO

**MASSIF 4 x 4**

**LC5**

p 150



2002 ->



AMP 1.5  
arrière  
rear connector  
Anschlussstecker  
hinten



K

152180

152180

K

gauche - left - links

droit - right - rechts



K

052500



052500

K

gauche - left - links

droit - right - rechts

**EUROSTAR - EUROTECH - EUROTRAKKER**

**LC7**

p 153



1996 -> 2002



IVECO  
arrière  
rear connector  
Anschlussstecker  
hinten



K

FPL

EPP

168610  
(IVECO 99463244)

168600

(IVECO 99463242)

K

FPL

gauche - left - links

droit - right - rechts



K

067500

(IVECO 93161844)



067500

(IVECO 93161844)

K

gauche - left - links

droit - right - rechts

Fonctions supplémentaires  
Additional functions  
Zusatzfunktionen

**Catadioptré**  
Reflector  
Rückstrahler

**Feu de position latéral**  
Side marker lamp  
Seitenmarkierungsleuchte

**Eclaireur de plaque**  
Number plate lamp  
Kennzeichenleuchte

**FPL93**

p 201



193020

(IVECO 500308514)



001726

## EUROCARGO

**LC7**

p 153

1996 ->



IVECO  
arrière  
rear connector  
Anschlusstecker  
hinten



**168590**

**K FPL** (IVECO 99463243)

gauche - left - links



**168600**

(IVECO 99463242) **K FPL**

droit - right - rechts



**168610**

**K FPL EPP** (IVECO 99463244)

gauche - left - links



**067500**

**K** (IVECO 93161844)

gauche - left - links



**067500**

(IVECO 93161844) **K**

droit - right - rechts

**C105**

p 178

06/2008 ->



**110520**

(IVECO 42555042)

gauche - left - links

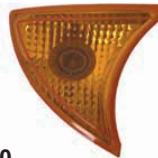

**110530**

(IVECO 42555041)

droit - right - rechts

**FPL93**

p 201



**193020**

(IVECO 500308514)



**001726**

Fonctions supplémentaires  
Additional functions  
Zusatzfunktionen

**K** **Catadioptré**  
Reflector  
Rückstrahler

**FPL** **Feu de position latéral**  
Side marker lamp  
Seitenmarkierungsleuchte

**EPP** **Eclaireur de plaque**  
Number plate lamp  
Kennzeichenleuchte

**IVECO**

26

IVECO

STRALIS - TRAKKER - ASTRA HD7/HD8

LC7

p 153

2002 ->



IVECO  
arrière  
rear connector  
Anschlusstecker  
hinten



168610

(IVECO 99463244) **K** **FPL** **EPP**

gauche - left - links



168600

(IVECO 99463242) **K** **FPL**

droit - right - rechts



168480

(IVECO R504083205) **K** **FPL** **ASR**

droit - right - rechts



067500

(IVECO 93161844) **K**

gauche - left - links



067500

(IVECO 93161844) **K**

droit - right - rechts

C199

p 178

2002 -> 05/2007



119920

(IVECO 41221041)

gauche - left - links



119930

(IVECO 41221040)

droit - right - rechts

C105

p 178

05/2007 ->



110520

(IVECO 42555042)

gauche - left - links

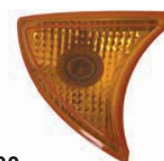

110530

(IVECO 42555041)

droit - right - rechts

Fonctions supplémentaires  
Additional functions  
Zusatzfunktionen

**K** Catadioptré  
Reflector  
Rückstrahler

**FPL** Feu de position latéral  
Side marker lamp  
Seitenmarkierungsleuchte

**EPP** Eclairer de plaque  
Number plate lamp  
Kennzeichenleuchte

**ASR** Alarme sonore de recul  
Back up alarm  
Rückfahrtsignalhorn

27

## STRALIS - TRAKKER - ASTRA HD7/HD8

**FPL93** p 201



**193170**  
(IVECO 41200664)

super seal



**001916**

super seal

**IVECO**

## SEDDON EUROMOVER

**LC7** p 153



**IVECO**  
arrière  
rear connector  
Anschlusstecker  
hinten

2000 ->



**168590**

**K FPL** (IVECO 99463243)

gauche - left - links



**168600**

(IVECO 99463242) **K FPL**

droit - right - rechts



**067500**

**K** (IVECO 93161844)

gauche - left - links



**067500**

(IVECO 93161844) **K**

droit - right - rechts

28

**ICDL94** p 184



**119550**  
(IVECO 97163920)



**001616**

Fonctions supplémentaires  
Additional functions  
Zusatzfunktionen

**K** **Catadioptré**  
**Reflector**  
**Rückstrahler**

**FPL** **Feu de position latéral**  
**Side marker lamp**  
**Seitenmarkierungsleuchte**



MAN

MAN

680/688 p 170

-> 1990



EPP

680121

gauche - left - links



EPP

688621

gauche - left - links

L - M - F

LC7 p 153

-1990 -> 2004



DIN  
arrière  
rear connector  
Anschlussstecker  
hinten



168090

K FPL (MAN 8125225-6033)

gauche - left - links



168090

(MAN 8125225-6464) K FPL

droit - right - rechts



168100

K FPL EPP (MAN 8125225-6034)

gauche - left - links



168490

(MAN 8125225-6528) K FPL ASR

droit - right - rechts

29

Fonctions supplémentaires  
Additional functions  
Zusatzfunktionen

- K Catadioptr  
Reflector  
Rückstrahler
- FPL Feu de position latéral  
Side marker lamp  
Seitenmarkierungsleuchte
- EPP Eclairer de plaque  
Number plate lamp  
Kennzeichenleuchte
- ASR Alarme sonore de recul  
Back up alarm  
Rückfahrhorn

TGA

LC7

p 153



1999 -> 2005

AMP 1.5  
latéral  
side connector  
Anschlusstecker  
seitlich



169180

K FPL (MAN 8125225-6526)

gauche - left - links



169170

(MAN 8125225-6523) K FPL

droit - right - rechts



169160

K FPL EPP (MAN 8125225-6524)

gauche - left - links



169190

(MAN 8125225-6530) K FPL ASR

droit - right - rechts



067500

K (MAN 8125229-6051)

gauche - left - links



067500

(MAN 8125229-6051) K

droit - right - rechts

MAN

30

Fonctions supplémentaires  
Additional functions  
Zusatzfunktionen

K Catadioptr  
Reflector  
Rückstrahler

FPL Feu de position latéral  
Side marker lamp  
Seitenmarkierungsleuchte

EPP Eclairer de plaque  
Number plate lamp  
Kennzeichenleuchte

ASR Alarme sonore de recul  
Back up alarm  
Rückfahrtsignalhorn

MAN

TGA - TGL - TGM - TGX

LC8

p 145



2005 ->



156200

**K** **FPL** **EPP** (MAN 8125225-6544)

gauche - left - links

AMP 1.5  
latéral  
side connector  
Anschlusstecker  
seitlich



156210

(MAN 8125225-6545) **K** **FPL**

droit - right - rechts



156220

(MAN 8125225-6547) **K** **FPL** **ASR**

droit - right - rechts



056500

**K** (MAN 8125229-6059)

gauche - left - links



056510

(MAN 8125229-6060) **K**

droit - right - rechts

31

NEOBUS

LC6

p 156



PE  
arrière  
rear connector  
Anschlusstecker  
hinten



166700

**K** (MAN 8125225-6469)

gauche - left - links



166700

(MAN 8125225-6470) **K**

droit - right - rechts

Fonctions supplémentaires  
Additional functions  
Zusatzfunktionen

**K** Catadioptré  
Reflector  
Rückstrahler

**FPL** Feu de position latéral  
Side marker lamp  
Seitenmarkierungsleuchte

**EPP** Eclairé de plaque  
Number plate lamp  
Kennzeichenleuchte

**ASR** Alarme sonore de recul  
Back up alarm  
Rückfahrhorn



066500

**K**

gauche - left - links



066500

**K**

droit - right - rechts

## MANISCOPIC

**LC5**

p 150



2001 ->



**AMP 1.5**  
arrière  
rear connector  
Anschlusstecker  
hinten



**152180**

**K** (MANITOU 223767)

gauche - left - links

**152180**

(MANITOU 223766) **K**

droit - right - rechts



**K**

**052500**

gauche - left - links



**K**

**052500**

droit - right - rechts

# MANITOU

## MSI

**BBS516**

p 166



1999 ->



**PF**  
arrière  
rear connector  
Anschlusstecker  
hinten



**500930**

**EPP** (MANITOU 163782)

gauche - left - links

**500940**

(MANITOU 163783)

droit - right - rechts

32

Fonctions supplémentaires  
Additional functions  
Zusatzfunktionen

**K** Catadioptr  
Reflector  
Rückstrahler

**EPP** Eclairer de plaque  
Number plate lamp  
Kennzeichenleuchte

# MERCEDES

## MERCEDES

680/688 p 170

-> 1990



**680121**  
gauche - left - links



**688621**  
gauche - left - links

672 p 159



**672000**  
(MB 0008202864)

## SPRINTER

LC8 p 146

-> 06/2006



**AMP 1.5**  
arrière  
rear connector  
Anschlussstecker  
hinten



**156340**  
(MB A9068200464)

gauche - left - links



**156350**  
(MB A9068201764)

droit - right - rechts



**056540**  
(MB A9068262056)

gauche - left - links



**056550**  
(MB A9068262156)

droit - right - rechts

Fonctions supplémentaires  
Additional functions  
Zusatzfunktionen

**K** Catadioptr  
Reflector  
Rückstrahler

**FPL** Feu de position latéral  
Side marker lamp  
Seitenmarkierungsleuchte

**EPP** Eclaireur de plaque  
Number plate lamp  
Kennzeichenleuchte

## CABSTAR - ATLEON

**LC5**

p 150



**AMP 1.5**  
arrière  
rear connector  
Anschlusstecker  
hinten



**152170**

**K** **EPP** (NISSAN 26555-9X126)

gauche - left - links



**152180**

(NISSAN 26555-9X125) **K**

droit - right - rechts



**052500**

**K** (NISSAN 26554-9X126)

gauche - left - links



**052500**

(NISSAN 26554-9X126) **K**

droit - right - rechts

**ICDL94**

p 184



**119550**

(NISSAN 26164-9X402)



**001616**

(NISSAN 26244-9X400)

**NISSAN**

34

Fonctions supplémentaires  
Additional functions  
Zusatzfunktionen

**Catadioptr**  
Reflector  
Rückstrahler

**Eclaireur de plaque**  
Number plate lamp  
Kennzeichenleuchte



# RENAULT AGRI

35

## RENAULT AGRI

**LA25** p 167



**PE**  
arrière  
rear connector  
Anschlussstecker  
hinten



**125100**  
(RT7700694212)  
EPP

gauche - left - links



**125200**  
(RT7700694211)

droit - right - rechts



**025100**  
EPP

gauche - left - links



**025200**

droit - right - rechts

**2066/1045** p 169



**PF**  
arrière  
rear connector  
Anschlussstecker  
hinten



**20660617**  
(RT7700647067)



**20661609**  
(RT7701020229)

Cabochon - Lens - Lichtscheibe



**10450605**  
(RT 7700620025/78)



**10451605**  
(RT 7701020232)

Cabochon - Lens - Lichtscheibe

**EPP96** p 177

Fonctions supplémentaires  
Additional functions  
Zusatzfunktionen

EPP

Eclaireur de plaque  
Number plate lamp  
Kennzeichenleuchte



**196020**  
(RT 7700027564)

# MAGNUM

## C184

p 179

-1991 -> 2003



**118440**  
(RENAULT 5010306711)

gauche - left - links



**118440**  
(RENAULT 5010306711)

droit - right - rechts

## FE85

p 184-195



**185020**  
(RT 5010217022)

gauche - left - links

1991 ->



**185020**  
(RT 5010217022)

droit - right - rechts



5W

**185040**  
(RT 5010217023)

gauche - left - links

1991-> 12/1998



**185040**  
(RT 5010217023)

5W

droit - right - rechts



21W

**185160**  
(RT 5010271807)

gauche - left - links

12/1998 ->



**185160**  
(RT 5010271807)

21W

droit - right - rechts

# RENAULT TRUCKS

# MAGNUM

**FE04**

p 187

06/2008 ->



**104290**  
(RT 7421430181)



**104510**  
(RT 7485114646)

**FPL93**

p 201

1994 ->



**193020**  
(RT 5010306792)



**001726**  
(RT 5001847589)

**FE02**

p 191

2003 ->

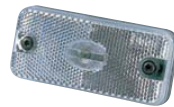

**102200**  
(RT 5001862030)



**001726**  
(RT 5001847589)

Clippé - Clipped - Clip-Befestigung

Autoperforant pour raccorde-  
ment sur câble plat  
Click-in for flat cable  
Click-in -Anschluss für  
Flachkabel



# RENAULT TRUCKS

37

## MAGNUM

**FTC**

p 220

10/2009 ->



**NEW**



**D13019\*\***  
(RT 7421396991)

**NEW**



**D13020\*\***  
(RT 7421396993)

**LC6**

p 156

1991-> 12/1998



**PE**  
arrière  
rear connector  
Anschlusstecker  
hinten



**166100\***  
(RT 5000296591)

gauche - left - links



**166000\***  
(RT 5000296591)

droit - right - rechts



**AMP 1.5**  
latéral  
side connector  
Anschlusstecker  
seitlich

12/1998 -> 09/2004



**169060**  
**EPP** (RT 5001847582)

gauche - left - links



**169070**  
(RT 5001847583)

droit - right - rechts



**066000**  
(RT 5000296593)

gauche - left - links



**066000**  
(RT 5000296593)

droit - right - rechts

\* Cales non fournies, voir ref. 001656 p.154

\*Brocks not supplied, see p/n 001656 p.154

\*Distanzstücke Art.-Nr. 001656 nicht im Lieferumfang, s Seite 154

\*\*Lampe fournie

\*\*Bulb included

\*\*Inklusiv Glühlampen

Fonctions supplémentaires  
Additional functions  
Zusatzfunktionen



**Eclaireur de plaque**  
**Number plate lamp**  
**Kennzeichenleuchte**

# RENAULT TRUCKS

# RENAULT TRUCKS

39

## MAGNUM

LC7

p 153



PE  
arrière  
rear connector  
Anschlusstecker  
hinten

1990 -> 1994



**167100\***  
EPP (RT 5000296592)

gauche - left - links



**167000\***  
(RT 5000296592)

droit - right - rechts

1994 -> 12/1998



**168220**  
FPL EPP (RT 5001831194)

gauche - left - links



**168260**  
(RT 5001832999) FPL

droit - right - rechts



AMP 1.5  
latéral  
side connector  
Anschlusstecker  
seitlich

-12/1998 -> 09/2004



**169020**  
FPL EPP (RT 5001847586)

gauche - left - links



**169030**  
(RT 5001847587) FPL

droit - right - rechts

\* Cales non fournies, voir ref. 001656 p. 154

\*Brocks not supplied, see p/n 001656 p.154

\*Distanzstücke Art.-Nr. 001656 nicht im Lieferumfang, s Seite 154

Fonctions supplémentaires  
Additional functions  
Zusatzfunktionen

**K** Catadioptr  
Reflector  
Rückstrahler

**FPL** Feu de position latéral  
Side marker lamp  
Seitenmarkierungsleuchte

**EPP** Eclaireur de plaque  
Number plate lamp  
Kennzeichenleuchte



**067000**  
(RT 5000296594)

gauche - left - links



**067000**  
(RT 5000296594)

droit - right - rechts



**169000**  
K FPL EPP (RT 5001847584)

gauche - left - links



**169010**  
(RT 5001847585) K FPL

droit - right - rechts



**067500**  
K (RT 5001847588)

gauche - left - links



**067500**  
(RT 5001847588) K

droit - right - rechts

## MAGNUM

LC7

p 153

09/2004 -> 01/2006



AMP 1.5  
latéral  
side connector  
Anschlussstecker  
seitlich



**169310**

**K** **FPL** **EPP** (RT 5001864535)

gauche - left - links



**169320**

(RT 5001864536) **K** **FPL**

droit - right - rechts



Entraxe : 160 mm  
Bolt distance : 160 mm  
Schraubenabstand : 160 mm



**169330**

(RT 5001864537) **K** **FPL** **ASR**

droit - right - rechts



**067500**

**K** (RT 5001847588)

gauche - left - links



**067500**

(RT 5001847588) **K**

droit - right - rechts

01/2006 ->

LC9

p 144



AMP 1.5  
latéral  
side connector  
Anschlussstecker  
seitlich



**159010**

**K** **FPL** **EPP** (RT 7420802348)

gauche - left - links



**159020**

(RT 7420802350) **K** **FPL**

droit - right - rechts



**159030**

(RT 7420802353) **K** **FPL** **ASR**

droit - right - rechts



**059000**

**K** (RT 7420802418)

gauche - left - links



**059000**

(RT 7420802418) **K**

droit - right - rechts

Fonctions supplémentaires  
Additional functions  
Zusatzfunktionen

**K** Catadioptré  
Reflector  
Rückstrahler

**FPL** Feu de position latéral  
Side marker lamp  
Seitenmarkierungsleuchte

**EPP** Eclairage de plaque  
Number plate lamp  
Kennzeichenleuchte

**ASR** Alarme sonore de recul  
Back up alarm  
Rückfahrtsignalhorn

# RENAULT TRUCKS

40



# RENAULT TRUCKS

41

## PREMIUM

**C194**

p 179

1995 -> 06/2006



**119400**  
(RT 5001834560)

gauche - left - links



**119410**  
(RT 5001834559)

droit - right - rechts

**FE95**

p 195

1995 ->



**195010**  
(RT 5001834561)

gauche - left - links



**195010**  
(RT 5001834561)

droit - right - rechts

**ICDL94**

p 184

1995 ->

12/1998 ->



5W  
**119450**  
(RT 5001834565)



21W  
**119470**  
(RT 5001847597)



**001616**  
(RT 5001834568)

**FPL93**

p 201

1995 ->



**193020**  
(RT 5010306792)



**001726**  
(RT 5001847589)

**FE02**

p 191

2003 ->



**193200\***  
(RT 5001862030)



**102200\*\***  
(RT 5001862030)



**001726**  
(RT 5001847589)

\* Feu d'encombrement Viscope  
Viscope outline marker lamp  
Umrissleuchte Viscope

\*\* Feu d'embranchement  
Set lamp  
Einstiegsbeleuchtung

Vissé - Screwed - Geschraubt

Clippé - Clipped - Befestigung

## PREMIUM

**SMD98** p 198

09/2007->



**198650**  
(RT 7421106206)

Feu d'identification Viscope  
Viscope identification lamp  
Markierungsleuchte Viscope

**FTC**

p 220

10/2009 ->



**D13019\*\***  
(RT 7421396991)



**D13020\*\***  
(RT 7421396993)

**LC6**

p 156

1995-> 12/1998



**PE**  
arrière  
rear connector  
Anschlusstecker  
hinten



**166100\***  
(RT 5000296591)

gauche - left - links



**166000\***  
(RT 5000296591)

droit - right - rechts



**AMP 1.5**  
latéral  
side connector  
Anschlusstecker  
seitlich



**169060**  
EPP (RT 5001847582)

gauche - left - links



**169070**  
(RT 5001847583)

droit - right - rechts



**066000**  
(RT 5000296593)

gauche - left - links



**066000**  
(RT 5000296593)

droit - right - rechts

06/2001 ->

\* Silent blocs non fournis, voir ref. 001706 p.154

\*Silent blocs not supplied, see p/n 001706 p.154

\*Schwingungsdämpfer Art.-Nr. 001706 nicht im Lieferumfang, s. Seite 154

\*\*Lampe fournie

\*\*Bulb included

\*\*Inklusiv Glühlampen

Fonctions supplémentaires  
Additional functions  
Zusatzfunktionen



**Eclaireur de plaque**  
**Number plate lamp**  
**Kennzeichenleuchte**

## PREMIUM

Variante - Other version - Variante

**LC5**

p 150

06/2001 -> 09/2004

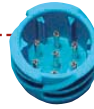

**AMP 1.5**  
arrière  
rear connector  
Anschlusstecker  
hinten



**152020**

**EPP** (RT 5001846847)



**152500**

(RT 5001858092)

**152510**

**EPP** (RT 5001857964)



**152520**

(RT 5001857965)



gauche - left - links

droit - right - rechts



**052000**

(RT 5010392231)

gauche - left - links



**052000**

(RT 5010392231)

droit - right - rechts

**LC7**

p 153

1995 -> 1999



**PE**  
arrière  
rear connector  
Anschlusstecker  
hinten



**168220**

**FPL** **EPP** (RT 5001831194)



**168260**

(RT 5001832999)

**FPL**

**168260**

**FPL** (RT 5001832999)



**168140**

(RT 5001835853)

**FPL**

**EPP**

gauche - left - links

droit - right - rechts



**067000**

(RT 5001847588)

gauche - left - links



**067000**

(RT 5001847588)

droit - right - rechts

Fonctions supplémentaires  
Additional functions  
Zusatzfunktionen

**FPL**

Feu de position latéral  
Side marker lamp  
Seitenmarkierungsleuchte

**EPP**

Eclaireur de plaque  
Number plate lamp  
Kennzeichenleuchte

## PREMIUM

LC7

p 153



1999 -> 09/2004



**169020**

FPL EPP (RT 5001847586)

gauche - left - links

AMP 1.5  
latéral  
side connector  
Anschlusstecker  
seitlich



**169030**

(RT 5001847587) FPL

droit - right - rechts



**067000**

(RT 5000296594)

gauche - left - links



**067000**

(RT 5000296594)

droit - right - rechts



**169000**

K FPL EPP (RT 5001847584)

gauche - left - links



**169010**

(RT 5001847585) K FPL

droit - right - rechts



**067500**

K (RT 5001847588)

gauche - left - links



**067500**

(RT 5001847588) K

droit - right - rechts

# RENAULT TRUCKS

44

Fonctions supplémentaires  
Additional functions  
Zusatzfunktionen

**K** Catadioptr  
Reflector  
Rückstrahler

**FPL** Feu de position latéral  
Side marker lamp  
Seitenmarkierungsleuchte

**EPP** Eclaireur de plaque  
Number plate lamp  
Kennzeichenleuchte

# RENAULT TRUCKS

45

## PREMIUM

LC7

p 153



-09/2004 -> 01/2006



**169310**

(RT 5001864535)



gauche - left - links

AMP 1.5  
latéral  
side connector  
Anschlussstecker  
seitlich



**169320**

(RT 5001864536)



droit - right - rechts



Entraxe : 160 mm  
Bolt distance : 160 mm  
Schraubenabstand : 160 mm



**169330**

(RT 5001864537)



droit - right - rechts



**067500**

(RT 5001847588)



gauche - left - links



**067500**

(RT 5001847588)



droit - right - rechts

LC9

p 144



01/2006 ->



**159010**

(RT 7420802348)



gauche - left - links

AMP 1.5  
latéral  
side connector  
Anschlussstecker  
seitlich



**159020**

(RT 7420802350)



droit - right - rechts



**159030**

(RT 7420802353)



droit - right - rechts



**059000**

(RT 7420802418)



gauche - left - links



**059000**

(RT 7420802418)



droit - right - rechts

Fonctions supplémentaires  
Additional functions  
Zusatzfunktionen

**K** Catadioptré  
Reflector  
Rückstrahler

**FPL** Feu de position latéral  
Side marker lamp  
Seitenmarkierungsleuchte

**EPP** Eclairé de plaque  
Number plate lamp  
Kennzeichenleuchte

**ASR** Alarme sonore de recul  
Back up alarm  
Rückfahrhorn



## KERAX

**C194**

p 179

1995 ->



**119400**  
(RT 5001834560)

gauche - left - links



**119410**  
(RT 5001834559)

droit - right - rechts

**FE95**

p 195

1995 ->



**195010**  
(RT 5001834561)

gauche - left - links



**195010**  
(RT 5001834561)

droit - right - rechts

**ICDL94**

p 184

1995 ->

1999->



**119450**  
(RT 5001834565)

5W



**119470**  
(RT 5001847597)

21W



**001616**  
(RT 5001834568)

**FPL93**

p 201

1995 ->



**193020**  
(RT 5010306792)



**001726**  
(RT 5001847589)

**FE02**

p 191

2003 ->



**193200\***  
(RT 5001862030)

Vissé - Screwed - Geschraubt



**102200\*\***  
(RT 5001862030)

Clippé - Clipped - Befestigung



**001726**  
(RT 5001847589)

\* Feu d'encombrement Viscope  
Viscope outline marker lamp  
Umrisleuchte Viscope

\*\* Feu d'embranchement  
Set lamp  
Einstiegsbeleuchtung

RENAULT TRUCKS



# RENAULT TRUCKS

47

## KERAX

**FTC**

p 220

10/2009 ->



**D13019\*\***  
(RT 7421396991)



**D13020\*\***  
(RT 7421396993)



**LC6**

p 156



**PE**  
arrière  
rear connector  
Anschlusstecker  
hinten

1995 -> 09/1998



**166100\***  
EPP (RT 5000296591)

gauche - left - links



**166000\***  
(RT 5000296591)

droit - right - rechts



**066000**  
(RT 5000296593)

gauche - left - links



**066000**  
(RT 5000296593)

droit - right - rechts

**LC7**

p 153



**AMP 1.5**  
latéral  
side connector  
Anschlusstecker  
seitlich

09/1998 -> 09/2004



**169020**  
FPL EPP (RT 5001847586)

gauche - left - links



**169030**  
(RT 5001847587) FPL

droit - right - rechts



**067000**  
(RT 5000296594)

gauche - left - links



**067000**  
(RT 5000296594)

droit - right - rechts

\* Silent blocs non fournis,  
voir ref. 001706 p.154

\*Silent blocs not supplied,  
see p/n 001706 p.154

\*Schwingungsdämpfer Art.-  
Nr. 001706 nicht im  
Lieferumfang, s. Seite 154

\*\*Lampe fournie  
\*\*Bulb included  
\*\*Inklusiv Glühlampen

Fonctions supplémentaires  
Additional functions  
Zusatzfunktionen

**FPL** Feu de position latéral  
Side marker lamp  
Seitenmarkierungsleuchte

**EPP** Eclairer de plaque  
Number plate lamp  
Kennzeichenleuchte

# KERAX

**LC7** p 153



1995-> 09/1998



**168220\***  
(RT 5001831194) **K FPL EPP**

**PE**  
arrière  
rear connector  
Anschlusstecker  
hinten



**168260\***  
(RT 5001832999) **K FPL**

**168260\***  
(RT 5001832999) **K FPL**

gauche - left - links

**168140\***  
(RT 5001835853) **K FPL EPP**

droit - right - rechts

**LC7** p 153

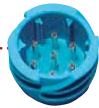

09/1998 -> 09/2004



**169000**  
(RT 5001847584) **K FPL EPP**

**AMP 1.5**  
latéral  
side connector  
Anschlusstecker  
seitlich



**169010**  
(RT 5001847585) **K FPL**

gauche - left - links

droit - right - rechts



09/2004 ->



**169310**  
(RT 5001864535) **K FPL EPP**

**AMP 1.5**  
latéral  
side connector  
Anschlusstecker  
seitlich



**169320**  
(RT 5001864536) **K FPL**

gauche - left - links

droit - right - rechts

Entraxe : 160 mm  
Bolt distance : 160 mm  
Schraubenabstand : 160 mm



**067500**  
(RT 5001847588) **K**

gauche - left - links



**169330**  
(RT 5001864537) **K FPL ASR**

droit - right - rechts



**067500**  
(RT 5001847588) **K**

droit - right - rechts

\* Silent blocs non fournis, voir ref. 001706 p.154

\*Silent blocs not supplied, see p/n 001706 p.154

\*Schwingungsdämpfer Art.-Nr. 001706 nicht im Lieferumfang, s. Seite 154

Fonctions supplémentaires  
Additional functions  
Zusatzfunktionen

**K** Catadioptré  
Reflector  
Rückstrahler

**FPL** Feu de position latéral  
Side marker lamp  
Seitenmarkierungsleuchte

**EPP** Eclaireur de plaque  
Number plate lamp  
Kennzeichenleuchte

**ASR** Alarme sonore de recul  
Back up alarm  
Rückfahrtsignalhorn

# RENAULT TRUCKS

## KERAX

LC9

p 144



06/2006 ->



**159010**

**K** **FPL** **EPP** (RT 7420802348)

gauche - left - links

**AMP 1.5**  
latéral  
side connector  
Anschlusstecker  
seitlich



**159020**

(RT 7420802350) **K** **FPL**

droit - right - rechts



**159030**

(RT 7420802353) **K** **FPL** **ASR**

droit - right - rechts



**059000**

**K** (RT 7420802418)

gauche - left - links



**059000**

(RT 7420802418) **K**

droit - right - rechts

49

Fonctions supplémentaires  
Additional functions  
Zusatzfunktionen

- K** **Catadioptr**  
Reflector  
Rückstrahler
- FPL** **Feu de position latéral**  
Side marker lamp  
Seitenmarkierungsleuchte
- EPP** **Eclaireur de plaque**  
Number plate lamp  
Kennzeichenleuchte
- ASR** **Alarme sonore de recul**  
Back up alarm  
Rückfahrhorn

## MIDLINER

**1085**

p 181



**10850603**  
(RT 5000462758)

gauche - left - links

1986 -> 1996



**10850603**  
(RT 5000462758)

droit - right - rechts

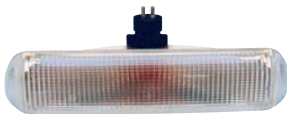

**10850605**  
(RT 5010271775)

gauche - left - links

1996 -> 1999

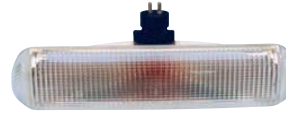

**10850605**  
(RT 5010271775)

droit - right - rechts

**FE86**

p 195

1986 -> 1999



**186030**  
(RT 5000463046)

gauche - left - links



**186040**  
(RT 5000463047)

droit - right - rechts

**LC4**

p 157



PE  
arrière  
rear connector  
Anschlusstecker  
hinten



**141500**  
(RT 5000808172)

**K** **EPP**

gauche - left - links



**141500**  
(RT 5000808172)

**K** **EPP**

droit - right - rechts



**040500**  
(RT 5000808166)

**K**

gauche - left - links



**040500**  
(RT 5000808166)

**K**

droit - right - rechts

Fonctions supplémentaires  
Additional functions  
Zusatzfunktionen

**K** Catadioptré  
Reflector  
Rückstrahler

**EPP** Eclairé de plaque  
Number plate lamp  
Kennzeichenleuchte

50

## MIDLUM

**FE95**

p 195

-1999 ->



**195010**  
(RT 5001834561)

gauche - left - links



**195010**  
(RT 5001834561)

droit - right - rechts

**ICDL94**

p 184

-> 1999

1999 ->



5W

**119450**  
(RT 5001834565)



21W

**119470**  
(RT 5001847597)



**001616**  
(RT 5001834568)

**FPL93**

p 201

-1999 ->



**193020**  
(RT 5010306792)



**001726**  
(RT 5001847589)



**193280**



**001726**  
(RT 5001847589)

**FE02**

p 191

-2003 ->



**102200**  
(RT 5001862030)



**001726**  
(RT 5001847589)

Clippé - Clipped - Befestigung

**EPP98**

p 177

-2003 ->



**196010**  
(RT 5010293829)

droit - right - rechts



## MIDLUM

**C194**

p 179

-1999 ->



**119400**  
(RT 5001834560)

gauche - left - links



**119410**  
(RT 5001834559)

droit - right - rechts

**LC5**

p 150

1999 -> 09/2005



AMP 1.5  
arrière  
rear connector  
Anschlusstecker  
hinten



**152020**  
EPP (RT 5001846847)

**152060**  
EPP (RT 5001846849)

gauche - left - links



**152030**  
(RT 5001846848)

**152070**  
(RT 5001846850)

droit - right - rechts

09/2005 ->



**152190**  
EPP (RT 7420862038)

gauche - left - links



**152200**  
(RT 7420862041)

droit - right - rechts



**052000**  
(RT 5010392231)

gauche - left - links



**052000**  
(RT 5010392231)

droit - right - rechts

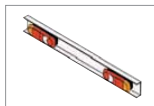

1999 -> 09/2005



**152000**  
K (RT 5001846843)

**152040**  
K (RT 5001846845)

gauche - left - links



**152010**  
K (RT 5001846844)

**152050**  
K (RT 5001846846)

droit - right - rechts

Fonctions supplémentaires  
Additional functions  
Zusatzfunktionen

Catadioptré  
Reflector  
Rückstrahler

Eclaireur de plaque  
Number plate lamp  
Kennzeichenleuchte



MIDLUM

RENAULT TRUCKS

53

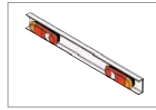

09/2005->



**152880**  
(RT 7420862032)

K

gauche - left - links



**152880**  
(RT 7420862035)

K

droit - right - rechts



**052500**  
(RT 5001847153)

K

gauche - left - links



**052500**  
(RT 5001847153)

K

droit - right - rechts

LC7

p 153

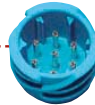

1999 -> 04/2006



**169000**

K FPL EPP (RT 5001847584)

gauche - left - links

AMP 1.5  
latéral  
side connector  
Anschlusstecker  
seitlich



**169010**

(RT 5001847585) K FPL

droit - right - rechts



**067500**

K (RT 5001847588)

gauche - left - links



**067500**

(RT 5001847588) K

droit - right - rechts

Fonctions supplémentaires  
Additional functions  
Zusatzfunktionen

**K** Catadioptré  
Reflector  
Rückstrahler

**FPL** Feu de position latéral  
Side marker lamp  
Seitenmarkierungsleuchte

**EPP** Eclairéur de plaque  
Number plate lamp  
Kennzeichenleuchte

EPP96

p 177

-1999 ->



**196020**

(RT 7700353021)

## MASTER

**FM91**

p 175

08/2008 ->



**191170**  
(RT 7421268609)

## MASCOTT

**FM97**

p 174

-1998 ->



**197050**  
(RT 7700377095)



**197040**  
(RT 7700377094)

**ICDL94**

p 184

-1998 ->



**119450**  
(RT 5001834565)



**001616**  
(RT 5001834568)

**LC4**

p 157

-1998 -> 07/2001



**PE**  
arrière  
rear connector  
Anschlusstecker  
hinten



**141500**  
**K** **EPP** (RT 5000808172)

gauche - left - links



**141500**  
(RT 5000808172) **K** **EPP**

droit - right - rechts



**040500**  
**K** (RT 5000808166)

gauche - left - links



**040500**  
(RT 5000808166) **K**

droit - right - rechts

Fonctions supplémentaires  
Additional functions  
Zusatzfunktionen

**K** Catadioptré  
Reflector  
Rückstrahler

**EPP** Eclaireur de plaque  
Number plate lamp  
Kennzeichenleuchte

## MASCOTT

LC5

p 150



07/2001 -> 04/2006



**152020**

**EPP** (RT 5001846847)

AMP 1.5  
arrière  
rear connector  
Anschlusstecker  
hinten



**152500**

(RT 5001858092)

**EPP** **152510**  
(RT 5001857964)



gauche - left - links



**152520**  
(RT 5001857965)

droit - right - rechts



**052000**

(RT 5010392231)

gauche - left - links



**052000**

(RT 5010392231)

droit - right - rechts

04/2006->



**152170**

**EPP** **K**

gauche - left - links



**152180**

**K**

droit - right - rechts



**052500**

**K** (RT 5001847153)

gauche - left - links



**052500**

(RT 5001847153) **K**

droit - right - rechts



07/2001 -> 04/2006



**152000**

**K** (RT 5001846843)

gauche - left - links



**152600**

(RT 5001858093) **K**

droit - right - rechts

**EPP** **152610**  
(RT 5001857966)



**152620**  
(RT 5001857967) **K**

Fonctions supplémentaires  
Additional functions  
Zusatzfunktionen

**K** Catadioptré  
Reflector  
Rückstrahler

**EPP** Eclairer de plaque  
Number plate lamp  
Kennzeichenleuchte

## MASCOTT

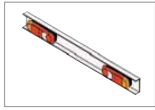

04/2006 ->



**K**

**152880**  
(RT 7420862032)

gauche - left - links



**K**

**152880**  
(RT 7420862035)

droit - right - rechts



**K**

**052500**  
(RT 5001847153)

gauche - left - links



**K**

**052500**  
(RT 5001847153)

droit - right - rechts

## EPP98

p 177

-1998 ->



**196010**  
(RT 5010293829)

## SMD98

p 198

-1998 ->



**198510**  
(RT 5010293829)

4 x LEDS-12V

## CA

p 213

1998 ->  
04/2006

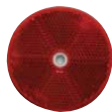

**620236**  
(RT 7700377130)

04/2006 ->



**620056**  
(RT 8200602314)

Fonctions supplémentaires  
Additional functions  
Zusatzfunktionen

**K** Catadioptré  
Reflector  
Rückstrahler

**EPP** Eclaireur de plaque  
Number plate lamp  
Kennzeichenleuchte

# RENAULT TRUCKS

56

**MASTER**

**LC5** p 150

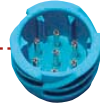

04/2010 ->



**AMP 1.5**  
arrière  
rear connector  
Anschlusstecker  
hinten



**152180**  
(265551402R)

**152180**  
(265504514R)

**152180**  
(265550674R)

**152180**  
(265500292R)

gauche - left - links

droit - right - rechts

**LA25** p 167



**125430**  
(RT 5000623398)

gauche - left - links

**125430**  
(RT 5000623398)

droit - right - rechts

**025210**  
(RT 5000810542)

gauche - left - links  
Cabochon - Lens - Lichtscheibe

**025210**  
(RT 5000810542)

droit - right - rechts  
Cabochon - Lens - Lichtscheibe

**EPP96/98** p 177

04/2010 ->



**196010**  
(265100848R)

04/2010 ->



**196020**  
(RT 7700353021)

-> 04/2010

Fonctions supplémentaires  
Additional functions  
Zusatzfunktionen

**Catadioptr**  
Reflector  
Rückstrahler

**Eclaireur de plaque**  
Number plate lamp  
Kennzeichenleuchte

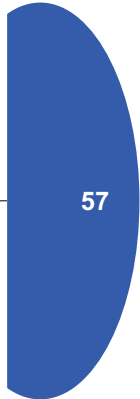

57

## MASTER

2066

p 169



PF  
arrière  
rear connector  
Anschlusstecker  
hinten



**20660617**  
(RT 7701026301)

gauche - left - links



**20660617**  
(RT 7701026302)

droit - right - rechts



**20661609**  
(RT 7701026300)

gauche - left - links  
Cabochon - Lens - Lichtscheibe



**20661609**  
(RT 7701026300)

droit - right - rechts  
Cabochon - Lens - Lichtscheibe

## GAMME B

FE85

p 195



**185020**  
(RT 5010217022)

gauche - left - links



**185020**  
(RT 5010217022)

droit - right - rechts

FPL93

p 201



**193020**  
(RT 5010306792)



**001726**  
(RT 5001847589)

RENAULT TRUCKS



## GAMME B

### LC4 *p 157*



PE  
arrière  
rear connector  
Anschlusstecker  
hinten



**141000**

**EPP** (RT 5000808171)

gauche - left - links



**040000**

(RT 5000807304)

gauche - left - links



**141000**

(RT 5000808171) **EPP**

droit - right - rechts



**040000**

(RT 5000807304)

droit - right - rechts

### LA25 *p 167*



PE  
arrière  
rear connector  
Anschlusstecker  
hinten

→ 06 / 1993



**125430**

**K** (RT 5000623398)

gauche - left - links



**025210**

**K** (RT 5000810542)

gauche - left - links



**125430**

(RT 5000623398) **K**

droit - right - rechts



**025210**

(RT 5000810542) **K**

droit - right - rechts



**125200**

(RT 5010231161)

gauche - left - links



**125200**

(RT 5010231161)

droit - right - rechts



**025200**

(RT 5001825075)

gauche - left - links



**025200**

(RT 5001825075)

droit - right - rechts

Fonctions supplémentaires  
Additional functions  
Zusatzfunktionen

**K** Catadioptré  
Reflector  
Rückstrahler

**EPP** Eclaireur de plaque  
Number plate lamp  
Kennzeichenleuchte

## GAMME C

### FE81 p 185-204



**181050**  
(RT 5000461059)



**181000**  
(RT 5000461058)

### FE88 p 203



**178340**  
(RT 5010040505)



**087040**  
(RT 5000808095)

Cabocho - Lens - Lichtscheibe



**188310**  
(RT 5000623050)



**088010**  
(RT 5000296718)

Cabocho - Lens - Lichtscheibe

### LC4 p 157



**PE**  
arrière  
rear connector  
Anschlussstecker  
hinten



**141110**  
EPP (RT 5000815760)

gauche - left - links



**141310**  
EPP (RT 5000815761)

droit - right - rechts



**040000**  
(RT 5000807304)

gauche - left - links



**040000**  
(RT 5000807304)

droit - right - rechts

Fonctions supplémentaires  
Additional functions  
Zusatzfunktionen



**Eclaireur de plaque**  
Number plate lamp  
Kennzeichenleuchte

# RENAULT TRUCKS

60

# RENAULT TRUCKS

61

## GAMME C

**C166**

p 171



-> 1986



**116600**  
(RT 0027567009)

PF  
arrière  
rear connector  
Anschlusstecker  
hinten



**016600**  
(RT 003603705)

Cabochoon - Lens - Lichtscheibe

**LA35**

p 165



-> 1986

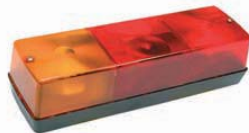

**135100**  
(RT 5000589493)

PF  
arrière  
rear connector  
Anschlusstecker  
hinten



**135100**  
(RT 5000589493)

gauche - left - links

droit - right - rechts



**035000**  
(RT 5000803784)

gauche - left - links



**035000**  
(RT 5000803784)

droit - right - rechts

**LC4**

p 157



-> 1986



**141500**  
(RT 5000808172) **K** **EPP**

gauche - left - links

PE  
arrière  
rear connector  
Anschlusstecker  
hinten



**141500**  
(RT 5000808172) **K** **EPP**

droit - right - rechts



**040500**  
(RT 5000808166) **K**

gauche - left - links



**040500**  
(RT 5000808166) **K**

droit - right - rechts

Fonctions supplémentaires  
Additional functions  
Zusatzfunktionen

**K** Catadioptré  
Reflector  
Rückstrahler

**EPP** Eclairer de plaque  
Number plate lamp  
Kennzeichenleuchte

## GAMME G

LC4

p 157



→ 1986



**141000**  
(RT 5000808171)

EPP

(RT 5000808171)

gauche - left - links



**040000**  
(RT 5000807304)

gauche - left - links



K EPP

**141500**  
(RT 5000808172)

gauche - left - links



K

**040500**  
(RT 5000808166)

gauche - left - links



**141000**  
(RT 5000808171) EPP

droit - right - rechts



**040000**  
(RT 5000807304)

droit - right - rechts



**141500**  
(RT 5000808172) K EPP

droit - right - rechts



**040500**  
(RT 5000808166) K

droit - right - rechts



→ 1986



LC6

p 156



**166000**  
(RT 5000296591)

gauche - left - links



**066000**  
(RT 5000296593)

gauche - left - links



PE  
arrière  
rear connector  
Anschlusstecker  
hinten



**166000**  
(RT 5000296591)

droit - right - rechts



**066000**  
(RT 5000296593)

droit - right - rechts

Fonctions supplémentaires  
Additional functions  
Zusatzfunktionen

**K** Catadioptré  
Reflector  
Rückstrahler

**EPP** Eclaireur de plaque  
Number plate lamp  
Kennzeichenleuchte

# RENAULT TRUCKS

62

# RENAULT TRUCKS

63

## GAMME G

**LC7**

p 153



1986 ->



**PE**  
arrière  
rear connector  
Anschlusstecker  
hinten



**167001**

**EPP** (RT 5000296592)

gauche - left - links



**167001**

(RT 5000296592) **EPP**

droit - right - rechts



**067000**

(RT 5000296594)

gauche - left - links



**067000**

(RT 5000296594)

droit - right - rechts

**LC4**

p 158



**PE**  
arrière  
rear connector  
Anschlusstecker  
hinten



**141110**

**EPP** (RT 5000815760)

gauche - left - links



**141310**

(RT 5000815761) **EPP**

droit - right - rechts



**040000**

(RT 5000807304)

gauche - left - links



**040000**

(RT 5000807304)

droit - right - rechts

Fonctions supplémentaires  
Additional functions  
Zusatzfunktionen

**EPP**

Eclaireur de plaque  
Number plate lamp  
Kennzeichenleuchte

## GAMME J

### FE81 *p 185-204*



**181050**  
(RT 5000461059)



**181000**  
(RT 5000461058)

### FE88 *p 184-203*



**178340**  
(RT 5010040505)



**087040**  
(RT 5000808095)

Cabocho - Lens - Lichtscheibe



**188310**  
(RT 5000623050)



**088010**  
(RT 5000296718)

Cabocho - Lens - Lichtscheibe

### FPL93 *p 201*



**193020**  
(RT 5010306792)



**001726**  
(RT 5001847589)

### C179 *p 180*

-> 1994



**117910**  
(RT 5000459967)

gauche - left - links



**117920**  
(RT 5000459966)

droit - right - rechts

# RENAULT TRUCKS



## GAMME J

**C166**

*p 171*



**PF**  
arrière  
rear connector  
Anschlusstecker  
hinten



**116600**

(RT 0027567009)

gauche - left - links



**116600**

(RT 0027567009)

droit - right - rechts



**016600**

(RT 003603705)

gauche - left - links

Cabochoon - Lens - Lichtscheibe



**016600**

(RT 003603705)

droit - right - rechts

Cabochoon - Lens - Lichtscheibe

**LA35**

*p 165*



**PF**  
arrière  
rear connector  
Anschlusstecker  
hinten



**135200**

(RT 5000589493)

gauche - left - links

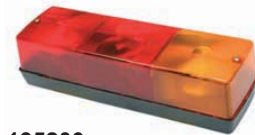

**135200**

(RT 5000589493)

droit - right - rechts



**035000**

(RT 5000803784)

gauche - left - links

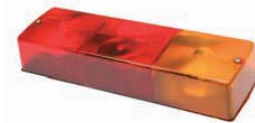

**035000**

(RT 5000803784)

droit - right - rechts

65

# RENAULT TRUCKS

## GAMME R

**C177**

p 180



**117700**  
(RT 5010231061)

gauche - left - links



**117700**  
(RT 5010231061)

droit - right - rechts

**FG82**

p 194



**182020**  
(RT 5000789306)

gauche - left - links



**182020**  
(RT 5000789306)

droit - right - rechts

**LC4**

p 157



**PE**  
arrière  
rear connector  
Anschlussstecker  
hinten

> 1994



**141000**  
(RT 5000808171)

EPP

gauche - left - links



**141000**  
(RT 5000808171)

EPP

droit - right - rechts



**141110**  
(RT 5000815760)

EPP

gauche - left - links



**141310**  
(RT 5000815761)

EPP

droit - right - rechts



**040000**  
(RT 5000807304)

gauche - left - links



**040000**  
(RT 5000807304)

droit - right - rechts

Fonctions supplémentaires  
Additional functions  
Zusatzfunktionen

EPP

**Eclaireur de plaque**  
Number plate lamp  
Kennzeichenleuchte

66

## GAMME R

LC7

p 153

1994 ->



PE  
arrière  
rear connector  
Anschlusstecker  
hinten



**167100\***

**EPP** (RT 5000296592)

gauche - left - links



**167000\***

(RT 5000296592)

droit - right - rechts



**067000**

(RT 5000296594)

gauche - left - links



**067000**

(RT 5000296594)

droit - right - rechts



**168220**

**K FPL EPP** (RT 5001831194)

gauche - left - links



**168260**

(RT 5001832999)

**K FPL**

droit - right - rechts



**067500**

**K** (RT 5001847588)

gauche - left - links



**067500**

(RT 5001847588)

**K**

droit - right - rechts

\* Cales non fournies, voir ref. 001656 p.154

\*Brocks not supplied, see p/n 001656 p.154

\*Distanzstücke Art.-Nr. 001656 nicht im Lieferumfang, s Seite 154

FPL93

p 201

Fonctions supplémentaires  
Additional functions  
Zusatzfunktionen

**K** Catadioptr  
Reflector  
Rückstrahler

**FPL** Feu de position latéral  
Side marker lamp  
Seitenmarkierungsleuchte

**EPP** Eclaireur de plaque  
Number plate lamp  
Kennzeichenleuchte



**193020**

(RT 5010306792)



**001726**

(RT 5001847589)

## GAMME S

**3113**

p 182



**31130701**  
(RT 5000360941)

gauche - left - links



**31130801**  
(RT 5000360942)

droit - right - rechts

**FE88**

p 184-203



**178340**  
(RT 5010040505)



**087040**  
(RT 5000808095)

Cabocho - Lens - Lichtscheibe



**188310**  
(RT 5000623050)



**088010**  
(RT 5000296718)

Cabocho - Lens - Lichtscheibe

**LA25**

p 167



> 06 / 1993

**PE**  
arrière  
rear connector  
Anschlussstecker  
hinten



**125430**  
**K** (RT 5000623398)

gauche - left - links



**125430**  
(RT 5000623398) **K**

droit - right - rechts



**025210**  
**K** (RT 5000810542)

gauche - left - links



**025210**  
(RT 5000810542) **K**

droit - right - rechts

Fonctions supplémentaires  
Additional functions  
Zusatzfunktionen

**K** Catadioptré  
Reflector  
Rückstrahler

# RENAULT TRUCKS

68

## GAMME S

**LC4**

p 157

-> 06 / 1993



gauche - left - links



**PE**  
arrière  
rear connector  
Anschlusstecker  
hinten



droit - right - rechts

**LA25**

p 167



gauche - left - links



**PE**  
arrière  
rear connector  
Anschlusstecker  
hinten



droit - right - rechts



gauche - left - links



droit - right - rechts

**LC4**

p 158



gauche - left - links



**PE**  
arrière  
rear connector  
Anschlusstecker  
hinten



droit - right - rechts



gauche - left - links



droit - right - rechts

Fonctions supplémentaires  
Additional functions  
Zusatzfunktionen

**EPP**

Eclaireur de plaque  
Number plate lamp  
Kennzeichenleuchte

## 4 x 4 ANIBAL

LC5

p 150



2002 ->



**152180**

(SANTANA 791123)

K

gauche - left - links

AMP 1.5  
arrière  
rear connector  
Anschlusstecker  
hinten



**152180**

(SANTANA 791123)

K

droit - right - rechts



**052500**

(SANTANA A610067-002)

K

gauche - left - links



**052500**

(SANTANA A610067-002)

K

droit - right - rechts

# SANTANA

70

Fonctions supplémentaires  
Additional functions  
Zusatzfunktionen

Catadioptr  
Reflector  
Rückstrahler

K



SCANIA

SERIE 3

LC7

p 153

1990 -> 1998



**168350**  
(SCANIA 1365963)

gauche - left - links



**168360**  
(SCANIA 1365964)

droit - right - rechts



**168370**  
(SCANIA 1365965)

gauche - left - links



**168380**  
(SCANIA 1365966)

droit - right - rechts



**067500**  
(SCANIA 1350343)

gauche - left - links



**067500**  
(SCANIA 1350343)

droit - right - rechts

SERIE P&R

LC8

p 146

01/2007 ->



AMP 1.5  
latéral  
side connector  
Anschlusstecker  
seitlich



**156770**  
(SCANIA 1756754/2021579)

gauche - left - links



**156780**  
(SCANIA 1756751/2021575)

droit - right - rechts



Fonctions supplémentaires  
Additional functions  
Zusatzfunktionen

**K**  
Catadioptr  
Reflector  
Rückstrahler

**FPL**  
Feu de position latéral  
Side marker lamp  
Seitenmarkierungsleuchte

**EPP**  
Eclaireur de plaque  
Number plate lamp  
Kennzeichenleuchte

**ASR**  
Alarme sonore de recul  
Back up alarm  
Rückfahrhorn



**155020**  
(SCANIA 2021578)

gauche - left - links



**156790**  
(SCANIA 1791369/2021576)

droit - right - rechts



**056540**  
(SCANIA 1784669)

gauche - left - links



**056550**  
(SCANIA 1784670)

droit - right - rechts

## CRAFTER

LC8

p 146



-06/2006 ->



**156340**

(VW 2E0945095A)

**K** **FPL** **EPP**

gauche - left - links

AMP 1.5  
arrière  
rear connector  
Anschlusstecker  
hinten



**156350**

(VW 2E0945096A)

**K** **FPL**

droit - right - rechts



**056540**

(VW 2E0945111A)

**K**

gauche - left - links



**056550**

(VW 2E0945112A)

**K**

droit - right - rechts

VOLKSWAGEN

72

Fonctions supplémentaires  
Additional functions  
Zusatzfunktionen

**K** Catadioptré  
Reflector  
Rückstrahler

**FPL** Feu de position latéral  
Side marker lamp  
Seitenmarkierungsleuchte

**EPP** Eclaireur de plaque  
Number plate lamp  
Kennzeichenleuchte

**VOLVO**

**FH - FM**

**SRD07** p 183

*FH 08/2008 ->  
FM 09/2010 ->*



**107000**  
LEDS 24V (VOLVO 82114506)

gauche - left - links



**107010**  
(VOLVO 82114500) LEDS 24V

droit - right - rechts



**107040**  
(VOLVO 82114504)

coque - cowl - schale  
gauche - left - links



**107050**  
(VOLVO 82114502)

coque - cowl - schale  
droit - right - rechts



73

**FE07** p 188

*08/2008 ->*



**207000**  
LEDS 24V (VOLVO 82116545)



**207010**  
(VOLVO 21087346) LEDS 24V



**207020**  
LEDS 24V (VOLVO 21087347)

## FL - FH - FM

**SMD00**

p 197

-2001 ->



Adaptateur - Adaptor - Adapterkabel

**VOLVO**

## FE

**LC9**

p 144

-2006 ->



**AMP 1.5**  
latéral  
side connector  
Anschlussstecker  
seitlich



**K** **FPL** **EPP**

gauche - left - links



**K** **FPL**

droit - right - rechts



**K** **FPL** **ASR**

droit - right - rechts



**K**

gauche - left - links



**K**

droit - right - rechts

Fonctions supplémentaires  
Additional functions  
Zusatzfunktionen

**K**  
Catadioptr  
Reflector  
Rückstrahler

**FPL**  
Feu de position latéral  
Side marker lamp  
Seitenmarkierungsleuchte

**EPP**  
Eclaireur de plaque  
Number plate lamp  
Kennzeichenleuchte

**ASR**  
Alarme sonore de recul  
Back up alarm  
Rückfahrhorn

74

**VOLVO**

**FL - FE**

**LC5**

p 150



2006 ->



**152190**

**EPP** (VOLVO 20769783)

gauche - left - links

AMP 1.5  
arrière  
rear connector  
Anschlusstecker  
hinten



**152200**

(VOLVO 20769784)

droit - right - rechts



**152880**

**K** (VOLVO 20769781)

gauche - left - links



**152880**

(VOLVO 20769782) **K**

droit - right - rechts



**052000**

(VOLVO 20537280)

gauche - left - links



**052000**

(VOLVO 20537280)

droit - right - rechts



**052500**

**K** (VOLVO 20745060)

gauche - left - links

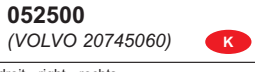

**052500**

(VOLVO 20745060) **K**

droit - right - rechts

**FE95**

p 195



**195010**

(VOLVO 20745225)

gauche - left - links



**195010**

(VOLVO 20745225)

droit - right - rechts

Fonctions supplémentaires  
Additional functions  
Zusatzfunktionen

**K** Catadioptré  
Reflector  
Rückstrahler

**EPP** Eclairer de plaque  
Number plate lamp  
Kennzeichenleuchte



**ORIGINAL QUALITY PARTS**

75

## FL - FE

**ICDL94** p 184



**119550**  
(VOLVO 20733983)



**001616**  
(VOLVO 20745066)

**VOLVO**

## FL

**FE02** p 191

-2006 ->

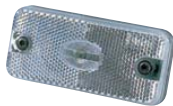

**102200** **001726**



Clippé - Clipped - Befestigung

76

**FPL93** p 201



**193020** **001726**  
(VOLVO 20734485)



**EPP98** p 177



**196010**  
(VOLVO 1374260)



**VOLVO**

**BUS - COACH**

**SMD98** p 198

-----> 2003



## 1

**Produits d'origine constructeurs - OE spare parts per manufacturer****Originalersatzteile nach Fahrzeughersteller / Fahrzeugtyp****1.1 Camions / Cars et bus - Trucks / Coaches - LKW / Busse**

DAF .....	p.07
ERF .....	p.12
FODEN .....	p.13
HEULIEZ .....	p.14
IRISBUS .....	p.16
IVECO .....	p.23
MAN .....	p.29
MANITOU .....	p.32
MERCEDES .....	p.33
NISSAN .....	p.34
RENAULT AGRI .....	p.35
RENAULT TRUCKS .....	p.36
SANTANA .....	p.70
SCANIA .....	p.71
VOLKSWAGEN .....	p.72
VOLVO .....	p.73

**1.2 Remorques - Trailers - Anhänger / Auflieger**

ASCA .....	p.79
BENALU .....	p.85
BFG .....	p.88
CHEREAU .....	p.90
CODER .....	p.94
DOLL .....	p.96
ECOVAC .....	p.97
FELDBINDER .....	p.99
FLIEGL .....	p.101
FRUEHAUF .....	p.102
GUILLEN .....	p.104
INVEPE .....	p.105
KEMPF .....	p.106
LAMBERET .....	p.107
LECINENA .....	p.112
MAGYAR .....	p.114
MAISONNEUVE .....	p.116
MENCI .....	p.118
MONTENEGRO .....	p.119
NETAM FRUEHAUF .....	p.120
OMEF .....	p.122
PACTON .....	p.123
SAMRO .....	p.125
SCHWARZMUELLER .....	p.129
SOMMER .....	p.130
TABARRINI .....	p.132
TEKNOCAR .....	p.134
TITAN / KAISER BTK .....	p.135

ASCA

ASCA

LC8TLED p 142



AMP 1.5  
arrière  
rear connector  
Anschlusstecker  
hinten



T FPL 157040

gauche - left - links



157050 T FPL

droit - right - rechts



057000

gauche - left - links



057000

droit - right - rechts



D13234

gauche - left - links

LC8T p 147



AMP 1.5  
arrière  
rear connector  
Anschlusstecker  
hinten



Faisceau p. 249  
Harness p. 249  
Anschlusskabel siehe S. 249



T FPL 156040

gauche - left - links



156050 T FPL

droit - right - rechts



T FPL EPP 156060

gauche - left - links



T 056700

gauche - left - links



T 056710

droit - right - rechts

Fonctions supplémentaires  
Additional functions  
Zusatzfunktionen

T Catadioptré triangulaire  
Triangular reflector  
Dreieckrückstrahler

FPL Feu de position latéral  
Side marker lamp  
Seitenmarkierungsleuchte

EPP Eclairer de plaque  
Number plate lamp  
Kennzeichenleuchte

79

## ASCA

### LC5TDX p 152



AMP 1.5  
arrière  
rear connector  
Anschlusstecker  
hinten



**T** 153660

gauche - left - links



153670 **T**

droit - right - rechts



**T** 053700

gauche - left - links



053710 **T**

droit - right - rechts

### LC5 p 150



AMP 1.5  
arrière  
rear connector  
Anschlusstecker  
hinten



152200

gauche - left - links



152200

droit - right - rechts



**EPP** 152190

gauche - left - links



052000

gauche - left - links



052000

droit - right - rechts

# ASCA

80



Faisceau p. 249  
Harness p. 249  
Anschlusskabel siehe S. 249

Fonctions supplémentaires  
Additional functions  
Zusatzfunktionen

**T**

Catadioptré triangulaire  
Triangular reflector  
Dreieckrückstrahler

# ASCA

## ASCA

### LC4 *p 157*



PE  
arrière  
rear connector  
Anschlusstecker  
hinten



**141000**

gauche - left - links



**141000**

droit - right - rechts



**040000**

gauche - left - links



**040000**

droit - right - rechts

### FE04 *p 187*



LEDS-24V

<b>104310</b>	5000 mm
---------------	---------



LEDS-24V

<b>D10132</b>	200 mm
---------------	--------



Faisceau p. 249  
Harness p. 249  
Anschlusskabel siehe S. 249

### SMD04 *p 188*



LEDS-24V

<b>104140</b>	1500 mm
---------------	---------

**K**

Fonctions supplémentaires  
Additional functions  
Zusatzfunktionen

**K** Catadioptré  
Reflector  
Rückstrahler

# ASCA

# ASCA

## SMD98 p 189

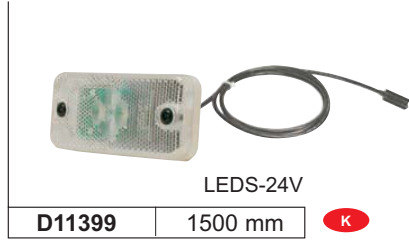

## FE94 p 190



## SMD04 p 197



Faisceau p. 249  
 Harness p. 249  
 Anschlusskabel siehe S. 249

## SMD98 p 198

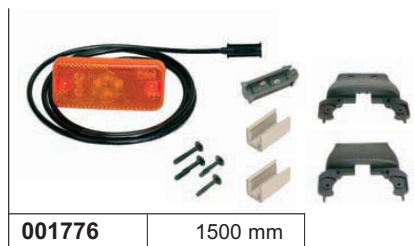

Fonctions supplémentaires  
 Additional functions  
 Zusatzfunktionen

**K** Catadioptr  
 Reflector  
 Rückstrahler

82



# ASCA

## ASCA

### FE94 p 199



### DXLC8 p 205



### D429 p 206



### EPP96 p 177



Faisceau p. 249  
Harness p. 249  
Anschlusskabel siehe S. 249

Fonctions supplémentaires  
Additional functions  
Zusatzfunktionen

**K** Catadioptr  
Reflector  
Rückstrahler

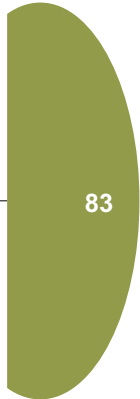

83

## ASCA

# ASCA

**FDT**

p 221

**NEW**



**D12390\***

feu de recul  
Reverse lamp  
Rückfahrleuchte

**CT**

p 214



**623016**

**MDJ**

p 251



**175020**

84

\*Lampe fournie  
\*Bulb included  
\*Inklusiv Glühlampen

# BENALU

## BENALU

### LC8T *p 147*



AMP 1.5  
arrière  
rear connector  
Anschlusstecker  
hinten



**T** **FPL** **156040**

gauche - left - links



**156050** **T** **FPL**

droit - right - rechts



**001830**

Alarme sonore de recul - Back-up alarm - Rückfahrwarner



**T** **056700**

gauche - left - links



**056710** **T**

droit - right - rechts

### SMD98 *p 189*



Faisceau p. 249  
Harness p. 249  
Anschlusskabel siehe S. 249



<b>D10500</b>	500 mm
<b>D11399</b>	1500 mm



**001716**

### FE94 *p 190*

Fonctions supplémentaires  
Additional functions  
Zusatzfunktionen

**T** **Catadioptré triangulaire**  
Triangular reflector  
Dreieckrückstrahler

**FPL** **Feu de position latéral**  
Side marker lamp  
Seitenmarkierungsleuchte



**194130**



**194150**

## BENALU

### SMD04 p 197



LEDS-24V **K**

104250	500 mm
104260	1500 mm

### SMD98 p 198



LEDS-24V **K**

D10494	500 mm
D10497	1500 mm

### DXLC8 p 205



D13034

gauche - left - links



D13035

droit - right - rechts

### D429 p 206



D10503	660 mm
D11796	1500 mm



610080

Fonctions supplémentaires  
Additional functions  
Zusatzfunktionen

**K** Catadioptré  
Reflector  
Rückstrahler

# BENALU

# BENALU

## BENALU

### EPP96 *p 177*



D10502	410 mm
D11888	1000 mm

### MDJ *p 251*



175020

87



Faisceau p. 249  
Harness p. 249  
Anschlusskabel siehe S. 249

## BFG

**LC8T**

p 147

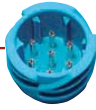

AMP 1.5  
arrière  
connettore posteriore  
conector trasero



**T** **FPL** **156040**

gauche - sinistra - izquierda



**T** **FPL** **156050**

droit - destra - derecha



**T** **056700**

gauche - sinistra - izquierda



**T** **056710**

droit - destra - derecha

**SMD04**

p 188



LEDS-24V **K**

<b>104140</b>	1500 mm
---------------	---------

**SMD04**

p 197



LEDS-24V **K**

<b>104260</b>	1500 mm
---------------	---------

# BFG

88



Faisceau p. 249  
Harness p. 249  
Anschlusskabel siehe S. 249

Fonctions supplémentaires  
Funzioni supplementari  
Funciones adicionales

**T** Catadioptré triangulaire  
Triangolo catarifrangente  
Catadióptrico triangular

**FPL** Feu de position latéral  
Luce di posizione laterale  
Piloto de posición lateral

**K** Catadioptré  
Reflector  
Rückstrahler



**BFG**

**BFG**

**FE88** p 203



188110

C5W

**EPP96** p 177



D11888

1000 mm

89



Faisceau p. 249  
Harness p. 249  
Anschlusskabel siehe S. 249

# CHEREAU

LC8T

p 147



AMP 1.5  
arrière  
rear connector  
Anschlusstecker  
hinten



**T** **FPL** **156040**

gauche - left - links



**156050** **T** **FPL**

droit - right - rechts



**T** **FPL** **EPP** **156060**

gauche - left - links



**156070** **T** **FPL** **EPP**

droit - right - rechts



**T** **056700**

gauche - left - links



**056710** **T**

droit - right - rechts



**FPL** **156550**

gauche - left - links



**156540** **FPL**

droit - right - rechts



**056000**

gauche - left - links

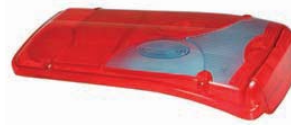

**056010**

droit - right - rechts



**001846**

Fonctions supplémentaires  
Additional functions  
Zusatzfunktionen

**T** **Catadioptré triangulaire**  
Triangular reflector  
Dreieckrückstrahler

**FPL** **Feu de position latéral**  
Side marker lamp  
Seitenmarkierungsleuchte

**EPP** **Eclaireur de plaque**  
Number plate lamp  
Kennzeichenleuchte

# CHEREAU

90



Faisceau p. 249  
Harness p. 249  
Anschlusskabel siehe S. 249

# CHEREAU

## CHEREAU

### LC7T p 155



PE  
arrière  
rear connector  
Anschlusstecker  
hinten



**T** **FPL** **168770**

gauche - left - links



**168790** **T** **FPL**

droit - right - rechts



**T** **067610**

gauche - left - links



**067600** **T**

droit - right - rechts



**K** **FPL** **168270**

gauche - left - links



**168270** **K** **FPL**

droit - right - rechts



**K** **067500**

gauche - left - links



**067500** **K**

droit - right - rechts

91



Faisceau p. 249  
Harness p. 249  
Anschlusskabel siehe S. 249

### EPP96 p 177

Fonctions supplémentaires  
Funzioni supplementari  
Funciones adicionales

**T** **Catadioptré triangulaire**  
**Triangolo catarifrangente**  
**Catadióptrico triangular**

**FPL** **Feu de position latéral**  
**Luce di posizione laterale**  
**Piloto de posición lateral**

**K** **Catadioptré**  
**Reflector**  
**Rückstrahler**



**196020**

R10W

## CHEREAU

**D429**

p 206



**D10642**



**610080**



**D11797**

3000 mm

Pour module de jonction ref. 175020 p.251  
For junction box ref.175020 p.251  
für Verteilerdose Art.-Nr. 175020 s. Seite 251



**D11899**

500 mm

Pour repiquage sur feu arrière LC8 p.147  
To plug in LC8 rear lamp p.147  
Zum direkten Anschluss an die Heckleuchte LC8 s. Seite 147

**MDJ**

p 251



**175020**



Faisceau p. 249  
Harness p. 249  
Anschlusskabel siehe S. 249

**7P**

p 245



**611520**

24N



**611540**

24S

92

# CHEREAU

## CHEREAU

**15P**

p 245



**A10060**

**FCA**

p 253

AMP 1.5 Ø 32

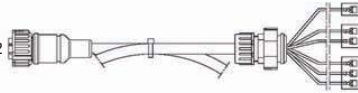

Pour - For - Für  
MDJ 175020 p.251

<b>D11626</b>	2500 mm
<b>D11627</b>	4300 mm

AMP 1.5 Ø 32

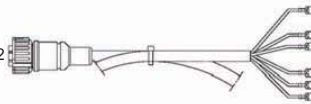

Pour - For - Für  
MDJ 175020 p.251

<b>D11628</b>	2500 mm
---------------	---------

**FCA**

p 254

AMP 1.5 Ø 24

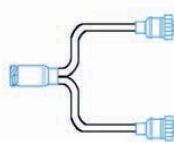

AMP 1.5 Ø 32

AMP 1.5 Ø 32

<b>D11689</b>	500 mm
---------------	--------

Faisceau doubleur de feu.  
Compatible avec feux arrière  
VIGNAL Systems avec connecteur  
AMP 1.5

Cable for double rear lamps.  
Compatible with all VIGNAL  
Systems rear lamps with AMP 1.5

Kabel für den Anschluss von zwei  
VIGNAL Heckleuchten je Seite mit  
Anschlussstecker AMP 1.5

93



Faisceau p. 249  
Harness p. 249  
Anschlusskabel siehe S. 249

## CODER

### LC8T *p 147*



AMP 1.5  
arrière  
rear connector  
Anschlusstecker  
hinten



**T** **FPL** **156040**

gauche - left - links



**T** **FPL** **156050**

droit - right - rechts



**T** **056700**

gauche - left - links



**T** **056710**

droit - right - rechts

### SMD98 *p 198*



<b>D10494</b>	500 mm
<b>D10497</b>	1500 mm

### FE94 *p 190*



**194130**



Faisceau p. 249  
Harness p. 249  
Anschlusskabel siehe S. 249

### D429 *p 206*



**D10503** 660 mm



**610080**

Fonctions supplémentaires  
Additional functions  
Zusatzfunktionen

- T** Catadioptré triangulaire  
Triangular reflector  
Dreieckrückstrahler
- FPL** Feu de position latéral  
Side marker lamp  
Seitenmarkierungsleuchte

CODER



CODER

CODER

EPP96 p 177



D10502	410 mm
--------	--------

7P-15P p 247



611410

95



Faisceau p. 249  
Harness p. 249  
Anschlusskabel siehe S. 249

## DOLL

### LC7T

p 155



PE  
arrière  
rear connector  
Anschlusstecker  
hinten



**T** **FPL** **168770**

gauche - left - links



**168790** **T** **FPL**

droit - right - rechts



**T** **067610**

gauche - left - links



**067600** **T**

droit - right - rechts

### FE94

p 190



**194130**

T4W

**K**



**094036**

**K**

### FE94

p 199



**194030**

T4W

**K**



**094016**

**K**

### MDJ

p 251



**175020**

Fonctions supplémentaires  
Additional functions  
Zusatzfunktionen

**K**

Catadioptr  
Reflector  
Rückstrahler

**FPL**

Feu de position latéral  
Side marker lamp  
Seitenmarkierungsleuchte

**T**

Catadioptr triangulaire  
Triangular reflector  
Dreieckrückstrahler

# DOLL

96



Faisceau p. 249  
Harness p. 249  
Anschlusskabel siehe S. 249

# ECOVTRAC

## ECOVTRAC

### LC8T *p 147*



AMP 1.5  
arrière  
rear connector  
Anschlusstecker  
hinten



**T** **FPL** **EPP** **156040**

gauche - left - links



**156050** **T** **FPL** **EPP**

droit - right - rechts



**T** **056700**

gauche - left - links



**056710** **T**

droit - right - rechts

### LC7T *p 155*



PE  
arrière  
rear connector  
Anschlusstecker  
hinten



**T** **FPL** **168770**

gauche - left - links



**168790** **T** **FPL**

droit - right - rechts



**T** **067610**

gauche - left - links



**067600** **T**

droit - right - rechts



Faisceau p. 249  
Harness p. 249  
Anschlusskabel siehe S. 249

Fonctions supplémentaires  
Additional functions  
Zusatzfunktionen

- K** Catadioptré  
Reflector  
Rückstrahler
- FPL** Feu de position latéral  
Side marker lamp  
Seitenmarkierungsleuchte
- EPP** Eclaireur de plaque  
Number plate lamp  
Kennzeichenleuchte
- T** Catadioptré triangulaire  
Triangular reflector  
Dreieckrückstrahler

### SMD98 *p 189*



**198660** **LEDS-24V** **K**

# ECOVAC

# ECOVAC

## SMD98 p 198



198520 LEDS-24V



## FE94 p 190



194130 T4W



094036



## DXLC8 p 205



D12712

gauche - left - links



D12711

droit - right - rechts



Faisceau p. 249  
Harness p. 249  
Anschlusskabel siehe S. 249

## EPP96 p 177



196020 R10W



D10502 410 mm

Fonctions supplémentaires  
Additional functions  
Zusatzfunktionen

**K**  
Catadioptr  
Reflector  
Rückstrahler

# FELDBINDER

## FELDBINDER

**LC8T** p 147



AMP 1.5  
arrière  
rear connector  
Anschlussstecker  
hinten



**T** **FPL** **156250**

gauche - left - links



**156260** **T** **FPL**

droit - right - rechts



**T** **056720**

gauche - left - links



**056730** **T**

droit - right - rechts

**SMD98** p 189



LEDS-24V

<b>D10500</b>	500 mm
<b>D10399</b>	1500 mm

**K**

**SMD98** p 198



LEDS-24V

<b>D10497</b>	1500 mm
---------------	---------

**K**



Faisceau p. 249  
Harness p. 249  
Anschlusskabel siehe S. 249

Fonctions supplémentaires  
Additional functions  
Zusatzfunktionen

**K** Catadioptr  
Reflector  
Rückstrahler

**FPL** Feu de position latéral  
Side marker lamp  
Seitenmarkierungsleuchte

**T** Catadioptr triangulaire  
Triangular reflector  
Dreieckrückstrahler

## FELDBINDER

**D429**

p 206



**EPP96**

p 177



# FELDBINDER

100



Faisceau p. 249  
Harness p. 249  
Anschlusskabel siehe S. 249



**FLIEGL**

**FLIEGL**

**LC7T** p 155



**PE**  
arrière  
rear connector  
Anschlusstecker  
hinten



**168770** T FPL

gauche - left - links



**168790** T FPL

droit - right - rechts



**067610** T

gauche - left - links



**067600** T

droit - right - rechts

**SMD98** p 198



**198540** 2 x LEDS-24V K

**EPP96** p 177



**196020** R10W

**MDJ** p 251



**175020**



Faisceau p. 249  
Harness p. 249  
Anschlusskabel siehe S. 249

Fonctions supplémentaires  
Additional functions  
Zusatzfunktionen

- K** Catadioptr  
Reflector  
Rückstrahler
- FPL** Feu de position latéral  
Side marker lamp  
Seitenmarkierungsleuchte
- T** Catadioptr triangulaire  
Triangular reflector  
Dreieckrückstrahler

## FRUEHAUF

LC8T

p 147



AMP 1.5  
arrière  
rear connector  
Anschlusstecker  
hinten



T FPL EPP 156060

gauche - left - links



156070 T FPL EPP

droit - right - rechts



001830

Alarme sonore de recul - Back-up alarm - Rückfahrwarner



T 056700

gauche - left - links



056710 T

droit - right - rechts

DXLC8

p 205



NEW

D13034

gauche - left - links



NEW

D13035

droit - right - rechts



Faisceau p. 249  
Harness p. 249  
Anschlusskabel siehe S. 249

SMD98

p 189



LED-24V

D10500	500 mm
D10399	1500 mm

K

Fonctions supplémentaires  
Additional functions  
Zusatzfunktionen

K Catadioptre  
Reflector  
Rückstrahler

FPL Feu de position latéral  
Side marker lamp  
Seitenmarkierungsleuchte

EPP Eclaireur de plaque  
Number plate lamp  
Kennzeichenleuchte

T Catadioptre triangulaire  
Triangular reflector  
Dreieckrückstrahler

FRUEHAUF

102

# FRUEHAUF

## FRUEHAUF

### FE94 *p 190*



### SMD04 *p 197*

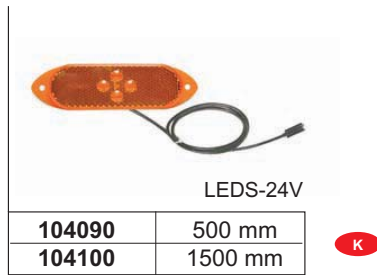

### FE94 *p 199*



Faisceau p. 249  
 Harness p. 249  
 Anschlusskabel siehe S. 249

### EPP96 *p 177*



Fonctions supplémentaires  
 Additional functions  
 Zusatzfunktionen

**K** Catadioptré  
 Reflector  
 Rückstrahler

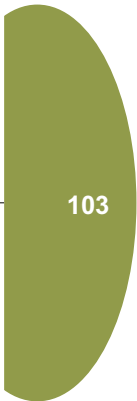

## GUILLEN

**LC8T**

p 147



AMP 1.5  
arrière  
rear connector  
Anschlusstecker  
hinten



**T** **FPL** **EPP** **156060**

gauche - left - links



**156070** **T** **FPL** **EPP**

droit - right - rechts



**T** **056700**

gauche - left - links



**056710** **T**

droit - right - rechts

**GUILLEN**

**SMD04**

p 188



**104130** 500 mm **K**

**SMD04**

p 197



**104260** 1500 mm **K**



Faisceau p. 249  
Harness p. 249  
Anschlusskabel siehe S. 249

Fonctions supplémentaires  
Additional functions  
Zusatzfunktionen

**K** **Catadioptre**  
**Reflector**  
**Rückstrahler**

**FPL** **Feu de position latéral**  
**Side marker lamp**  
**Seitenmarkierungsleuchte**

**EPP** **Eclaireur de plaque**  
**Number plate lamp**  
**Kennzeichenleuchte**

**T** **Catadioptre triangulaire**  
**Triangular reflector**  
**Dreieckrückstrahler**

104

**INVEPE**

**INVEPE**

**LC8T** p 147



AMP 1.5  
arrière  
rear connector  
Anschlusstecker  
hinten



**T FPL EPP 156060**

gauche - left - links



**156070 T FPL EPP**

droit - right - rechts



**T 056700**

gauche - left - links



**056710 T**

droit - right - rechts

**FE94** p 190



**194130 T4W K**



**094036 K**



Faisceau p. 249  
Harness p. 249  
Anschlusskabel siehe S. 249

Fonctions supplémentaires  
Additional functions  
Zusatzfunktionen

**K** Catadioptr  
Reflector  
Rückstrahler

**FPL** Feu de position latéral  
Side marker lamp  
Seitenmarkierungsleuchte

**EPP** Eclairer de plaque  
Number plate lamp  
Kennzeichenleuchte

**T** Catadioptr triangulaire  
Triangular reflector  
Dreieckrückstrahler

**FE94** p 199



**194030 T4W K**



**094016 K**

**EPP96** p 177



**196020 R10W**

## KEMPF

LC7

p 153



PE  
arrière  
rear connector  
Anschlusstecker  
hinten



**K** **FPL** **168270**

gauche - left - links



**168270** **K** **FPL**

droit - right - rechts



**K** **067500**

gauche - left - links



**067500** **K**

droit - right - rechts

FE94

p 199



**194030** T4W **K**



**094016** **K**

106



Faisceau p. 249  
Harness p. 249  
Anschlusskabel siehe S. 249

Fonctions supplémentaires  
Additional functions  
Zusatzfunktionen

**K** **Catadioptr**  
**Reflector**  
**Rückstrahler**

**FPL** **Feu de position latéral**  
**Side marker lamp**  
**Seitenmarkierungsleuchte**



LAMBERET

LAMBERET

LC8T p 147



T FPL 156040

gauche - left - links



T 056700

gauche - left - links

AMP 1.5  
arrière  
rear connector  
Anschlusstecker  
hinten



156050 T FPL

droit - right - recht



056710 T

droit - right - recht

LC8 p 145



K FPL 156310

gauche - left - links



K 056500

gauche - left - links

AMP 1.5  
arrière  
rear connector  
Anschlusstecker  
hinten



156300 K FPL

droit - right - recht



056510 K

droit - right - recht

107



Faisceau p. 249  
Harness p. 249  
Anschlusskabel siehe S. 249

Fonctions supplémentaires  
Additional functions  
Zusatzfunktionen

- K** Catadioptr  
Reflector  
Rückstrahler
- FPL** Feu de position latéral  
Side marker lamp  
Seitenmarkierungsleuchte
- T** Catadioptr triangulaire  
Triangular reflector  
Dreieckrückstrahler

## LAMBERET

### LC5T

p 151



AMP 1.5  
arrière  
rear connector  
stecker hinten



**T** 153000

gauche - left - links



153010 **T**

droit - right - rechts



**T** 053700

gauche - left - links



053710 **T**

droit - right - rechts

### LC5

p 150



AMP 1.5  
arrière  
rear connector  
Anschlusstecker  
hinten



152200

gauche - left - links



152200

droit - right - rechts



052000

gauche - left - links



052000

droit - right - rechts

### EPP96

p 177



196020

# LAMBERET

108



Faisceau p. 249  
Harness p. 249  
Anschlusskabel siehe S. 249

Fonctions supplémentaires  
Additional functions  
Zusatzfunktionen

**T** Catadioptré triangulaire  
Triangular reflector  
Dreieckrückstrahler

**FPL** Feu de position latéral  
Side marker lamp  
Seitenmarkierungsleuchte

LAMBERET

LAMBERET

LC7T p 155



PE  
arrière  
rear connector  
Anschlusstecker  
hinten



T FPL 168770

gauche - left - links



168790 T FPL

droit - right - rechts



T FPL EPP 168780

gauche - left - links



T 067610

gauche - left - links



067600 T

droit - right - rechts

LC7 p 153



PE  
arrière  
rear connector  
Anschlusstecker  
hinten



K FPL 168270

gauche - left - links



168270 K FPL

droit - right - rechts



K 067500

gauche - left - links



067500 K

droit - right - rechts



Faisceau p. 249  
Harness p. 249  
Anschlusskabel siehe S. 249

Fonctions supplémentaires  
Additional functions  
Zusatzfunktionen

**K** Catadioptr  
Reflector  
Rückstrahler

**FPL** Feu de position latéral  
Side marker lamp  
Seitenmarkierungsleuchte

**EPP** Eclairer de plaque  
Number plate lamp  
Kennzeichenleuchte

**T** Catadioptr triangulaire  
Triangular reflector  
Dreieckrückstrahler

109

## LAMBERET

# LAMBERET

### SMD04 p 188



LEDS-24V

104130	500 mm	<b>K</b>
--------	--------	----------

### SMD04 p 197



LEDS-24V

104100	1500 mm	<b>K</b>
--------	---------	----------

### SMD98 p 198



198520	4 x LEDS-24V	<b>K</b>
--------	--------------	----------



198540	2 x LEDS-24V	<b>K</b>
--------	--------------	----------

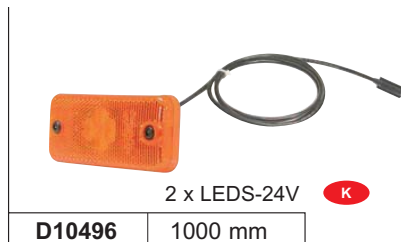

2 x LEDS-24V **K**

D10496	1000 mm
--------	---------



2 x LEDS-24V **K**

D10497	1500 mm
--------	---------



Faisceau p. 249  
 Harness p. 249  
 Anschlusskabel siehe S. 249

110

### DX p 205



D12428

Fonctions supplémentaires  
 Additional functions  
 Zusatzfunktionen

**K** Catadioptré  
 Reflector  
 Rückstrahler

# LAMBERET

## LAMBERET

### FE04 *p 207*



### FDT *p 221*



**D12390\***

feu de recul  
Reverse lamp  
Rückfahrleuchte

### 15P *p 245*



**A10060**



**A10061**

### 7P *p 245*



**611520**

**24N**



**611540**

**24S**

### MDJ *p 251*



**175020**

\*Lampe fournie  
\*Bulb included  
\*Inklusiv Glühlampen

## LECINENA

### LC8T *p 147*



AMP 1.5  
arrière  
rear connector  
stecker hinten



**T FPL 156250**

gauche - left - links



**T FPL EPP 156380**

gauche - left - links



**T 056720**

gauche - left - links



**156260 T FPL**

droit - right - rechts



**156390 T FPL EPP**

droit - right - rechts



**056730 T**

droit - right - rechts

### LC5T *p 151*



AMP 1.5  
arrière  
rear connector  
stecker hinten



**T 153000**

gauche - left - links



**153010 T**

droit - right - rechts



**153130 T ASR**

droit - right - rechts



**053700**

gauche - left - links



**053710**

droit - right - rechts



Faisceau p. 249  
Harness p. 249  
Anschlusskabel siehe S. 249

Fonctions supplémentaires  
Additional functions  
Zusatzfunktionen

**K** Catadioptré  
Reflector  
Rückstrahler

**FPL** Feu de position latéral  
Side marker lamp  
Seitenmarkierungsleuchte

**EPP** Eclaireur de plaque  
Number plate lamp  
Kennzeichenleuchte

**ASR** Alarme sonore de recul  
Back up alarm  
Rückfahrtsignalhorn

# LECINENA



# LECINENA

## LECINENA

### SMD04 p 188



LEDS-24V

104140	1500 mm
--------	---------

**K**

### FPL93 p 191



193200

### SMD04 p 197



LEDS-24V

104100	1500 mm
--------	---------

**K**



LEDS-24V

104250	500 mm
--------	--------

**K**



Faisceau p. 249  
 Harness p. 249  
 Anschlusskabel siehe S. 249

### SMD98 p 198



LEDS-24V

D10494	500 mm
--------	--------

**K**



LEDS-24V

001786	500 mm
--------	--------

**K**

Fonctions supplémentaires  
 Additional functions  
 Zusatzfunktionen

**K** Catadioptré  
 Reflector  
 Rückstrahler

113

## MAGYAR

**LC7T** p 155



PE  
arrière  
rear connector  
Anschlussstecker  
hinten



**T** **FPL** **168770**

gauche - left - links



**168790** **T** **FPL**

droit - right - rechts



**T** **067610**

gauche - left - links



**067600** **T**

droit - right - rechts

**FE94** p 190



**194130** T4W **K**



**094036** **K**

**FE94** p 199



**194010** T4W **K**



**094016** **K**



Faisceau p. 249  
Harness p. 249  
Anschlusskabel siehe S. 249

**D429** p 206



**D10642** R5W



R5W  
**D10503** 660 mm

Fonctions supplémentaires  
Additional functions  
Zusatzfunktionen

- K** Catadioptr  
Reflector  
Rückstrahler
- FPL** Feu de position latéral  
Side marker lamp  
Seitenmarkierungsleuchte
- T** Catadioptr triangulaire  
Triangular reflector  
Dreieckrückstrahler

MAGYAR

MAGYAR

EPP96 p 177



196020

R10W

MDJ p 251



175020

115



Faisceau p. 249  
Harness p. 249  
Anschlusskabel siehe S. 249

## MAISONNEUVE

**LC7T**

p 155



PE  
arrière  
rear connector  
Anschlusstecker  
hinten



**T** **FPL** **168770**

gauche - left - links



**168790** **T** **FPL**

droit - right - rechts



**T** **067610**

gauche - left - links



**067600** **T**

droit - right - rechts

**SMD00**

p 197



**198620** LEDS-24V **K**

**SMD98**

p 198



**198520** 4 x LEDS-24V **K**



Faisceau p. 249  
Harness p. 249  
Anschlusskabel siehe S. 249

116

Fonctions supplémentaires  
Additional functions  
Zusatzfunktionen

**K** **Catadiopre**  
**Reflector**  
**Rückstrahler**

**FPL** **Feu de position latéral**  
**Side marker lamp**  
**Seitenmarkierungsleuchte**

**T** **Catadiopre triangulaire**  
**Triangular reflector**  
**Dreieckrückstrahler**

# MAISONNEUVE

## MAISONNEUVE

**D429** p 206



**EPP96** p 177



**MDJ** p 251



Faisceau p. 249  
Harness p. 249  
Anschlusskabel siehe S. 249

## MENCI

**LC8T**

p 147



AMP 1.5  
arrière  
rear connector  
stecker hinten



**T** **FPL** **156040**

gauche - left - links



**156050** **T** **FPL**

droit - right - rechts



**T** **056700**

gauche - left - links



**T** **056710**

droit - right - rechts

**D429**

p 206



**D10642**

R5W



R5W

**D10503**

660 mm

**EPP96**

p 177



**196020**

R10W



Faisceau p. 249  
Harness p. 249  
Anschlusskabel siehe S. 249

Fonctions supplémentaires  
Additional functions  
Zusatzfunktionen

**K**

**Catadioptr**  
**Reflector**  
**Rückstrahler**

**FPL**

**Feu de position latéral**  
**Side marker lamp**  
**Seitenmarkierungsleuchte**

**T**

**Catadioptr triangulaire**  
**Triangular reflector**  
**Dreieckrückstrahler**

**MENCI**

118



# MONTENEGRO

## MONTENEGRO

### LC8T *p 147*



**T** **FPL** **EPP** **156060**

gauche - left - links

AMP 1.5  
arrière  
rear connector  
stecker hinten



**156070** **T** **FPL** **EPP**

droit - right - rechts



**T** **FPL** **EPP** **156630**

gauche - left - links

AMP 1.5  
latéral  
side connector  
Anschlusstecker  
seitlich



**156640** **T** **FPL** **EPP**

droit - right - rechts



**T** **056700**

gauche - left - linke



**056710** **T**

droit - right - recht

### SMD98 *p 198*



Faisceau p. 249  
Harness p. 249  
Anschlusskabel siehe S. 249

Fonctions supplémentaires  
Additional functions  
Zusatzfunktionen

**K** Catadioptré  
Reflector  
Rückstrahler

**FPL** Feu de position latéral  
Side marker lamp  
Seitenmarkierungsleuchte

**EPP** Eclaireur de plaque  
Number plate lamp  
Kennzeichenleuchte

**T** Catadioptré triangulaire  
Triangular reflector  
Dreieckrückstrahler



LEDS-24V **K**

**D10497** 1500 mm



LEDS-24V **K**

**001776** 1500 mm

## NETAM FRUEHAUF

**LC5**

p 150

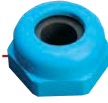

**PE**  
 arrière  
 rear connector  
 Anschlussstecker  
 hinten



**152130**

gauche - left - links



**152130**

droit - right - rechts



**052000**

gauche - left - links



**052000**

droit - right - rechts

**FE94**

p 190



**194130**

T4W



**094036**



**FE94**

p 199



**194030**

T4W



**094016**



Faisceau p. 249  
 Harness p. 249  
 Anschlusskabel siehe S. 249

120

**SMD98**

p 198



LEDS-24V



**D10494**

500 mm

Fonctions supplémentaires  
 Additional functions  
 Zusatzfunktionen

**Catadioptré**  
 Reflector  
 Rückstrahler



## NETAM FRUEHAUF

# NETAM FRUEHAUF

121



Faisceau p. 249  
Harness p. 249  
Anschlusskabel siehe S. 249

### D429

p 206



D10642

R5W



R5W

D10503

660 mm

### EPP96

p 177



196020

R10W



D10502

410 mm

### CT

p 214



623016

### MDJ

p 251



175020

## OMEPP

**LC8T** p 147



AMP 1.5  
arrière  
rear connector  
stecker hinten



**T** **FPL** **156040**

gauche - left - linke



**156050** **T** **FPL**

droit - right - recht



**T** **056700**

gauche - left - linke



**056710** **T**

droit - right - recht

**D429** p 206



**D10642**

R5W



R5W

**D10503**

660 mm

**EPP96** p 177



**196020**

R10W



Faisceau p. 249  
Harness p. 249  
Anschlusskabel siehe S. 249

122

Fonctions supplémentaires  
Additional functions  
Zusatzfunktionen

**T** **Catadioptré triangulaire**  
**Triangular reflector**  
**Dreieckrückstrahler**

**FPL** **Feu de position latéral**  
**Side marker lamp**  
**Seitenmarkierungsleuchte**

# PACTON

## PACTON

**LC5**

p 150

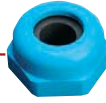

**PE**  
 arrière  
 rear connector  
 Anschlussstecker  
 hinten



**152130**

gauche - left - links



**152130**

droit - right - rechts



**052000**

gauche - left - links



**052000**

droit - right - rechts

**FE94**

p 190



**194130**

T4W



**094036**



**FE94**

p 199



**194030**

T4W



**094016**



**D429**

p 206



**D10642**

R5W

Faisceau p. 249  
 Harness p. 249  
 Anschlusskabel siehe S. 249



Fonctions supplémentaires  
 Additional functions  
 Zusatzfunktionen

**Catadioptré**  
**Reflector**  
**Rückstrahler**



## PACTON

### EPP96 p 177



### CT p 214



### MDJ p 251



PACTON

124



Faisceau p. 249  
Harness p. 249  
Anschlusskabel siehe S. 249



# SAMRO

## SAMRO

### LC5TDX p 152



AMP 1.5  
arrière  
rear connector  
Anschlusstecker  
hinten

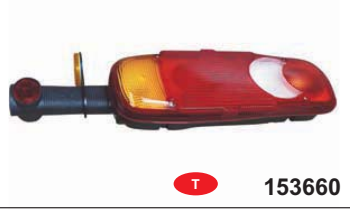

**T** 153660

gauche - left - links



153670 **T**

droit - right - rechts



**T** 053700

gauche - left - links



053710 **T**

droit - right - rechts

### LC5 p 150



PE  
arrière  
rear connector  
Anschlusstecker  
hinten

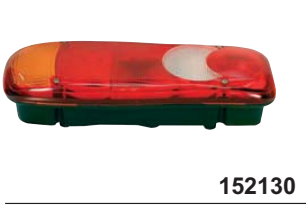

152130

gauche - left - links

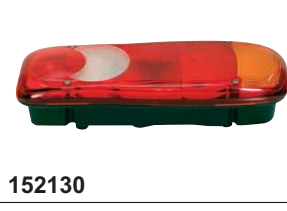

152130

droit - right - rechts



052000

gauche - left - links



052000

droit - right - rechts

### LC7 p 153



PE  
arrière  
rear connector  
Anschlusstecker  
hinten



**K** **FPL** 168270

gauche - left - links



168270 **K** **FPL**

droit - right - rechts



**K** 067500

gauche - left - links



067500 **K**

droit - right - rechts



Faisceau p. 249  
Harness p. 249  
Anschlusskabel siehe S. 249

Fonctions supplémentaires  
Additional functions  
Zusatzfunktionen

**K** Catadioptr  
Reflector  
Rückstrahler

**FPL** Feu de position latéral  
Side marker lamp  
Seitenmarkierungsleuchte

**T** Catadioptr triangulaire  
Triangular reflector  
Dreieckrückstrahler

125

## SAMRO

### LC6

p 156



PE  
arrière  
rear connector  
Anschlussstecker  
hinten



166000

gauche - left - links



EPP

166100

gauche - left - links



066000

gauche - left - links



166000

droit - right - rechts



166100

EPP

droit - right - rechts



066000

droit - right - rechts

### SMD04

p 188

NEW



LEDS-24V

K

104520

1000 mm

### FE04

p 187



LEDS-24V

K

104290

500 mm

104310

5000 mm

SAMRO

126



Faisceau p. 249  
Harness p. 249  
Anschlusskabel siehe S. 249

Fonctions supplémentaires  
Additional functions  
Zusatzfunktionen

**K** Catadioptr  
Reflector  
Rückstrahler

**EPP** Eclaireur de plaque  
Number plate lamp  
Kennzeichenleuchte

**SAMRO**

**SAMRO**

**SMD98** p 189



**FE94** p 190

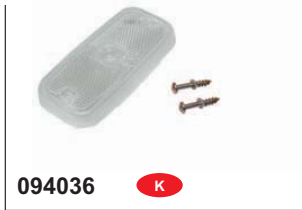

**SMD98** p 198



**FE94** p 199



**FE04** p 207



104330	500 mm
104360	5000 mm

Faisceau p. 249  
 Harness p. 249  
 Anschlusskabel siehe S. 249

Fonctions supplémentaires  
 Additional functions  
 Zusatzfunktionen

**K** Catadioptré  
 Reflector  
 Rückstrahler



## SAMRO

**FE88**

*p 203*



**D429**

*p 206*



**EPP96**

*p 177*



**CT**

*p 214*



**MDJ**

*p 251*



# SAMRO

128



Faisceau p. 249  
Harness p. 249  
Anschlusskabel siehe S. 249

## SCHWARZMUELLER

FE94

p 190



FE94

p 199



FE94

p 209



Faisceau p. 249  
 Harness p. 249  
 Anschlusskabel siehe S. 249

Fonctions supplémentaires  
 Additional functions  
 Zusatzfunktionen

**K** Catadioptré  
 Reflector  
 Rückstrahler

## SOMMER NOVTRUCK

### LC8T

p 147



AMP 1.5  
arrière  
rear connector  
stecker hinten



**T** **FPL** **156040**

gauche - left - links



**T** **FPL** **156050**

droit - right - rechts



**T** **056700**

gauche - left - links



**T** **056710**

droit - right - rechts

### SMD04

p 188



LEDS-24V **K**

<b>104130</b>	500 mm
<b>104140</b>	1500 mm

### FE94

p 190



**194130** **T4W** **K**



**094036** **K**



Faisceau p. 249  
Harness p. 249  
Anschlusskabel siehe S. 249

Fonctions supplémentaires  
Additional functions  
Zusatzfunktionen

**K**

**Catadioptr**  
**Reflector**  
**Rückstrahler**

**FPL**

**Feu de position latéral**  
**Side marker lamp**  
**Seitenmarkierungsleuchte**

**T**

**Catadioptr triangulaire**  
**Triangular reflector**  
**Dreieckrückstrahler**

SOMMER

130



**SOMMER**

**SOMMER NOVTRUCK**

**SMD04** p 197



LEDS-24V **K**

<b>104250</b>	500 mm
<b>104260</b>	1500 mm

**SMD98** p 198



LEDS-24V **K**

<b>D10494</b>	500 mm
<b>D10497</b>	1500 mm

**D429** p 206



<b>D10503</b>	660 mm
---------------	--------

**EPP96** p 177



<b>D11888</b>	1000 mm
---------------	---------

Faisceau p. 249  
 Harness p. 249  
 Anschlusskabel siehe S. 249

Fonctions supplémentaires  
 Additional functions  
 Zusatzfunktionen

**K**  
 Catadioptré  
 Reflector  
 Rückstrahler

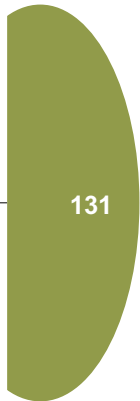

131

## TABARRINI

**LC8T**

p 147



AMP 1.5  
arrière  
rear connector  
stecker hinten



**T** **FPL** **156040**

gauche - left - links



**156050** **T** **FPL**

droit - right - rechts



**001830**

Alarme sonore de recul - Back-up alarm - Rückfahrwarner



**T** **056700**

gauche - left - links



**056710** **T**

droit - right - rechts

**SMD04**

p 188



LEDS-24V **K**

<b>104130</b>	500 mm
<b>104140</b>	1500 mm



Faisceau p. 249  
Harness p. 249  
Anschlusskabel siehe S. 249

132

Fonctions supplémentaires  
Additional functions  
Zusatzfunktionen

**K** **Catadioptr**  
**Reflector**  
**Rückstrahler**

**FPL** **Feu de position latéral**  
**Side marker lamp**  
**Seitenmarkierungsleuchte**

**T** **Catadioptr triangulaire**  
**Triangular reflector**  
**Dreieckrückstrahler**

# TABARRINI

## TABARRINI

**D429**

p 206



**EPP96**

p 177



Faisceau p. 249  
Harness p. 249  
Anschlusskabel siehe S. 249

133

## TEKNOCAR

### LC8T p 147



AMP 1.5  
arrière  
rear connector  
stecker hinten



**T** **FPL** **156040**

gauche - left - links



**156050** **T** **FPL**

droit - right - rechts



**T** **FPL** **EPP** **156060**

gauche - left - links



**T** **056700**

gauche - left - links



**056710** **T**

droit - right - rechts

### D429 p 206



**D10642**

R5W



**D10503**

660 mm



Faisceau p. 249  
Harness p. 249  
Anschlusskabel siehe S. 249

### EPP96 p 177



**196020**

R10W

Fonctions supplémentaires  
Additional functions  
Zusatzfunktionen



**Catadioptre triangulaire**  
Triangular reflector  
Dreieckrückstrahler



**Feu de position latéral**  
Side marker lamp  
Seitenmarkierungsleuchte



**Eclaireur de plaque**  
Number plate lamp  
Kennzeichenleuchte

# TITAN BTK

## TITAN / KAISER BTK

### LC8T *p 147*



**T** **FPL** **156040**

gauche - left - links

AMP 1.5  
arrière  
rear connector  
stecker hinten



**156050** **T** **FPL**

droit - right - rechts



**T** **056700**

gauche - left - links



**056710** **T**

droit - right - rechts

### LC5T *p 151*



**T** **153660**

gauche - left - links

AMP 1.5  
arrière  
rear connector  
stecker hinten



**153670** **T**

droit - right - rechts



**T** **153000**

gauche - left - links



**153010** **T**

droit - right - rechts



**053700**

gauche - left - links



**053710**

droit - right - rechts



Faisceau p. 249  
Harness p. 249  
Anschlusskabel siehe S. 249

Fonctions supplémentaires  
Additional functions  
Zusatzfunktionen

**T** **Catadioptré triangulaire**  
**Triangular reflector**  
**Dreieckrückstrahler**

**FPL** **Feu de position latéral**  
**Side marker lamp**  
**Seitenmarkierungsleuchte**

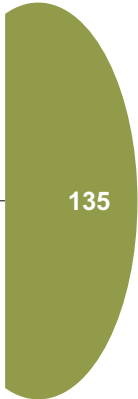

135

## TITAN / KAISER BTK

**LC3**

p 171



LEDS 12-24V **K**

<b>103080</b>	1500 mm
---------------	---------

**SMD04**

p 188



LEDS 24V **K**

<b>104130</b>	500 mm
---------------	--------

**SMD98**

p 189



LEDS 24V **K**

<b>D11399</b>	1500 mm
---------------	---------

**FPL93**

p 191



<b>193200</b>	<b>K</b>
---------------	----------



<b>001726</b>
---------------

# TITAN BTK

136



Faisceau p. 249  
 Harness p. 249  
 Anschlusskabel siehe S. 249

Fonctions supplémentaires  
 Additional functions  
 Zusatzfunktionen

**K** Catadioptré  
 Reflector  
 Rückstrahler



# TITAN BTK

## TITAN / KAISER BTK

### SMD04 p 197



LEDS-24V **K**

104250	500 mm
--------	--------



LEDS-24V **K**

104090	500 mm
--------	--------



LEDS-24V **K**

D12699	1000 mm
--------	---------

### FE88 p 203



188110	C5W
--------	-----

### EPP96 p 177



196020	R10W
--------	------

### FDT p 220



D12263*	H3/70W-24V
---------	------------



Faisceau p. 249  
 Harness p. 249  
 Anschlusskabel siehe S. 249

\*Lampe fournie  
 \*Bulb included  
 \*Inklusiv Glühlampen



Fonctions supplémentaires  
 Additional functions  
 Zusatzfunktionen

**Catadiopre**  
**Reflector**  
**Rückstrahler**



137

## TITAN / KAISER BTK

7P

p 245



611520

24N



611540

24S

# TITAN BTK

## Guide de lecture des pages "Produits standard" User guide pages "Standard products" Hinweise zur Katalogbenutzung "Standardprodukte"

Nom du produit  
Product name  
Produktbezeichnung

n° d'homologation  
Homologation number  
Homologationsnummer

Report compléments  
Reference to other versions  
Zusatzbemerkungen

Sens de montage  
Assembling position  
Montagehinweis

Report affections constructeurs  
Reference to OE applications  
Hinweise zur Fahrzeugverwendung

Lampe  
Bulb  
Glühlampe

Référence Vignal  
Vignal p/n  
Art.-Nr. Vignal

Spécificité du produit  
Product specificity  
Besonderheit des Produkts

### 2.3 Feux de position - Position lamps - Positionsluchten

Face latérale - Side face - Seitenansicht

---

**SMD04**

E2 05021

montage - mounting - Anbringung

Exemple de montage p.  
Assembly suggestion p.  
Montageempfehlung siehe S.

Autoperforant pour raccordement sur câble plat  
Click-in for flat cable  
Click-in - Anschluss für Flachkabel

**AP**

**NEW**

LED-24V **K**

104090	500 mm
104100	1500 mm

**NEW**

LED-24V **K**

104210	500 mm
104220	1500 mm

**NEW**

LED-24V **K**

104250	500 mm
104260	1500 mm

---

**SMD00**

E2 1295

montage - mounting - Anbringung

Affections constructeurs  
OE application  
Fahrzeugverwendung

**VOLVO p.**

Fonctions supplémentaires  
Additional functions  
Zusatzfunktionen

**K** Catadioptr  
Reflector  
Rückstrahler

Autoperforant pour raccordement sur câble plat  
Click-in for flat cable  
Click-in - Anschluss für Flachkabel

**AP**

Ø 102 mm x 54 mm

198620

LED-24V **K**

001766

**K**

**VIGNAL** ORIGINAL QUALITY PARTS

Référence Vignal  
Vignal p/n  
Art.-Nr. Vignal

Symbole fonctions  
Functions symbol  
Funktionssymbole

**K** Catadioptr  
Reflector  
Rückstrahler

**FPL** Feu de position latéral  
Side marker lamp  
Seitenmarkierungsleuchte

**EPP** Eclaireur de plaque  
Number plate lamp  
Kennzeichenleuchte

**ASR** Alarme sonore de recul  
Back up alarm  
Rückfahrtsignalhorn

**T** Catadioptr triangulaire  
Triangular reflector  
Dreieckrückstrahler

**SAM** Système d'aide à la manoeuvre  
Manoeuvre helping system  
Manövriehilfsreflektor

LEDS-24V **K**

104090	500 mm
104100	1500 mm

**VIGNAL**

**ORIGINAL QUALITY PARTS**

## 2

**Produits standard - Standard products - Universalprodukte****2.1 Feux arrière - Rear lamps - Heckleuchten**

Feux multifonction - Multifunction lamps - Mehrkammerleuchten.....	p.141
Feux monofonction - Monofunction lamps - Einzelfunktionsleuchten .....	p.173
Eclaireurs de plaque - Number plate lamps - Kennzeichenleuchten.....	p.177

**2.2 Feux clignotants - Flasher lamps - Fahrtrichtungsanzeiger**

Face avant - Front face - Frontansicht.....	p.178
Face latérale - Side face - Seitenansicht.....	p.183
Face arrière - Rear face - Heckansicht.....	p.186

**2.3 Feux de position - Position lamps - Positionsleuchten**

Face avant - Front face - Frontansicht.....	p.187
Face latérale - Side face - Seitenansicht.....	p.197
Face arrière - Rear face - Heckansicht.....	p.207

**2.4 Produits complémentaires - Complementary products - Ergänzende Produkte**

Signalisation passive - Warning products - Warnmarkierungen.....	p.213
Eclairage intérieur - Dom lamps - Innenraumleuchten.....	p.218
Eclairage extérieur - Working lamps - Arbeitsscheinwerfer.....	p.220
Gyrophares - Rotating beacons - Rundumkennleuchten.....	p.222
Alarmes et caméras - Back-up alarms and cameras - Rückfahrwarner und -videosysteme.....	p.225
Centrales et tempo - Flasher units and windscreen - Elektronische Blinkgeber und Zeitrelais.....	p.227
Lampes - Bulbs - Glühlampen.....	p.228
Rétroviseurs - Rear view mirrors - Rückspiegel.....	p.235

**2.5 Electricité remorque - Electric products for trailers - Elektrik für Anhänger/Auflieger**

Prises et cordons de liaison - Cables and plugs - Anschlusskabel und Steckverbindungen.....	p.244
Câblage remorque - Trailers harnesses - Verkabelungsprodukte für Anhänger/Auflieger.....	p.249

# LC8 LEDS



Brouillard / Position 25 leds  
Fog / Position lamp 25 leds  
Nebelschluss/Schlussleuchte 25 leds

Catadiopre camion / remorque  
Reflex reflector truck / trailer  
Rückstrahler LKW / Anhänger

Feu stop 10 leds  
Stop lamp 10 leds  
Bremsleuchte 10 leds

Feu d'encombrement 4 leds  
Rear outline marker lamp 4 leds  
Hinterepositionleuchte 4 leds



Catadiopre latéral  
Side reflex reflector  
Seitlicher Rückstrahler

Feu de recul 5 leds  
Reverse lamp 5 leds  
Rückfahrleuchte 5 leds

Indicateur de direction 21 leds  
Flasher lamp 21 leds  
Fahrtrichtungsanzeiger 21 leds

Feu de position latéral 3 leds  
Side position lamp 3 leds  
Seitenmarkierungsleuchte 3 leds

141

- 100 % LEDS - 12V / 24V
- Interchangeable avec le feu LC8  
Interchangeable with LC8 rear lamp  
Austauschbar mit Leuchte LC8
- Compatibilité tous véhicules \*  
Compatible with all vehicles \*  
Für alle Fahrzeuge geeignet \*
- Leds qualifiées pour 30 000 h  
30,000 h Leds lifetime  
Leds Lebensdauer 30,000 h
- Homologation CEM (Compatibilité Electro-Magnétique)  
EMC certification (Electro Magnetic Compatibility)  
EMV-Typgenehmigung (elektromagnetische Verträglichkeit)

\* pour remorques, boîtier supplémentaire p. 143  
for trailers, additional gear p. 143  
Vorschaltgerät für Anhänger Seite 143

Tableau comparatif consommation LC8 lampes / LC8 Leds  
Comparative statement LC8 bulbs / LC8 Leds  
Komparativtafel LC8 Glühlampen / LC8 Leds

Fonction - Function - Funktionen	Lampes Bulbs Glühlampen	LEDS
Position Latéral Side position lamp Seitenmarkierungsleuchte	5 W	2,5 W
Feu d'encombrement Rear outline marker lamp Hinterepositionleuchte	5 W	0,15 W
Indicateur de direction Direction indicator Fahrtrichtungsanzeiger	21 W	5,5 W
Feu stop Stop lamp Bremsleuchte	21 W	3,5 W
Feu de recul Reverse lamp Rückfahrleuchte	21 W	4 W
Feu de position Position lamp Schlussleuchte	5 W	0,1 W
Feu de brouillard Fog lamp Nebelschlussleuchte	21 W	8,5 W

## 2.1 Feux arrière - Rear lamps - Heckleuchten

### Feux multifonction - Multifunction lamps - Mehrkammerleuchten

LC8  
LEDS

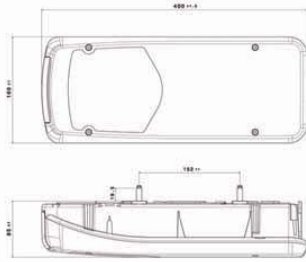

400 mm x 160 mm x 88,5 mm



**NEW**



**157000**  
LED 12-24V    gauche - left - links



AMP 1.5  
latéral  
side connector  
Anschlussstecker  
seitlich

**NEW**



**157010**  
LED 12-24V    droit - right - rechts



E2 08110

montage - mounting - Anbringung



**NEW**



**157060**  
LED 12-24V    gauche - left - links

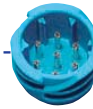

AMP 1.5  
arrière  
rear connector  
Anschlussstecker  
hinten

**NEW**



**157070**  
LED 12-24V    droit - right - rechts

142

### Pièces détachées - Spare part - Ersatzteile

**NEW**



**057000**

gauche - left - links

**NEW**



**057000**

droit - right - rechts



Faisceau p. 253  
Harness p. 253  
Anschlusskabel siehe S. 253

Fonctions supplémentaires  
Additional functions  
Zusatzfunktionen

**K**  
Catadioptr  
Reflector  
Rückstrahler

**FPL**  
Feu de position latéral  
Side marker lamp  
Seitenmarkierungsleuchte



## 2.1 Feux arrière - Rear lamps - Heckleuchten

### Feux multifonction - Multifunction lamps - Mehrkammerleuchten

**LC8T  
LEDS**

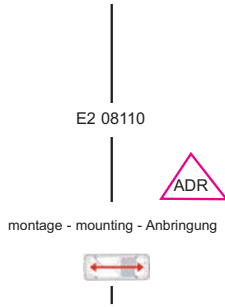
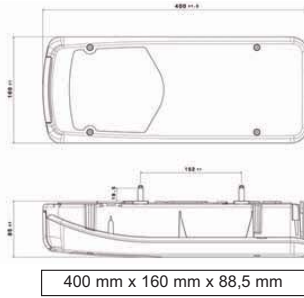

**NEW**



**T FPL** **157040**  
LED 12-24V gauche - left - links



**AMP 1.5**  
arrière  
rear connector  
Anschlussstecker  
hinten

**NEW**



**157050** **FPL T**  
LED 12-24V droit - right - rechts

### Pièces détachées - Spare part - Ersatzteile

**NEW**



**057000**  
gauche - left - links

**NEW**



**057000**  
droit - right - rechts



Faisceau p. 253  
Harness p. 253  
Anschlusskabel siehe S. 253

**NEW**



**D13234** 16 voies - poles - Pöilige Stecker  
**D13235** 15 voies - poles - Pöilige Stecker  
**D13236** 7 voies - poles - Pöilige Stecker

Boitier de compatibilité  
Compatibility gear  
Vorschaltgerät

Fonctions supplémentaires  
Additional functions  
Zusatzfunktionen

**T** **Catadioptré triangulaire**  
Triangular reflector  
Dreieckrückstrahler

**FPL** **Feu de position latéral**  
Side marker lamp  
Seitenmarkierungsleuchte



Connecteur AMP 1.5 simple  
Single AMP 1.5 connector  
Anschlussstecker AMP 1.5 **D11868**



## 2.1 Feux arrière - Rear lamps - Heckleuchten Feux multifonction - Multifunction lamps - Mehrkammerleuchten

LC9

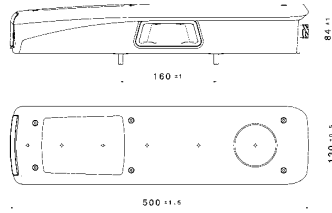

500 mm x 130 mm x 83 mm



E2 04075



montage - mounting - Anbringung



Affectations constructeurs  
OE application  
Fahrzeugverwendung

RENAULT TRUCKS p. 36

VOLVO p. 73

### Pièces détachées - Spare part - Ersatzteile



Fonctions supplémentaires  
Additional functions  
Zusatzfunktionen

**K** Catadioptré  
Reflector  
Rückstrahler

**FPL** Feu de position latéral  
Side marker lamp  
Seitenmarkierungsleuchte

**EPP** Eclairage de plaque  
Number plate lamp  
Kennzeichenleuchte

**ASR** Alarme sonore de recul  
Back up alarm  
Rückfahrhorn

144

## 2.1 Feux arrière - Rear lamps - Heckleuchten

### Feux multifonction - Multifunction lamps - Mehrkammerleuchten

LC8



400 mm x 160 mm x 88.5 mm

E2 2040



montage - mounting - Anbringung



Affectations constructeurs  
OE application  
Fahrzeugverwendung

MAN p. 29



**K FPL EPP 156200**

gauche - left - links



AMP 1.5  
latéral  
side connector  
Anschlusstecker  
seitlich



**156210 K FPL**

droit - right - rechts



**156220 K FPL ASR**

droit - right - rechts



AMP 1.5  
arrière  
rear connector  
Anschlusstecker  
hinten



**FPL 156550**

gauche - left - links



**156540 FPL**

droit - right - rechts



**K FPL 156310**

gauche - left - links



**156300 K FPL**

droit - right - rechts



**K FPL EPP 156290**

gauche - left - links

Faisceau p. 253  
Harness p. 253  
Anschlusskabel siehe S. 253

Fonctions supplémentaires  
Additional functions  
Zusatzfunktionen

- K** Catadioptré  
Reflector  
Rückstrahler
- FPL** Feu de position latéral  
Side marker lamp  
Seitenmarkierungsleuchte
- EPP** Eclairer de plaque  
Number plate lamp  
Kennzeichenleuchte
- ASR** Alarme sonore de recul  
Back up alarm  
Rückfahrhorn

### Pièces détachées - Spare part - Ersatzteile



**056000**

**K 056500**

gauche - left - links



**056010**

**056510 K**

droit - right - rechts

## 2.1 Feux arrière - Rear lamps - Heckleuchten

### Feux multifonction - Multifunction lamps - Mehrkammerleuchten

LC8



AMP 1.5  
arrière  
rear connector  
Anschlussstecker  
hinten



FPL 156590

gauche - left - links



156600 FPL

droit - right - rechts



K FPL EPP 156340

gauche - left - links



156350 K FPL

droit - right - rechts



AMP 1.5  
latéral  
side connector  
Anschlussstecker  
seitlich



K FPL EPP 156770

gauche - left - links



156780 K FPL

droit - right - rechts



K FPL 155020

gauche - left - links



156790 K FPL ASR

droit - right - rechts

E2 2040



montage - mounting - Anbringung



Affectations constructeurs  
OE application  
Fahrzeugverwendung

MERCEDES p. 33  
SCANIA p. 71  
VOLKSWAGEN p. 72

146



Faisceau p. 253  
Harness p. 253  
Anschlusskabel siehe S. 253

### Pièces détachées - Spare part - Ersatzteile



056020

K 056540

gauche - left - links



056030

056550 K

droit - right - rechts



Connecteur AMP 1.5 simple  
Single AMP 1.5 connector  
Anschlussstecker AMP 1.5 D11868

Fonctions supplémentaires  
Additional functions  
Zusatzfunktionen

**K** Catadioptré  
Reflector  
Rückstrahler

**FPL** Feu de position latéral  
Side marker lamp  
Seitenmarkierungsleuchte

**EPP** Eclairé de plaque  
Number plate lamp  
Kennzeichenleuchte

**ASR** Alarme sonore de recul  
Back up alarm  
Rückfahrtsignalhorn

## 2.1 Feux arrière - Rear lamps - Heckleuchten

### Feux multifonction - Multifunction lamps - Mehrkammerleuchten

LC8T

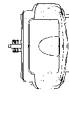
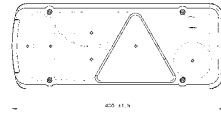
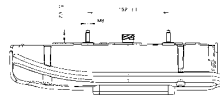

400 mm x 160 mm x 88,5 mm

E2 2040



montage - mounting - Anbringung



Affectations constructeurs  
OE application  
Fahrzeugverwendung

p. 78



AMP 1.5  
arrière  
rear connector  
Anschlusstecker  
hinten



T FPL 156040

gauche - left - links



T FPL EPP 156060

gauche - left - links



156050 T FPL

droit - right - rechts



156070 T FPL EPP

droit - right - rechts

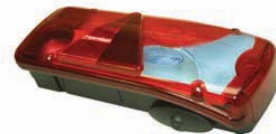

156130 T FPL ASR

droit - right - rechts



156150 T FPL ASR EPP

droit - right - rechts



156170 T ASR SAM FPL

droit - right - rechts



156190 T EPP ASR SAM FPL

droit - right - rechts

147



Faisceau p. 253  
Harness p. 253  
Anschlusskabel siehe S. 253

Fonctions supplémentaires  
Additional functions  
Zusatzfunktionen

T Catadiopre triangulaire  
Triangular reflector  
Dreieckrückstrahler

FPL Feu de position latéral  
Side marker lamp  
Seitenmarkierungsleuchte

EPP Eclairer de plaque  
Number plate lamp  
Kennzeichenleuchte

ASR Alarme sonore de recul  
Back up alarm  
Rückfahrhorn

SAM Réflecteur additionnel pour  
fonction recul  
Inside additional reflector for  
reverse light  
Zusätzlicher Reflektor für die  
Rückfahrleuchte

## 2.1 Feux arrière - Rear lamps - Heckleuchten

### Feux multifonction - Multifunction lamps - Mehrkammerleuchten

LC8T



**T** **FPL** **EPP** **156630**

gauche - left - links



**AMP 1.5**  
latéral  
side connector  
Anschlussstecker  
seitlich



**156640** **T** **FPL** **EPP**

droit - right - rechts

E2 2040



montage - mounting - Anbringung



Affectations constructeurs  
OE application  
Fahrzeugverwendung

**p. 78**

### Pièces détachées - Spare part - Ersatzteile



**T** **056700**

gauche - left - links



**056710** **T**

droit - right - rechts



**001830**

Alarme sonore de recul  
Back up alarm  
Rückfahrtsignalhorn



**001846**



Faisceau p. 253  
Harness p. 253  
Anschlusskabel siehe S. 253



Connecteur AMP 1.5 simple  
Single AMP 1.5 connector  
Anschlussstecker AMP 1.5 **D11868**

Fonctions supplémentaires  
Additional functions  
Zusatzfunktionen

**T** **Catadioptre triangulaire**  
**Triangular reflector**  
**Dreieckrückstrahler**

**FPL** **Feu de position latéral**  
**Side marker lamp**  
**Seitenmarkierungsleuchte**

**EPP** **Eclaireur de plaque**  
**Number plate lamp**  
**Kennzeichenleuchte**

148



## 2.1 Feux arrière - Rear lamps - Heckleuchten

### Feux multifonction - Multifunction lamps - Mehrkammerleuchten

LC8T



E2 2040



montage - mounting - Anbringung



Affectations constructeurs  
OE application  
Fahrzeugverwendung

p. 78



AMP 1.5  
arrière  
rear connector  
Anschlussstecker  
hinten



T FPL 156250

gauche - left - links



156260 T FPL

droit - right - rechts



T FPL EPP 156380

gauche - left - links



156390 T FPL EPP

droit - right - rechts

149

### Pièces détachées - Spare part - Ersatzteile



Faisceau p. 253  
Harness p. 253  
Anschlusskabel siehe S. 253



T 056720

gauche - left - links



056730 T

droit - right - rechts



Connecteur AMP 1.5 simple  
Single AMP 1.5 connector  
Anschlussstecker AMP 1.5 D11868

Fonctions supplémentaires  
Additional functions  
Zusatzfunktionen

T Catadioptre triangulaire  
Triangular reflector  
Dreieckrückstrahler

FPL Feu de position latéral  
Side marker lamp  
Seitenmarkierungsleuchte

EPP Eclairer de plaque  
Number plate lamp  
Kennzeichenleuchte



## 2.1 Feux arrière - Rear lamps - Heckleuchten Feux multifonction - Multifunction lamps - Mehrkammerleuchten

LC5

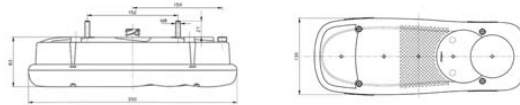

350 mm x 130 mm x 83 mm

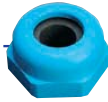

**PE**  
arrière  
rear connector  
Anschlusstecker  
hinten



**152130**

**K 152150**

gauche - left - links



**152130**

**152150 K**

droit - right - rechts



**EPP 152160**

**K EPP 152140**

gauche - left - links



**AMP 1.5**  
arrière  
rear connector  
Anschlusstecker  
hinten



**152200**

**K 152180**

gauche - left - links



**152200**

**152180 K**

droit - right - rechts



**EPP 152190**

**K EPP 152170**

gauche - left - links



**153120 K ASR**

droit - right - rechts

E2 8005



montage - mounting - Anbringung



Affectations constructeurs  
OE application  
Fahrzeugverwendung

**DAF p. 07**

**MANITOU p. 32**

**NISSAN p. 34**

**RENAULT TRUCKS p. 36**

**SANTANA p. 70**

**VOLVO p. 73**

150



Faisceau p. 253  
Harness p. 253  
Anschlusskabel siehe S. 253

Fonctions supplémentaires  
Additional functions  
Zusatzfunktionen

**K**  
**Catadioptr**  
Reflector  
Rückstrahler

**FPL**  
**Feu de position latéral**  
Side marker lamp  
Seitenmarkierungsleuchte

**EPP**  
**Eclairer de plaque**  
Number plate lamp  
Kennzeichenleuchte

**ASR**  
**Alarme sonore de recul**  
Back up alarm  
Rückfahrtsignalhorn

### Pièces détachées - Spare part - Ersatzteile



**052000**

**K 052500**

gauche - left - links



**052000**

**052500 K**

droit - right - rechts

## 2.1 Feux arrière - Rear lamps - Heckleuchten

### Feux multifonction - Multifunction lamps - Mehrkammerleuchten

LC5T

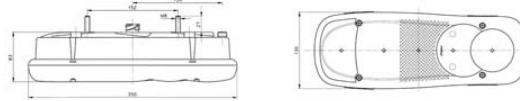

350 mm x 130 mm x 83 mm

E2 06024 (sans DX)  
E2 07092 (avec DX)



montage - mounting - Anbringung



Affectations constructeurs  
OE application  
Fahrzeugverwendung

p.78

151



Faisceau p. 253  
Harness p. 253  
Anschlusskabel siehe S. 253

Fonctions supplémentaires  
Additional functions  
Zusatzfunktionen

**T** Catadioptre triangulaire  
Triangular reflector  
Dreieckrückstrahler

**EPP** Eclairer de plaque  
Number plate lamp  
Kennzeichenleuchte

**ASR** Alarme sonore de recul  
Back up alarm  
Rückfahrhorn



PE  
arrière  
rear connector  
Anschlussstecker  
hinten



**T** 153040

gauche - left - links



153050 **T**

droit - right - rechts



**T** **EPP** 153060

gauche - left - links



153070 **EPP** **T**

droit - right - rechts



AMP 1.5  
arrière  
rear connector  
Anschlussstecker  
hinten



**T** 153000

gauche - left - links



153010 **T**

droit - right - rechts



**T** **EPP** 153020

gauche - left - links



153030 **EPP** **T**

droit - right - rechts



153130 **T** **ASR**

droit - right - rechts



D13288



D13288

## 2.1 Feux arrière - Rear lamps - Heckleuchten

### Feux multifonction - Multifunction lamps - Mehrkammerleuchten

LC5T



AMP 1.5  
arrière  
rear connector  
Anschlussstecker  
hinten





**T** **153660**

gauche - left - links



**153670** **T**

droit - right - rechts



**T** **EPP** **153700**

gauche - left - links



**153710** **EPP** **T**

droit - right - rechts

Affectations constructeurs  
OE application  
Fahrzeugverwendung  
**p. 78**

### Pièces détachées - Spare part - Ersatzteile



**T** **053700**

gauche - left - links



**053710** **T**

droit - right - rechts



**001746**

Câble pour connection EPP séparé  
Wiring for number plate lamp  
Anschlusskabel für Kennzeichenleuchte



Connecteur AMP 1.5 simple  
Single AMP 1.5 connector  
Anschlussstecker AMP 1.5 **D11868**



**D12430**



**D12473**



**D12471**



**D12472**

152

Faisceau p. 253  
Harness p. 253  
Anschlusskabel siehe S. 253

Fonctions supplémentaires  
Additional functions  
Zusatzfunktionen

- T** Catadioptré triangulaire  
Triangular reflector  
Dreieckrückstrahler
- EPP** Eclaireur de plaque  
Number plate lamp  
Kennzeichenleuchte

## 2.1 Feux arrière - Rear lamps - Heckleuchten

### Feux multifonction - Multifunction lamps - Mehrkammerleuchten

LC7

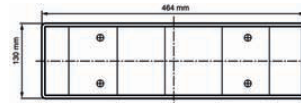
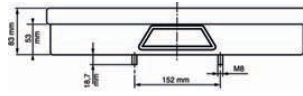

464 mm x 130 mm x 83 mm

E2 88017 (LC7)  
E2 88035 (LC7K)



montage - mounting - Anbringung



Affectations constructeurs  
OE application  
Fahrzeugverwendung

DAF p. 07

ERF p. 12

FODEN p. 13

HEULIEZ p. 14

IRISBUS p. 16

IVECO p. 23

MAN p. 29

RENAULT TRUCKS p. 36

SCANIA p. 71

153

Fonctions supplémentaires  
Additional functions  
Zusatzfunktionen

**K**

Catadioptr  
Reflector  
Rückstrahler

**FPL**

Feu de position latéral  
Side marker lamp  
Seitenmarkierungsleuchte

**EPP**

Eclaireur de plaque  
Number plate lamp  
Kennzeichenleuchte



PE  
arrière  
rear connector  
Anschlusstecker  
hinten



**EPP** 167100

gauche - left - links



167000

droit - right - rechts



**K** **EPP** 167600

gauche - left - links



167500 **K**

droit - right - rechts



**K** **FPL** 168270

gauche - left - links



168270 **K** **FPL**

droit - right - rechts



**K** **FPL** **EPP** 168340

gauche - left - links



DIN  
arrière  
rear connector  
Stecker hinten



**K** **FPL** 168090

gauche - left - links



168090 **K** **FPL**

droit - right - rechts



**K** **FPL** **EPP** 168100

gauche - left - links

## 2.1 Feux arrière - Rear lamps - Heckleuchten

### Feux multifonction - Multifunction lamps - Mehrkammerleuchten

LC7



AMP 1.5  
latéral  
side connector  
Anschlussstecker  
seitlich



**K FPL EPP 169160**

gauche - left - links



**K FPL 169180**

gauche - left - links



**169170 K FPL**

droit - right - rechts



**169280 K FPL EPP**

droit - right - rechts



**169190 K FPL ASR**

droit - right - rechts



E2 88017 (LC7)  
E2 88035 (LC7K)



montage - mounting - Anbringung



Affectations constructeurs  
OE application  
Fahrzeugverwendung

DAF p. 07

ERF p. 12

FODEN p. 13

HEULIEZ p. 14

IRISBUS p. 16

IVECO p. 23

MAN p. 29

RENAULT TRUCKS p.  
36

SCANIA p. 71



Faisceau p. 253  
Harness p. 253  
Anschlusskabel siehe S. 253

Fonctions supplémentaires  
Additional functions  
Zusatzfunktionen

**K** Catadioptr  
Reflector  
Rückstrahler

**FPL** Feu de position latéral  
Side marker lamp  
Seitenmarkierungsleuchte

**EPP** Eclaireur de plaque  
Number plate lamp  
Kennzeichenleuchte

**ASR** Alarme sonore de recul  
Back up alarm  
Rückfahrtsignalhorn

### Pièces détachées - Spare part - Ersatzteile



**067000**

**K 067500**

gauche - left - links



**067000**

**067500 K**

droit - right - rechts



**001706**

Silent blocs  
Silent blocs  
Schwingungsdämpfer



**001656**

Cales  
Brocks  
Distanzstücke



Connecteur AMP 1.5 simple  
Single AMP 1.5 connector  
Anschlussstecker AMP 1.5 **D11868**



**D12953**

Alarme sonore de recul  
Back up alarm  
Rückfahrtsignalhorn



154



## 2.1 Feux arrière - Rear lamps - Heckleuchten

### Feux multifonction - Multifunction lamps - Mehrkammerleuchten

LC7T

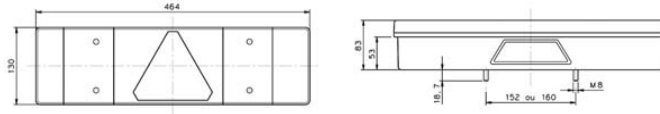

464 mm x 130 mm x 83 mm



**PE**  
arrière  
rear connector  
Anschlusstecker  
hinten

E2 9056



montage - mounting - Anbringung



Affectations constructeurs  
OE application  
Fahrzeugverwendung

p. 78



**T** 167530

gauche - left - links



167550 **T**

droit - right - rechts



**T** **FPL** 168770

gauche - left - links



168790 **T** **FPL**

droit - right - rechts



**T** **FPL** **EPP** 168780

gauche - left - links



168800 **T** **FPL** **EPP**

droit - right - rechts



168830 **T** **FPL** **ASR**

droit - right - rechts

### Pièces détachées - Spare part - Ersatzteile

Fonctions supplémentaires  
Additional functions  
Zusatzfunktionen

**T** Catadioptré triangulaire  
Triangular reflector  
Dreieckrückstrahler

**FPL** Feu de position latéral  
Side marker lamp  
Seitenmarkierungsleuchte

**EPP** Eclairer de plaque  
Number plate lamp  
Kennzeichenleuchte

**ASR** Alarme sonore de recul  
Back up alarm  
Rückfahrwarnhorn



**T** 067610

gauche - left - links



067600 **T**

droit - right - rechts



## 2.1 Feux arrière - Rear lamps - Heckleuchten

### Feux multifonction - Multifunction lamps - Mehrkammerleuchten

LC6

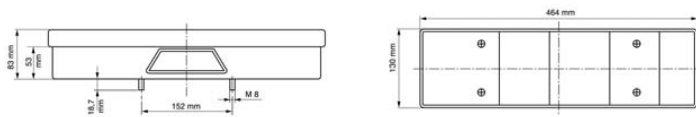

464 mm x 130 mm x 83 mm



**PE**  
arrière  
rear connector  
Anschlussstecker  
hinten

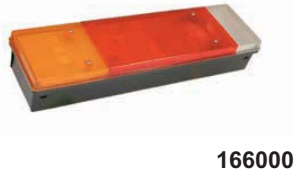

gauche - left - links



droit - right - rechts

E2 88033 (LC6)  
E2 88034 (LC6K)



montage - mounting - Anbringung



Affectations constructeurs  
OE application  
Fahrzeugverwendung

**HEULIEZ p. 14**

**IRISBUS p. 16**

**MAN p. 29**

**RENAULT TRUCKS p.36**

156



gauche - left - links



droit - right - rechts



gauche - left - links



droit - right - rechts

### Pièces détachées - Spare part - Ersatzteile



gauche - left - links



droit - right - rechts



gauche - left - links



droit - right - rechts

Fonctions supplémentaires  
Additional functions  
Zusatzfunktionen

**K**  
Catadioptr  
Reflector  
Rückstrahler

**EPP**  
Eclaireur de plaque  
Number plate lamp  
Kennzeichenleuchte

## 2.1 Feux arrière - Rear lamps - Heckleuchten

### Feux multifonction - Multifunction lamps - Mehrkammerleuchten

LC4

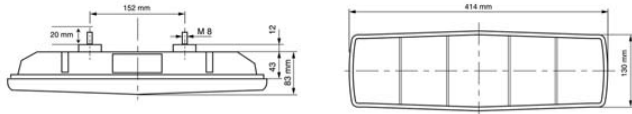

414 mm x 130 mm x 83 mm



**PE**  
arrière  
rear connector  
Anschlussstecker  
hinten

E2 91098 (LC4K)  
E2 91099 (LC4)

montage - mounting - Anbringung



Affectations constructeurs  
OE application  
Fahrzeugverwendung

DAF p. 07

RENAULT TRUCKS p. 36



**EPP** 141000

gauche - left - links



141000 **EPP**

droit - right - rechts



**K** **EPP** 141500

gauche - left - links



141500 **K** **EPP**

droit - right - rechts

### Pièces détachées - Spare part - Ersatzteile



040000

gauche - left - links



040000

droit - right - rechts



**K** 040500

gauche - left - links



040500 **K**

droit - right - rechts



000046

Fonctions supplémentaires  
Additional functions  
Zusatzfunktionen

**K** Catadioptré  
Reflector  
Rückstrahler

**EPP** Eclaireur de plaque  
Number plate lamp  
Kennzeichenleuchte

157

## 2.1 Feux arrière - Rear lamps - Heckleuchten

### Feux multifonction - Multifunction lamps - Mehrkammerleuchten

LC4B

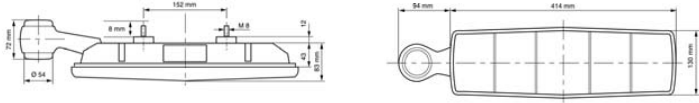

508 mm x 130 mm x 83 mm



**PE**  
arrière  
rear connector  
Anschlussstecker  
hinten



**EPP** 141110

gauche - left - links



141310 **EPP**

droit - right - rechts

E2 90715  
E2 91098

montage - mounting - Anbringung



Affectations constructeurs  
OE application  
Fahrzeugverwendung

**RENAULT TRUCKS p. 36**

### Pièces détachées - Spare part - Ersatzteile



**040000**

gauche - left - links



**040000**

droit - right - rechts



**180130**



**080126**



**080136**



**080156**



**000046**

158

Fonctions supplémentaires  
Additional functions  
Zusatzfunktionen

**EPP**

Eclaireur de plaque  
Number plate lamp  
Kennzeichenleuchte

## 2.1 Feux arrière - Rear lamps - Heckleuchten

### Feux multifonction - Multifunction lamps - Mehrkammerleuchten

672

E1 63221

montage - mounting - Anbringung

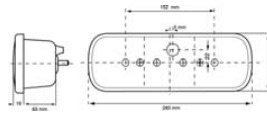

343 mm x 133 mm x 73 mm



PF  
arrière  
rear connector  
Anschlusstecker  
hinten



**K** **EPP**

672240

gauche - left - links



672230

**K**

droit - right - rechts

### Pièces détachées - Spare part - Ersatzteile



**K**

672330

gauche - left - links



672330

**K**

droit - right - rechts

159

672

E1 63216

montage - mounting - Anbringung



Affectations constructeurs  
OE application  
Fahrzeugverwendung

**MERCEDES p. 33**

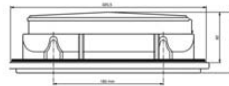

330 mm x 120 mm x 100 mm



672000

gauche - left - links



672000

droit - right - rechts

Fonctions supplémentaires  
Additional functions  
Zusatzfunktionen

**K** **Catadioptré**  
Reflector  
Rückstrahler

**EPP** **Eclaireur de plaque**  
Number plate lamp  
Kennzeichenleuchte

## 2.1 Feux arrière - Rear lamps - Heckleuchten

### Feux multifonction - Multifunction lamps - Mehrkammerleuchten

2086

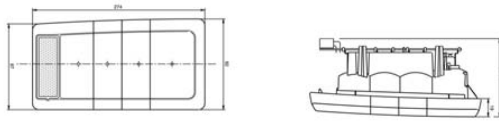

274 mm x 92 mm x 19 mm

E2 87101

montage - mounting - Anbringung



20860705

gauche - left - links



20860805

droit - right - rechts

725 V



K

D12338

gauche - left - links

3,5 T



K

D12339

droit - right - rechts

montage - mounting - Anbringung



160



K

D12340

gauche - left - links

5 T



K

D12341

droit - right - rechts

Fonctions supplémentaires  
Additional functions  
Zusatzfunktionen

**K** Catadioptr  
Reflector  
Rückstrahler

## 2.1 Feux arrière - Rear lamps - Heckleuchten

### Feux multifonction - Multifunction lamps - Mehrkammerleuchten

**725**

E3 47364  
E3 52308  
E3 52309  
E3 52310  
E3 52312

montage - mounting - Anbringung



Affectations constructeurs  
OE application  
Fahrzeugverwendung

**IVECO p. 23**

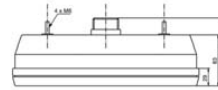
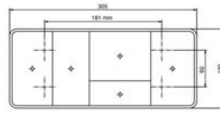

305 mm x 130 mm x 83 mm



**IVECO**  
arrière  
rear connector  
Anschlusstecker  
hinten



**K** **725040**

gauche - left - links



**K** **EPP** **725000**

gauche - left - links



**IVECO**  
arrière  
rear connector  
Anschlusstecker  
hinten



**K** **725020**

gauche - left - links

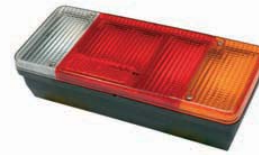

**725010** **K**

droit - right - rechts

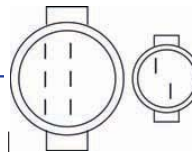

**IVECO**  
arrière  
rear connector  
Anschlusstecker  
hinten



**K** **726310**

gauche - left - links



**726320** **K**

droit - right - rechts

Fonctions supplémentaires  
Additional functions  
Zusatzfunktionen

**K** **Catadioptré**  
**Reflector**  
**Rückstrahler**

**EPP** **Eclaireur de plaque**  
**Number plate lamp**  
**Kennzeichenleuchte**

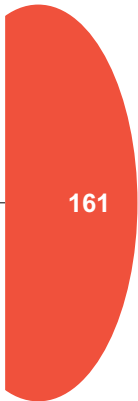

161



## 2.1 Feux arrière - Rear lamps - Heckleuchten

### Feux multifonction - Multifunction lamps - Mehrkammerleuchten



**726290** K

gauche - left - links

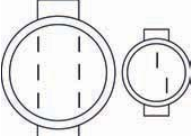

IVECO  
arrière  
rear connector  
Anschlussstecker  
hinten



**726300** K

droit - right - rechts

---



**726350** K EPP

gauche - left - links

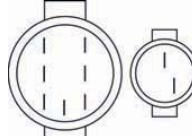

IVECO  
arrière  
rear connector  
Anschlussstecker  
hinten



**726450** K

gauche - left - links



IVECO  
arrière  
rear connector  
Anschlussstecker  
hinten



**726460** K

droit - right - rechts

**725**

E3 47364  
E3 52308  
E3 52309  
E3 52310  
E3 52312

montage - mounting - Anbringung



Affectations constructeurs  
OE application  
Fahrzeugverwendung

**IVECO p. 23**

162

### Pièces détachées - Spare part - Ersatzteile



**725002** K

gauche - left - links



**725012** K

droit - right - rechts



**725022** K

gauche - left - links



**725032** K

droit - right - rechts

Fonctions supplémentaires  
Additional functions  
Zusatzfunktionen

K **Catadioptr**  
**Reflector**  
**Rückstrahler**

EPP **Eclaireur de plaque**  
**Number plate lamp**  
**Kennzeichenleuchte**

## 2.1 Feux arrière - Rear lamps - Heckleuchten

### Feux multifonction - Multifunction lamps - Mehrkammerleuchten

725

E13 8434

montage - mounting - Anbringung



Affectations constructeurs  
OE application  
Fahrzeugverwendung

IVECO p. 23

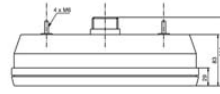
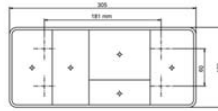

305 mm x 130 mm x 83 mm



AMP 1.5  
arrière  
rear connector  
Anschlusstecker  
hinten



**K** D11482

gauche - left - links



D11481 **K**

droit - right - rechts

### Pièces détachées - Spare part - Ersatzteile



**K** D11480

gauche - left - links



D11479 **K**

droit - right - rechts



AMP 1.5  
arrière  
rear connector  
Anschlusstecker  
hinten



**K** D12334

gauche - left - links



D12335 **K**

droit - right - rechts

### Pièces détachées - Spare part - Ersatzteile



**K** D12336

gauche - left - links



D12337 **K**

droit - right - rechts

Fonctions supplémentaires  
Additional functions  
Zusatzfunktionen

**K** Catadioptré  
Reflector

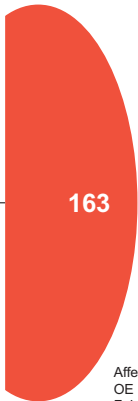

163

E13 2060

Affectations constructeurs  
OE application  
Fahrzeugverwendung

IVECO p. 23

## 2.1 Feux arrière - Rear lamps - Heckleuchten

### Feux multifonction - Multifunction lamps - Mehrkammerleuchten

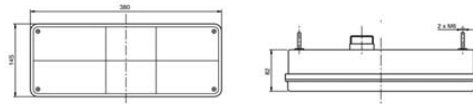

380 mm x 145 mm x 82 mm



IVECO  
arrière  
rear connector  
Anschlusstecker  
hinten



**K** 726720

gauche - left - links



726730 **K**

droit - right - rechts



**K** **EPP** 726740

gauche - left - links

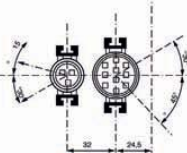

IVECO  
arrière  
rear connector  
Anschlusstecker  
hinten



**K** 726750

gauche - left - links



726760 **K**

droit - right - rechts



**K** **EPP** 726770

gauche - left - links

### Pièces détachées - Spare part - Ersatzteile



**K** 726701

gauche - left - links



726691 **K**

droit - right - rechts

726

E13 9035

montage - mounting - Anbringung



Affectations constructeurs  
OE application  
Fahrzeugverwendung

IVECO p. 23

164

Fonctions supplémentaires  
Additional functions  
Zusatzfunktionen

**K** Catadioptr  
Reflector  
Rückstrahler

**EPP** Eclairer de plaque  
Number plate lamp  
Kennzeichenleuchte

## 2.1 Feux arrière - Rear lamps - Heckleuchten Feux multifonction - Multifunction lamps - Mehrkammerleuchten

**LA35**

E2 90724

montage - mounting - Anbringung

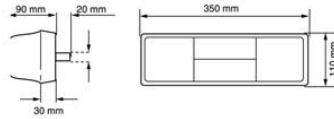

350 mm x 110 mm x 90 mm



**PF**  
arrière  
rear connector  
Anschlusstecker  
hinten



**EPP** **135200**

gauche - left - links

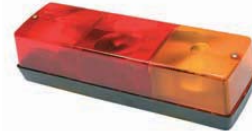

**135200**

droit - right - rechts



**2 x EPP** **135300**

gauche - left - links



**135300** **2 x EPP**

droit - right - rechts

### Pièces détachées - Spare part - Ersatzteile



**EPP** **035000**

gauche - left - links

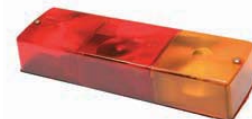

**035000**

droit - right - rechts



**2 x EPP** **035300**

gauche - left - links



**035300** **2 x EPP**

droit - right - rechts



**000046**

Fonctions supplémentaires  
Additional functions  
Zusatzfunktionen

**EPP**

Eclaireur de plaque  
Number plate lamp  
Kennzeichenleuchte

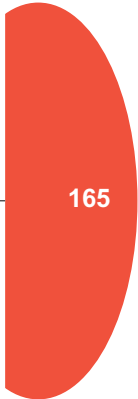

165

## 2.1 Feux arrière - Rear lamps - Heckleuchten

### Feux multifonction - Multifunction lamps - Mehrkammerleuchten

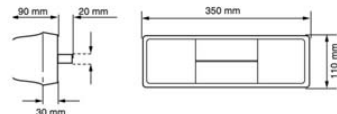

350 mm x 110 mm x 90 mm

**LA38**

E2 864  
E2 1051  
E2 1052

montage - mounting - Anbringung



**PE**  
arrière  
rear connector  
Anschlussstecker  
hinten



**EPP**

**138000**

gauche - left - links



**138000**

droit - right - rechts

### Pièces détachées - Spare part - Ersatzteile

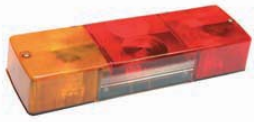

**EPP**

**038000**

gauche - left - links



**038000**

droit - right - rechts

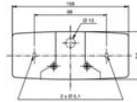

158 mm x 64 mm x 51 mm

**BBS 516**

E1 1559  
E1 53329

montage - mounting - Anbringung



Affectations constructeurs  
OE application  
Fahrzeugverwendung

**MANITOU p. 32**



**PF**  
arrière  
rear connector  
Anschlussstecker  
hinten



**500930**

gauche - left - links



**500940**

droit - right - rechts



**EPP**

**500930**

gauche - left - links



**500940**

**EPP**

droit - right - rechts

Fonctions supplémentaires  
Additional functions  
Zusatzfunktionen

**EPP**

Eclaireur de plaque  
Number plate lamp  
Kennzeichenleuchte

166

## 2.1 Feux arrière - Rear lamps - Heckleuchten

### Feux multifonction - Multifunction lamps - Mehrkammerleuchten

**LA25**

E2 92004 (LA25)  
E2 146 (LA25K)  
E2 462 (LA25K)  
E2 521 (LA25K)

montage - mounting - Anbringung

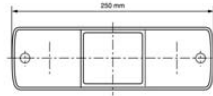

250 mm x 69,5 mm x 80 mm



**PE**  
arrière  
rear connector  
Anschlusstecker  
hinten

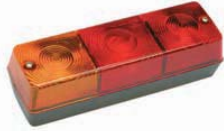

**125200**

gauche - left - links

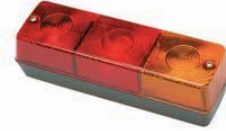

**125200**

droit - right - rechts



**K**

**125430**

gauche - left - links



**125430**

**K**

droit - right - rechts



**EPP**

**125100**

gauche - left - links



**125300**

**EPP**

droit - right - rechts



**K**

**EPP**

**125310**

gauche - left - links



**125350**

**K**

**EPP**

droit - right - rechts

Fonctions supplémentaires  
Additional functions  
Zusatzfunktionen

**K** Catadioptré  
Reflector  
Rückstrahler

**EPP** Eclairer de plaque  
Number plate lamp  
Kennzeichenleuchte

167



## 2.1 Feux arrière - Rear lamps - Heckleuchten

### Feux multifonction - Multifunction lamps - Mehrkammerleuchten

LA25

#### Pièces détachées - Spare part - Ersatzteile



025200

gauche - left - links



025200

droit - right - rechts



K

025210

gauche - left - links



025210

droit - right - rechts



EPP

025100

gauche - left - links



025300

droit - right - rechts



K

EPP

025110

gauche - left - links



025310

droit - right - rechts

E2 92004 (LA25)  
E2 146 (LA25K)  
E2 462 (LA25K)  
E2 521 (LA25K)

montage - mounting - Anbringung

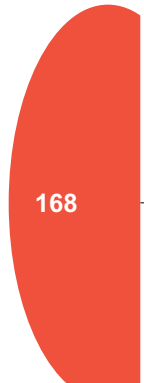

168

Fonctions supplémentaires  
Additional functions  
Zusatzfunktionen

K

Catadioptr  
Reflector  
Rückstrahler

EPP

Eclaireur de plaque  
Number plate lamp  
Kennzeichenleuchte

## 2.1 Feux arrière - Rear lamps - Heckleuchten

### Feux multifonction - Multifunction lamps - Mehrkammerleuchten

**2066**

E2 90116

montage - mounting - Anbringung

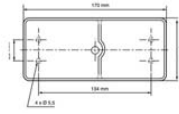

170 mm x 75 mm x 63 mm



PF  
arrière  
rear connector  
Anschlusstecker  
hinten



**20660617**

gauche - left - links



**20660617**

droit - right - rechts

### Pièces détachées - Spare part - Ersatzteile



**20661609**

gauche - left - links



**20661609**

droit - right - rechts

169

**2132**

E2 393  
E2 446

montage - assembly - montage

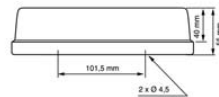
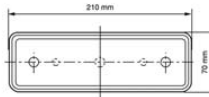

210 mm x 70 mm x 55 mm



PF  
arrière  
rear connector  
Anschlusstecker  
hinten



**21320601**

gauche - left - links



**21320601**

droit - right - rechts

## 2.1 Feux arrière - Rear lamps - Heckleuchten Feux multifonction - Multifunction lamps - Mehrkammerleuchten

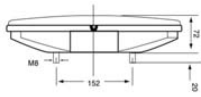

340 mm x 147 mm x 72 mm



EPP

688621

gauche - left - links



PF  
arrière  
rear connector  
Anschlusstecker  
hinten



688631

droit - right - rechts

688

E12 6065  
E12 7091

montage - mounting - Anbringung



### Pièces détachées - Spare part - Ersatzteile



688601

gauche - left - links



688601

droit - right - rechts

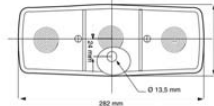
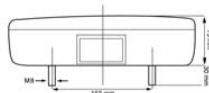

282 mm x 105 mm x 73 mm



EPP

680121

gauche - left - links



PF  
arrière  
rear connector  
Anschlusstecker  
hinten



680131

droit - right - rechts

680

E12 7128

montage - mounting - Anbringung



170

Fonctions supplémentaires  
Additional functions  
Zusatzfunktionen

EPP

Eclaireur de plaque  
Number plate lamp  
Kennzeichenleuchte

## 2.1 Feux arrière - Rear lamps - Heckleuchten

### Feux multifonction - Multifunction lamps - Mehrkammerleuchten

**LC3**



E2 05032



Faisceau p. 253  
 Harness p. 253  
 Anschlusskabel siehe S. 253

Position - Stop - Clignotant  
 Position lamp - Stop lamp - Flasher lamp  
 Schlussleuchte - Bremsleuchte -  
 Fahrtrichtungsanzeiger



Ø 122 mm x 52



LED 12-24V

<b>103000</b>	300 mm
<b>103070</b>	1500 mm



**AMP 1.5**  
 arrière  
 rear connector  
 Anschlussstecker  
 hinten



LED 12-24V

<b>103020</b>	300 mm
<b>103080</b>	1500 mm

**C166**

E2 113  
 E2 530  
 E2 621

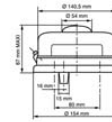

Ø 154 mm x 87 mm



**116600**

gauche - left - links



**PF**  
 arrière  
 rear connector  
 Anschlussstecker  
 hinten



**116600**



droit - right - rechts

### Pièces détachées - Spare part - Ersatzteile



**016600**

gauche - left - links



**016600**



droit - right - rechts

Fonctions supplémentaires  
 Additional functions  
 Zusatzfunktionen



**ECLAIREUR DE PLAQUE**  
 Number plate lamp  
 Kennzeichenleuchte

## 2.1 Feux arrière - Rear lamps - Heckleuchten

### Feux multifonction - Multifunction lamps - Mehrkammerleuchten

**LB21**

E12 7147



Ø 140 mm x 80 mm

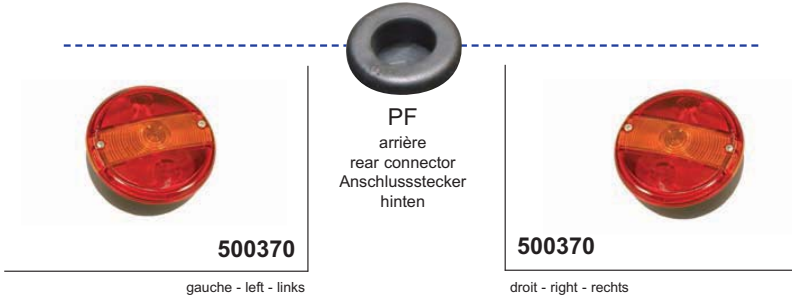

gauche - left - links

droit - right - rechts

**FRR**

E13 9657

Ø 140 mm x 80 mm

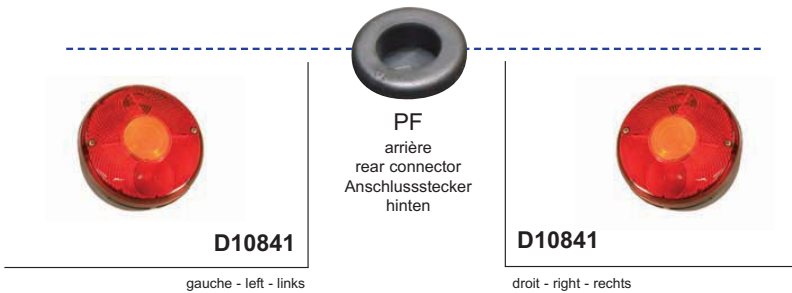

gauche - left - links

droit - right - rechts

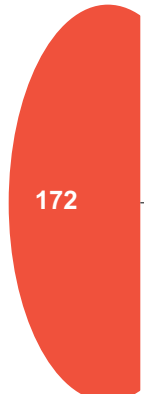

172

**FRC**

E20 02465

103 mm x 97 mm

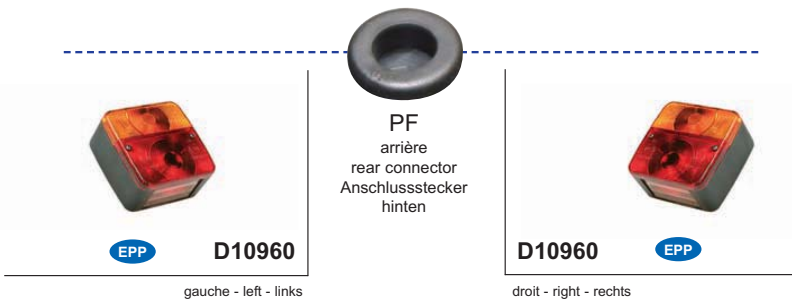

gauche - left - links

droit - right - rechts

Fonctions supplémentaires  
Additional functions  
Zusatzfunktionen

**EPP**

Eclaireur de plaque  
Number plate lamp  
Kennzeichenleuchte

## 2.1 Feux arrière - Rear lamps - Heckleuchten

### Feux monofonction - Monofunction lamps - Einzelfunktionsleuchten

#### LC1



E2 07177  
E2 07176



Faisceau p. 253  
Harness p. 253  
Anschlusskabel siehe S. 253

**Feu de brouillard**  
**Fog lamp**  
**Nebelschlussleuchte**

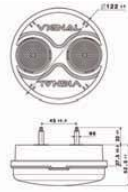

Ø 122 mm x 52



**AMP 1.5**  
arrière  
rear connector  
Anschlusstecker  
hinten

	LED 12-24V
<b>103030</b>	300 mm
<b>103090</b>	1500 mm

	LED 12-24V
<b>103040</b>	300 mm
<b>103100</b>	1500 mm

	LED 12-24V
<b>103050</b>	300 mm
<b>103110</b>	1500 mm

	LED 12-24V
<b>103060</b>	300 mm
<b>103120</b>	1500 mm

**Feu de recul**  
**Reverse lamp**  
**Rückfahrleuchte**

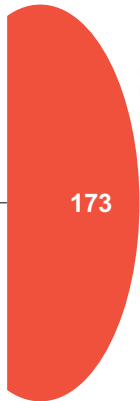

#### FM76

E2 136  
E2 78

montage - mounting - Anbringung

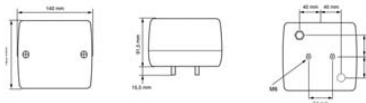

140 mm x 125 mm x 91,5 mm



**PE**  
arrière  
rear connector  
Anschlusstecker  
hinten

	<b>176000</b>	P21W
Feu de recul Reverse lamp Rückfahrleuchte		

	<b>176050</b>	P21W
Feu de brouillard Fog lamp Nebelschlussleuchte		

#### FRR

E13 697  
E13 698

Ø 140 mm x 80 mm



**PF**  
arrière  
rear connector  
Anschlusstecker  
hinten

	<b>D10840</b>	P21W
--	---------------	------

	<b>D10839</b>	P21W
--	---------------	------



## 2.1 Feux arrière - Rear lamps - Heckleuchten

### Feux monofonction - Monofunction lamps - Einzelfunktionsleuchten

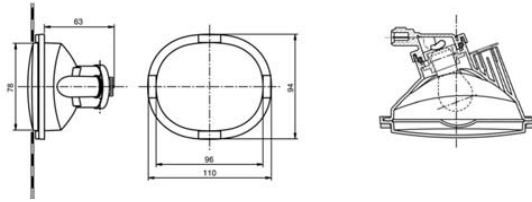

110 mm x 94 mm

**FM97**

E2 8035  
E2 9014  
E2 8003  
E2 8034  
E2 8004

montage - mounting - Anbringung

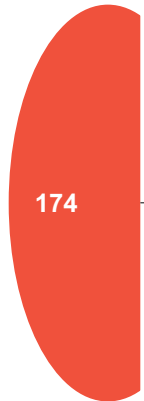

### Pièces détachées - Spare part - Ersatzteile



## 2.1 Feux arrière - Rear lamps - Heckleuchten

### Feux monofonction - Monofunction lamps - Einzelfunktionsleuchten

**FM91**

E2 92057  
E2 92058  
E2 92059  
E2 92060  
E2 92061  
E2 92062

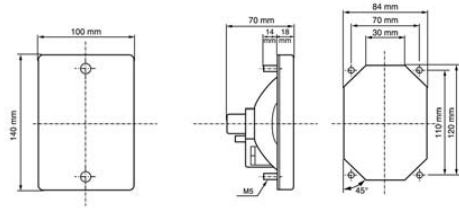

140 mm x 100 mm x 70mm

montage - mounting - Anbringung



**PE**  
arrière  
rear connector  
Anschlussstecker  
hinten



**191170** P21W

feu de recul  
Reverse lamp  
Rückfahrleuchte



**191140** R10W

feu de position  
Rear position lamp  
Schlussleuchte



**191160** P21W

Feu clignotant avant  
Front flasher lamp  
Vordere Blinkleuchte



**191150** P21W

feu clignotant arrière  
Rear flasher lamp  
Hinterer Fahrtrichtungsanzeiger



**191120** P21W

feu stop  
Stop lamp  
Bremsleuchte



**191110** P21W

feu de brouillard  
Fog lamp  
Nebelschlussleuchte



**191100** P21W

plafonnier  
Ceiling lamp  
Innenraumleuchte

175

## 2.1 Feux arrière - Rear lamps - Heckleuchten Eclaireurs de plaque - Number plate lamps - Kennzeichenleuchten

4030

E2 92025

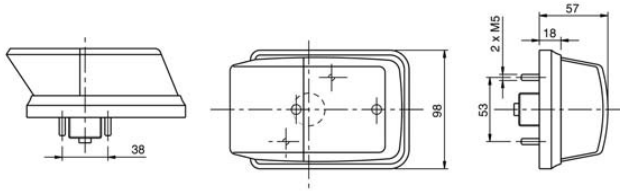

132 mm x 98 mm x 57 mm



**40300117** R5W-P21W

feu de brouillard  
Fog lamp  
Nebelschlussleuchte



**40300225** R5W-P21W

feu de recul  
Reverse lamp  
Rückfahrleuchte

BX868

E11 4249

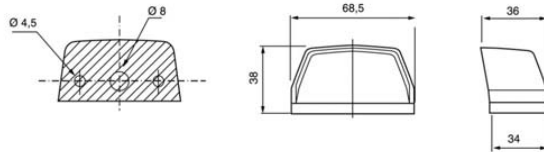

68,5 mm x 36 mm x 38 mm



**610091** C5W

176

## 2.1 Feux arrière - Rear lamps - Heckleuchten Eclaireurs de plaque - Number plate lamps - Kennzeichenleuchten

**EPP96**

E2 7001



montage - mounting - Anbringung



Affectations constructeurs  
OE application  
Fahrzeugverwendung

**RENAULT AGRI p. 35**

**RENAULT TRUCKS p. 36**

**p. 78**

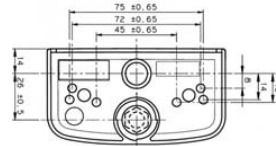
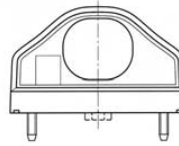
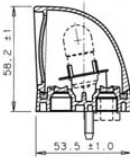

100 mm x 53,3 mm x 58,2 mm



**PF**  
arrière  
rear connector  
Anschlusstecker  
hinten



**196020**

R10W



**000176**

R10W

**Autoperforant pour raccordement  
sur câble plat**  
Click-in for flat cable  
Click-in-Anschluss für Flachkabel

**AP**

Exemple de montage p. 250  
Assembly suggestion p. 250  
Montagebeispiel siehe S. 250

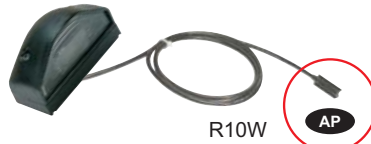

R10W

<b>D10502</b>	410 mm
<b>D11888</b>	1000 mm

177

**EPP98**

E2 7001



montage - mounting - Anbringung



Affectations constructeurs  
OE application  
Fahrzeugverwendung

**DAF TRUCKS p. 7**

**FODEN p. 13**

**RENAULT TRUCKS p. 36**

**VOLVO TRUCKS p. 73**

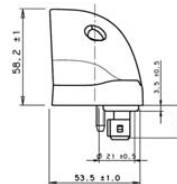
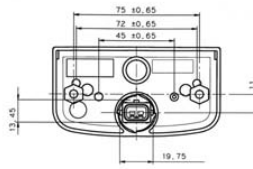
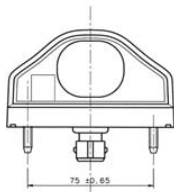

101 mm x 53,3 mm x 58,2 mm



**AMP JPT**  
arrière  
rear connector  
Anschlusstecker  
hinten



**196010**

R10W



Faisceau p. 255  
Harness p. 255  
Anschlusskabel siehe S. 255

## 2.2 Feux clignotants - Flasher lamps - Fahrtrichtungsanzeiger

### Face avant - Front face - Frontansicht

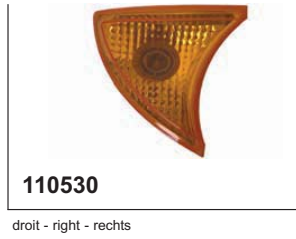

**C105**

E2 06018

Affectations constructeurs  
OE application  
Fahrzeugverwendung

**IVECO p. 23**

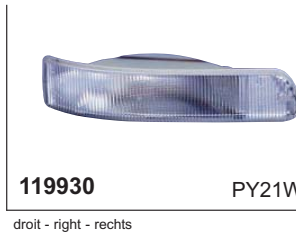
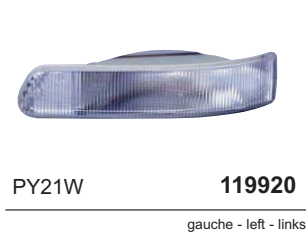

**C199**

E2 0050

Affectations constructeurs  
OE application  
Fahrzeugverwendung

**IVECO p. 23**



**C195**

E2 5117

Affectations constructeurs  
OE application  
Fahrzeugverwendung

**IRISBUS p. 16**



Connecteur  
Connector  
Steckverbindung

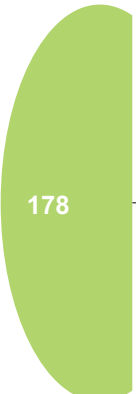

## 2.2 Feux clignotants - Flasher lamps - Fahrtrichtungsanzeiger

### Face avant - Front face - Frontansicht

**C194**

E2 5040

Affectations constructeurs  
OE application  
Fahrzeugverwendung

**RENAULT TRUCKS p. 36**



P21W

**119400**

gauche - left - links



**119410**

P21W

droit - right - rechts



**001606**

Connecteur  
Connector  
Steckverbindung

**C184**

E2 87712

Affectations constructeurs  
OE application  
Fahrzeugverwendung

**RENAULT TRUCKS p. 36**



**118440**

P21W



**001616**

179

**C181**

E2 92098

Affectations constructeurs  
OE application  
Fahrzeugverwendung

**IRISBUS p. 16**

**HEULIEZ p.14**

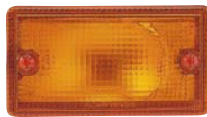

**118100**

P21W

**C180**

E2 92700

Affectations constructeurs  
OE application  
Fahrzeugverwendung

**RENAULT TRUCKS p. 36**



**118000**

P21W



**018006**

cabochon  
lens  
Lichtscheibe



## 2.2 Feux clignotants - Flasher lamps - Fahrtrichtungsanzeiger

### Face avant - Front face - Frontansicht

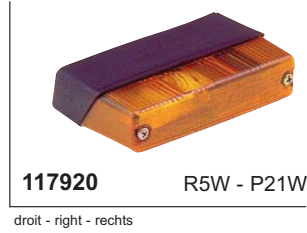
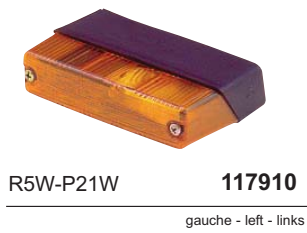

**C179**

E2166

Affectations constructeurs  
OE application  
Fahrzeugverwendung

**RENAULT TRUCKS p. 36**



**C177**

E2 91714

Affectations constructeurs  
OE application  
Fahrzeugverwendung

**RENAULT TRUCKS p. 36**

180



**1122**

E2 130  
E2 402  
E2 52

## 2.2 Feux clignotants - Flasher lamps - Fahrtrichtungsanzeiger

### Face avant - Front face - Frontansicht

1085

E2 5060

Affectations constructeurs  
OE application  
Fahrzeugverwendung

RENAULT TRUCKS p. 36

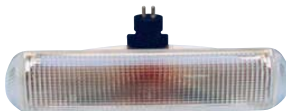

10850605 P21W

1085

E2 87002

Affectations constructeurs  
OE application  
Fahrzeugverwendung

RENAULT TRUCKS p. 36

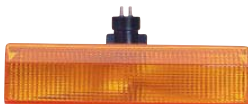

10850603 P21W

181

C178

E2 669



10640513 P21W

gauche - left - links



10640413 P21W

droit - right - rechts

BX816

E11 6219

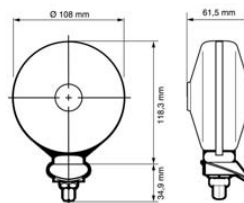

610050 P21W

## 2.2 Feux clignotants - Flasher lamps - Fahrtrichtungsanzeiger

### Face avant - Front face - Frontansicht

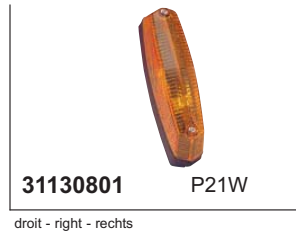
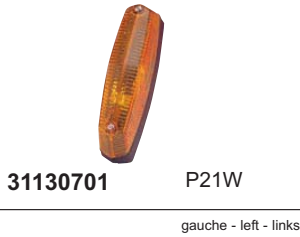

3113

E2 363

Affectations constructeurs  
OE application  
Fahrzeugverwendung

[RENAULT TRUCKS p. 36](#)

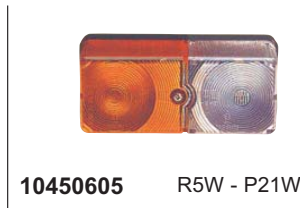
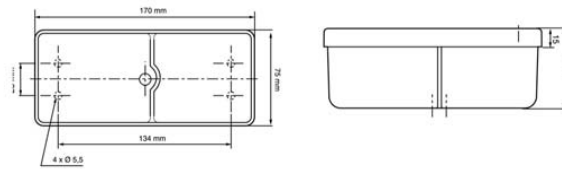

1045

E2 86038  
E2 90117

182

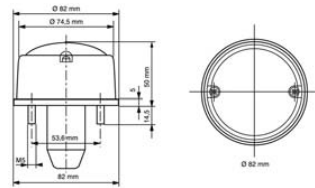

0204

E2 4136

## 2.2 Feux clignotants - Flasher lamps - Fahrtrichtungsanzeiger

### Face latérale - Side face - Seitenansicht

**SRD07**

E2 08028

Affectations constructeurs  
OE application  
Fahrzeugverwendung

**VOLVO p. 73**



**107000**  
LEDS 24V (VOLVO 82114506)

gauche - left - links



**107010**  
(VOLVO 82114500) LEDS 24V

droit - right - rechts



**107040**  
(VOLVO 82114504)

coque - cowl - schale  
gauche - left - links



**107050**  
(VOLVO 82114502)

coque - cowl - schale  
droit - right - rechts



183

**ICDL07**

E2 09025

Affectations constructeurs  
OE application  
Fahrzeugverwendung

**DAF p. 7**



**109010**

P21W

## 2.2 Feux clignotants - Flasher lamps - Fahrtrichtungsanzeiger

### Face latérale - Side face - Seitenansicht

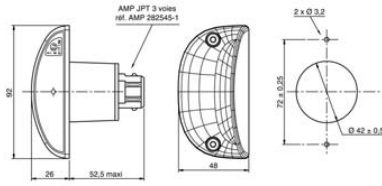

**ICDL94**

E2 5047 (R5W)  
E2 7139 (P21W)

Affectations constructeurs  
OE application  
Fahrzeugverwendung

**DAF p. 07**

**ERF p. 12**

**HEULIEZ p. 14**

**IRISBUS p. 16**

**NISSAN p. 34**

**RENAULT TRUCKS p. 36**

**VOLVO p. 73**



**FE85**

E2 86708  
E2 9033

Affectations constructeurs  
OE application  
Fahrzeugverwendung

**RENAULT TRUCKS p. 36**

184

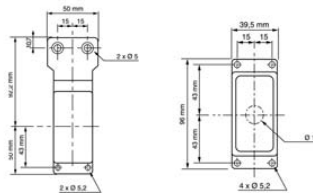

**FE87**

E2 4703



cabochon  
lens  
Lichtscheibe

## 2.2 Feux clignotants - Flasher lamps - Fahrtrichtungsanzeiger

Face latérale - Side face - Seitenansicht

**FE79**

E2 3703

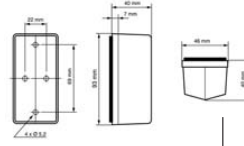

**179240**

2 x C5W



**179340**

2 x C5W

Pour presse-étoupe 000176  
For o-ring 000176  
für PG-Verschraubung Art-Nr. 000176



**079040**

cabochon  
lens  
Lichtscheibe



**000176**

**0207**

E2 109  
E2 111  
E2 112  
E2 219

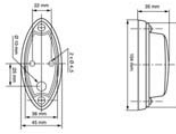

**02070605**

C5W

**FE81**

E2 90711

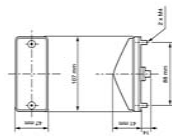

**181050**

T4W



**181070**

T4W

Version pétrolière  
Petroleum version  
für Tankfahrzeuge



**000086**



## 2.2 Feux clignotants - Flasher lamps - Fahrtrichtungsanzeiger

### Face arrière - Rear face - Heckansicht

0204

E2 4136

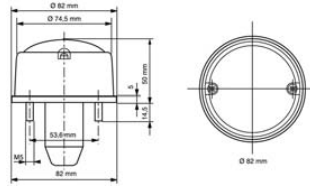

02040601

P21W



02041601

cabochon  
lens  
Lichtscheibe

0148

E2 87078

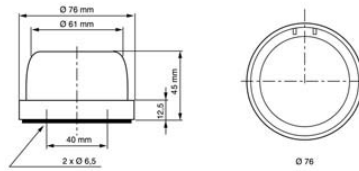

01442621

P21W



01487801

cabochon  
lens  
Lichtscheibe

186

## 2.3 Feux de position - Position lamps - Positionsleuchten

### Face avant - Front face - Frontansicht

**FE04**

E2 05010  
SAE P2



montage - mounting - Anbringung



Version ambre p. 197  
Amber version p. 197  
Ausführung in gelb siehe S. 197

Version rouge p. 207  
Red version p. 207  
Ausführung in rot siehe S. 207

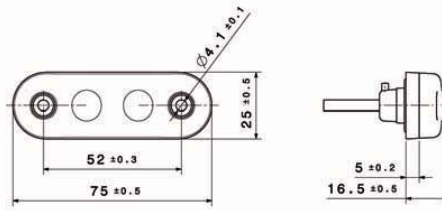

75 mm x 25 mm x 16,5 mm



LEDS-24V

<b>104290</b>	500 mm
<b>104300</b>	1500 mm
<b>104310</b>	5000 mm

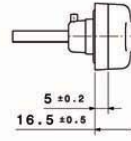

5 ± 0.2  
16.5 ± 0.5



**D10132** 200 mm

AP

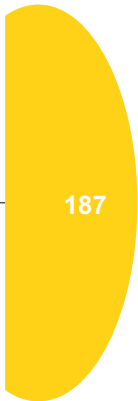

187

SAE P2



200 mm



AP

LEDS-24V

**104510** 300 mm

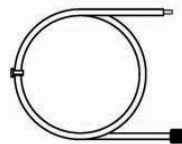
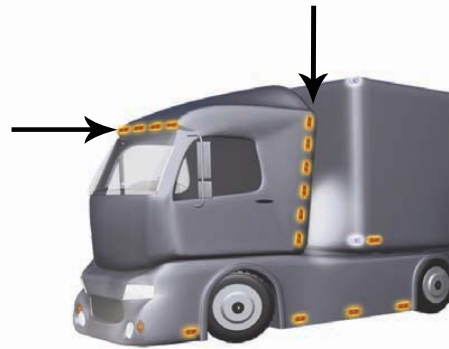

**D11268**

16 m

Fils nus  
Naked cable extremity  
Kabellitze

Câble plat - Flat cable - Flachkabel

AP

Autoperforant pour raccorde-  
ment sur câble plat  
Click-in for flat cable  
Click-in -Anschluss für  
Flachkabel

### 2.3 Feux de position - Position lamps - Positionsleuchten Face avant - Front face - Frontansicht

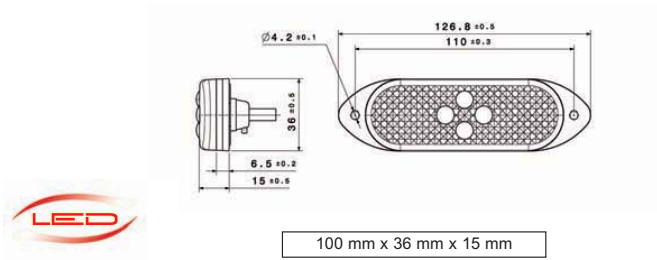

100 mm x 36 mm x 15 mm

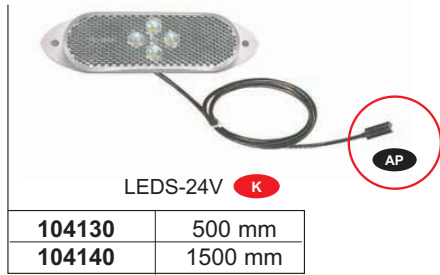

<b>104130</b>	500 mm
<b>104140</b>	1500 mm



<b>104520</b>	1000 mm
---------------	---------

**SMD04**

E2 05022



montage - mounting - Anbringung



**Version ambre p. 197**  
Amber version p. 197  
Ausführung in gelb siehe S. 197

**Version rouge p. 208**  
Red version p. 208  
Ausführung in rot siehe S. 208

Exemple de montage p. 250  
Assembly suggestion p. 250  
Montagebeispiel siehe S. 250

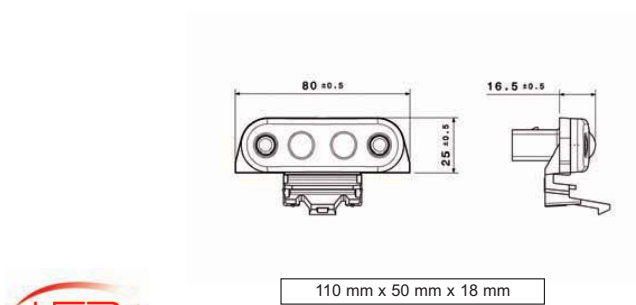

110 mm x 50 mm x 18 mm



**FE07**

E2 05010



montage - mounting - Anbringung



Affectations constructeurs  
OE application  
Fahrzeugverwendung

**VOLVO p. 73**

188



**207000**  
LEDS 24V (VOLVO 82116545)



**207010**  
(VOLVO 21087346) LEDS 24V



**207020**  
LEDS 24V (VOLVO 21087347)

Fonctions supplémentaires  
Additional functions  
Zusatzfunktionen



**Catadioptr**  
Reflector  
Rückstrahler



**Autoperforant pour**  
raccordement sur  
câble plat  
Click-in for flat cable  
Click-in-Anschluss  
für Flachkabel

## 2.3 Feux de position - Position lamps - Positionsleuchten

### Face avant - Front face - Frontansicht

#### SMD98

E2 04010



montage - mounting - Anbringung



Version ambre p. 198  
Amber version p. 198  
Ausführung in gelb siehe S. 198

Version rouge p. 208  
Red version p. 208  
Ausführung in rot siehe S. 208

Fonctions supplémentaires  
Additional functions  
Zusatzfunktionen

**K**  
Catadioptré  
Reflector  
Rückstrahler

**AP**  
Autoperforant pour  
raccordement sur  
câble plat  
Click-in for flat cable  
Click-in-Anschluss  
für Flachkabel

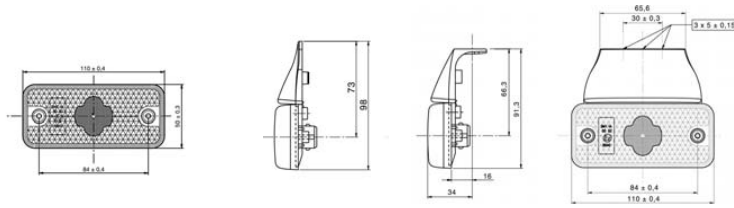

110 mm x 50 mm x 18 mm



**AMP JPT**  
Arrière  
Rear connector  
Anschlussstecker  
hinten



**NEW** 198690 LEDS-12V **K**

198660 LEDS-24V **K**



LEDS-24V **K**

D10500	500 mm
D11399	1500 mm



001696



001716

#### FE94/98

E2 4088  
E2 4089 (K)



montage - mounting - Anbringung



Version ambre p. 199  
Amber version p. 199  
Ausführung in gelb siehe S. 199

Version rouge p. 209  
Red version p. 209  
Ausführung in rot siehe S. 209

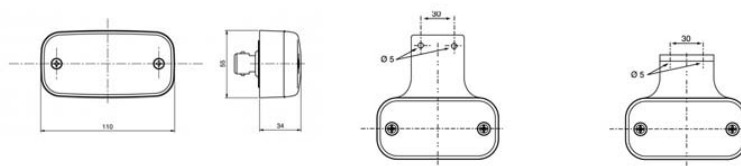

110 x 55 mm x 34 mm



**AMP JPT**  
Arrière  
Rear connector  
Anschlussstecker  
hinten



198040 T4W



198050 T4W **K**

## 2.3 Feux de position - Position lamps - Positionsleuchten

### Face avant - Front face - Frontansicht



**PE**  
arrière  
rear connector  
Anschlussstecker  
hinten

**FE94/98**

E2 4088  
E2 4089 (K)

 ADR

montage - mounting - Anbringung





**194190** T4W



**194130** T4W K



**194140** T4W K



**194150** T4W K

### Pièces détachées - Spare part - Zubehör



**094046**



**094036** K



**001596**



**001586**



**000176**

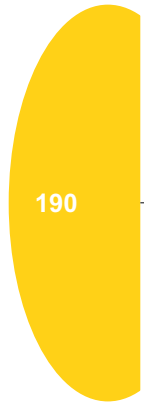

Faisceau p. 255  
Harness p. 255  
Anschlusskabel siehe S. 255

**Version ambre p. 199**  
**Amber version p. 199**  
**Ausführung in gelb siehe S. 199**

**Version rouge p. 209**  
**Red version p. 209**  
**Ausführung in rot siehe S. 209**

Fonctions supplémentaires  
Additional functions  
Zusatzfunktionen

K **Catadiopre**  
**Reflector**  
**Rückstrahler**

## 2.3 Feux de position - Position lamps - Positionsleuchten

### Face avant - Front face - Frontansicht

**FE02**

E2 7102

montage - mounting - Anbringung

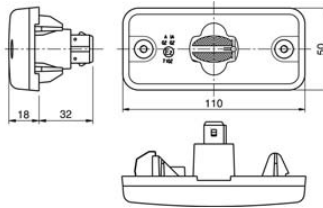

110 mm x 50 mm x 18 mm

**102200**

W5W **K**

**001726**

Clippé - Clipped - Clip-Befestigung

**FPL93**

E2 7102

montage - mounting  
Anbringung

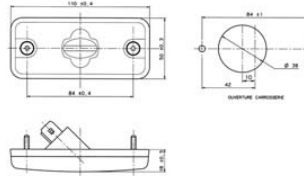

110 mm x 50 mm x 18 mm

**193200**

W5W **K**

**001726**

Vissé - Screwed - Geschraubt

191



Faisceau p. 255  
Harness p. 255  
Anschlusskabel siehe S. 255

Version ambre p. 201  
Amber version p. 201  
Ausführung in gelb siehe S. 201

**SM84B**

E2 90123

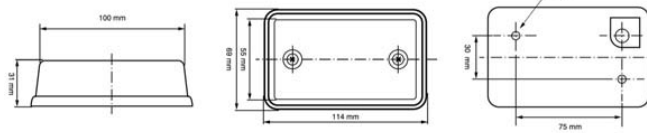

114 mm x 69 mm x 31 mm

Fonctions supplémentaires  
Additional functions  
Zusatzfunktionen

**Catadioptr**  
Reflector  
Rückstrahler

**K**

**02233060**

C5W **K**

**2233065**

**K**

Cabochon - Lens - Lichtscheibe



### 2.3 Feux de position - Position lamps - Positionsleuchten

Face avant - Front face - Frontansicht

PLR272

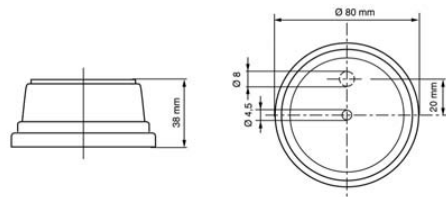

Ø 80 mm x 38 mm

E1 21633



Cabochon - Lens - Lichtscheibe

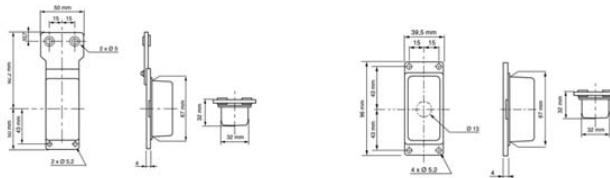

96 / 142 mm x 39 mm x 32 mm

FE87

E2 86710



Cabochon - Lens - Lichtscheibe



Cabochon - Lens - Lichtscheibe

Fonctions supplémentaires  
Additional functions  
Zusatzfunktionen

**K**

**Catadioptré**  
**Reflector**  
**Rückstrahler**

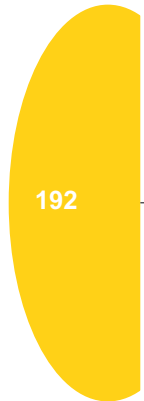

### 2.3 Feux de position - Position lamps - Positionsleuchten Face avant - Front face - Frontansicht

**FE79**

E2 3704

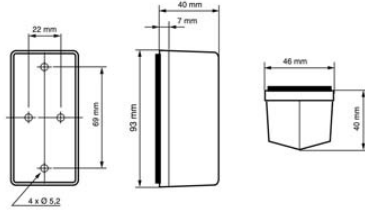

93 mm x 46 mm x 40 mm



**179220**

2 x C5W



**179320**

2 x C5W

Pour presse-étoupe 000176  
For o-ring 000176  
für PG-Verschraubung Art-Nr. 000176



**079020**

Cabochoon - Lens - Lichtscheibe



**000176**

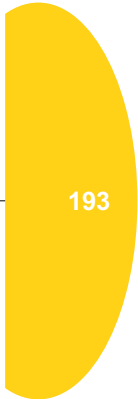

193

**0207**

E2 727

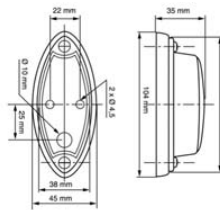

104 mm x 45 mm x 35 mm



**02070637**

C5W



**02077011**

Cabochoon - Lens - Lichtscheibe

## 2.3 Feux de position - Position lamps - Positionsleuchten

### Face avant - Front face - Frontansicht

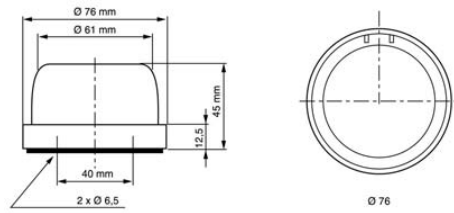

Ø 76 mm x 45 mm

0144

E2 87072

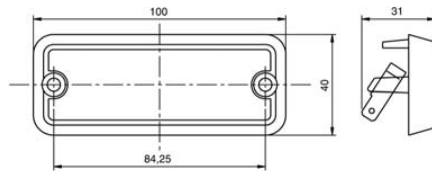

100 mm x 40 mm x 10 mm

671

E1 21628



Affectations constructeurs  
OE application  
Fahrzeugverwendung

**MERCEDES p. 33**

194

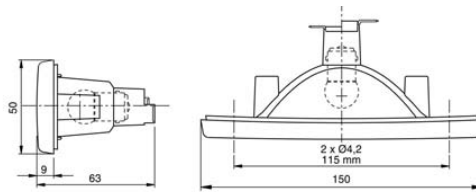

150,5 mm x 50 mm x 9 mm

FG82

E2 88042

Affectations constructeurs  
OE application  
Fahrzeugverwendung

**RENAULT TRUCKS p. 36**



## 2.3 Feux de position - Position lamps - Positionsleuchten

### Face avant - Front face - Frontansicht

**FE95**

E2 5052

Affectations constructeurs  
OE application  
Fahrzeugverwendung

**HEULIEZ p. 14**

**IRISBUS p. 16**

**RENAULT TRUCKS p. 36**

**VOLVO p. 73**

140 mm x 65 mm x 30.5 mm



**195010**

R5W

Semelle plate  
Flat gasket  
Flache Sockeldichtung



**195030**

R5W

Semelle galbée  
Curved gasket  
Gewölbte Sockeldichtung

**FE85**

E2 9037

Affectations constructeurs  
OE application  
Fahrzeugverwendung

**HEULIEZ p. 14**

**IRISBUS p. 16**

**RENAULT TRUCKS p. 36**

175 mm x 68 mm x 52 mm



**185010**

R5W

Semelle galbée - Curved gasket - Gewölbte Sockeldichtung



**185020**

R5W

Semelle plate - Flat gasket - Flache Sockeldichtung

195

**FE86**

E2 87714

220,5 mm x 72,5 mm x 66 mm



**186030**

R5W

gauche - left - links



**186040**

R5W

droit - right - rechts

### 2.3 Feux de position - Position lamps - Positionsleuchten Face avant - Front face - Frontansicht

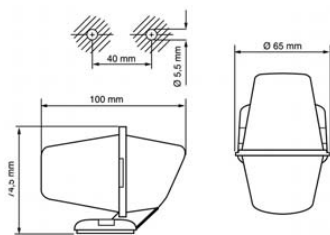

100 mm x 65 mm x 74,5 mm

FE80

E2 314  
E2 915  
E2 781



#### Pièces détachées - Spare part - Zubehör

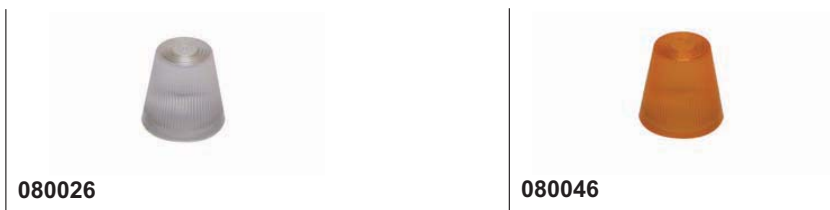

196

### 2.3 Feux de position - Position lamps - Positionsleuchten Face latérale - Side face - Seitenansicht

#### SMD04

E2 05021



montage - mounting - Anbringung



Version cristal p. 188  
White version p. 188  
Ausführung in weiss siehe S. 188

Version rouge p. 208  
Red version p. 208  
Ausführung in rot siehe S. 208

Exemple de montage p. 250  
Assembly suggestion p. 250  
Montagebeispiel siehe S. 250

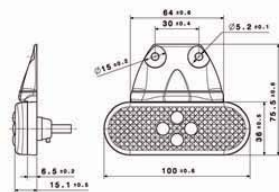

100 mm x 36 mm x 15 mm

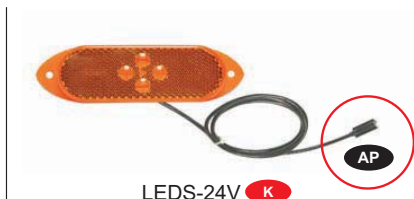
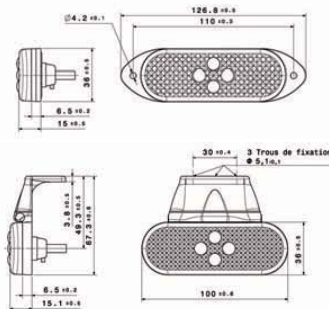

LEDS-24V **K**

104090	500 mm
104100	1500 mm



LEDS-24V **K**

104210	500 mm
104220	1500 mm



LEDS-24V **K**

104250	500 mm
104260	1500 mm



LEDS-24V **K**

D12699	1000 mm
--------	---------

197

#### SMD00

E2 1295

montage - mounting - Anbringung



Affectations constructeurs  
OE application  
Fahrzeugverwendung

**VOLVO p. 73**

Fonctions supplémentaires  
Additional functions  
Zusatzfunktionen

**K** Catadioptr  
Reflector  
Rückstrahler

**AP** Autoperforant pour raccorde-  
ment sur câble plat  
Click-in for flat cable  
Click-in-Anschluss für  
Flachkabel

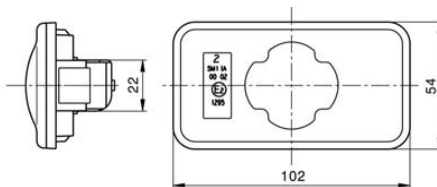

102 mm x 54 mm



198620 LEDS-24V **K**



001766	600 mm
--------	--------

Adaptateur - Adaptor - Adapterkabel



## 2.3 Feux de position - Position lamps - Positionsleuchten

### Face latérale - Side face - Seitenansicht

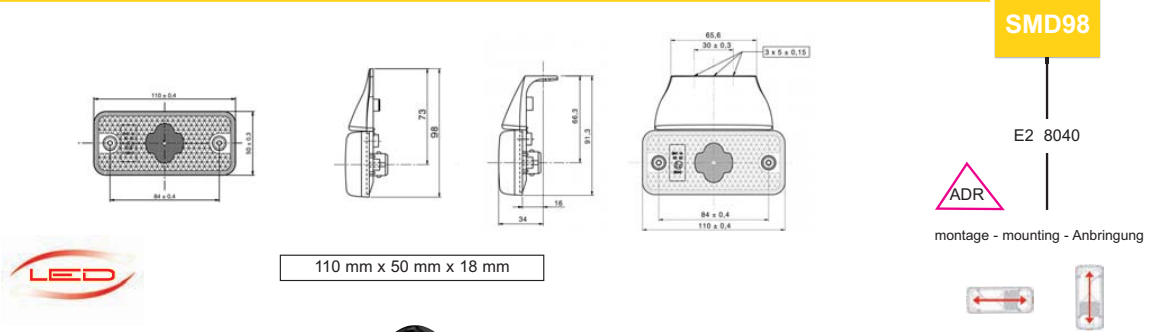

110 mm x 50 mm x 18 mm



**AMP JPT**  
Arrière  
Rear connector  
Anschlusstecker  
hinten



<b>198510</b>	4 x LEDS-12V
<b>198520</b>	4 x LEDS-24V



**198650** 2 x LEDS-24V **K**

Version cristal p. 189  
White version p. 189  
Ausführung in weiss siehe S. 189

Version rouge p. 208  
Red version p. 208  
Ausführung in rot siehe S. 208



**198530** 2 x LEDS-24V **K**



**198540** 2 x LEDS-24V **K**



**D12867** 2 x LEDS-24V **K**



4 x LEDS-24V **K**

<b>D10493</b>	500 mm
<b>D10496</b>	1500 mm



2 x LEDS-24V **K**

<b>D10494</b>	500 mm
<b>D10497</b>	1500 mm



2 x LEDS-24V **K**

<b>D10495</b>	500 mm
<b>D10498</b>	1500 mm



Faisceau p. 255  
Harness p. 255  
Anschlusskabel siehe S. 255



**001696**



**001716**

Fonctions supplémentaires  
Additional functions  
Zusatzfunktionen

**K**  
Catadioptr  
Reflector  
Rückstrahler

**AP**  
Autoperforant pour  
raccordement sur  
câble plat  
Click-in for flat cable  
Click-in-Anschluss  
für Flachkabel

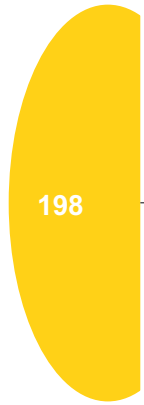

198

### 2.3 Feux de position - Position lamps - Positionsleuchten Face latérale - Side face - Seitenansicht

**FE94/98**

E2 4092  
E2 4093 (K)



montage - mounting - Anbringung

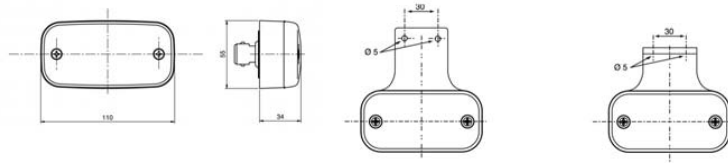

110 mm x 55 mm x 34 mm

Version cristal p. 189  
White version p. 189  
Ausführung in weiss siehe S. 189

Version rouge p. 209  
Red version p. 209  
Ausführung in rot siehe S. 209



**AMP JPT**  
Arrière  
Rear connector  
Anschlusstecker  
hinten

**198010** T4W **K**



**198020** T4W **K**



**198030** T4W **K**



199



**PE**  
arrière  
rear connector  
Anschlusstecker  
hinten

**194070** T4W



**194010** T4W **K**



**194080** T4W



**194020** T4W **K**



**194090** T4W



**194030** T4W **K**



Faisceau p. 255  
Harness p. 255  
Anschlusskabel siehe S. 255

Fonctions supplémentaires  
Additional functions  
Zusatzfunktionen

**K** Catadioptr  
Reflector  
Rückstrahler

## 2.3 Feux de position - Position lamps - Positionsleuchten

Face latérale - Side face - Seitenansicht

### Pièces détachées - Spare part - Zubehör

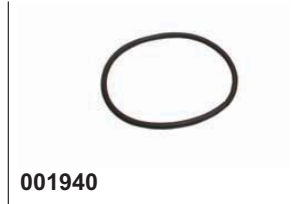

**FE94/98**

E2 4092  
E2 4093 (K)



montage - mounting - Anbringung



Version cristal p. 189  
White version p. 189  
Ausführung in weiss siehe S. 189

Version rouge p. 209  
Red version p. 209  
Ausführung in rot siehe S. 209

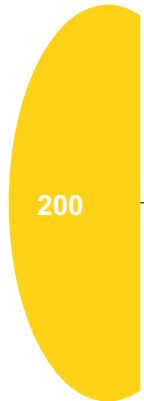

Fonctions supplémentaires  
Additional functions  
Zusatzfunktionen

**K** Catadioptré  
Reflector  
Rückstrahler

## 2.3 Feux de position - Position lamps - Positionsleuchten

### Face latérale - Side face - Seitenansicht

**FPL93**

E2 4054



montage - montaggio - montaje



Version cristal p. 191  
White version p. 191  
Ausführung in weiss siehe S. 191



Faisceau p. 255  
Harness p. 255  
Anschlusskabel siehe S. 255

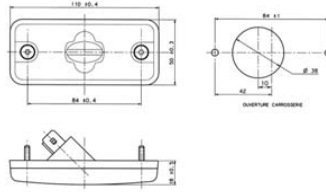

110 mm x 50 mm x 18 mm



SUPERSEAL

**193170**

W5W **K**



**001916**

SUPERSEAL



AMP JPT

**193020**

W5W **K**



AMP JPT

**193280**

W5W **K**



**001716**



**001726**

AMP JPT

201

**672**

E9 1084

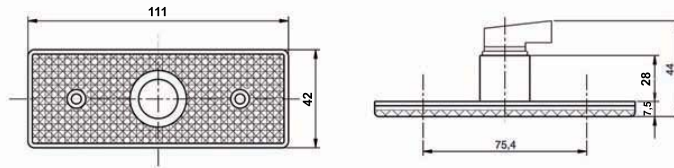

111 mm x 42 mm x 44 mm



**672410**

W5W **K**

Fonctions supplémentaires  
Additional functions  
Zusatzfunktionen

**K**

Catadioptr  
Reflector  
Rückstrahler

### 2.3 Feux de position - Position lamps - Positionsleuchten

#### Face latérale - Side face - Seitenansicht

SM84

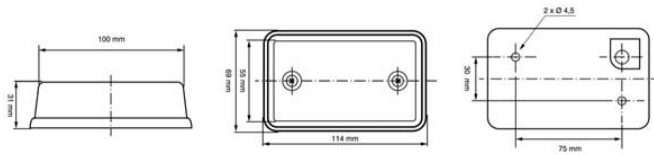

E2 90123

114 mm x 69 mm x 31 mm



02233050

C5W



2233025



Cabochon - Lens - Lichtscheibe

Fonctions supplémentaires  
Additional functions  
Zusatzfunktionen

**Catadioptré**  
**Reflector**  
**Rückstrahler**



FE87

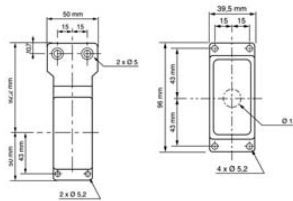

E2 4701



187140

C5W



187760

C5W



087040

Cabochon - Lens - Lichtscheibe

202

FE88

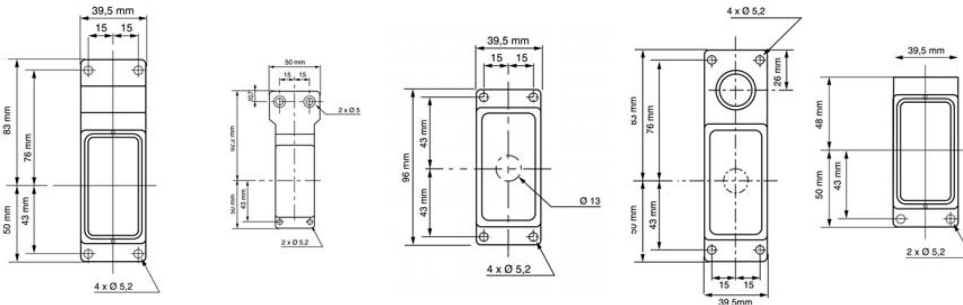

E2 88714



188010

C5W



188710

C5W

### 2.3 Feux de position - Position lamps - Positionsleuchten

Face latérale - Side face - Seitenansicht

**FE88**

E2 88714

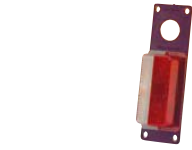

**188310** C5W

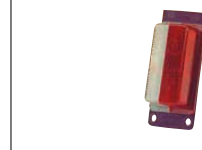

**188610** C5W

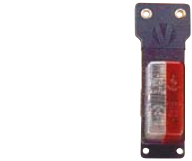

**188110** C5W



**088010**

Cabochon - Lente - Tulipa

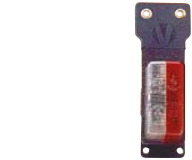

**188210** C5W



**000176**

Pour presse-étoupe 000176  
For o-ring 000176  
für PG-Verschraubung Art-Nr. 000176

203

**FE79**

E2 4702  
E2 92702

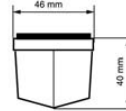
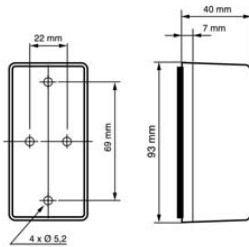

**179240** 2 x C5W



**179340** 2 x C5W

Pour presse-étoupe 000176  
For o-ring 000176  
für PG-Verschraubung Art-Nr. 000176



**179210** 2 x C5W



**179310** 2 x C5W

Pour presse-étoupe 000176  
For o-ring 000176  
für PG-Verschraubung Art-Nr. 000176

### 2.3 Feux de position - Position lamps - Positionsleuchten Face latérale - Side face - Seitenansicht

FE79



Pour presse-étoupe 000176  
For o-ring 000176  
für PG-Verschraubung Art-Nr. 000176



Cabochoon - Lens - Lichtscheibe



Cabochoon - Lens - Lichtscheibe

FE81

107 mm x 47 mm x 41 mm



E2 193

204

3013

Ø 76 x 45 mm



Cabochoon - Lens - Lichtscheibe

FEA801

98 mm x 39 mm x 171 mm

Ø 54 mm



E2 90715





### 2.3 Feux de position - Position lamps - Positionsleuchten Face latérale - Side face - Seitenansicht

#### DXLC8

E2 07092

montage - montaggio - montaje



**D13034** 500 mm  
gauche - left - links



**D13035** 500 mm  
droit - right - rechts



**D12712** 300 mm  
gauche - left - links



**D12711** 300 mm  
droit - right - rechts



#### DX

E2 07092



**D12430** W5W



**D12473**



**D12429** 1500 mm W5W



**D12428** 1400 mm W5W



**D12471**



**D12472** 1500 mm

#### DX

E11 10532



147 mm x 100 mm



LED -12/24V  
**D12208** 1750 mm

119 mm x 100 mm



LED -12/24V  
**D12209** 1750 mm

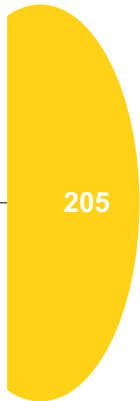



205

### 2.3 Feux de position - Position lamps - Positionsleuchten

Face latérale - Side face - Seitenansicht

67 mm x 100 mm	49 mm x 110 mm	<b>DX</b>
		
LED -12/24V	LED -12/24V	E11 10532
<b>D12210</b>   1750 mm	<b>D12211</b>   1750 mm	

95 mm x 50 mm x 191 mm	95 mm x 50 mm x 191 mm	<b>DX</b>
		
<b>D10642</b>   W5W	<b>D10643</b>   W5W	E2 10035
		

	
<b>D10800</b>   R5W	<b>610080</b>   R5W

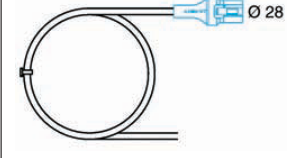
		<b>NEW</b>
<b>D13277</b>   350 mm	<b>D11147</b>   500 mm	

Ø 54 mm	
	
<b>611010</b>	<b>611020</b>
	
<b>D10503</b>   600 mm	<b>D11796</b>   1500 mm

	
<b>D11797</b>   3000 mm	<b>D11899</b>   500 mm

Pour module de jonction ref. 175020 p. 251  
For junction box ref.175020 p. 251  
für Verteilerdose Art.-Nr. 175020 S. 251

Pour repiquage sur feu arrière LC8 p. 147  
To plug in LC8 rear lamp p. 147  
Zum direkten Anschluss an die Heckleuchte LC8 S. 147

**AP** Autoperforant pour raccordement sur câble plat  
Click-in for flat cable  
Click-in-Anschluss für Flachkabel

Câblage remorque p. 249  
Trailers harnesses p. 249  
Verkabelung für Anhänger/Auflieger  
siehe S. 249

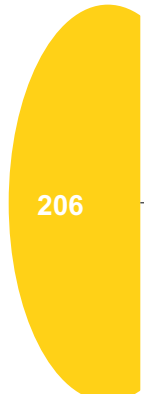

206

## 2.3 Feux de position - Position lamps - Positionsleuchten

### Face arrière - Rear face - Heckansicht

FE04

E2 05011



montage - mounting - Anbringung



Version cristal p. 187  
White version p. 187  
Ausführung in weiss siehe S. 187

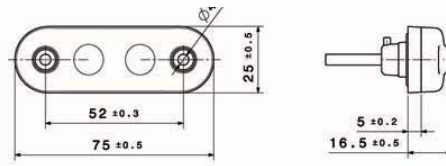

75 mm x 25 mm x 16,5 mm



LEDS-24V

104330	500 mm
104340	1500 mm
104360	5000 mm

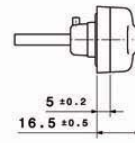

5 ± 0.2  
16.5 ± 0.5



D10132 200 mm

### Les + des feux à LED - The + of LED lamps - Vorteile von LED-Leuchten

#### Consommation - Consumption - Energieverbrauch

$$\begin{aligned}
 &10 \times \text{[Orange lamp]} + 2 \times \text{[Grey lamp]} + 2 \times \text{[Red lamp]} = 56W \\
 &10 \times \text{[LED lamp]} + 2 \times \text{[LED lamp]} + 2 \times \text{[LED lamp]} = 16W
 \end{aligned}$$

#### Etanchéité - Watertightness/Sealing - Dichtigkeit

- Connecteur soudé - Welded connector - Verschweisster Anschluss
- Câble surmoulé - Overmoulded cable - Eingegossenes Anschlusskabel

#### Compacité - Compactness - Kompakte Abmessungen

- FE04: 75mm x 25mm x 16,5mm
- SMD04: 126,8mm x 36mm x 15mm

Autoperforant pour raccordement sur câble plat  
Click-in for flat cable  
Click-in-Anschluss für Flachkabel

AP

## 2.3 Feux de position - Position lamps - Positionsleuchten

### Face arrière - Rear face - Heckansicht

**LED**

126,8 mm x 36 mm x 15 mm

LEDS-24V **K** **AP**

Exemple de montage p. 250  
Assembly suggestion p. 250  
Montagebeispiel siehe S. 250

<b>104170</b>	500 mm
<b>104180</b>	1500 mm

**SMD04**

E2 05023



montage - mounting - Anbringung



Version cristal p. 188  
White version p. 188  
Ausführung in weiss siehe S. 188

Version ambre p. 197  
Amber version p. 197  
Ausführung in gelb siehe S. 197

**LED**

110 mm x 50 mm x 18 mm

AMP JPT  
Arrière  
Rear connector  
Anschlussstecker  
hinten

LEDS-24V **K** **AP**

<b>D11400</b>	1500 mm
<b>D10499</b>	3500 mm

**SMD98**

E2 2065



montage - mounting - Anbringung



Version cristal p. 189  
White version p. 189  
Ausführung in weiss siehe S. 189

Version ambre p. 198  
Amber version p. 198  
Ausführung in gelb siehe S. 198

208

**001696**

**001716**

Fonctions supplémentaires  
Additional functions  
Zusatzfunktionen

**K**  
Catadioptr  
Reflector  
Rückstrahler

**AP**  
Autoperforant pour  
raccordement sur  
câble plat  
Click-in for flat cable  
Click-in-Anschluss  
für Flachkabel

## 2.3 Feux de position - Position lamps - Positionsleuchten

### Face arrière - Rear face - Heckansicht

**FE94/98**

E2 4090  
E2 4091 (K)



montage - mounting - Anbringung



Version cristal p. 189  
White version p. 189  
Ausführung in weiss siehe S. 189

Version ambre p. 199  
Amber version p. 199  
Ausführung in gelb siehe S. 199

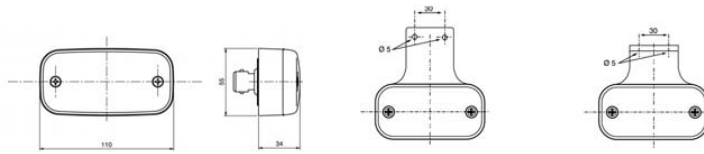

110 mm x 55 mm x 34 mm



**AMP JPT**  
Arrière  
Rear connector  
Anschlusstecker  
hinten



**PE**  
arrière  
rear connector  
Anschlusstecker  
hinten



Faisceau p. 255  
Harness p. 255  
Anschlusskabel siehe S. 255

Fonctions supplémentaires  
Additional functions  
Zusatzfunktionen

**K** **Catadioptr**  
**Reflector**  
**Rückstrahler**

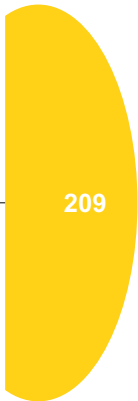

### 2.3 Feux de position - Position lamps - Positionsleuchten

Face arrière - Rear face - Heckansicht

SM84

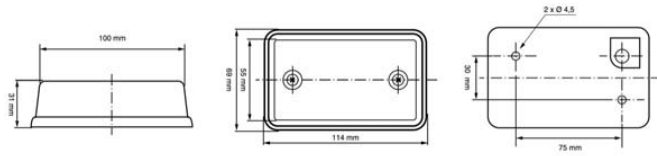

E2 896

114 mm x 69 mm x 31 mm



02233070

C5W

K

2233073

K

Cabochoon - Lens - Lichtscheibe

FE87

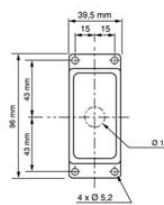
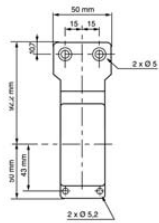

E2 86711

210

142/96 mm x 50/39 mm x 32 mm

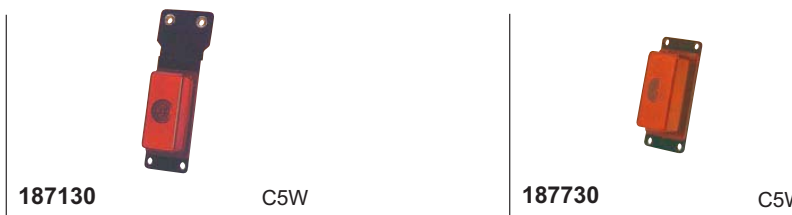

187130

C5W

187730

C5W



087030

Cabochoon - Lens - Lichtscheibe

Fonctions supplémentaires  
Additional functions  
Zusatzfunktionen

**K** Catadioptr  
Reflector  
Rückstrahler

## 2.3 Feux de position - Position lamps - Positionsleuchten

### Face arrière - Rear face - Heckansicht

**FE79**

E2 2785

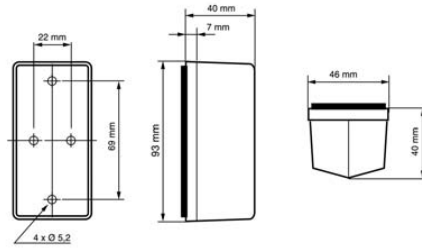

93 mm x 46 mm x 32 mm



**0207**

E2 219

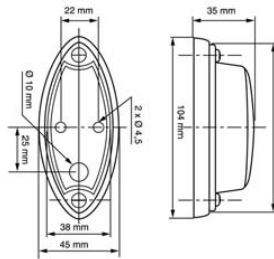

104 mm x 45 mm x 35 mm



**0149**

E2 97073

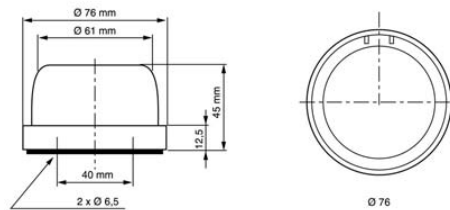

Ø 76 mm x 45 mm





### 2.3 Feux de position - Position lamps - Positionsleuchten Face arrière - Rear face - Heckansicht

0204

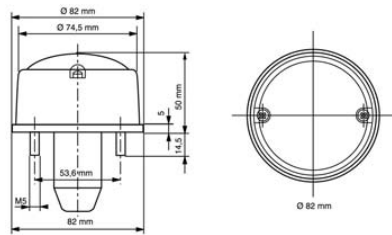

E2 2121

Ø 82 mm x 50 mm



FE85

175 mm x 68 mm x 52 mm

E2 9036



FE95

140 mm x 65 mm x 30,5 mm

E2 5126



Affectations constructeurs  
OE application  
Fahrzeugverwendung

HEULIEZ p. 14

IRISBUS p. 16

## 2.4 Produits complémentaires - Complementary products - Ergänzende Produkte Signalisation passive - Warning products - Warnmarkierungen

CA

### Métallique - Metal - Metall

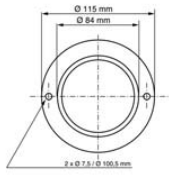

Ø 115 mm



46270601

### Plastique - Plastic housing - Kunststoffgehäuse

Ø 60 mm

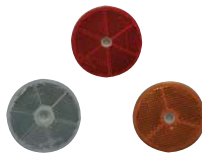

	620066
	620046
	620056

Adhésif - Adhesive - Selbstklebend

90 mm x 39 mm

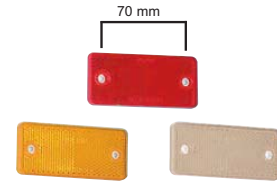

	624036
	624016
	624026

Adhésif - Adhesive - Selbstklebend

Ø 80 mm

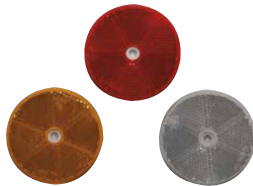

	620246
	620226
	620236

Adhésif - Adhesive - Selbstklebend

105 mm x 45 mm



	240366
	240346
	240356

Adhésif - Adhesive - Selbstklebend

64 mm x 40 mm



45210606

Adhésif - Adhesive - Selbstklebend

213

**2.4 Produits complémentaires - Complementary products - Ergänzende Produkte**  
**Signalisation passive - Warning products - Warnmarkierungen**

CA

**Plastique - Plastic housing - Kunststoffgehäuse**

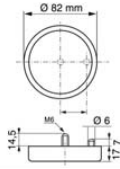

Ø 82 mm - M6



46090601

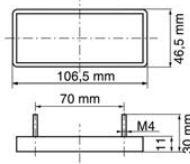

105 mm x 45 mm - M4



	241366
	241346
	241356

CT

159 mm x 159 mm x 159 mm



623016

168 mm x 168 mm x 168 mm



46120601

214

P30

420 mm x 420 mm x 420 mm



D10596

## 2.4 Produits complémentaires - Complementary products - Ergänzende Produkte Signalisation passive - Warning products - Warnmarkierungen

VC 70.01

E4 017016

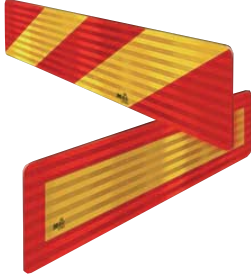

### Camions / Cars et bus - Trucks / Coaches - LKW / Busse

1 x (132 x 1132)



Adhésif *	<b>D11255</b>
Alu 1 mm	<b>D11261</b>
Alu 2 mm	<b>D11588</b>

2 x (132 x 566)

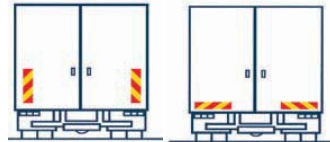

Adhésif *	<b>D11256</b>
Alu 1 mm	<b>D10900</b>
Alu 2 mm	<b>D11589</b>

4 x (132 x 283)



Adhésif *	<b>D11257</b>
Alu 1 mm	<b>D11262</b>
Alu 2 mm	<b>D11590</b>

215

### Remorques - Trailers - Anhänger

\* Adhésif - Adhesive - Selbstklebend

1 x (197 x 1132)



Adhésif *	<b>D11258</b>
Alu 1 mm	<b>D11263</b>
Alu 2 mm	<b>D11591</b>

2 x (197 x 566)



Adhésif *	<b>D11259</b>
Alu 1 mm	<b>D10901</b>
Alu 2 mm	<b>D11592</b>

4 x (197 x 283)



Adhésif *	<b>D11260</b>
Alu 1 mm	<b>D11264</b>
Alu 2 mm	<b>D11593</b>

**2.4 Produits complémentaires - Complementary products - Ergänzende Produkte**  
**Signalisation passive - Warning products - Warnmarkierungen**

**BA**

2 x 9 m x 141 mm



Cl.1 :  ->80m	<b>D12020</b>
Cl.2 :  ->500m	<b>D11955</b>

2 x 45 m x 141 mm



Cl.1 :  ->80m	<b>D12021</b>
Cl.2 :  ->500m	<b>D11956</b>

**NEW**

2 x 9 m x 141 mm



Cl.2 :  ->500m	<b>D11957</b>
----------------	---------------

**NEW**

2 x 45 m x 141 mm



Cl.2 :  ->500m	<b>D11958</b>
----------------	---------------

**Structure rigide - Rigid support - Auf Festaufbauten**

**VC 104**

E4 0001

**216**

50 m x 50 mm



	<b>465219</b>
	<b>465229</b>
	<b>465239</b>

12.50 m x 50 mm



	<b>465319</b>
	<b>465329</b>
	<b>465339</b>

**Structure souple - Curtain support - Für Plane**

**NEW**

50 m x 50 mm



	<b>465519</b>
	<b>465529</b>

Adhésif à froid - Pressure sensitive adhesive - Kalt verklebt

**2.4 Produits complémentaires - Complementary products - Ergänzende Produkte**  
**Signalisation passive - Warning products - Warnmarkierungen**

**VC 104**

E4 0001

**Stickers Citerne - Tanker Stickers - Aufkleber für Tankfahrzeuge**



50 m x 50 mm



●	<b>465419</b>
○	<b>465429</b>
●	<b>465439</b>

Découpe tous les 16cm - Precut every 16cm - Vorgeschnitten 16cm Schritte

**Kit de balisage - Reflective stripes kit - Satz mit reflektierende Streifen**

50 mm

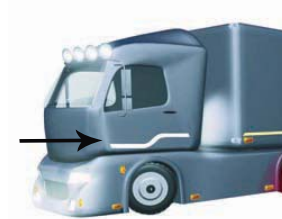
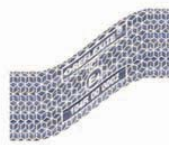

<b>D12526</b>	<b>IVECO STRALIS AS</b>
<b>D12527</b>	<b>IVECO STRALIS AT AD</b>
<b>D12528</b>	<b>VOLVO FH</b>
<b>D12529</b>	<b>VOLVO FM</b>

217

## 2.4 Produits complémentaires - Complementary products - Ergänzende Produkte

### Eclairage intérieur - Dom lamps - Innenraumleuchten

FE02

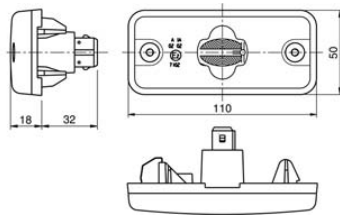

E2 7102

montage - mounting - Anbringung

110 mm x 50 mm x 18 mm



102200

W5W



001726

Clippé - Clipped-Clip - Befestigung

CM6

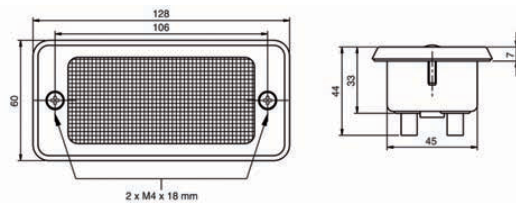

120 mm x 60 mm x 44 mm



350049

C5W

218

EC

115 mm x 50 mm



D10805



## 2.4 Produits complémentaires - Complementary products - Ergänzende Produkte

### Eclairage intérieur - Dom lamps - Innenraumleuchten

PL

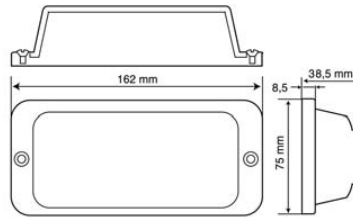

162 mm x 75 mm



**36070607**

2x5W



**36070603**

2x5W

Interrupteur  
Switch  
Schalter

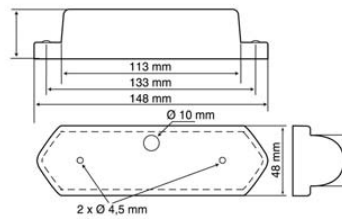

148 mm x 48 mm



**36080603**

1x7W

Interrupteur  
Switch  
Schalter

219

## 2.4 Produits complémentaires - Complementary products - Ergänzende Produkte Eclairage extérieur - Working lamps - Arbeitsscheinwerfer

FM76

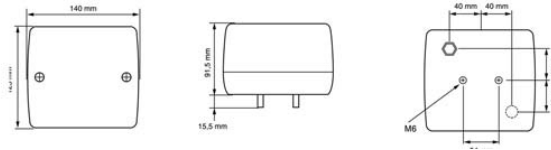

140 mm x 125 mm x 91,5 mm



176100

P21W

FTC

104 mm x 94mm

NEW



D13019\*

H3/70W-24V

104 mm x 94mm

NEW



D13020\*

H3/35W-24V

Feu de sellette Renault Trucks  
Working lamp Renault Trucks  
Arbeitsscheinwerfer f. renault

104 mm x 94mm



D12111\*

H3/70W-24V

Câble : 20 cm  
Cable : 20 cm  
Anschlusskabel : 20 cm

104 mm x 94mm



D12112\*

H3/35W-24V

Feu de sellette Volvo Trucks  
Working lamp Volvo Trucks  
Arbeitsscheinwerfer f. volvo

104 mm x 94mm



D12487\*

H3/70W-24V

104 mm x 94mm



D12488\*

H3/35W-24V

NEW

104 mm x 94mm



D12263\*

H3/70W-24V

\*Lampe fournie  
\*Bulb included  
\*Inklusiv Glühlampen

220

## 2.4 Produits complémentaires - Complementary products - Ergänzende Produkte

### Eclairage extérieur - Working lamps - Arbeitsscheinwerfer

FTC



Ø 114 mm x 70 mm



**D12998\*** LED -12/24V



104 mm x 94mm



**D12390\*** H3/70W-24V

Feu homologué recul + Interrupteur  
Reverse + Switch  
Rückfahrleuchte + Schalter

Ø 105 mm



**D10837** P21W-12/24V

Interrupteur  
Switch  
Schalter

167 mm x 71 mm x 115 mm



**D10986** H3-12/24V

193 mm x 88 mm x 93 mm



**D10987** H3-12/24V



**D11006**

\*Lampe fournie  
\*Bulb included  
\*Inklusiv Glühlampen

221

Feu de sellette Renault Trucks  
Working lamp Renault Trucks  
Arbeitsscheinwerfer f. renault

## 2.4 Produits complémentaires - Complementary products - Ergänzende Produkte Gyrophares - Rotating beacons - Rundumkennleuchten

VA

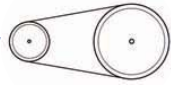

Ø 153 mm x 143 mm



**D12602** H1-12/24V

3P

Ø 166 mm x 150 mm



**D12603** H1-12/24V

M

Ø 134 mm x 214 mm



**D12600** H1-12/24V

T



**D12610**

Cabochoon - Lens - Lichtscheibe

**NEW**

Ø 153 mm x 143 mm



**D12739** XENON-12/24V

3P

**NEW**

Ø 166 mm x 150 mm



**D12741** XENON-12/24V

M

**NEW**

Ø 134 mm x 214 mm



**D12740** XENON-12/24V

T

**NEW**



**D12742**

Cabochoon - Lens - Lichtscheibe

222

Fixation  
fixing  
Befestigung

3P  
3 points  
3 points fixing  
3-Punkt-Befestigung

M  
Magnétique  
Magnetic  
Magnetfuss

T  
Sur tige  
On stirrup  
für Aufsteckrohr

## 2.4 Produits complémentaires - Complementary products - Ergänzende Produkte Gyrophares - Rotating beacons - Rundumkennleuchten

390

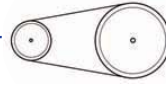

Ø 153 mm x 179 mm



**D12220**

H1-12/24V

3P

Ø 156 mm x 182 mm



**D12222**

H1-12/24V

M

Ø 153 mm x 179 mm



**D12221**

H1-12/24V

T

223

320

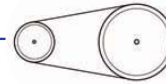

Ø 153 mm x 165 mm



**632030**

H1-12/24V

3P

Ø 153 mm x 165 mm



**632430**

H1-12/24V

M

Ø 149 mm x 223 mm



**632230**

H1-12/24V

T



**603230**

Cabochon - Lens - Lichtscheibe

Fixation  
fixing  
Befestigung

3P  
3 points  
3 points fixing  
3-Punkt-Befestigung

M  
Magnétique  
Magnetic  
Magnetfuss

T  
Sur tige  
On stirrup  
für Aufsteckrohr

## 2.4 Produits complémentaires - Complementary products - Ergänzende Produkte Gyrophares - Rotating beacons - Rundumkennleuchten

B20

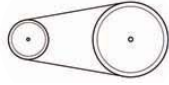

Ø 148 mm x 148 mm



**D10801**

H1-24V **3P**

Ø 162 mm x 182 mm



**D10802**

H1-24V **M**

Ø 149 mm x 257 mm



**D10803**

H1-24V **T**

**D10980**

Cabochoon - Lens - Lichtscheibe

224

Fixation  
fixing  
Befestigung

**3P**  
3 points  
3 points fixing  
3-Punkt-Befestigung

**M**  
Magnétique  
Magnetic  
Magnettuss

**T**  
Sur tige  
On stirrup  
für Aufsteckrohr

## 2.4 Produits complémentaires - Complementary products - Ergänzende Produkte

### Alarmes et systèmes de vision arrière - Back-up alarms and rear vision systems

#### Rückfahrwarner und Rückfahrvideosysteme

#### ASR

101 mm x 67 mm x 41 mm



12/24V

1	630120	87 db
2	630110	82-102 db
3	630100	102 db

- 1 Chariots élévateurs, petits camions, VUL  
Fork lift, small trucks, LCV  
Gabelstapler, Lieferwagen, Transporter
- 2 Toute utilisation. Ajustement automatique 10 db supérieur au bruit ambiant  
All use. Automatic adjustment 10 dB higher than the environment noise  
Alle Anwendungsbereiche. Automatische Lautstärkeanpassung +10db über Umgebungslärm
- 3 Benne à ordure, chantier, forêt, PL  
Waste collection vehicles, forest work vehicles, trucks  
Müllfahrzeuge, Baustellenfahrzeuge, Forstfahrzeuge, LKW



**NEW**

**D12953**

Alarme sonore de recul  
Back up alarm  
Rückfahrsignalhorn

Pour connection sur feu arrière LC9 p. 144, LC7 p. 153  
To plug in LC9 / LC7 rear lamp p. 144 / p. 153  
Zum direkten Anschluss an die Heckleuchte LC9 S. 144, LC7 S. 153



**001830**

Alarme sonore de recul  
Back up alarm  
Rückfahrsignalhorn

Pour connection sur feu arrière LC8 p. 145  
To plug in LC8 rear lamp p. 145  
Zum direkten Anschluss an die Heckleuchte LC8 S. 145

225

#### CAM

**NEW**

196 mm  
x 127 mm  
x 27 mm



**D12935**

12/24V

Sans fil - Wireless - Drahtlos

Transmission sans fil A/V 2.4 GHz , caméra IP66, capteur SONY CCD, 420 lignes de définition.  
Wireless transmission A/V 2.4 GHz, IP66 camera, SONY CCD sensor.  
Drahtlose Bildübertragung A/V 2.4 GHz; Kamera Schutzklasse IP66, Bildsensor SONY CCD, Bildauflösung 420 Linien.

Les appareils 2.4 GHz tels que les téléphones cellulaires, les systèmes Bluetooth et Wi-Fi peuvent causer des interférences passagères.

Applications conseillées : agricole et TP carrière.

2.4 GHz devices such as mobile phones, Bluetooth and Wi-Fi may cause some temporary interferences.

Recommended applications : agricultural and construction equipment.

Bei gleichzeitigem Betrieb von Geräten, die im Frequenzbereich von 2.4 GHz arbeiten, wie z.B. Mobiltelefone, Bluetooth und WLAN Übertragungen, können gelegentlich Störinterferenzen auftreten.

Empfohlener Anwendungsbereich : Landwirtschaftliche Geräte und Baumaschinen.





## 2.4 Produits complémentaires - Complementary products - Ergänzende Produkte

### Alarmes et systèmes de vision arrière - Back-up alarms and rear vision systems

### Rückfahrwarner und Rückfahrvideosysteme

CAM



Ecran LCD, caméra SONY avec micro intégré, réglage automatique de luminosité, entrée/sortie audio et vidéo, IP68  
 LCD Screen, SONY camera with integrated microphone, brightness automatic adjustment, audio and video input/output, IP 68  
 LCD-Bildschirm, SONY Kamera mit integriertem Mikrophon, automatische Helligkeitsregelung, Audio- und Video-Eingang und -Ausgang, Dichtigkeit IP 68

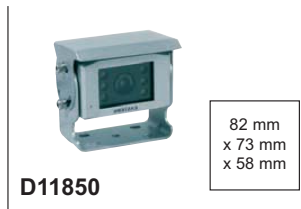

Kit remorques pour A10091  
 Trailer kit for A10091  
 Kit Anhänger / Auflieger für A10091

226

## 2.4 Produits complémentaires - Complementary products - Ergänzende Produkte Centrales et tempo - Flasher units and windscreen - Elektronische Blinkgeber und Zeitrelais

CPL



014080



014580

Renault 5000461149  
5 lampes commande warning  
5 lamps, warning command  
5 Glühlampen, Warnblinker

227

## 2.4 Produits complémentaires - Complementary products - Ergänzende Produkte

### Lampes - Bulbs - Glühlampen

#### Projecteurs - Head lamps - Hauptscheinwerfer

MP: MegalightPlus  
 LL: Longlife  
 SB: Superblue  
 R: Rally

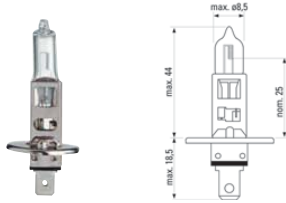

H1 - P14,5s

12V	H1-55W	<b>50310/U</b>
	H1MP-55W	<b>50310MPU</b>
	H1LL-55W	<b>50310LU</b>
24V	H1-70W	<b>50320 / 1U</b>
	H1R-100W	<b>91192</b>

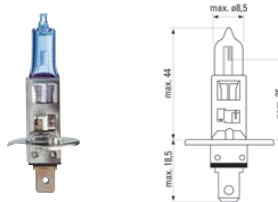

H1 - P14,5s

12V	H1 SB-55W	<b>50310BU</b>
-----	-----------	----------------

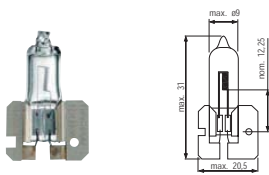

H2 - H511

12V	H2-55W	<b>50410U</b>
24V	H2-70W	<b>50420U</b>

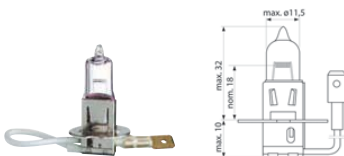

H3 - PK22s

12V	H3-55W	<b>50340U</b>
	H3LL-55W	<b>50340LU</b>
24V	H3-35W	<b>D13080</b>
	H3-70W	<b>50350U</b>
	H3R-100W	<b>50400</b>

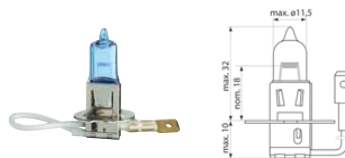

H3 - PK22s

12V	H3 SB-55W	<b>50340BU</b>
-----	-----------	----------------

## 2.4 Produits complémentaires - Complementary products - Ergänzende Produkte

### Lampes - Bulbs - Glühlampen

#### Projecteurs - Head lamps - Hauptscheinwerfer

MP: MegalightPlus  
 LL: Longlife  
 SB: Superblue  
 R: Rally

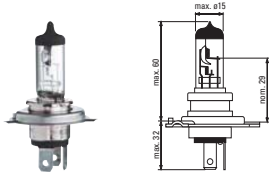

H4 - P43t

12V	H4-60/55W	<b>50440U</b>
	H4MP-60/55W	<b>50440MPU</b>
	H4LL-60/55W	<b>50440LU</b>
24V	H4-75/70W	<b>50450U</b>
	H4R-100/70W	<b>52710</b>

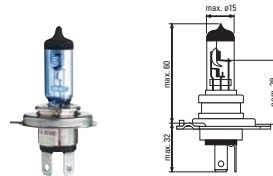

H4 - P43t

12V	H4 SB-60/55W	<b>50440BU</b>
-----	--------------	----------------

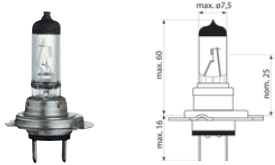

H7 - Px 26d

12V	H7-55W	<b>58520U</b>
	H7MP-55W	<b>58520MPU</b>
	H7LL-55W	<b>58520LU</b>
24V	H7-70W	<b>58521U</b>

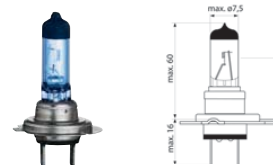

H7 - Px 26d

12V	H7 SB-55W	<b>58520BU</b>
-----	-----------	----------------

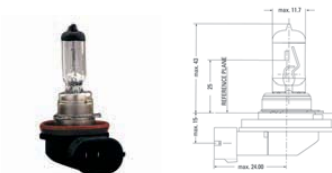

H8 - PGJ19-1

12V	H8-35W	<b>53090U</b>
-----	--------	---------------

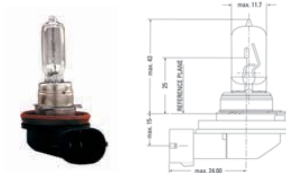

H9 - PGJ19-5

12V	H9 -55W	<b>53100U</b>
-----	---------	---------------

## 2.4 Produits complémentaires - Complementary products - Ergänzende Produkte

### Lampes - Bulbs - Glühlampen

#### Projecteurs - Head lamps - Hauptscheinwerfer

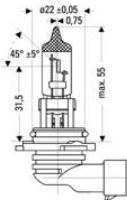

H10 - PY20d

12V	H10-42W	<b>9145</b>
	H10W	<b>58560</b>

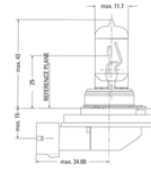

H11 - PGJ19-2

12V	H11-55W	<b>53110U</b>
-----	---------	---------------

MP: MegalightPlus  
LL: Longlife  
SB: Superblue  
R: Rally

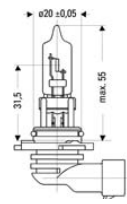

HB3 - P20d

12V	HB3-60W	<b>9005</b>
-----	---------	-------------

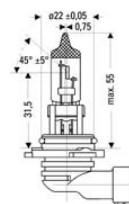

HB4 - P22d

12V	HB4-51W	<b>9006</b>
-----	---------	-------------



D2R - P32d3

12V	D2R-35W	<b>53510</b>
-----	---------	--------------

(85V)



D2S - P32d-2

12V	D2S-35W	<b>53500</b>
-----	---------	--------------

(85V)

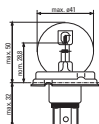

R2 - P45t

12V	R2-45/40W	<b>1931</b>
24V	R2-55/50W	<b>1937</b>

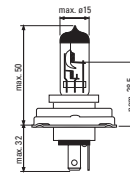

R2 Visio - P45t

12V	R2 Visio-45/40W	<b>52950U</b>
-----	-----------------	---------------

## 2.4 Produits complémentaires - Complementary products - Ergänzende Produkte Lampes - Bulbs - Glühlampen

### Projecteurs - Head lamps - Hauptscheinwerfer

MP: MegalightPlus  
LL: Longlife  
SB: Superblue  
R: Rally  
HD: Heavy Duty

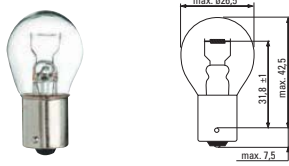

P21W - BA15s

12V	P21W	<b>1057</b>
	P21WLL	<b>1057L</b>
24V	P21W	<b>1060</b>
	P21WHD	<b>1060HD</b>

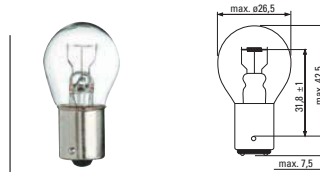

P21W - BA15d

24V	P21WHD	<b>1061HD</b>
-----	--------	---------------

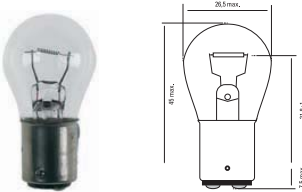

Poirette - BA15d

24V	PL-20W	<b>91376</b>
-----	--------	--------------

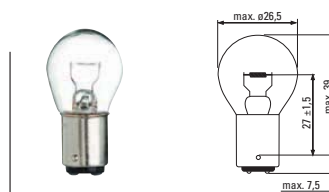

Sphérique - BA15d

24V	S1114-15W	<b>1114</b>
-----	-----------	-------------

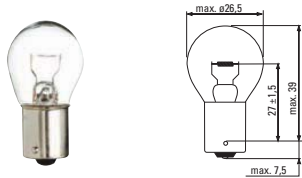

Sphérique - BA15s

12V	S1143-15W	<b>1143</b>
	S1115-15W	<b>1115</b>
24V	S1117-18W	<b>1117</b>

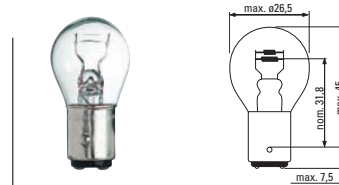

P21/5W - BAY15d

12V	P21/5W	<b>1077</b>
	P21/5WLL	<b>1077L</b>
24V	P21/5W	<b>1078</b>

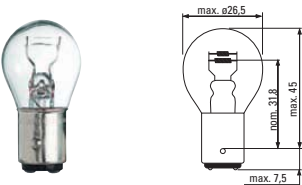

P21/4W - BAZ15d

12V	P21/4W	<b>1122</b>
-----	--------	-------------

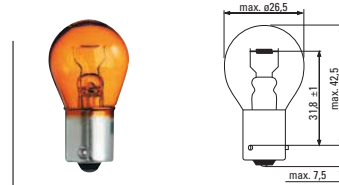

PY21W - BAU15s

12V	PY21W	<b>1056</b>
	PY21WLL	<b>1056L</b>
24V	PY21W	<b>1073</b>

## 2.4 Produits complémentaires - Complementary products - Ergänzende Produkte

### Lampes - Bulbs - Glühlampen

#### Signalisation - Signalling lamps - Schlusslicht

MP: MegalightPlus  
 LL: Longlife  
 SB: Superblue  
 R: Rally  
 HD: Heavy Duty

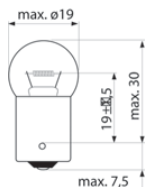

R5W - BA15s

12V	R5W	<b>2619</b>
	R5WLL	<b>2619L</b>
24V	R5W	<b>2627</b>
	R5WHD	<b>2627HD</b>

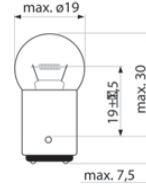

R5W - BA15d

12V	R5W	<b>2618</b>
24V	R5W	<b>2626</b>

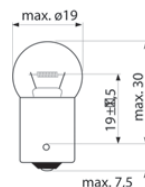

R10W - BA15s

12V	R10W	<b>2641</b>
	R10W	<b>2643</b>
24V	R10WHD	<b>2643HD</b>

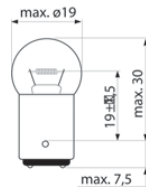

R10W - BA15d

12V	R10W	<b>2640</b>
-----	------	-------------



C3W - SV7

12V	C3W-28x6	<b>91701</b>
24V	C3W-28x8	<b>91702</b>



C5W - SV8,5

12V	C5WLL	<b>7546L</b>
	C5W-36x11	<b>7546</b>
	C5W-40x11	<b>7575</b>
24V	C5W-35x11	<b>7552</b>
	C5W-41x11	<b>7579</b>

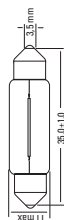

C10W - SV8,5

12V	C10W-35x11	<b>91715</b>
	C10W-41x11	<b>7576</b>
24V	C10W-41x11	<b>7580</b>



C15W - SV8,5

12V	C15W-41x15	<b>7592</b>
24V	C15W-41x15	<b>7594</b>



## 2.4 Produits complémentaires - Complementary products - Ergänzende Produkte

### Lampes - Bulbs - Glühlampen

#### Signalisation - Signalling lamps - Schlusslicht

MP: MegalightPlus  
 LL: Longlife  
 SB: Superblue  
 R: Rally  
 HD: Heavy Duty



C18W - SV8,5

12V	C18W-41x15	<b>7593</b>
24V	C18W-41x15	<b>7595</b>

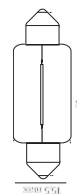

C21W - SV8,5

12V	C21W-41x15,5	<b>91761</b>
-----	--------------	--------------

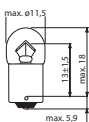

T2W/T3W - BA9s

12V	T2W	<b>2660</b>
	T3W	<b>2656</b>
24V	T2W	<b>2663</b>

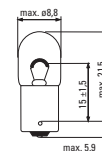

T4W - BA9s

12V	T4W	<b>2662</b>
	T4WLL	<b>2662L</b>
24V	T4W	<b>2661</b>
	T4WHD	<b>2661HD</b>

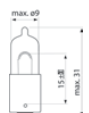

H5W - BA9s

12V	H5W	<b>58540</b>
-----	-----	--------------

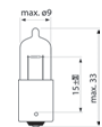

H6W - BAX9s

12V	H6W	<b>52830</b>
-----	-----	--------------

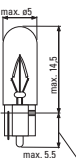

W1,2W - W2x4,6d

12V	W1,2W	<b>5301</b>
	W2W	<b>91605</b>
24V	W1,2W	<b>91602</b>



W1,2W - B8,3d

12V	W1,2W	<b>5301PS2</b>
-----	-------	----------------

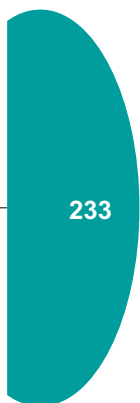

233

## 2.4 Produits complémentaires - Complementary products - Ergänzende Produkte

### Lampes - Bulbs - Glühlampen

#### Signalisation - Signalling lamps - Schlusslicht

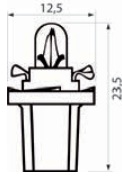

W1,2W - B8,5d

12V	W1,2W	<b>5301PS</b>
24V	W1,2W	<b>5302PS</b>

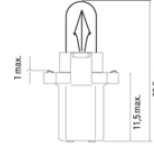

W2W - B8,5d

12V	W2W	<b>5303PS</b>
-----	-----	---------------

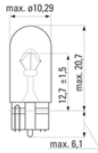

WY5W - W2,1x9,5d

12V	WY5W	<b>501AMBER</b>
-----	------	-----------------

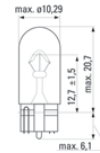

W3W/W5W - W2,1x9,5d

12V	W3W	<b>5304</b>
	W5W	<b>501</b>
24V	W3W	<b>5305</b>
	W5W	<b>91622</b>

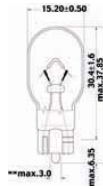

W16W - W2,1x9,5d

12V	W16W	<b>921</b>
-----	------	------------

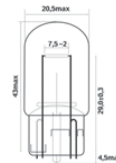

W21W - W3x16d

12V	W21W	<b>7440</b>
-----	------	-------------

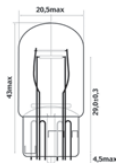

W21/5W - W3x16q

12V	W21/5W	<b>7443</b>
-----	--------	-------------

## 2.4 Produits complémentaires - Complementary products - Ergänzende Produkte

### Rétroviseurs - Rear view mirrors - Rückspiegel

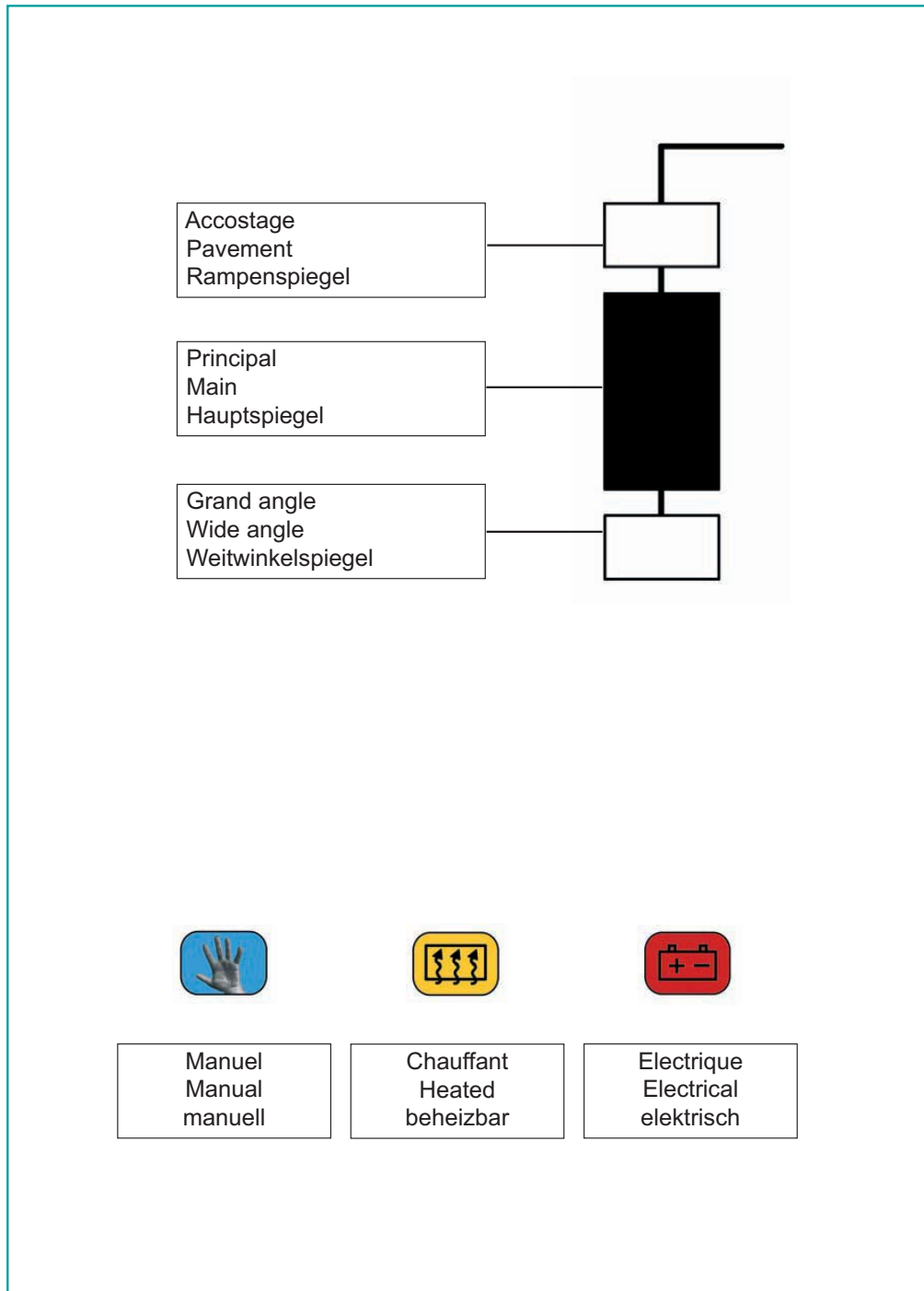

**2.4 Produits complémentaires - Complementary products - Ergänzende Produkte**  
**Rétroviseurs - Rear view mirrors - Rückspiegel**

**PREMIUM 97->06 / KERAX 97->06 / MIDLUM 99->06**



II E2 5004  
II E2 5006



Ø 22 mm

**VI0060**  
(RVI 5001844006)

gauche et droit - left and right - links und rechts

370 mm x 182 mm



**VI0061**  
(RVI 5001844005)



Ø 22 mm

**VI0064**  
(RVI 5001856291)

gauche - left - links



Ø 22 mm

**VI0062**  
(RVI 5001856292)

droit - right - rechts



Ø 22 mm

Premium / Midlum	<b>VI0056</b>	(RVI 5001856290)		
Kerax	<b>VI0058</b>	(RVI 5001853677)		

gauche et droit - left and right - links und rechts

374 mm x 184 mm



**VI0057**  
(RVI 5001832947)



2003/97/EC  
IV e2 03 05024

ECE 46R02  
IV e2 02 05024



Ø 22 mm

**VI0072**  
(RVI 5001853185)

gauche et droit - left and right - links und rechts

180 mm x 180 mm



**VI0075**  
(RVI 5001853332)

Manuel  
Manual  
manuell

Electrique  
Electrical  
elektrisch

Chauffant  
Heated  
beheizbar

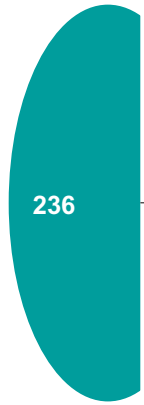

## 2.4 Produits complémentaires - Complementary products - Ergänzende Produkte

### Rétroviseurs - Rear view mirrors - Rückspiegel

#### PREMIUM 97->06 / KERAX 97->06 / MIDLUM 99->06

2003/97/EC  
IV e2 03 05024

ECE 46R02  
IV e2 02 05024



**VI0073**

(RVI 5001856289)



gauche - left - links



**VI0074**

(RVI 5001853673)



droit - right - rechts

180 mm x 180 mm



**VI0076**

(RVI 5001832948)



#### RVI Gammes C, G, M, R, S

89->

237

II E2 01800



**VI0041**



gauche et droit - left and right - links und rechts

369 mm x 180 mm



**VI0042**

(RVI 5001824156)



**VI0043**



gauche et droit - left and right - links und rechts



**VI0045**



gauche et droit - left and right - links und rechts

Manuel  
Manual  
manuell

Electrique  
Electrical  
elektrisch

Chauffant  
Heated  
beheizbar



**VI0047**



gauche et droit - left and right - links und rechts

Kit miroir - Kit specchi retrovisori - Kit espejos retrovisores

369 mm x 180 mm



**VI0044**

(RVI 5001824162)







## 2.4 Produits complémentaires - Complementary products - Ergänzende Produkte

### Rétroviseurs - Rear view mirrors - Rückspiegel







#### RVI Gammes C, G, M, R, S

89->

 <p>Ø 22 mm</p> <p><b>VI0048</b> (RVI 5000504769)</p> <p>gauche et droit - left and right - links und rechts</p>	 <p>257 mm x 158 mm</p> <p><b>VI0049</b> (RVI 5000295727)</p>	<p>IV / V E2 01801</p>
 <p>Ø 22 mm</p> <p><b>VI0050</b> (RVI 5000297205)</p> <p>gauche et droit - left and right - links und rechts</p>	 <p>257 mm x 158 mm</p> <p><b>VI0051</b> (RVI 5001821583)</p>	

#### RVI Gammes G, R

->89

 <p>Ø 18 mm</p> <p><b>VI0067</b> (RVI 5010057488)</p> <p>gauche et droit - left and right - links und rechts</p>	 <p>403 mm x 204 mm</p> <p><b>VI0068</b> (RVI 5000805326)</p>	<p>II E2 01740</p>
 <p><b>VI0034</b> (RVI 5010057492)</p> <p>gauche et droit - left and right - links und rechts</p>	 <p>239 mm x 143 mm</p> <p><b>VI0036</b> (RVI 5000816853)</p>	<p>IV / V E2 00759</p>
 <p>Ø 18 mm</p> <p><b>VI0035</b></p> <p>gauche et droit - left and right - links und rechts</p>	 <p><b>VI0036</b> (RVI 5000816853)</p>	

 Manuel  
 Manual  
 manuell

 Electrique  
 Electrical  
 elektrisch

 Chauffant  
 Heated  
 beheizbar

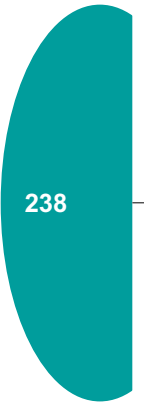

## 2.4 Produits complémentaires - Complementary products - Ergänzende Produkte

### Rétroviseurs - Rear view mirrors - Rückspiegel

RVI Gammes C, J, S

->89

II E2 00739



-  Manuel  
Manual  
manuell
-  Electrique  
Electrical  
elektrisch
-  Chauffant  
Heated  
beheizbar





## 2.4 Produits complémentaires - Complementary products - Ergänzende Produkte

### Rétroviseurs - Rear view mirrors - Rückspiegel

#### RVI PR100, R312, FR1, TRACER / BERKHOF / Universel

**VI0025**  
(RVI 5000813435)

gauche et droit - left and right - links und rechts

**VI0027**  
(RVI 5001834387)

gauche et droit - left and right - links und rechts

**VI0021**  
(RVI 5000823249)

gauche et droit - left and right - links und rechts

**VI0023**  
(RVI 5001834397)

gauche et droit - left and right - links und rechts

II E2 00651

**VI0026**  
(RVI 5000823600)

gauche et droit - left and right - links und rechts

387 mm x 165 mm

**VI0028**  
(RVI 5000813447)

**VI0022**  
(RVI 5000824385)

gauche et droit - left and right - links und rechts

387 mm x 165 mm

**VI0024**  
(RVI 5000813442)

240

	Manuel Manual manuell
	Electrique Electrical elektrisch
	Chauffant Heated beheizbar

**2.4 Produits complémentaires - Complementary products - Ergänzende Produkte**  
**Rétroviseurs - Rear view mirrors - Rückspiegel**

**RVI PR100, R312, FR1, TRACER / BERKHOF / Universel**

II E2 00764



gauche et droit - left and right - links und rechts



gauche et droit - left and right - links und rechts  
 Avec faisceau - With harness - Mit Anschlusskabel



gauche et droit - left and right - links und rechts



gauche et droit - left and right - links und rechts  
 Avec faisceau - With harness - Mit Anschlusskabel



IV / V E2 01801



gauche et droit - left and right - links und rechts



gauche et droit - left and right - links und rechts



-  Manuel  
Manual  
manuell
-  Electrique  
Electrical  
elektrisch
-  Chauffant  
Heated  
beheizbar

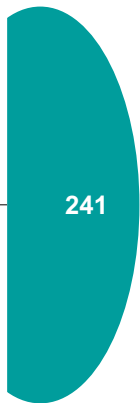

**2.4 Produits complémentaires - Complementary products - Ergänzende Produkte**  
**Rétroviseurs - Rear view mirrors - Rückspiegel**

**Intérieur - Interiore - Interior**

Ø 18mm



**VI0037**  
(RVI 5001020059)

miroir plat - flat glass - flaches Spiegel

239 mm x 143 mm



**VI0038**  
(RVI 7701014862)

Ø 18 mm



**VI0039**

miroir bombé - rounded glass - gewölbt Spiegel

239 mm x 143 mm



**VI0040**  
(RVI 7701014502)

II / III E2 00760

Ø 18 mm





**VI0052**  
(RVI 5001021067)



Ø 280 mm

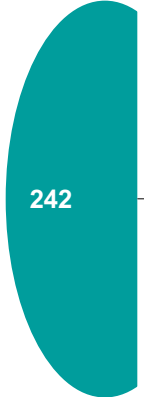

**VI0053**  
(RVI 5000802915)

**VI0054**  
(RVI 5000815684)

-  Manuel  
Manual  
manuell
-  Electrique  
Electrical  
elektrisch
-  Chauffant  
Heated  
beheizbar

## 2.4 Produits complémentaires - Complementary products - Ergänzende Produkte

### Rétroviseurs - Rear view mirrors - Rückspiegel

ACC



## 2.5 Electricité remorque - Electric products for trailers - Elektrik für Anhänger/Auflieger

### Prises et cordons de liaison - Cables and plugs - Anschlusskabel und Steckverbindungen



---



**611560**      ABS/EBS



**A10062**      ABS/EBS

---



---



**A10065**      ABS/EBS



**A10066**      ABS/EBS

**ABS/  
EBS**

ISO 7638-1

ADR

Schéma électrique p. 248  
Electric scheme p. 248  
Belegungsplan siehe S.248

**Métallique - Metal - Metall**



---



**D10873**      24N



**611530**      24N

---



**D10874**      24S



**611550**      24S

**7P**

24N (ISO 1185)  
24S (ISO 3731)

Schéma électrique p. 248  
Electric scheme p. 248  
Belegungsplan siehe S.248

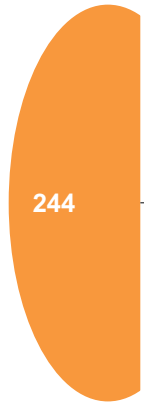

## 2.5 Electricité remorque - Electric products for trailers - Elektrik für Anhänger/Auflieger

### Prises et cordons de liaison - Cables and plugs - Anschlusskabel und Steckverbindungen

7P

24N (ISO 1185)  
24S (ISO 3731)

Schéma électrique p. 248  
Electric scheme p. 248  
Belegungsplan siehe S.248

Plastique - Plastic housing - Kunststoffgehäuse



24N



24S

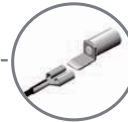

24N



24S

245

15P

ISO 12098

Schéma électrique p. 248  
Electric scheme p. 248  
Belegungsplan siehe S.248



PARC



ABS/EBS-15P

## 2.5 Electricité remorque - Electric products for trailers - Elektrik für Anhänger/Auflieger

### Prises et cordons de liaison - Cables and plugs - Anschlusskabel und Steckverbindungen



**ABS/  
EBS**

Longueur de travail : 3 m  
Working length : 3 m  
Arbeitslänge : 3 m

Longueur d'extension maximale : 4,5 m  
Maximum extension length : 4,5 m  
Maximale Ausziehlänge : 4,5 m

#### Plastique - Plastic housing - Kunststoffgehäuse



**C7P**

Longueur de travail : L  
Working length : L  
Arbeitslänge : L

Longueur d'extension maximale : LMax  
Maximum extension length : LMax  
Maximale Ausziehlänge : LMax

#### Métallique - Metal - Metall



246

**NEW**

**NEW**

**NEW**



**NEW**

6 x 1,0 mm<sup>2</sup> + 1 x 1,5 mm<sup>2</sup>





## 2.5 Electricité remorque - Electric products for trailers - Elektrik für Anhänger/Auflieger

Prises et cordons de liaison - Cables and plugs - Anschlusskabel und Steckverbindungen

C15P



D11578

7P-15P



611410

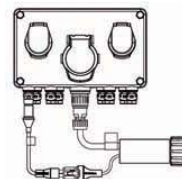

D13258



D11487



A10064

247

## 2.5 Electricité remorque - Electric products for trailers - Elektrik für Anhänger/Auflieger

### Prises et cordons de liaison - Cables and plugs - Anschlusskabel und Steckverbindungen

#### 24N

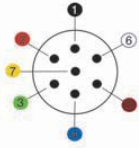

① - Masse	Common return	Masse
② - Feu de position G	L rear position lamp	Linke Schlussleuchte
③ - Clignotant G	L flasher lamp	Fahrtrichtungsanzeiger links
④ - Feu Stop	Stop lamp	Bremsleuchte
⑤ - Clignotant D	R flasher lamp	Fahrtrichtungsanzeiger rechts
⑥ - Feu de position D, Feu plaque immatriculation	R rear position lamp, Number plate lamp	Rechte Schlussleuchte, Kennzeichenleuchte
⑦ - Commande de frein	Breaking control	Steuerung Anhängerbremse

#### 24S

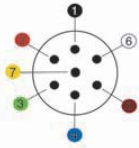

① - Masse	Common return	Masse
② - Sans affectation	Without affectation	Nicht belegt
③ - Feu de recul	Reverse lamp	Rückfahrleuchte
④ - Alimentation en puissance	Power supply	Stromversorgung (Dauerplus)
⑤ - Contrôle par mise en puissance	Sensing device with common return	Kontrolleinrichtung über Masse
⑥ - Alimentation en puissance supplémentaire	Additional power supply	Stromversorgung über Zündschalter gesteuert
⑦ - Feu AR de brouillard	Fog lamp	Nebelschlussleuchte

#### ABS/EBS

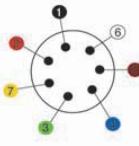

① - Plus (+) alimentation électrovanne	Plus electrovalve	Plus Magnetventil
② - Plus (+) connexions électroniques	Plus electronics	Plus Elektronik
③ - Moins (-) connexions électroniques	Minus electronics	Minus Elektronik
④ - Moins (-) alimentation électrovanne	Minus electrovalve	Minus Magnetventil
⑤ - Connexion lampe témoin	Warning device	Warneinrichtung
⑥ - Connexion donnée CANH	CANH	Datenleitung CANH
⑦ - Connexion donnée CANL	CANL	Datenleitung CANL

#### 15 PÔLES

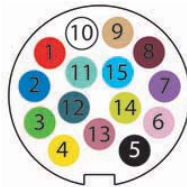

① - Clignotant gauche	L flasher lamp	Fahrtrichtungsanzeiger links
② - Clignotant droit	R flasher lamp	Fahrtrichtungsanzeiger rechts
③ - Feu AR de brouillard	Fog lamp	Nebelschlussleuchte
④ - Masse	Common return	Masse
⑤ - Feu de position gauche	L rear position lamp	Linke Schlussleuchte
⑥ - Feu de position droit	R rear position lamp	Rechte Schlussleuchte
⑦ - Feu stop	Stop lamp	Bremsleuchte
⑧ - Feu de recul	Reverse lamp	Rückfahrleuchte
⑨ - Alimentation 24V	24V power supply	Stromversorgung +24V
⑩ - Capteur d'usure des freins	Worn brake indicator	Sensor für Bremsbelagverschleissanzeige
⑪ - Capteurs de pressions des freins	Brake pressure collector	Anzeige für Federspeicherbremse
⑫ - Dispositif de levage d'essieu	Adjustable suspension lift	Achsanhebung
⑬ - Masse pour contacts 14 et 15	Common return	Masse für Datenleitungen
⑭ - Bus de données	Data line	Datenleitung
⑮ - Bus de données	Data line	Datenleitung

## 2.5 Electricité remorque - Electric products for trailers - Elektrik für Anhänger/Auflieger Câblage remorque - Trailers harnesses - Verkabelungsprodukte für Anhänger/Auflieger

### Système "MDJ" - Box system - Verteilerdose

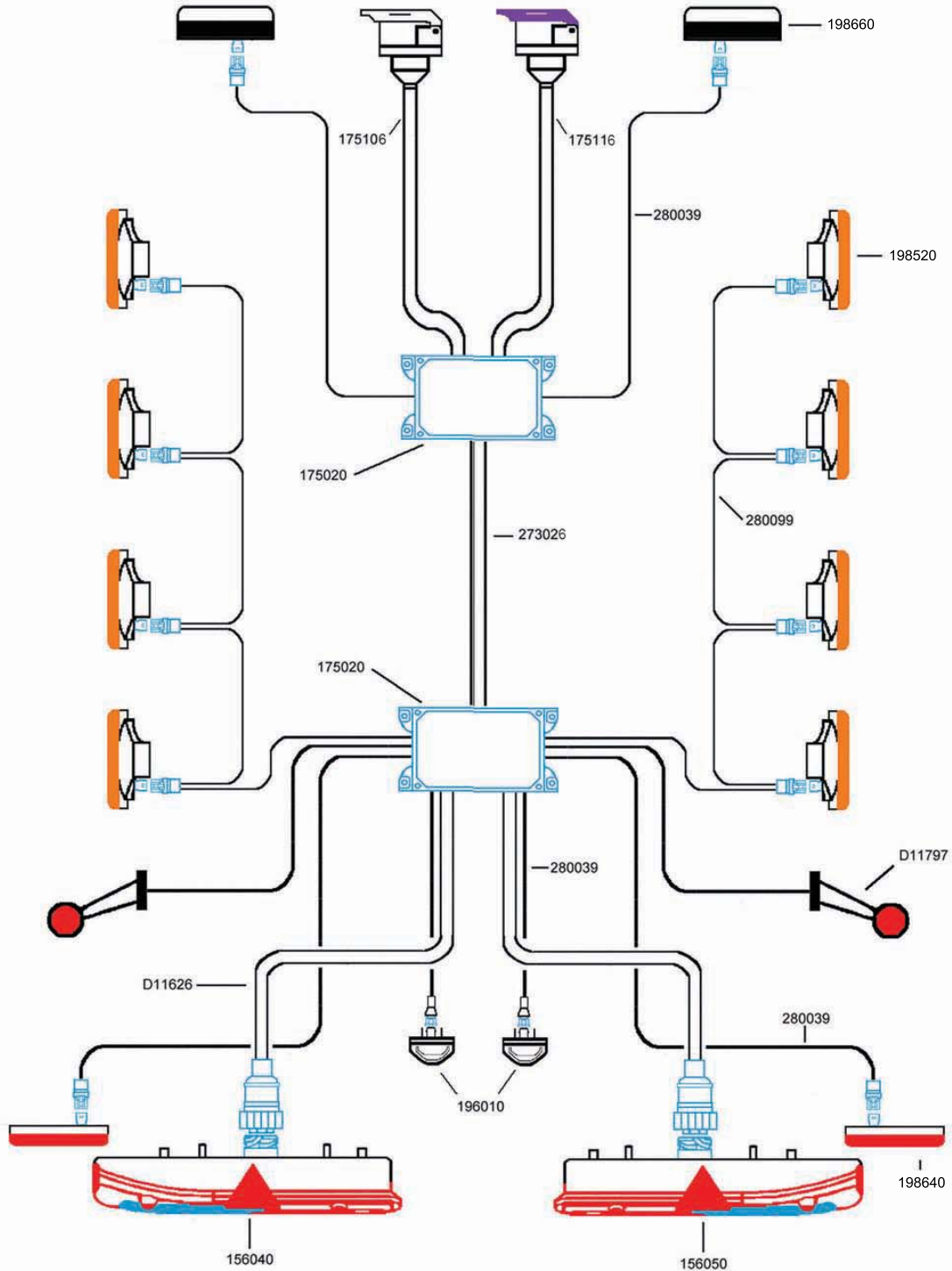

Exemple de montage - Assembly suggestion - Montagebeispiel

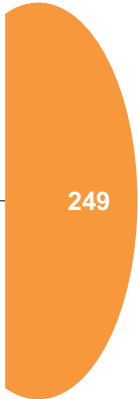

249

**2.5 Electricité remorque - Electric products for trailers - Elektrik für Anhänger/Auflieger**  
**Câblage remorque - Trailers harnesses - Verkabelungsprodukte für Anhänger/Auflieger**

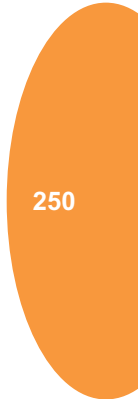
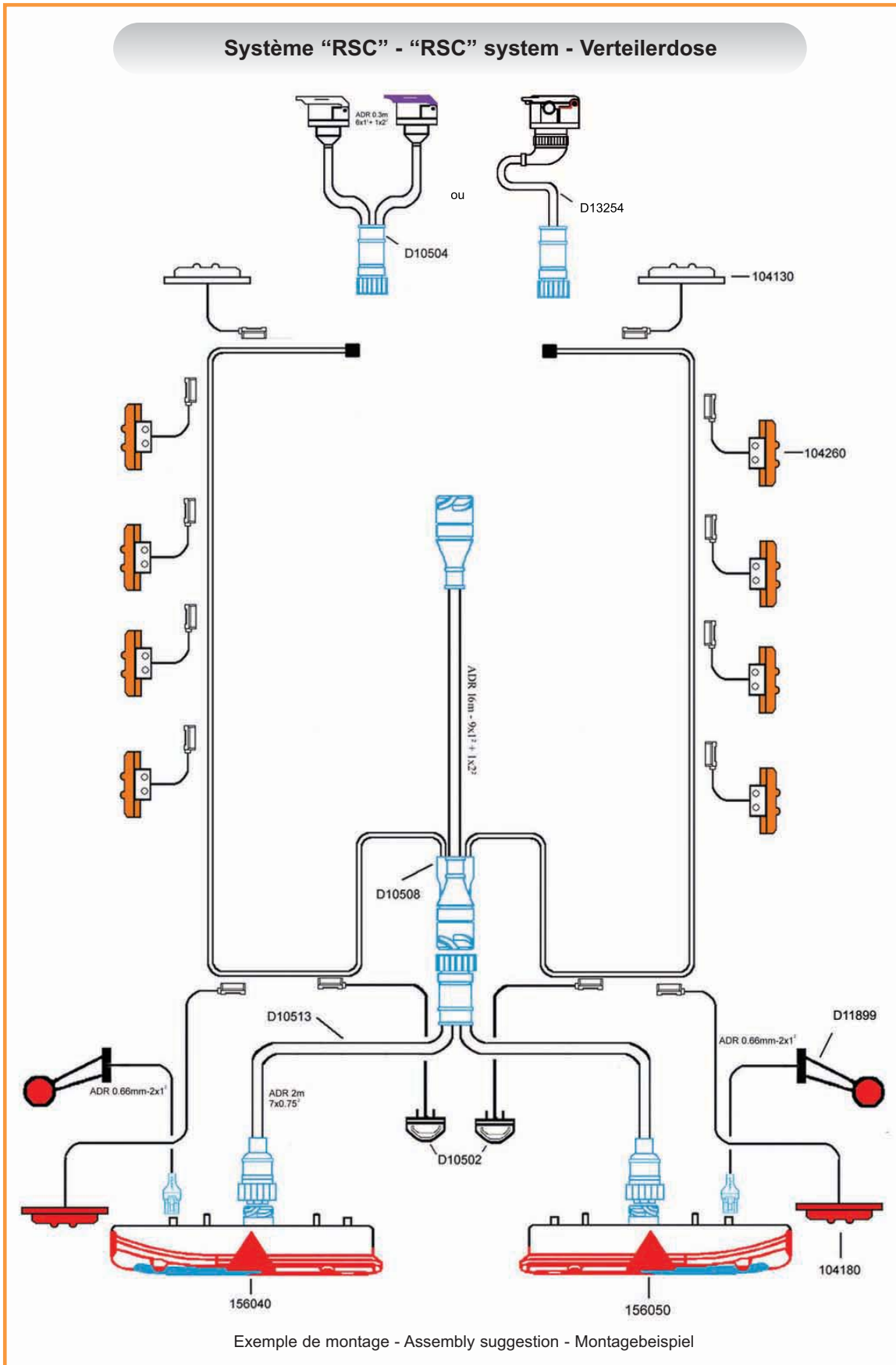

250

**2.5 Electricité remorque - Electric products for trailers - Elektrik für Anhänger/Auflieger**  
**Câblage remorque - Trailers harnesses - Verkabelungsprodukte für Anhänger/Auflieger**

**MDJ**



**Système "MDJ" - Box system - Verteilerdose**

105 mm x 57,5 mm x 42,3 mm

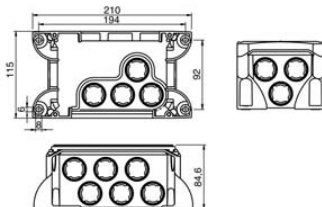

**175020**



**3530060**



<b>câble</b>	Ø 5,9-6,9	<b>175086</b>
<b>cabl</b>	Ø 8,3-10	<b>177136</b>
<b>kable</b>	Ø 11-12	<b>175096</b>

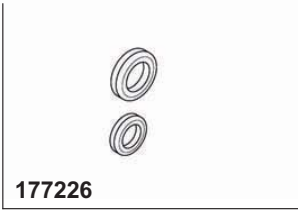

**177226**

Pour gaine annelée  
 For conduit  
 Für GGVS Wellrohr

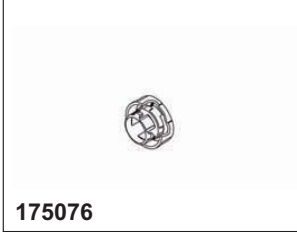

**175076**



**D11889**



**D13248**

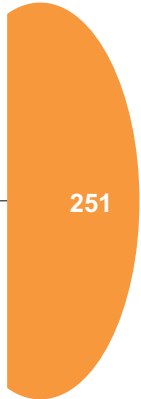

251

## 2.5 Electricité remorque - Electric products for trailers - Elektrik für Anhänger/Auflieger

Câblage remorque - Trailers harnesses - Verkabelungsprodukte für Anhänger/Auflieger

MDJ

**NEW**



**A13179**

Kit de réparation standard partie arrière du véhicule  
Standard repair kit for rear system  
Standard-Reparaturkit für hinteren Kabelstrang

ADR

106 mm x 127 mm x 141,3 mm

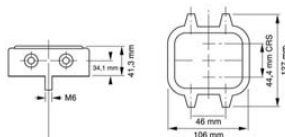

**611090**

8 voies - 8 ways - 8 Verbindungen

252

## 2.5 Electricité remorque - Electric products for trailers - Elektrik für Anhänger/Auflieger

### Câblage remorque - Trailers harnesses - Verkabelungsprodukte für Anhänger/Auflieger

FCA



Pour feux arrière type LC5, LC6, LC7, LC8, LC9 chapitre p. 141

For rear lamps LC5, LC6, LC7, LC8, LC9 chapter p. 141

für Heckleuchten vom Typ LC5, LC6, LC7, LC8, LC9 s. Kapitel Heckleuchten 141



AMP 1.5



Exemple de montage p. 249  
Assembly suggestion p. 249  
Montagebeispiel siehe S. 249

AMP 1.5

Pour/ For / für  
MDJ 175020 p.251

<b>D11626</b>	2500 mm
<b>D11627</b>	4300 mm

AMP 1.5

Fils nus  
Naked cable extremity  
Kabellitze

<b>D11628</b>	2500 mm
<b>280049 *</b>	4000 mm

\* Connecteur coudé à 90°  
\* 90° connector  
\* 90° gewinkelter Stecker

### Rallonges - Extension leads - Verlängerungsschnur

<b>D12449</b>	1000 mm
<b>D12450</b>	2000 mm

**NEW**

Fonction position  
Position function  
Versorgung Schlussleuchte

<b>R12575</b>	A : 3 m / B : 3 m
<b>R12576 *</b>	A : 0,5 m / B : 3 m

\* Pour / For / für LC9 p. 144

### Doubleur de feux - Double rear lamp cable - Doppelanschlusskabel für zwei Heckleuchten

<b>D11689</b>	500 mm
---------------	--------

253



## 2.5 Electricité remorque - Electric products for trailers - Elektrik für Anhänger/Aufleger

### Câblage remorque - Trailers harnesses - Verkabelungsprodukte für Anhänger/Aufleger

FCA



#### Raccordement RSC - RSC connecting - RSC Anschluss

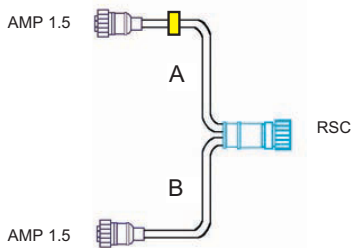

<b>D10513</b>	A : 2 m / B : 2 m	16 V *
<b>D13261</b>	A : 3,5 m / B : 3,5 m	15 V *

■ = gauche - left - links

Faisceau simple pour feux arrière avec surmoulages droits  
Single rear lamp cable with straight overmoulding  
Anschlusskabel für Heckleuchten mit geradem Anschlussstecker

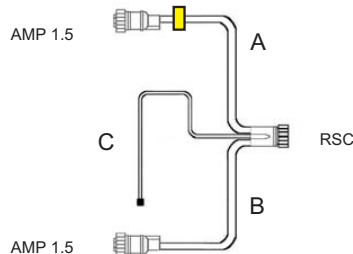

<b>D13262</b>	A : 1,5 m / B : 2,5 m / C : 1,2 m	15 V *
---------------	-----------------------------------	--------

■ = gauche - left - links

Faisceau simple pour feux arrière avec surmoulages droits avec câbles plats  
Single rear lamp cable with straight overmoulding and flat cables  
Anschlusskabel für Heckleuchten mit geradem Anschlussstecker und Flachkabel

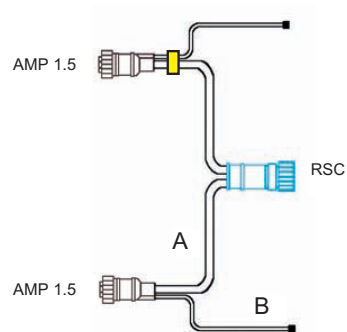

<b>D10514</b>	A : 2 m / B : 0,5 m	16 V *
<b>D10515</b>	A : 2 m / B : 16 m	16 V *

■ = gauche - left - links

Faisceau pour feux arrière avec câble plat et surmoulages droits  
Rear lamp cable with flat cables and straight overmoulding  
Anschlusskabel für Heckleuchten mit Flachkabel und geradem Anschlussstecker

\* 16 voies - poles - Pölige Stecker  
\* 15 voies - poles - Pölige Stecker

Exemple de montage p. 250  
Assembly suggestion p. 250  
Montagebeispiel siehe S. 250

254

KIT

#### Kits de réparation pour feux arrière - Rear lamps repair kits - Reparatursatz für Heckleuchten



**D11868**

Connecteur AMP 1.5 simple  
Single AMP 1.5 connector  
Anschlussstecker AMP 1.5



**D11865** | 500 mm

Connecteur AMP 1.5 avec câble plat  
AMP 1.5 connector with flat cable  
Anschlussstecker AMP 1.5 mit Flachkabel



## 2.5 Electricité remorque - Electric products for trailers - Elektrik für Anhänger/Auflieger

### Câblage remorque - Trailers harnesses - Verkabelungsprodukte für Anhänger/Auflieger

#### FCA

Pour éclairer de plaque EPP98 p. 177 et feux de position type SMD98, FE98 et FPL93 chapitre p. 187

For number plate lamp EPP98 p. 177 and position lamp SMD98, FE98, and FPL93 chapter p. 187

für Kennzeichenleuchte EPP98 S. 177 und Markierungsleuchten SMD98, FE98 und FPL98 s. Kapitel 187



AMP JPT

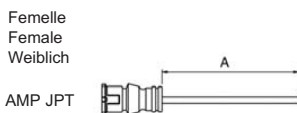

Fils nus  
Naked cable extremity  
Kabellitze

<b>280009</b>	A : 2 m
<b>280019</b>	A : 4 m
<b>280029</b>	A : 6 m

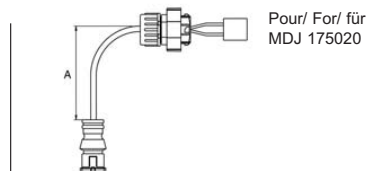

<b>280039</b>	A : 4 m
---------------	---------

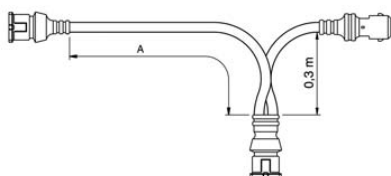

<b>280059</b>	A : 3,5 m
<b>280069</b>	A : 5,5 m

Femelle  
Female  
Weiblich

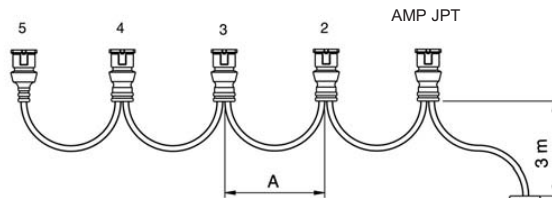

2 x AMP-JPT	-	A : 5,5 m	<b>280119</b>
3 x AMP-JPT	A : 3,5 m	<b>280089</b>	A : 5,5 m <b>280129</b>
4 x AMP-JPT	A : 3,5 m	<b>280099</b>	A : 5,5 m <b>280139</b>
5 x AMP-JPT	A : 3,5 m	<b>280109</b>	A : 5,5 m <b>280149</b>

Pour/ For/ für MDJ 175020

Exemple de montage p. 249  
Assembly suggestion p. 249  
Montagebeispiel siehe S. 249

255

#### KIT

### Kits de réparation pour feux latéraux - Side marker lamps repair kits Reparaturatz für Positionsleuchten

AP

Autoperforant pour raccordement sur câble plat  
Click-in for flat cable  
Click-in-Anschluss für Flachkabel



<b>001796</b>	500 mm
<b>001806</b>	1500 mm



<b>001786</b>	500 mm
<b>001776</b>	1500 mm

## 2.5 Electricité remorque - Electric products for trailers - Elektrik für Anhänger/Auflieger

### Câblage remorque - Trailers harnesses - Verkabelungsprodukte für Anhänger/Auflieger

PRL

#### Prolongateurs - Main supply cable - Haupt-Verlängerungskabel

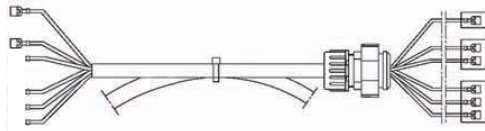

<b>273026</b>	15 m
---------------	------

Prolongateur MDJ ref. 175020 p.251  
Main supply cable for ref. 175020 p.251  
Haupt-Verlängerungskabel für ref. 175020 p.251

Exemple de montage p. 249  
Assembly suggestion p. 249  
Montagebeispiel siehe S. 249



<b>D10507</b>	10 m	16 V *
<b>D10505</b>	16 m	16 V *
<b>D13263</b>	15 m	15 V *

Prolongateur RSC simple  
Single RSC main supply cable  
Haupt-Verlängerungskabel für RSC

Exemple de montage p. 250  
Assembly suggestion p. 250  
Montagebeispiel siehe S. 249

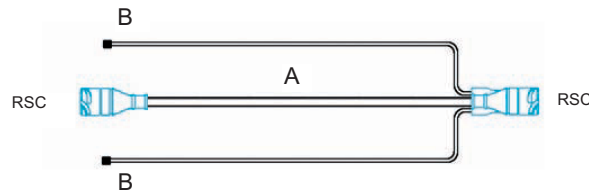

<b>D10510</b>	A: 10 m / B: 10 m	16 V *
<b>D10509</b>	A: 13 m / B: 13 m	16 V *
<b>D10508</b>	A: 16 m / B: 16 m	16 V *
<b>D13260</b>	A: 15 m / B: 0,27 m	15 V *

Prolongateur avec câbles plats  
Main supply cable with flat cables  
Haupt-Verlängerungskabel mit eingegossenem Flachkabel

\* 16 voies - poles - Pöilige Stecker  
\* 15 voies - poles - Pöilige Stecker

**NEW**



**D13249**

Connecteur RSC femelle presse étoupe  
Female RSC connector with o'ring  
weiblicher RSC Stecker mit Kabelverschraubung

**NEW**



**D13250**

Connecteur RSC mâle presse étoupe  
Male RSC connector with o'ring  
männlicher RSC Stecker mit Kabelverschraubung

256

## 2.5 Electricité remorque - Electric products for trailers - Elektrik für Anhänger/Auflieger

### Câblage remorque - Trailers harnesses - Verkabelungsprodukte für Anhänger/Auflieger

ADP

Chapitre Prises et Cordons de liaison p. 244  
 Chapter Cable and Plugs p.244  
 Kapitel Anschlusskabel und Steckverbindungen siehe S. 244



24N / 24S  
15P

Exemple de montage p. 249  
 Assembly suggestion p. 249  
 Montagebeispiel siehe S. 249

Pour/ For / für  
MDJ 175020 p.251

175106	700 mm	24S
--------	--------	-----

Faisceau prise 24 S  
 Cable with plug 24 S  
 Anschlusskabel mit Steckdosen 24S

Pour/ For / für  
MDJ 175020 p.251

175116	700 mm	24N
--------	--------	-----

Faisceau prise 24 N  
 Cable with plug 24 N  
 Anschlusskabel mit Steckdosen 24N

RSC

D10504	1000 mm	24N-24S	16 V *
D13257	1500 mm	24N-24S	15 V *

Faisceau prises 24 N&S  
 Cable with plugs 24 N&S  
 Anschlusskabel mit Steckdosen 24N/24S

NEW

Exemple de montage p. 250  
 Assembly suggestion p. 250  
 Montagebeispiel siehe S. 250

RSC

D13254	1000 mm	15 P	16 V *
D13255	600 mm	15 P	15 V *

Faisceau prise 15P  
 Cable with plug 15P  
 Anschlusskabel mit Steckdosen 15P

NEW

\* 16 voies - poles - Pöilige Stecker  
 \* 15 voies - poles - Pöilige Stecker

RSC

D13256	300 mm	15 P-24N-24S	15 V *
--------	--------	--------------	--------

Faisceau prise 15P - 24N-24S  
 Cable with plug 15P - 24N-24S  
 Anschlusskabel mit Steckdosen 15P - 24N-24S

NEW

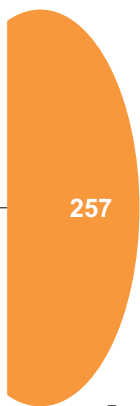

257

## 2.5 Electricité remorque - Electric products for trailers - Elektrik für Anhänger/Auflieger

### Câblage remorque - Trailers harnesses - Verkabelungsprodukte für Anhänger/Auflieger

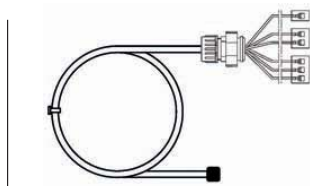

Pour/ For / für  
MDJ 175020 p.251

Câble plat pour module de jonction  
ref. 175020

Flat cable for junction box p/n. 175020

Flachkabel für Verteilerdose ref.  
175020

CP



Câble plat  
Flat cable  
Flachkabel

<b>001816</b>	16 m
---------------	------

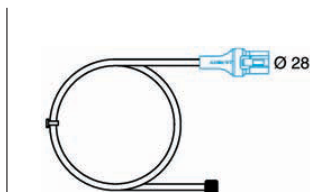

Pour/ For / für  
LC8 p.145

Câble plat optionnel avec connecteur  
2 voies pour repiquage sur feu arrière  
LC8

Optional flat cable with 2-pin connector  
to plug-in LC8 rear lamp

Flachkabel mit 2-poligem  
Anschlussstecker zum direkten  
Anschluss an die Heckleuchte LC8

<b>D11147</b>	500 mm
<b>D10520</b>	16 m

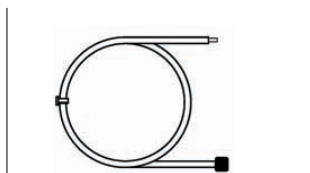

Fils nus  
Naked cable extremity  
Kabellitze



**4330012**

Bouchon pour câble plat  
Cap for flat cable  
Abschlussstopfen für Flachkabel

Câble plat - Flat cable - Flachkabel

ACC

258



<b>D10517</b>	500 mm
<b>D10518</b>	1500 mm
<b>D10519</b>	3500 mm



**D10132**



**151236**

Verrou pour click-in à usage unique  
Clamp for click-in, single use  
Einmal click-in Riegel



**001826**

Obtuteur seal-in  
Seal-in obturator  
Verschlussöse seal-in



**9115118**

Pince pour click-in  
Pliers for click-in  
Montagezange für click-in-Befestigung



**D13251** 1 Kg

Graisse anti-corrosion  
Anti-corrosion grease  
Korrosionsschutzfett



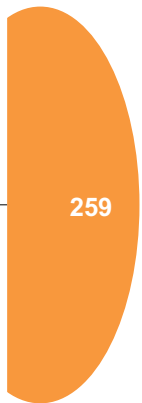

259



**3**

**Recherche produits - Products research - Produktsuche**

- 3.1** Par liste de correspondance - By cross list - nach Hersteller-Nr. .... **p.261**
- 3.2** Par no. d'homologation - By homologation number - nach Homologationsnummer ..... **p.264**
- 3.3** Par photo - By pictures - nach Abbildung ..... **p.265**
- 3.4** Par référence - By part number - nach Artikelnummer ..... **p.271**



### 3.1 Par liste de correspondance - By cross list - nach Hersteller-Nr.

Constructeur	Ref. constructeur	Ref. Vignal			
Manufacturer	OES P/N	Vignal P/N			
Erbauer	Art.-Nr. OES	Art.-Nr. Vignal			
<b>DAF</b>	698603	040500	<b>IRISBUS</b>	5001020318	119410
	0867930	196010		5001834505	195030
	1272653	067500		5001834564	001606
	1284211	167640		5001834568	001616
	1284212	167630		5001834576	195060
	1304788	168010		5001837993	001626
	1304789	168020		5001847589	001726
	1329718	193020		5010086923	185010
	1401713	152180		5010086924	185030
	1401731	152170		5010177690	191100
	1403887	195010		5010179915	167150
	1451482	052500		5010197259	191170
	1524495	169190		5010197260	191110
	1608352	001726		5010197261	191140
	1625985	169160		5010197262	191120
	1625986	169170		5010197938	10330613
	1626101	119550		5010217022	185020
	1626102	001616		5010286898	195000
	1653605	193200		5010286903	119500
	1785561	169380		5010286904	119510
	1785562	168890		5010306792	193020
	2922224	141640		5010403075	197080
	1626319/1284213	168100		5010403076	197070
	1626320/1284214	168390		7701025919	20860705
	1814096/1815754	109010		7701025921	20860805
				50101972564	191150
	<b>ERF</b>	35-20416-9922		169280	<b>IVECO</b>
35-20416-9939		169180	41221040	119930	
403721-0		168100	42555041	110530	
404514-6		168090	42555042	110520	
411804-2		198520	42555131	D12337	
411828-5		119470	42555132	D12336	
<b>FODEN</b>	62-00109-000	196010	69500026	D12335	
	62-01143-000	168100	69500032	D12334	
	62-01143-000	168340	93161844	067500	
	62-01143-001	168090	97163920	119550	
	62-01143-001	168270	99463242	168600	
	Y 058 701 02	067500	99463243	168590	
<b>HEULIEZ</b>	3156201	067000	99463244	168610	
	0190408700	181000	500308514	193020	
	0190439000	179240	500356782	D11481	
	0190552400	181050	500356783	D11482	
	190825600	193020	504083205	168480	
	5010104837	185050	<b>MAN</b>	8125225-6033	168090
	5010217022	185020		8125225-6034	168100
	5010271501	195030		8125225-6469	166700
	5010312524	195060		8125225-6523	169170
	2773801/2870801	167150		8125225-6524	169160
		8125225-6526		169180	
		8125225-6528		168490	
		8125225-6530		169190	
		8125225-6544		156200	
		8125225-6545		156210	
<b>IRISBUS</b>	504217797	198650	8125225-6547	156220	
	5000461058	181000	8125229-6051	067500	
	5000461059	181050	8125229-6059	056500	
	5000461059	181050	8125229-6060	056510	
	5000786265	179210			
	5000804703	079010			
	5000953043	118100			
	5001020257	119550			
	5001020317	119400			

261

### 3.1 Par liste de correspondance - By cross list - nach Hersteller-Nr.

Constructeur	Ref. constructeur	Ref. Vignal			
Manufacturer	OES P/N	Vignal P/N			
Erbauer	Art.-Nr. OES	Art.-Nr. Vignal			
<b>MANITOU</b>	163782	500930	<b>RENAULT TRUCKS</b>	5001834559	119410
	163783	500940		5001834560	119400
	223766	152180		5001834561	195010
	223767	152180		5001834565	119450
			5001834568	001616	
<b>MERCEDES</b>	0008202864	672000	5001835853	168140	
	A9068200464	156340	5001846843	152000	
	A9068201764	156350	5001846844	152010	
	A9068262056	056540	5001846845	152040	
	A9068262156	056550	5001846846	152050	
			5001846847	152020	
<b>NISSAN</b>	26164-9X402	119550	5001846848	152030	
	26244-9X400	001616	5001846849	152060	
	26554-9X126	052500	5001846850	152070	
	26555-9X125	152180	5001847153	052500	
	26555-9X126	152170	5001847582	169060	
			5001847583	169070	
<b>RENAULT AGRI</b>	7701020232	10451605	5001847584	169000	
	7700620025/78	10450605	5001847585	169010	
	7700027564	196020	5001847586	169020	
	7700647067	20660617	5001847587	169030	
	7700694211	125200	5001847588	067500	
	7700694212	125100	5001847589	001726	
	7701020229	20661609	5001847597	119470	
			5001857964	152510	
<b>RENAULT TRUCKS</b>	003603705	016600	5001857965	152520	
	0027567009	116600	5001857966	152610	
	5000296591	166000	5001857967	152620	
	5000296591	166100	5001858092	152500	
	5000296592	167100	5001858093	152600	
	5000296592	167000	5001862030	102200	
	5000296593	066000	5001864535	169310	
	5000296594	067000	5001864536	169320	
	5000296718	088010	5001864537	169330	
	5000360941	31130701	5010040505	178340	
	5000360942	31130801	5010217022	185020	
	5000459966	117920	5010217023	185040	
	5000459967	117910	5010231061	117700	
	5000461058	181000	5010231161	125200	
	5000461059	181050	5010271775	10850605	
	5000462758	10850603	5010271807	185160	
	5000463046	186030	5010293829	196010	
	5000463047	186040	5010306711	118440	
	5000589493	135100	5010306792	193020	
	5000589493	135200	5010392231	052000	
	5000623050	188310	7420802348	159010	
	5000623398	125430	7420802350	159020	
	5000789306	182020	7420802353	159030	
	5000803784	035000	7420802418	059000	
	5000807304	040000	7420862032	152880	
	5000808095	087040	7420862038	152190	
	5000808166	040500	7420862041	152200	
	5000808171	141000	7421106206	198650	
	5000808172	141500	7421268609	191170	
	5000810542	025210	7421396991	D13019	
	5000815760	141110	7421396993	D13020	
	5000815761	141310	7421430181	104290	
	5001825075	025200	7485114646	104510	
	5001831194	168220	7700353021	196020	
	5001832999	168260	7700377094	197040	

### 3.1 Par liste de correspondance - By cross list - nach Hersteller-Nr.

Constructeur	Ref. constructeur	Ref. Vignal
Manufacturer	OES P/N	Vignal P/N
Erbauer	Art.-Nr. OES	Art.-Nr. Vignal
<b>RENAULT TRUCKS</b>	7700377095	197050
	7700377130	620236
	7701026300	20661609
	8200602314	620056
	7701026301/302	20660617
<b>SANTANA</b>	791123	152180
	A610067-002	052500
<b>SCANIA</b>	1350343	067500
	1365963	168350
	1365964	168360
	1365965	168370
	1365966	168380
	1784669	056540
	1784670	056550
	2021578	155020
	1756751	156780
	1756754	156770
	1791369	156790
	2021575	156780
	2021576	156790
	2021579	156770
	<b>VOLKSWAGEN</b>	2E0 945 095 A
2E0 945 096 A		156350
2E0 945 111 A		056540
2E0 945 112 A		056550
<b>VOLVO</b>	1374260	196010
	11170068	198520
	20480486	198650
	20537280	052000
	20733983	119550
	20734485	193020
	20745060	052500
	20745066	001616
	20745225	195010
	20769781	152880
	20769783	152190
	20769784	152200
	20789440	198620
	20802346	159010
	20802350	159020
	20802353	159030
	20802418	059000
	21087346	207010
	21087347	207020
	82114500	107010
	82114502	107050
	82114504	107040
	82114506	107000
	82116545	207000
	85105029	001766

263



### 3.2 Par n° d'homologation - By homologation number - nach Homologationsnummer

N°	Désignation	Page	N°	Désignation	Page	N°	Désignation	Page
No.	Name	Page						
Nb	Bezeichnung	Seite						
E2 52	1122	180	E2 5047	ICDL94	184	E3 52310	725	161
E2 78	FM76	173	E2 5052	FE95	195	E3 52312	725	161
E2 109	0207	185	E2 5060	1085	181	E1 53329	BBS516	166
E2 111	0207	185	E2 5117	C195	178	E1 63216	672	159
E2 112	0207	185	E2 5126	FE95	212	E1 63221	672	159
E2 113	C166	171	E12 6065	688	170	E2 86038	1045	182
E2 130	1122	180	E11 6219	BX816	181	E2 86708	FE85	184
E2 136	FM76	173	E2 7001	EPP96	177	E2 86710	FE87	192
E2 146	LA25	167	E2 7001	EPP98	177	E2 86711	FE87	210
E2 166	C179	180	E12 7091	688	170	E2 87002	1085	181
E2 193	FE81	204	E2 7102	FE02	191	E2 87072	0144	194
E2 219	0207	211	E2 7102	FPL93	191	E2 87078	0148	186
E2 314	FE80	196	E12 7128	680	170	E2 87101	2086	160
E2 363	3113	182	E2 7139	ICDL94	184	E2 87712	C184	179
E2 393	2132	169	E12 7147	LB21	172	E2 87714	FE86	195
E2 402	1122	180	E2 8003	FM97	174	E2 88017	LC7	153
E2 446	2132	169	E2 8004	FM97	174	E2 88033	LC6	156
E2 462	LA25	167	E2 8005	LC5	150	E2 88034	LC6	156
E2 521	LA25	167	E2 8034	FM97	174	E2 88035	LC7	153
E2 530	C166	171	E2 8035	FM97	174	E2 88042	FG82	194
E2 621	C166	171	E2 8040	SMD98	198	E2 88714	FE88	202
E2 669	C178	181	E13 8434	725	163	E2 90116	2066	169
E13 697	FRR	173	E2 9014	FM97	174	E2 90117	1045	182
E13 698	FRR	173	E2 9033	FE85	184	E2 90123	SM84B	191
E2 727	0207	193	E13 9035	726	164	E2 90123	SM84	202
E2 781	FE80	196	E2 9036	FE85	212	E2 90711	FE81	185
E2 864	LA38	166	E2 9037	FE85	195	E2 90715	LC4B	204
E2 896	SM84	210	E2 9056	LC7T	155	E2 90715	FEA801	204
E2 915	FE80	196	E13 9657	FRR	172	E2 90724	LA35	165
E4 0001	VC104	216	E2 00651	GR4	239	E2 91098	LC4	157
E2 0050	C199	178	E2 00759	GR5	238	E2 91099	LC4	157
E2 1051	LA38	166	E2 00760	PR1	241	E2 91714	C177	180
E2 1052	LA38	166	E2 00764	EGM1	240	E2 92004	LA25	167
E9 1084	672	201	E2 01740	GR6	238	E2 92025	4030	176
E2 1295	SMD00	197	E2 01800	EGM3	237	E2 92057	FM91	175
E1 1559	BBS516	166	E2 01801	PM2	238	E2 92058	FM91	175
E2 2040	LC8	145	E20 02465	FRC	172	E2 92059	FM91	175
E13 2060	725	163	E2 04010	SMD98	189	E2 92060	FM91	175
E2 2065	SMD98	208	E2 04075	LC9	144	E2 92061	FM91	175
E2 2121	0204	212	E2 05010	FE04	187	E2 92062	FM91	175
E2 2785	FE79	211	E2 05010	FE07	188	E2 92098	C181	179
E2 3703	FE79	185	E2 05011	FE04	207	E2 92700	C180	179
E2 3704	FE79	193	E2 05021	SMD04	197	E2 92702	FE79	203
E2 4054	FPL93	201	E2 05022	SMD04	188	E2 97073	0149	211
E2 4088	FE94/98	189	E2 05023	SMD04	208	E4 017016	VC 70.01	215
E2 4089	FE94/98	189	E2 05032	LC3	171			
E2 4090	FE94/98	209	E2 06018	C105	178			
E2 4091	FE94/98	209	E2 06024	LC5T	151			
E2 4092	FE94/98	199	E2 07092	LC5T (DX)	205			
E2 4093	FE94/98	199	E2 07176	LC1R	173			
E2 4136	0204	182	E2 07177	LC1B	173			
E2 4136	0204	186	E2 08028	SRD07	183			
E11 4249	BX868	176	E2 08110	LC8LED	141			
E2 4701	FE87	202	E2 09025	ICDL07	183			
E2 4702	FE79	203	E11 10532	DX	205			
E2 4703	FE87	184	E1 21628	671	194			
E2 5004	GR8	236	E1 21633	PLR272	192			
E2 5005	PM3	237	E3 47364	725	161			
E2 5006	EGM8	236	E3 52308	725	161			
E2 5040	C194	179	E3 52309	725	161			

### 3.3 Par photo - Products research - Produktsuche

#### 2.1 Feux arrière - Rear lamps - Heckleuchten



 p. 141	 p. 144	 p. 145	 p. 146
 p. 147	 p. 148	 p. 150	 p. 151
 p. 153	 p. 155	 p. 156	 p. 157
 p. 158	 p. 159	 p. 159	 p. 160
 p. 160	 p. 161	 p. 163	 p. 164
 p. 165	 p. 166	 p. 167	 p. 169
 p. 169	 p. 170	 p. 170	 p. 171

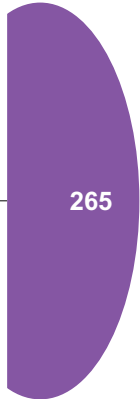

265

### 3.3 Par photo - By picture - nach Abbildung



### 2.2 Feux clignotants - Flasher lamps - Fahrtrichtungsanzeiger

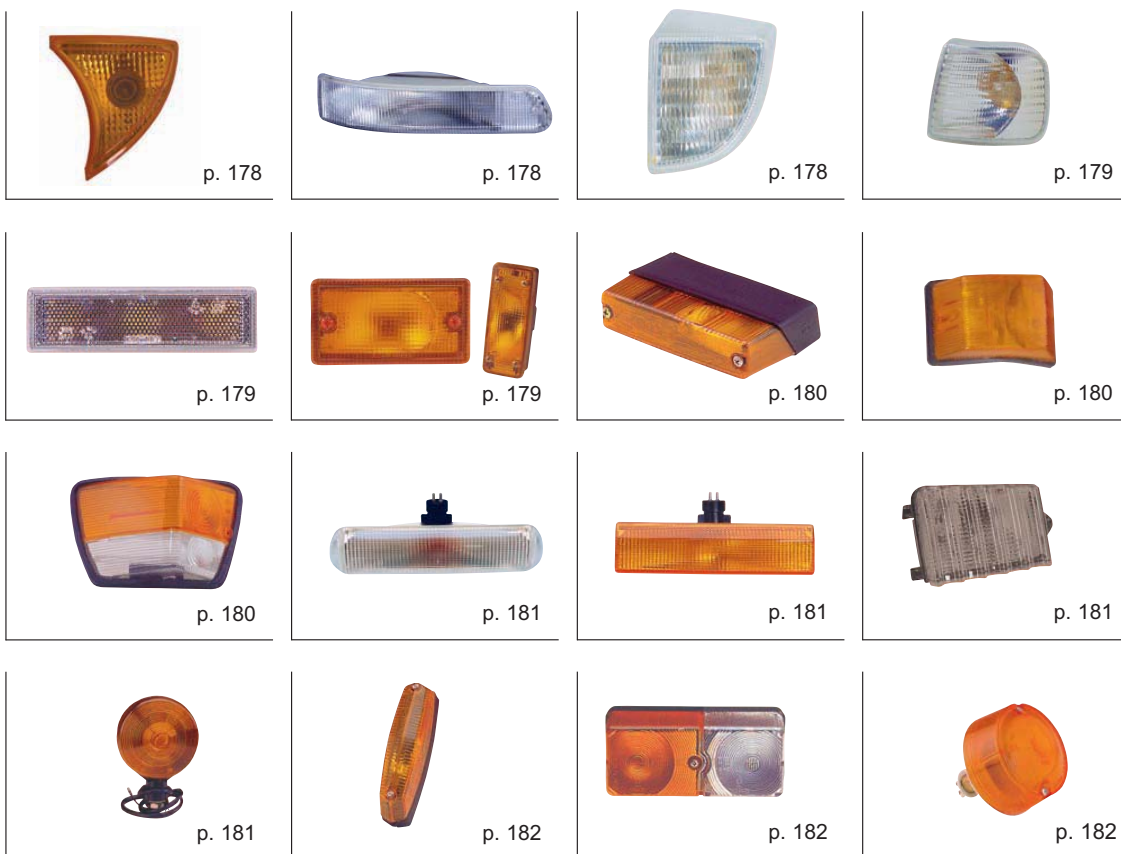



### 3.3 Par photo - Products research - Produktsuche

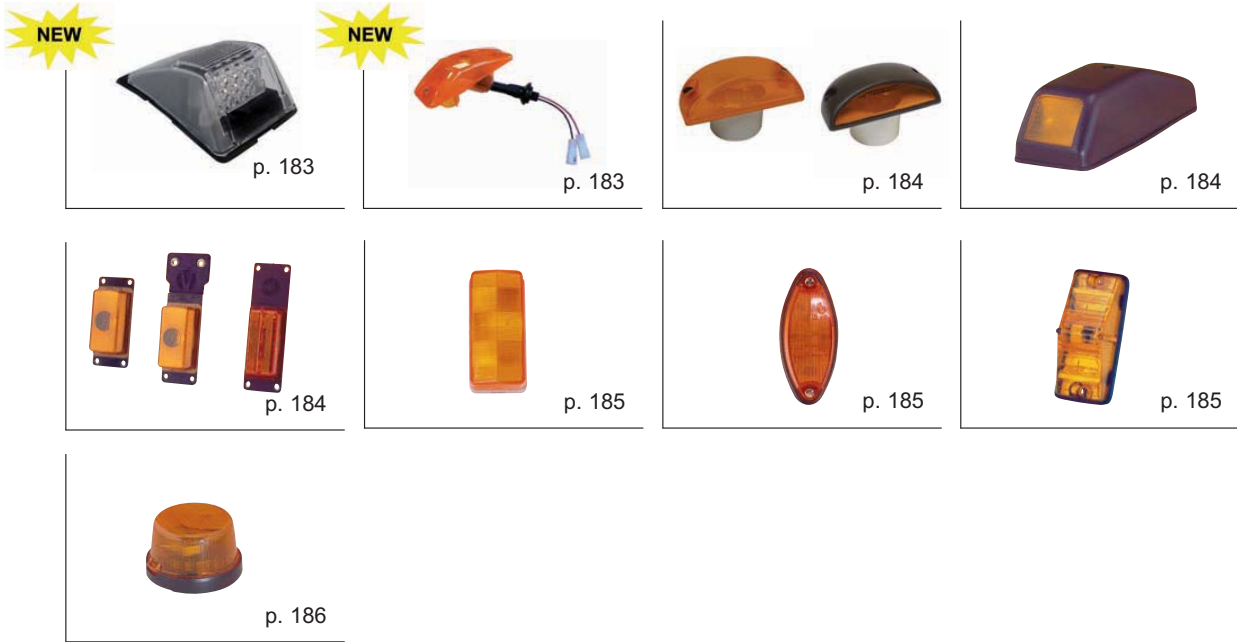

### 2.3 Feux de position - Position lamps - Positionsleuchten



267



### 3.3 Par photo - Products research - Produktsuche

 <p>p. 195</p>	 <p>p. 196</p>	 <p>p. 192</p>	 <p>p. 197</p>
 <p>p. 197</p>	 <p>p. 198</p>	 <p>p. 199</p>	 <p>p. 201</p>
 <p>p. 201</p>	 <p>p. 202</p>	 <p>p. 202</p>	 <p>p. 203</p>
 <p>p. 203</p>	 <p>p. 204</p>	 <p>p. 205</p>	 <p>p. 205</p>
 <p>p. 205</p>	 <p>p. 206</p>	 <p>p. 207</p>	 <p>p. 208</p>
 <p>p. 208</p>	 <p>p. 209</p>	 <p>p. 210</p>	 <p>p. 210</p>
 <p>p. 211</p>	 <p>p. 211</p>	 <p>p. 211</p>	 <p>p. 212</p>

### 3.3 Par photo - Products research - Produktsuche



### 2.4 Produits complémentaires - Complementary products - Ergänzende Produkte

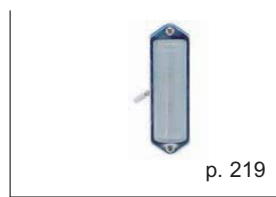
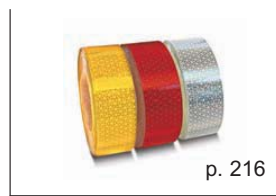
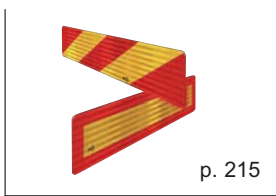
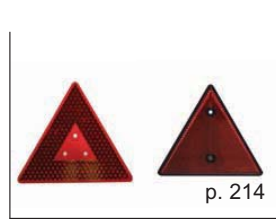
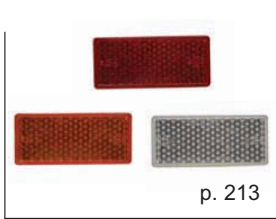
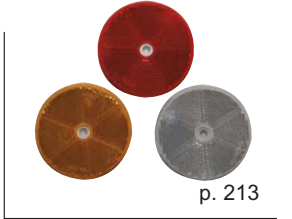

269

### 3.3 Par photo - Products research - Produktsuche



### 2.5 Electricité remorque - Electric products for trailers - Elektrik für Anhänger/Auflieger

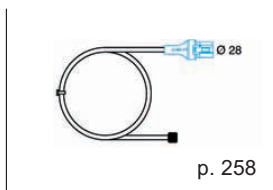
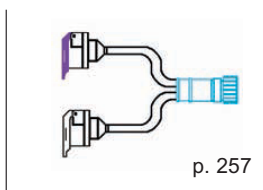
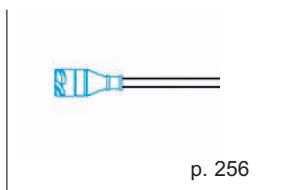

### 3.4 Par référence - By part number - nach Artikelnummer

Référence	Page						
P/N	Page						
Art.-Nr.	Seite						
501	234	000086	185, 204	056710	148	107040	183
921	234	000176	177, 185	056720	149	107050	183
1056	231		190, 193	056730	149	109010	183
1057	231		200, 203	057000	142, 143	110520	178
1060	231		204, 209	059000	144	110530	178
1073	231	001586	190, 200	066000	156	116600	171
1077	231		209	066500	156	117700	180
1078	231	001596	190, 200	067000	154	117910	180
1114	231		209	067500	154	117920	180
1115	231	001606	174, 178	067600	155	118000	179
1117	231		179	067610	155	118100	179
1122	231	001616	179, 184	079010	204	118440	179
1143	231	001626	15, 17	079020	193	119400	179
1931	230		20, 22	079030	211	119410	179
1937	230	001656	154	079040	185, 204	119450	184
2618	232	001696	189, 198	080026	196	119470	184
2619	232		200, 208	080046	196	119500	178
2626	232	001706	154	080126	158, 204	119510	178
2627	232	001716	189, 198	080136	158, 204	119550	184
2640	232		200, 201	080156	158, 204	119920	178
2641	232		208	087020	192	119930	178
2643	232	001726	191, 201	087030	210	125100	167
2656	233		218	087040	184, 202	125200	167
2660	233	001746	152	087050	192	125300	167
2661	233	001766	197	088010	203	125310	167
2662	233	001776	255	094016	200	125350	167
2663	233	001786	255	094026	200	125430	167
5301	233	001796	255	094036	190	135200	165
5304	234	001806	255	094046	190	135300	165
5305	234	001816	258	094056	209	138000	166
7440	234	001826	258	094066	209	141000	157
7443	234	001830	225	102200	191, 218	141110	158
7546	232	001846	148	103000	171	141310	158
7552	232	001916	201	103020	171	141500	157
7575	232	001940	200, 209	103030	173	141640	7
7576	232	014080	227	103040	173	142500	16
7579	232	014580	227	103050	173	151236	258
7580	232	016600	171	103060	173	152000	52, 55
7592	232	017900	180	103070	171	152010	52
7593	233	018006	179	103080	171	152020	43, 52
7594	232	025100	168	103090	173		55
7595	233	025110	168	103100	173	152030	52
9005	230	025200	168	103110	173	152040	52
9006	230	025210	168	103120	173	152050	52
9145	230	025300	168	104090	197	152060	52
50400	228	025310	168	104100	197	152070	52
52710	229	035000	165	104130	188	152130	150
52830	233	035300	165	104140	188	152140	150
53500	230	038000	166	104170	208	152150	150
53510	230	040000	157, 158	104180	208	152160	150
58540	233	040500	157	104210	197	152170	150
58560	230	052000	150	104220	197	152180	150
91192	228	052500	150	104250	197	152190	150
91376	231	053700	152	104260	197	152200	150
91602	233	053710	152	104290	187	152500	43, 55
91605	233	056000	145	104300	187	152510	43, 55
91622	234	056010	145	104310	187	152520	43, 55
91701	232	056020	146	104330	207	152600	55
91702	232	056030	146	104340	207	152610	55
91715	232	056500	145	104360	207	152620	55
91761	233	056510	145	104510	187	152880	53, 56
000046	157, 158	056540	146	104520	188		75
	165	056550	146	107000	183	153000	151
		056700	148	107010	183	153010	151



### 3.4 Par référence - By part number - nach Artikelnummer

Référence	Page						
P/N	Page						
Art.-Nr.	Seite						
153020	151	167600	153	176050	173	194130	190
153030	151	167630	8	176100	220	194140	190
153040	151	167640	8	177136	251	194150	190
153050	151	168010	8	177226	251	194190	190
153060	151	168020	8	178340	184	194250	209
153070	151	168090	153	179210	203	194260	209
153120	150	168100	153	179220	193	194270	209
153130	151	168140	43, 48	179230	211	194310	209
153660	152	168220	39, 43	179240	185, 203	195000	20, 22
153670	152		48, 67	179310	203	195010	195
153700	152	168260	39, 43	179320	193	195030	195
153710	152		48, 67	179340	185, 203	195060	212
155020	146	168270	153	179350	204	196010	177
156040	147	168340	153	180010	196	196020	177
156050	147	168350	71	180030	196	197040	174
156060	147	168360	71	180040	196	197050	174
156070	147	168370	71	180050	196	197060	174
156130	147	168380	71	180100	204	197070	174
156150	147	168390	7, 12	180130	158	197080	174
156170	147		13	180220	196	198010	199
156190	147	168480	27	180240	196	198020	199
156200	145	168490	29	181000	204	198030	199
156210	145	168590	23, 26	181050	185	198040	189
156220	145		28	181070	185	198050	189
156250	149	168600	23, 25	182020	194	198060	209
156260	149		26, 27	185010	195	198510	198
156290	145		28	185020	195	198520	198
156300	145	168610	25, 26	185030	212	198530	198
156310	145		27	185040	184	198540	198
156340	146	168770	155	185050	212	198620	197
156350	146	168780	155	185160	184	198640	208
156380	149	168790	155	186030	195	198650	198
156390	149	168800	155	186040	195	198660	189
156540	145	168830	155	187120	192	198690	189
156550	145	168890	8	187130	210	207000	188
156590	146	169000	39, 44	187140	184, 202	207010	188
156600	146		48, 53	187150	192	207020	188
156630	148	169010	39, 44	187720	192	240346	213
156640	148		48, 53	187730	210	240356	213
156770	146	169020	39, 44	187760	184, 202	240366	213
156780	146		47	187770	192	241346	214
156790	146	169030	39, 44	188010	202	241356	214
157000	142		47	188110	203	241366	214
157010	142	169060	38, 42	188210	203	273026	256
157040	143	169070	38, 42	188310	203	280009	255
157050	143	169160	154	188610	203	280019	255
157060	142	169170	154	188710	202	280029	255
157070	142	169180	154	191100	175	280039	255
159010	144	169190	154	191110	175	280049	253
159020	144	169280	154	191120	175	280059	255
159030	144	169310	40, 45	191140	175	280069	255
166000	156		48	191150	175	280089	255
166100	156	169320	40, 45	191160	175	280099	255
166500	14, 16		48	191170	175	280109	255
166600	156	169330	40, 45	193020	201	280119	255
166700	31		48	193170	201	280129	255
167000	153	169380	8	193200	191	280139	255
167001	63	175020	251	193280	201	280149	255
167100	153	175076	251	194010	199	350049	218
167150	14, 16	175086	251	194020	199	465219	216
	17	175096	251	194030	199	465229	216
167500	153	175106	257	194070	199	465239	216
167530	155	175116	257	194080	199	465319	216
167550	155	176000	173	194090	199	465329	216

### 3.4 Par référence - By part number - nach Artikelnummer

Référence	Page						
P/N	Page						
Art.-Nr.	Seite						
465339	216	725002	162	45210606	213	D10502	177
465419	217	725010	161	46090601	214	D10503	206
465429	217	725012	162	46120601	214	D10504	257
465439	217	725020	161	46270601	213	D10505	256
465519	216	725022	162	1056L	231	D10507	256
465529	216	725032	162	1057L	231	D10508	256
500370	172	725040	161	1060HD	231	D10509	256
500930	166	726290	162	1061HD	231	D10510	256
500940	166	726300	162	1077L	231	D10513	254
521010	192	726310	161	2619L	232	D10514	254
521050	192	726320	161	2627HD	232	D10515	254
603230	223	726350	162	2643HD	232	D10517	258
610050	181	726450	162	2661HD	233	D10518	258
610080	206	726460	162	2662L	233	D10519	258
610091	176	726691	164	501AMBER	234	D10520	258
611010	206	726701	164	50310/1U	228	D10596	214
611020	206	726720	164	50310BU	228	D10597	246
611044	246	726730	164	50310LU	228	D10642	206
611070	246	726740	164	50310MPU	228	D10643	206
611080	246	726750	164	50320/1U	228	D10800	206
611090	252	726760	164	50340BU	228	D10801	224
611094	246	726770	164	50340LU	228	D10802	224
611100	246	2233025	202	50340U	228	D10803	224
611110	246	2233065	191	50350U	228	D10805	218
611140	246	2233073	210	50410U	228	D10837	221
611150	246	3530060	251	50420U	228	D10839	173
611410	247	4330012	258	50440BU	229	D10840	173
611500	245	9115118	258	50440LU	229	D10841	172
611510	245	01447801	194, 186	50440MPU	229	D10873	244
611520	245		211	50440U	229	D10874	244
611530	244	02040601	182, 186	50450U	229	D10900	215
611540	245	02040603	212	52950U	230	D10901	215
611550	244	02041601	182, 186	5301PS	234	D10960	172
611560	244	02041603	212	5301PS2	233	D10980	224
611570	245	02070603	211	5302PS	234	D10986	221
620046	213	02070605	185	5303PS	234	D10987	221
620056	213	02070637	193	53090U	229	D11006	221
620066	213	02077003	211	53100U	229	D11147	206, 258
620226	213	02077011	193	53110U	230	D11255	215
620236	213	02233050	202	58520BU	229	D11256	215
620246	213	02233060	191	58520LU	229	D11257	215
623016	214	02233070	210	58520MPU	229	D11258	215
624016	213	10450605	182	58520U	229	D11259	215
624026	213	10640413	181	58521U	229	D11260	215
624036	213	10640513	181	7546L	232	D11261	215
630100	225	10850603	181	A10060	245	D11262	215
630110	225	10850605	181	A10061	245	D11263	215
630120	225	11220701	180	A10062	244	D11264	215
632030	223	11220801	180	A10064	247	D11268	187, 258
632230	223	11221406	180	A10065	244	D11399	189
632430	223	11221506	180	A10066	244	D11400	208
671000	194	20660617	169	A10091	226	D11479	163
671100	194	20661609	169	A13179	252	D11480	163
672000	159	20860705	160	D10132	187	D11481	163
672230	159	20860805	160	D10132	207	D11482	163
672240	159	21320601	169	D10132	258	D11487	247
672330	159	30137801	204	D10493	198	D11578	247
672410	201	31130701	182	D10494	198	D11588	215
680121	170	31130801	182	D10495	198	D11589	215
680131	170	36070603	219	D10496	198	D11590	215
688601	170	36070607	219	D10497	198	D11591	215
688621	170	36080603	219	D10498	198	D11592	215
688631	170	40300117	176	D10499	208	D11593	215
725000	161	40300225	176	D10500	189	D11626	253



### 3.4 Par référence - By part number - nach Artikelnummer

Référence	Page				
P/N	Page				
Art.-Nr.	Seite				
D11627	253	D12935	225	VI0001	243
D11628	253	D12953	144, 154	VI0002	243
D11689	254		225	VI0003	243
D11796	206	D12998	221	VI0004	241
D11797	206	D13019	220	VI0008	243
D11850	226	D13020	220	VI0009	243
D11851	226	D13034	205	VI0015	239
D11865	254	D13035	205	VI0016	239
D11868	254	D13080	228	VI0018	239
D11888	177	D13234	143	VI0019	239
D11889	251	D13235	143	VI0021	240
D11899	206	D13236	143	VI0022	240
D11955	216	D13248	251	VI0023	240
D11956	216	D13249	256	VI0024	240
D11957	216	D13250	256	VI0024	241
D11958	216	D13251	258	VI0025	240
D12020	216	D13254	257	VI0026	240
D12021	216	D13255	257	VI0027	240
D12111	220	D13256	257	VI0028	240
D12112	220	D13257	257	VI0029	241
D12208	205	D13258	247	VI0030	241
D12209	205	D13260	256	VI0031	241
D12210	206	D13261	254	VI0032	241
D12211	206	D13262	254	VI0034	238
D12220	223	D13263	256	VI0035	238
D12221	223	D13277	206	VI0036	238
D12222	223	D13288	151	VI0036	238
D12263	137	R12575	253	VI0037	242
D12334	163	R12576	253	VI0038	242
D12335	163	R13116	246	VI0039	242
D12336	163	R13117	246	VI0040	242
D12337	163			VI0041	237
D12338	160			VI0042	237
D12339	160			VI0043	237
D12340	160			VI0044	237
D12341	160			VI0045	237
D12390	221			VI0047	237
D12428	205			VI0048	238
D12429	205			VI0048	241
D12430	152, 205			VI0049	238
D12449	253			VI0049	241
D12450	253			VI0050	238
D12471	152, 205			VI0050	241
D12472	152, 205			VI0051	238
D12473	152, 205			VI0051	241
D12487	220			VI0052	242
D12488	220			VI0053	242
D12526	217			VI0054	239
D12527	217			VI0054	242
D12528	217			VI0056	236
D12529	217			VI0057	236
D12543	226			VI0058	236
D12600	222			VI0060	236
D12602	222			VI0061	236
D12603	222			VI0062	236
D12610	222			VI0064	236
D12699	197			VI0067	238
D12711	205			VI0068	238
D12712	205			VI0072	236
D12739	222			VI0073	237
D12740	222			VI0074	237
D12741	222			VI0075	236
D12742	222			VI0076	237
D12867	198				





**2011**



Points de ventes en Europe  
Sales points in Europe  
Verkaufspunkte in Europa

### VIGNAL SYSTEMS

12, rue Eugène Hénaff  
B.P. 594  
69637 VENISSIEUX cedex  
France

Tel : +33(0)4 72 90 29 29  
Fax : +33(0)4 72 90 29 01  
mail : info@vignal-systems.com

[www.vignal-systems.com](http://www.vignal-systems.com)

### Certificats / Certificates / Zertifikate



Téléchargez nos certificats sur  
Download our certificates on  
Downloaden Sie unsere Zertifikate auf

[WWW.VIGNAL-SYSTEMS.COM](http://WWW.VIGNAL-SYSTEMS.COM)

- Products
- Innovation
- Catalogue
- Homologations

### Service commandes / Sales administration / Kundendienst

FRANCE  
Tel : 04 72 90 29 23 / 21  
Fax : 04 72 50 78 18

EXPORT  
Ph : +33 (0) 4 72 90 29 21 / 26  
Fax : +33 (0) 4 72 50 78 18

### Service technique et commercial / Technical sales Dpt / Verkaufs und Technik Abt.

Tel : +33 (0) 4 72 90 29 20  
Fax : +33 (0) 4 72 90 29 01

### Contact commercial / Sales contact / Geschäftl. Ansprechpartner

FRANCE  
Nord Ouest - Tel : 06 23 94 20 57  
Nord Est - Tel : 04 72 90 29 20  
Grand Sud - Tel : 06 18 03 56 32

EXPORT  
North/Eastern Europe / Nord-Osteuropa :  
+33 (0) 634 418 166  
Southern Europe + UK and Netherlands/  
Südeuropa + UK und Niederlande :  
+33 (0) 614 185 247



99999CAD - Edition 2011 - Prix HT : 10€ - Conception, réalisation Vignal