



TURK TRUCK & TRAILER

**Brake Caliper Catalogue
2009**

ttd.com.tr



TTT Otomotiv was founded in 2007.

We would like to render conspicuous ourselves as a manufacturer and exporter company which has specialized on Truck and Trailer spare parts.

TTT Otomotiv became one of big exporter company within very short period and decided its products in international market d.b.a. **TURK TRUCK&TRAILER.**

We supply our customers with high quality spare parts for Heavy Duty Vehicles (MAN, MERCEDES, SCANIA, DAF, VOLVO, RENAULT, IVECO, SETRA, NEOPLAN, KASSBOHRER, MITSUBISHI) and Trailers (BPW, SAF, ROR, FRUEHAUF, KOGEL, SCHMITZ). We have started to production for Brake Caliper Parts and Suspension parts at the beginning of 2008 and exported over 20 countries in one year.

Our policy for customer satisfaction is to produce and acquire high quality spare parts, reasonable prices and on time delivery.

We look forward to that this Catalogue will be quite useful for our customer. Please feel free to contact us for any further information.

With Best Regards
TURK TRUCK&TRAILER.



more than

3500

products

visit our website

ttd.com.tr

Shift

On time delivery
Export
over **30** countries
meet with excellent service



easy to find your requirements
have a our CD Catalogue





www.ttt.com.tr

for
knorr
caliper systems



13333 / Caliper Tappet & Boot Set

OEM NO : K000944 / K010604 / II304130065 / II304130062
APPLICATION : SB6000 / SB7000

TTT NO	DESCRIPTION	QTY
14507	Thrust Part With Bellow (74 mm)	2
14508	Shaft Body Dust Rubber (Black)	2
14509	Tappet Bush 18x16x10 mm	2
14688	Grease	1

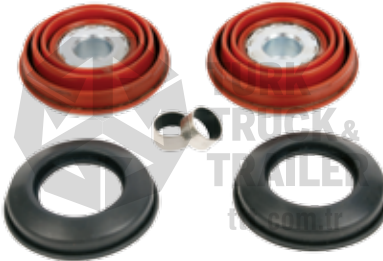

13439 / Caliper Tappet & Boot Set

OEM NO : K000366 / K001300 / K010603
APPLICATION : SN6000 / SN7000 / SK7000 / NA7000

TTT NO	DESCRIPTION	QTY
14517	Thrust Part With Bellow - (69 mm)	2
14518	Shaft Body Dust Rubber (Black)	2
14509	Tappet Bush 18x16x10 mm	2
14688	Grease	1

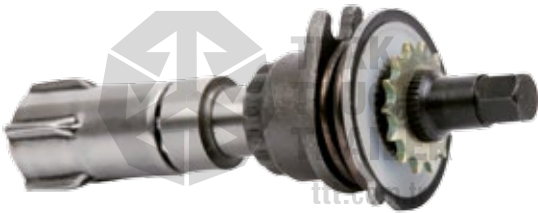

13471 / Adjusting Mechanism Shaft

APPLICATION : SB6000 / SB7000 / SN6000 / SN7000



13472 / Pinion Shaft

APPLICATION : SB6000 / SB7000 / SN6000 / SN7000



13505 / Caliper Mechanism Gear

APPLICATION : All SB Series / All SN Series



13508 / Caliper Calibration Shaft Chain

APPLICATION : SB6000 / SB7000 / SN6000 / SN7000



14690 / Adjusting Mechanism Adapter Set

OEM NO : Z001548
APPLICATION : All SB Series / All SN Series

TTT NO	DESCRIPTION	QTY
13509	Adjusting Mechanism Adapter	10



14670 / Adjusting Mechanism Cap Set

OEM NO : K000029
APPLICATION : All SB Series / All SN Series

TTT NO	DESCRIPTION	QTY
14669	Adjusting Mechanism Cap	10
13509	Adjusting Mechanism Adapter	10

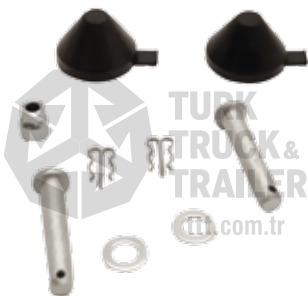

14676 / Brake Pad Retainer & Mechanism Adapter Repair Kit

APPLICATION : All SB Series / All SN Series



13496 / Brake Pad Retainer Repair Kit

OEM NO : II19712004 / II30679004
APPLICATION : SB6000 / SB7000 / SN6000 / SN7000



13506 / Plastic Cover

APPLICATION : SB6000 / SB7000 / SN6000 / SN7000



14564 / Sheet Metal Cap

APPLICATION : SN6000 / SN7000

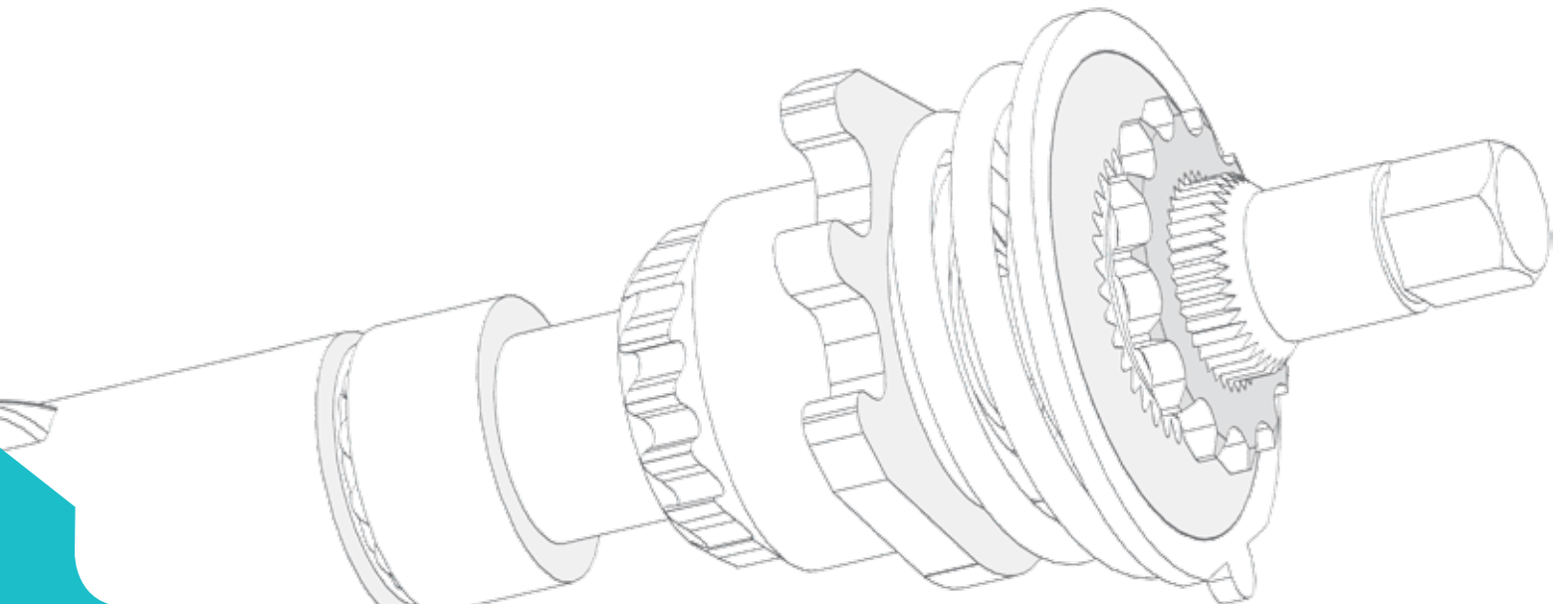



13512 / Brake Caliper Lever - Straight (Angle 0°)

APPLICATION : SB6000 / SB7000

TTT NO	DESCRIPTION	QTY
14563	Lever Bearing	1



13513 / Brake Caliper Lever - (Angle 12°)

APPLICATION : SB7000

TTT NO	DESCRIPTION	QTY
14563	Lever Bearing	1



13510 / Brake Caliper Lever - Straight (Angle 0°)

APPLICATION : SN6000 / SN7000

TTT NO	DESCRIPTION	QTY
14563	Lever Bearing	1



13511 / Brake Caliper Lever - (Angle 12°)

APPLICATION : SN6000 / SN7000

TTT NO	DESCRIPTION	QTY
14563	Lever Bearing	1



14714 / Brake Caliper Lever - (Angle 12°)

TTT NO	DESCRIPTION	QTY
14563	Lever Bearing	1

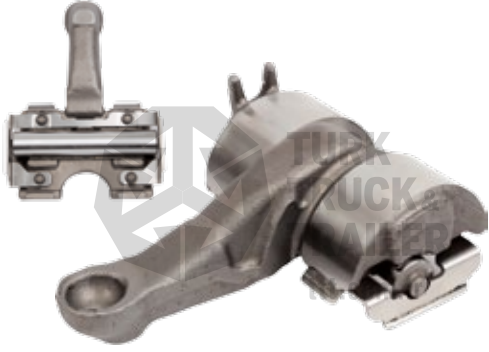

14715 / Brake Caliper Lever - (Angle 12°)

TTT NO	DESCRIPTION	QTY
14563	Lever Bearing	1
14665	Lever Pin	1



14563 / Brake Caliper Lever Bearing

APPLICATION : SB6000 / SB7000 / SN6000 / SN7000

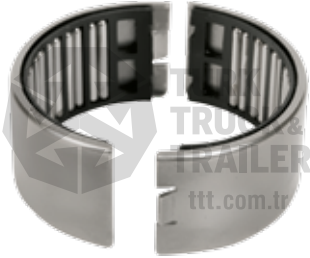

14701 / Roller Bearing Set

APPLICATION : SB6000 / SB7000

TTT NO	DESCRIPTION	QTY
14649	Roller Bearing	1

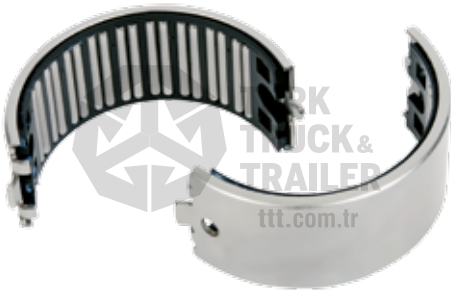

14657 / Roller Bearing Set

APPLICATION : SN6000 / SN7000

TTT NO	DESCRIPTION	QTY
13514	Roller Bearing	1



14664 / Shaft Housing Pin Clamp Bearing Set

APPLICATION : SB6000 / SB7000 / SN6000 / SN7000

TTT NO	DESCRIPTION	QTY
14563	Lever Bearing	1
14665	Shaft Housing Pin	1
14666	Shaft Housing Pin Clamp	2



13507 / Brake Caliper Calibration Bolt - (3 Thread)

APPLICATION : SB6000 / SB7000 / SN6000 / SN7000



13502 / Shaft Housing

APPLICATION : SB6000 / SB7000

TTT NO	DESCRIPTION	QTY
14665	Shaft Housing Pin	1
14666	Shaft Housing Pin Clamp	2
14656	Shaft Housing Spring	1
14688	Grease	1



13504 / Shaft Housing

APPLICATION : SN6000 / SN7000

TTT NO	DESCRIPTION	QTY
14665	Shaft Housing Pin	1
14666	Shaft Housing Pin Clamp	2
14656	Shaft Housing Spring	1
14688	Grease	1



13503 / Shaft Housing

APPLICATION : SN6000 / SN7000

TTT NO	DESCRIPTION	QTY
14656	Shaft Housing Spring	1
14688	Grease	1



15512 / Shaft Housing Set

TTT NO	DESCRIPTION	QTY
13502	Shaft Housing	1
14563	Brake Caliper Lever Bearing	1
13507	Brake Caliper Calibration Bolt - (3 Thread)	2
14688	Grease	1

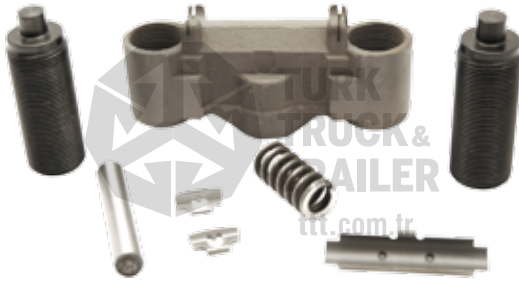

15514 / Shaft Housing Set

TTT NO	DESCRIPTION	QTY
13504	Shaft Housing	1
14563	Brake Caliper Lever Bearing	1
13507	Brake Caliper Calibration Bolt - (3 Thread)	2
14688	Grease	1



15513 / Shaft Housing Set

TTT NO	DESCRIPTION	QTY
13503	Shaft Housing	1
13507	Brake Caliper Calibration Bolt - (3 Thread)	2
14688	Grease	1

14660 / Caliper Repair Set

APPLICATION : SB6000 / SB7000

TTT NO	DESCRIPTION	QTY
13333	Caliper Tappet & Boot Set - (74 mm)	1
13502	Shaft Housing	1
13512	Brake Caliper Lever - Straight (Angle 0°)	1
14701	Roller Bearing Set	1
13508	Caliper Calibration Shaft Chain	1
13471	Adjusting Mechanism Shaft	1
13472	Pinion Shaft	1
13507	Brake Caliper Calibration Bolt - (3 Thread)	2
14688	Grease	3



14661 / Caliper Repair Set

APPLICATION : SB6000 / SB7000

TTT NO	DESCRIPTION	QTY
13333	Caliper Tappet & Boot Set - (74 mm)	1
13502	Shaft Housing	1
13513	Brake Caliper Lever - (Angle 12°)	1
14701	Roller Bearing Set	1
13508	Caliper Calibration Shaft Chain	1
13471	Adjusting Mechanism Shaft	1
13472	Pinion Shaft	1
13507	Brake Caliper Calibration Bolt - (3 Thread)	2
14688	Grease	3





14812 / Caliper Repair Set

APPLICATION : SB6000 / SB7000

TTT NO	DESCRIPTION	QTY
13333	Caliper Tappet & Boot Set - (74 mm)	1
13502	Shaft Housing	1
14714	Brake Caliper Lever - (Angle 12°)	1
14701	Roller Bearing Set	1
13508	Caliper Calibration Shaft Chain	1
13471	Adjusting Mechanism Shaft	1
13472	Pinion Shaft	1
13507	Brake Caliper Calibration Bolt - (3 Thread)	2
14688	Grease	3



13470 / Caliper Repair Set

APPLICATION : SN6000 / SN7000

TTT NO	DESCRIPTION	QTY
13439	Caliper Tappet & Boot Set - (69 mm)	1
13504	Shaft Housing	1
13510	Brake Caliper Lever - Straight (Angle 0°)	1
14657	Roller Bearing Set	1
13508	Caliper Calibration Shaft Chain	1
13471	Adjusting Mechanism Shaft	1
13472	Pinion Shaft	1
13507	Brake Caliper Calibration Bolt - (3 Thread)	2
14688	Grease	3



14652 / Caliper Repair Set

APPLICATION : SN6000 / SN7000

TTT NO	DESCRIPTION	QTY
13439	Caliper Tappet & Boot Set - (69 mm)	1
13504	Shaft Housing	1
13511	Brake Caliper Lever - (Angle 12°)	1
14657	Roller Bearing Set	1
13508	Caliper Calibration Shaft Chain	1
13471	Adjusting Mechanism Shaft	1
13472	Pinion Shaft	1
13507	Brake Caliper Calibration Bolt - (3 Thread)	2
14688	Grease	3



14813 / Caliper Repair Set

APPLICATION : SN6000 / SN7000

TTT NO	DESCRIPTION	QTY
13439	Caliper Tappet & Boot Set - (69 mm)	1
13504	Shaft Housing	1
14714	Brake Caliper Lever - (Angle 12°)	1
14657	Roller Bearing Set	1
13508	Caliper Calibration Shaft Chain	1
13471	Adjusting Mechanism Shaft	1
13472	Pinion Shaft	1
13507	Brake Caliper Calibration Bolt - (3 Thread)	2
14688	Grease	3



14900 / Caliper Repair Set

APPLICATION : SN7000

TTT NO	DESCRIPTION	QTY
13439	Caliper Tappet & Boot Set - (69 mm)	1
13503	Shaft Housing	1
14715	Brake Caliper Lever - (Angle 12°)	1
14657	Roller Bearing Set	1
13508	Caliper Calibration Shaft Chain	1
13471	Adjusting Mechanism Shaft	1
13472	Pinion Shaft	1
13507	Brake Caliper Calibration Bolt - (3 Thread)	2
14688	Grease	3

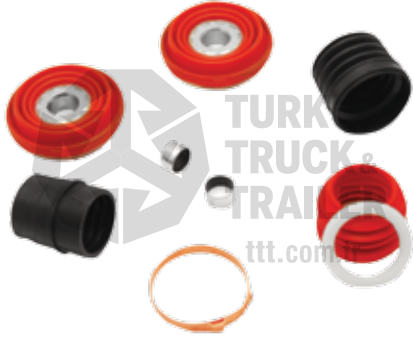

14720 / Caliper Pin & Boot Set

APPLICATION : SB6000 / SB7000

TTT NO	DESCRIPTION	QTY
14507	Thrust Part With Bellow - (74 mm)	2
14509	Tappet Bush 18x16x10 mm	2
14683	Pin Boot - (Red)	1
14684	Pin Boot Ring (Plastic)	1
14524	Pin Bellow Cap - (Black)	1
14525	Clamp	1
14522	Pin Rubber Bush	1
14688	Grease	2



14721 / Caliper Pin & Boot Set

APPLICATION : SB6000 / SB7000

TTT NO	DESCRIPTION	QTY
13333	Caliper Tappet & Boot Set - (74 mm)	1
14683	Pin Boot - (Red)	1
14684	Pin Boot Ring (Plastic)	1
14524	Pin Bellow Cap - (Black)	1
14525	Clamp	1
14522	Pin Rubber Bush	1
14693	Pin Cap	1
14694	Pin Cap O-ring	1
14521	Pin Bush - 40x36x82 mm	1
14669	Adjusting Mechanism Cap	1
14536	Pin Bolt Ring	1
14688	Grease	2



14722 / Caliper Pin & Boot Set

APPLICATION : SN6000 / SN7000

TTT NO	DESCRIPTION	QTY
14517	Thrust Part With Bellow - (69 mm)	2
14509	Tappet Bush 18x16x10 mm	2
14683	Pin Boot - (Red)	1
14684	Pin Boot Ring (Plastic)	1
14524	Pin Bellow Cap - (Black)	1
14525	Clamp	1
14522	Pin Rubber Bush	1
14688	Grease	2



14723 / Caliper Pin & Boot Set

APPLICATION : SN6000 / SN7000

TTT NO	DESCRIPTION	QTY
13439	Caliper Tappet & Boot Set - (69 mm)	1
14683	Pin Boot - (Red)	1
14684	Pin Boot Ring (Plastic)	1
14524	Pin Bellow Cap - (Black)	1
14525	Clamp	1
14522	Pin Rubber Bush	1
14693	Pin Cap	1
14694	Pin Cap O-ring	1
14521	Pin Bush - 40x36x82 mm	1
14669	Adjusting Mechanism Cap	1
14536	Pin Bolt Ring	1
14688	Grease	2



14523 / Caliper Pin Boot Set

APPLICATION : All SB Series / All SN Series

TTT NO	DESCRIPTION	QTY
14683	Pin Boot - (Red)	1
14684	Pin Boot Ring (Plastic)	1



14533 / Caliper Pin Cap Set

OEM NO : II39769F0063

APPLICATION : All SB Series

TTT NO	DESCRIPTION	QTY
14693	Pin Cap	1
14694	Pin Cap O-ring	1

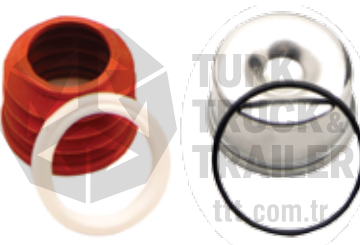

14713 / Caliper Pin Boot & Pin Cap Set

OEM NO : II328090061

APPLICATION : All SB Series

TTT NO	DESCRIPTION	QTY
14523	Caliper Pin Boot Set	1
14533	Caliper Pin Cap Set	1



14541 / Caliper Pin Cap Set

OEM NO : K001301 / II350470063 / II397690063

APPLICATION : All SB Series / All SN Series

TTT NO	DESCRIPTION	QTY
14693	Pin Cap	6
14694	Pin Cap O-ring	6
14524	Pin Bellow Cap - (Black)	6
14525	Clamp	6



14539 / Caliper Pin Cap Set

APPLICATION : All SB Series / All SN Series

TTT NO	DESCRIPTION	QTY
14532	Pin Cap	5



13433 / Caliper Pin Repair Kit

OEM NO : II197140062 / II197330062 / II328090062 / II328090063
II339680062 / II369100062

APPLICATION : SB6000 / SB7000



TTT NO	DESCRIPTION	QTY
14519	Caliper Pin - Ø36x145 mm	1
14520	Caliper Pin - Ø34x80 mm	1
14526	Pin Bolt - M16x1.5-150 mm	1
14527	Pin Bolt - M16x1.5-85 mm	1
14521	Pin Bush - 40x36x82 mm	1
14683	Pin Boot - (Red)	1
14684	Pin Boot Ring (Plastic)	1
14524	Pin Bellow Cap - (Black)	1
14525	Clamp	1
14522	Pin Rubber Bush	1
14688	Grease	2

14704 / Caliper Pin Repair Kit

APPLICATION : SB6000 / SB7000



TTT NO	DESCRIPTION	QTY
14519	Caliper Pin - Ø36x145 mm	1
14520	Caliper Pin - Ø34x80 mm	1
14526	Pin Bolt - M16x1.5-150 mm	1
14527	Pin Bolt - M16x1.5-85 mm	1
14522	Pin Rubber Bush	1
14688	Grease	1

14705 / Caliper Long Pin Repair Kit

OEM NO : K000935

APPLICATION : SB6000 / SB7000



TTT NO	DESCRIPTION	QTY
14519	Caliper Pin - Ø36x145 mm	1
14526	Pin Bolt - M16x1.5-150 mm	1
14521	Pin Bush - 40x36x82 mm	1
14683	Pin Boot - (Red)	1
14684	Pin Boot Ring (Plastic)	1
14524	Pin Bellow Cap - (Black)	1
14525	Clamp	1
14688	Grease	1

13435 / Caliper Pin Repair Kit

OEM NO : K000132 / II304130061
APPLICATION : SB6000 / SB7000



TTT NO	DESCRIPTION	QTY
14537	Caliper Pin - Ø36x135 mm	1
14520	Caliper Pin - Ø34x80 mm	1
14538	Pin Bolt - M16x1.5-140 mm	1
14527	Pin Bolt - M16x1.5-85 mm	1
14521	Pin Bush - 40x36x82 mm	1
14683	Pin Boot - (Red)	1
14684	Pin Boot Ring (Plastic)	1
14524	Pin Bellow Cap - (Black)	1
14525	Clamp	1
14522	Pin Rubber Bush	1
14688	Grease	2

13432 / Caliper Pin Repair Kit

APPLICATION : SB6000 / SB7000



TTT NO	DESCRIPTION	QTY
14537	Caliper Pin - Ø36x135 mm	1
14520	Caliper Pin - Ø34x80 mm	1
14521	Pin Bush - 40x36x82 mm	1
14683	Pin Boot - (Red)	1
14684	Pin Boot Ring (Plastic)	1
14524	Pin Bellow Cap - (Black)	1
14525	Clamp	1
14522	Pin Rubber Bush	1
14688	Grease	2

14706 / Caliper Pin Repair Kit

APPLICATION : SB6000 / SB7000



TTT NO	DESCRIPTION	QTY
14537	Caliper Pin - Ø36x135 mm	1
14520	Caliper Pin - Ø34x80 mm	1
14538	Pin Bolt - M16x1.5-140 mm	1
14527	Pin Bolt - M16x1.5-85 mm	1
14522	Pin Rubber Bush	1
14688	Grease	1



14707 / Caliper Long Pin Repair Kit

APPLICATION : SB6000 / SB7000

TTT NO	DESCRIPTION	QTY
14537	Caliper Pin - Ø36x135 mm	1
14538	Pin Bolt - M16x1.5-140 mm	1
14521	Pin Bush - 40x36x82 mm	1
14683	Pin Boot - (Red)	1
14684	Pin Boot Ring (Plastic)	1
14524	Pin Bellow Cap - (Black)	1
14525	Clamp	1
14688	Grease	1



14530 / Caliper Short Pin Repair Kit

OEM NO : II368470064

APPLICATION : SB6000 / SB7000

TTT NO	DESCRIPTION	QTY
14520	Caliper Pin - Ø34x80 mm	1
14527	Pin Bolt - M16x1.5-85 mm	1
14522	Pin Rubber Bush	1



14531 / Caliper Short Pin Repair Kit

APPLICATION : SB6000 / SB7000

TTT NO	DESCRIPTION	QTY
14520	Caliper Pin - Ø34x80 mm	1
14522	Pin Rubber Bush	1



13436 / Caliper Pin Rubber Bush - (Long)

APPLICATION : All SB Series / All SN Series



13437 / Caliper Pin Rubber Bush - (Short)

APPLICATION : All SB Series / All SN Series



13440 / Caliper Pin Repair Kit

OEM NO : K000472

APPLICATION : SB6000 / SN6000 / SN7000 / SK7000 / NA7000

TTT NO	DESCRIPTION	QTY
14528	Caliper Pin - Ø36x114 mm	1
14529	Caliper Pin - Ø32x80 mm	1
14527	Pin Bolt - M16x1.5-85 mm	1
14535	Pin Bolt - M16x1.5-80 mm	1
14521	Pin Bush - 40x36x82 mm	1
14683	Pin Boot - (Red)	1
14684	Pin Boot Ring (Plastic)	1
13436	Caliper Pin Rubber Bush - (Long)	1
14532	Pin Cap	1
14536	Pin Bolt Ring	1
14688	Grease	2



14750 / Caliper Pin Repair Kit

OEM NO : K001915

APPLICATION : SN6000 / SN7000

TTT NO	DESCRIPTION	QTY
14528	Caliper Pin - Ø36x114 mm	1
14529	Caliper Pin - Ø32x80 mm	1
14527	Pin Bolt - M16x1.5-85 mm	1
14535	Pin Bolt - M16x1.5-80 mm	1
14521	Pin Bush - 40x36x82 mm	1
14683	Pin Boot - (Red)	1
14684	Pin Boot Ring (Plastic)	1
13437	Caliper Pin Rubber Bush - (Short)	1
14532	Pin Cap	1
14688	Grease	2



13441 / Caliper Pin Repair Kit

OEM NO : K000375 / K001532

APPLICATION : SB6000 / SB7000



TTT NO	DESCRIPTION	QTY
14528	Caliper Pin - Ø36x114 mm	1
14529	Caliper Pin - Ø32x80 mm	1
14527	Pin Bolt - M16x1.5-85 mm	1
14535	Pin Bolt - M16x1.5-80 mm	1
14521	Pin Bush - 40x36x82 mm	1
14683	Pin Boot - (Red)	1
14684	Pin Boot Ring (Plastic)	1
13436	Caliper Pin Rubber Bush - (Long)	1
14693	Pin Cap	1
14694	Pin Cap O-ring	1
14536	Pin Bolt Ring	1
14688	Grease	2

14751 / Caliper Pin Repair Kit

APPLICATION : SN6000 / SN7000



TTT NO	DESCRIPTION	QTY
14528	Caliper Pin - Ø36x114 mm	1
14529	Caliper Pin - Ø32x80 mm	1
14527	Pin Bolt - M16x1.5-85 mm	1
14535	Pin Bolt - M16x1.5-80 mm	1
14521	Pin Bush - 40x36x82 mm	1
14683	Pin Boot - (Red)	1
14684	Pin Boot Ring (Plastic)	1
13437	Caliper Pin Rubber Bush - (Short)	1
14693	Pin Cap	1
14694	Pin Cap O-ring	1
14536	Pin Bolt Ring	1
14688	Grease	2



14755 / Caliper Pin Repair Kit

OEM NO : II39769F0062
APPLICATION : SB6000 / SB7000

TTT NO	DESCRIPTION	QTY
14528	Caliper Pin - Ø36x114 mm	1
14520	Caliper Pin - Ø34x80 mm	1
14527	Pin Bolt - M16x1.5-85 mm	2
14521	Pin Bush - 40x36x82 mm	1
14683	Pin Boot - (Red)	1
14684	Pin Boot Ring (Plastic)	1
14693	Pin Cap	1
14694	Pin Cap O-ring	1
14522	Pin Rubber Bush	1
14688	Grease	2



14746 / Caliper Pin Repair Kit

TTT NO	DESCRIPTION	QTY
14528	Caliper Pin - Ø36x114 mm	1
14520	Caliper Pin - Ø34x80 mm	1
14527	Pin Bolt - M16x1.5-85 mm	2
14522	Pin Rubber Bush	1
14688	Grease	2



13442 / Caliper Long Pin Repair Kit

OEM NO : K000696 / II310370066
APPLICATION : SB7000

TTT NO	DESCRIPTION	QTY
14528	Caliper Pin - Ø36x114 mm	1
14527	Pin Bolt - M16x1.5-85 mm	1
14521	Pin Bush - 40x36x82 mm	1
14683	Pin Boot - (Red)	1
14684	Pin Boot Ring (Plastic)	1
14693	Pin Cap	1
14694	Pin Cap O-ring	1
14688	Grease	1



14540 / Caliper Pin Repair Kit

APPLICATION : All SB Series / All SN Series

TTT NO	DESCRIPTION	QTY
14528	Caliper Pin - Ø36x114 mm	1
14529	Caliper Pin - Ø32x80 mm	1
14527	Pin Bolt - M16x1.5-85 mm	1
14535	Pin Bolt - M16x1.5-80 mm	1
13436	Caliper Pin Rubber Bush - (Long)	1
14688	Grease	1



14708 / Caliper Short Pin Repair Kit

OEM NO : K000698

APPLICATION : All SB Series

TTT NO	DESCRIPTION	QTY
14529	Caliper Pin - Ø32x80 mm	1
14535	Pin Bolt - M16x1.5-80 mm	1
13436	Caliper Pin Rubber Bush - (Long)	1
14536	Pin Bolt Ring	1
14688	Grease	1



14709 / Caliper Short Pin Repair Kit

TTT NO	DESCRIPTION	QTY
14529	Caliper Pin - Ø32x80 mm	1
13436	Caliper Pin Rubber Bush - (Long)	1



14730 / Caliper Pin Repair Kit

APPLICATION : All SB Series / All SN Series

TTT NO	DESCRIPTION	QTY
14528	Caliper Pin - Ø36x114 mm	1
14529	Caliper Pin - Ø32x80 mm	1
14527	Pin Bolt - M16x1.5-85 mm	1
14535	Pin Bolt - M16x1.5-80 mm	1
13437	Caliper Pin Rubber Bush - (Short)	1
14688	Grease	1



14738 / Caliper Short Pin Repair Kit

APPLICATION : All SB Series / All SN Series

TTT NO	DESCRIPTION	QTY
14529	Caliper Pin - Ø32x80 mm	1
14535	Pin Bolt - M16x1.5-80 mm	1
13437	Caliper Pin Rubber Bush - (Short)	1



14739 / Caliper Short Pin Repair Kit

APPLICATION : All SB Series / All SN Series

TTT NO	DESCRIPTION	QTY
14529	Caliper Pin - Ø32x80 mm	1
13437	Caliper Pin Rubber Bush - (Short)	1



13438 / Caliper Pin Repair Kit

TTT NO	DESCRIPTION	QTY
14519	Caliper Pin - Ø36x145 mm	1
14529	Caliper Pin - Ø32x80 mm	1
14526	Pin Bolt - M16x1.5-150 mm	1
14535	Pin Bolt - M16x1.5-80 mm	1
14521	Pin Bush - 40x36x82 mm	1
14683	Pin Boot - (Red)	1
14684	Pin Boot Ring (Plastic)	1
13437	Pin Rubber Bush - (Short)	1
14524	Pin Bellow Cap - (Black)	1
14525	Clamp	1
14532	Pin Cap	1
14688	Grease	2



14820 / Caliper Pin Repair Kit

TTT NO	DESCRIPTION	QTY
14528	Caliper Pin - Ø36x114 mm	1
14728	Caliper Pin - Ø36x64 mm	1
14527	Pin Bolt - M16x1.5-85 mm	1
14727	Pin Bolt - M16x1.5-70 mm	1
14521	Pin Bush - 40x36x82 mm	1
14683	Pin Boot - (Red)	2
14684	Pin Boot Ring (Plastic)	2
14534	Pin Bush - 40x36x20 mm	1
14688	Grease	2



14821 / Caliper Pin Repair Kit

TTT NO	DESCRIPTION	QTY
14728	Caliper Pin - Ø36x64 mm	1
14727	Pin Bolt - M16x1.5-70 mm	1
14683	Pin Boot - (Red)	1
14684	Pin Boot Ring (Plastic)	1
14534	Pin Bush - 40x36x20 mm	1
14688	Grease	1



14688 / Grease

SB / SN 50000



13498 / Caliper Tappet & Boot Set

APPLICATION : SB5000 / SN5000

TTT NO	DESCRIPTION	QTY
14542	Thrust Part With Bellow - (69 mm)	1
14518	Shaft Body Dust Rubber (Black)	1
14509	Tappet Bush 18x16x10 mm	1
14688	Grease	1



13469 / Brake Caliper Calibration Bolt - (3 Thread)

APPLICATION : SB5000 / SN5000



14794 / Roller Bearing Set

APPLICATION : SB5000 / SN5000

TTT NO	DESCRIPTION	QTY
13494	Roller Bearing	2



13490 / Adjusting Mechanism Shaft

APPLICATION : SB5000 / SN5000

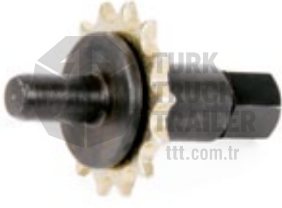

13491 / Pinion Shaft

APPLICATION : SB5000 / SN5000



13495 / Caliper Calibration Shaft Chain

APPLICATION : SB5000 / SN5000



13501 / Caliper Pin Repair Kit

APPLICATION : SB5000 / SN5000

TTT NO	DESCRIPTION	QTY
14544	Caliper Pin - Ø30x99 mm	1
14545	Caliper Pin - Ø29.80x71.5 mm	1
14546	Pin Bolt - M16x1.5-105 mm	1
14547	Pin Bolt - M16x1.5-75 mm	1
14561	Pin Boot - (Red)	2
14562	Pin Boot Ring (Plastic)	2
14548	Pin Bush 34x30x65 mm	1
14549	Pin Bush 33.80x29.80x20 mm	1
14688	Grease	2



for
meritor
caliper systems

www.ttt.com.tr



ELSA 2

13460 / Caliper Adjusting Mechanism



APPLICATION : ELSA 2 LRG544 / LRG546 / LRG572 / LRG580 / LRG582 / LRG638 / LRG646 / LRG658 / LRG662 / LRG664 / LRG669 / LRG700 / LRG712 / LRG720 / LRG722 / LRG724 / LRG744 / LRG748 / LRG750
LRG545 / LRG547 / LRG573 / LRG581 / LRG583 / LRG639 / LRG647 / LRG659 / LRG663 / LRG665 / LRG670 / LRG701 / LRG713 / LRG721 / LRG723 / LRG725 / LRG745 / LRG749 / LRG751
ELSA 195 LRG702 / LRG703
ELSA 225 LRG736 / LRG737

13461 / Caliper Adjusting Mechanism Gear Set



APPLICATION : ELSA 2 LRG544 / LRG546 / LRG572 / LRG580 / LRG582 / LRG638 / LRG646 / LRG658 / LRG662 / LRG664 / LRG669 / LRG700 / LRG712 / LRG720 / LRG722 / LRG724 / LRG744 / LRG748 / LRG750
LRG545 / LRG547 / LRG573 / LRG581 / LRG583 / LRG639 / LRG647 / LRG659 / LRG663 / LRG665 / LRG670 / LRG701 / LRG713 / LRG721 / LRG723 / LRG725 / LRG745 / LRG749 / LRG751
ELSA 195 LRG702 / LRG703

TTT NO	DESCRIPTION	QTY
14884	Caliper Adjusting Mechanism Gear	2
14688	Grease	2

13486 / Caliper Adjusting Mechanism Cap With Bush



APPLICATION : ELSA 2 LRG544 / LRG546 / LRG572 / LRG580 / LRG582 / LRG638 / LRG646 / LRG658 / LRG662 / LRG664 / LRG669 / LRG700 / LRG712 / LRG720 / LRG722 / LRG724 / LRG744 / LRG748 / LRG750
LRG545 / LRG547 / LRG573 / LRG581 / LRG583 / LRG639 / LRG647 / LRG659 / LRG663 / LRG665 / LRG670 / LRG701 / LRG713 / LRG721 / LRG723 / LRG725 / LRG745 / LRG749 / LRG751

14646 / Caliper Adjusting Mechanism Set



APPLICATION : ELSA 2 LRG544 / LRG546 / LRG572 / LRG580 / LRG582 / LRG638 / LRG646 / LRG658 / LRG662 / LRG664 / LRG669 / LRG700 / LRG712 / LRG720 / LRG722 / LRG724 / LRG744 / LRG748 / LRG750
LRG545 / LRG547 / LRG573 / LRG581 / LRG583 / LRG639 / LRG647 / LRG659 / LRG663 / LRG665 / LRG670 / LRG701 / LRG713 / LRG721 / LRG723 / LRG725 / LRG745 / LRG749 / LRG751

TTT NO	DESCRIPTION	QTY
13486	Caliper Adjusting Mechanism Cap With Bush	1
13460	Caliper Adjusting Mechanism	1
13461	Caliper Adjusting Mechanism Gear Set	1
14688	Grease	2

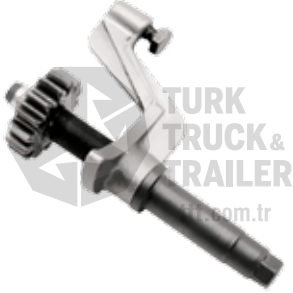

13467 / Manuel Adjusting Gear - R

APPLICATION : ELSA 2 LRG545 / LRG547 / LRG573 / LRG581 / LRG583 / LRG639 / LRG647 / LRG659 / LRG663 / LRG665 /
LRG670 / LRG701 / LRG713 / LRG721 / LRG723 / LRG725 / LRG745 / LRG749 / LRG751
B DUCO LRG553



15467 / Manuel Adjusting Gear - L

APPLICATION : ELSA 2 LRG544 / LRG546 / LRG572 / LRG580 / LRG582 / LRG638 / LRG646 / LRG658 / LRG662 / LRG664 /
LRG669 / LRG700 / LRG712 / LRG720 / LRG722 / LRG724 / LRG748 / LRG750
B DUCO LRG552

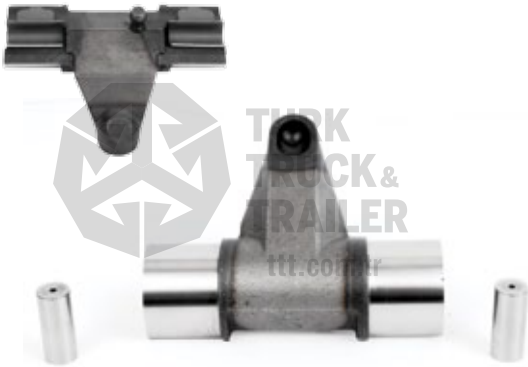

13515 / Brake Caliper Lever

APPLICATION : ELSA 2 LRG544 / LRG546 / LRG572 / LRG580 / LRG582 / LRG638 / LRG646 / LRG658 / LRG664 / LRG700 /
LRG712 / LRG720 / LRG722 / LRG724 / LRG748 / LRG750
LRG545 / LRG547 / LRG573 / LRG581 / LRG583 / LRG639 / LRG647 / LRG659 / LRG665 / LRG701 /
LRG713 / LRG721 / LRG723 / LRG725 / LRG749 / LRG751



14844 / Roller Bearings Set

APPLICATION : ELSA 2 LRG544 / LRG546 / LRG572 / LRG580 / LRG582 / LRG638 / LRG646 / LRG658 / LRG664 / LRG700 /
LRG712 / LRG720 / LRG722 / LRG724 / LRG748 / LRG750 /
LRG545 / LRG547 / LRG573 / LRG581 / LRG583 / LRG639 / LRG647 / LRG659 / LRG665 / LRG701 /
LRG713 / LRG721 / LRG723 / LRG725 / LRG749 / LRG751

TTT NO	DESCRIPTION	QTY
13488	Roller Bearing	2

14850 / Bearing Set

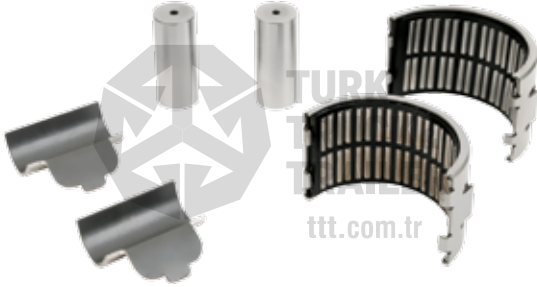

OEM NO : SJ4112

APPLICATION : D DUCO LRG536 / LRG578 / LRG596 / LRG652 / LRG657 / LRG659 / LRG597 / LRG653

B DUCO LRG552 / LRG553

C DUCO LRG560 / LRG648 / LRG561 / LRG649

LE DUCO LRG650 / LRG651

ELSA 1 LRG570 / LRG574 / LRG576 / LRG586 / LRG588 / LRG590 / LRG616 / LRG704

LRG571 / LRG575 / LRG577 / LRG587 / LRG589 / LRG591 / LRG617 / LRG705

ELSA 2 LRG544 / LRG546 / LRG572 / LRG580 / LRG582 / LRG638 / LRG646 / LRG658 / LRG664 / LRG700 /

LRG712 / LRG720 / LRG722 / LRG724 / LRG748 / LRG750

LRG545 / LRG547 / LRG573 / LRG581 / LRG583 / LRG639 / LRG647 / LRG659 / LRG665 / LRG701 /

LRG713 / LRG721 / LRG723 / LRG725 / LRG749 / LRG751

ELSA 195 LRG702 / LRG703

ELSA 225 LRG736 / LRG737

13487 / Caliper Pin Bush - 42x31x45



14712 / Caliper Boot & Pin Repair Kit

APPLICATION : ELSA 2 LRG544 / LRG546 / LRG572 / LRG580 / LRG582 / LRG638 / LRG646 / LRG658 / LRG664 / LRG700 /
LRG712 / LRG720 / LRG722 / LRG724 / LRG748 / LRG750
LRG545 / LRG547 / LRG573 / LRG581 / LRG583 / LRG639 / LRG647 / LRG659 / LRG665 / LRG701 /
LRG713 / LRG721 / LRG723 / LRG725 / LRG749 / LRG751

TTT NO	DESCRIPTION	QTY
14598	Caliper Pin - Ø35x144 mm	1
14599	Caliper Pin - Ø31x84 mm	1
14685	Pin Bolt - M18x1.5-150 mm	1
14686	Pin Bolt - M18x1.5-90 mm	1
13487	Pin Bush - 42x31x45 mm	1
14689	Pin Boot Ring - 42x37x14 mm	1
14602	Pin Bush - 39x35x30 mm	2
14710	Tappet Boot	2
14640	Pin Boot	2
14711	Pin Cap	2
14688	Grease	2



13479 / Caliper Boot & Pin Repair Kit

OEM NO : MCK1243

APPLICATION : ELSA 2 LRG544 / LRG546 / LRG572 / LRG580 / LRG582 / LRG638 / LRG646 / LRG658 / LRG664 / LRG700 / LRG712 / LRG720 / LRG722 / LRG724 / LRG748 / LRG750
LRG545 / LRG547 / LRG573 / LRG581 / LRG583 / LRG639 / LRG647 / LRG659 / LRG665 / LRG701 / LRG713 / LRG721 / LRG723 / LRG725 / LRG749 / LRG751

TTT NO	DESCRIPTION	QTY
14598	Caliper Pin - Ø35x144 mm	1
14599	Caliper Pin - Ø31x84 mm	1
13487	Pin Bush - 42x31x45 mm	1
14689	Pin Boot Ring - 42x37x14 mm	1
14602	Pin Bush - 39x35x30 mm	2
14710	Tappet Boot	2
14640	Pin Boot	2
14711	Pin Cap	2
14688	Grease	2



14716 / Caliper Pin Repair Kit

APPLICATION : ELSA 2 LRG544 / LRG546 / LRG572 / LRG580 / LRG582 / LRG638 / LRG646 / LRG658 / LRG664 / LRG700 / LRG712 / LRG720 / LRG722 / LRG724 / LRG748 / LRG750
LRG545 / LRG547 / LRG573 / LRG581 / LRG583 / LRG639 / LRG647 / LRG659 / LRG665 / LRG701 / LRG713 / LRG721 / LRG723 / LRG725 / LRG749 / LRG751

TTT NO	DESCRIPTION	QTY
14598	Caliper Pin - Ø35x144 mm	1
14599	Caliper Pin - Ø31x84 mm	1
14685	Pin Bolt - M18x1.5-150 mm	1
14686	Pin Bolt - M18x1.5-90 mm	1
13487	Pin Bush - 42x31x45 mm	1
14689	Pin Boot Ring - 42x37x14 mm	1
14602	Pin Bush - 39x35x30 mm	2
14640	Pin Boot	2
14711	Pin Cap	2
14688	Grease	2



14597 / Caliper Tappet Boot Set

OEM NO : MCK1139 / 68324854PK10

APPLICATION : ELSA 2 LRG544 / LRG546 / LRG572 / LRG580 / LRG582 / LRG638 / LRG646 / LRG658 / LRG662 / LRG664 / LRG669 / LRG700 / LRG712 / LRG720 / LRG722 / LRG724 / LRG744 / LRG748 / LRG750
LRG545 / LRG547 / LRG573 / LRG581 / LRG583 / LRG639 / LRG647 / LRG659 / LRG663 / LRG665 / LRG670 / LRG701 / LRG713 / LRG721 / LRG723 / LRG725 / LRG745 / LRG749 / LRG751

ELSA 195 LRG702 / LRG703
ELSA 225 LRG736 / LRG737

TTT NO	DESCRIPTION	QTY
14710	Tappet Boot	2



14788 / Caliper Boot & Pin Repair Kit

APPLICATION : ELSA 2 LRG546 / LRG664 / LRG669 / LRG724
LRG547 / LRG665 / LRG670 / LRG725

TTT NO	DESCRIPTION	QTY
14781	Caliper Pin - Ø35x126 mm	1
14782	Caliper Pin - Ø31x84 mm	1
14609	Pin Bolt - M20x1.5-150 mm	1
14610	Pin Bolt - M20x1.5-90 mm	1
14602	Pin Bush - 39x35x30 mm	3
14710	Tappet Boot	2
14640	Pin Boot	2
14762	Pin Ring	2
14763	Pin Cap	2
14766	Caliper Plate Bolt	4
14688	Grease	2



14779 / Caliper Pin Repair Kit

OEM NO : MCK1086
APPLICATION : ELSA 2 LRG546 / LRG664 / LRG669 / LRG724
LRG547 / LRG665 / LRG670 / LRG725

TTT NO	DESCRIPTION	QTY
14781	Caliper Pin - Ø35x126 mm	1
14782	Caliper Pin - Ø31x84 mm	1
14609	Pin Bolt - M20x1.5-150 mm	1
14610	Pin Bolt - M20x1.5-90 mm	1
14602	Pin Bush - 39x35x30 mm	3
14640	Pin Boot	2
14762	Pin Ring	2
14763	Pin Cap	2
14766	Caliper Plate Bolt	4
14688	Grease	2



14740 / Caliper Pin Bush Set

APPLICATION : ELSA 2 LRG544 / LRG546 / LRG572 / LRG580 / LRG582 / LRG638 /
LRG646 / LRG658 / LRG662 / LRG664 / LRG669 / LRG700 /
LRG712 / LRG720 / LRG722 / LRG724 / LRG744 / LRG748 /
LRG750
LRG545 / LRG547 / LRG573 / LRG581 / LRG583 / LRG639 /
LRG647 / LRG659 / LRG663 / LRG665 / LRG670 / LRG701 /
LRG713 / LRG721 / LRG723 / LRG725 / LRG745 / LRG749 /
LRG751
ELSA 195 LRG702 / LRG703
ELSA 225 LRG736 / LRG737

TTT NO	DESCRIPTION	QTY
14602	Pin Bush - 39x35x30 mm	10

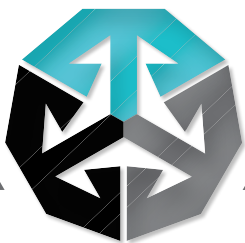

ELSA 1

13445 / Caliper Adjusting Gear - R - (35 mm)

APPLICATION : ELSA 1 LRG543 / LRG571 / LRG575 / LRG577 / LRG587 / LRG589 / LRG591 / LRG617 / LRG633 / LRG643 / LRG705 / LRG753



15445 / Caliper Adjusting Gear - L - (35 mm)

APPLICATION : ELSA 1 LRG542 / LRG570 / LRG574 / LRG576 / LRG586 / LRG588 / LRG590 / LRG616 / LRG632 / LRG642 / LRG704 / LRG752



14691 / Caliper Adjusting Gear Set - R - (35 mm)

APPLICATION : ELSA 1 LRG543 / LRG571 / LRG575 / LRG577 / LRG587 / LRG589 / LRG591 / LRG617 / LRG633 / LRG643 / LRG705 / LRG753



TTT NO	DESCRIPTION	QTY
13445	Caliper Adjusting Gear - R - (35 mm)	2
14696	Caliper Adjusting Mechanism (35 mm)	1
14697	Gear Slot	2
14688	Grease	2

15691 / Caliper Adjusting Gear Set - L - (35 mm)

APPLICATION : ELSA 1 LRG542 / LRG570 / LRG574 / LRG576 / LRG586 / LRG588 / LRG590 / LRG616 / LRG632 / LRG642 / LRG704 / LRG752



TTT NO	DESCRIPTION	QTY
15445	Caliper Adjusting Gear - L - (35 mm)	2
14696	Caliper Adjusting Mechanism (35 mm)	1
14697	Gear Slot	2
14688	Grease	2

14717 / Caliper Adjusting Gear - R - (37.5 mm)



15717 / Caliper Adjusting Gear - L - (37.5 mm)



14724 / Caliper Adjusting Gear Set - R - (37.5 mm)



TTT NO	DESCRIPTION	QTY
14717	Caliper Adjusting Gear - R - (37.5 mm)	2
14698	Caliper Adjusting Mechanism (37.5 mm)	1
14697	Gear Slot	2
14688	Grease	2

15724 / Caliper Adjusting Gear Set - L - (37.5 mm)



TTT NO	DESCRIPTION	QTY
15717	Caliper Adjusting Gear - L - (37.5 mm)	2
14698	Caliper Adjusting Mechanism (37.5 mm)	1
14697	Gear Slot	2
14688	Grease	2

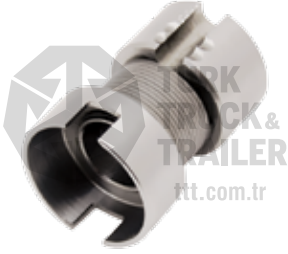

13465 / Adjusting Mechanism Clutch System - R

APPLICATION : ELSA 1 LRG543 / LRG571 / LRG575 / LRG577 / LRG587 / LRG589 / LRG591 / LRG617 / LRG633 / LRG643 / LRG705 / LRG753



15465 / Adjusting Mechanism Clutch System - L

APPLICATION : ELSA 1 LRG542 / LRG570 / LRG574 / LRG576 / LRG586 / LRG588 / LRG590 / LRG616 / LRG632 / LRG642 / LRG704 / LRG752

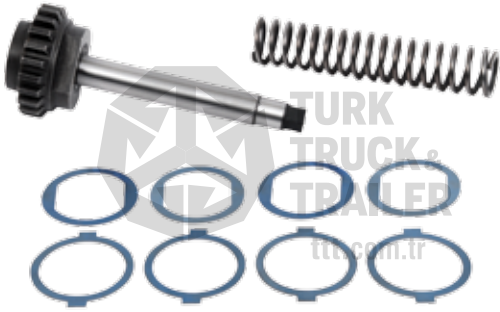

13466 / Caliper Adjusting Mechanism

APPLICATION : ELSA 1 LRG542 / LRG570 / LRG574 / LRG576 / LRG586 / LRG588 / LRG590 / LRG616 / LRG632 / LRG642 / LRG704 / LRG752
LRG543 / LRG571 / LRG575 / LRG577 / LRG587 / LRG589 / LRG591 / LRG617 / LRG633 / LRG643 / LRG705 / LRG753



13446 / Locking Shim

OEM NO : 68321678PK10

APPLICATION : ELSA 1 LRG542 / LRG570 / LRG574 / LRG576 / LRG586 / LRG588 / LRG590 / LRG616 / LRG632 / LRG642 / LRG704 / LRG752
LRG543 / LRG571 / LRG575 / LRG577 / LRG587 / LRG589 / LRG591 / LRG617 / LRG633 / LRG643 / LRG705 / LRG753



14745 / Spring Retainer Thrust - R

APPLICATION : ELSA 1 LRG543 / LRG571 / LRG575 / LRG577 / LRG587 / LRG589 / LRG591 / LRG617 / LRG705



15745 / Spring Retainer Thrust - L

APPLICATION : ELSA 1 LRG542 / LRG570 / LRG574 / LRG576 / LRG586 / LRG588 / LRG590 / LRG616 / LRG704



13443 / Caliper Boot & Pin Repair Kit

OEM NO : MCK1103

APPLICATION : ELSA 1 LRG574 / LRG590 / LRG704 / LRG575 / LRG591 / LRG705

TTT NO	DESCRIPTION	QTY
14614	Caliper Pin - Ø28.5x110 mm (With Bolt M20x1.5-26 mm)	1
14607	Caliper Pin - Ø35x135 mm	1
14609	Pin Bolt - M20x1.5-150 mm	1
14615	Pin Rubber Bush - 40x28.5x27 mm	1
14611	Pin Boot Ring - 40x30x19 mm	1
14604	Pin Boot Ring - 39x37/36x15 mm	1
14602	Pin Bush - 39x35x30 mm	2
14687	Tappet Boot	2
14603	Pin Boot	2
14605	Pin Cap	2
14688	Grease	2



14733 / Caliper Pin Repair Kit

TTT NO	DESCRIPTION	QTY
14614	Caliper Pin - Ø28.5x110 mm (With Bolt M20x1.5-26 mm)	1
14607	Caliper Pin - Ø35x135 mm	1
14609	Pin Bolt - M20x1.5-150 mm	1
14615	Pin Rubber Bush - 40x28.5x27 mm	1
14611	Pin Boot Ring - 40x30x19 mm	1
14604	Pin Boot Ring - 39x37/36x15 mm	1
14602	Pin Bush - 39x35x30 mm	2
14603	Pin Boot	2
14605	Pin Cap	2
14688	Grease	2



14740 / Caliper Pin Bush Set

APPLICATION : ELSA 1 LRG542 / LRG570 / LRG574 / LRG576 / LRG586 / LRG588 / LRG590 / LRG616 / LRG632 / LRG642 / LRG704 / LRG752 / LRG543 / LRG571 / LRG575 / LRG577 / LRG587 / LRG589 / LRG591 / LRG617 / LRG633 / LRG643 / LRG705 / LRG753

TTT NO	DESCRIPTION	QTY
14602	Pin Bush - 39x35x30 mm	10



13444 / Caliper Boot & Pin Repair Kit

APPLICATION : ELSA 1 LRG542 / LRG570 / LRG576 / LRG586 / LRG588 / LRG616 /
LRG632 / LRG642 / LRG752
LRG543 / LRG571 / LRG577 / LRG587 / LRG589 / LRG617 /
LRG633 / LRG643 / LRG753

TTT NO	DESCRIPTION	QTY
14607	Caliper Pin - Ø35x135 mm	1
14608	Caliper Pin - Ø35x73 mm	1
14609	Pin Bolt - M20x1.5-150 mm	1
14610	Pin Bolt - M20x1.5-90 mm	1
14612	Pin Bush - 40x35x38 mm	1
14602	Pin Bush - 39x35x30 mm	2
14725	Pin Boot Ring - 40x37x15 mm	1
14604	Pin Boot Ring - 39x37/36x15 mm	1
14729	Pin Boot Ring - 48x37x13.5 mm	2
14687	Tappet Boot	2
14603	Pin Boot	2
14605	Pin Cap	2
14688	Grease	2



14606 / Caliper Pin Repair Kit

OEM NO : MCK1102
APPLICATION : ELSA 1 LRG542 / LRG570 / LRG576 / LRG586 / LRG588 / LRG616 /
LRG632 / LRG642 / LRG752
LRG543 / LRG571 / LRG577 / LRG587 / LRG589 / LRG617 /
LRG633 / LRG643 / LRG753

TTT NO	DESCRIPTION	QTY
14607	Caliper Pin - Ø35x135 mm	1
14608	Caliper Pin - Ø35x73 mm	1
14609	Pin Bolt - M20x1.5-150 mm	1
14610	Pin Bolt - M20x1.5-90 mm	1
14612	Pin Bush - 40x35x38 mm	1
14602	Pin Bush - 39x35x30 mm	2
14725	Pin Boot Ring - 40x37x15 mm	1
14604	Pin Boot Ring - 39x37/36x15 mm	1
14729	Pin Boot Ring - 48x37x13.5 mm	2
14603	Pin Boot	2
14605	Pin Cap	2
14688	Grease	2



14613 / Caliper Tappet Boot Set

OEM NO : ST1156
APPLICATION : ELSA 1 LRG542 / LRG570 / LRG574 / LRG576 / LRG586 / LRG588 /
LRG590 / LRG616 / LRG632 / LRG642 / LRG704 / LRG752
LRG543 / LRG571 / LRG575 / LRG577 / LRG587 / LRG589 /
LRG591 / LRG617 / LRG633 / LRG643 / LRG705 / LRG753

TTT NO	DESCRIPTION	QTY
14687	Tappet Boot	2

D DUCO

14734 / Intermediate Gear & Spring Set

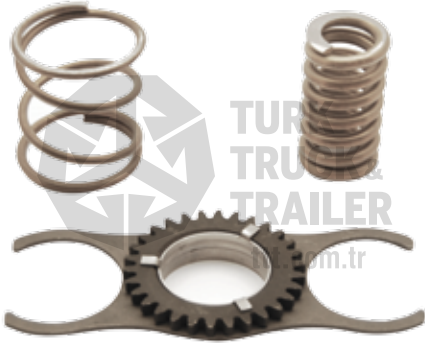

OEM NO : MCK1067
 APPLICATION : D DUCO LRG536 / LRG578 / LRG596 / LRG598 / LRG652
 LRG537 / LRG579 / LRG597 / LRG599 / LRG653
 C DUCO LRG560 / LRG561



14735 / Tappet Anti Rotation Plate

OEM NO : 68322900PK10
 APPLICATION : D DUCO LRG536 / LRG578 / LRG596 / LRG598 / LRG652
 LRG537 / LRG579 / LRG597 / LRG599 / LRG653
 C DUCO LRG560 / LRG561



13480 / Caliper Boot & Pin Repair Kit

APPLICATION : D DUCO LRG598 / LRG599

TTT NO	DESCRIPTION	QTY
14616	Caliper Pin - Ø35x102 mm	2
14617	Pin Bolt - M20x2-125 mm	2
14618	Pin Bush - 40x35x77 mm	1
14602	Pin Bush - 39x35x30 mm	2
14729	Pin Boot Ring - 48x37x13.5 mm	2
14731	Pin Boot Ring - 39x37x11.5 mm	2
14692	Tappet Boot	2
14603	Pin Boot	2
14711	Pin Cap	2
14688	Grease	2



14760 / Caliper Pin Repair Kit

OEM NO : MCK1135
APPLICATION : D DUCO LRG598 / LRG599

TTT NO	DESCRIPTION	QTY
14616	Caliper Pin - Ø35x102 mm	2
14617	Pin Bolt - M20x2-125 mm	2
14618	Pin Bush - 40x35x77 mm	1
14602	Pin Bush - 39x35x30 mm	2
14729	Pin Boot Ring - 48x37x13.5 mm	2
14731	Pin Boot Ring - 39x37x11.5 mm	2
14603	Pin Boot	2
14711	Pin Cap	2
14688	Grease	2



14643 / Caliper Boot & Pin Repair Kit

TTT NO	DESCRIPTION	QTY
14616	Caliper Pin - Ø35x102 mm	2
14618	Pin Bush - 40x35x77 mm	1
14602	Pin Bush - 39x35x30 mm	2
14692	Tappet Boot	2
14603	Pin Boot	2
14688	Grease	2



14642 / Caliper Boot & Pin Repair Kit

TTT NO	DESCRIPTION	QTY
14618	Pin Bush - 40x35x77 mm	1
14602	Pin Bush - 39x35x30 mm	2
14692	Tappet Boot	2
14603	Pin Boot	2
14688	Grease	1



14741 / Caliper Pin Repair Kit

OEM NO : MCK1065 / MCK1066
APPLICATION : D DUCO LRG536 / LRG578 / LRG596 / LRG598 / LRG652
LRG537 / LRG579 / LRG597 / LRG599 / LRG653
B DUCO LRG552 / LRG553
C DUCO LRG560 / LRG648 / LRG561 / LRG649
LE DUCO LRG650 / LRG651

TTT NO	DESCRIPTION	QTY
14616	Caliper Pin - Ø35x102 mm	1
14603	Pin Boot	2
14711	Pin Cap	2
14688	Grease	1



14600 / Caliper Tappet Boot Set

APPLICATION : D DUCO LRG536 / LRG578 / LRG596 / LRG598 / LRG652 /
LRG537 / LRG579 / LRG597 / LRG599 / LRG653
B DUCO LRG552 / LRG553
C DUCO LRG560 / LRG648 / LRG561 / LRG649
LE DUCO LRG650 / LRG651

TTT NO	DESCRIPTION	QTY
14692	Tappet Boot	2

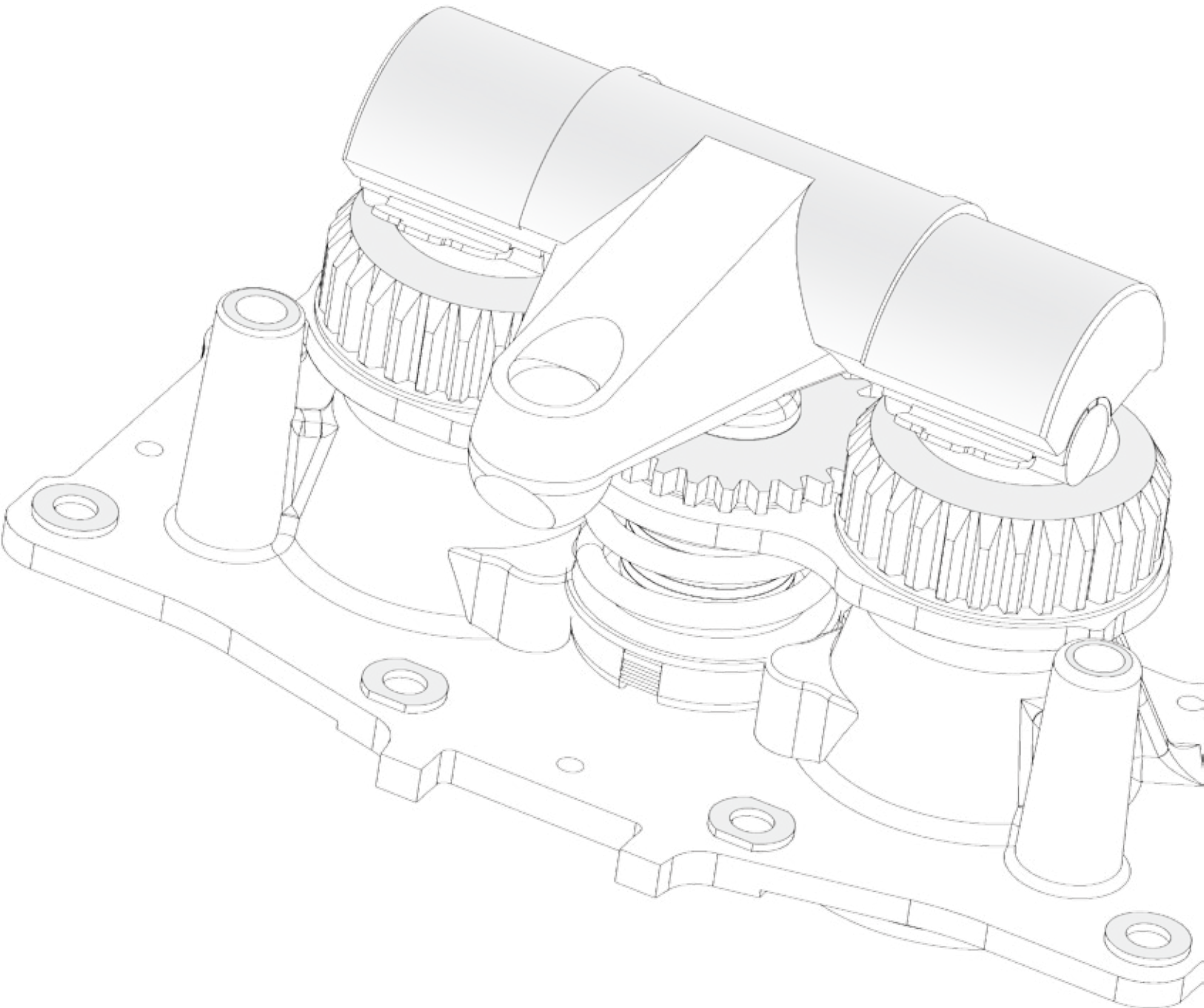



D/C LISA

13457 / Caliper Adjusting Mechanism - R

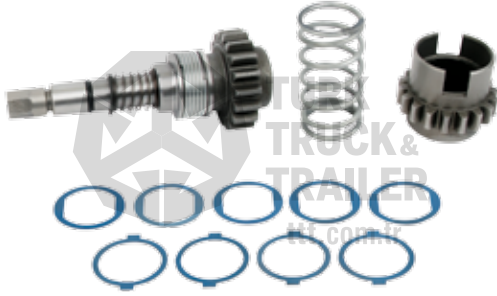

OEM NO : SJ4114
APPLICATION : D LISA LRG549 / LRG551 / LRG565 / LRG593 / LRG631
C LISA LRG555 / LRG595

15457 / Caliper Adjusting Mechanism - L

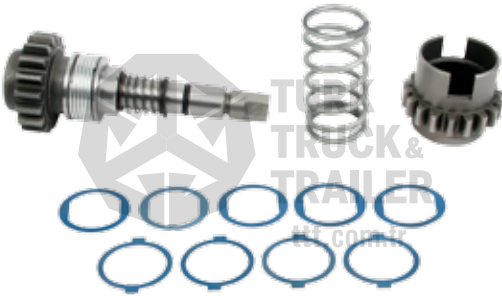

OEM NO : SJ4113
APPLICATION : D LISA LRG548 / LRG550 / LRG564 / LRG592 / LRG630
C LISA LRG554 / LRG594

13455 / Caliper Adjusting Gear - R



OEM NO : SJ4074
APPLICATION : D LISA LRG549 / LRG551 / LRG565 / LRG593 / LRG631
C LISA LRG555

15455 / Caliper Adjusting Gear - L



OEM NO : SJ4073
APPLICATION : D LISA LRG548 / LRG550 / LRG564 / LRG592 / LRG630
C LISA LRG554



14770 / Caliper Pin Repair Kit

OEM NO : SJ4076

APPLICATION : D LISA LRG548 / LRG550 / LRG564 / LRG592 / LRG630
LRG549 / LRG551 / LRG565 / LRG593 / LRG631

TTT NO	DESCRIPTION	QTY
14771	Caliper Pin - Ø35x132 mm	1
14772	Caliper Pin - Ø35x79 mm	1
14609	Pin Bolt - M20x1.5-150 mm	1
14610	Pin Bolt - M20x1.5-90 mm	1
14726	Pin Bush - 39x35x47 mm	1
14602	Pin Bush - 39x35x30 mm	2
14732	Pin Bush - 41x35x30 mm	2
14729	Pin Boot Ring - 48x37x13.5 mm	2
14603	Pin Boot	2
14736	Pin Cap	2
14688	Grease	2

14740 / Caliper Pin Bush Set

APPLICATION : D LISA LRG548 / LRG550 / LRG564 / LRG592 / LRG630 / LRG549 /
LRG551 / LRG565 / LRG593 / LRG631



TTT NO	DESCRIPTION	QTY
14602	Pin Bush - 39x35x30 mm	10



D 3

14583 / Spline Shaft Cover Set

OEM NO : SJ1212

APPLICATION : D3 LRG524 / LRG526 / LRG528 / LRG532 / LRG562 / LRG622
LRG525 / LRG527 / LRG529 / LRG533 / LRG563 / LRG623

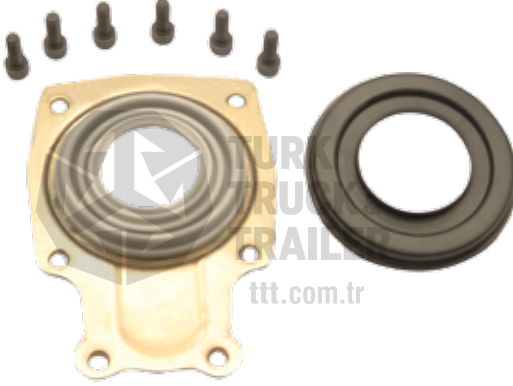

TTT NO	DESCRIPTION	QTY
14570	Dust Cover	1
14575	Boot (Big)	1
14737	Bolt	6



14567 / Wavy Washer

APPLICATION : D3 LRG524 / LRG526 / LRG528 / LRG532 / LRG562 / LRG622
LRG525 / LRG527 / LRG529 / LRG533 / LRG563 / LRG623



14566 / Roller Bearing

APPLICATION : D3 LRG524 / LRG526 / LRG528 / LRG532 / LRG562 / LRG622
LRG525 / LRG527 / LRG529 / LRG533 / LRG563 / LRG623



14565 / Ball Bearing Set

APPLICATION : D3 LRG524 / LRG526 / LRG528 / LRG532 / LRG562 / LRG622
LRG525 / LRG527 / LRG529 / LRG533 / LRG563 / LRG623



13456 / Caliper Adjusting Gear (Big) - R

APPLICATION : D3 LRG525 / LRG527 / LRG529 / LRG533 / LRG563 / LRG623



15456 / Caliper Adjusting Gear (Big) - L

APPLICATION : D3 LRG524 / LRG526 / LRG528 / LRG532 / LRG562 / LRG622



14774 / Clutch System (Big) - R

APPLICATION : D3 LRG525 / LRG527 / LRG529 / LRG533 / LRG563 / LRG623

TTT NO	DESCRIPTION	QTY
14742	Torsion Spring Bearing	1
14578	Torsion Spring (Big) - R	1
14747	Washer	4
14748	Washer	3



14775 / Clutch System (Big) - L

APPLICATION : D3 LRG524 / LRG526 / LRG528 / LRG532 / LRG562 / LRG622

TTT NO	DESCRIPTION	QTY
14742	Torsion Spring Bearing	1
14579	Torsion Spring (Big) - L	1
14747	Washer	4
14748	Washer	3



14584 / Clutch System (Small) - R

APPLICATION : D3 LRG525 / LRG527 / LRG529 / LRG533 / LRG563 / LRG623

TTT NO	DESCRIPTION	QTY
14571	Adjusting Gear (Small)	1
14568	Torsion Spring (Small) - R	1
14573	Adjuster Bolt - M10x1.5-50 mm	1
14572	Adjuster Bolt Rubber	1



14585 / Clutch System (Small) - L

APPLICATION : D3 LRG524 / LRG526 / LRG528 / LRG532 / LRG562 / LRG622

TTT NO	DESCRIPTION	QTY
14571	Adjusting Gear (Small)	1
14569	Torsion Spring (Small) - L	1
14573	Adjuster Bolt - M10x1.5-50 mm	1
14572	Adjuster Bolt Rubber	1



14576 / Spline Shaft (Front) - R - (26 Teeth)

APPLICATION : D3 LRG529 / LRG533 / LRG563



14577 / Spline Shaft (Front) - L - (26 Teeth)

APPLICATION : D3 LRG528 / LRG532 / LRG562

14586 / Spline Shaft (Rear) - R - (26 Teeth)

APPLICATION : D3 LRG623



14587 / Spline Shaft (Rear) - L - (26 Teeth)

APPLICATION : D3 LRG622



14580 / Bearing House - R

APPLICATION : D3 LRG525 / LRG527 / LRG529 / LRG533 / LRG563 / LRG623



14581 / Bearing House - L

APPLICATION : D3 LRG524 / LRG526 / LRG528 / LRG532 / LRG562 / LRG622





13516 / Caliper Repair Kit (Front) - R

APPLICATION : D3 LRG529 / LRG533 / LRG563

TTT NO	DESCRIPTION	QTY
14576	Spline Shaft (Front) - R - (26 Teeth)	1
14580	Bearing House - R	1
13456	Caliper Adjusting Gear (Big) - R	1
14774	Clutch System (Big) - R	1
14584	Clutch System (Small) - R	1
14582	Spline Shaft Bush - 55x50x20 mm	1
14574	Boot (Small)	1
14567	Wavy Washer	1
14566	Roller Bearing	1
14565	Ball Bearing Set	1
14583	Spline Shaft Cover Set	1
14688	Grease	4



15516 / Caliper Repair Kit (Front) - L

APPLICATION : D3 LRG528 / LRG532 / LRG562

TTT NO	DESCRIPTION	QTY
14577	Spline Shaft (Front) - L - (26 Teeth)	1
14581	Bearing House - L	1
15456	Caliper Adjusting Gear (Big) - L	1
14775	Clutch System (Big) - L	1
14585	Clutch System (Small) - L	1
14582	Spline Shaft Bush - 55x50x20 mm	1
14574	Boot (Small)	1
14567	Wavy Washer	1
14566	Roller Bearing	1
14565	Ball Bearing Set	1
14583	Spline Shaft Cover Set	1
14688	Grease	4



13517 / Caliper Repair Kit (Rear) - R

APPLICATION : D3 LRG623

TTT NO	DESCRIPTION	QTY
14586	Spline Shaft (Rear) - R - (26 Teeth)	1
14580	Bearing House - R	1
13456	Caliper Adjusting Gear (Big) - R	1
14774	Clutch System (Big) - R	1
14584	Clutch System (Small) - R	1
14582	Spline Shaft Bush - 55x50x20 mm	1
14574	Boot (Small)	1
14567	Wavy Washer	1
14566	Roller Bearing	1
14565	Ball Bearing Set	1
14583	Spline Shaft Cover Set	1
14688	Grease	4



15517 / Caliper Repair Kit (Rear) - L

APPLICATION : D3 LRG622

TTT NO	DESCRIPTION	QTY
14587	Spline Shaft (Rear) - L - (26 Teeth)	1
14581	Bearing House - L	1
15456	Caliper Adjusting Gear (Big) - L	1
14775	Clutch System (Big) - L	1
14585	Clutch System (Small) - L	1
14582	Spline Shaft Bush - 55x50x20 mm	1
14574	Boot (Small)	1
14567	Wavy Washer	1
14566	Roller Bearing	1
14565	Ball Bearing Set	1
14583	Spline Shaft Cover Set	1
14688	Grease	4



13518 / Caliper Brake Lining Plate

APPLICATION : D3 LRG524 / LRG526 / LRG528 / LRG532 / LRG562 / LRG622
LRG525 / LRG527 / LRG529 / LRG533 / LRG563 / LRG623



13519 / Caliper Pin Repair Kit

OEM NO : SJ4011
APPLICATION : D3 LRG524 / LRG526 / LRG528 / LRG532 / LRG562 / LRG622
LRG525 / LRG527 / LRG529 / LRG533 / LRG563 / LRG623

TTT NO	DESCRIPTION	QTY
14588	Caliper Pin - Ø32x117 mm	1
14589	Caliper Pin - Ø32x74 mm	1
14591	Pin Bolt - M18x1.5-117 mm	1
14592	Pin Bolt - M18x1.5-92 mm	1
14596	Pin Bush - 36x32x62 mm	1
14595	Pin Bush - 36x32x42 mm	2
14593	Pin Dust Cover	2
14590	Pin Boot	2
14594	Pin Cap	2
14688	Grease	2



14744 / Caliper Pin Repair Kit

OEM NO : SJ4001

TTT NO	DESCRIPTION	QTY
14588	Caliper Pin - Ø32x117 mm	1
14589	Caliper Pin - Ø32x74 mm	1
14591	Pin Bolt - M18x1.5-117 mm	1
14592	Pin Bolt - M18x1.5-92 mm	1
14593	Pin Dust Cover	2
14590	Pin Boot	2
14594	Pin Cap	2
14688	Grease	2



14688 / Grease

DX195



14811 / Caliper Boot & Pin Repair Kit

OEM NO : MCK1171
APPLICATION : DX195.51 / DX195.52

TTT NO	DESCRIPTION	QTY
14757	Caliper Pin - Ø32x97 mm	2
14767	Pin Bolt - M16x1.5-80 mm	1
14768	Pin Bolt - M16x1.5-55 mm	1
14759	Pin Bush - 36x32x55 mm	2
14791	Tappet Boot	2
14792	Pin Boot	2
14793	Pin Cap	2
14795	Adjusting Mechanism Cap Bolt	2
14796	Calibration Bolt Pin	2
14789	Pin	1
14790	Cotter	1
14797	Cap (With Bolt)	1
14798	Cap Washer	1
14688	Grease	2



14815 / Caliper Boot & Pin Bolt Repair Kit

OEM NO : MCK1192
APPLICATION : DX195.51 / DX195.52

TTT NO	DESCRIPTION	QTY
14767	Pin Bolt - M16x1.5-80 mm	1
14768	Pin Bolt - M16x1.5-55 mm	1
14791	Tappet Boot	2
14792	Pin Boot	2
14793	Pin Cap	2





for
wabco
caliper systems

www.ttt.com.tr



17.5''

13449 / Caliper Boot & Pin Repair Kit

OEM NO : 12 999 699 / 12 999 702

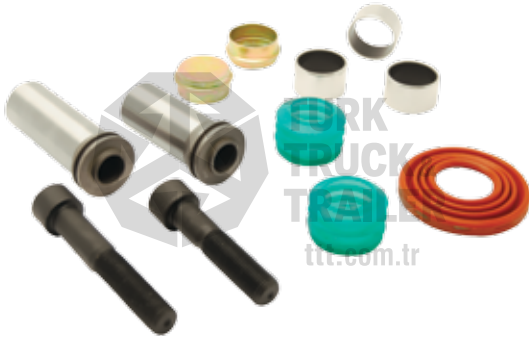

TTT NO	DESCRIPTION	QTY
14622	Caliper Pin - Ø30x88 mm	1
14623	Caliper Pin - Ø30x75 mm	1
14624	Pin Bolt - M16x1.5-90 mm	1
14625	Pin Bolt - M16x1.5-70 mm	1
14628	Pin Bush - 34x30x20 mm	3
14626	Tappet Boot	1
14627	Pin Boot	2
14629	Pin Cap	2
14688	Grease	2

14641 / Caliper Boot & Pin Repair Kit



TTT NO	DESCRIPTION	QTY
14622	Caliper Pin - Ø30x88 mm	1
14623	Caliper Pin - Ø30x75 mm	1
14628	Pin Bush - 34x30x20 mm	3
14626	Tappet Boot	1
14627	Pin Boot	2
14629	Pin Cap	2
14688	Grease	2

14630 / Caliper Boot & Pin Bolt Repair Kit

OEM NO : 12 999 704



TTT NO	DESCRIPTION	QTY
14624	Pin Bolt - M16x1.5-90 mm	1
14625	Pin Bolt - M16x1.5-70 mm	1
14628	Pin Bush - 34x30x20 mm	3
14626	Tappet Boot	1
14627	Pin Boot	2
14629	Pin Cap	2

14631 / Caliper Boot & Pin Bush Set



TTT NO	DESCRIPTION	QTY
14628	Pin Bush - 34x30x20 mm	3
14626	Tappet Boot	1
14627	Pin Boot	2
14629	Pin Cap	2



14817 / Caliper Boot & Pin Cap Set

TTT NO	DESCRIPTION	QTY
14626	Tappet Boot	1
14627	Pin Boot	2
14629	Pin Cap	2

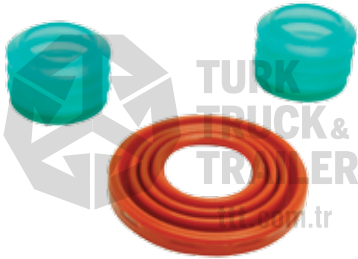

13450 / Caliper Boot Set

TTT NO	DESCRIPTION	QTY
14626	Tappet Boot	1
14627	Pin Boot	2



14807 / Caliper Boot & Pin Bush Set

TTT NO	DESCRIPTION	QTY
14625	Pin Bolt - M16x1.5-70 mm	2
14628	Pin Bush - 34x30x20 mm	6
14626	Tappet Boot	2
14627	Pin Boot	4
14629	Pin Cap	4



14808 / Caliper Pin Repair Kit

TTT NO	DESCRIPTION	QTY
14622	Caliper Pin - Ø30x88 mm	1
14623	Caliper Pin - Ø30x75 mm	1
14624	Pin Bolt - M16x1.5-90 mm	1
14625	Pin Bolt - M16x1.5-70 mm	1
14756	Caliper Head Bolt	8



14662 / Roller Bearing Set

TTT NO	DESCRIPTION	QTY
13478	Roller Bearing	2



14809 / Caliper Cap & Pin Bolt Set

OEM NO : 12 999 580

TTT NO	DESCRIPTION	QTY
14624	Pin Bolt - M16x1.5-90 mm	1
14625	Pin Bolt - M16x1.5-70 mm	1
14628	Pin Bush - 34x30x20 mm	3
14626	Tappet Boot	1
14627	Pin Boot	2
14629	Pin Cap	2
14756	Caliper Head Bolt	8
14776	Caliper Head Gasket	1
14777	Caliper Head Seal	1
14778	Caliper Head Cap	1



14810 / Caliper Head Gasket Set

TTT NO	DESCRIPTION	QTY
14776	Caliper Head Gasket	1
14777	Caliper Head Seal	1
14778	Caliper Head Cap	1



14494 / Caliper Adjusting Mechanism Washer & Spring Set

TTT NO	DESCRIPTION	QTY
14773	Spring	1
14783	Bevel Washer	1
14784	Washer	1
14785	Bottom Washer	1
14786	Locker Ring	1
14787	Clips	1

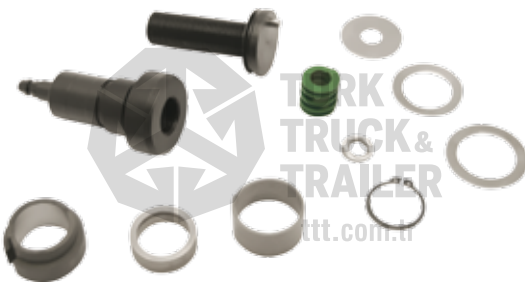

13448 / Caliper Adjusting Mechanism - (With Pin)

TTT NO	DESCRIPTION	QTY
14761	Adjusting Mechanism Slot - 110 mm	1
13451	Calibration Bolt (With Pin) - 87 mm	1
14752	Torsion Spring Ring (Thick)	1
14753	Torsion Spring Ring (Thin)	1
14754	Torsion Spring	1
14688	Grease	1

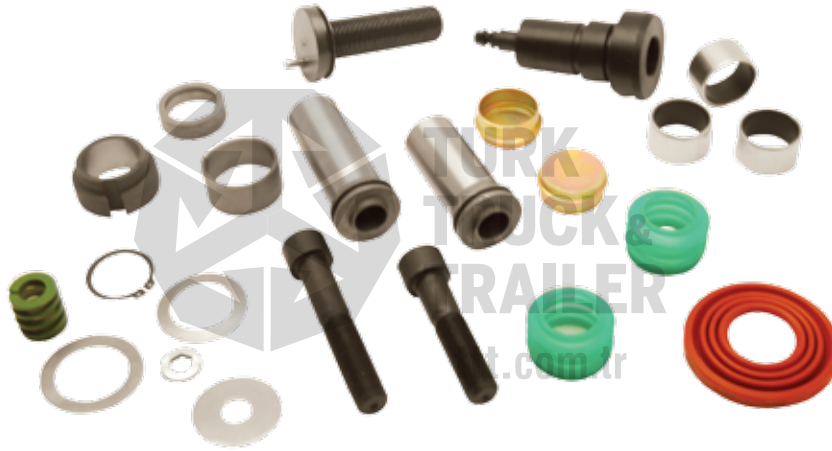

13447 / Caliper Adjusting Set

TTT NO	DESCRIPTION	QTY
13448	Caliper Adjusting Mechanism - (With Pin)	1
14622	Caliper Pin - Ø30x88 mm	1
14623	Caliper Pin - Ø30x75 mm	1
14624	Pin Bolt - M16x1.5-90 mm	1
14625	Pin Bolt - M16x1.5-70 mm	1
14628	Pin Bush - 34x30x20 mm	3
14626	Tappet Boot	1
14627	Pin Boot	2
14629	Pin Cap	2
14688	Grease	3



13451 / Calibration Bolt (With Pin) - 87 mm



13454 / Caliper Brake Lining Plate (With Groove) - R



15454 / Caliper Brake Lining Plate (With Groove) - L



14758 / Caliper Adjusting Mechanism - (With Groove)

TTT NO	DESCRIPTION	QTY
14494	Caliper Adjusting Mechanism Washer & Spring Set	1
14761	Adjusting Mechanism Slot - 110 mm	1
13452	Calibration Bolt (With Groove) - 87 mm	1
14752	Torsion Spring Ring (Thick)	1
14753	Torsion Spring Ring (Thin)	1
14754	Torsion Spring	1
14688	Grease	1



14805 / Caliper Adjusting Set

TTT NO	DESCRIPTION	QTY
14758	Caliper Adjusting Mechanism - (With Groove)	1
14622	Caliper Pin - Ø30x88 mm	1
14623	Caliper Pin - Ø30x75 mm	1
14624	Pin Bolt - M16x1.5-90 mm	1
14625	Pin Bolt - M16x1.5-70 mm	1
14628	Pin Bush - 34x30x20 mm	3
14626	Tappet Boot	1
14627	Pin Boot	2
14629	Pin Cap	2
14688	Grease	3



13452 / Calibration Bolt (With Groove) - 87 mm



13453 / Caliper Brake Lining Plate (With Pin) - R



15453 / Caliper Brake Lining Plate (With Pin) - L

19.5"



13482 / Caliper Boot & Pin Repair Kit

OEM NO : 12 999 776

TTT NO	DESCRIPTION	QTY
14632	Caliper Pin - Ø38x120 mm	1
14633	Caliper Pin - Ø38x76 mm	1
14634	Pin Bolt - M16x1.5-120 mm	1
14765	Pin Bolt - M16x1.5-80 mm	1
14635	Pin Bush - 42x38x30 mm	3
14636	Tappet Boot	1
14637	Pin Boot	2
14645	Pin Boot Washer	2
14644	Pin Cap (Long)	1
14638	Pin Cap (Short)	1
14688	Grease	2



14814 / Caliper Boot & Pin Repair Kit

TTT NO	DESCRIPTION	QTY
14632	Caliper Pin - Ø38x120 mm	1
14633	Caliper Pin - Ø38x76 mm	1
14635	Pin Bush - 42x38x30 mm	3
14636	Tappet Boot	1
14637	Pin Boot	2
14645	Pin Boot Washer	2
14644	Pin Cap (Long)	1
14638	Pin Cap (Short)	1
14688	Grease	2



14816 / Caliper Boot & Pin Bush Repair Kit

TTT NO	DESCRIPTION	QTY
14635	Pin Bush - 42x38x30 mm	3
14636	Tappet Boot	1
14637	Pin Boot	2
14645	Pin Boot Washer	2
14644	Pin Cap (Long)	1
14638	Pin Cap (Short)	1



13483 / Caliper Boot Set

TTT NO	DESCRIPTION	QTY
14636	Tappet Boot	1
14637	Pin Boot	2
14645	Pin Boot Washer	2



14662 / Roller Bearing Set

TTT NO	DESCRIPTION	QTY
13478	Roller Bearing	2



14801 / Caliper Boot & Pin Repair Kit

TTT NO	DESCRIPTION	QTY
14632	Caliper Pin - Ø38x120 mm	1
14633	Caliper Pin - Ø38x76 mm	1
14634	Pin Bolt - M16x1.5-120 mm	1
14765	Pin Bolt - M16x1.5-80 mm	1
14635	Pin Bush - 42x38x30 mm	3
14636	Tappet Boot	1
14637	Pin Boot (Green)	2
14799	Pin Boot (White)	2
14645	Pin Boot Washer	4
14644	Pin Cap (Long)	2
14638	Pin Cap (Short)	2
14688	Grease	2



14802 / Caliper Boot & Pin Bush Repair Kit

TTT NO	DESCRIPTION	QTY
14635	Pin Bush - 42x38x30 mm	3
14636	Tappet Boot	1
14637	Pin Boot (Green)	2
14799	Pin Boot (White)	2
14645	Pin Boot Washer	4
14644	Pin Cap (Long)	2
14638	Pin Cap (Short)	2

14803 / Caliper Boot & Pin Repair Kit

OEM NO : 12 999 738

TTT NO	DESCRIPTION	QTY
14632	Caliper Pin - Ø38x120 mm	1
14633	Caliper Pin - Ø38x76 mm	1
14634	Pin Bolt - M16x1.5-120 mm	1
14765	Pin Bolt - M16x1.5-80 mm	1
14635	Pin Bush - 42x38x30 mm	3
14636	Tappet Boot	1
14799	Pin Boot (White)	2
14645	Pin Boot Washer	2
14644	Pin Cap (Long)	1
14638	Pin Cap (Short)	1
14688	Grease	2





14804 / Caliper Pin & Bolt Set

TTT NO	DESCRIPTION	QTY
14632	Caliper Pin - Ø38x120 mm	1
14633	Caliper Pin - Ø38x76 mm	1
14634	Pin Bolt - M16x1.5-120 mm	1
14765	Pin Bolt - M16x1.5-80 mm	1
14756	Caliper Head Bolt	8



14688 / Grease



14494 / Caliper Adjusting Mechanism Washer & Spring Set

TTT NO	DESCRIPTION	QTY
14773	Spring	1
14783	Bevel Washer	1
14784	Washer	1
14785	Bottom Washer	1
14786	Locker Ring	1
14787	Clips	1



13458 / Caliper Adjusting Mechanism - (With Pin)

TTT NO	DESCRIPTION	QTY
14494	Caliper Adjusting Mechanism Washer & Spring Set	1
14764	Adjusting Mechanism Slot - 115 mm	1
13484	Calibration Bolt (With Pin) - 91 mm	1
14752	Torsion Spring Ring (Thick)	1
14753	Torsion Spring Ring (Thin)	1
14754	Torsion Spring	1
14688	Grease	1



13484 / Calibration Bolt (With Pin) - 91 mm



13481 / Caliper Adjusting Set

TTT NO	DESCRIPTION	QTY
13458	Caliper Adjusting Mechanism - (With Pin)	1
14632	Caliper Pin - Ø38x120 mm	1
14633	Caliper Pin - Ø38x76 mm	1
14634	Pin Bolt - M16x1.5-120 mm	1
14765	Pin Bolt - M16x1.5-80 mm	1
14635	Pin Bush - 42x38x30 mm	3
14636	Tappet Boot	1
14637	Pin Boot	2
14645	Pin Boot Washer	2
14644	Pin Cap (Long)	1
14638	Pin Cap (Short)	1
14688	Grease	3



13485 / Caliper Brake Lining Plate (With Groove) - R



15485 / Caliper Brake Lining Plate (With Groove) - L



notes

A large area of the page is filled with horizontal dashed lines, intended for writing notes.

TTT OTOMOTIV IC ve DIS TIC. LTD. STI

Address : Fatih Mh. Oto Parcacilar Sitesi
Boyluca Sk. No : 34 Selcuklu, Konya / TURKIYE
Phone : +90 332 233 34 44
Fax : +90 332 233 24 33
E-Mail : info@ttd.com.tr

ttd.com.tr