



IVECO

TYPENLISTE
CATALOGUE

FEDERN
LEAF SPRINGS



2010

MADE IN EU

TES GROUP S.A.

UL. POZNAŃSKA 169

62-080 TARNOWO PODGÓRNE, POLAND

**TEL. +48 (61) 65 711 00, +48 (61) 65 711 01
+48 (61) 65 711 05, +48 (61) 65 711 10**

FAX +48 (61) 65 711 11

HANDLOWY@TES.PL, WWW.TES.PL

INHALTSVERZEICHNIS CONTENTS

IDENTIFICATION, IDENTIFIZIERUNG	2
FORMEN; SHAPES	4
MAGIRUS-TYPEN: 70, 80, 90, 100, 110, 120, 126, 130, 135, 156, 160, 168, 170, 190, 192, 200, 210, 230, 232, 235, 256, 260, 270, 280, 290, 310, 320, 330, 340, 350, 360, 400	10
IVECO-TYPEN: 28.-59., 60.-79., 80.-100., 110.-120., 130.-159., 160.-165., 170.-175., 180., 190., 220., 240., 260., 300., 330.	33
DAILY	56
DUCATO	63
EUROCARGO	64
EUROSTAR	72
EUROTECH	75
EUROTRAKKER	79

IDENTIFICATION IDENTIFIZIERUNG

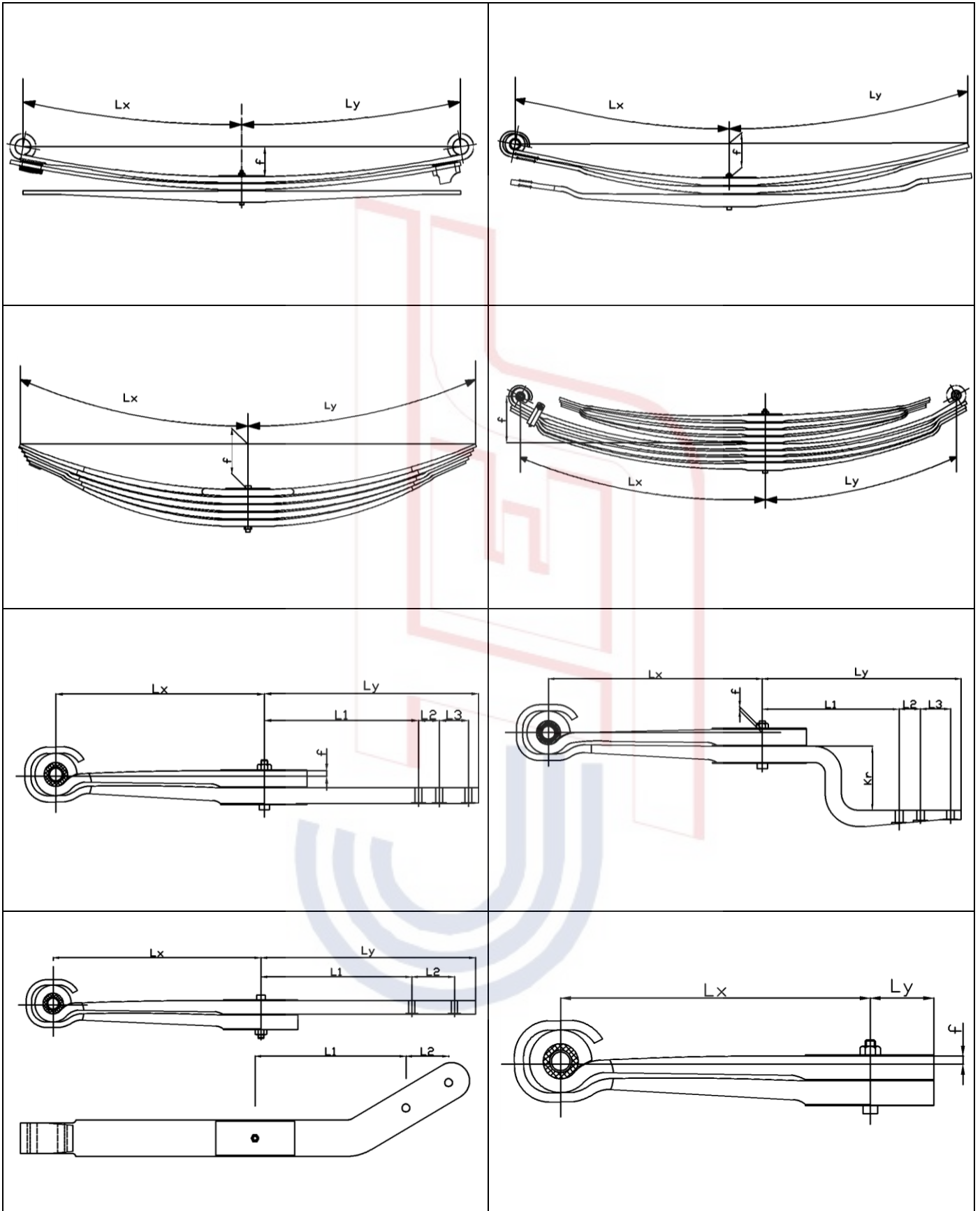

IDENTIFICATION IDENTIFIZIERUNG

Heading of catalogue	Kopfspalte der Typenliste	Заголовки в таблице типов рессор
Article no.	Artikel-Nr.	Артикул Ио.
suitable for vehicle type	passend für Fahrzeugtype	Предназначена для типа автомобиля
V = front spring	V = Vorderfeder	V = передняя рессора
H = rear spring	H = Hinterfeder	H = задняя рессора
T = part of the complete spring(main spring)	T = Teil aus kompletter Feder (Hauptfeder)	T = деталь из комплектной рессоры
Z = helper spring, detached	Z = Zusatzfeder, lose	Z = дополнительная рессора, отдельная
L = trailing arm for air suspension	L = Lenkerfeder	L= подруливающая рессора
Number of leaves	Blattzahl	Количество листов
Width largeur	Breite	Ширина
Length	Lange	Длина
front	vorn	передняя
rear	hinten	задняя
Free arch	Sprengung, unbelastet	Прогиб рессоры в ненагруженном состоянии
Inside diameter of bushes	Buchsen-innen	Внутренний диаметр втулки
front	vorne	передняя
rear	hinten	задняя
R = eye without bush	R = Rolle ohne Buchse	R= ролик без втулки
Shape	Form	Форма
Remarks, info	Bemerkungen, info	Примечания
Weight on the axle	Achslast	нагрузка на ось

IVECO FORMEN; SHAPES

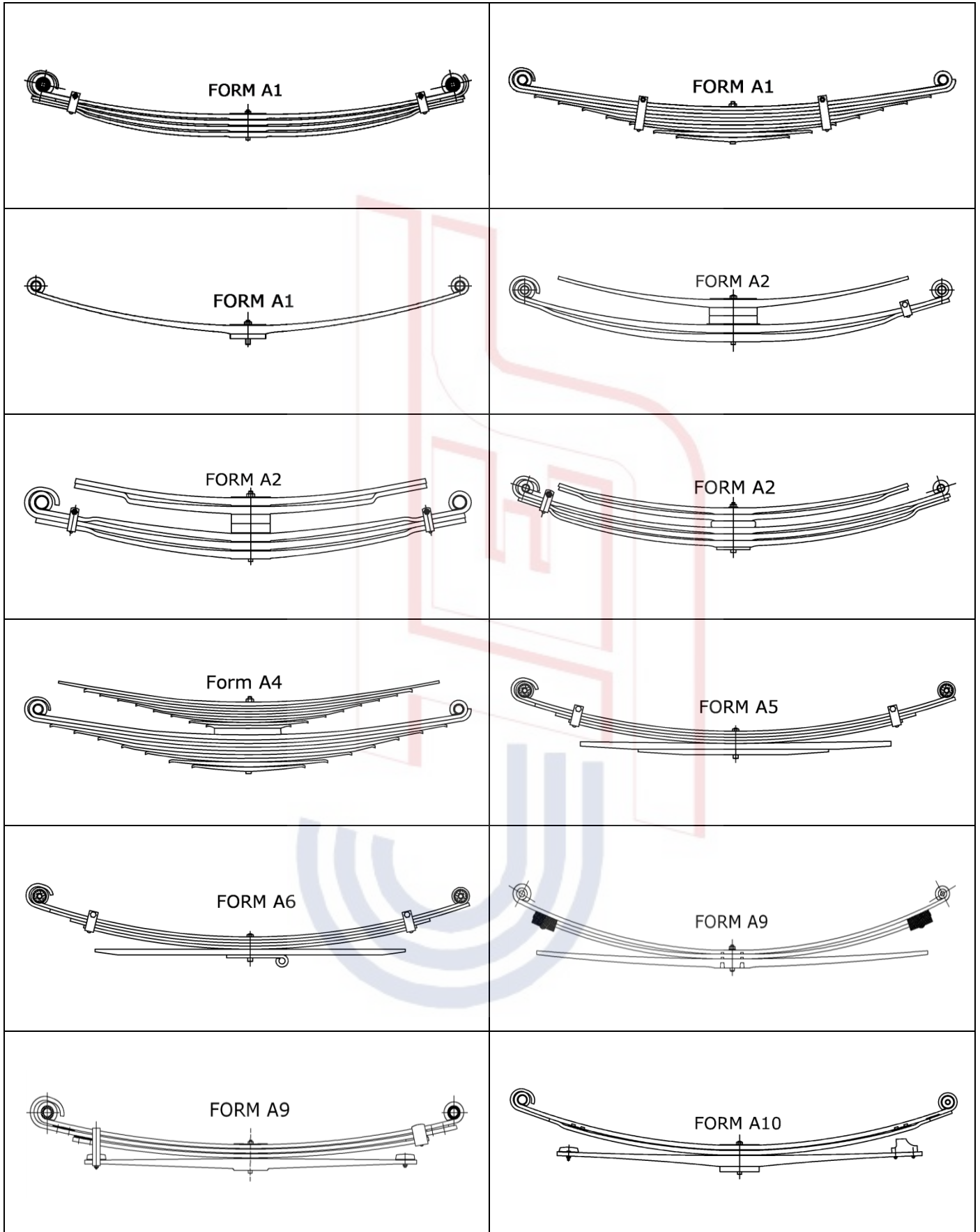

IVECO FORMEN; SHAPES

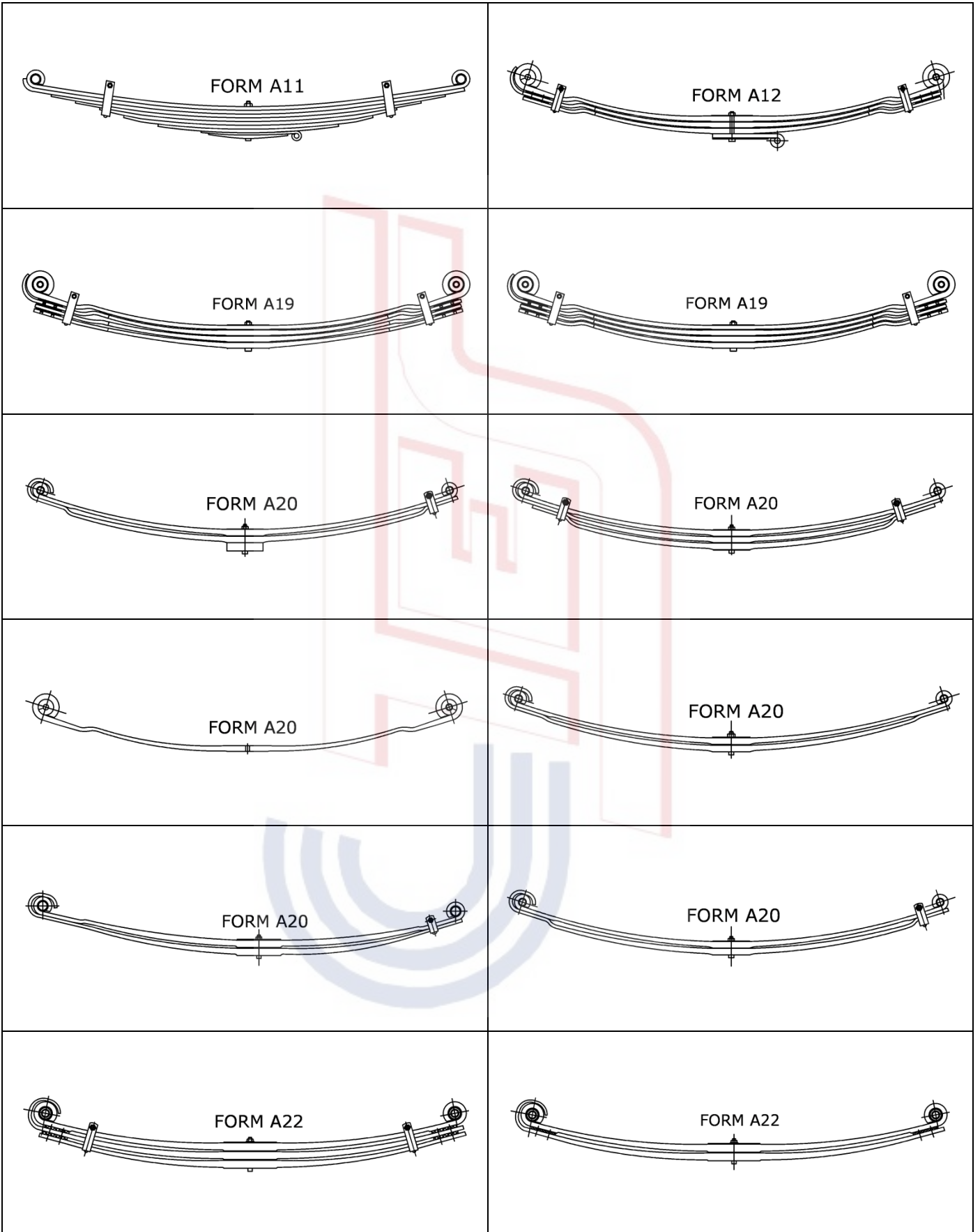

IVECO FORMEN; SHAPES

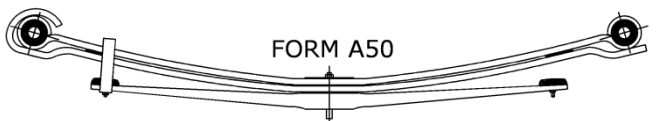
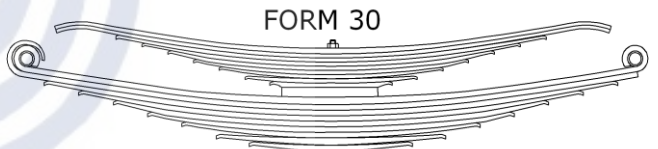
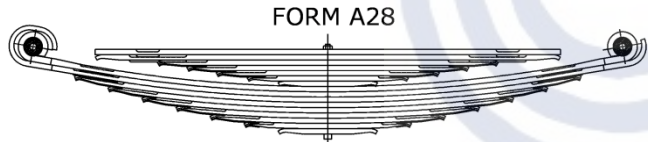
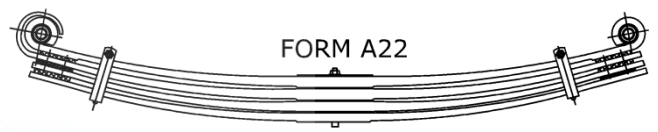
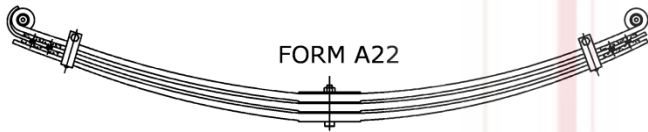
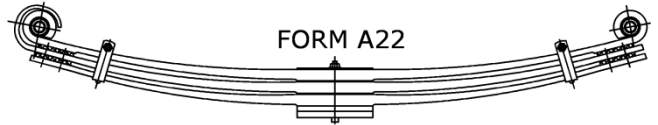
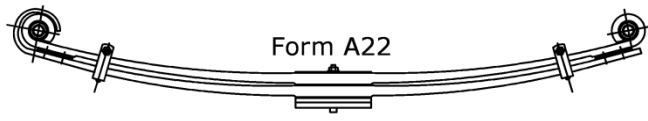

IVECO FORMEN; SHAPES

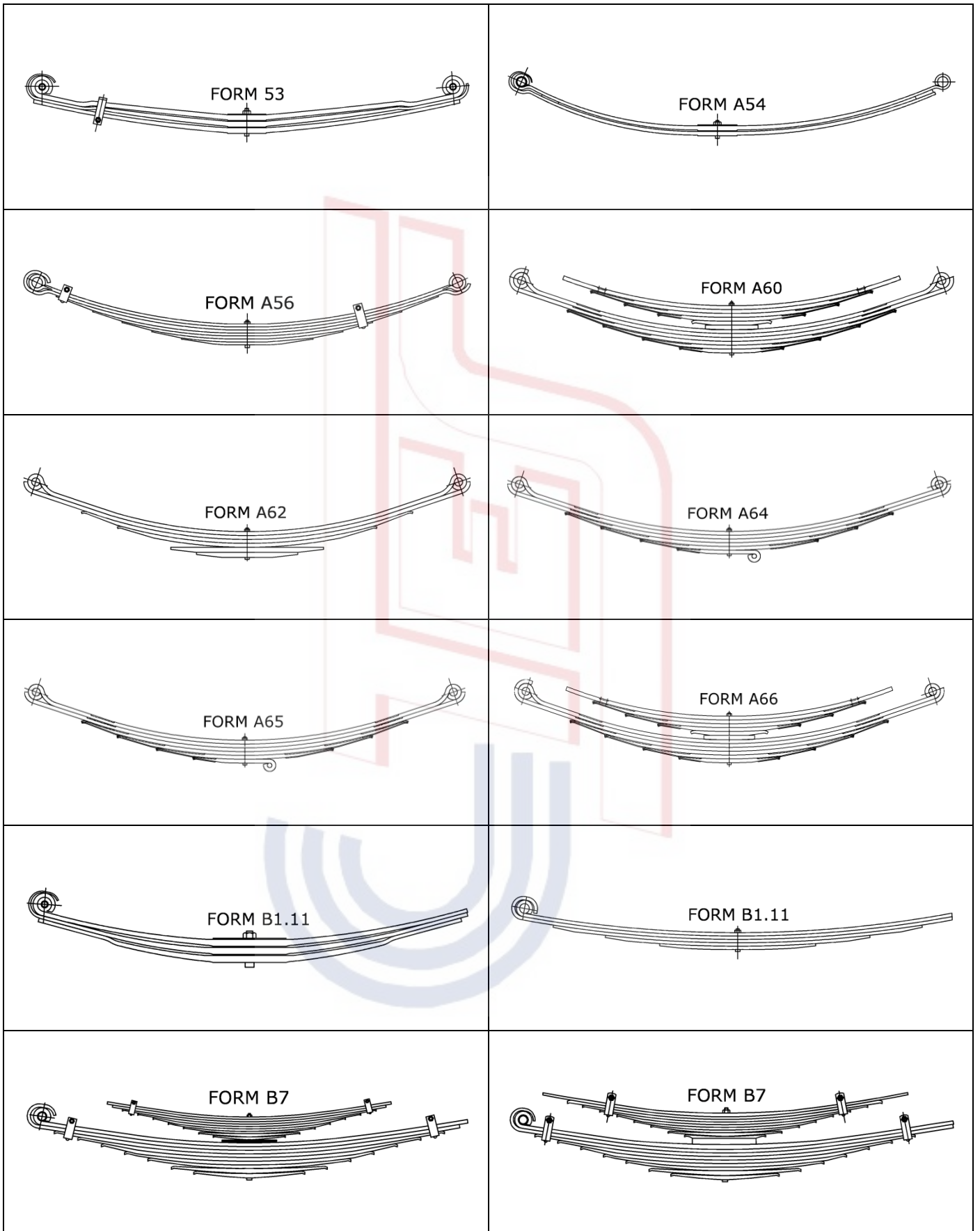

IVECO FORMEN; SHAPES

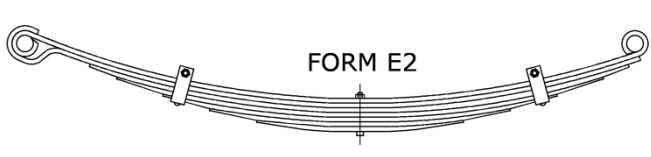
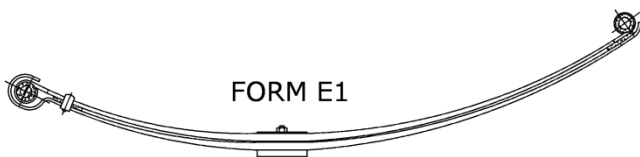
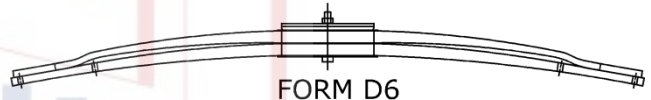
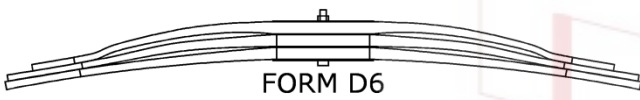
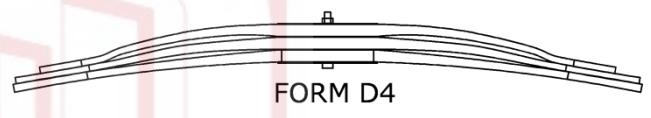
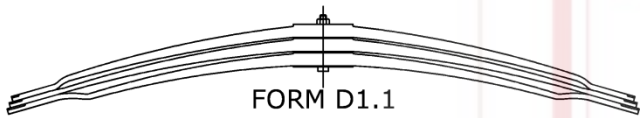
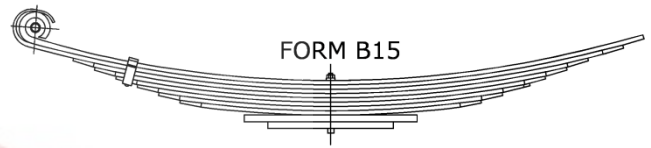
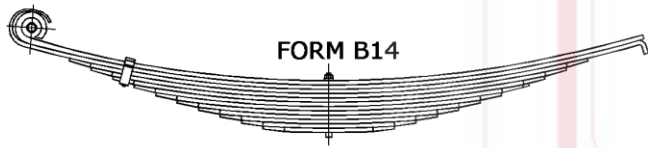
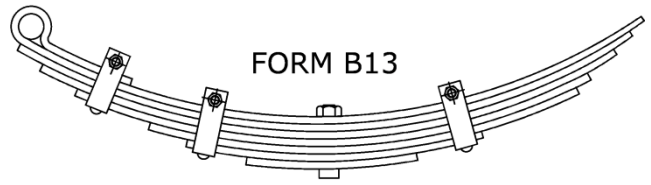
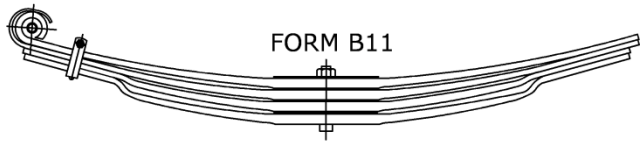

IVECO FORMEN; SHAPES

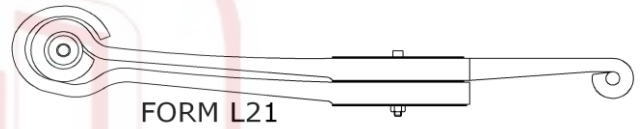
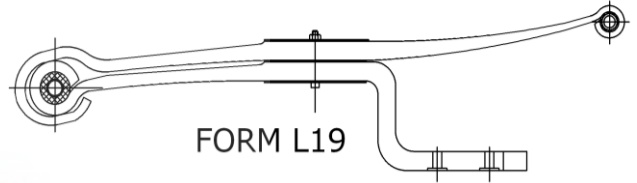
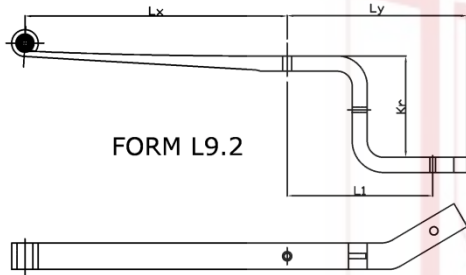
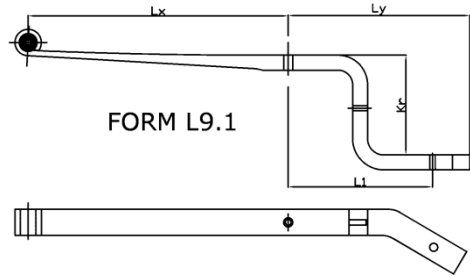
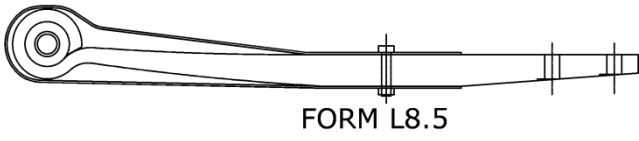

MAGIRUS-TYPEN

IVECO

MAGIRUS-TYPEN

Artikel.Nr.	Fahrzeugtyp	Info	Achsl.	Blattzahl	Breite	Lx/L1	Ly/L2	Spr./ Kr.	Buchsen vorn	Buchsen hinten	Form	Paket- stärke
Art.-No.	Type		Axle Load	Leaves	Width			FreeArch /Crank	Bush front	Bush rear	Shape	Total height
66774000	80 D 6 F	3/8,6/7,Sil,-Bl.	V	9	60	640	640	164	R34	24x34	A26	66
66700000	80 D 6 FK	3/8,6/7	V	9	60	640	640	180	R34	24x34	A26	64
66774000	80 D 6 FK	3/8,6/7,Sil,-Bl.	V	9	60	640	640	164	R34	24x34	A26	66
66701000	80 D 6 FK	9/10,1/4Pl.,1/9,2/8	H	12	60	740	835	183	28x48		B13	119
66771000	80 D 6 FK	2/11,7/10,1/4Pl.,3/9	H	12	60	740	820	186	R48		B7	123
66700000	80 D 6 FL	3/8,6/7	V	9	60	640	640	180	R34	24x34	A26	64
66774000	80 D 6 FL	3/8,6/7,Sil,-Bl.	V	9	60	640	640	164	R34	24x34	A26	66
66701000	80 D 6 FL	9/10,1/4Pl.,1/9,2/8	H	12	60	740	835	183	28x48		B13	119
66771000	80 D 6 FL	2/11,7/10,1/4Pl.,3/9	H	12	60	740	820	186	R48		B7	123
66791000	80 D 6 FL	2/11,7/10,1/4Pl.,2/9,1/8	H	12	70	740	840	175	30x40		B7	130
66486000	80 D 7 F	4/8,6/7	V	10	60	645	645	176	24x34	24x34	A32	80
66791000	80 D 7 F	2/11,7/10,1/4Pl.,2/9,1/8	H	12	70	740	840	175	30x40		B7	130
66781000	80 D 7 F	2/11,7/10,1/Pl.,4/	H	13	70	740	840		30x40		B7	
66486000	80 D 7 FG	4/8,6/7	V	10	60	645	645	176	24x34	24x34	A32	80
66457000	80 D 7 FG		H	11	70	623	732	95	30x40		B1.11	
66486000	80 D 7 FGB	4/8,6/7	V	10	60	645	645	176	24x34	24x34	A32	80
66457000	80 D 7 FGB		H	11	70	623	732	95	30x40		B1.11	
66486000	80 D 7 FK	4/8,6/7	V	10	60	645	645	176	24x34	24x34	A32	80
66702000	80 D 7 FK	4/8,6/7	V	10	60	640	640	180	24x34	24x34	A32	74
66791000	80 D 7 FK	2/11,7/10,1/4Pl.,2/9,1/8	H	12	70	740	840	175	30x40		B7	130
66781000	80 D 7 FK	2/11,7/10,1/Pl.,4/	H	13	70	740	840		30x40		B7	
66700000	80 D 7 FL	3/8,6/7	V	9	60	640	640	180	R34	24x34	A26	64
66486000	80 D 7 FL	4/8,6/7	V	10	60	645	645	176	24x34	24x34	A32	80
66791000	80 D 7 FL	2/11,7/10,1/4Pl.,2/9,1/8	H	12	70	740	840	175	30x40		B7	130
66781000	80 D 7 FL	2/11,7/10,1/Pl.,4/	H	13	70	740	840		30x40		B7	
66486000	80 D 8 F	4/8,6/7	V	10	60	645	645	176	24x34	24x34	A32	80
66486000	80 D 8 FK	4/8,6/7	V	10	60	645	645	176	24x34	24x34	A32	80
66791000	80 D 8 FK	2/11,7/10,1/4Pl.,2/9,1/8	H	12	70	740	840	175	30x40		B7	130
66781000	80 D 8 FK	2/11,7/10,1/Pl.,4/	H	13	70	740	840		30x40		B7	
66486000	80 D 8 FL	4/8,6/7	V	10	60	645	645	176	24x34	24x34	A32	80
66702000	80 D 8 FL	4/8,6/7	V	10	60	640	640	180	24x34	24x34	A32	74
66791000	80 D 8 FL	2/11,7/10,1/4Pl.,2/9,1/8	H	12	70	740	840	175	30x40		B7	130
66781000	80 D 8 FL	2/11,7/10,1/Pl.,4/	H	13	70	740	840		30x40		B7	
67200000	90 D 5 F	1/10,3/11,1/13,1/13Pl.,1/10Pl.	V	5	70	705	705	135	24x30	24x30	A5	79
67210000	90 D 5 F	1/10,3/11,1/15,1/21Pl.	V	5	70	705	705	106	24x30	24x30	A5	79
67201000	90 D 5 F	5/10,3/14,1/13Pl.,1/12Pl.	H	8	70	675	675	110	24x30	24x30	E2	117
67211000	90 D 5 F	2/10,3/11,3/14,1/25Pl.	H	8	70	675	675	94	24x30	24x30	E2	120
67200000	90 D 5 FK	1/10,3/11,1/13,1/13Pl.,1/10Pl.	V	5	70	705	705	135	24x30	24x30	A5	79
67210000	90 D 5 FK	1/10,3/11,1/15,1/21Pl.	V	5	70	705	705	106	24x30	24x30	A5	79
67203000	90 D 5 FK	4/11,3/14	H	7	70	710	710	119	24x30	24x30	A5	86
67201000	90 D 5 FK	5/10,3/14,1/13Pl.,1/12Pl.	H	8	70	675	675	110	24x30	24x30	E2	117
67211000	90 D 5 FK	2/10,3/11,3/14,1/25Pl.	H	8	70	675	675	94	24x30	24x30	E2	120
67200000	90 D 5 FL	1/10,3/11,1/13,1/13Pl.,1/10Pl.	V	5	70	705	705	135	24x30	24x30	A5	79
67210000	90 D 5 FL	1/10,3/11,1/15,1/21Pl.	V	5	70	705	705	106	24x30	24x30	A5	79
67203000	90 D 5 FL	4/11,3/14	H	7	70	710	710	119	24x30	24x30	A5	86
66849000	90 D 5 FL	5/13,3/13	H	8	70	710	710	91	24x30	24x30	A1	104
67201000	90 D 5 FL	5/10,3/14,1/13Pl.,1/12Pl.	H	8	70	675	675	110	24x30	24x30	E2	117
67211000	90 D 5 FL	2/10,3/11,3/14,1/25Pl.	H	8	70	675	675	94	24x30	24x30	E2	120
67200000	90 D 5 FV	1/10,3/11,1/13,1/13Pl.,1/10Pl.	V	5	70	705	705	135	24x30	24x30	A5	79
67210000	90 D 5 FV	1/10,3/11,1/15,1/21Pl.	V	5	70	705	705	106	24x30	24x30	A5	79
67230000	90 D 5 FV	6/10,2/14	V	8	70	705	705	115	24x30	24x30	A5	88
67203000	90 D 5 FV	4/11,3/14	H	7	70	710	710	119	24x30	24x30	A5	86
66849000	90 D 5 FV	5/13,3/13	H	8	70	710	710	91	24x30	24x30	A1	104
67201000	90 D 5 FV	5/10,3/14,1/13Pl.,1/12Pl.	H	8	70	675	675	110	24x30	24x30	E2	117
67211000	90 D 5 FV	2/10,3/11,3/14,1/25Pl.	H	8	70	675	675	94	24x30	24x30	E2	120
67231000	90 D 5 FV	6/10,2/11,1/15Pl.,3/6,5/7	H	16	70	713	713	167	24x30	24x30	A28	150
67221000	90 D 6 FK	5/11/2/10,2/11Pl.,7/7	H	14	70	710	710	165	24x30	24x30	A28	146

MAGIRUS-TYPEN
IVECO
MAGIRUS-TYPEN

Artikel.Nr.	Fahrzeugtyp	Info	Achsl.	Blattzahl	Breite	Lx/L1	Ly/L2	Spr./Kr.	Buchsen vorn	Buchsen hinten	Form	Paketstärke
Art.-No.	Type		Axle Load	Leaves	Width			FreeArch/Crank	Bush front	Bush rear	Shape	Total height
67230000	90 D 6 FL	6/10,2/14	V		70	705	705	115	24x30	24x30	A5	88
67221000	90 D 6 FL	5/11/2/10,2/11Pl.,7/7	H	14	70	710	710	165	24x30	24x30	A28	146
67231000	90 D 6 FL	6/10,2/11,1/15Pl.,3/6,5/7	H	16	70	713	713	167	24x30	24x30	A28	150
67221000	90 D 6 FV	5/11/2/10,2/11Pl.,7/7	H	14	70	710	710	165	24x30	24x30	A28	146
67208000	90 M 5 F	1/10,3/11,1/13	V	5	70	705	705	112	24x30	24x30	A1	56
67217000	90 M 5 F	5/11,3/14	H	8	70	715	715	96	24x30	24x30	A5	97
67208000	90 M 5 FK	1/10,3/11,1/13	V	5	70	705	705	112	24x30	24x30	A1	56
67212000	90 M 5 FK	5/10,2/14	V	7	70	705	705	104	24x30	24x30	A5	80
67215000	90 M 5 FK	4/11,3/14	H	7	70	715	715	111	24x30	24x30	A5	86
67217000	90 M 5 FK	5/11,3/14	H	8	70	715	715	96	24x30	24x30	A5	97
67221000	90 M 5 FK	5/11/2/10,2/11Pl.,7/7	H	14	70	710	710	165	24x30	24x30	A28	146
67208000	90 M 5 FL	1/10,3/11,1/13	V	5	70	705	705	112	24x30	24x30	A1	56
67212000	90 M 5 FL	5/10,2/14	V	7	70	705	705	104	24x30	24x30	A5	80
67222000	90 M 5 FL	6/10,1/2Lg.,2/14	V	8	70	707	707	135	24x30	24x30	A5	90
67215000	90 M 5 FL	4/11,3/14	H	7	70	715	715	111	24x30	24x30	A5	86
67217000	90 M 5 FL	5/11,3/14	H	8	70	715	715	96	24x30	24x30	A5	97
67221000	90 M 5 FL	5/11/2/10,2/11Pl.,7/7	H	14	70	710	710	165	24x30	24x30	A28	146
67219000	90 M 5 FL	8,2pl.,8	H	7,5	70	700	700				A28	
67208000	90 M 5 FV	1/10,3/11,1/13	V	5	70	705	705	112	24x30	24x30	A1	56
67212000	90 M 5 FV	5/10,2/14	V	7	70	705	705	104	24x30	24x30	A5	80
67215000	90 M 5 FV	4/11,3/14	H	7	70	715	715	111	24x30	24x30	A5	86
67217000	90 M 5 FV	5/11,3/14	H	8	70	715	715	96	24x30	24x30	A5	97
67221000	90 M 5 FV	5/11/2/10,2/11Pl.,7/7	H	14	70	710	710	165	24x30	24x30	A28	146
67212000	90 M 6 F	5/10,2/14	V	7	70	705	705	104	24x30	24x30	A5	80
67221000	90 M 6 F	5/11/2/10,2/11Pl.,7/7	H	14	70	710	710	165	24x30	24x30	A28	146
66498000	90 M 6 FK	3/10,1/11,1/11/1/12	V	6	70	785	950	212	22x28		B15	64
67212000	90 M 6 FK	5/10,2/14	V	7	70	705	705	104	24x30	24x30	A5	80
66495000	90 M 6 FK	2/11,2/12,2/14	H	8	70	700	860	135	25x32		B15	74
66497000	90 M 6 FK	3/10,3/11,3/15	H	9	70	700	880	195	25x32		B15	108
67221000	90 M 6 FK	5/11/2/10,2/11Pl.,7/7	H	14	70	710	710	165	24x30	24x30	A28	146
67208000	90 M 6 FL	1/10,3/11,1/13	V	5	70	705	705	112	24x30	24x30	A1	56
66498000	90 M 6 FL	3/10,1/11,1/11/1/12	V	6	70	785	950	212	22x28		B15	64
67212000	90 M 6 FL	5/10,2/14	V	7	70	705	705	104	24x30	24x30	A5	80
67222000	90 M 6 FL	6/10,1/2Lg.,2/14	V	8	70	707	707	135	24x30	24x30	A5	90
66495000	90 M 6 FL	2/11,2/12,2/14	H	6	70	700	860	135	25x32		B15	74
67217000	90 M 6 FL	5/11,3/14	H	8	70	715	715	96	24x30	24x30	A5	97
66497000	90 M 6 FL	3/10,3/11,3/15	H	9	70	700	880	195	25x32		B15	108
67221000	90 M 6 FL	5/11/2/10,2/11Pl.,7/7	H	14	70	710	710	165	24x30	24x30	A28	146
67208000	90 M 6 FV	1/10,3/11,1/13	V	5	70	705	705	112	24x30	24x30	A1	56
67212000	90 M 6 FV	5/10,2/14	V	7	70	705	705	104	24x30	24x30	A5	80
67217000	90 M 6 FV	5/11,3/14	H	8	70	715	715	96	24x30	24x30	A5	97
67221000	90 M 6 FV	5/11/2/10,2/11Pl.,7/7	H	14	70	710	710	165	24x30	24x30	A28	146
66617000	90 M 7 FG	12/9	H	7	70	570	680	97	25x32		B14	108
66498000	90 M 7 FGB	3/10,1/11,1/11/1/12	V	6	70	785	950	212	22x28		B15	64
66497000	90 M 7 FGB	3/10,3/11,3/15	H	9	70	700	880	195	25x32		B15	108
66617000	90 M 7 FGB	12/9	H	7	70	570	680	97	25x32		B14	108
66498000	90 M 7 FK	3/10,1/11,1/11/1/12	V	6	70	785	950	212	22x28		B15	64
67222000	90 M 7 FK	6/10,1/2Lg.,2/14	V	8	70	707	707	135	24x30	24x30	A5	90
66495000	90 M 7 FK	2/11,2/12,2/14	H	6	70	700	860	135	25x32		B15	74
66497000	90 M 7 FK	3/10,3/11,3/15	H	9	70	700	880	195	25x32		B15	108
67219000	90 M 7 FK		H	7,5	70	700	700				A28	
66498000	90 M 7 FL	3/10,1/11,1/11/1/12	V	6	70	785	950	212	22x28		B15	64
66496000	90 M 7 FL	6/10,2/11	V	8	70	785	950	205	22x28		B15	82
67222000	90 M 7 FL	6/10,1/2Lg.,2/14	V	8	70	707	707	135	24x30	24x30	A5	90
66495000	90 M 7 FL	2/11,2/12,2/14	H	6	70	700	860	135	25x32		B15	74
66497000	90 M 7 FL	3/10,3/11,3/15	H	9	70	700	880	195	25x32		B15	108
66617000	90 M 7 FL	12/9	H	7	70	570	680	97	25x32		B14	108

MAGIRUS-TYPEN

IVECO

MAGIRUS-TYPEN

Artikel.Nr.	Fahrzeugtyp	Info	Achsl.	Blattzahl	Breite	Lx/L1	Ly/L2	Spr./ Kr.	Buchsen vorn	Buchsen hinten	Form	Paket- stärke	
Art.-No.	Type		Axle Load	Leaves	Width			FreeArch/ Crank	Bush front	Bush rear	Shape	Total height	
67219000	90 M 7 FL		H	7,5	16	70	700	700			A28		
66917000	90 M 7 FL	6/11,2/12,1/Pl.,9/7,1/Pl.	H		17	70	710	710		24	24	A30	
67222000	90 M 7 FV	6/10,1/2Lg.,2/14	V		8	70	707	707	135	24x30	24x30	A5	90
67219000	90 M 7 FV		H	7,5	16	70	700	700				A28	
66496000	90 M 8 FK	6/10,2/11	V		8	70	785	950	205	22x28		B15	82
66497000	90 M 8 FK	3/10,3/11,3/15	H		9	70	700	880	195	25x32		B15	108
66496000	90 M 8 FL	6/10,2/11	V		8	70	785	950	205	22x28		B15	82
66470000	90 M 8 FL	2/10,2/11,3/10,3/11	V		10	70	785	945	128	22x28		B15	105
66497000	90 M 8 FL	3/10,3/11,3/15	H		9	70	700	880	195	25x32		B15	108
66496000	90 M 9 FL	6/10,2/11	V		8	70	785	950	205	22x28		B15	82
67222000	90 M 9 FL	6/10,1/2Lg.,2/14	V		8	70	707	707	135	24x30	24x30	A5	90
66470000	90 M 9 FL	2/10,2/11,3/10,3/11	V		10	70	785	945	128	22x28		B15	105
66497000	90 M 9 FL	3/10,3/11,3/15	H		9	70	700	880	195	25x32		B15	108
66486000	100 D 7	4/8,6/7	V		10	60	645	645	176	24x34	24x34	A32	80
66791000	100 D 7	2/11,7/10,1/4Pl.,2/9,1/8	H		12	70	740	840	175	30x40		B7	130
66486000	100 D 8	4/8,6/7	V		10	60	645	645	176	24x34	24x34	A32	80
66791000	100 D 8	2/11,7/10,1/4Pl.,2/9,1/8	H		12	70	740	840	175	30x40		B7	130
66486000	100 D 9	4/8,6/7	V		10	60	645	645	176	24x34	24x34	A32	80
66791000	100 D 9	2/11,7/10,1/4Pl.,2/9,1/8	H		12	70	740	840	175	30x40		B7	130
66940000	100 M 6 FAL	8/10	V		8	80	775	775	140	R25	R25	A32	80
66941000	100 M 6 FAL	8/10,1/20Pl.,5/8	H		13	80	775	775	150	R25	R25	A28	140
66486000	110 D 7	4/8,6/7	V		10	60	645	645	176	24x34	24x34	A32	80
66594000	110 D 7	12/9	V		12	60	760	910	206	20x25		B15	108
66771000	110 D 7	2/11,7/10,1/4Pl.,3/9	H		12	60	740	820	186	R48		B7	123
66791000	110 D 7	2/11,7/10,1/4Pl.,2/9,1/8	H		12	70	740	840	175	30x40		B7	130
66781000	110 D 7	2/11,7/10,1/Pl.,4/	H		13	70	740	840		30x40		B7	
66486000	110 D 8	4/8,6/7	V		10	60	645	645	176	24x34	24x34	A32	80
66594000	110 D 8	12/9	V		12	60	760	910	206	20x25		B15	108
66771000	110 D 8	2/11,7/10,1/4Pl.,3/9	H		12	60	740	820	186	R48		B7	123
66791000	110 D 8	2/11,7/10,1/4Pl.,2/9,1/8	H		12	70	740	840	175	30x40		B7	130
66781000	110 D 8	2/11,7/10,1/Pl.,4/	H		13	70	740	840		30x40		B7	
66820000	120 D 11	7/11	V		7	80	840	840	204	R25	R25	A32	77
66811000	120 D 11	4/12,1/10,2/18,2/10,3/12	H		9	100	900	900	220	R30	R30	A28	150
66881000	120 D 11	4/12,1/10Pl.,2/18,1/20Pl.,3/12,1/10,1/4Pl.	H		10	100	900	900	190	R30	R30	A28	164
66707000	120 D 11	5/12,1/14Pl.,2/20,1/20Pl.,3/12,1/10	H		11	100	900	900	200	R30	R30	A28	180
66807000	120 D 11	5/12,1/15Pl.,2/20,1/20Pl.,4/12,1/10	H		12	100	900	900	209	R30	R30	A28	193
66588000	120 D 12	7/10	V		7	80	760	760	146	R30	R30	A32	70
66772000	120 D 12	7/10	V		7	80	760	760	158	R25	R25	A32	70
66820000	120 D 12	7/11	V		7	80	840	840	204	R25	R25	A32	77
66768000	120 D 12	8/11	V		8	80	840	840	202	R25	R25	A32	88
66581000	120 D 12	11/11,2/10Pl.,6/9	H		17	90	750	750	125	25x30	25x30	A4	195
66811000	120 D 12	4/12,1/10,2/18,2/10,3/12	H		9	100	900	900	220	R30	R30	A28	150
66881000	120 D 12	4/12,1/10Pl.,2/18,1/20Pl.,3/12,1/10,1/4Pl.	H		10	100	900	900	190	R30	R30	A28	164
66707000	120 D 12	5/12,1/14Pl.,2/20,1/20Pl.,3/12,1/10	H		11	100	900	900	200	R30	R30	A28	180
66819000	120 D 12	8/13,1/P,3/13	H		11	100	900	900	165	R30	R30	A4	163
66768000	120 D 13	8/11	V		8	80	840	840	202	R25	R25	A32	88
66752000	120 D 13	9/11	V		9	80	840	840	176	R25	R25	A32	99
66881000	120 D 13	4/12,1/10Pl.,2/18,1/20Pl.,3/12,1/10,1/4Pl.	H		10	100	900	900	190	R30	R30	A28	164
66707000	120 D 13	5/12,1/14Pl.,2/20,1/20Pl.,3/12,1/10	H		11	100	900	900	200	R30	R30	A28	180
66819000	120 D 13	8/13,1/P,3/13	H		11	100	900	900	165	R30	R30	A4	163
66807000	120 D 13	5/12,1/15Pl.,2/20,1/20Pl.,4/12,1/10	H		12	100	900	900	209	R30	R30	A28	193
66774000	120 D 7	3/8,6/7,Sil,-Bl.	V		9	60	640	640	164	R34	24x34	A26	66
66486000	120 D 7	4/8,6/7	V		10	60	645	645	176	24x34	24x34	A32	80

MAGIRUS-TYPEN
IVECO
MAGIRUS-TYPEN

Artikel.Nr.	Fahrzeugtyp	Info	Achsl.	Blattzahl	Breite	Lx/L1	Ly/L2	Spr./ Kr.	Buchsen vorn	Buchsen hinten	Form	Paket- stärke
Art.-No.	Type		Axle Load	Leaves	Width			FreeArch /Crank	Bush front	Bush rear	Shape	Total height
66594000	120 D 7	12/9	V	12	60	760	910	206	20x25		B15	108
66457000	120 D 7		H	11	70	623	732	95	30x40		B1.11	
66791000	120 D 7	2/11,7/10,1/4Pl.,2/9,1/8	H	12	70	740	840	175	30x40		B7	130
66781000	120 D 7	2/11,7/10,1/Pl.,4/	H	13	70	740	840		30x40		B7	
66774000	120 D 8	3/8,6/7,Sil,-Bl.	V	9	60	640	640	164	R34	24x34	A26	66
66486000	120 D 8	4/8,6/7	V	10	60	645	645	176	24x34	24x34	A32	80
66594000	120 D 8	12/9	V	12	60	760	910	206	20x25		B15	108
66457000	120 D 8		H	11	70	623	732	95	30x40		B1.11	
66791000	120 D 8	2/11,7/10,1/4Pl.,2/9,1/8	H	12	70	740	840	175	30x40		B7	130
66781000	120 D 8	2/11,7/10,1/Pl.,4/	H	13	70	740	840		30x40		B7	
66280000	120 D 9		V	14	60	600	860	105	20x25		B1.11	116
66820000	120 D 9	7/11	V	7	80	840	840	204	R25	R25	A32	77
66287000	120 D 9	4/9,9/9,1/9Pl.,6/9	H	19	90	660	660	97	25x30	25x30	A4	169
66801000	120 D 9	4/12,1/10Pl.,2/18,1/20Pl.,2/12	H	8	100	900	900	220	R30	R30	A28	138
66881000	120 D 9	4/12,1/10Pl.,2/18,1/20Pl.,3/12,1/10,1/4Pl.	H	10	100	900	900	190	R30	R30	A28	164
66518000	126 D 11	7/11	V	7	70	760	760	180	22x26	22x26	A11	77
66562000	126 D 11	7/11	V	7	70	760	875	175	22x26		B15	77
66584000	126 D 11	10/10	V	10	70	760	760	175	22x26	22x26	A11	100
66516000	126 D 11	11/9	V	11	70	760	760	170	22x26	22x26	A11	99
66560000	126 D 11	11/9	V	11	70	760	870	200	22x26		B15	99
66580000	126 D 11	11/9	V	11	70	760	910	210	22x26		B15	99
66340000	126 D 11	14/9	V	14	70	760	760	135	22x26	22x26	A1	126
66511000	126 D 11	10/11,1/10,6/9	H	16	90	750	750	145	25x30	25x30	A4	184
66581000	126 D 11	11/11,2/10Pl.,6/9	H	17	90	750	750	125	25x30	25x30	A4	195
66584000	126 D 12	10/10	V	10	70	760	760	175	22x26	22x26	A11	100
66560000	126 D 12	11/9	V	11	70	760	870	200	22x26		B15	99
66511000	126 D 12	10/11,1/10,6/9	H	16	90	750	750	145	25x30	25x30	A4	184
66581000	126 D 12	11/11,2/10Pl.,6/9	H	17	90	750	750	125	25x30	25x30	A4	195
66590000	126 D 13	14/9	V	14	70	760	910	230	22x26		B15	126
66591000	126 D 13	12/11,1/20Pl.,7/9	H	19	90	750	750	125	25x30	25x30	A4	215
66590000	126 D 14	14/9	V	14	70	760	910	230	22x26		B15	126
66591000	126 D 14	12/11,1/20Pl.,7/9	H	19	90	750	750	125	25x30	25x30	A4	215
66340000	126 D 15	14/9	V	14	70	760	760	135	22x26	22x26	A1	126
66600000	126 D 15	14/9	V	14	70	760	870	150	22x26		B1.11	126
66611000	126 D 15	4/12,8/11,1/10Pl.,7/10	H	19	90	800	800	132	25x30	25x30	A4	216
66601000	126 D 15	13/12,2/5,7/9	H	20	100	805	950	109	30x36		B7	229
66820000	130 D 11	7/11	V	7	80	840	840	204	R25	R25	A32	77
66494000	130 D 11	6/10,2/11,1/16Pl.	V	8	80	785	950	230	25x32		B15	98
66768000	130 D 11	8/11	V	8	80	840	840	202	R25	R25	A32	88
66752000	130 D 11	9/11	V	9	80	840	840	176	R25	R25	A32	99
66499000	130 D 11	4/11,3/12,3/16	H	10	80	800	990	215	30x36		B14	128
66801000	130 D 11	4/12,1/10Pl.,2/18,1/20Pl.,2/12	H	8	100	900	900	220	R30	R30	A28	138
66881000	130 D 11	4/12,1/10Pl.,2/18,1/20Pl.,3/12,1/10,1/4Pl.	H	10	100	900	900	190	R30	R30	A28	164
66707000	130 D 11	5/12,1/14Pl.,2/20,1/20Pl.,3/12,1/10	H	11	100	900	900	200	R30	R30	A28	180
66819000	130 D 11	8/13,1/P,3/13	H	11	100	900	900	165	R30	R30	A4	163
66807000	130 D 11	5/12,1/15ZPl.,2/20,1/20Pl.,4/12,1/10	H	12	100	900	900	209	R30	R30	A28	193
66820000	130 D 12	7/11	V	7	80	840	840	204	R25	R25	A32	77
66768000	130 D 12	8/11	V	8	80	840	840	202	R25	R25	A32	88
66752000	130 D 12	9/11	V	9	80	840	840	176	R25	R25	A32	99
66900000	130 D 12	10/10	V	10	80	840	840	186	R25	R25	A11	100
66819000	130 D 12	8/13,1/P,3/13	H	11	100	900	900	165	R30	R30	A4	163
66807000	130 D 12	5/12,1/15Pl.,2/20,1/20Pl.,4/12,1/10	H	12	100	900	900	209	R30	R30	A28	193
66871000	130 D 12	6/14,1/20Pl.,3/20,1/10Pl.,4/14	H	13	100	950	950	194	R35	R35	A28	230
66768000	130 D 13	8/11	V	8	80	840	840	202	R25	R25	A32	88

MAGIRUS-TYPEN

IVECO

MAGIRUS-TYPEN

Artikel.Nr.	Fahrzeugtyp	Info	Achsl.	Blattzahl	Breite	Lx/L1	Ly/L2	Spr./ Kr.	Buchsen vorn	Buchsen hinten	Form	Paket- stärke
Art.-No.	Type		Axle Load	Leaves	Width			FreeArch /Crank	Bush front	Bush rear	Shape	Total height
66484000	130 D 13	7/10,2/22,1/16Pl.	V	9	80	785	945	190	25x32		B15	108
66752000	130 D 13	9/11	V	9	80	840	840	176	R25	R25	A32	99
66822000	130 D 13	10/11	V	10	80	840	840	167	R25	R25	A32	110
66791000	130 D 13	2/11,7/10,1/4Pl.,2/9,1/8	H	12	70	740	840	175	30x40		B7	130
66819000	130 D 13	8/13,1/P,3/13	H	11	100	900	900	165	R30	R30	A4	163
66807000	130 D 13	5/12,1/15Pl.,2/20,1/20Pl.,4/12,1/10	H	12	100	900	900	209	R30	R30	A28	193
66871000	130 D 13	6/14,1/20Pl.,3/20,1/10Pl.,4/14	H	13	100	950	950	194	R35	R35	A28	230
66570000	130 D 14	8/13	V	8	80	950	950	225	R25	R25	A32	110
66731000	130 D 14	5/14,1/10Pl.,2/20,1/20Pl.,3/14	H	10	100	950	950	199	R35	R35	A28	182
66807000	130 D 14	5/12,1/15Pl.,2/20,1/20Pl.,4/12,1/10	H	12	100	900	900	209	R30	R30	A28	193
66871000	130 D 14	6/14,1/20Pl.,3/20,1/10Pl.,4/14	H	13	100	950	950	194	R35	R35	A28	230
66752000	130 D 15	9/11	V	9	80	840	840	176	R25	R25	A32	99
66824000	130 D 15	9/11	V	9	80	840	840	175	R25	R25	A32	99
66822000	130 D 15	10/11	V	10	80	840	840	167	R25	R25	A32	110
66826000	130 D 15	14/10	V	14	80	840	840	175	R25	R25	A11	140
66813000	130 D 15	5/14,1/10Pl.,2/20,1/20Pl.,3/16	H	10	100	950	950	182	R35	R35	A28	188
66891000	130 D 15	6/14,1/10,3/20,1/10,4/16	H	13	100	950	950	172	R35	R35	A28	228
66911000	130 D 15	11/15,1/10Pl.,5/14	H	16	100	950	950	140	R35	R35	A4	245
66570000	130 D 16	8/13	V	8	80	950	950	225	R25	R25	A32	110
66526000	130 D 16	9/13	V	9	80	950	950	198	R25	R25	A32	117
66731000	130 D 16	5/14,1/10Pl.,2/20,1/20Pl.,3/14	H	10	100	950	950	199	R35	R35	A28	182
66813000	130 D 16	5/14,1/10Pl.,2/20,1/20Pl.,3/16	H	10	100	950	950	182	R35	R35	A28	188
66871000	130 D 16	6/14,1/20Pl.,3/20,1/10Pl.,4/14	H	13	100	950	950	194	R35	R35	A28	230
66940000	130 D 7 FAL	8/10	V	8	80	775	775	140	R25	R25	A32	80
66941000	130 D 7 FAL	8/10,1/20Pl.,5/8	H	13	80	775	775	150	R25	R25	A28	140
66496000	130 D 8	6/10,2/11	V	8	70	785	950	205	22x28		B15	82
66497000	130 D 8	3/10,3/11,3/15	H	9	70	700	880	195	25x32		B15	108
66820000	130 D 9 AL	7/11	V	7	80	840	840	204	R25	R25	A32	77
66819000	130 D 9 AL	8/13,1/P,3/13	H	11	100	900	900	165	R30	R30	A4	163
66529000	130 D 9 AL	10,1,4	H	14	100	900	900	137	R30	R30	A4	
66484000	130 D 9 FA	7/10,2/22,1/16Pl.	V	9	80	785	945	190	25x32		B15	108
66484000	130 D 9 FA	7/10,2/22,1/16Pl.	V	9	80	785	945	190	25x32		B15	108
66486000	130 D 9 FGB	4/8,6/7	V	10	60	645	645	176	24x34	24x34	A32	80
66496000	130 D 9 FGB	6/10,2/11	V	8	70	785	950	205	22x28		B15	82
66496000	130 D 9 FK	6/10,2/11	V	8	70	785	950	205	22x28		B15	82
66497000	130 D 9 FK	3/10,3/11,3/15	H	9	70	700	880	195	25x32		B15	108
66496000	130 D 9 FL	6/10,2/11	V	8	70	785	950	205	22x28		B15	82
66820000	130 D 9 FL	7/11	V	7	80	840	840	204	R25	R25	A32	77
66497000	130 D 9 FL	3/10,3/11,3/15	H	9	70	700	880	195	25x32		B15	108
66801000	130 D 9 FL	4/12,1/10Pl.,2/18,1/20Pl.,2/12	H	8	100	900	900	220	R30	R30	A28	138
66881000	130 D 9 FL	4/12,1/10Pl.,2/18,1/20Pl.,3/12,1/10,1/4Pl.	H	10	100	900	900	190	R30	R30	A28	164
66496000	130 M 11	6/10,2/11	V	8	70	785	950	205	22x28		B15	82
66494000	130 M 11	6/10,2/11,1/16Pl.	V	8	80	785	950	230	25x32		B15	98
66484000	130 M 11	7/10,2/22,1/16Pl.	V	9	80	785	945	190	25x32		B15	108
66619000	130 M 11		H	14	70	570	680	95	25x32		B14	
66949000	130 M 11	4/15,1/10,3/19	H	7	80	800	990	105	30x36		B14	127
66499000	130 M 11	4/11,3/12,3/16	H	10	80	800	990	215	30x36		B14	128
66489000	130 M 11	4/11,4/12,4/16	H	12	80	800	990	170	30x36		B15	156
66627000	130 M 11	15/9	H	15	80	570	680	100	30x36		B14	135
66484000	130 M 12	7/10,2/22,1/16Pl.	V	9	80	785	945	190	25x32		B15	108
66949000	130 M 12	4/15,1/10,3/19	H	7	80	800	990	105	30x36		B14	127
66484000	130 M 13	7/10,2/22,1/16Pl.	V	9	80	785	945	190	25x32		B15	108
66752000	130 M 13	9/11	V	9	80	840	840	176	R25	R25	A32	99
66949000	130 M 13	4/15,1/10,3/19	H	7	80	800	990	105	30x36		B14	127
66489000	130 M 13	4/11,4/12,4/16	H	12	80	800	990	170	30x36		B15	156

MAGIRUS-TYPEN

IVECO

MAGIRUS-TYPEN

Artikel.Nr.	Fahrzeugtyp	Info	Achsl.	Blattzahl	Breite	Lx/L1	Ly/L2	Spr./Kr.	Buchsen vorn	Buchsen hinten	Form	Paketstärke
Art.-No.	Type		Axle Load	Leaves	Width			FreeArch/Crank	Bush front	Bush rear	Shape	Total height
67206000	130 M 14 FL	2/10,7/13	V	9	70	800	800	94	28x35	28x35	E3	111
67209000	130 M 14 FL	2/11,4/15,1/8,9/11	H	15	80	800	800	155	28x35	28x35	A28	189
66496000	130 M 7	6/10,2/11	V	8	70	785	950	205	22x28		B15	82
66940000	130 M 7	8/10	V	8	80	775	775	140	R25	R25	A32	80
66497000	130 M 7	3/10,3/11,3/15	H	9	70	700	880	195	25x32		B15	108
66941000	130 M 7	8/10,1/20Pl.,5/8	H	13	80	775	775	150	R25	R25	A28	140
66496000	130 M 8	6/10,2/11	V	8	70	785	950	205	22x28		B15	82
66470000	130 M 8	2/10,2/11,3/10,3/11	V	10	70	785	945	128	22x28		B15	105
66940000	130 M 8	8/10	V	8	80	775	775	140	R25	R25	A32	80
66484000	130 M 8	7/10,2/22,1/16Pl.	V	9	80	785	945	190	25x32		B15	108
66497000	130 M 8	3/10,3/11,3/15	H	9	70	700	880	195	25x32		B15	108
66489000	130 M 8	4/11,4/12,4/16	H	12	80	800	990	170	30x36		B15	156
66496000	130 M 9	6/10,2/11	V	8	70	785	950	205	22x28		B15	82
66470000	130 M 9	2/10,2/11,3/10,3/11	V	10	70	785	945	128	22x28		B15	105
66484000	130 M 9	7/10,2/22,1/16Pl.	V	9	80	785	945	190	25x32		B15	108
66497000	130 M 9	3/10,3/11,3/15	H	9	70	700	880	195	25x32		B15	108
66467000	130 M 9	4/10,4/11,3/15	H	11	70	700	880	140	25x36		B15	129
66956000	130 R 81	3/18,Bus	V	3	70	775	775	138	R25	R25	A1	62
66955000	130 R 81	4/18,Bus	H	4	80	825	825	124	R25	R25	A1	84
66752000	135 D 15 AK	9/11	V	9	80	840	840	176	R25	R25	A32	99
66813000	135 D 15 AK	5/14,1/10Pl.,2/20,1/20Pl.,3/16	H	10	100	950	950	182	R35	R35	A28	188
66690000	156 D 22 6X4	11/11	V	11	80	875	1050	270	25x30		B15	121
66699000	156 D 22 6X4	7/16,Rippe	H	7	90	720	720	80			D1.1	112
66494000	160 D 11 FL	6/10,2/11,1/16Pl.	V	8	80	785	950	230	25x32		B15	98
66499000	160 D 11 FL	4/11,3/12,3/16	H	10	80	800	990	215	30x36		B14	128
66819000	160 D 12 AK	8/13,1/P,3/13	H	11	100	900	900	165	R30	R30	A4	163
66807000	160 D 12 AK	5/12,1/15Pl.,2/20,1/20Pl.,4/12,1/10	H	12	100	900	900	209	R30	R30	A28	193
66526000	160 D 12 FL	9/13	V	9	80	950	950	198	R25	R25	A32	117
66731000	160 D 12 FL	5/14,1/10Pl.,2/20,1/20Pl.,3/14	H	10	100	950	950	199	R35	R35	A28	182
66819000	160 D 12 K	8/13,1/P,3/13	H	11	100	900	900	165	R30	R30	A4	163
66807000	160 D 12 K	5/12,1/15Pl.,2/20,1/20Pl.,4/12,1/10	H	12	100	900	900	209	R30	R30	A28	193
66820000	160 D 12 K/AK	7/11	V	7	80	840	840	204	R25	R25	A32	77
66484000	160 D 13 FK	7/10,2/22,1/16Pl.	V	9	80	785	945	190	25x32		B15	108
66489000	160 D 13 FK	4/11,4/12,4/16	H	12	80	800	990	170	30x36		B15	156
66484000	160 D 13 FL	7/10,2/22,1/16Pl.	V	9	80	785	945	190	25x32		B15	108
66949000	160 D 13 FL	4/15,1/10,3/19	H	7	80	800	990	105	30x36		B14	127
66489000	160 D 13 FL	4/11,4/12,4/16	H	12	80	800	990	170	30x36		B15	156
66752000	160 D 13 L	9/11	V	9	80	840	840	176	R25	R25	A32	99
66819000	160 D 13 L	8/13,1/P,3/13	H	11	100	900	900	165	R30	R30	A4	163
66824000	160 D 15 AK	9/11	V	9	80	840	840	175	R25	R25	A32	99
66822000	160 D 15 AK	10/11	V	10	80	840	840	167	R25	R25	A32	110
66826000	160 D 15 AK	14/10	V	14	80	840	840	175	R25	R25	A11	140
66813000	160 D 15 AK	5/14,1/10Pl.,2/20,1/20Pl.,3/16	H	10	100	950	950	182	R35	R35	A28	188
66891000	160 D 15 AK	6/14,1/10,3/20,1/10,4/16	H	13	100	950	950	172	R35	R35	A28	228
66752000	160 D 15 K	9/11	V	9	80	840	840	176	R25	R25	A32	99
66824000	160 D 15 K	9/11	V	9	80	840	840	175	R25	R25	A32	99
66822000	160 D 15 K	10/11	V	10	80	840	840	167	R25	R25	A32	110
66813000	160 D 15 K	5/14,1/10Pl.,2/20,1/20Pl.,3/16	H	10	100	950	950	182	R35	R35	A28	188
66819000	160 D 15 K	8/13,1/P,3/13	H	11	100	900	900	165	R30	R30	A4	163
66570000	160 D 16 FL	8/13	V	8	80	950	950	225	R25	R25	A32	110
66526000	160 D 16 FL	9/13	V	9	80	950	950	198	R25	R25	A32	117
66731000	160 D 16 FL	5/14,1/10Pl.,2/20,1/20Pl.,3/14	H	10	100	950	950	199	R35	R35	A28	182
66813000	160 D 16 FL	5/14,1/10Pl.,2/20,1/20Pl.,3/16	H	10	100	950	950	182	R35	R35	A28	188
66824000	160 D 19 AK	9/11	V	9	80	840	840	175	R25	R25	A32	99
66813000	160 D 19 AK	5/14,1/10Pl.,2/20,1/20Pl.,3/16	H	10	100	950	950	182	R35	R35	A28	188
66494000	160 M 11 F	6/10,2/11,1/16Pl.	V	8	80	785	950	230	25x32		B15	98

MAGIRUS-TYPEN

IVECO

MAGIRUS-TYPEN

Artikel.Nr.	Fahrzeugtyp	Info	Achsl.	Blattzahl	Breite	Lx/L1	Ly/L2	Spr./ Kr.	Buchsen vorn	Buchsen hinten	Form	Paket- stärke
Art.-No.	Type		Axle Load	Leaves	Width			FreeArch/ Crank	Bush front	Bush rear	Shape	Total height
66484000	160 M 11 F	7/10,2/22,1/16Pl.	V	9	80	785	945	190	25x32		B15	108
66949000	160 M 11 F	4/15,1/10,3/19	H	7	80	800	990	105	30x36		B14	127
66499000	160 M 11 F	4/11,3/12,3/16	H	10	80	800	990	215	30x36		B14	128
66489000	160 M 11 F	4/11,4/12,4/16	H	12	80	800	990	170	30x36		B15	156
66494000	160 M 13 F	6/10,2/11,1/16Pl.	V	8	80	785	950	230	25x32		B15	98
66484000	160 M 13 F	7/10,2/22,1/16Pl.	V	9	80	785	945	190	25x32		B15	108
66949000	160 M 13 F	4/15,1/10,3/19	H	7	80	800	990	105	30x36		B14	127
66499000	160 M 13 F	4/11,3/12,3/16	H	10	80	800	990	215	30x36		B14	128
66489000	160 M 13 F	4/11,4/12,4/16	H	12	80	800	990	170	30x36		B15	156
66940000	160 M 8 FAL	8/10	V	8	80	775	775	140	R25	R25	A32	80
66496000	160 M 8 FL	6/10,2/11	V	8	70	785	950	205	22x28		B15	82
66497000	160 M 8 FL	3/10,3/11,3/15	H	9	70	700	880	195	25x32		B15	108
66941000	160 M 8 FL	8/10,1/20Pl.,5/8	H	13	80	775	775	150	R25	R25	A28	140
66484000	168 M 13 FS	7/10,2/22,1/16Pl.	V	9	80	785	945	190	25x32		B15	108
66949000	168 M 13 FS	4/15,1/10,3/19	H	7	80	800	990	105	30x36		B14	127
66949000	168 M 14 FL	4/15,1/10,3/19	H	7	80	800	990	105	30x36		B14	127
67206000	168 M 14FL	2/10,7/13	V	9	70	800	800	94	28x35	28x35	E3	111
67218000	168 M 14FL	2/11,8/13	V	10	70	800	800	125	34x42	34x42	E3	126
67209000	168 M 14FL	2/11,4/15,1/8,9/11	H	15	80	800	800	155	28x35	28x35	A28	189
67206000	168 M 16FL	2/10,7/13	V	9	70	800	800	94	28x35	28x35	E3	111
67218000	168 M 16FL	2/11,8/13	V	10	70	800	800	125	34x42	34x42	E3	126
67209000	168 M 16FL	2/11,4/15,1/8,9/11	H	15	80	800	800	155	28x35	28x35	A28	189
66820000	170 D 11 F	7/11	V	7	80	840	840	204	R25	R25	A32	77
66881000	170 D 11 F	4/12,1/10Pl.,2/18,1/20Pl.,3/12,1/10,1/4Pl.	H	10	100	900	900	190	R30	R30	A28	164
66780000	170 D 11 FA	7/15	V	7	80	950	950	142	R25	R25	A32	105
66807000	170 D 11 FA	5/12,1/15Pl.,2/20,1/20Pl.,4/12,1/10	H	12	100	900	900	209	R30	R30	A28	193
66820000	170 D 11 FL	7/11	V	7	80	840	840	204	R25	R25	A32	77
66707000	170 D 11 FL	5/12,1/14Pl,2/20,1/20Pl.,3/12,1/10	H	11	100	900	900	200	R30	R30	A28	180
66588000	170 D 12	7/10	V	7	80	760	760	146	R30	R30	A32	70
66752000	170 D 12	9/11	V	9	80	840	840	176	R25	R25	A32	99
66707000	170 D 12	5/12,1/14Pl,2/20,1/20Pl.,3/12,1/10	H	11	100	900	900	200	R30	R30	A28	180
66819000	170 D 12	8/13,1/P,3/13	H	11	100	900	900	165	R30	R30	A4	163
66807000	170 D 12	5/12,1/15Pl.,2/20,1/20Pl.,4/12,1/10	H	12	100	900	900	209	R30	R30	A28	193
66820000	170 D 13	7/11	V	7	80	840	840	204	R25	R25	A32	77
66813000	170 D 13	5/14,1/10Pl.,2/20,1/20Pl.,3/16	H	10	100	950	950	182	R35	R35	A28	188
66707000	170 D 13	5/12,1/14Pl,2/20,1/20Pl.,3/12,1/10	H	11	100	900	900	200	R30	R30	A28	180
66807000	170 D 13	5/12,1/15Pl.,2/20,1/20Pl.,4/12,1/10	H	12	100	900	900	209	R30	R30	A28	193
66570000	170 D 14	8/13	V	8	80	950	950	225	R25	R25	A32	110
66522000	170 D 14	9/12	V	9	80	950	950	236	R25	R25	A32	108
66901000	170 D 14	8/13,1/10Pl.,5/11	H	11	100	950	720	150	R35	R35	A28	169
66807000	170 D 14	5/12,1/15Pl.,2/20,1/20Pl.,4/12,1/10	H	12	100	900	900	209	R30	R30	A28	193
66891000	170 D 14	6/14,1/10,3/20,1/10,4/16	H	13	100	950	950	172	R35	R35	A28	228
66779000	170 D 14	13/9,2/15	H	15	100	580	850	103	R35	R35	A43	147
66752000	170 D 15 AK	9/11	V	9	80	840	840	176	R25	R25	A32	99
66824000	170 D 15 AK	9/11	V	9	80	840	840	175	R25	R25	A32	99
66822000	170 D 15 AK	10/11	V	10	80	840	840	167	R25	R25	A32	110
66826000	170 D 15 AK	14/10	V	14	80	840	840	175	R25	R25	A11	140
66731000	170 D 15 AK	5/14,1/10Pl.,2/20,1/20Pl.,3/14	H	10	100	950	950	199	R35	R35	A28	182
66813000	170 D 15 AK	5/14,1/10Pl.,2/20,1/20Pl.,3/16	H	10	100	950	950	182	R35	R35	A28	188
66891000	170 D 15 AK	6/14,1/10,3/20,1/10,4/16	H	13	100	950	950	172	R35	R35	A28	228
66911000	170 D 15 AK	11/15,1/10Pl.,5/14	H	16	100	950	950	140	R35	R35	A4	245
66522000	170 D 15 F	9/12	V	9	80	950	950	236	R25	R25	A32	108
66374000	170 D 15 FAK	9/14	V	6,5	9	80	950	153	R25	R25	A32	126

MAGIRUS-TYPEN
IVECO
MAGIRUS-TYPEN

Artikel.Nr.	Fahrzeugtyp	Info	Achsl.	Blattzahl	Breite	Lx/L1	Ly/L2	Spr./Kr.	Buchsen vorn	Buchsen hinten	Form	Paketstärke	
Art.-No.	Type		Axle Load	Leaves	Width			FreeArch/Crank	Bush front	Bush rear	Shape	Total height	
66522000	170 D 15 FAK	9/12	V		9	80	950	950	236	R25	R25	A32	108
66572000	170 D 15 FAK	10/15	V		10	80	900	1000	100	R25	R25	A11	150
66731000	170 D 15 FAK	5/14,1/10Pl.,2/20,1/20Pl.,3/14	H		10	100	950	950	199	R35	R35	A28	182
66813000	170 D 15 FAK	5/14,1/10Pl.,2/20,1/20Pl.,3/16	H		10	100	950	950	182	R35	R35	A28	188
66819000	170 D 15 FAK	8/13,1/P,3/13	H		11	100	900	900	165	R30	R30	A4	163
66891000	170 D 15 FAK	6/14,1/10,3/20,1/10,4/16	H		13	100	950	950	172	R35	R35	A28	228
66522000	170 D 15 FK	9/12	V		9	80	950	950	236	R25	R25	A32	108
66526000	170 D 15 FK	9/13	V		9	80	950	950	198	R25	R25	A32	117
66731000	170 D 15 FK	5/14,1/10Pl.,2/20,1/20Pl.,3/14	H		10	100	950	950	199	R35	R35	A28	182
66813000	170 D 15 FK	5/14,1/10Pl.,2/20,1/20Pl.,3/16	H		10	100	950	950	182	R35	R35	A28	188
66891000	170 D 15 FK	6/14,1/10,3/20,1/10,4/16	H		13	100	950	950	172	R35	R35	A28	228
66522000	170 D 15 FL	9/12	V		9	80	950	950	236	R25	R25	A32	108
66731000	170 D 15 FL	5/14,1/10Pl.,2/20,1/20Pl.,3/14	H		10	100	950	950	199	R35	R35	A28	182
66813000	170 D 15 FL	5/14,1/10Pl.,2/20,1/20Pl.,3/16	H		10	100	950	950	182	R35	R35	A28	188
66689000	170 D 15 FL	8/14,6/11	H	13,0	14	100	950	725	165	R35	R35	A28	178
66752000	170 D 15 K	9/11	V		9	80	840	840	176	R25	R25	A32	99
66826000	170 D 15 K	14/10	V		14	80	840	840	175	R25	R25	A11	140
66731000	170 D 15 K	5/14,1/10Pl.,2/20,1/20Pl.,3/14	H		10	100	950	950	199	R35	R35	A28	182
66813000	170 D 15 K	5/14,1/10Pl.,2/20,1/20Pl.,3/16	H		10	100	950	950	182	R35	R35	A28	188
66891000	170 D 15 K	6/14,1/10,3/20,1/10,4/16	H		13	100	950	950	172	R35	R35	A28	228
66911000	170 D 15 K	11/15,1/10Pl.,5/14	H		16	100	950	950	140	R35	R35	A4	245
66762000	170 D 16 F	8/13	V		8	80	950	950	190	R25	R25	A32	104
66526000	170 D 16 F	9/13	V		9	80	950	950	198	R25	R25	A32	117
66731000	170 D 16 F	5/14,1/10Pl.,2/20,1/20Pl.,3/14	H		10	100	950	950	199	R35	R35	A28	182
66813000	170 D 16 F	5/14,1/10Pl.,2/20,1/20Pl.,3/16	H		10	100	950	950	182	R35	R35	A28	188
66891000	170 D 16 F	6/14,1/10,3/20,1/10,4/16	H		13	100	950	950	172	R35	R35	A28	228
66752000	170 D 17 AK	9/11	V		9	80	840	840	176	R25	R25	A32	99
66824000	170 D 17 AK	9/11	V		9	80	840	840	175	R25	R25	A32	99
66826000	170 D 17 AK	14/10	V		14	80	840	840	175	R25	R25	A11	140
66813000	170 D 17 AK	5/14,1/10Pl.,2/20,1/20Pl.,3/16	H		10	100	950	950	182	R35	R35	A28	188
66911000	170 D 17 AK	11/15,1/10Pl.,5/14	H		16	100	950	950	140	R35	R35	A4	245
66762000	170 D 17 F	8/13	V		8	80	950	950	190	R25	R25	A32	104
66374000	170 D 17 F	9/14	V	6,5	9	80	950	950	153	R25	R25	A32	126
66522000	170 D 17 F	9/12	V		9	80	950	950	236	R25	R25	A32	108
66901000	170 D 17 F	8/13,1/10Pl.,5/11	H		11	100	950	720	150	R35	R35	A28	169
66891000	170 D 17 F	6/14,1/10,3/20,1/10,4/16	H		13	100	950	950	172	R35	R35	A28	228
66689000	170 D 17 F	8/14,6/11	H	13,0	14	100	950	725	165	R35	R35	A28	178
66762000	170 D 17 FAK	8/13	V		8	80	950	950	190	R25	R25	A32	104
66762000	170 D 17 FK	8/13	V		8	80	950	950	190	R25	R25	A32	104
66813000	170 D 17 FK	5/14,1/10Pl.,2/20,1/20Pl.,3/16	H		10	100	950	950	182	R35	R35	A28	188
66891000	170 D 17 FK	6/14,1/10,3/20,1/10,4/16	H		13	100	950	950	172	R35	R35	A28	228
66522000	170 D 17 FL	9/12	V		9	80	950	950	236	R25	R25	A32	108
66731000	170 D 17 FL	5/14,1/10Pl.,2/20,1/20Pl.,3/14	H		10	100	950	950	199	R35	R35	A28	182
66707000	170 D 17 FL	5/12,1/14Pl,2/20,1/20Pl.,3/12,1/10	H		11	100	900	900	200	R30	R30	A28	180
66901000	170 D 17 FL	8/13,1/10Pl.,5/11	H		11	100	950	720	150	R35	R35	A28	169
66752000	170 D 17 K	9/11	V		9	80	840	840	176	R25	R25	A32	99
66826000	170 D 17 K	14/10	V		14	80	840	840	175	R25	R25	A11	140
66891000	170 D 17 K	6/14,1/10,3/20,1/10,4/16	H		13	100	950	950	172	R35	R35	A28	228
66911000	170 D 17 K	11/15,1/10Pl.,5/14	H		16	100	950	950	140	R35	R35	A4	245
66374000	170 D 19 F	9/14	V	6,5	9	80	950	950	153	R25	R25	A32	126
66522000	170 D 19 F	9/12	V		9	80	950	950	236	R25	R25	A32	108
66526000	170 D 19 F	9/13	V		9	80	950	950	198	R25	R25	A32	117
66901000	170 D 19 F	8/13,1/10Pl.,5/11	H		11	100	950	720	150	R35	R35	A28	169
66689000	170 D 19 F	8/14,6/11	H	13,0	14	100	950	725	165	R35	R35	A28	178
66762000	170 D 19 FK	8/13	V		8	80	950	950	190	R25	R25	A32	104
66526000	170 D 19 FK	9/13	V		9	80	950	950	198	R25	R25	A32	117

MAGIRUS-TYPEN

IVECO

MAGIRUS-TYPEN

Artikel.Nr.	Fahrzeugtyp	Info	Achsl.	Blattzahl	Breite	Lx/L1	Ly/L2	Spr./ Kr.	Buchsen vorn	Buchsen hinten	Form	Paket- stärke
Art.-No.	Type		Axle Load	Leaves	Width			FreeArch /Crank	Bush front	Bush rear	Shape	Total height
66891000	170 D 19 FK	6/14,1/10,3/20,1/10,4/16	H	13	100	950	950	172	R35	R35	A28	228
66762000	170 D 19 FL	8/13	V	8	80	950	950	190	R25	R25	A32	104
66522000	170 D 19 FL	9/12	V	9	80	950	950	236	R25	R25	A32	108
66526000	170 D 19 FL	9/13	V	9	80	950	950	198	R25	R25	A32	117
66731000	170 D 19 FL	5/14,1/10Pl.,2/20,1/20Pl.,3/14	H	10	100	950	950	199	R35	R35	A28	182
66891000	170 D 19 FL	6/14,1/10,3/20,1/10,4/16	H	13	100	950	950	172	R35	R35	A28	228
66689000	170 D 19 FL	8/14,6/11	H	14	100	950	725	165	R35	R35	A28	178
66910000	170 D 19 L	4/22	V	4	80	760	760	113	28	28	A20	100
66762000	170 D 19 L	8/13	V	8	80	950	950	190	R25	R25	A32	104
66526000	170 D 19 L	9/13	V	9	80	950	950	198	R25	R25	A32	117
66572000	170 D 19 L	10/15	V	10	80	900	1000	100	R25	R25	A11	150
66762000	170 D 21 AK	8/13	V	8	80	950	950	190	R25	R25	A32	104
66752000	170 D 21 AK	9/11	V	9	80	840	840	176	R25	R25	A32	99
66826000	170 D 21 AK	14/10	V	14	80	840	840	175	R25	R25	A11	140
66695000	170 D 21 AK	7/20,Rippe	H	7	90	720	720	64			D1.1	140
66647000	170 D 21 AK	7/20,1/10Halter	H	7	100	770	770	73			D20	150
66649000	170 D 21 AK	9/20,1/10Halter	H	9	100	780	780	46			D20	190
66569000	170 D 21 AK	10/20,1/10Halter	H	10	100	780	780	50			D20	210
66809000	170 D 21 AK	15/17,1/10Pl.	H	15	100	780	780	49			D21	265
66820000	170 D 24	7/11	V	7	80	840	840	204	R25	R25	A32	77
66374000	170 D 24	9/14	V	9	80	950	950	153	R25	R25	A32	126
66569000	170 D 24	10/20,1/10Halter	H	10	100	780	780	50			D20	210
66777000	170 D 24	8/13,1/10Pl.,3/13	H	11	100	900	900	165	R30	R30	A28	163
66819000	170 D 24	8/13,1/P,3/13	H	11	100	900	900	165	R30	R30	A4	163
66768000	170 M 14 FS	8/11	V	8	80	840	840	202	R25	R25	A32	88
66779000	170 M 14 FS	13/9,2/15	H	15	100	580	850	103	R35	R35	A43	147
66374000	190 PAC 20	9/14	V	9	80	950	950	153	R25	R25	A32	126
66790000	190 PAC 20	14/13	V	14	80	950	950	100	R25	R25	A32	182
66891000	190 PAC 20	6/14,1/10,3/20,1/10,4/16	H	13	100	950	950	172	R35	R35	A28	228
66911000	190 PAC 20	11/15,1/10Pl.,5/14	H	16	100	950	950	140	R35	R35	A4	245
66374000	190 PAC 26	9/14	V	9	80	950	950	153	R25	R25	A32	126
66572000	190 PAC 26	10/15	V	10	80	900	1000	100	R25	R25	A11	150
66662000	190 PAC 26	10/15	V	10	80	900	1000	147	R25		A11	150
66790000	190 PAC 26	14/13	V	14	80	950	950	100	R25	R25	A32	182
66927000	190 PAC 26	5/14,1/10Pl.,2/20,1/10Pl.,5/14	H	12	100	950	950	172	R35	R35	A28	210
66891000	190 PAC 26	6/14,1/10,3/20,1/10,4/16	H	13	100	950	950	172	R35	R35	A28	228
66911000	190 PAC 26	11/15,1/10Pl.,5/14	H	16	100	950	950	140	R35	R35	A4	245
66572000	190 PC 26	10/15	V	10	80	900	1000	100	R25	R25	A11	150
66662000	190 PC 26	10/15	V	10	80	900	1000	147	R25		A11	150
66800000	190 PC 26	10/15	V	10	80	950	950	102	R25	R25	A11	150
66790000	190 PC 26	14/13	V	14	80	950	950	100	R25	R25	A32	182
66911000	190 PC26	11/15,1/10Pl.,5/14	H	16	100	950	950	140	R35	R35	A4	245
66800000	190 PT 26	10/15	V	10	80	950	950	102	R25	R25	A11	150
66824000	192 D 11 AL	9/11	V	9	80	840	840	175	R25	R25	A32	99
66529000	192 D 11 AL	10,1,4	H	14	100	900	900	137	R30	R30	A4	
66832000	192 D 11 F	8/11	V	8	80	840	840	156	R25	R25	A11	88
66949000	192 D 11 F	4/15,1/10,3/19	H	7	80	800	990	105	30x36		B14	127
66484000	192 D 11 FA	7/10,2/22,1/16Pl.	V	9	80	785	945	190	25x32		B15	108
66949000	192 D 11 FA	4/15,1/10,3/19	H	7	80	800	990	105	30x36		B14	127
67206000	192 M 14 FL	2/10,7/13	V	9	70	800	800	94	28x35	28x35	E3	111
67218000	192 M 14 FL	2/11,8/13	V	10	70	800	800	125	34x42	34x42	E3	126
66732000	192 M 14 FS	2/11,5/14	V	7	70	800	800	90	28x35	28x35	E3	92
67204000	192 M 14 FS	2/19,2/12,3/14,1/10Pl.	V	7	70	800	800	99	28x35	28x35	E2	96
66374000	192 M 16 AK	9/14	V	9	80	950	950	153	R25	R25	A32	126
66704000	192 M 16 AK	9/14	V	9	80	950	950	123	R25	R25	A11	126
66800000	192 M 16 AK	10/15	V	10	80	950	950	102	R25	R25	A11	150
66813000	192 M 16 AK	5/14,1/10Pl.,2/20,1/20Pl.,3/16	H	10	100	950	950	182	R35	R35	A28	188

MAGIRUS-TYPEN

IVECO

MAGIRUS-TYPEN

Artikel.Nr.	Fahrzeugtyp	Info	Achsl.	Blattzahl	Breite	Lx/L1	Ly/L2	Spr./Kr.	Buchsen vorn	Buchsen hinten	Form	Paketstärke	
Art.-No.	Type		Axle Load	Leaves	Width			FreeArch/Crank	Bush front	Bush rear	Shape	Total height	
66927000	192 M 16 AK	5/14,1/10Pl.,2/20,1/10Pl.,5/14	H	12	100	950	950	172	R35	R35	A28	210	
67209000	192 M14 FL	2/11,4/15,1/8,9/11	H	15	80	800	800	155	28x35	28x35	A28	189	
67209000	192 M14 FS	2/11,4/15,1/8,9/11	H	15	80	800	800	155	28x35	28x35	A28	189	
67218000	192 M16 FL	2/11,8/13	V	10	70	800	800	125	34x42	34x42	E3	126	
67209000	192 M16 FL	2/11,4/15,1/8,9/11	H	15	80	800	800	155	28x35	28x35	A28	189	
67218000	192 M16 FS	2/11,8/13	V	10	70	800	800	125	34x42	34x42	E3	126	
67209000	192 M16 FS	2/11,4/15,1/8,9/11	H	15	80	800	800	155	28x35	28x35	A28	189	
66484000	200 A 13 FS	7/10,2/22,1/16Pl.	V	9	80	785	945	190	25x32		B15	108	
66667000	200 A 13 FS	8/16,1/10Pl.	H	8	80	800	990	75	30		B14	138	
66676000	200 D 16 AK	2/11/12/10	V	14	80	830	920	200	25x30		B1.11	142	
66601000	200 D 16 AK	13/12,2/5,7/9	H	20	100	805	950	109	30x36		B7	229	
66768000	210 D 14 FS	8/11	V	8	80	840	840	202	Rx25	R25	A32	88	
66779000	210 D 14 FS	13/9,2/15	H	15	100	580	850	103	Rx35	R35	A43	147	
66762000	210 D 16 AK	8/13	V	8	80	950	950	190	Rx25	R25	A32	104	
66374000	210 D 16 AK	9/14	V	9	80	950	950	153	Rx25	R25	A32	126	
66891000	210 D 16 AK	6/14,1/10,3/20,1/10,4/16	H	13	100	950	950	172	Rx35	R35	A28	228	
66672000	210 D 22	10/12	V	10	80	830	1000	133	25x30		B1.11	120	
66690000	210 D 22	11/11	V	11	80	875	1050	270	25x30		B15	121	
66695000	210 D 22	7/20,Rippe	H	7	90	720	720	64			D1.1	140	
66699000	210 D 22	7/16,Rippe	H	7	90	720	720	80			D1.1	112	
66477000	210 D 22	12/16	H	12	90	720	720	50			D1.1	192	
66672000	210 D 26 AK	10/12	V	10	80	830	1000	133	25x30		B1.11	120	
66693000	210 D 26 AK	10/20	H	10	90	760	760	60			D1.1	200	
66676000	230 D 16 AK	2/11/12/10	V	14	80	830	920	200	25x30		B1.11	142	
66601000	230 D 16 AK	13/12,2/5,7/9	H	20	100	805	950	109	30x36		B7	229	
66690000	230 D 16 FL	11/11	V	11	80	875	1050	270	25x30		B15	121	
66759000	230 D 16 FL	13/13	H	13	100	900	1070	132	30		B15	177	
66762000	230 D 16 FS	8/13	V	8	80	950	950	190	Rx25	R25	A32	104	
66711000	230 D 16 FS	3/12,5/11,1/10Pl.,3/18	H	11	100	900	900	212	30x36	R40	A5	163	
66672000	230 D 22 AK	10/12	V	10	80	830	1000	133	25x30		B1.11	120	
66695000	230 D 22 AK	7/20,Rippe	H	7	90	720	720	64			D1.1	140	
66693000	230 D 22 AK	10/20	H	10	90	760	760	60			D1.1	200	
66690000	230 D 22 FB	11/11	V	11	80	875	1050	270	25x30		B15	121	
66699000	230 D 22 FB	7/16,Rippe	H	7	90	720	720	80			D1.1	112	
66672000	230 D 26	10/12	V	10	80	830	1000	133	25x30		B1.11	120	
66693000	230 D 26	10/20	H	10	90	760	760	60			D1.1	200	
66676000	230 D 26 K	2/11/12/10	V	14	80	830	920	200	25x30		B1.11	142	
66747000	230 D 26 K	17/17,Rippe	H	17	90	730	770	80			D1.1	289	
66762000	232 D 15 AK	8/13	V	8	80	950	950	190	Rx25	R25	A32	104	
66813000	232 D 15 AK	5/14,1/10Pl.,2/20,1/20Pl.,3/16	H	10	100	950	950	182	Rx35	R35	A28	188	
66891000	232 D 15 AK	6/14,1/10,3/20,1/10,4/16	H	13	100	950	950	172	Rx35	R35	A28	228	
66522000	232 D 15 F	9/12	V	9	80	950	950	236	Rx25	R25	A32	108	
66731000	232 D 15 F	5/14,1/10Pl.,2/20,1/20Pl.,3/14	H	10	100	950	950	199	Rx35	R35	A28	182	
66762000	232 D 15 FA	8/13	V	8	80	950	950	190	Rx25	R25	A32	104	
66374000	232 D 15 FA	9/14	V	9	80	950	950	153	Rx25	R25	A32	126	
66813000	232 D 15 FA	5/14,1/10Pl.,2/20,1/20Pl.,3/16	H	10	100	950	950	182	Rx35	R35	A28	188	
66762000	232 D 15 FAK	8/13	V	8	80	950	950	190	Rx25	R25	A32	104	
66374000	232 D 15 FAK	9/14	V	9	80	950	950	153	Rx25	R25	A32	126	
66572000	232 D 15 FAK	10/15	V	10	80	900	1000	100	Rx25	R25	A11	150	
66813000	232 D 15 FAK	5/14,1/10Pl.,2/20,1/20Pl.,3/16	H	10	100	950	950	182	Rx35	R35	A28	188	
66891000	232 D 15 FAK	6/14,1/10,3/20,1/10,4/16	H	13	100	950	950	172	Rx35	R35	A28	228	
66522000	232 D 15 FK	9/12	V	9	80	950	950	236	Rx25	R25	A32	108	
66526000	232 D 15 FK	9/13	V	9	80	950	950	198	Rx25	R25	A32	117	
66800000	232 D 15 FK	10/15	V	10	80	950	950	102	Rx25	R25	A11	150	
66813000	232 D 15 FK	5/14,1/10Pl.,2/20,1/20Pl.,3/16	H	10	100	950	950	182	Rx35	R35	A28	188	
66891000	232 D 15 FK	6/14,1/10,3/20,1/10,4/16	H	13	100	950	950	172	Rx35	R35	A28	228	
66689000	232 D 15 FK	8/14,6/11	H	13,0	14	100	950	725	165	Rx35	R35	A28	178

MAGIRUS-TYPEN

IVECO

MAGIRUS-TYPEN

Artikel.Nr.	Fahrzeugtyp	Info	Achsl.	Blattzahl	Breite	Lx/L1	Ly/L2	Spr./ Kr.	Buchsen vorn	Buchsen hinten	Form	Paket- stärke
Art.-No.	Type		Axle Load	Leaves	Width			FreeArch /Crank	Bush front	Bush rear	Shape	Total height
66780000	232 D 15 FL	7/15	V	7	80	950	950	142	Rx25	R25	A32	105
66570000	232 D 15 FL	8/13	V	8	80	950	950	225	Rx25	R25	A32	110
66762000	232 D 15 FL	8/13	V	8	80	950	950	190	Rx25	R25	A32	104
66522000	232 D 15 FL	9/12	V	9	80	950	950	236	Rx25	R25	A32	108
66526000	232 D 15 FL	9/13	V	9	80	950	950	198	Rx25	R25	A32	117
66589000	232 D 15 FL	5/16,1/10Pl.,2/22	H	7	100	950	950	152	Rx35	R35	A5	134
66731000	232 D 15 FL	5/14,1/10Pl.,2/20,1/20Pl.,3/14	H	10	100	950	950	199	Rx35	R35	A28	182
66813000	232 D 15 FL	5/14,1/10Pl.,2/20,1/20Pl.,3/16	H	10	100	950	950	182	Rx35	R35	A28	188
66587000	232 D 15 FL	7/12,1/10Pl.,4/16	H	11	100	950	950	250	Rx35	R35	A5	166
66707000	232 D 15 FL	5/12,1/14Pl,2/20,1/20Pl.,3/12,1/10	H	11	100	900	900	200	Rx30	R30	A28	180
66871000	232 D 15 FL	6/14,1/20Pl.,3/20,1/10Pl.,4/14	H	13	100	950	950	194	Rx35	R35	A28	230
66570000	232 D 15 FS	8/13	V	8	80	950	950	225	Rx25	R25	A32	110
66522000	232 D 15 FS	9/12	V	9	80	950	950	236	Rx25	R25	A32	108
66589000	232 D 15 FS	5/16,1/10Pl.,2/22	H	7	100	950	950	152	Rx35	R35	A5	134
66815000	232 D 15 FS	7/16,1/10Pl.,3/20	H	10	100	950	950	155	Rx35	R35	A5	182
66587000	232 D 15 FS	7/12,1/10Pl.,4/16	H	11	100	950	950	250	Rx35	R35	A5	166
66557000	232 D 15 FS	9/12,1/10Pl.,2/18,3/16	H	14	100	950	950	208	Rx35	R35	A5	216
66813000	232 D 15 K	5/14,1/10Pl.,2/20,1/20Pl.,3/16	H	10	100	950	950	182	Rx35	R35	A28	188
66374000	232 D 16 AK	9/14	V	9	80	950	950	153	Rx25	R25	A32	126
66526000	232 D 16 AK	9/13	V	9	80	950	950	198	Rx25	R25	A32	117
66800000	232 D 16 AK	10/15	V	10	80	950	950	102	Rx25	R25	A11	150
66813000	232 D 16 AK	5/14,1/10Pl.,2/20,1/20Pl.,3/16	H	10	100	950	950	182	Rx35	R35	A28	188
66871000	232 D 16 AK	6/14,1/20Pl.,3/20,1/10Pl.,4/14	H	13	100	950	950	194	Rx35	R35	A28	230
66891000	232 D 16 AK	6/14,1/10,3/20,1/10,4/16	H	13	100	950	950	172	Rx35	R35	A28	228
66911000	232 D 16 AK	11/15,1/10Pl.,5/14	H	16	100	950	950	140	Rx35	R35	A4	245
66558000	232 D 16 AK	8/15		8	80	950	950	153	Rx25	R25	A32	120
66526000	232 D 16 FL	9/13	V	9	80	950	950	198	Rx25	R25	A32	117
66731000	232 D 16 FL	5/14,1/10Pl.,2/20,1/20Pl.,3/14	H	10	100	950	950	199	Rx35	R35	A28	182
66871000	232 D 16 FL	6/14,1/20Pl.,3/20,1/10Pl.,4/14	H	13	100	950	950	194	Rx35	R35	A28	230
66891000	232 D 16 FL	6/14,1/10,3/20,1/10,4/16	H	13	100	950	950	172	Rx35	R35	A28	228
66570000	232 D 16 FS	8/13	V	8	80	950	950	225	Rx25	R25	A32	110
66589000	232 D 16 FS	5/16,1/10Pl.,2/22	H	7	100	950	950	152	Rx35	R35	A5	134
66762000	232 D 16 K	8/13	V	8	80	950	950	190	Rx25	R25	A32	104
66526000	232 D 16 K	9/13	V	9	80	950	950	198	Rx25	R25	A32	117
66871000	232 D 16 K	6/14,1/20Pl.,3/20,1/10Pl.,4/14	H	13	100	950	950	194	Rx35	R35	A28	230
66800000	232 D 16 S	10/15	V	10	80	950	950	102	Rx25	R25	A11	150
66813000	232 D 16 S	5/14,1/10Pl.,2/20,1/20Pl.,3/16	H	10	100	950	950	182	Rx35	R35	A28	188
66526000	232 D 17 F	9/13	V	9	80	950	950	198	Rx25	R25	A32	117
66891000	232 D 17 F	6/14,1/10,3/20,1/10,4/16	H	13	100	950	950	172	Rx35	R35	A28	228
66374000	232 D 17 FA	9/14	V	9	80	950	950	153	Rx25	R25	A32	126
66762000	232 D 17 FAK	8/13	V	8	80	950	950	190	Rx25	R25	A32	104
66871000	232 D 17 FAK	6/14,1/20Pl.,3/20,1/10Pl.,4/14	H	13	100	950	950	194	Rx35	R35	A28	230
66522000	232 D 17 FK	9/12	V	9	80	950	950	236	Rx25	R25	A32	108
66871000	232 D 17 FK	6/14,1/20Pl.,3/20,1/10Pl.,4/14	H	13	100	950	950	194	Rx35	R35	A28	230
66891000	232 D 17 FK	6/14,1/10,3/20,1/10,4/16	H	13	100	950	950	172	Rx35	R35	A28	228
66522000	232 D 17 FS	9/12	V	9	80	950	950	236	Rx25	R25	A32	108
66557000	232 D 17 FS	9/12,1/10Pl.,2/18,3/16	H	14	100	950	950	208	Rx35	R35	A5	216
66374000	232 D 19 AK	9/14	V	9	80	950	950	153	Rx25	R25	A32	126
66572000	232 D 19 AK	10/15	V	10	80	900	1000	100	Rx25	R25	A11	150
66800000	232 D 19 AK	10/15	V	10	80	950	950	102	Rx25	R25	A11	150
66813000	232 D 19 AK	5/14,1/10Pl.,2/20,1/20Pl.,3/16	H	10	100	950	950	182	Rx35	R35	A28	188
66891000	232 D 19 AK	6/14,1/10,3/20,1/10,4/16	H	13	100	950	950	172	Rx35	R35	A28	228
66911000	232 D 19 AK	11/15,1/10Pl.,5/14	H	16	100	950	950	140	Rx35	R35	A4	245
66526000	232 D 19 F	9/13	V	9	80	950	950	198	Rx25	R25	A32	117
66374000	232 D 19 FAK	9/14	V	9	80	950	950	153	Rx25	R25	A32	126
66731000	232 D 19 FAK	5/14,1/10Pl.,2/20,1/20Pl.,3/14	H	10	100	950	950	199	Rx35	R35	A28	182

MAGIRUS-TYPEN

IVECO

MAGIRUS-TYPEN

Artikel.Nr.	Fahrzeugtyp	Info	Achsl.	Blattzahl	Breite	Lx/L1	Ly/L2	Spr./Kr.	Buchsen vorn	Buchsen hinten	Form	Paketstärke
Art.-No.	Type		Axle Load	Leaves	Width			FreeArch/Crank	Bush front	Bush rear	Shape	Total height
66891000	232 D 19 FAK	6/14,1/10,3/20,1/10,4/16	H	13	100	950	950	172	Rx35	R35	A28	228
66526000	232 D 19 FK	9/13	V	9	80	950	950	198	Rx25	R25	A32	117
66891000	232 D 19 FK	6/14,1/10,3/20,1/10,4/16	H	13	100	950	950	172	Rx35	R35	A28	228
66526000	232 D 19 FL	9/13	V	9	80	950	950	198	Rx25	R25	A32	117
66731000	232 D 19 FL	5/14,1/10Pl.,2/20,1/20Pl.,3/14	H	10	100	950	950	199	Rx35	R35	A28	182
66815000	232 D 19 FL	7/16,1/10Pl.,3/20	H	10	100	950	950	155	Rx35	R35	A5	182
66526000	232 D 19 FS	9/13	V	9	80	950	950	198	Rx25	R25	A32	117
66589000	232 D 19 FS	5/16,1/10Pl.,2/22	H	7	100	950	950	152	Rx35	R35	A5	134
66815000	232 D 19 FS	7/16,1/10Pl.,3/20	H	10	100	950	950	155	Rx35	R35	A5	182
66557000	232 D 19 FS	9/12,1/10Pl.,2/18,3/16	H	14	100	950	950	208	Rx35	R35	A5	216
66762000	232 D 19 K	8/13	V	8	80	950	950	190	Rx25	R25	A32	104
66374000	232 D 19 K	9/14	V	9	80	950	950	153	Rx25	R25	A32	126
66526000	232 D 19 K	9/13	V	9	80	950	950	198	Rx25	R25	A32	117
66572000	232 D 19 K	10/15	V	10	80	900	1000	100	Rx25	R25	A11	150
66800000	232 D 19 K	10/15	V	10	80	950	950	102	Rx25	R25	A11	150
66891000	232 D 19 K	6/14,1/10,3/20,1/10,4/16	H	13	100	950	950	172	Rx35	R35	A28	228
66911000	232 D 19 K	11/15,1/10Pl.,5/14	H	16	100	950	950	140	Rx35	R35	A4	245
66526000	232 D 19 L	9/13	V	9	80	950	950	198	Rx25	R25	A32	117
66572000	232 D 19 L	10/15	V	10	80	900	1000	100	Rx25	R25	A11	150
66800000	232 D 19 L	10/15	V	10	80	950	950	102	Rx25	R25	A11	150
66911000	232 D 19 L	11/15,1/10Pl.,5/14	H	16	100	950	950	140	Rx35	R35	A4	245
66572000	232 D 19 S	10/15	V	10	80	900	1000	100	Rx25	R25	A11	150
66800000	232 D 19 S	10/15	V	10	80	950	950	102	Rx25	R25	A11	150
66815000	232 D 19 S	7/16,1/10Pl.,3/20	H	10	100	950	950	155	Rx35	R35	A5	182
66911000	232 D 19 S	11/15,1/10Pl.,5/14	H	16	100	950	950	140	Rx35	R35	A4	245
66374000	232 D 20 AK	9/14	V	9	80	950	950	153	Rx25	R25	A32	126
66649000	232 D 20 AK	9/20,1/10Halter	H	9	100	780	780	46			D20	190
66572000	232 D 20 AL	10/15	V	10	80	900	1000	100	Rx25	R25	A11	150
66569000	232 D 20 AL	10/20,1/10Halter	H	10	100	780	780	50			D20	210
66374000	232 D 20 FAL	9/14	V	9	80	950	950	153	Rx25	R25	A32	126
66647000	232 D 20 FAL	7/20,1/10Halter	H	7	100	770	770	73			D20	150
66572000	232 D 20 L	10/15	V	10	80	900	1000	100	Rx25	R25	A11	150
66569000	232 D 20 L	10/20,1/10Halter	H	10	100	780	780	50			D20	210
66657000	232 D 20 L	13/20,1/10Halter	H	13	100	780	780	60			D20	270
66813000	232 D 22	5/14,1/10Pl.,2/20,1/20Pl.,3/16	H	10	100	950	950	182	Rx35	R35	A28	188
66762000	232 D 22 AK	8/13	V	8	80	950	950	190	Rx25	R25	A32	104
66374000	232 D 22 AK	9/14	V	9	80	950	950	153	Rx25	R25	A32	126
66752000	232 D 22 AK	9/11	V	9	80	840	840	176	Rx25	R25	A32	99
66647000	232 D 22 AK	7/20,1/10Halter	H	7	100	770	770	73			D20	150
66649000	232 D 22 AK	9/20,1/10Halter	H	9	100	780	780	46			D20	190
66569000	232 D 22 AK	10/20,1/10Halter	H	10	100	780	780	50			D20	210
66374000	232 D 22 AKO	9/14	V	9	80	950	950	153	Rx25	R25	A32	126
66820000	232 D 22 FAK	7/11	V	7	80	840	840	204	Rx25	R25	A32	77
66374000	232 D 22 FAK	9/14	V	9	80	950	950	153	Rx25	R25	A32	126
66522000	232 D 22 FAK	9/12	V	9	80	950	950	236	Rx25	R25	A32	108
66647000	232 D 22 FAK	7/20,1/10Halter	H	7	100	770	770	73			D20	150
66649000	232 D 22 FAK	9/20,1/10Halter	H	9	100	780	780	46			D20	190
66569000	232 D 22 FAK	10/20,1/10Halter	H	10	100	780	780	50			D20	210
66762000	232 D 22 FB	8/13	V	8	80	950	950	190	Rx25	R25	A32	104
66374000	232 D 22 FB	9/14	V	9	80	950	950	153	Rx25	R25	A32	126
66649000	232 D 22 FB	9/20,1/10Halter	H	9	100	780	780	46			D20	190
66569000	232 D 22 FB	10/20,1/10Halter	H	10	100	780	780	50			D20	210
66762000	232 D 22 FK	8/13	V	8	80	950	950	190	Rx25	R25	A32	104
66374000	232 D 22 FK	9/14	V	9	80	950	950	153	Rx25	R25	A32	126
66800000	232 D 22 FK	10/15	V	10	80	950	950	102	Rx25	R25	A11	150
66647000	232 D 22 FK	7/20,1/10Halter	H	7	100	770	770	73			D20	150
66569000	232 D 22 FK	10/20,1/10Halter	H	10	100	780	780	50			D20	210

MAGIRUS-TYPEN

IVECO

MAGIRUS-TYPEN

Artikel.Nr.	Fahrzeugtyp	Info	Achsl.	Blattzahl	Breite	Lx/L1	Ly/L2	Spr./ Kr.	Buchsen vorn	Buchsen hinten	Form	Paket- stärke
Art.-No.	Type		Axle Load	Leaves	Width			FreeArch /Crank	Bush front	Bush rear	Shape	Total height
66762000	232 D 22 FL	8/13	V	8	80	950	950	190	Rx25	R25	A32	104
66526000	232 D 22 FL	9/13	V	9	80	950	950	198	Rx25	R25	A32	117
66762000	232 D 22 FS	8/13	V	8	80	950	950	190	Rx25	R25	A32	104
66762000	232 D 22 K	8/13	V	8	80	950	950	190	Rx25	R25	A32	104
66374000	232 D 22 K	9/14	V	9	80	950	950	153	Rx25	R25	A32	126
66647000	232 D 22 K	7/20,1/10Halter	H	7	100	770	770	73			D20	150
66649000	232 D 22 K	9/20,1/10Halter	H	9	100	780	780	46			D20	190
66569000	232 D 22 K	10/20,1/10Halter	H	10	100	780	780	50			D20	210
66809000	232 D 22 K	15/17,1/10Pl.	H	15	100	780	780	49			D21	265
66572000	232 D 24 AL	10/15	V	10	80	900	1000	100	Rx25	R25	A11	150
66569000	232 D 24 AL	10/20,1/10Halter	H	10	100	780	780	50			D20	210
66800000	232 D 24 FK	10/15	V	10	80	950	950	102	Rx25	R25	A11	150
66569000	232 D 24 FK	10/20,1/10Halter	H	10	100	780	780	50			D20	210
66374000	232 D 24 K	9/14	V	9	80	950	950	153	Rx25	R25	A32	126
66800000	232 D 24 K	10/15	V	10	80	950	950	102	Rx25	R25	A11	150
66569000	232 D 24 K	10/20,1/10Halter	H	10	100	780	780	50			D20	210
66374000	232 D 24 L	9/14	V	9	80	950	950	153	Rx25	R25	A32	126
66572000	232 D 24 L	10/15	V	10	80	900	1000	100	Rx25	R25	A11	150
66569000	232 D 24 L	10/20,1/10Halter	H	10	100	780	780	50			D20	210
66374000	232 D 26 AK	9/14	V	9	80	950	950	153	Rx25	R25	A32	126
66572000	232 D 26 AK	10/15	V	10	80	900	1000	100	Rx25	R25	A11	150
66800000	232 D 26 AK	10/15	V	10	80	950	950	102	Rx25	R25	A11	150
66649000	232 D 26 AK	9/20,1/10Halter	H	9	100	780	780	46			D20	190
66569000	232 D 26 AK	10/20,1/10Halter	H	10	100	780	780	50			D20	210
66657000	232 D 26 AK	13/20,1/10Halter	H	13	100	780	780	60			D20	270
66809000	232 D 26 AK	15/17,1/10Pl.	H	15	100	780	780	49			D21	265
66374000	232 D 26 F	9/14	V	9	80	950	950	153	Rx25	R25	A32	126
66800000	232 D 26 F	10/15	V	10	80	950	950	102	Rx25	R25	A11	150
66569000	232 D 26 F	10/20,1/10Halter	H	10	100	780	780	50			D20	210
66809000	232 D 26 F	15/17,1/10Pl.	H	15	100	780	780	49			D21	265
66526000	232 D 26 FAK	9/13	V	9	80	950	950	198	Rx25	R25	A32	117
66569000	232 D 26 FAK	10/20,1/10Halter	H	10	100	780	780	50			D20	210
66731000	232 D 26 FAK	5/14,1/10Pl.,2/20,1/20Pl.,3/14	H	10	100	950	950	199	Rx35	R35	A28	182
66374000	232 D 26 FB	9/14	V	9	80	950	950	153	Rx25	R25	A32	126
66649000	232 D 26 FB	9/20,1/10Halter	H	9	100	780	780	46			D20	190
66569000	232 D 26 FB	10/20,1/10Halter	H	10	100	780	780	50			D20	210
66768000	232 D 26 FK	8/11	V	8	80	840	840	202	Rx25	R25	A32	88
66374000	232 D 26 FK	9/14	V	9	80	950	950	153	Rx25	R25	A32	126
66800000	232 D 26 FK	10/15	V	10	80	950	950	102	Rx25	R25	A11	150
66649000	232 D 26 FK	9/20,1/10Halter	H	9	100	780	780	46			D20	190
66569000	232 D 26 FK	10/20,1/10Halter	H	10	100	780	780	50			D20	210
66813000	232 D 26 FK	5/14,1/10Pl.,2/20,1/20Pl.,3/16	H	10	100	950	950	182	Rx35	R35	A28	188
66657000	232 D 26 FK	13/20,1/10Halter	H	13	100	780	780	60			D20	270
66891000	232 D 26 FK	6/14,1/10,3/20,1/10,4/16	H	13	100	950	950	172	Rx35	R35	A28	228
66809000	232 D 26 FK	15/17,1/10Pl.	H	15	100	780	780	49			D21	265
66762000	232 D 26 K	8/13	V	8	80	950	950	190	Rx25	R25	A32	104
66374000	232 D 26 K	9/14	V	9	80	950	950	153	Rx25	R25	A32	126
66572000	232 D 26 K	10/15	V	10	80	900	1000	100	Rx25	R25	A11	150
66800000	232 D 26 K	10/15	V	10	80	950	950	102	Rx25	R25	A11	150
66649000	232 D 26 K	9/20,1/10Halter	H	9	100	780	780	46			D20	190
66569000	232 D 26 K	10/20,1/10Halter	H	10	100	780	780	50			D20	210
66813000	232 D 26 K	5/14,1/10Pl.,2/20,1/20Pl.,3/16	H	10	100	950	950	182	Rx35	R35	A28	188
66657000	232 D 26 K	13/20,1/10Halter	H	13	100	780	780	60			D20	270
66891000	232 D 26 K	6/14,1/10,3/20,1/10,4/16	H	13	100	950	950	172	Rx35	R35	A28	228
66809000	232 D 26 K	15/17,1/10Pl.	H	15	100	780	780	49			D21	265
66374000	232 D 26 L	9/14	V	9	80	950	950	153	Rx25	R25	A32	126
66569000	232 D 26 L	10/20,1/10Halter	H	10	100	780	780	50			D20	210

MAGIRUS-TYPEN
IVECO
MAGIRUS-TYPEN

Artikel.Nr.	Fahrzeugtyp	Info	Achsl.	Blattzahl	Breite	Lx/L1	Ly/L2	Spr./Kr.	Buchsen vorn	Buchsen hinten	Form	Paketstärke
Art.-No.	Type		Axle Load	Leaves	Width			FreeArch/Crank	Bush front	Bush rear	Shape	Total height
66572000	232 D 26 S	10/15	V	10	80	900	1000	100	Rx25	R25	A11	150
66569000	232 D 26 S	10/20,1/10Halter	H	10	100	780	780	50			D20	210
66842000	232 D 30 FK	8/10,3/16	V	11	80	725	775	141	Rx25	R25	A6	128
66569000	232 D 30 FK	10/20,1/10Halter	H	10	100	780	780	50			D20	210
66662000	232 D 32 AK	10/15	V	10	80	900	1000	147	Rx25		A11	150
66657000	232 D 32 AK	13/20,1/10Halter	H	13	100	780	780	60			D20	270
66662000	232 D 32 K	10/15	V	10	80	900	1000	147	Rx25		A11	150
66657000	232 D 32 K	13/20,1/10Halter	H	13	100	780	780	60			D20	270
66522000	232 M 15 FS	9/12	V	9	80	950	950	236	Rx25	R25	A32	108
66587000	232 M 15 FS	7/12,1/10Pl.,4/16	H	11	100	950	950	250	Rx35	R35	A5	166
66526000	232 M 17 F	9/13	V	9	80	950	950	198	Rx25	R25	A32	117
66891000	232 M 17 F	6/14,1/10,3/20,1/10,4/16	H	13	100	950	950	172	Rx35	R35	A28	228
66690000	235 D 22 FS	11/11	V	11	80	875	1050	270	25x30		B15	121
66695000	235 D 22 FS	7/20,Rippe	H	7	90	720	720	64			D1.1	140
66477000	235 D 22 FS	12/16	H	12	90	720	720	50			D1.1	192
66374000	256 D 16 AK	9/14	V	9	80	950	950	153	R25	R25	A32	126
66800000	256 D 16 AK	10/15	V	10	80	950	950	102	R25	R25	A11	150
66813000	256 D 16 AK	5/14,1/10Pl.,2/20,1/20Pl.,3/16	H	10	100	950	950	182	R35	R35	A28	188
66891000	256 D 16 AK	6/14,1/10,3/20,1/10,4/16	H	13	100	950	950	172	R35	R35	A28	228
66647000	256 D 16 AL	7/20,1/10Halter	H	7	100	770	770	73			D20	150
66526000	256 D 16 FL	9/13	V	9	80	950	950	198	R25	R25	A32	117
66731000	256 D 16 FL	5/14,1/10Pl.,2/20,1/20Pl.,3/14	H	10	100	950	950	199	R35	R35	A28	182
66526000	256 D 16 K	9/13	V	9	80	950	950	198	R25	R25	A32	117
66813000	256 D 16 K	5/14,1/10Pl.,2/20,1/20Pl.,3/16	H	10	100	950	950	182	R35	R35	A28	188
66891000	256 D 16 K	6/14,1/10,3/20,1/10,4/16	H	13	100	950	950	172	R35	R35	A28	228
66572000	256 D 18 AL	10/15	V	10	80	900	1000	100	R25	R25	A11	150
66374000	256 D 19 AK	9/14	V	9	80	950	950	153	R25	R25	A32	126
66891000	256 D 19 AK	6/14,1/10,3/20,1/10,4/16	H	13	100	950	950	172	R35	R35	A28	228
66526000	256 D 19 FL	9/13	V	9	80	950	950	198	R25	R25	A32	117
66800000	256 D 19 FL	10/15	V	10	80	950	950	102	R25	R25	A11	150
66815000	256 D 19 FL	7/16,1/10Pl.,3/20	H	10	100	950	950	155	R35	R35	A5	182
66526000	256 D 19 FS	9/13	V	9	80	950	950	198	R25	R25	A32	117
66589000	256 D 19 FS	5/16,1/10Pl.,2/22	H	7	100	950	950	152	R35	R35	A5	134
66815000	256 D 19 FS	7/16,1/10Pl.,3/20	H	10	100	950	950	155	R35	R35	A5	182
66587000	256 D 19 FS	7/12,1/10Pl.,4/16	H	11	100	950	950	250	R35	R35	A5	166
66526000	256 D 19 K	9/13	V	9	80	950	950	198	R25	R25	A32	117
66891000	256 D 19 K	6/14,1/10,3/20,1/10,4/16	H	13	100	950	950	172	R35	R35	A28	228
66558000	256 D 19 K	8/15		8	80	950	950	153	R25	R25	A32	120
66572000	256 D 19 L	10/15	V	10	80	900	1000	100	R25	R25	A11	150
66815000	256 D 19 S	7/16,1/10Pl.,3/20	H	10	100	950	950	155	R35	R35	A5	182
66374000	256 D 26 AK	9/14	V	9	80	950	950	153	R25	R25	A32	126
66800000	256 D 26 AK	10/15	V	10	80	950	950	102	R25	R25	A11	150
66569000	256 D 26 AK	10/20,1/10Halter	H	10	100	780	780	50			D20	210
66657000	256 D 26 AK	13/20,1/10Halter	H	13	100	780	780	60			D20	270
66809000	256 D 26 AK	15/17,1/10Pl.	H	15	100	780	780	49			D21	265
66569000	256 D 26 FB	10/20,1/10Halter	H	10	100	780	780	50			D20	210
66657000	256 D 26 FB	13/20,1/10Halter	H	13	100	780	780	60			D20	270
66374000	256 D 26 K	9/14	V	9	80	950	950	153	R25	R25	A32	126
66572000	256 D 26 K	10/15	V	10	80	900	1000	100	R25	R25	A11	150
66800000	256 D 26 K	10/15	V	10	80	950	950	102	R25	R25	A11	150
66569000	256 D 26 K	10/20,1/10Halter	H	10	100	780	780	50			D20	210
66657000	256 D 26 K	13/20,1/10Halter	H	13	100	780	780	60			D20	270
66809000	256 D 26 K	15/17,1/10Pl.	H	15	100	780	780	49			D21	265
66572000	256 D 26 S	10/15	V	10	80	900	1000	100	R25	R25	A11	150
66569000	256 D 26 S	10/20,1/10Halter	H	10	100	780	780	50			D20	210
66374000	256 D FB	9/14	V	9	80	950	950	153	R25	R25	A32	126
67214000	256 M 16 FL	2/13,5/14	V	7	90	900	900	178	35x45	35x45	A26	96

MAGIRUS-TYPEN

IVECO

MAGIRUS-TYPEN

Artikel.Nr.	Fahrzeugtyp	Info	Achsl.	Blattzahl	Breite	Lx/L1	Ly/L2	Spr./ Kr.	Buchsen vorn	Buchsen hinten	Form	Paket- stärke
Art.-No.	Type		Axle Load	Leaves	Width			FreeArch /Crank	Bush front	Bush rear	Shape	Total height
66716000	256 M 16 FL	8/13	V	8	90	900	900	186	35x45	35x45	A26	104
67213000	256 M 16 FL	6/15,1/10Zwlg.,9/11	H	15	90	900	900	175	35x45	35x45	A28	199
66722000	256 M 16 FLL	11/11	V	11	90	900	900		35	35	A26	121
66720000	256 M 16 FS	11/10,1/12	V	11	90	900	900	282	35x45	35x45	A26	122
67262000	256 M 16 FS	11/10	V	11	90	900	900	280	35x45	35x45	A26	110
67213000	256 M 16 FS	6/15,1/10Zwlg.,9/11	H	15	90	900	900	175	35x45	35x45	A28	199
67216000	256 M 16 FSL	13/10	V	13	90	900	900	255	35x45	35x45	A26	130
66708000	256 M 16 K	10/	V	10	80	900	1000	100			A1	150
66927000	256 M 16 K	5/14,1/10Pl.,2/20,1/10Pl.,5/14	H	12	100	950	950	172	R35	R35	A28	210
66708000	256 M 16 L	10/	V	10	80	900	1000	100			A1	150
66927000	256 M 16 L	5/14,1/10Pl.,2/20,1/10Pl.,5/14	H	12	100	950	950	172	R35	R35	A28	210
66658000	256 M 19 AK	9/14	V	9	80	950	950	160	R25	R25	A32	126
66704000	256 M 19 AK	9/14	V	9	80	950	950	123	R25	R25	A11	126
66620000	256 M 19 AK	14/13	V	14	80	900	1000	130	R25	R25	A32	182
66790000	256 M 19 AK	14/13	V	14	80	950	950	100	R25	R25	A32	182
66927000	256 M 19 AK	5/14,1/10Pl.,2/20,1/10Pl.,5/14	H	12	100	950	950	172	R35	R35	A28	210
66911000	256 M 19 AK	11/15,1/10Pl.,5/14	H	16	100	950	950	140	R35	R35	A4	245
66790000	256 M 19 F	14/13	V	14	80	950	950	100	R25	R25	A32	182
66911000	256 M 19 F	11/15,1/10Pl.,5/14	H	16	100	950	950	140	R35	R35	A4	245
66790000	256 M 19 FAK	14/13	V	14	80	950	950	100	R25	R25	A32	182
66911000	256 M 19 FAK	11/15,1/10Pl.,5/14	H	16	100	950	950	140	R35	R35	A4	245
66800000	256 M 19 FK	10/15	V	10	80	950	950	102	R25	R25	A11	150
66790000	256 M 19 FK	14/13	V	14	80	950	950	100	R25	R25	A32	182
66891000	256 M 19 FK	6/14,1/10,3/20,1/10,4/16	H	13	100	950	950	172	R35	R35	A28	228
66911000	256 M 19 FK	11/15,1/10Pl.,5/14	H	16	100	950	950	140	R35	R35	A4	245
66704000	256 M 19 FKS	9/14	V	9	80	950	950	123	R25	R25	A11	126
66790000	256 M 19 FKS	14/13	V	14	80	950	950	100	R25	R25	A32	182
66911000	256 M 19 FKS	11/15,1/10Pl.,5/14	H	16	100	950	950	140	R35	R35	A4	245
66976000	256 M 19 FL	4/20,1/10Pl.	V	4	90	900	900	213	35x45	35x45	A19	102
67214000	256 M 19 FL	2/13,5/14	V	7	90	900	900	178	35x45	35x45	A26	96
66716000	256 M 19 FL	8/13	V	8	90	900	900	186	35x45	35x45	A26	104
67213000	256 M 19 FL	6/15,1/10Zwlg.,9/11	H	15	90	900	900	175	35x45	35x45	A28	199
66722000	256 M 19 FLL	11/11	V	11	90	900	900		35	35	A26	121
67216000	256 M 19 FLL	13/10	V	13	90	900	900	255	35x45	35x45	A26	130
66704000	256 M 19 FS	9/14	V	9	80	950	950	123	R25	R25	A11	126
66976000	256 M 19 FS	4/20,1/10Pl.	V	4	90	900	900	213	35x45	35x45	A19	102
66718000	256 M 19 FS	11/10	V	11	90	900	900		35	35	A26	110
66720000	256 M 19 FS	11/10,1/12	V	11	90	900	900	282	35x45	35x45	A26	122
67262000	256 M 19 FS	11/10	V	11	90	900	900	280	35x45	35x45	A26	110
67216000	256 M 19 FS	13/10	V	13	90	900	900	255	35x45	35x45	A26	130
67213000	256 M 19 FS	6/15,1/10Zwlg.,9/11	H	15	90	900	900	175	35x45	35x45	A28	199
66891000	256 M 19 FS	6/14,1/10,3/20,1/10,4/16	H	13	100	950	950	172	R35	R35	A28	228
66911000	256 M 19 FS	11/15,1/10Pl.,5/14	H	16	100	950	950	140	R35	R35	A4	245
67216000	256 M 19 FSL	13/10	V	13	90	900	900	255	35x45	35x45	A26	130
66658000	256 M 19 K	9/14	V	9	80	950	950	160	R25	R25	A32	126
66704000	256 M 19 K	9/14	V	9	80	950	950	123	R25	R25	A11	126
66620000	256 M 19 K	14/13	V	14	80	900	1000	130	R25	R25	A32	182
66790000	256 M 19 K	14/13	V	14	80	950	950	100	R25	R25	A32	182
66927000	256 M 19 K	5/14,1/10Pl.,2/20,1/10Pl.,5/14	H	12	100	950	950	172	R35	R35	A28	210
66911000	256 M 19 K	11/15,1/10Pl.,5/14	H	16	100	950	950	140	R35	R35	A4	245
66572000	256 M 19 L	10/15	V	10	80	900	1000	100	R25	R25	A11	150
66620000	256 M 19 L	14/13	V	14	80	900	1000	130	R25	R25	A32	182
66911000	256 M 19 L	11/15,1/10Pl.,5/14	H	16	100	950	950	140	R35	R35	A4	245
66570000	256 M 19 S	8/13	V	8	80	950	950	225	R25	R25	A32	110
66658000	256 M 19 S	9/14	V	9	80	950	950	160	R25	R25	A32	126
66704000	256 M 19 S	9/14	V	9	80	950	950	123	R25	R25	A11	126
66815000	256 M 19 S	7/16,1/10Pl.,3/20	H	10	100	950	950	155	R35	R35	A5	182

MAGIRUS-TYPEN

IVECO

MAGIRUS-TYPEN

Artikel.Nr.	Fahrzeugtyp	Info	Achsl.	Blattzahl	Breite	Lx/L1	Ly/L2	Spr./Kr.	Buchsen vorn	Buchsen hinten	Form	Paketstärke
Art.-No.	Type		Axle Load	Leaves	Width			FreeArch/Crank	Bush front	Bush rear	Shape	Total height
66927000	256 M 19 S	5/14,1/10Pl.,2/20,1/10Pl.,5/14	H	12	100	950	950	172	R35	R35	A28	210
66911000	256 M 19 S	11/15,1/10Pl.,5/14	H	16	100	950	950	140	R35	R35	A4	245
67216000	256 M 22 FLL	13/10	V	13	90	900	900	255	35x45	35x45	A26	130
67216000	256 M 22 FSL	13/10	V	13	90	900	900	255	35x45	35x45	A26	130
66658000	256 M 26 AK	9/14	V	9	80	950	950	160	R25	R25	A32	126
66704000	256 M 26 AK	9/14	V	9	80	950	950	123	R25	R25	A11	126
66620000	256 M 26 AK	14/13	V	14	80	900	1000	130	R25	R25	A32	182
66790000	256 M 26 AK	14/13	V	14	80	950	950	100	R25	R25	A32	182
66569000	256 M 26 AK	10/20,1/10Halter	H	10	100	780	780	50			D20	210
66867000	256 M 26 AK	14/18,1/10Halter	H	14	100	780	780	50			D20	262
66919000	256 M 26 AK	18/18,1/10Halter	H	18	100	780	780	41			D20	334
66868000	256 M 26 FAK	10/15	V	10	80	950	950	90	R25	R25	A11	150
66790000	256 M 26 FAK	14/13	V	14	80	950	950	100	R25	R25	A32	182
66867000	256 M 26 FAK	14/18,1/10Halter	H	14	100	780	780	50			D20	262
66569000	256 M 26 FB	10/20,1/10Halter	H	10	100	780	780	50			D20	210
66790000	256 M 26 FK	14/13	V	14	80	950	950	100	R25	R25	A32	182
66867000	256 M 26 FK	14/18,1/10Halter	H	14	100	780	780	50			D20	262
66790000	256 M 26 FKL	14/13	V	14	80	950	950	100	R25	R25	A32	182
66867000	256 M 26 FKL	14/18,1/10Halter	H	14	100	780	780	50			D20	262
66704000	256 M 26 FKS	9/14	V	9	80	950	950	123	R25	R25	A11	126
66790000	256 M 26 FKS	14/13	V	14	80	950	950	100	R25	R25	A32	182
66569000	256 M 26 FKS	10/20,1/10Halter	H	10	100	780	780	50			D20	210
66867000	256 M 26 FKS	14/18,1/10Halter	H	14	100	780	780	50			D20	262
66790000	256 M 26 FS	14/13	V	14	80	950	950	100	R25	R25	A32	182
66569000	256 M 26 FS	10/20,1/10Halter	H	10	100	780	780	50			D20	210
66658000	256 M 26 K	9/14	V	9	80	950	950	160	R25	R25	A32	126
66704000	256 M 26 K	9/14	V	9	80	950	950	123	R25	R25	A11	126
66708000	256 M 26 K	10/	V	10	80	900	1000	100			A1	150
66620000	256 M 26 K	14/13	V	14	80	900	1000	130	R25	R25	A32	182
66790000	256 M 26 K	14/13	V	14	80	950	950	100	R25	R25	A32	182
66569000	256 M 26 K	10/20,1/10Halter	H	10	100	780	780	50			D20	210
66867000	256 M 26 K	14/18,1/10Halter	H	14	100	780	780	50			D20	262
66919000	256 M 26 K	18/18,1/10Halter	H	18	100	780	780	41			D20	334
66658000	256 M 26 L	9/14	V	9	80	950	950	160	R25	R25	A32	126
66708000	256 M 26 L	10/	V	10	80	900	1000	100			A1	150
66620000	256 M 26 L	14/13	V	14	80	900	1000	130	R25	R25	A32	182
66569000	256 M 26 L	10/20,1/10Halter	H	10	100	780	780	50			D20	210
66867000	256 M 26 L	14/18,1/10Halter	H	14	100	780	780	50			D20	262
66790000	256 M 33 FK	14/13	V	14	80	950	950	100	R25	R25	A32	182
66569000	256 M 33 FK	10/20,1/10Halter	H	10	100	780	780	50			D20	210
66919000	256 M 33 FK	18/18,1/10Halter	H	18	100	780	780	41			D20	334
66780000	260 D 16 FAL	7/15	V	7	80	950	950	142	R25	R25	A32	105
66844000	260 D 16 FAL	9/14	V	9	80	900	1000	124	R25	R25	A1	126
66695000	260 D 16 FAL	7/20,Rippe	H	7	90	720	720	64			D1.1	140
66647000	260 D 16 FAL	7/20,1/10Halter	H	7	100	770	770	73			D20	150
66658000	260 F 19 PAC	9/14	V	9	80	950	950	160	R25	R25	A32	126
66572000	260 F 19 PAC	10/15	V	10	80	900	1000	100	R25	R25	A11	150
66662000	260 F 19 PAC	10/15	V	10	80	900	1000	147	R25		A11	150
66800000	260 F 19 PAC	10/15	V	10	80	950	950	102	R25	R25	A11	150
66868000	260 F 19 PAC	10/15	V	10	80	950	950	90	R25	R25	A11	150
66569000	260 F 19 PAC	10/20,1/10Halter	H	10	100	780	780	50			D20	210
66891000	260 F 19 PAC	6/14,1/10,3/20,1/10,4/16	H	13	100	950	950	172	R35	R35	A28	228
66867000	260 F 19 PAC	14/18,1/10Halter	H	14	100	780	780	50			D20	262
66911000	260 F 19 PAC	11/15,1/10Pl.,5/14	H	16	100	950	950	140	R35	R35	A4	245
66800000	260 F 19 PC	10/15	V	10	80	950	950	102	R25	R25	A11	150
66868000	260 F 19 PC	10/15	V	10	80	950	950	90	R25	R25	A11	150
66911000	260 F 19 PC	11/15,1/10Pl.,5/14	H	16	100	950	950	140	R35	R35	A4	245

MAGIRUS-TYPEN

IVECO

MAGIRUS-TYPEN

Artikel.Nr.	Fahrzeugtyp	Info	Achsl.	Blattzahl	Breite	Lx/L1	Ly/L2	Spr./ Kr.	Buchsen vorn	Buchsen hinten	Form	Paket- stärke
Art.-No.	Type		Axle Load	Leaves	Width			FreeArch /Crank	Bush front	Bush rear	Shape	Total height
66658000	260 F 26 PAC	9/14	V	9	80	950	950	160	R25	R25	A32	126
66800000	260 F 26 PAC	10/15	V	10	80	950	950	102	R25	R25	A11	150
66868000	260 F 26 PAC	10/15	V	10	80	950	950	90	R25	R25	A11	150
66790000	260 F 26 PAC	14/13	V	14	80	950	950	100	R25	R25	A32	182
66569000	260 F 26 PAC	10/20,1/10Halter	H	10	100	780	780	50			D20	210
66867000	260 F 26 PAC	14/18,1/10Halter	H	14	100	780	780	50			D20	262
66919000	260 F 26 PAC	18/18,1/10Halter	H	18	100	780	780	41			D20	334
66658000	260 F 26 PAT	9/14	V	9	80	950	950	160	R25	R25	A32	126
66569000	260 F 26 PAT	10/20,1/10Halter	H	10	100	780	780	50			D20	210
66800000	260 F 26 PC	10/15	V	10	80	950	950	102	R25	R25	A11	150
66868000	260 F 26 PC	10/15	V	10	80	950	950	90	R25	R25	A11	150
66569000	260 F 26 PC	10/20,1/10Halter	H	10	100	780	780	50			D20	210
66569000	260 F 26 PT	10/20,1/10Halter	H	10	100	780	780	50			D20	210
66800000	260 F 33 PC	10/15	V	10	80	950	950	102	R25	R25	A11	150
66569000	260 F 33 PC	10/20,1/10Halter	H	10	100	780	780	50			D20	210
66800000	260 F 35 P	10/15	V	10	80	950	950	102	R25	R25	A11	150
66569000	260 F 35 P	10/20,1/10Halter	H	10	100	780	780	50			D20	210
66800000	260 F 35 PC	10/15	V	10	80	950	950	102	R25	R25	A11	150
66569000	260 F 35 PC	10/20,1/10Halter	H	10	100	780	780	50			D20	210
66800000	260 F 35 PT	10/15	V	10	80	950	950	102	R25	R25	A11	150
66569000	260 F 35 PT	10/20,1/10Halter	H	10	100	780	780	50			D20	210
66374000	270 D 16 AK	9/14	V	6,5	9	80	950	153	R25	R25	A32	126
66902000	270 D 16 AK	9/	V	6,5	9	80	950		R25	R25	A26	126
66813000	270 D 16 AK	5/14,1/10Pl.,2/20,1/20Pl.,3/16	H	6,5	10	100	950	182	R35	R35	A28	188
66374000	270 D 16 FAK	9/14	V	6,5	9	80	950	153	R25	R25	A32	126
66813000	270 D 16 FAK	5/14,1/10Pl.,2/20,1/20Pl.,3/16	H	6,5	10	100	950	182	R35	R35	A28	188
66891000	270 D 16 FAK	6/14,1/10,3/20,1/10,4/16	H	6,5	13	100	950	172	R35	R35	A28	228
66526000	270 D 16 FK	9/13	V	6,5	9	80	950	198	R25	R25	A32	117
66813000	270 D 16 FK	5/14,1/10Pl.,2/20,1/20Pl.,3/16	H	6,5	10	100	950	182	R35	R35	A28	188
66891000	270 D 16 FK	6/14,1/10,3/20,1/10,4/16	H	6,5	13	100	950	172	R35	R35	A28	228
66526000	270 D 16 FL	9/13	V	6,5	9	80	950	198	R25	R25	A32	117
66731000	270 D 16 FL	5/14,1/10Pl.,2/20,1/20Pl.,3/14	H	6,5	10	100	950	199	R35	R35	A28	182
66570000	270 D 16 FS	8/13	V	6,5	8	80	950	225	R25	R25	A32	110
66589000	270 D 16 FS	5/16,1/10Pl.,2/22	H	6,5	7	100	950	152	R35	R35	A5	134
66815000	270 D 16 FS	7/16,1/10Pl.,3/20	H	6,5	10	100	950	155	R35	R35	A5	182
66587000	270 D 16 FS	7/12,1/10Pl.,4/16	H	6,5	11	100	950	250	R35	R35	A5	166
66557000	270 D 16 FS	9/12,1/10Pl.,2/18,3/16	H	6,5	14	100	950	208	R35	R35	A5	216
66526000	270 D 16 K	9/13	V	6,5	9	80	950	198	R25	R25	A32	117
66813000	270 D 16 K	5/14,1/10Pl.,2/20,1/20Pl.,3/16	H	6,5	10	100	950	182	R35	R35	A28	188
66570000	270 D 16 S	8/13	V	6,5	8	80	950	225	R25	R25	A32	110
66589000	270 D 16 S	5/16,1/10Pl.,2/22	H	6,5	7	100	950	152	R35	R35	A5	134
66374000	270 D 22 FL	9/14	V	6,5	9	80	950	153	R25	R25	A32	126
66526000	270 D 22 FL	9/13	V	6,5	9	80	950	198	R25	R25	A32	117
66779000	270 D 22 FL	13/9,2/15	H	6,5	15	100	580	103	R35	R35	A43	147
66887000	270 D 22 FL	14/10,2/16	H	6,5	16	100	580	116	R35	R35	A43	172
66526000	270 D 22 FLL	9/13	V	6,5	9	80	950	198	R25	R25	A32	117
66570000	270 D 22 FS	8/13	V	6,5	8	80	950	225	R25	R25	A32	110
66779000	270 D 22 FS	13/9,2/15	H	6,5	15	100	580	103	R35	R35	A43	147
66887000	270 D 22 FS	14/10,2/16	H	6,5	16	100	580	116	R35	R35	A43	172
66570000	270 D 22 FSL	8/13	V	6,5	8	80	950	225	R25	R25	A32	110
66902000	270 D 26 AK	9/	V	6,5	9	80	950		R25	R25	A26	126
66569000	270 D 26 AK	10/20,1/10Halter	H	6,5	10	100	780	50			D20	210
66526000	270 D 26 FAK	9/13	V	6,5	9	80	950	198	R25	R25	A32	117
66569000	270 D 26 FAK	10/20,1/10Halter	H	6,5	10	100	780	50			D20	210
66657000	270 D 26 FAK	13/20,1/10Halter	H	6,5	13	100	780	60			D20	270
66374000	270 D 26 FK	9/14	V	6,5	9	80	950	153	R25	R25	A32	126
66569000	270 D 26 FK	10/20,1/10Halter	H	6,5	10	100	780	50			D20	210

MAGIRUS-TYPEN

IVECO

MAGIRUS-TYPEN

Artikel.Nr.	Fahrzeugtyp	Info	Achsl.	Blattzahl	Breite	Lx/L1	Ly/L2	Spr./Kr.	Buchsen vorn	Buchsen hinten	Form	Paketstärke	
Art.-No.	Type		Axle Load	Leaves	Width			FreeArch/Crank	Bush front	Bush rear	Shape	Total height	
66374000	270 D 26 K	9/14	V	6,5	9	80	950	950	153	R25	R25	A32	126
66569000	270 D 26 K	10/20,1/10Halte	H		10	100	780	780	50			D20	210
66526000	270 M 16 FL	9/13	V		9	80	950	950	198	R25	R25	A32	117
66731000	270 M 16 FL	5/14,1/10Pl.,2/20,1/20Pl.,3/14	H		10	100	950	950	199	R35	R35	A28	182
66927000	280 M 16 S	5/14,1/10Pl.,2/20,1/10Pl.,5/14	H		12	100	950	950	172	R35	R35	A28	210
66708000	280 M 16 S 4X2	10/	V		10	80	900	1000	100			A1	150
66569000	280 M 26 S	10/20,1/10Halte	H		10	100	780	780	50			D20	210
66708000	280 M 26 S 6X4	10/	V		10	80	900	1000	100			A1	150
66844000	290 D 16 FAL	9/14	V		9	80	900	1000	124	R25	R25	A1	126
66647000	290 D 16 FAL	7/20,1/10Halte	H		7	100	770	770	73			D20	150
66762000	290 D 22 FK	8/13	V		8	80	950	950	190	R25	R25	A32	104
66695000	290 D 22 FK	7/20,Rippe	H		7	90	720	720	64			D1.1	140
66570000	290 D 26 K	8/13	V		8	80	950	950	225	R25	R25	A32	110
66526000	290 D 26 K	9/13	V		9	80	950	950	198	R25	R25	A32	117
66800000	290 D 26 K	10/15	V		10	80	950	950	102	R25	R25	A11	150
66569000	290 D 26 K	10/20,1/10Halte	H		10	100	780	780	50			D20	210
66871000	290 D 26 K	6/14,1/20Pl.,3/20,1/10Pl.,4/14	H		13	100	950	950	194	R35	R35	A28	230
66809000	290 D 26 K	15/17,1/10Pl.	H		15	100	780	780	49			D21	265
66800000	290 D 26 L	10/15	V		10	80	950	950	102	R25	R25	A11	150
66569000	290 D 26 L	10/20,1/10Halte	H		10	100	780	780	50			D20	210
66780000	290 D 26 S	7/15	V		7	80	950	950	142	R25	R25	A32	105
66976000	290 M 19 FL	4/20,1/10Pl.	V		4	90	900	900	213	35x45	35x45	A19	102
66716000	290 M 19 FL	8/13	V		8	90	900	900	186	35x45	35x45	A26	104
66722000	290 M 19 FL	11/11	V		11	90	900	900		35	35	A26	121
66961000	290 M 19 FL	4/21,1/21Pl.,1/10Pl.,3/20	H	13,0	7	90	900	900	189	35x45	35x45	A2	202
67213000	290 M 19 FL	6/15,1/10Zwlg.,9/11	H		15	90	900	900	175	35x45	35x45	A28	199
66722000	290 M 19 FLL	11/11	V		11	90	900	900		35	35	A26	121
66976000	290 M 19 FS	4/20,1/10Pl.	V		4	90	900	900	213	35x45	35x45	A19	102
66718000	290 M 19 FS	11/10	V		11	90	900	900		35	35	A26	110
66724000	290 M 19 FS	11/10,2/9,1/12	V		13	90	900	900	247	35x45	35x45	A26	140
67216000	290 M 19 FS	13/10	V		13	90	900	900	255	35x45	35x45	A26	130
66961000	290 M 19 FS	4/21,1/21Pl.,1/10Pl.,3/20	H	13,0	7	90	900	900	189	35x45	35x45	A2	202
67261000	290 M 19 FS	6/15,1/10Pl.,7/11	H		13	90	900	900	175	35x45	35x45	A28	177
67213000	290 M 19 FS	6/15,1/10Zwlg.,9/11	H		15	90	900	900	175	35x45	35x45	A28	199
66976000	290 M 22 FLL	4/20,1/10Pl.	V		4	90	900	900	213	35x45	35x45	A19	102
66718000	290 M 22 FLL	11/10	V		11	90	900	900		35	35	A26	110
67216000	290 M 22 FLL	13/10	V		13	90	900	900	255	35x45	35x45	A26	130
66570000	310 D 16 S	8/13	V		8	80	950	950	225	R25	R25	A32	110
66570000	310 D 19 AK	8/13	V		8	80	950	950	225	R25	R25	A32	110
66374000	310 D 19 AK	9/14	V	6,5	9	80	950	950	153	R25	R25	A32	126
66891000	310 D 19 AK	6/14,1/10,3/20,1/10,4/16	H		13	100	950	950	172	R35	R35	A28	228
66891000	310 D 19 FA	6/14,1/10,3/20,1/10,4/16	H		13	100	950	950	172	R35	R35	A28	228
66374000	310 D 19 FAK	9/14	V	6,5	9	80	950	950	153	R25	R25	A32	126
66526000	310 D 19 FAK	9/13	V		9	80	950	950	198	R25	R25	A32	117
66813000	310 D 19 FAK	5/14,1/10Pl.,2/20,1/20Pl.,3/16	H		10	100	950	950	182	R35	R35	A28	188
66891000	310 D 19 FAK	6/14,1/10,3/20,1/10,4/16	H		13	100	950	950	172	R35	R35	A28	228
66762000	310 D 19 FK	8/13	V		8	80	950	950	190	R25	R25	A32	104
66526000	310 D 19 FK	9/13	V		9	80	950	950	198	R25	R25	A32	117
66891000	310 D 19 FK	6/14,1/10,3/20,1/10,4/16	H		13	100	950	950	172	R35	R35	A28	228
66570000	310 D 19 FL	8/13	V		8	80	950	950	225	R25	R25	A32	110
66762000	310 D 19 FL	8/13	V		8	80	950	950	190	R25	R25	A32	104
66526000	310 D 19 FL	9/13	V		9	80	950	950	198	R25	R25	A32	117
66731000	310 D 19 FL	5/14,1/10Pl.,2/20,1/20Pl.,3/14	H		10	100	950	950	199	R35	R35	A28	182
66570000	310 D 19 FS	8/13	V		8	80	950	950	225	R25	R25	A32	110
66762000	310 D 19 FS	8/13	V		8	80	950	950	190	R25	R25	A32	104
66526000	310 D 19 FS	9/13	V		9	80	950	950	198	R25	R25	A32	117

MAGIRUS-TYPEN

IVECO

MAGIRUS-TYPEN

Artikel.Nr.	Fahrzeugtyp	Info	Achsl.	Blattzahl	Breite	Lx/L1	Ly/L2	Spr./ Kr.	Buchsen vorn	Buchsen hinten	Form	Paket- stärke
Art.-No.	Type		Axle Load	Leaves	Width			FreeArch /Crank	Bush front	Bush rear	Shape	Total height
66731000	310 D 19 FS	5/14,1/10Pl.,2/20,1/20Pl.,3/14	H	10	100	950	950	199	R35	R35	A28	182
66815000	310 D 19 FS	7/16,1/10Pl.,3/20	H	10	100	950	950	155	R35	R35	A5	182
66587000	310 D 19 FS	7/12,1/10Pl.,4/16	H	11	100	950	950	250	R35	R35	A5	166
66557000	310 D 19 FS	9/12,1/10Pl.,2/18,3/16	H	14	100	950	950	208	R35	R35	A5	216
66570000	310 D 19 FSL	8/13	V	8	80	950	950	225	R25	R25	A32	110
66526000	310 D 19 K	9/13	V	9	80	950	950	198	R25	R25	A32	117
66891000	310 D 19 K	6/14,1/10,3/20,1/10,4/16	H	13	100	950	950	172	R35	R35	A28	228
66570000	310 D 19 S	8/13	V	8	80	950	950	225	R25	R25	A32	110
66762000	310 D 19 S	8/13	V	8	80	950	950	190	R25	R25	A32	104
66815000	310 D 19 S	7/16,1/10Pl.,3/20	H	10	100	950	950	155	R35	R35	A5	182
66752000	310 D 20 AL	9/11	V	9	80	840	840	176	R25	R25	A32	99
66569000	310 D 20 AL	10/20,1/10Halter	H	10	100	780	780	50			D20	210
66748000	310 D 21 F		V	9	80						A32	126
66779000	310 D 21 F	13/9,2/15	H	15	100	580	850	103	R35	R35	A43	147
66762000	310 D 22 AK	8/13	V	8	80	950	950	190	R25	R25	A32	104
66374000	310 D 22 AK	9/14	V	6,5	9	80	950	153	R25	R25	A32	126
66647000	310 D 22 AK	7/20,1/10Halter	H	7	100	770	770	73			D20	150
66649000	310 D 22 AK	9/20,1/10Halter	H	9	100	780	780	46			D20	190
66569000	310 D 22 AK	10/20,1/10Halter	H	10	100	780	780	50			D20	210
66374000	310 D 22 FA	9/14	V	6,5	9	80	950	153	R25	R25	A32	126
66647000	310 D 22 FA	7/20,1/10Halter	H	7	100	770	770	73			D20	150
66820000	310 D 22 FAK	7/11	V	7	80	840	840	204	R25	R25	A32	77
66374000	310 D 22 FAK	9/14	V	6,5	9	80	950	153	R25	R25	A32	126
66647000	310 D 22 FAK	7/20,1/10Halter	H	7	100	770	770	73			D20	150
66649000	310 D 22 FAK	9/20,1/10Halter	H	9	100	780	780	46			D20	190
66569000	310 D 22 FAK	10/20,1/10Halter	H	10	100	780	780	50			D20	210
66762000	310 D 22 FK	8/13	V	8	80	950	950	190	R25	R25	A32	104
66374000	310 D 22 FK	9/14	V	6,5	9	80	950	153	R25	R25	A32	126
66647000	310 D 22 FK	7/20,1/10Halter	H	7	100	770	770	73			D20	150
66649000	310 D 22 FK	9/20,1/10Halter	H	9	100	780	780	46			D20	190
66569000	310 D 22 FK	10/20,1/10Halter	H	10	100	780	780	50			D20	210
66809000	310 D 22 FK	15/17,1/10Pl.	H	15	100	780	780	49			D21	265
66558000	310 D 22 FK	8/15		8	80	950	950	153	R25	R25	A32	120
66762000	310 D 22 FL	8/13	V	8	80	950	950	190	R25	R25	A32	104
66374000	310 D 22 FL	9/14	V	6,5	9	80	950	153	R25	R25	A32	126
66526000	310 D 22 FL	9/13	V	9	80	950	950	198	R25	R25	A32	117
66800000	310 D 22 FL	10/15	V	10	80	950	950	102	R25	R25	A11	150
66374000	310 D 22 FLL	9/14	V	6,5	9	80	950	153	R25	R25	A32	126
66526000	310 D 22 FLL	9/13	V	9	80	950	950	198	R25	R25	A32	117
66800000	310 D 22 FLL	10/15	V	10	80	950	950	102	R25	R25	A11	150
66570000	310 D 22 FS	8/13	V	8	80	950	950	225	R25	R25	A32	110
66762000	310 D 22 FS	8/13	V	8	80	950	950	190	R25	R25	A32	104
66374000	310 D 22 FS	9/14	V	6,5	9	80	950	153	R25	R25	A32	126
66526000	310 D 22 FS	9/13	V	9	80	950	950	198	R25	R25	A32	117
66647000	310 D 22 FS	7/20,1/10Halter	H	7	100	770	770	73			D20	150
66569000	310 D 22 FS	10/20,1/10Halter	H	10	100	780	780	50			D20	210
66815000	310 D 22 FS	7/16,1/10Pl.,3/20	H	10	100	950	950	155	R35	R35	A5	182
66429000	310 D 22 FS	13/9,2/15	H	15	100	580	850	79	R35	R35	A43	147
66779000	310 D 22 FS	13/9,2/15	H	15	100	580	850	103	R35	R35	A43	147
66433000	310 D 22 FS		H	16	100	580	850	62	R35	R35	A43	
66887000	310 D 22 FS	14/10,2/16	H	16	100	580	850	116	R35	R35	A43	172
66570000	310 D 22 FSL	8/13	V	8	80	950	950	225	R25	R25	A32	110
66526000	310 D 22 FSL	9/13	V	9	80	950	950	198	R25	R25	A32	117
66374000	310 D 22 K	9/14	V	6,5	9	80	950	153	R25	R25	A32	126
66647000	310 D 22 K	7/20,1/10Halter	H	7	100	770	770	73			D20	150
66569000	310 D 22 K	10/20,1/10Halter	H	10	100	780	780	50			D20	210
66374000	310 D 26 AK	9/14	V	6,5	9	80	950	153	R25	R25	A32	126

MAGIRUS-TYPEN

IVECO

MAGIRUS-TYPEN

Artikel.Nr.	Fahrzeugtyp	Info	Achsl.	Blattzahl	Breite	Lx/L1	Ly/L2	Spr./Kr.	Buchsen vorn	Buchsen hinten	Form	Paketstärke	
Art.-No.	Type		Axle Load	Leaves	Width			FreeArch/Crank	Bush front	Bush rear	Shape	Total height	
66572000	310 D 26 AK	10/15	V		10	80	900	1000	100	R25	R25	A11	150
66662000	310 D 26 AK	10/15	V		10	80	900	1000	147	R25		A11	150
66800000	310 D 26 AK	10/15	V		10	80	950	950	102	R25	R25	A11	150
66647000	310 D 26 AK	7/20,1/10Halter	H		7	100	770	770	73			D20	150
66649000	310 D 26 AK	9/20,1/10Halter	H		9	100	780	780	46			D20	190
66569000	310 D 26 AK	10/20,1/10Halter	H		10	100	780	780	50			D20	210
66657000	310 D 26 AK	13/20,1/10Halter	H		13	100	780	780	60			D20	270
66809000	310 D 26 AK	15/17,1/10Pl.	H		15	100	780	780	49			D21	265
66374000	310 D 26 AS	9/14	V	6,5	9	80	950	950	153	R25	R25	A32	126
66800000	310 D 26 AS	10/15	V		10	80	950	950	102	R25	R25	A11	150
66809000	310 D 26 AS	15/17,1/10Pl.	H		15	100	780	780	49			D21	265
66911000	310 D 26 AS	11/15,1/10Pl.,5/14	H		16	100	950	950	140	R35	R35	A4	245
66526000	310 D 26 F	9/13	V		9	80	950	950	198	R25	R25	A32	117
66647000	310 D 26 FAK	7/20,1/10Halter	H		7	100	770	770	73			D20	150
66569000	310 D 26 FAK	10/20,1/10Halter	H		10	100	780	780	50			D20	210
66657000	310 D 26 FAK	13/20,1/10Halter	H		13	100	780	780	60			D20	270
66374000	310 D 26 FB	9/14	V	6,5	9	80	950	950	153	R25	R25	A32	126
66649000	310 D 26 FB	9/20,1/10Halter	H		9	100	780	780	46			D20	190
66374000	310 D 26 FK	9/14	V	6,5	9	80	950	950	153	R25	R25	A32	126
66522000	310 D 26 FK	9/12	V		9	80	950	950	236	R25	R25	A32	108
66800000	310 D 26 FK	10/15	V		10	80	950	950	102	R25	R25	A11	150
66647000	310 D 26 FK	7/20,1/10Halter	H		7	100	770	770	73			D20	150
66649000	310 D 26 FK	9/20,1/10Halter	H		9	100	780	780	46			D20	190
66569000	310 D 26 FK	10/20,1/10Halter	H		10	100	780	780	50			D20	210
66657000	310 D 26 FK	13/20,1/10Halter	H		13	100	780	780	60			D20	270
66809000	310 D 26 FK	15/17,1/10Pl.	H		15	100	780	780	49			D21	265
66558000	310 D 26 FK	8/15			8	80	950	950	153	R25	R25	A32	120
66762000	310 D 26 FS	8/13	V		8	80	950	950	190	R25	R25	A32	104
66374000	310 D 26 FS	9/14	V	6,5	9	80	950	950	153	R25	R25	A32	126
66569000	310 D 26 FS	10/20,1/10Halter	H		10	100	780	780	50			D20	210
66587000	310 D 26 FS	7/12,1/10Pl.,4/16	H		11	100	950	950	250	R35	R35	A5	166
66374000	310 D 26 K	9/14	V	6,5	9	80	950	950	153	R25	R25	A32	126
66572000	310 D 26 K	10/15	V		10	80	900	1000	100	R25	R25	A11	150
66800000	310 D 26 K	10/15	V		10	80	950	950	102	R25	R25	A11	150
66569000	310 D 26 K	10/20,1/10Halter	H		10	100	780	780	50			D20	210
66809000	310 D 26 K	15/17,1/10Pl.	H		15	100	780	780	49			D21	265
66572000	310 D 26 S	10/15	V		10	80	900	1000	100	R25	R25	A11	150
66569000	310 D 26 S	10/20,1/10Halter	H		10	100	780	780	50			D20	210
66842000	310 D 28 FK	8/10,3/16	V		11	80	725	775	141	R25	R25	A6	128
66569000	310 D 28 FK	10/20,1/10Halter	H		10	100	780	780	50			D20	210
66657000	310 D 28 FK	13/20,1/10Halter	H		13	100	780	780	60			D20	270
66842000	310 D 28 FL	8/10,3/16	V		11	80	725	775	141	R25	R25	A6	128
66569000	310 D 28 FL	10/20,1/10Halter	H		10	100	780	780	50			D20	210
66662000	310 D 31 AS	10/15	V		10	80	900	1000	147	R25		A11	150
66569000	310 D 31 AS	10/20,1/10Halter	H		10	100	780	780	50			D20	210
66662000	310 D 32 AK	10/15	V		10	80	900	1000	147	R25		A11	150
66657000	310 D 32 AK	13/20,1/10Halter	H		13	100	780	780	60			D20	270
66662000	310 D 32 AS	10/15	V		10	80	900	1000	147	R25		A11	150
66657000	310 D 32 AS	13/20,1/10Halter	H		13	100	780	780	60			D20	270
66662000	310 D 32 K	10/15	V		10	80	900	1000	147	R25		A11	150
66657000	310 D 32 K	13/20,1/10Halter	H		13	100	780	780	60			D20	270
66572000	310 D 32 L	10/15	V		10	80	900	1000	100	R25	R25	A11	150
66657000	310 D 32 L	13/20,1/10Halter	H		13	100	780	780	60			D20	270
66662000	310 D 34 AS	10/15	V		10	80	900	1000	147	R25		A11	150
66657000	310 D 34 AS	13/20,1/10Halter	H		13	100	780	780	60			D20	270
66929000	310 D 34 AS	13/20,1/10Halter	H		13	100	815	815	41			D20	270
66658000	320 D 19 AK	9/14	V		9	80	950	950	160	R25	R25	A32	126

MAGIRUS-TYPEN

IVECO

MAGIRUS-TYPEN

Artikel.Nr.	Fahrzeugtyp	Info	Achsl.	Blattzahl	Breite	Lx/L1	Ly/L2	Spr./ Kr.	Buchsen vorn	Buchsen hinten	Form	Paket- stärke
Art.-No.	Type		Axle Load	Leaves	Width			FreeArch /Crank	Bush front	Bush rear	Shape	Total height
66891000	320 D 19 AK	6/14,1/10,3/20,1/10,4/16	H	13	100	950	950	172	R35	R35	A28	228
66658000	320 D 19 K	9/14	V	9	80	950	950	160	R25	R25	A32	126
66891000	320 D 19 K	6/14,1/10,3/20,1/10,4/16	H	13	100	950	950	172	R35	R35	A28	228
66570000	320 D 19 S	8/13	V	8	80	950	950	225	R25	R25	A32	110
66815000	320 D 19 S	7/16,1/10Pl.,3/20	H	10	100	950	950	155	R35	R35	A5	182
66572000	320 D 20 AS	10/15	V	10	80	900	1000	100	R25	R25	A11	150
66569000	320 D 20 AS	10/20,1/10Halter	H	10	100	780	780	50			D20	210
66374000	320 D 20 FA	9/14	V	9	80	950	950	153	R25	R25	A32	126
66647000	320 D 20 FA	7/20,1/10Halter	H	7	100	770	770	73			D20	150
66569000	320 D 20 FA	10/20,1/10Halter	H	10	100	780	780	50			D20	210
66572000	320 D 21 AL	10/15	V	10	80	900	1000	100	R25	R25	A11	150
66569000	320 D 21 AL	10/20,1/10Halter	H	10	100	780	780	50			D20	210
66570000	320 D 22 FS	8/13	V	8	80	950	950	225	R25	R25	A32	110
66429000	320 D 22 FS	13/9,2/15	H	15	100	580	850	79	R35	R35	A43	147
66779000	320 D 22 FS	13/9,2/15	H	15	100	580	850	103	R35	R35	A43	147
66658000	320 D 26 AK	9/14	V	9	80	950	950	160	R25	R25	A32	126
66572000	320 D 26 AK	10/15	V	10	80	900	1000	100	R25	R25	A11	150
66569000	320 D 26 AK	10/20,1/10Halter	H	10	100	780	780	50			D20	210
66809000	320 D 26 AK	15/17,1/10Pl.	H	15	100	780	780	49			D21	265
66658000	320 D 26 AL	9/14	V	9	80	950	950	160	R25	R25	A32	126
66572000	320 D 26 AL	10/15	V	10	80	900	1000	100	R25	R25	A11	150
66569000	320 D 26 AL	10/20,1/10Halter	H	10	100	780	780	50			D20	210
66526000	320 D 26 F	9/13	V	9	80	950	950	198	R25	R25	A32	117
66374000	320 D 26 FA	9/14	V	9	80	950	950	153	R25	R25	A32	126
66569000	320 D 26 FA	10/20,1/10Halter	H	10	100	780	780	50			D20	210
66658000	320 D 26 K	9/14	V	9	80	950	950	160	R25	R25	A32	126
66569000	320 D 26 K	10/20,1/10Halter	H	10	100	780	780	50			D20	210
66572000	320 D 26 S	10/15	V	10	80	900	1000	100	R25	R25	A11	150
66569000	320 D 26 S	10/20,1/10Halter	H	10	100	780	780	50			D20	210
66662000	320 D 32 AL	10/15	V	10	80	900	1000	147	R25		A11	150
66657000	320 D 32 AL	13/20,1/10Halter	H	13	100	780	780	60			D20	270
66662000	320 D 32 K	10/15	V	10	80	900	1000	147	R25		A11	150
66657000	320 D 32 K	13/20,1/10Halter	H	13	100	780	780	60			D20	270
66662000	320 D 34 AS	10/15	V	10	80	900	1000	147	R25		A11	150
66657000	320 D 34 AS	13/20,1/10Halter	H	13	100	780	780	60			D20	270
66662000	320 F 26 PAC	10/15	V	10	80	900	1000	147	R25		A11	150
66657000	320 F 26 PAC	13/20,1/10Halter	H	13	100	780	780	60			D20	270
66662000	320 F 26 PC	10/15	V	10	80	900	1000	147	R25		A11	150
66657000	320 F 26 PC	13/20,1/10Halter	H	13	100	780	780	60			D20	270
66662000	320 F 32 PAC	10/15	V	10	80	900	1000	147	R25		A11	150
66657000	320 F 32 PAC	13/20,1/10Halter	H	13	100	780	780	60			D20	270
66662000	320 F 32 PC	10/15	V	10	80	900	1000	147	R25		A11	150
66657000	320 F 32 PC	13/20,1/10Halter	H	13	100	780	780	60			D20	270
66662000	320 F 35 PAC	10/15	V	10	80	900	1000	147	R25		A11	150
66657000	320 F 35 PAC	13/20,1/10Halter	H	13	100	780	780	60			D20	270
66662000	320 F 35 PC	10/15	V	10	80	900	1000	147	R25		A11	150
66657000	320 F 35 PC	13/20,1/10Halter	H	13	100	780	780	60			D20	270
66720000	320 M 16 FL	11/10,1/12	V	11	90	900	900	282	35x45	35x45	A26	122
67262000	320 M 16 FL	11/10	V	11	90	900	900	280	35x45	35x45	A26	110
67213000	320 M 16 FL	6/15,1/10Zwlg.,9/11	H	15	90	900	900	175	35x45	35x45	A28	199
66722000	320 M 16 FLL	11/11	V	11	90	900	900		35	35	A26	121
67216000	320 M 16 FLS	13/10	V	13	90	900	900	255	35x45	35x45	A26	130
66720000	320 M 16 FS	11/10,1/12	V	11	90	900	900	282	35x45	35x45	A26	122
67262000	320 M 16 FS	11/10	V	11	90	900	900	280	35x45	35x45	A26	110
67213000	320 M 16 FS	6/15,1/10Zwlg.,9/11	H	15	90	900	900	175	35x45	35x45	A28	199
66658000	320 M 19 AK	9/14	V	9	80	950	950	160	R25	R25	A32	126
66911000	320 M 19 AK	11/15,1/10Pl.,5/14	H	16	100	950	950	140	R35	R35	A4	245

MAGIRUS-TYPEN
IVECO
MAGIRUS-TYPEN

Artikel.Nr.	Fahrzeugtyp	Info	Achsl.	Blattzahl	Breite	Lx/L1	Ly/L2	Spr./Kr.	Buchsen vorn	Buchsen hinten	Form	Paketstärke
Art.-No.	Type		Axle Load	Leaves	Width			FreeArch/Crank	Bush front	Bush rear	Shape	Total height
66790000	320 M 19 FAK	14/13	V	14	80	950	950	100	R25	R25	A32	182
66911000	320 M 19 FAK	11/15,1/10Pl.,5/14	H	16	100	950	950	140	R35	R35	A4	245
66790000	320 M 19 FK	14/13	V	14	80	950	950	100	R25	R25	A32	182
66891000	320 M 19 FK	6/14,1/10,3/20,1/10,4/16	H	13	100	950	950	172	R35	R35	A28	228
66911000	320 M 19 FK	11/15,1/10Pl.,5/14	H	16	100	950	950	140	R35	R35	A4	245
66790000	320 M 19 FKS	14/13	V	14	80	950	950	100	R25	R25	A32	182
66911000	320 M 19 FKS	11/15,1/10Pl.,5/14	H	16	100	950	950	140	R35	R35	A4	245
67214000	320 M 19 FL	2/13,5/14	V	7	90	900	900	178	35x45	35x45	A26	96
66716000	320 M 19 FL	8/13	V	8	90	900	900	186	35x45	35x45	A26	104
66720000	320 M 19 FL	11/10,1/12	V	11	90	900	900	282	35x45	35x45	A26	122
67262000	320 M 19 FL	11/10	V	11	90	900	900	280	35x45	35x45	A26	110
67216000	320 M 19 FL	13/10	V	13	90	900	900	255	35x45	35x45	A26	130
67213000	320 M 19 FL	6/15,1/10Zwlg.,9/11	H	15	90	900	900	175	35x45	35x45	A28	199
66722000	320 M 19 FLL	11/11	V	11	90	900	900		35	35	A26	121
67216000	320 M 19 FLL	13/10	V	13	90	900	900	255	35x45	35x45	A26	130
66704000	320 M 19 FS	9/14	V	9	80	950	950	123	R25	R25	A11	126
66718000	320 M 19 FS	11/10	V	11	90	900	900		35	35	A26	110
66720000	320 M 19 FS	11/10,1/12	V	11	90	900	900	282	35x45	35x45	A26	122
67262000	320 M 19 FS	11/10	V	11	90	900	900	280	35x45	35x45	A26	110
67216000	320 M 19 FS	13/10	V	13	90	900	900	255	35x45	35x45	A26	130
67213000	320 M 19 FS	6/15,1/10Zwlg.,9/11	H	15	90	900	900	175	35x45	35x45	A28	199
66891000	320 M 19 FS	6/14,1/10,3/20,1/10,4/16	H	13	100	950	950	172	R35	R35	A28	228
67262000	320 M 19 FSL	11/10	V	11	90	900	900	280	35x45	35x45	A26	110
67216000	320 M 19 FSL	13/10	V	13	90	900	900	255	35x45	35x45	A26	130
66658000	320 M 19 K	9/14	V	9	80	950	950	160	R25	R25	A32	126
66620000	320 M 19 K	14/13	V	14	80	900	1000	130	R25	R25	A32	182
66911000	320 M 19 K	11/15,1/10Pl.,5/14	H	16	100	950	950	140	R35	R35	A4	245
66658000	320 M 19 S	9/14	V	9	80	950	950	160	R25	R25	A32	126
66815000	320 M 19 S	7/16,1/10Pl.,3/20	H	10	100	950	950	155	R35	R35	A5	182
67216000	320 M 22 FLL	13/10	V	13	90	900	900	255	35x45	35x45	A26	130
67216000	320 M 22 FSL	13/10	V	13	90	900	900	255	35x45	35x45	A26	130
66658000	320 M 26 AK	9/14	V	9	80	950	950	160	R25	R25	A32	126
66790000	320 M 26 AK	14/13	V	14	80	950	950	100	R25	R25	A32	182
66569000	320 M 26 AK	10/20,1/10Halter	H	10	100	780	780	50			D20	210
66867000	320 M 26 AK	14/18,1/10Halter	H	14	100	780	780	50			D20	262
66704000	320 M 26 FAK	9/14	V	9	80	950	950	123	R25	R25	A11	126
66868000	320 M 26 FAK	10/15	V	10	80	950	950	90	R25	R25	A11	150
66790000	320 M 26 FAK	14/13	V	14	80	950	950	100	R25	R25	A32	182
66569000	320 M 26 FAK	10/20,1/10Halter	H	10	100	780	780	50			D20	210
66867000	320 M 26 FAK	14/18,1/10Halter	H	14	100	780	780	50			D20	262
66800000	320 M 26 FK	10/15	V	10	80	950	950	102	R25	R25	A11	150
66790000	320 M 26 FK	14/13	V	14	80	950	950	100	R25	R25	A32	182
66867000	320 M 26 FK	14/18,1/10Halter	H	14	100	780	780	50			D20	262
66790000	320 M 26 FKL	14/13	V	14	80	950	950	100	R25	R25	A32	182
66790000	320 M 26 FKL	14/13	V	14	80	950	950	100	R25	R25	A32	182
66867000	320 M 26 FKL	14/18,1/10Halter	H	14	100	780	780	50			D20	262
66867000	320 M 26 FKL	14/18,1/10Halter	H	14	100	780	780	50			D20	262
66658000	320 M 26 FKS	9/14	V	9	80	950	950	160	R25	R25	A32	126
66658000	320 M 26 FKS	9/14	V	9	80	950	950	160	R25	R25	A32	126
66704000	320 M 26 FKS	9/14	V	9	80	950	950	123	R25	R25	A11	126
66704000	320 M 26 FKS	9/14	V	9	80	950	950	123	R25	R25	A11	126
66790000	320 M 26 FKS	14/13	V	14	80	950	950	100	R25	R25	A32	182
66790000	320 M 26 FKS	14/13	V	14	80	950	950	100	R25	R25	A32	182
66867000	320 M 26 FKS	14/18,1/10Halter	H	14	100	780	780	50			D20	262
66867000	320 M 26 FKS	14/18,1/10Halter	H	14	100	780	780	50			D20	262
66658000	320 M 26 K	9/14	V	9	80	950	950	160	R25	R25	A32	126
66620000	320 M 33 AK	14/13	V	14	80	900	1000	130	R25	R25	A32	182

MAGIRUS-TYPEN

IVECO

MAGIRUS-TYPEN

Artikel.Nr.	Fahrzeugtyp	Info	Achsl.	Blattzahl	Breite	Lx/L1	Ly/L2	Spr./ Kr.	Buchsen vorn	Buchsen hinten	Form	Paket- stärke
Art.-No.	Type		Axle Load	Leaves	Width			FreeArch /Crank	Bush front	Bush rear	Shape	Total height
66919000	320 M 33 AK	18/18,1/10Halter	H	18	100	780	780	41			D20	334
66790000	320 M 33 FK	14/13	V	14	80	950	950	100	R25	R25	A32	182
66919000	320 M 33 FK	18/18,1/10Halter	H	18	100	780	780	41			D20	334
66620000	320 M 33 K	14/13	V	14	80	900	1000	130	R25	R25	A32	182
66919000	320 M 33 K	18/18,1/10Halter	H	18	100	780	780	41			D20	334
66620000	320 M 33 L	14/13	V	14	80	900	1000	130	R25	R25	A32	182
66919000	320 M 33 L	18/18,1/10Halter	H	18	100	780	780	41			D20	334
66762000	340 D 16 FL	8/13	V	8	80	950	950	190	R25	R25	A32	104
66526000	340 D 16 FL	9/13	V	9	80	950	950	198	R25	R25	A32	117
66731000	340 D 16 FL	5/14,1/10Pl.,2/20,1/20Pl.,3/14	H	10	100	950	950	199	R35	R35	A28	182
66526000	340 D 22 FL	9/13	V	9	80	950	950	198	R25		A32	117
66429000	340 D 22 FL	13/9,2/15	H	15	100	580	850	79	R35	2	A43	147
66779000	340 D 22 FL	13/9,2/15	H	15	100	580	850	103	R35		A43	147
66526000	340 D 22 FLL	9/13	V	9	80	950	950	198	R25		A32	117
66526000	340 D 22 FS	9/13	V	9	80	950	950	198	R25		A32	117
66429000	340 D 22 FS	13/9,2/15	H	15	100	580	850	79	R35	2	A43	147
66779000	340 D 22 FS	13/9,2/15	H	15	100	580	850	103	R35		A43	147
66570000	340 D 22 FSL	8/13	V	8	80	950	950	225	R25		A32	110
66526000	340 D 22 FSL	9/13	V	9	80	950	950	198	R25		A32	117
66800000	350 F 26 PC	10/15	V	10	80	950	950	102	R25	R25	A11	150
66569000	350 F 26 PC	10/20,1/10Halter	H	10	100	780	780	50			D20	210
66800000	350 F 26 PT	10/15	V	10	80	950	950	102	R25	R25	A11	150
66569000	350 F 26 PT	10/20,1/10Halter	H	10	100	780	780	50			D20	210
66800000	350 F 33 PC	10/15	V	10	80	950	950	102	R25	R25	A11	150
66657000	350 F 33 PC	13/20,1/10Halter	H	13	100	780	780	60			D20	270
66800000	350 F 33 PT	10/15	V	10	80	950	950	102	R25	R25	A11	150
66790000	350 F 33 PT	14/13	V	14	80	950	950	100	R25	R25	A32	182
66919000	350 F 33 PT	18/18,1/10Halter	H	18	100	780	780	41			D20	334
66526000	360 D 18 FL	9/13	V	9	80	950	950	198	R25	R25	A32	117
66815000	360 D 18 FL	7/16,1/10Pl.,3/20	H	10	100	950	950	155	R35	R35	A5	182
66871000	360 D 18 FL	6/14,1/20Pl.,3/20,1/10Pl.,4/14	H	13	100	950	950	194	R35	R35	A28	230
66526000	360 D 18 FS	9/13	V	9	80	950	950	198	R25	R25	A32	117
66815000	360 D 18 FS	7/16,1/10Pl.,3/20	H	10	100	950	950	155	R35	R35	A5	182
66662000	360 D 34 AS	10/15	V	10	80	900	1000	147	R25		A11	150
66657000	360 D 34 AS	13/20,1/10Halter	H	13	100	780	780	60			D20	270
66976000	360 M 19 FL	4/20,1/10Pl.	V	4	90	900	900	213	35x45	35x45	A19	102
66716000	360 M 19 FL	8/13	V	8	90	900	900	186	35x45	35x45	A26	104
66961000	360 M 19 FL	4/21,1/21Pl.,1/10Pl.,3/20	H	7	90	900	900	189	35x45	35x45	A2	202
67213000	360 M 19 FL	6/15,1/10Zwlg.,9/11	H	15	90	900	900	175	35x45	35x45	A28	199
66976000	360 M 19 FS	4/20,1/10Pl.	V	4	90	900	900	213	35x45	35x45	A19	102
66718000	360 M 19 FS	11/10	V	11	90	900	900		35	35	A26	110
67216000	360 M 19 FS	13/10	V	13	90	900	900	255	35x45	35x45	A26	130
66961000	360 M 19 FS	4/21,1/21Pl.,1/10Pl.,3/20	H	7	90	900	900	189	35x45	35x45	A2	202
67213000	360 M 19 FS	6/15,1/10Zwlg.,9/11	H	15	90	900	900	175	35x45	35x45	A28	199
66976000	360 M 22 FL	4/20,1/10Pl.	V	4	90	900	900	213	35x45	35x45	A19	102
66976000	360 M 22 FL	4/20,1/10Pl.	V	4	90	900	900	213	35x45	35x45	A19	102
66976000	360 M 22 FL	4/20,1/10Pl.	V	4	90	900	900	213	35x45	35x45	A19	102
67216000	360 M 22 FL	13/10	V	13	90	900	900	255	35x45	35x45	A26	130
67216000	360 M 22 FL	13/10	V	13	90	900	900	255	35x45	35x45	A26	130
67216000	360 M 22 FL	13/10	V	13	90	900	900	255	35x45	35x45	A26	130
66620000	400 M 33 AS	14/13	V	14	80	900	1000	130	R25	R25	A32	182
66929000	400 M 33 AS	13/20,1/10Halter	H	13	100	815	815	41			D20	270

Artikel.Nr.	Fahrzeugtyp	Info	Achsl.	Blattzahl	Breite	Lx/L1	Ly/L2	Spr./Kr.	Buchsen vorn	Buchsen hinten	Form	Paketstärke
Art.-No.	Type		Axle Load	Leaves	Width			FreeArch/Crank	Bush front	Bush rear	Shape	Total height
67273000	28.8	3/9,2/15	H		60	700	715	153	16x38	24x30	E2	57
67295000	28.8	3/9,2/15	H		60	700	715	153	16x38	24x38	E2	57
67275000	28.8	4/9,2/15	H	3,2	60	700	715	160	16x38	24x30	E2	66
67297000	28.8	3/9,2/15	H		60	700	715	160	16x38	24x38	E2	66
67283000	28.8	4/9,3/15	H		60	700	715	132	16	16	E2	
67285000	28.8	4/9,3/15	H		60	700	715	132	16x38	24x30	E2	81
67273000	32.8	3/9,2/15	H		60	700	715	153	16x38	24x30	E2	57
67295000	32.8	3/9,2/15	H		60	700	715	153	16x38	24x38	E2	57
67275000	32.8	4/9,2/15	H	3,2	60	700	715	160	16x38	24x30	E2	66
67297000	32.8	3/9,2/15	H		60	700	715	160	16x38	24x38	E2	66
67279000	35.10 RESTYL.	4/9,2/15	H	3,2-3,6	60	700	715	172	16x38	24x30	E2	66
67281000	35.10 RESTYL.	4/9,2/15	H	2,8	60	700	715	130	16x38	24x30	E2	66
67285000	35.10 RESTYL.	4/9,3/15	H		60	700	715	132	16x38	24x30	E2	81
67279000	35.10 TURBO	4/9,2/15	H	3,2-3,6	60	700	715	172	16x38	24x30	E2	66
67281000	35.10 TURBO	4/9,2/15	H	2,8	60	700	715	130	16x38	24x30	E2	66
67285000	35.10 TURBO	4/9,3/15	H		60	700	715	132	16x38	24x30	E2	81
67277000	35.8	4/9,2/15	H	3,2	60	700	715	172	16x38	24x38	E2	66
67279000	35.8	4/9,2/15	H	3,2-3,6	60	700	715	172	16x38	24x30	E2	66
67281000	35.8	4/9,2/15	H	2,8	60	700	715	130	16x38	24x30	E2	66
67283000	35.8	4/9,3/15	H		60	700	715	132	16	16	E2	
67285000	35.8 35.8 H	4/9,3/15	H		60	700	715	132	16x38	24x30	E2	81
67290000	35.8 H	4/10	V		60	650	680	67	16x38	24x30	E1	40
67279000	35.8 RESTYL.	4/9,2/15	H	3,2-3,6	60	700	715	172	16x38	24x30	E2	66
67281000	35.8 RESTYL.	4/9,2/15	H	2,8	60	700	715	130	16x38	24x30	E2	66
67285000	35.8 RESTYL.	4/9,3/15	H		60	700	715	132	16x38	24x30	E2	81
67109000	40.10	4/9,3/16	H		60	700	715	142	16x39	24x30	E2	84
67279000	40.10 TURBO	4/9,2/15	H	3,2-3,6	60	700	715	172	16x38	24x30	E2	66
67285000	40.10 TURBO	4/9,3/15	H		60	700	715	132	16x38	24x30	E2	81
67101000	40.10 W M	4/9,3/15	H		60	700	715	125	16x39	24x30	E2	84
67277000	40.8	4/9,2/15	H	3,2	60	700	715	172	16x38	24x38	E2	66
67279000	40.8	4/9,2/15	H	3,2-3,6	60	700	715	172	16x38	24x30	E2	66
67283000	40.8	4/9,3/15	H		60	700	715	132	16	16	E2	
67285000	40.8	4/9,3/15	H		60	700	715	132	16x38	24x30	E2	81
67290000	40.8 H	4/10	V		60	650	680	67	16x38	24x30	E1	40
67285000	40.8 H	4/9,3/15	H		60	700	715	132	16x38	24x30	E2	81
67285000	40.8 RESTYL.	4/9,3/15	H		60	700	715	132	16x38	24x30	E2	81
66989000	45.10	4/9,3/15	H		60	700	715	140	16x39	24x30	E2	81
66989000	45.10 RESTYL.	4/9,3/15	H		60	700	715	140	16x39	24x30	E2	81
67109000	49.10	4/9,3/16	H		60	700	715	142	16x39	24x30	E2	84
67227000	49.10	4/9,3/16	H		60	700	715	140	16x38	24x30	E2	84
67227000	49.10 RESTYL.	4/9,3/16	H		60	700	715	140	16x38	24x30	E2	84
67208000	50.10	1/10,3/11,1/13	V		70	705	705	112	24x30	24x30	A1	56
67215000	50.10	4/11,3/14	H		70	715	715	111	24x30	24x30	A5	86
67208000	50.8	1/10,3/11,1/13	V		70	705	705	112	24x30	24x30	A1	56
67215000	50.8	4/11,3/14	H		70	715	715	111	24x30	24x30	A5	86
67292000	50.9 ZETA	2/18,1/7PI.	V		70	705	705	93	16x40	16x40	A1	49
67293000	50.9 ZETA	2/19,1/35PI.,1/17,1/25PI.	H		70	710	830	116	16x40		B13	121
67208000	55.10	1/10,3/11,1/13	V		70	705	705	112	24x30	24x30	A1	56
67215000	55.10	4/11,3/14	H		70	715	715	111	24x30	24x30	A5	86
67208000	55.8	1/10,3/11,1/13	V		70	705	705	112	24x30	24x30	A1	56
67215000	55.8	4/11,3/14	H		70	715	715	111	24x30	24x30	A5	86
67208000	55.9	1/10,3/11,1/13	V		70	705	705	112	24x30	24x30	A1	56
67215000	55.9	4/11,3/14	H		70	715	715	111	24x30	24x30	A5	86
67151000	59.12	3/14,1/22	H		70	700	715	133			E2	64
67181000	59.12	4/11,2/18	H		70	700	715	123	16x40		E2	80
67155000	59.12 PNEUMATICO	1/39,1/10	L		70	700/229	340/90	44/236			L19	58

Artikel.Nr.	Fahrzeugtyp	Info	Achsl.	Blattzahl	Breite	Lx/L1	Ly/L2	Spr./ Kr.	Buchsen vorn	Buchsen hinten	Form	Paket- stärke
Art.-No.	Type		Axle Load	Leaves	Width			FreeArch /Crank	Bush front	Bush rear	Shape	Total height
67208000	60.10	1/10,3/11,1/13	V	5	70	705	705	112	24x30	24x30	A1	56
67217000	60.10	5/11,3/14	H	8	70	715	715	96	24x30	24x30	A5	97
66974000	60.11 TURBO ZETA	2/18,1/7Pl.	V	2	70	705	705	92	16x40	16x40	A1	49
67228000	60.11 TURBO ZETA	6/10	V	6	70	705	705	91	16x40	16x40	A1	60
67289000	60.11 TURBO ZETA	2/21,1/35Pl.,1/22,1/25Pl.	H	3	70	710	830	120	16x40		B13	130
67229000	60.11 TURBO ZETA	7/11,1/20Pl.,3/11	H	10	70	710	830	133	16x40		B13	130
67208000	60.8	1/10,3/11,1/13	V	5	70	705	705	112	24x30	24x30	A1	56
67217000	60.8	5/11,3/14	H	8	70	715	715	96	24x30	24x30	A5	97
67212000	65.10	5/10,2/14	V	7	70	705	705	104	24x30	24x30	A5	80
67220000	65.10	5/10,2/14	V	12	70	705	705	150	24x30	24x30	A5	80
66469000	65.10	4/12+2/21	H	6	70	710	710	145	24	24		
67221000	65.10	5/11/2/10,2/11Pl.,7/7	H	14	70	710	710	165	24x30	24x30	A28	146
66974000	65.12 TURBO ZETA	2/18,1/7Pl.	V	2	70	705	705	92	16x40	16x40	A1	49
67228000	65.12 TURBO ZETA	6/10	V	6	70	705	705	91	16x40	16x40	A1	60
67289000	65.12 TURBO ZETA	2/21,1/35Pl.,1/22,1/25Pl.	H	3	70	710	830	120	16x40		B13	130
67229000	65.12 TURBO ZETA	7/11,1/20Pl.,3/11	H	10	70	710	830	133	16x40		B13	130
67228000	65.9 ZETA	6/10	V	6	70	705	705	91	16x40	16x40	A1	60
67229000	65.9 ZETA	7/11,1/20Pl.,3/11	H	10	70	710	830	133	16x40		B13	130
67212000	70.10	5/10,2/14	V	7	70	705	705	104	24x30	24x30	A5	80
67212000	70.10	5/10,2/14	V	7	70	705	705	104	24x30	24x30	A5	80
67221000	70.10	5/11/2/10,2/11Pl.,7/7	H	14	70	710	710	165	24x30	24x30	A28	146
67221000	70.10	5/11/2/10,2/11Pl.,7/7	H	14	70	710	710	165	24x30	24x30	A28	146
66700000	75 D 6 FL	3/8,6/7	V	9	60	640	640	180	R34	24x34	A26	64
66701000	75 D 6 FL	9/10,1/4Pl.,1/9,2/8	H	12	60	740	835	183	28x48		B13	119
66771000	75 D 6 FL	2/11,7/10,1/4Pl.,3/9	H	12	60	740	820	186	R48		B7	123
66978000	75.13 AWM	3/18	V	3	80	775	775	147	R25	R25	A11	72
66940000	75.13 AWM	8/10	V	8	80	775	775	140	R25	R25	A32	80
66945000	75.13 AWM		H	7	80	800	990	105	30		B14	127
66941000	75.13 AWM	8/10,1/20Pl.,5/8	H	13	80	775	775	150	R25	R25	A28	140
66972000	75.16 A FEUERWEHR/T HW	2/20,1/15Pl.	V	2	70	785	940	140	22x28		B11	64
66930000	75.16 A FEUERWEHR/T HW	2/22	V	2	80	775	775	124			A20	53
67256000	75.16 A FEUERWEHR/THW	2/21+3/3	V	2	80	775	775				A20	51
67212000	79.10	5/10,2/14	V	7	70	705	705	104	24x30	24x30	A5	80
67222000	79.10	6/10,2/14	V	8	70	707	707	135	24x30	24x30	A5	90
66917000	79.10	6/11,2/12,1/Pl.,9/7,1/Pl.	H	17	70	710	710		24	24	A30	
67268000	79.12 TURBO ZETA	2/20,1/13	V	2	70	705	705	92	16x40	16x40	A20	59
67287000	79.12 TURBO ZETA	2/23,1/35Pl.,1/25,1/25Pl.	H	3	70	710	830	128	16x40		B13	137
67208000	79.13	1/10,3/11,1/13	V	5	70	705	705	112	24x30	24x30	A1	56
67212000	79.13	5/10,2/14	V	7	70	705	705	104	24x30	24x30	A5	80
67222000	79.13	6/10,1/2Lg.,2/14	V	8	70	707	707	135	24x30	24x30	A5	90
66728000	79.13	7/10,2/13,2/14Pl.	V	9	70	725	685	119	24x30	24x30	E1	126
66487000	79.13	6/11,2/12,Pl.,2/8,6/7	H	16	70	750	750	150			A4	
66917000	79.13	6/11,2/12,1/Pl.,9/7,1/Pl.	H	17	70	710	710		24	24	A30	
67268000	79.14	2/20,1/13	V	2	70	705	705	92	16x40	16x40	A20	59
67222000	79.14	6/10,1/2Lg.,2/14	V	8	70	707	707	135	24x30	24x30	A5	90
67269000	79.14	3/23,1/7Pl.	H	3	70	710	830	115	16x40		B11	85
67287000	79.14	2/23,1/35Pl.,1/25,1/25Pl.	H	3	70	710	830	128	16x40		B13	137
66917000	79.14	6/11,2/12,1/Pl.,9/7,1/Pl.	H	17	70	710	710		24	24	A30	
67268000	79.14 ZETA	2/20,1/13	V	2	70	705	705	92	16x40	16x40	A20	59
67269000	79.14 ZETA	3/23,1/7Pl.	H	3	70	710	830	115	16x40		B11	85
67287000	79.14 ZETA	2/23,1/35Pl.,1/25,1/25Pl.	H	3	70	710	830	128	16x40		B13	137

80

IVECO

100

Artikel.Nr.	Fahrzeugtyp	Info	Achsl.	Blattzahl	Breite	Lx/L1	Ly/L2	Spr./Kr.	Buchsen vorn	Buchsen hinten	Form	Paketstärke
Art.-No.	Type		Axle Load	Leaves	Width			FreeArch/Crank	Bush front	Bush rear	Shape	Total height
67222000	80.13	6/10,1/2Lg.,2/14	V	8	70	707	707	135	24x30	24x30	A5	90
66487000	80.13	6/11,2/12,Pl.,2/8,6/7	H	16	70	750	750	150			A4	
66972000	80.13 A	2/20,1/15Pl.	V	2	70	785	940	140	22x28		B11	64
66476000	80.13 A	6/10,2/11	V	8	70	785	940	140	22x28		B1.11	82
67272000	80.13 A		V	8	80						A1	
66497700	80.13 A	3/10,3/11,3/15	H	9	70	700	880	134	25x32		B15	108
66619000	80.13 A		H	14	70	570	680	95	25x32		B14	
66941000	80.13 A	8/10,1/20Pl.,5/8	H	13	80	775	775	150	R25	R25	A28	140
66972000	80.13 ABP	2/20,1/15Pl.	V	2	70	785	940	140	22x28		B11	64
67207000	80.13A	3/10,3/11,3/15	H	9	70	700	880	164	25x32		B15	108
66476000	80.13A2	6/10,2/11	V	8	70	785	940	140	22x28		B1.11	82
66497700	80.13A2	3/10,3/11,3/15	H	9	70	700	880	134	25x32		B15	108
66972000	80.13A3	2/20,1/15Pl.	V	2	70	785	940	140	22x28		B11	64
66497700	80.13A3	3/10,3/11,3/15	H	9	70	700	880	134	25x32		B15	108
66619000	80.13A3		H	14	70	570	680	95	25x32		B14	
67207000	80.13ABP	3/10,3/11,3/15	H	9	70	700	880	164	25x32		B15	108
66972000	80.13AW	2/20,1/15Pl.	V	2	70	785	940	140	22x28		B11	64
67272000	80.13AW		V	8	80						A1	
67207000	80.13AW	3/10,3/11,3/15	H	9	70	700	880	164	25x32		B15	108
66619000	80.13AW		H	14	70	570	680	95	25x32		B14	
66941000	80.13AW	8/10,1/20Pl.,5/8	H	13	80	775	775	150	R25	R25	A28	140
66972000	80.16 A	2/20,1/15Pl.	V	2	70	785	940	140	22x28		B11	64
66476000	80.16 A	6/10,2/11	V	8	70	785	940	140	22x28		B1.11	82
66497700	80.16 A	3/10,3/11,3/15	H	9	70	700	880	134	25x32		B15	108
67207000	80.16 A	3/10,3/11,3/15	H	9	70	700	880	164	25x32		B15	108
66940000	80.16 AW	8/10	V	8	80	775	775	140	R25	R25	A32	80
66941000	80.16 AW	8/10,1/20Pl.,5/8	H	13	80	775	775	150	R25	R25	A28	140
66972000	80.16A4	2/20,1/15Pl.	V	2	70	785	940	140	22x28		B11	64
66940000	80.16A4	8/10	V	8	80	775	775	140	R25	R25	A32	80
67207000	80.16A4	3/10,3/11,3/15	H	9	70	700	880	164	25x32		B15	108
66941000	80.16A4	8/10,1/20Pl.,5/8	H	13	80	775	775	150	R25	R25	A28	140
67222000	90.13	6/10,1/2Lg.,2/14	V	8	70	707	707	135	24x30	24x30	A5	90
66487000	90.13	6/11,2/12,Pl.,2/8,6/7	H	16	70	750	750	150			A4	
66917000	90.13	6/11,2/12,1/Pl.,9/7,1/Pl.	H	17	70	710	710		24	24	A30	
66972000	90.13 A	2/20,1/15Pl.	V	2	70	785	940	140	22x28		B11	64
66982000	90.13 A	2/22	V	2	70	785	940	96	22x28		B1.11	47
66476000	90.13 A	6/10,2/11	V	8	70	785	940	140	22x28		B1.11	82
66497700	90.13 A	3/10,3/11,3/15	H	9	70	700	880	134	25x32		B15	108
67207000	90.13 A	3/10,3/11,3/15	H	9	70	700	880	164	25x32		B15	108
66467000	90.13 A	4/10,4/11,3/15	H	11	70	700	880	140	25x36		B15	129
67256000	90.16 AW	2/21+3/3mm	V	2	80	775	775				A20	51
67257000	90.16 AW		H	5	80						A1	75
67258000	95.14 ZETA	2/20	V	2	70	780	780	134	24x30	24x30	A1	46
67259000	95.14 ZETA	3/19,1/25Pl.,2/17,1/25Pl.	H	5	80	810	950	150	24x30		B13	156
66728000	100.13	7/10,2/13,2/14Pl.	V	9	70	725	685	119	24x30	24x30	E1	126
66319000	100.13	10/11,1/10Pl.,1/22Pl.,7/8	H	17	80	715	715	115	24x30	24x30	A66	198
66317000	100.13	8/11,2/12,1/15,2/9,9/7	H	21	80	717	703	96	24x30	24x30	A66	208

110

IVECO

120

Artikel.Nr.	Fahrzeugtyp	Info	Achsl.	Blattzahl	Breite	Lx/L1	Ly/L2	Spr./ Kr.	Buchsen vorn	Buchsen hinten	Form	Paket- stärke
Art.-No.	Type		Axle Load	Leaves	Width			FreeArch /Crank	Bush front	Bush rear	Shape	Total height
67242000	109.14 ZETA	2/21,1/6Pl.	V	2	70	780	780	114	24x30	24x30	A1	54
67243000	109.14 ZETA	3/21,1/25Pl,2/19,1/25Pl.	H	5	80	810	950	149	24x30		B13	166
67244000	110.13 A	3/18,1/25Pl.	V	3	80	785	940	150	25x32		B11	79
66664000	110.13 A	6/10,2/11,1/16Pl.	V	8	80	785	950	177	25x32		B1.11	98
66484000	110.13 A	7/10,2/22,1/16Pl.	V	9	80	785	945	190	25x32		B15	108
66949000	110.13 A	4/15,1/10,3/19	H	7	80	800	990	105	30x36		B14	127
66627000	110.13 A	15/9	H	15	80	570	680	100	30x36		B14	135
66732000	110.14	2/11,5/14	V	7	70	800	800	90	28x35	28x35	E3	92
67245000	110.14	9/12,1/10,9/10	H	18	80	775	775	121	24x30	24x30	A28	208
67244000	110.16 A	3/18,1/25Pl.	V	3	80	785	940	150	25x32		B11	79
66664000	110.16 A	6/10,2/11,1/16Pl.	V	8	80	785	950	177	25x32		B1.11	98
66949000	110.16 A	4/15,1/10,3/19	H	7	80	800	990	105	30x36		B14	127
66627000	110.16 A	15/9	H	15	80	570	680	100	30x36		B14	135
66706000	110.16 AWM		V	11	80	850	1005	171	R25		B1.11	
66792000	110.16 AWM	3/11,9/10	V	12	80	850	1005		25x32		B1.11	123
66909000	110.16 AWM	8/16,1/10Pl.,2.Lagem.Haken	H	8	80	800	990	125	30x36		B14	138
66664000	110.17 AM	6/10,2/11,1/16Pl.	V	8	80	785	950	177	25x32		B1.11	98
66949000	110.17 AM	4/15,1/10,3/19	H	7	80	800	990	105	30x36		B14	127
66706000	110.17 AW		V	11	80	850	1005	171	R25		B1.11	
66909000	110.17 AW	8/16,1/10Pl.,2.Lagem.Haken	H	8	80	800	990	125	30x36		B14	138
66784000	110.17 AWM	4/18+1/10Pl.	V	4	80	850	1005		25x32		B1.11	
66706000	110.17 AWM		V	11	80	850	1005	171	R25		B1.11	
67247000	110.17 AWM	7/11,1/11Pl.,7/12	H	14	80	800	990	170	30x36		B13	172
66706000	110.17 W		V	11	80	850	1005	171	R25		B1.11	
66792000	110.17 W	3/11,9/10	V	12	80	850	1005		25x32		B1.11	123
66909000	110.17 W	8/16,1/10Pl.,2.Lagem.Haken	H	8	80	800	990	125	30x36		B14	138
66966000	115.14	2/26,P/26	V	2	70	900	900	119	34x42	34	A1	85
67249000	115.14	3/24,1/26Pl.,1/23	H	4	80	900	1050	135	28		B13	139
66965000	115.14	3/24,1/8Pl.,2/19	H	5	80	900	1050	135	28x35		B13	139
66966000	115.17	2/26,P/26	V	2	70	900	900	119	34x42	34	A1	85
67226000	115.17	2/11,1/13,4/15	V	7	70	800	800	98	22x29	22x29	E3	95
67236000	115.17	2/10,1/13,4/15	V	7	70	800	800	106	22x29	22x29	E3	93
67249000	115.17	3/24,1/26Pl.,1/23	H	4	80	900	1050	135	28		B13	139
66965000	115.17	3/24,1/8Pl.,2/19	H	5	80	900	1050	135	28x35		B13	139
67235000	115.17	1/10,7/13,1/7Pl.,7/10	H	15	80	750	750	156	24x30	24x30	A28	178
66820000	120.13 ANW	7/11	V	7	80	840	840	204	R25	R25	A32	77
66900000	120.13 ANW	10/10	V	10	80	840	840	186	R25	R25	A11	100
66819000	120.13 ANW	8/13,1/P,3/13	H	11	100	900	900	165	R30	R30	A4	163
66529000	120.13 ANW	10,1,4	H	14	100	900	900	137	R30	R30	A4	
67232000	120.14	2/10,2/12,3/14,1/8	V	7	70	800	800	109	22x29	22x29	E1	94
67233000	120.14	2/11,4/15,1/8:3/10,4/11	H	13	80	800	800	146	24x30	24x30	A28	164
66820000	120.16 ANW	7/11	V	7	80	840	840	204	R25	R25	A32	77
66768000	120.16 ANW	8/11	V	8	80	840	840	202	R25	R25	A32	88
66819000	120.16 ANW	8/13,1/P,3/13	H	11	100	900	900	165	R30	R30	A4	163
66820000	120.17 ANW	7/11	V	7	80	840	840	204	R25	R25	A32	77
66768000	120.17 ANW	8/11	V	8	80	840	840	202	R25	R25	A32	88
66819000	120.17 ANW	8/13,1/P,3/13	H	11	100	900	900	165	R30	R30	A4	163
66822000	120.19 A	10/11	V	10	80	840	840	167	R25	R25	A32	110
66787000	120.19 A	8/18	H	8	100	900	900	45	R30	R30	A26	144
66822000	120.23 AW	10/11	V	10	80	840	840	167	R25	R25	A32	110
66787000	120.23 AW	8/18	H	8	100	900	900	45	R30	R30	A26	144
66738000	120.25 AN	9/11	V	9	80	840	840		R25	R25	A11	99
66787000	120.25 AN	8/18	H	8	100	900	900	45	R30	R30	A26	144
66822000	120.25 AW	10/11	V	10	80	840	840	167	R25	R25	A32	110
66787000	120.25 AW	8/18	H	8	100	900	900	45	R30	R30	A26	144

Artikel.Nr.	Fahrzeugtyp	Info	Achsl.	Blattzahl	Breite	Lx/L1	Ly/L2	Spr./Kr.	Buchsen vorn	Buchsen hinten	Form	Paketstärke
Art.-No.	Type		Axle Load	Leaves	Width			FreeArch/Crank	Bush front	Bush rear	Shape	Total height
67244000	130.13 A	3/18,1/25Pl.	V	3	80	785	940	150	25x32		B11	79
66484000	130.13 A	7/10,2/22,1/16Pl.	V	9	80	785	945	190	25x32		B15	108
66949000	130.13 A	4/15,1/10,3/19	H	7	80	800	990	105	30x36		B14	127
66822000	130.13 AN	10/11	V	10	80	840	840	167	R25	R25	A32	110
66529000	130.13 AN	10,1,4	H	14	100	900	900	137	R30	R30	A4	
67244000	130.16 A	3/18,1/25Pl.	V	3	80	785	940	150	25x32		B11	79
66484000	130.16 A	7/10,2/22,1/16Pl.	V	9	80	785	945	190	25x32		B15	108
66949000	130.16 A	4/15,1/10,3/19	H	7	80	800	990	105	30x36		B14	127
66966000	135.14	2/26,P/26	V	2	70	900	900	119	34x42	34	A1	85
67226000	135.14	2/11,1/13,4/15	V	7	70	800	800	98	22x29	22x29	E3	95
67236000	135.14	2/10,1/13,4/15	V	7	70	800	800	106	22x29	22x29	E3	93
67248000	135.14	2/12,5/15	V	7	70	800	800				E3	99
66965000	135.14	3/24,1/8Pl.,2/19	H	5	80	900	1050	135	28x35		B13	139
67235000	135.14	1/10,7/13,1/7Pl.,7/10	H	15	80	750	750	156	24x30	24x30	A28	178
66966000	135.17	2/26,P/26	V	2	70	900	900	119	34x42	34	A1	85
67226000	135.17	2/11,1/13,4/15	V	7	70	800	800	98	22x29	22x29	E3	95
67236000	135.17	2/10,1/13,4/15	V	7	70	800	800	106	22x29	22x29	E3	93
67248000	135.17	2/12,5/15	V	7	70	800	800				E3	99
66965000	135.17	3/24,1/8Pl.,2/19	H	5	80	900	1050	135	28x35		B13	139
66967000	135.17	2/28,1/8Pl.,3/20	H	5	80	900	1050	136	28x35		B13	145
67235000	135.17	1/10,7/13,1/7Pl.,7/10	H	15	80	750	750	156	24x30	24x30	A28	178
67238000	135.17 T	2/24,1/24Pl.	V	2	70	900	900	131	34x42	34x42	A1	78
67237000	135.17 T	3/24,1/8Pl.,2/19	H	5	80	900	1050	135	28x35		B13	133
67218000	140.14	2/11,8/13	V	10	70	800	800	125	34x42	34x42	E3	126
66732000	140.20	2/11,5/14	V	7	70	800	800	90	28x35	28x35	E3	92
67209000	140.20	2/11,4/15,1/8Pl.,9/11	H	15	80	800	800	155	28x35	28x35	A28	189
66822000	140.25 A	10/11	V	10	80	840	840	167	R25	R25	A32	110
66787000	140.25 A	8/18	H	8	100	900	900	45	R30	R30	A26	144
66980000	145.17	2/28,1/19Pl.	V	2	70	900	900	109	34	34	A1	84
66908000	145.17	3/23	V	3	70	900	900	137	34x42	34x42	A1	78
66967000	145.17	2/28,1/8Pl.,3/20	H	5	80	900	1050	136	28x35		B13	145
66977000	145.17	3/24,2/23	H	5	80	900	1050	142	28		B13	147
67206000	150.14	2/10,7/13	V	9	70	800	800	94	28x35	28x35	E3	111
67209000	150.14	2/11,4/15,1/8,9/11	H	15	80	800	800	155	28x35	28x35	A28	189
67206000	150.16 A	2/10,7/13	V	9	70	800	800	94	28x35	28x35	E3	111
67209000	150.16 A	2/11,4/15,1/8,9/11	H	15	80	800	800	155	28x35	28x35	A28	189
66822000	150.16 AN	10/11	V	10	80	840	840	167	R25	R25	A32	110
66813000	150.16 AN	5/14,1/10Pl.,2/20,1/20Pl.,3/16	H	10	100	950	950	182	R35	R35	A28	188
66822000	150.16 ANW	10/11	V	10	80	840	840	167	R25	R25	A32	110
66813000	150.16 ANW	5/14,1/10Pl.,2/20,1/20Pl.,3/16	H	10	100	950	950	182	R35	R35	A28	188
66964000	150.17	4/22,1/10Pl.	V	4	70	800	800	108	34x42	34x42	A1	113
67206000	150.17	2/10,7/13	V	9	70	800	800	94	28x35	28x35	E3	111
67218000	150.17	2/11,8/13	V	10	70	800	800	125	34x42	34x42	E3	126
66937000	150.17	3/22,1/28Pl.,4/17	H	7	80	800	800	147	28x35	28x35	A2	180
67209000	150.17	2/11,4/15,1/8,9/11	H	15	80	800	800	155	28x35	28x35	A28	189
67204000	150.17 T	2/19,2/12,3/14,1/10Pl.	V	7	70	800	800	99	28x35	28x35	E2	96
66964000	159.17	4/22,1/10Pl.	V	4	70	800	800	108	34x42	34x42	A1	113
67218000	159.17	2/11,8/13	V	10	70	800	800	125	34x42	34x42	E3	126
66937000	159.17	3/22,1/28Pl.,4/17	H	7	80	800	800	147	28x35	28x35	A2	180
67209000	159.17	2/11,4/15,1/8,9/11	H	15	80	800	800	155	28x35	28x35	A28	189
67224000	159.20	3/22,1/35	V	3	70	800	800	93	34x42	34x42	A1	113
66964000	159.20	4/22,1/10Pl.	V	4	70	800	800	108	34x42	34x42	A1	113
66732000	159.20	2/11,5/14	V	7	70	800	800	90	28x35	28x35	E3	92
67218000	159.20	2/11,8/13	V	10	70	800	800	125	34x42	34x42	E3	126
66937000	159.20	3/22,1/28Pl.,4/17	H	7	80	800	800	147	28x35	28x35	A2	180
67209000	159.20	2/11,4/15,1/8,9/11	H	15	80	800	800	155	28x35	28x35	A28	189

160	IVECO	165
------------	--------------	------------

Artikel.Nr.	Fahrzeugtyp	Info	Achsl.	Blattzahl	Breite	Lx/L1	Ly/L2	Spr./	Buchsen	Buchsen	Form	Paket-
				Leaves	Width			Kr.	vorn	hinten		stärke
Art.-No.	Type		Axle					FreeArch	Bush	Bush	Shape	Total
			Load					/Crank	front	rear		height
67218000	160.16 A	2/11,8/13	V	10	70	800	800	125	34x42	34x42	E3	126
67209000	160.16 A	2/11,4/15,1/8,9/11	H	15	80	800	800	155	28x35	28x35	A28	189
66822000	160.17 AN	10/11	V	10	80	840	840	167	R25	R25	A32	110
66813000	160.17 AN	5/14,1/10Pl.,2/20,1/20Pl.,3/16	H	10	100	950	950	182	R35	R35	A28	188
66985000	160.17 AN	5/14,1/10Pl.,2/20,5/14,1/10Pl.,1/10Pl.,1/10Pl.	H	12	100	950	950	187	35x42	35x42	A60	220
66822000	160.17 ANW	10/11	V	10	80	840	840	167	R25	R25	A32	110
66813000	160.17 ANW	5/14,1/10Pl.,2/20,1/20Pl.,3/16	H	10	100	950	950	182	R35	R35	A28	188
66985000	160.17 ANW	5/14,1/10Pl.,2/20,5/14,1/10Pl.,1/10Pl.,1/10Pl.	H	12	100	950	950	187	35x42	35x42	A60	220
66970000	160.23 AH	4/23	V	4	80	950	950	143	28x34	28x34	A20	115
66906000	160.23 AH	9/14	V	9	80	950	950	146	28x34	28x34	A64	126
66985000	160.23 AH	5/14,1/10Pl.,2/20,5/14,1/10Pl.,1/10Pl.,1/10Pl.	H	12	100	950	950	187	35x42	35x42	A60	220
66939000	160.23 AH	1/17,10/15,1/10Pl.,5/14	H	16	100	950	950	141	35x41	35x41	B7	247
66906000	160.23 AHW	9/14	V	9	80	950	950	146	28x34	28x34	A64	126
66985000	160.23 AHW	5/14,1/10Pl.,2/20,5/14,1/10Pl.,1/10Pl.,1/10Pl.	H	12	100	950	950	187	35x42	35x42	A60	220
66939000	160.23 AHW	1/17,10/15,1/10Pl.,5/14	H	16	100	950	950	141	35x41	35x41	B7	247
66838000	160.23 ANW		V	8	80	950	950	75	R25	R25	A11	
66704000	160.23 ANW	9/14	V	9	80	950	950	123	R25	R25	A11	126
66572000	160.23 ANW	10/15	V	10	80	900	1000	100	R25	R25	A11	150
66927000	160.23 ANW	5/14,1/10Pl.,2/20,1/10Pl.,5/14	H	12	100	950	950	172	R35	R35	A28	210
66985000	160.23 ANW	5/14,1/10Pl.,2/20,5/14,1/10Pl.,1/10Pl.,1/10Pl.	H	12	100	950	950	187	35x42	35x42	A60	220
66572000	160.23 ANWM	10/15	V	10	80	900	1000	100	R25	R25	A11	150
66647000	160.23 ANWM	7/20,1/10Halter	H	7	100	770	770	73			D20	150
66976000	160.26	4/20,1/10Pl.	V	4	90	900	900	213	35x45	35x45	A19	102
67214000	160.26	2/13,5/14	V	7	90	900	900	178	35x45	35x45	A26	96
66961000	160.26	4/21,1/21Pl.,1/10Pl.,3/20	H	7	90	900	900	189	35x45	35x45	A2	202
67261000	160.26	6/15,1/10Pl.,7/11	H	13	90	900	900	175	35x45	35x45	A28	177
66970000	160.30 AH	4/23	V	4	80	950	950	143	28x34	28x34	A20	115
66906000	160.30 AH	9/14	V	9	80	950	950	146	28x34	28x34	A64	126
66985000	160.30 AH	5/14,1/10Pl.,2/20,5/14,1/10Pl.,1/10Pl.,1/10Pl.	H	12	100	950	950	187	35x42	35x42	A60	220
66906000	160.30 AHW	9/14	V	9	80	950	950	146	28x34	28x34	A64	126
66985000	160.30 AHW	5/14,1/10Pl.,2/20,5/14,1/10Pl.,1/10Pl.,1/10Pl.	H	12	100	950	950	187	35x42	35x42	A60	220
66939000	160.30 AHW	1/17,10/15,1/10Pl.,5/14	H	16	100	950	950	141	35x41	35x41	B7	247
67224000	165.24	3/22,1/35	V	3	70	800	800	93	34x42	34x42	A1	113
66964000	165.24	4/22,1/10Pl.	V	4	70	800	800	108	34x42	34x42	A1	113
66732000	165.24	2/11,5/14	V	7	70	800	800	90	28x35	28x35	E3	92
67218000	165.24	2/11,8/13	V	10	70	800	800	125	34x42	34x42	E3	126
66937000	165.24	3/22,1/28Pl.,4/17	H	7	80	800	800	147	28x35	28x35	A2	180
67209000	165.24	2/11,4/15,1/8,9/11	H	15	80	800	800	155	28x35	28x35	A28	189

Artikel.Nr.	Fahrzeugtyp	Info	Achsl.	Blattzahl	Breite	Lx/L1	Ly/L2	Spr./ Kr.	Buchsen vorn	Buchsen hinten	Form	Paket- stärke
Art.-No.	Type		Axle Load	Leaves	Width			FreeArch /Crank	Bush front	Bush rear	Shape	Total height
67214000	170.20	2/13,5/14	V	7	90	900	900	178	35x45	35x45	A26	96
66716000	170.20	8/13	V	8	90	900	900	186	35x45	35x45	A26	104
67261000	170.20	6/15,1/10Pl.,7/11	H	13	90	900	900	175	35x45	35x45	A28	177
67213000	170.20	6/15,1/10Zwlg.,9/11	H	15	90	900	900	175	35x45	35x45	A28	199
66970000	170.23 AH	4/23	V	4	80	950	950	143	28x34	28x34	A20	115
66906000	170.23 AH	9/14	V	9	80	950	950	146	28x34	28x34	A64	126
66606000	170.23 AH	1/15,13/13	V	14	80	950	950	90	28x34	28x34	A64	184
66985000	170.23 AH	5/14,1/10Pl.,2/20,5/14,1/10Pl.,1/10Pl.,1/10Pl.	H	12	100	950	950	187	35x42	35x42	A60	220
66939000	170.23 AH	1/17,10/15,1/10Pl.,5/14	H	16	100	950	950	141	35x41	35x41	B7	247
66970000	170.23 AHW	4/23	V	4	80	950	950	143	28x34	28x34	A20	115
66906000	170.23 AHW	9/14	V	9	80	950	950	146	28x34	28x34	A64	126
66606000	170.23 AHW	1/15,13/13	V	14	80	950	950	90	28x34	28x34	A64	184
66985000	170.23 AHW	5/14,1/10Pl.,2/20,5/14,1/10Pl.,1/10Pl.,1/10Pl.	H	12	100	950	950	187	35x42	35x42	A60	220
66939000	170.23 AHW	1/17,10/15,1/10Pl.,5/14	H	16	100	950	950	141	35x41	35x41	B7	247
66906000	170.23 ANW	9/14	V	9	80	950	950	146	28x34	28x34	A64	126
66912000	170.23 ANW	9/14	V	9	80	950	950	103	28x34	28x34	E1	126
66985000	170.23 ANW	5/14,1/10Pl.,2/20,5/14,1/10Pl.,1/10Pl.,1/10Pl.	H	12	100	950	950	187	35x42	35x42	A60	220
66970000	170.25 AH	4/23	V	4	80	950	950	143	28x34	28x34	A20	115
66906000	170.25 AH	9/14	V	9	80	950	950	146	28x34	28x34	A64	126
66606000	170.25 AH	1/15,13/13	V	14	80	950	950	90	28x34	28x34	A64	184
66985000	170.25 AH	5/14,1/10Pl.,2/20,5/14,1/10Pl.,1/10Pl.,1/10Pl.	H	12	100	950	950	187	35x42	35x42	A60	220
66939000	170.25 AH	1/17,10/15,1/10Pl.,5/14	H	16	100	950	950	141	35x41	35x41	B7	247
66970000	170.25 AHW	4/23	V	4	80	950	950	143	28x34	28x34	A20	115
66906000	170.25 AHW	9/14	V	9	80	950	950	146	28x34	28x34	A64	126
66606000	170.25 AHW	1/15,13/13	V	14	80	950	950	90	28x34	28x34	A64	184
66985000	170.25 AHW	5/14,1/10Pl.,2/20,5/14,1/10Pl.,1/10Pl.,1/10Pl.	H	12	100	950	950	187	35x42	35x42	A60	220
66939000	170.25 AHW	1/17,10/15,1/10Pl.,5/14	H	16	100	950	950	141	35x41	35x41	B7	247
67214000	170.26	2/13,5/14	V	7	90	900	900	178	35x45	35x45	A26	96
66716000	170.26	8/13	V	8	90	900	900	186	35x45	35x45	A26	104
67262000	170.26	11/10	V	11	90	900	900	280	35x45	35x45	A26	110
67261000	170.26	6/15,1/10Pl.,7/11	H	13	90	900	900	175	35x45	35x45	A28	177
67213000	170.26	6/15,1/10Zwlg.,9/11	H	15	90	900	900	175	35x45	35x45	A28	199
66970000	170.34 AH	4/23	V	4	80	950	950	143	28x34	28x34	A20	115
66906000	170.34 AH	9/14	V	9	80	950	950	146	28x34	28x34	A64	126
66606000	170.34 AH	1/15,13/13	V	14	80	950	950	90	28x34	28x34	A64	184
66985000	170.34 AH	5/14,1/10Pl.,2/20,5/14,1/10Pl.,1/10Pl.,1/10Pl.	H	12	100	950	950	187	35x42	35x42	A60	220
66939000	170.34 AH	1/17,10/15,1/10Pl.,5/14	H	16	100	950	950	141	35x41	35x41	B7	247
66970000	170.34 AHW	4/23	V	4	80	950	950	143	28x34	28x34	A20	115
66906000	170.34 AHW	9/14	V	9	80	950	950	146	28x34	28x34	A64	126
66606000	170.34 AHW	1/15,13/13	V	14	80	950	950	90	28x34	28x34	A64	184
66985000	170.34 AHW	5/14,1/10Pl.,2/20,5/14,1/10Pl.,1/10Pl.,1/10Pl.	H	12	100	950	950	187	35x42	35x42	A60	220
66939000	170.34 AHW	1/17,10/15,1/10Pl.,5/14	H	16	100	950	950	141	35x41	35x41	B7	247
67214000	170.35	2/13,5/14	V	7	90	900	900	178	35x45	35x45	A26	96
66716000	170.35	8/13	V	8	90	900	900	186	35x45	35x45	A26	104
67262000	170.35	11/10	V	11	90	900	900	280	35x45	35x45	A26	110
67261000	170.35	6/15,1/10Pl.,7/11	H	13	90	900	900	175	35x45	35x45	A28	177
67213000	170.35	6/15,1/10Zwlg.,9/11	H	15	90	900	900	175	35x45	35x45	A28	199
66964000	175.17	4/22,1/10Pl.	V	4	70	800	800	108	34x42	34x42	A1	113
66937000	175.17	3/22,1/28Pl.,4/17	H	7	80	800	800	147	28x35	28x35	A2	180
66964000	175.24	4/22,1/10Pl.	V	4	70	800	800	108	34x42	34x42	A1	113
66888000	175.24	11/13	V	11	70	800	800				E3	143
66937000	175.24	3/22,1/28Pl.,4/17	H	7	80	800	800	147	28x35	28x35	A2	180
66899000	175.24	2/15,4/18,1/9,9/14	H	14	80	930	930				A4	238
66964000	175.24 RSU	4/22,1/10Pl.	V	4	70	800	800	108	34x42	34x42	A1	113
66937000	175.24 RSU	3/22,1/28Pl.,4/17	H	7	80	800	800	147	28x35	28x35	A2	180

180**IVECO****180**

Artikel.Nr.	Fahrzeugtyp	Info	Achsl.	Blattzahl	Breite	Lx/L1	Ly/L2	Spr./ Kr.	Buchsen vorn	Buchsen hinten	Form	Paket- stärke	
Art.-No.	Type		Axle Load	Leaves	Width			FreeArch /Crank	Bush front	Bush rear	Shape	Total height	
66976000	180.24	4/20,1/10Pl.	V	13,0	4	90	900	900	213	35x45	35x45	A19	102
66716000	180.24	8/13	V		8	90	900	900	186	35x45	35x45	A26	104
66961000	180.24	4/21,1/21Pl.,1/10Pl.,3/20	H		7	90	900	900	189	35x45	35x45	A2	202
67213000	180.24	6/15,1/10Zwlg.,9/11	H		15	90	900	900	175	35x45	35x45	A28	199
66976000	180.24 T	4/20,1/10Pl.	V		4	90	900	900	213	35x45	35x45	A19	102
66718000	180.24 T	11/10	V		11	90	900	900	35	35	A26	110	
67216000	180.24 T	13/10	V		13	90	900	900	255	35x45	35x45	A26	130
66961000	180.24 T	4/21,1/21Pl.,1/10Pl.,3/20	H		7	90	900	900	189	35x45	35x45	A2	202
67213000	180.24 T	6/15,1/10Zwlg.,9/11	H		15	90	900	900	175	35x45	35x45	A28	199
66976000	180.26	4/20,1/10Pl.	V		13,0	4	90	900	900	213	35x45	35x45	A19
66716000	180.26	8/13	V	8		90	900	900	186	35x45	35x45	A26	104
66961000	180.26	4/21,1/21Pl.,1/10Pl.,3/20	H	7		90	900	900	189	35x45	35x45	A2	202
67213000	180.26	6/15,1/10Zwlg.,9/11	H	15		90	900	900	175	35x45	35x45	A28	199
66976000	180.26 T	4/20,1/10Pl.	V	4		90	900	900	213	35x45	35x45	A19	102
66718000	180.26 T	11/10	V	11		90	900	900	35	35	A26	110	
67216000	180.26 T	13/10	V	13		90	900	900	255	35x45	35x45	A26	130
66961000	180.26 T	4/21,1/21Pl.,1/10Pl.,3/20	H	7		90	900	900	189	35x45	35x45	A2	202
67213000	180.26 T	6/15,1/10Zwlg.,9/11	H	15		90	900	900	175	35x45	35x45	A28	199

Artikel.Nr.	Fahrzeugtyp	Info	Achsl.	Blattzahl	Breite	Lx/L1	Ly/L2	Spr./Kr.	Buchsen vorn	Buchsen hinten	Form	Paketstärke	
Art.-No.	Type		Axle Load	Leaves	Width			FreeArch/Crank	Bush front	Bush rear	Shape	Total height	
66606000	190.2 NT	1/15,13/13	V	7,5	14	80	950	950	90	28x34	28x34	A64	184
66374000	190.20 N	9/14	V	6,5	9	80	950	950	153	R25	R25	A32	126
66790000	190.20 N	14/13	V		14	80	950	950	100	R25	R25	A32	182
66891000	190.20 N	6/14,1/10,3/20,1/10,4/16	H		13	100	950	950	172	R35	R35	A28	228
66911000	190.20 N	11/15,1/10Pl.,5/14	H		16	100	950	950	140	R35	R35	A4	245
66416000	190.24 T.R.U.	4/21,1/10Pl.	V		4	90	900	900	199	35	35	A1	106
66976000	190.24 T.R.U.	4/20,1/10Pl.	V		4	90	900	900	213	35x45	35x45	A19	102
66963000	190.24 T.R.U.	4/21,4/P,2/20	H		6	90	900	900	189	35x45	35x45	A2	197
66961000	190.24 T.R.U.	4/21,1/21Pl.,1/10Pl.,3/20	H	13,0	7	90	900	900	189	35x45	35x45	A2	202
67213000	190.24 T.R.U.	6/15,1/10Zwlg.,9/11	H		15	90	900	900	175	35x45	35x45	A28	199
66416000	190.24 TURBO TECH	4/21,1/10Pl.	V		4	90	900	900	199	35	35	A1	106
66976000	190.24 TURBO TECH	4/20,1/10Pl.	V		4	90	900	900	213	35x45	35x45	A19	102
66963000	190.24 TURBO TECH	4/21,4/P,2/20	H		6	90	900	900	189	35x45	35x45	A2	197
66961000	190.24 TURBO TECH	4/21,1/21Pl.,1/10Pl.,3/20	H	13,0	7	90	900	900	189	35x45	35x45	A2	202
67213000	190.24 TURBO TECH	6/15,1/10Zwlg.,9/11	H		15	90	900	900	175	35x45	35x45	A28	199
66716000	190.25 A	8/13	V		8	90	900	900	186	35x45	35x45	A26	104
67213000	190.25 A	6/15,1/10Zwlg.,9/11	H		15	90	900	900	175	35x45	35x45	A28	199
66704000	190.25 AH	9/14	V		9	80	950	950	123	R25	R25	A11	126
66790000	190.25 AH	14/13	V		14	80	950	950	100	R25	R25	A32	182
66927000	190.25 AH	5/14,1/10Pl.,2/20,1/10Pl.,5/14	H		12	100	950	950	172	R35	R35	A28	210
66911000	190.25 AH	11/15,1/10Pl.,5/14	H		16	100	950	950	140	R35	R35	A4	245
66970000	190.25 AN	4/23	V		4	80	950	950	143	28x34	28x34	A20	115
66704000	190.25 AN	9/14	V		9	80	950	950	123	R25	R25	A11	126
66906000	190.25 AN	9/14	V		9	80	950	950	146	28x34	28x34	A64	126
66606000	190.25 AN	1/15,13/13	V	7,5	14	80	950	950	90	28x34	28x34	A64	184
66790000	190.25 AN	14/13	V		14	80	950	950	100	R25	R25	A32	182
66850000	190.25 AN	1/15,13/13	V		14	80	900	1000	111	28x34	28x34	E2	184
66927000	190.25 AN	5/14,1/10Pl.,2/20,1/10Pl.,5/14	H		12	100	950	950	172	R35	R35	A28	210
66985000	190.25 AN	5/14,1/10Pl.,2/20,5/14,1/10Pl.,1/10Pl.,1/10Pl.	H		12	100	950	950	187	35x42	35x42	A60	220
66911000	190.25 AN	11/15,1/10Pl.,5/14	H		16	100	950	950	140	R35	R35	A4	245
66939000	190.25 AN	1/17,10/15,1/10Pl.,5/14	H		16	100	950	950	141	35x41	35x41	B7	247
66718000	190.25 AT	11/10	V		11	90	900	900		35	35	A26	110
67213000	190.25 AT	6/15,1/10Zwlg.,9/11	H		15	90	900	900	175	35x45	35x45	A28	199
66606000	190.26 H	1/15,13/13	V	7,5	14	80	950	950	90	28x34	28x34	A64	184
66790000	190.26 H	14/13	V		14	80	950	950	100	R25	R25	A32	182
66985000	190.26 H	5/14,1/10Pl.,2/20,5/14,1/10Pl.,1/10Pl.,1/10Pl.	H		12	100	950	950	187	35x42	35x42	A60	220
66939000	190.26 H	1/17,10/15,1/10Pl.,5/14	H		16	100	950	950	141	35x41	35x41	B7	247
66704000	190.26 HT	9/14	V		9	80	950	950	123	R25	R25	A11	126
66790000	190.26 HT	14/13	V		14	80	950	950	100	R25	R25	A32	182
66911000	190.26 HT	11/15,1/10Pl.,5/14	H		16	100	950	950	140	R35	R35	A4	245
66790000	190.26 HW	14/13	V		14	80	950	950	100	R25	R25	A32	182
66911000	190.26 HW	11/15,1/10Pl.,5/14	H		16	100	950	950	140	R35	R35	A4	245
66374000	190.26 N	9/14	V	6,5	9	80	950	950	153	R25	R25	A32	126
66906000	190.26 N	9/14	V		9	80	950	950	146	28x34	28x34	A64	126
66606000	190.26 N	1/15,13/13	V	7,5	14	80	950	950	90	28x34	28x34	A64	184
66790000	190.26 N	14/13	V		14	80	950	950	100	R25	R25	A32	182
66850000	190.26 N	1/15,13/13	V		14	80	900	1000	111	28x34	28x34	E2	184
66985000	190.26 N	5/14,1/10Pl.,2/20,5/14,1/10Pl.,1/10Pl.,1/10Pl.	H		12	100	950	950	187	35x42	35x42	A60	220
66891000	190.26 N	6/14,1/10,3/20,1/10,4/16	H		13	100	950	950	172	R35	R35	A28	228
66911000	190.26 N	11/15,1/10Pl.,5/14	H		16	100	950	950	140	R35	R35	A4	245
66939000	190.26 N	1/17,10/15,1/10Pl.,5/14	H		16	100	950	950	141	35x41	35x41	B7	247
66970000	190.26 NT	4/23	V		4	80	950	950	143	28x34	28x34	A20	115
66374000	190.26 NT	9/14	V	6,5	9	80	950	950	153	R25	R25	A32	126
66704000	190.26 NT	9/14	V		9	80	950	950	123	R25	R25	A11	126

190

IVECO

190

Artikel.Nr.	Fahrzeugtyp	Info	Achsl.	Blattzahl	Breite	Lx/L1	Ly/L2	Spr./ Kr.	Buchsen vorn	Buchsen hinten	Form	Paket- stärke
Art.-No.	Type		Axle Load	Leaves	Width			FreeArch /Crank	Bush front	Bush rear	Shape	Total height
66572000	190.26 NT	10/15	V	10	80	900	1000	100	R25	R25	A11	150
66620000	190.26 NT	14/13	V	14	80	900	1000	130	R25	R25	A32	182
66790000	190.26 NT	14/13	V	14	80	950	950	100	R25	R25	A32	182
66911000	190.26 NT	11/15,1/10Pl.,5/14	H	16	100	950	950	140	R35	R35	A4	245
66906000	190.26 NW	9/14	V	9	80	950	950	146	28x34	28x34	A64	126
66572000	190.26 NW	10/15	V	10	80	900	1000	100	R25	R25	A11	150
66868000	190.26 NW	10/15	V	10	80	950	950	90	R25	R25	A11	150
66606000	190.26 NW	1/15,13/13	V	14	80	950	950	90	28x34	28x34	A64	184
66620000	190.26 NW	14/13	V	14	80	900	1000	130	R25	R25	A32	182
66790000	190.26 NW	14/13	V	14	80	950	950	100	R25	R25	A32	182
66850000	190.26 NW	1/15,13/13	V	14	80	900	1000	111	28x34	28x34	E2	184
66985000	190.26 NW	5/14,1/10Pl.,2/20,5/14,1/10Pl.,1/10Pl.,1/10Pl.	H	12	100	950	950	187	35x42	35x42	A60	220
66911000	190.26 NW	11/15,1/10Pl.,5/14	H	16	100	950	950	140	R35	R35	A4	245
66939000	190.26 NW	1/17,10/15,1/10Pl.,5/14	H	16	100	950	950	141	35x41	35x41	B7	247
66416000	190.26 T.R.U.	4/21,1/10Pl.	V	4	90	900	900	199	35	35	A1	106
66976000	190.26 T.R.U.	4/20,1/10Pl.	V	4	90	900	900	213	35x45	35x45	A19	102
66716000	190.26 T.R.U.	8/13	V	8	90	900	900	186	35x45	35x45	A26	104
66718000	190.26 T.R.U.	11/10	V	11	90	900	900		35	35	A26	110
67216000	190.26 T.R.U.	13/10	V	13	90	900	900	255	35x45	35x45	A26	130
66963000	190.26 T.R.U.	4/21,4/P,2/20	H	6	90	900	900	189	35x45	35x45	A2	197
66961000	190.26 T.R.U.	4/21,1/21Pl.,1/10Pl.,3/20	H	7	90	900	900	189	35x45	35x45	A2	202
67213000	190.26 T.R.U.	6/15,1/10Zwlg.,9/11	H	15	90	900	900	175	35x45	35x45	A28	199
66416000	190.26 TURBO TECH	4/21,1/10Pl.	V	4	90	900	900	199	35	35	A1	106
66976000	190.26 TURBO TECH	4/20,1/10Pl.	V	4	90	900	900	213	35x45	35x45	A19	102
66716000	190.26 TURBO TECH	8/13	V	8	90	900	900	186	35x45	35x45	A26	104
66718000	190.26 TURBO TECH	11/10	V	11	90	900	900		35	35	A26	110
67216000	190.26 TURBO TECH	13/10	V	13	90	900	900	255	35x45	35x45	A26	130
66963000	190.26 TURBO TECH	4/21,4/P,2/20	H	6	90	900	900	189	35x45	35x45	A2	197
66961000	190.26 TURBO TECH	4/21,1/21Pl.,1/10Pl.,3/20	H	7	90	900	900	189	35x45	35x45	A2	202
67213000	190.26 TURBO TECH	6/15,1/10Zwlg.,9/11	H	15	90	900	900	175	35x45	35x45	A28	199
66911000	190.26H	11/15,1/10Pl.,5/14	H	16	100	950	950	140	R35	R35	A4	245
66976000	190.29	4/20,1/10Pl.	V	4	90	900	900	213	35x45	35x45	A19	102
66716000	190.29	8/13	V	8	90	900	900	186	35x45	35x45	A26	104
66718000	190.29	11/10	V	11	90	900	900		35	35	A26	110
66722000	190.29	11/11	V	11	90	900	900		35	35	A26	121
66726000	190.29	11/10;1/12	V	11	90	900	900	287	35x45	35x45	A26	122
66724000	190.29	11/10,2/9,1/12	V	13	90	900	900	247	35x45	35x45	A26	140
67216000	190.29	13/10	V	13	90	900	900	255	35x45	35x45	A26	130
66961000	190.29	4/21,1/21Pl.,1/10Pl.,3/20	H	7	90	900	900	189	35x45	35x45	A2	202
67261000	190.29	6/15,1/10Pl.,7/11	H	13	90	900	900	175	35x45	35x45	A28	177
67213000	190.29	6/15,1/10Zwlg.,9/11	H	15	90	900	900	175	35x45	35x45	A28	199
66416000	190.30	4/21,1/10Pl.	V	4	90	900	900	199	35	35	A1	106
66976000	190.30	4/20,1/10Pl.	V	4	90	900	900	213	35x45	35x45	A19	102
66716000	190.30	8/13	V	8	90	900	900	186	35x45	35x45	A26	104
66718000	190.30	11/10	V	11	90	900	900		35	35	A26	110
66722000	190.30	11/11	V	11	90	900	900		35	35	A26	121
66963000	190.30	4/21,4/P,2/20	H	6	90	900	900	189	35x45	35x45	A2	197
66961000	190.30	4/21,1/21Pl.,1/10Pl.,3/20	H	7	90	900	900	189	35x45	35x45	A2	202
67261000	190.30	6/15,1/10Pl.,7/11	H	13	90	900	900	175	35x45	35x45	A28	177
67213000	190.30	6/15,1/10Zwlg.,9/11	H	15	90	900	900	175	35x45	35x45	A28	199
66970000	190.30 AHT	4/23	V	4	80	950	950	143	28x34	28x34	A20	115
66985000	190.30 AHT	5/14,1/10Pl.,2/20,5/14,1/10Pl.,1/10Pl.,1/10Pl.	H	12	100	950	950	187	35x42	35x42	A60	220

Artikel.Nr.	Fahrzeugtyp	Info	Achsl.	Blattzahl	Breite	Lx/L1	Ly/L2	Spr./Kr.	Buchsen vorn	Buchsen hinten	Form	Paketstärke	
Art.-No.	Type		Axle Load	Leaves	Width			FreeArch/Crank	Bush front	Bush rear	Shape	Total height	
66970000	190.30 H	4/23	V	7,5	4	80	950	950	143	28x34	28x34	A20	115
66704000	190.30 H	9/14	V	7,5	9	80	950	950	123	R25	R25	A11	126
66906000	190.30 H	9/14	V	7,5	9	80	950	950	146	28x34	28x34	A64	126
66606000	190.30 H	1/15,13/13	V	7,5	14	80	950	950	90	28x34	28x34	A64	184
66985000	190.30 H	5/14,1/10Pl.,2/20,5/14,1/10Pl.,1/10Pl.,1/10Pl.	H	7,5	12	100	950	950	187	35x42	35x42	A60	220
66911000	190.30 H	11/15,1/10Pl.,5/14	H	7,5	16	100	950	950	140	R35	R35	A4	245
66939000	190.30 H	1/17,10/15,1/10Pl.,5/14	H	7,5	16	100	950	950	141	35x41	35x41	B7	247
66852000	190.30 N	9/14	V	7,5	9	80	900	1000	128	28	28	E2	126
66850000	190.30 N	1/15,13/13	V	7,5	14	80	900	1000	111	28x34	28x34	E2	184
66985000	190.30 N	5/14,1/10Pl.,2/20,5/14,1/10Pl.,1/10Pl.,1/10Pl.	H	7,5	12	100	950	950	187	35x42	35x42	A60	220
66939000	190.30 N	1/17,10/15,1/10Pl.,5/14	H	7,5	16	100	950	950	141	35x41	35x41	B7	247
66852000	190.30 NT	9/14	V	7,5	9	80	900	1000	128	28	28	E2	126
66850000	190.30 NT	1/15,13/13	V	7,5	14	80	900	1000	111	28x34	28x34	E2	184
66985000	190.30 NT	5/14,1/10Pl.,2/20,5/14,1/10Pl.,1/10Pl.,1/10Pl.	H	7,5	12	100	950	950	187	35x42	35x42	A60	220
66939000	190.30 NT	1/17,10/15,1/10Pl.,5/14	H	7,5	16	100	950	950	141	35x41	35x41	B7	247
66416000	190.30 T.R.U.	4/21,1/10Pl.	V	13,0	4	90	900	900	199	35	35	A1	106
66976000	190.30 T.R.U.	4/20,1/10Pl.	V	13,0	4	90	900	900	213	35x45	35x45	A19	102
66716000	190.30 T.R.U.	8/13	V	13,0	8	90	900	900	186	35x45	35x45	A26	104
66718000	190.30 T.R.U.	11/10	V	13,0	11	90	900	900		35	35	A26	110
66722000	190.30 T.R.U.	11/11	V	13,0	11	90	900	900		35	35	A26	121
66963000	190.30 T.R.U.	4/21,4/P,2/20	H	13,0	6	90	900	900	189	35x45	35x45	A2	197
66961000	190.30 T.R.U.	4/21,1/21Pl.,1/10Pl.,3/20	H	13,0	7	90	900	900	189	35x45	35x45	A2	202
67261000	190.30 T.R.U.	6/15,1/10Pl.,7/11	H	13,0	13	90	900	900	175	35x45	35x45	A28	177
67213000	190.30 T.R.U.	6/15,1/10Zwlg.,9/11	H	13,0	15	90	900	900	175	35x45	35x45	A28	199
66416000	190.30 TURBO TECH	4/21,1/10Pl.	V	13,0	4	90	900	900	199	35	35	A1	106
66976000	190.30 TURBO TECH	4/20,1/10Pl.	V	13,0	4	90	900	900	213	35x45	35x45	A19	102
66716000	190.30 TURBO TECH	8/13	V	13,0	8	90	900	900	186	35x45	35x45	A26	104
66718000	190.30 TURBO TECH	11/10	V	13,0	11	90	900	900		35	35	A26	110
66722000	190.30 TURBO TECH	11/11	V	13,0	11	90	900	900		35	35	A26	121
66963000	190.30 TURBO TECH	4/21,4/P,2/20	H	13,0	6	90	900	900	189	35x45	35x45	A2	197
66961000	190.30 TURBO TECH	4/21,1/21Pl.,1/10Pl.,3/20	H	13,0	7	90	900	900	189	35x45	35x45	A2	202
67261000	190.30 TURBO TECH	6/15,1/10Pl.,7/11	H	13,0	13	90	900	900	175	35x45	35x45	A28	177
67213000	190.30 TURBO TECH	6/15,1/10Zwlg.,9/11	H	13,0	15	90	900	900	175	35x45	35x45	A28	199
66704000	190.32 AH	9/14	V	7,5	9	80	950	950	123	R25	R25	A11	126
66790000	190.32 AH	14/13	V	7,5	14	80	950	950	100	R25	R25	A32	182
66927000	190.32 AH	5/14,1/10Pl.,2/20,1/10Pl.,5/14	H	7,5	12	100	950	950	172	R35	R35	A28	210
66911000	190.32 AH	11/15,1/10Pl.,5/14	H	7,5	16	100	950	950	140	R35	R35	A4	245
66704000	190.32 AHT	9/14	V	7,5	9	80	950	950	123	R25	R25	A11	126
66790000	190.32 AHT	14/13	V	7,5	14	80	950	950	100	R25	R25	A32	182
66911000	190.32 AHT	11/15,1/10Pl.,5/14	H	7,5	16	100	950	950	140	R35	R35	A4	245
66704000	190.32 AHW	9/14	V	7,5	9	80	950	950	123	R25	R25	A11	126
66790000	190.32 AHW	14/13	V	7,5	14	80	950	950	100	R25	R25	A32	182
66927000	190.32 AHW	5/14,1/10Pl.,2/20,1/10Pl.,5/14	H	7,5	12	100	950	950	172	R35	R35	A28	210
66911000	190.32 AHW	11/15,1/10Pl.,5/14	H	7,5	16	100	950	950	140	R35	R35	A4	245
66416000	190.32 GV TURBO TECH	4/21,1/10Pl.	V	13,0	4	90	900	900	199	35	35	A1	106
66976000	190.32 GV TURBO TECH	4/20,1/10Pl.	V	13,0	4	90	900	900	213	35x45	35x45	A19	102
66716000	190.32 GV TURBO TECH	8/13	V	13,0	8	90	900	900	186	35x45	35x45	A26	104
66718000	190.32 GV TURBO TECH	11/10	V	13,0	11	90	900	900		35	35	A26	110
66722000	190.32 GV TURBO TECH	11/11	V	13,0	11	90	900	900		35	35	A26	121

190

IVECO

190

Artikel-Nr.	Fahrzeugtyp	Info	Achsl.	Blattzahl	Breite	Lx/L1	Ly/L2	Spr./ Kr.	Buchsen vorn	Buchsen hinten	Form	Paket- stärke	
Art.-No.	Type		Axle Load	Leaves	Width			FreeArch /Crank	Bush front	Bush rear	Shape	Total height	
67216000	190.32 GV TURBO TECH	13/10	V	13,0	13	90	900	900	255	35x45	35x45	A26	130
66416000	190.33 TURBOSTAR	4/21,1/10Pl.	V		4	90	900	900	199	35	35	A1	106
66976000	190.33 TURBOSTAR	4/20,1/10Pl.	V		4	90	900	900	213	35x45	35x45	A19	102
66963000	190.33 TURBOSTAR	4/21,4/P,2/20	H		6	90	900	900	189	35x45	35x45	A2	197
66961000	190.33 TURBOSTAR	4/21,1/21Pl.,1/10Pl.,3/20	H		7	90	900	900	189	35x45	35x45	A2	202
66716000	190.35	8/13	V		8	90	900	900	186	35x45	35x45	A26	104
67216000	190.35	13/10	V		13	90	900	900	255	35x45	35x45	A26	130
66963000	190.35	4/21,4/P,2/20	H		6	90	900	900	189	35x45	35x45	A2	197
66961000	190.35	4/21,1/21Pl.,1/10Pl.,3/20	H		7	90	900	900	189	35x45	35x45	A2	202
67261000	190.35	6/15,1/10Pl.,7/11	H		13	90	900	900	175	35x45	35x45	A28	177
67213000	190.35	6/15,1/10Zwlg.,9/11	H		15	90	900	900	175	35x45	35x45	A28	199
66704000	190.35 H	9/14	V		9	80	950	950	123	R25	R25	A11	126
66790000	190.35 H	14/13	V		14	80	950	950	100	R25	R25	A32	182
66911000	190.35 H	11/15,1/10Pl.,5/14	H	16	100	950	950	140	R35	R35	A4	245	
66718000	190.35 T	11/10	V	11	90	900	900	35	35	35	A26	110	
67262000	190.35 T	11/10	V	11	90	900	900	280	35x45	35x45	A26	110	
66976000	190.36 A	4/20,1/10Pl.	V	4	90	900	900	213	35x45	35x45	A19	102	
66716000	190.36 A	8/13	V	8	90	900	900	186	35x45	35x45	A26	104	
66961000	190.36 A	4/21,1/21Pl.,1/10Pl.,3/20	H	7	90	900	900	189	35x45	35x45	A2	202	
67213000	190.36 A	6/15,1/10Zwlg.,9/11	H	15	90	900	900	175	35x45	35x45	A28	199	
66718000	190.36 APT	11/10	V	11	90	900	900	35	35	35	A26	110	
67213000	190.36 APT	6/15,1/10Zwlg.,9/11	H	15	90	900	900	175	35x45	35x45	A28	199	
66718000	190.36 AT	11/10	V	11	90	900	900	35	35	35	A26	110	
67213000	190.36 AT	6/15,1/10Zwlg.,9/11	H	15	90	900	900	175	35x45	35x45	A28	199	
66416000	190.36 GV TURBOTECH	4/21,1/10Pl.	V	13,0	4	90	900	900	199	35	35	A1	106
66976000	190.36 GV TURBOTECH	4/20,1/10Pl.	V		4	90	900	900	213	35x45	35x45	A19	102
66961000	190.36 GV TURBOTECH	4/21,1/21Pl.,1/10Pl.,3/20	H		7	90	900	900	189	35x45	35x45	A2	202
66416000	190.36 T. R. U.	4/21,1/10Pl.	V		4	90	900	900	199	35	35	A1	106
66963000	190.36 T. R. U.	4/21,4/P,2/20	H		6	90	900	900	189	35x45	35x45	A2	197
66976000	190.36 T.R.U.	4/20,1/10Pl.	V		4	90	900	900	213	35x45	35x45	A19	102
66961000	190.36 T.R.U.	4/21,1/21Pl.,1/10Pl.,3/20	H		7	90	900	900	189	35x45	35x45	A2	202
66416000	190.36 TURBOSTAR	4/21,1/10Pl.	V		4	90	900	900	199	35	35	A1	106
66976000	190.36 TURBOSTAR	4/20,1/10Pl.	V		4	90	900	900	213	35x45	35x45	A19	102
66963000	190.36 TURBOSTAR	4/21,4/P,2/20	H		6	90	900	900	189	35x45	35x45	A2	197
66961000	190.36 TURBOSTAR	4/21,1/21Pl.,1/10Pl.,3/20	H		7	90	900	900	189	35x45	35x45	A2	202
66416000	190.36 TURBOTECH	4/21,1/10Pl.	V		4	90	900	900	199	35	35	A1	106
66976000	190.36 TURBOTECH	4/20,1/10Pl.	V		4	90	900	900	213	35x45	35x45	A19	102
66963000	190.36 TURBOTECH	4/21,4/P,2/20	H	6	90	900	900	189	35x45	35x45	A2	197	
66961000	190.36 TURBOTECH	4/21,1/21Pl.,1/10Pl.,3/20	H	7	90	900	900	189	35x45	35x45	A2	202	
67213000	190.36 TURBOTECH	6/15,1/10Zwlg.,9/11	H	15	90	900	900	175	35x45	35x45	A28	199	
66722000	190.38 P	11/11	V	13,0	11	90	900	900	35	35	A26	121	
66718000	190.38 PT	11/10	V		11	90	900	900	35	35	A26	110	
66718000	190.38 T	11/10	V		11	90	900	900	35	35	A26	110	
66961000	190.38 T.R.U.	4/21,1/21Pl.,1/10Pl.,3/20	H		7	90	900	900	189	35x45	35x45	A2	202
66961000	190.38 T.R.U.	4/21,1/21Pl.,1/10Pl.,3/20	H		7	90	900	900	189	35x45	35x45	A2	202
66963000	190.38 TURBOSTAR	4/21,4/P,2/20	H		6	90	900	900	189	35x45	35x45	A2	197
66963000	190.38 TURBOSTAR	4/21,4/P,2/20	H		6	90	900	900	189	35x45	35x45	A2	197

190**IVECO****190**

Artikel.Nr.	Fahrzeugtyp	Info		Achsl.	Blattzahl	Breite	Lx/L1	Ly/L2	Spr./ Kr.	Buchsen vorn	Buchsen hinten	Form	Paket- stärke
Art.-No.	Type			Axle Load	Leaves	Width			FreeArch /Crank	Bush front	Bush rear	Shape	Total height
66416000	190.42 TURBOSTAR	4/21,1/10Pl.	V	13,0	4	90	900	900	199	35	35	A1	106
66976000	190.42 TURBOSTAR	4/20,1/10Pl.	V		4	90	900	900	213	35x45	35x45	A19	102
66963000	190.42 TURBOSTAR	4/21,4/P,2/20	H		6	90	900	900	189	35x45	35x45	A2	197
66961000	190.42 TURBOSTAR	4/21,1/21Pl.,1/10Pl.,3/20	H		7	90	900	900	189	35x45	35x45	A2	202
66416000	190.48 TURBOSTAR	4/21,1/10Pl.	V		4	90	900	900	199	35	35	A1	106
66976000	190.48 TURBOSTAR	4/20,1/10Pl.	V		4	90	900	900	213	35x45	35x45	A19	102
66963000	190.48 TURBOSTAR	4/21,4/P,2/20	H		6	90	900	900	189	35x45	35x45	A2	197
66961000	190.48 TURBOSTAR	4/21,1/21Pl.,1/10Pl.,3/20	H		7	90	900	900	189	35x45	35x45	A2	202

220**IVECO****220**

Artikel.Nr.	Fahrzeugtyp	Info	Achsl.	Blattzahl	Breite	Lx/L1	Ly/L2	Spr./ Kr.	Buchsen vorn	Buchsen hinten	Form	Paket- stärke
Art.-No.	Type		Axle Load	Leaves	Width			FreeArch /Crank	Bush front	Bush rear	Shape	Total height
66976000	220.29 3. SERIE	4/20,1/10Pl.	V	4	90	900	900	213	35x45	35x45	A19	102
66718000	220.29 3. SERIE	11/10	V	11	90	900	900		35	35	A26	110
66976000	220.30 PT 6X2	4/20,1/10Pl.	V	4	90	900	900	213	35x45	35x45	A19	102
66976000	220.30 T.R.U.	4/20,1/10Pl.	V	4	90	900	900	213	35x45	35x45	A19	102
66570000	220.32 AHTM	8/13	V	8	80	950	950	225	R25	R25	A32	110
66976000	220.32 AHTM	4/20,1/10Pl.	V	4	90	900	900	213	35x45	35x45	A19	102
66429000	220.32 AHTM	13/9,2/15	H	15	100	580	850	79	R35	R35	A43	147
66779000	220.32 AHTM	13/9,2/15	H	15	100	580	850	103	R35	R35	A43	147
66976000	220.32 T.R.U.	4/20,1/10Pl.	V	4	90	900	900	213	35x45	35x45	A19	102
66976000	220.32 TURBOTECH	4/20,1/10Pl.	V	4	90	900	900	213	35x45	35x45	A19	102
66976000	220.36 T.R.U.	4/20,1/10Pl.	V	4	90	900	900	213	35x45	35x45	A19	102
66976000	220.36 TURBOTECH	4/20,1/10Pl.	V	4	90	900	900	213	35x45	35x45	A19	102

240

IVECO

240

Artikel.Nr.	Fahrzeugtyp	Info	Achsl.	Blattzahl	Breite	Lx/L1	Ly/L2	Spr./Kr.	Buchsen vorn	Buchsen hinten	Form	Paketstärke
Art.-No.	Type		Axle Load	Leaves	Width			FreeArch/Crank	Bush front	Bush rear	Shape	Total height
66416000	240.26 T.R.U.	4/21,1/10Pl.	V	4	90	900	900	199	35	35	A1	106
66976000	240.26 T.R.U.	4/20,1/10Pl.	V	4	90	900	900	213	35x45	35x45	A19	102
66975000	240.26 T.R.U.	3/14	H	3	90	700	750	210	35x45	35x45	A20	42
66961000	240.26 T.R.U.	4/21,1/21Pl.,1/10Pl.,3/20	H	7	90	900	900	189	35x45	35x45	A2	202
66416000	240.26 TURBO TECH	4/21,1/10Pl.	V	4	90	900	900	199	35	35	A1	106
66976000	240.26 TURBO TECH	4/20,1/10Pl.	V	4	90	900	900	213	35x45	35x45	A19	102
66975000	240.26 TURBO TECH	3/14	H	3	90	700	750	210	35x45	35x45	A20	42
66961000	240.26 TURBO TECH	4/21,1/21Pl.,1/10Pl.,3/20	H	7	90	900	900	189	35x45	35x45	A2	202
66976000	240.30 P	4/20,1/10Pl.	V	4	90	900	900	213	35x45	35x45	A19	102
66718000	240.30 P	11/10	V	11	90	900	900		35	35	A26	110
66976000	240.30 T.R.U.	4/20,1/10Pl.	V	4	90	900	900	213	35x45	35x45	A19	102
66416000	240.32 GV	4/21,1/10Pl.	V	4	90	900	900	199	35	35	A1	106
66976000	240.32 GV	4/20,1/10Pl.	V	4	90	900	900	213	35x45	35x45	A19	102
66416000	240.32 TURBOTECH GV	4/21,1/10Pl.	V	4	90	900	900	199	35	35	A1	106
66976000	240.32 TURBOTECH GV	4/20,1/10Pl.	V	4	90	900	900	213	35x45	35x45	A19	102
66416000	240.36 GV TURBOTECH	4/21,1/10Pl.	V	4	90	900	900	199	35	35	A1	106
66976000	240.36 GV TURBOTECH	4/20,1/10Pl.	V	4	90	900	900	213	35x45	35x45	A19	102
66975000	240.36 GV TURBOTECH	3/14	H	3	90	700	750	210	35x45	35x45	A20	42
66961000	240.36 GV TURBOTECH	4/21,1/21Pl.,1/10Pl.,3/20	H	7	90	900	900	189	35x45	35x45	A2	202
66416000	240.36 T.R.U.	4/21,1/10Pl.	V	4	90	900	900	199	35	35	A1	106
66976000	240.36 T.R.U.	4/20,1/10Pl.	V	4	90	900	900	213	35x45	35x45	A19	102
66975000	240.36 T.R.U.	3/14	H	3	90	700	750	210	35x45	35x45	A20	42
66961000	240.36 T.R.U.	4/21,1/21Pl.,1/10Pl.,3/20	H	7	90	900	900	189	35x45	35x45	A2	202
66416000	240.36 TURBOSTAR	4/21,1/10Pl.	V	4	90	900	900	199	35	35	A1	106
66976000	240.36 TURBOSTAR	4/20,1/10Pl.	V	4	90	900	900	213	35x45	35x45	A19	102
66975000	240.36 TURBOSTAR	3/14	H	3	90	700	750	210	35x45	35x45	A20	42
66961000	240.36 TURBOSTAR	4/21,1/21Pl.,1/10Pl.,3/20	H	7	90	900	900	189	35x45	35x45	A2	202
66416000	240.36 TURBOTECH	4/21,1/10Pl.	V	4	90	900	900	199	35	35	A1	106
66976000	240.36 TURBOTECH	4/20,1/10Pl.	V	4	90	900	900	213	35x45	35x45	A19	102
66975000	240.36 TURBOTECH	3/14	H	3	90	700	750	210	35x45	35x45	A20	42
66961000	240.36 TURBOTECH	4/21,1/21Pl.,1/10Pl.,3/20	H	7	90	900	900	189	35x45	35x45	A2	202
66416000	240.38	4/21,1/10Pl.	V	4	90	900	900	199	35	35	A1	106
66976000	240.38	4/20,1/10Pl.	V	4	90	900	900	213	35x45	35x45	A19	102
66975000	240.38	3/14	H	3	90	700	750	210	35x45	35x45	A20	42
66961000	240.38	4/21,1/21Pl.,1/10Pl.,3/20	H	7	90	900	900	189	35x45	35x45	A2	202
66976000	240.38 3 SER	4/20,1/10Pl.	V	4	90	900	900	213	35x45	35x45	A19	102
66722000	240.38 3 SER	11/11	V	11	90	900	900		35	35	A26	121
66416000	240.38 P	4/21,1/10Pl.	V	4	90	900	900	199	35	35	A1	106
66722000	240.38 P	11/11	V	11	90	900	900		35	35	A26	121
66975000	240.38 P	3/14	H	3	90	700	750	210	35x45	35x45	A20	42
66961000	240.38 P	4/21,1/21Pl.,1/10Pl.,3/20	H	7	90	900	900	189	35x45	35x45	A2	202
66416000	240.38 T.R.U.	4/21,1/10Pl.	V	4	90	900	900	199	35	35	A1	106
66975000	240.38 T.R.U.	3/14	H	3	90	700	750	210	35x45	35x45	A20	42
66961000	240.38 T.R.U.	4/21,1/21Pl.,1/10Pl.,3/20	H	7	90	900	900	189	35x45	35x45	A2	202
66416000	240.38 TURBOSTAR	4/21,1/10Pl.	V	4	90	900	900	199	35	35	A1	106
66975000	240.38 TURBOSTAR	3/14	H	3	90	700	750	210	35x45	35x45	A20	42

240

IVECO

240

Artikel.Nr.	Fahrzeugtyp	Info	Achsl.	Blattzahl	Breite	Lx/L1	Ly/L2	Spr./ Kr.	Buchsen vorn	Buchsen hinten	Form	Paket- stärke	
Art.-No.	Type		Axle Load	Leaves	Width			FreeArch /Crank	Bush front	Bush rear	Shape	Total height	
66961000	240.38 TURBOSTAR	4/21,1/21Pl.,1/10Pl.,3/20	H	13,0	7	90	900	900	189	35x45	35x45	A2	202
66416000	240.38 TURBOTECH	4/21,1/10Pl.	V		4	90	900	900	199	35	35	A1	106
66975000	240.38 TURBOTECH	3/14	H		3	90	700	750	210	35x45	35x45	A20	42
66961000	240.38 TURBOTECH	4/21,1/21Pl.,1/10Pl.,3/20	H	13,0	7	90	900	900	189	35x45	35x45	A2	202
66416000	240.48	4/21,1/10Pl.	V		4	90	900	900	199	35	35	A1	106
66976000	240.48	4/20,1/10Pl.	V		4	90	900	900	213	35x45	35x45	A19	102
66975000	240.48	3/14	H		3	90	700	750	210	35x45	35x45	A20	42
66961000	240.48	4/21,1/21Pl.,1/10Pl.,3/20	H	13,0	7	90	900	900	189	35x45	35x45	A2	202
66416000	240.48 TURBOSTAR	4/21,1/10Pl.	V		4	90	900	900	199	35	35	A1	106
66976000	240.48 TURBOSTAR	4/20,1/10Pl.	V		4	90	900	900	213	35x45	35x45	A19	102
66975000	240.48 TURBOSTAR	3/14	H		3	90	700	750	210	35x45	35x45	A20	42
66961000	240.48 TURBOSTAR	4/21,1/21Pl.,1/10Pl.,3/20	H	13,0	7	90	900	900	189	35x45	35x45	A2	202

Artikel.Nr.	Fahrzeugtyp	Info		Achsl.	Blattzahl	Breite	Lx/L1	Ly/L2	Spr./ Kr.	Buchsen vorn	Buchsen hinten	Form	Paket- stärke
Art.-No.	Type			Axle Load	Leaves	Width			FreeArch /Crank	Bush front	Bush rear	Shape	Total height
66970000	260.23 AH	4/23	V		4	80	950	950	143	28x34	28x34	A20	115
66906000	260.23 AH	9/14	V		9	80	950	950	146	28x34	28x34	A64	126
66606000	260.23 AH	1/15,13/13	V	7,5	14	80	950	950	90	28x34	28x34	A64	184
66969000	260.23 AH	1/10Pl.,5/24,1/10Halter	H		5	100	740	740	84			D6	152
66987000	260.23 AH	6/22,1/10Halter	H		6	100	740	740				D1.1	142
66379000	260.23 AH	7/22,1/10Halter	H		7	100	740	740	33			D1.1	164
66397000	260.23 AH	8/22,1/10Halter	H		8	100	740	740	28			D21	186
66970000	260.23 AHB	4/23	V		4	80	950	950	143	28x34	28x34	A20	115
66379000	260.23 AHB	7/22,1/10Halter	H		7	100	740	740	33			D1.1	164
66712000	260.25 AH	4/23	V		4	80	950	950	143	25	25	A20	115
66970000	260.25 AH	4/23	V		4	80	950	950	143	28x34	28x34	A20	115
66704000	260.25 AH	9/14	V		9	80	950	950	123	R25	R25	A11	126
66906000	260.25 AH	9/14	V		9	80	950	950	146	28x34	28x34	A64	126
66606000	260.25 AH	1/15,13/13	V	7,5	14	80	950	950	90	28x34	28x34	A64	184
66790000	260.25 AH	14/13	V		14	80	950	950	100	R25	R25	A32	182
66969000	260.25 AH	1/10Pl.,5/24,1/10Halter	H		5	100	740	740	84			D6	152
66379000	260.25 AH	7/22,1/10Halter	H		7	100	740	740	33			D1.1	164
66397000	260.25 AH	8/22,1/10Halter	H		8	100	740	740	28			D21	186
66981000	260.25 AH	8/22,1/10Halter	H	10,5	8	100	740	740	99			D20	186
66867000	260.25 AH	14/18,1/10Halter	H		14	100	780	780	50			D20	262
66958000	260.25 AHB	3/27	V		3	80	950	950		R25	R25		
66712000	260.25 AHB	4/23	V		4	80	950	950	143	25	25	A20	115
66606000	260.25 AHB	1/15,13/13	V	7,5	14	80	950	950	90	28x34	28x34	A64	184
66969000	260.25 AHB	1/10Pl.,5/24,1/10Halter	H		5	100	740	740	84			D6	152
66569000	260.25 AHB	10/20,1/10Halter	H		10	100	780	780	50			D20	210
66704000	260.25 AHT	9/14	V		9	80	950	950	123	R25	R25	A11	126
66790000	260.25 AHT	14/13	V		14	80	950	950	100	R25	R25	A32	182
66867000	260.25 AHT	14/18,1/10Halter	H		14	100	780	780	50			D20	262
66606000	260.25 AHW	1/15,13/13	V	7,5	14	80	950	950	90	28x34	28x34	A64	184
66790000	260.25 AHW	14/13	V		14	80	950	950	100	R25	R25	A32	182
66867000	260.25 AHW	14/18,1/10Halter	H		14	100	780	780	50			D20	262
66374000	260.25 AN	9/14	V	6,5	9	80	950	950	153	R25	R25	A32	126
66704000	260.25 AN	9/14	V		9	80	950	950	123	R25	R25	A11	126
66606000	260.25 AN	1/15,13/13	V	7,5	14	80	950	950	90	28x34	28x34	A64	184
66620000	260.25 AN	14/13	V		14	80	900	1000	130	R25	R25	A32	182
66790000	260.25 AN	14/13	V		14	80	950	950	100	R25	R25	A32	182
66867000	260.25 AN	14/18,1/10Halter	H		14	100	780	780	50			D20	262
66919000	260.25 AN	18/18,1/10Halter	H		18	100	780	780	41			D20	334
66704000	260.25 ANW	9/14	V		9	80	950	950	123	R25	R25	A11	126
66606000	260.25 ANW	1/15,13/13	V	7,5	14	80	950	950	90	28x34	28x34	A64	184
66620000	260.25 ANW	14/13	V		14	80	900	1000	130	R25	R25	A32	182
66790000	260.25 ANW	14/13	V		14	80	950	950	100	R25	R25	A32	182
66867000	260.25 ANW	14/18,1/10Halter	H		14	100	780	780	50			D20	262
66919000	260.25 ANW	18/18,1/10Halter	H		18	100	780	780	41			D20	334
66970000	260.25 B	4/23	V		4	80	950	950	143	28x34	28x34	A20	115
66906000	260.25 B	9/14	V		9	80	950	950	146	28x34	28x34	A64	126
66379000	260.25 B	7/22,1/10Halter	H		7	100	740	740	33			D1.1	164
66397000	260.25 B	8/22,1/10Halter	H		8	100	740	740	28			D21	186
66981000	260.25 B	8/22,1/10Halter	H	10,5	8	100	740	740	99			D20	186
66970000	260.25 W	4/23	V		4	80	950	950	143	28x34	28x34	A20	115
66906000	260.25 W	9/14	V		9	80	950	950	146	28x34	28x34	A64	126
66379000	260.25 W	7/22,1/10Halter	H		7	100	740	740	33			D1.1	164
66397000	260.25 W	8/22,1/10Halter	H		8	100	740	740	28			D21	186
66981000	260.25 W	8/22,1/10Halter	H	10,5	8	100	740	740	99			D20	186
66790000	260.26 H	14/13	V		14	80	950	950	100	R25	R25	A32	182
66867000	260.26 H	14/18,1/10Halter	H		14	100	780	780	50			D20	262
66704000	260.26 HT	9/14	V		9	80	950	950	123	R25	R25	A11	126

260

IVECO

260

Artikel.Nr.	Fahrzeugtyp	Info	Achsl.	Blattzahl	Breite	Lx/L1	Ly/L2	Spr./ Kr.	Buchsen vorn	Buchsen hinten	Form	Paket- stärke
Art.-No.	Type		Axle Load	Leaves	Width			FreeArch /Crank	Bush front	Bush rear	Shape	Total height
66867000	260.26 HT	14/18,1/10Halter	H	14	100	780	780	50			D20	262
66790000	260.26 HW	14/13	V	14	80	950	950	100	R25	R25	A32	182
66867000	260.26 HW	14/18,1/10Halter	H	14	100	780	780	50			D20	262
66800000	260.26 N	10/15	V	10	80	950	950	102	R25	R25	A11	150
66790000	260.26 N	14/13	V	14	80	950	950	100	R25	R25	A32	182
66867000	260.26 N	14/18,1/10Halter	H	14	100	780	780	50			D20	262
66919000	260.26 N	18/18,1/10Halter	H	18	100	780	780	41			D20	334
66712000	260.26 NW	4/23	V	4	80	950	950	143	25	25	A20	115
66572000	260.26 NW	10/15	V	10	80	900	1000	100	R25	R25	A11	150
66620000	260.26 NW	14/13	V	14	80	900	1000	130	R25	R25	A32	182
66790000	260.26 NW	14/13	V	14	80	950	950	100	R25	R25	A32	182
66867000	260.26 NW	14/18,1/10Halter	H	14	100	780	780	50			D20	262
66919000	260.26 NW	18/18,1/10Halter	H	18	100	780	780	41			D20	334
66970000	260.30 AH	4/23	V	4	80	950	950	143	28x34	28x34	A20	115
66906000	260.30 AH	9/14	V	9	80	950	950	146	28x34	28x34	A64	126
66606000	260.30 AH	1/15,13/13	V	14	80	950	950	90	28x34	28x34	A64	184
66969000	260.30 AH	1/10Pl.,5/24,1/10Halter	H	5	100	740	740	84			D6	152
66981000	260.30 AH	8/22,1/10Halter	H	8	100	740	740	99			D20	186
66970000	260.30 AHT	4/23	V	4	80	950	950	143	28x34	28x34	A20	115
66969000	260.30 AHT	1/10Pl.,5/24,1/10Halter	H	5	100	740	740	84			D6	152
66906000	260.30 AHW	9/14	V	9	80	950	950	146	28x34	28x34	A64	126
66606000	260.30 AHW	1/15,13/13	V	14	80	950	950	90	28x34	28x34	A64	184
66981000	260.30 AHW	8/22,1/10Halter	H	8	100	740	740	99			D20	186
66704000	260.30 H	9/14	V	9	80	950	950	123	R25	R25	A11	126
66867000	260.30 H	14/18,1/10Halter	H	14	100	780	780	50			D20	262
66416000	260.30 T.R.U	4/21,1/10Pl.	V	4	90	900	900	199	35	35	A1	106
66839000	260.30 T.R.U	10/16	H	10	90	900	635				A1	160
66976000	260.30 T.R.U.	4/20,1/10Pl.	V	4	90	900	900	213	35x45	35x45	A19	102
66976000	260.30 T.R.U.	4/20,1/10Pl.	V	4	90	900	900	213	35x45	35x45	A19	102
66704000	260.32 AH	9/14	V	9	80	950	950	123	R25	R25	A11	126
66790000	260.32 AH	14/13	V	14	80	950	950	100	R25	R25	A32	182
66867000	260.32 AH	14/18,1/10Halter	H	14	100	780	780	50			D20	262
66526000	260.32 AHM	9/13	V	9	80	950	950	198	R25	R25	A32	117
66887000	260.32 AHM	14/10,2/16	H	16	100	580	850	116	R35	R35	A43	172
66704000	260.32 AHT	9/14	V	9	80	950	950	123	R25	R25	A11	126
66790000	260.32 AHT	14/13	V	14	80	950	950	100	R25	R25	A32	182
66867000	260.32 AHT	14/18,1/10Halter	H	14	100	780	780	50			D20	262
66704000	260.32 AHW	9/14	V	9	80	950	950	123	R25	R25	A11	126
66906000	260.32 AHW	9/14	V	9	80	950	950	146	28x34	28x34	A64	126
66606000	260.32 AHW	1/15,13/13	V	14	80	950	950	90	28x34	28x34	A64	184
66790000	260.32 AHW	14/13	V	14	80	950	950	100	R25	R25	A32	182
66867000	260.32 AHW	14/18,1/10Halter	H	14	100	780	780	50			D20	262
66374000	260.32 AHWM	9/14	V	9	80	950	950	153	R25	R25	A32	126
66569000	260.32 AHWM	10/20,1/10Halter	H	10	100	780	780	50			D20	210
66416000	260.32 T.R.U.	4/21,1/10Pl.	V	4	90	900	900	199	35	35	A1	106
66976000	260.32 T.R.U.	4/20,1/10Pl.	V	4	90	900	900	213	35x45	35x45	A19	102
66839000	260.32 T.R.U.	10/16	H	10	90	900	635				A1	160
66416000	260.32 TURBOTECH	4/21,1/10Pl.	V	4	90	900	900	199	35	35	A1	106
66976000	260.32 TURBOTECH	4/20,1/10Pl.	V	4	90	900	900	213	35x45	35x45	A19	102
66839000	260.32 TURBOTECH	10/16	H	10	90	900	635				A1	160
66970000	260.34 AH	4/23	V	4	80	950	950	143	28x34	28x34	A20	115
66906000	260.34 AH	9/14	V	9	80	950	950	146	28x34	28x34	A64	126
66606000	260.34 AH	1/15,13/13	V	14	80	950	950	90	28x34	28x34	A64	184
66969000	260.34 AH	1/10Pl.,5/24,1/10Halter	H	5	100	740	740	84			D6	152
66397000	260.34 AH	8/22,1/10Halter	H	8	100	740	740	28			D21	186

260

IVECO

260

Artikel.Nr.	Fahrzeugtyp	Info	Achsl.	Blattzahl	Breite	Lx/L1	Ly/L2	Spr./Kr.	Buchsen vorn	Buchsen hinten	Form	Paketstärke
Art.-No.	Type		Axle Load	Leaves	Width			FreeArch/Crank	Bush front	Bush rear	Shape	Total height
66981000	260.34 AH	8/22,1/10Halter	H	10,5	8	100	740	740	99			186
66790000	260.35 H	14/13	V		14	80	950	950	100	R25	A32	182
66867000	260.35 H	14/18,1/10Halter	H		14	100	780	780	50		D20	262
66704000	260.35 HT	9/14	V		9	80	950	950	123	R25	A11	126
66790000	260.35 HT	14/13	V		14	80	950	950	100	R25	A32	182
66867000	260.35 HT	14/18,1/10Halter	H		14	100	780	780	50		D20	262
66416000	260.36 T.R.U.	4/21,1/10Pl.	V		4	90	900	900	199	35	A1	106
66976000	260.36 T.R.U.	4/20,1/10Pl.	V		4	90	900	900	213	35x45	A19	102
66839000	260.36 T.R.U.	10/16	H		10	90	900	635			A1	160
66416000	260.36 TURBOSTAR	4/21,1/10Pl.	V		4	90	900	900	199	35	A1	106
66976000	260.36 TURBOSTAR	4/20,1/10Pl.	V		4	90	900	900	213	35x45	A19	102
66839000	260.36 TURBOSTAR	10/16	H		10	90	900	635			A1	160
66416000	260.36 TURBOTECH	4/21,1/10Pl.	V		4	90	900	900	199	35	A1	106
66976000	260.36 TURBOTECH	4/20,1/10Pl.	V		4	90	900	900	213	35x45	A19	102
66839000	260.36 TURBOTECH	10/16	H		10	90	900	635			A1	160
66416000	260.38 TURBOSTAR	4/21,1/10Pl.	V		4	90	900	900	199	35	A1	106
66976000	260.38 TURBOSTAR	4/20,1/10Pl.	V		4	90	900	900	213	35x45	A19	102
66839000	260.38 TURBOSTAR	10/16	H		10	90	900	635			A1	160
66416000	260.38 TURBOTECH	4/21,1/10Pl.	V		4	90	900	900	199	35	A1	106
66976000	260.38 TURBOTECH	4/20,1/10Pl.	V		4	90	900	900	213	35x45	A19	102
66839000	260.38 TURBOTECH	10/16	H		10	90	900	635			A1	160
66416000	260.48 TS	4/21,1/10Pl.	V		4	90	900	900	199	35	A1	106
66976000	260.48 TS	4/20,1/10Pl.	V		4	90	900	900	213	35x45	A19	102
66839000	260.48 TS	10/16	H		10	90	900	635			A1	160

300

IVECO

300

Artikel.Nr.	Fahrzeugtyp	Info	Achsl.	Blattzahl	Breite	Lx/L1	Ly/L2	Spr./ Kr.	Buchsen vorn	Buchsen hinten	Form	Paket- stärke
Art.-No.	Type		Axle Load	Leaves	Width			FreeArch /Crank	Bush front	Bush rear	Shape	Total height
66968000	300.25 AH	3/22	V	3	80	760	760	125	28x34	28x34	A20	98
66910000	300.25 AH	4/22	V	4	80	760	760	113	28	28	A20	100
66608000	300.25 AH	1/15,12/11	V	13	80	760	760	145	28x34	28x34	A32	147
66969000	300.25 AH	1/10Pl.,5/24,1/10Halter	H	5	100	740	740	84			D6	152
66987000	300.25 AH	6/22,1/10Halter	H	6	100	740	740				D1.1	142
66379000	300.25 AH	7/22,1/10Halter	H	7	100	740	740	33			D1.1	164
66968000	300.25 AHB	3/22	V	3	80	760	760	125	28x34	28x34	A20	98
66910000	300.25 AHB	4/22	V	4	80	760	760	113	28	28	A20	100
66608000	300.25 AHB	1/15,12/11	V	13	80	760	760	145	28x34	28x34	A32	147
66969000	300.25 AHB	1/10Pl.,5/24,1/10Halter	H	5	100	740	740	84			D6	152
66987000	300.25 AHB	6/22,1/10Halter	H	6	100	740	740				D1.1	142
66379000	300.25 AHB	7/22,1/10Halter	H	7	100	740	740	33			D1.1	164
66968000	300.30 AH	3/22	V	3	80	760	760	125	28x34	28x34	A20	98
66608000	300.30 AH	1/15,12/11	V	13	80	760	760	145	28x34	28x34	A32	147
66969000	300.30 AH	1/10Pl.,5/24,1/10Halter	H	5	100	740	740	84			D6	152
66981000	300.30 AH	8/22,1/10Halter	H	8	100	740	740	99			D20	186
66608000	300.30 AHB	1/15,12/11	V	13	80	760	760	145	28x34	28x34	A32	147
66379000	300.30 AHB	7/22,1/10Halter	H	7	100	740	740	33			D1.1	164
66968000	300.32 AH	3/22	V	3	80	760	760	125	28x34	28x34	A20	98
66969000	300.32 AH	1/10Pl.,5/24,1/10Halter	H	5	100	740	740	84			D6	152
66968000	300.34 AH	3/22	V	3	80	760	760	125	28x34	28x34	A20	98
66969000	300.34 AH	1/10Pl.,5/24,1/10Halter	H	5	100	740	740	84			D6	152

Artikel.Nr.	Fahrzeugtyp	Info	Achsl.	Blattzahl	Breite	Lx/L1	Ly/L2	Spr./Kr.	Buchsen vorn	Buchsen hinten	Form	Paketstärke	
Art.-No.	Type		Axle Load	Leaves	Width			FreeArch/Crank	Bush front	Bush rear	Shape	Total height	
66910000	320.32 AHB	4/22	V		4	80	760	760	113	28	28	A20	100
66608000	320.32 AHB	1/15,12/11	V		13	80	760	760	145	28x34	28x34	A32	147
66379000	320.32 AHB	7/22,1/10Halter	H		7	100	740	740	33			D1.1	164
66397000	320.32 AHB	8/22,1/10Halter	H		8	100	740	740	28			D21	186
66800000	330 P 26	10/15	V		10	80	950	950	102	R25	R25	A11	150
66800000	330 P 35	10/15	V		10	80	950	950	102	R25	R25	A11	150
66800000	330 PC 26	10/15	V		10	80	950	950	102	R25	R25	A11	150
66800000	330 PC 35	10/15	V		10	80	950	950	102	R25	R25	A11	150
66657000	330 PC 35	13/20,1/10Halter	H		13	100	780	780	60			D20	270
66800000	330 PT 26	10/15	V		10	80	950	950	102	R25	R25	A11	150
66800000	330 PT 35	10/15	V		10	80	950	950	102	R25	R25	A11	150
66919000	330 PT 35	18/18,1/10Halter	H		18	100	780	780	41			D20	334
66790000	330.25 AH	14/13	V		14	80	950	950	100	R25	R25	A32	182
66919000	330.25 AH	18/18,1/10Halter	H		18	100	780	780	41			D20	334
66620000	330.25 AN	14/13	V		14	80	900	1000	130	R25	R25	A32	182
66850000	330.25 AN	1/15,13/13	V		14	80	900	1000	111	28x34	28x34	E2	184
66387000	330.25 AN	Doppelachslast,11/22,1/10Halter	H	13,0	11	100	740	740	71			D20	252
66389000	330.25 AN	11/22,1/10Halter	H		11	100	730	730	29			D1.1	252
66919000	330.25 AN	18/18,1/10Halter	H		18	100	780	780	41			D20	334
66970000	330.26 H	4/23	V		4	80	950	950	143	28x34	28x34	A20	115
66606000	330.26 H	1/15,13/13	V	7,5	14	80	950	950	90	28x34	28x34	A64	184
66790000	330.26 H	14/13	V		14	80	950	950	100	R25	R25	A32	182
67167000	330.26 H	3/26,1/53,1/10Halter	H	13,0	4	100	730	730	75			D4	150
66973000	330.26 H	6/24,1/10Halter	H		6	100	720	720	87			D6	179
66387000	330.26 H	Doppelachslast,11/22,1/10Halter	H	13,0	11	100	740	740	71			D20	252
66389000	330.26 H	11/22,1/10Halter	H		11	100	730	730	29			D1.1	252
66790000	330.26 HT	14/13	V		14	80	950	950	100	R25	R25	A32	182
66919000	330.26 HT	18/18,1/10Halter	H		18	100	780	780	41			D20	334
66620000	330.26 N	14/13	V		14	80	900	1000	130	R25	R25	A32	182
66850000	330.26 N	1/15,13/13	V		14	80	900	1000	111	28x34	28x34	E2	184
66387000	330.26 N	Doppelachslast,11/22,1/10Halter	H	13,0	11	100	740	740	71			D20	252
66389000	330.26 N	11/22,1/10Halter	H		11	100	730	730	29			D1.1	252
66919000	330.26 N	18/18,1/10Halter	H		18	100	780	780	41			D20	334
66919000	330.26H	18/18,1/10Halter	H		18	100	780	780	41			D20	334
66970000	330.30	4/23	V		4	80	950	950	143	28x34	28x34	A20	115
66906000	330.30	9/14	V		9	80	950	950	146	28x34	28x34	A64	126
66606000	330.30	1/15,13/13	V	7,5	14	80	950	950	90	28x34	28x34	A64	184
66973000	330.30	6/24,1/10Halter	H		6	100	720	720	87			D6	179
66397000	330.30	8/22,1/10Halter	H		8	100	740	740	28			D21	186
66981000	330.30	8/22,1/10Halter	H	10,5	8	100	740	740	99			D20	186
66387000	330.30	Doppelachslast,11/22,1/10Halter	H	13,0	11	100	740	740	71			D20	252
66389000	330.30	11/22,1/10Halter	H		11	100	730	730	29			D1.1	252
66850000	330.30 AN	1/15,13/13	V		14	80	900	1000	111	28x34	28x34	E2	184
66981000	330.30 AN	8/22,1/10Halter	H	10,5	8	100	740	740	99			D20	186
66387000	330.30 AN	Doppelachslast,11/22,1/10Halter	H	13,0	11	100	740	740	71			D20	252
66389000	330.30 AN	11/22,1/10Halter	H		11	100	730	730	29			D1.1	252
67185000	330.30 AN	13/22,1/10Halter	H	16,0	13	100	730	730	73			D1.1	296
66850000	330.30 ANW	1/15,13/13	V		14	80	900	1000	111	28x34	28x34	E2	184
66981000	330.30 ANW	8/22,1/10Halter	H	10,5	8	100	740	740	99			D20	186
66387000	330.30 ANW	Doppelachslast,11/22,1/10Halter	H	13,0	11	100	740	740	71			D20	252
67185000	330.30 ANW	13/22,1/10Halter	H	16,0	13	100	730	730	73			D1.1	296
66970000	330.30 H	4/23	V		4	80	950	950	143	28x34	28x34	A20	115
66906000	330.30 H	9/14	V		9	80	950	950	146	28x34	28x34	A64	126
66606000	330.30 H	1/15,13/13	V	7,5	14	80	950	950	90	28x34	28x34	A64	184
67167000	330.30 H	3/26,1/53,1/10Halter	H	13,0	4	100	730	730	75			D4	150
66969000	330.30 H	1/10Pl.,5/24,1/10Halter	H		5	100	740	740	84			D6	152
66973000	330.30 H	6/24,1/10Halter	H		6	100	720	720	87			D6	179

330

IVECO

340

Artikel.Nr.	Fahrzeugtyp	Info	Achsl.	Blattzahl	Breite	Lx/L1	Ly/L2	Spr./ Kr.	Buchsen vorn	Buchsen hinten	Form	Paket- stärke	
Art.-No.	Type		Axle Load	Leaves	Width			FreeArch /Crank	Bush front	Bush rear	Shape	Total height	
66397000	330.30 H	8/22,1/10Halter	H	8	100	740	740	28			D21	186	
66981000	330.30 H	8/22,1/10Halter	H	10,5	8	100	740	740	99		D20	186	
66387000	330.30 H	Doppelachslast,11/22,1/10Halter	H	13,0	11	100	740	740	71		D20	252	
66389000	330.30 H	11/22,1/10Halter	H		11	100	730	730	29		D1.1	252	
66970000	330.30 HAT	4/23	V		4	80	950	950	143	28x34	28x34	A20	115
66606000	330.30 HAT	1/15,13/13	V	7,5	14	80	950	950	90	28x34	28x34	A64	184
66981000	330.30 HAT	8/22,1/10Halter	H	10,5	8	100	740	740	99		D20	186	
66387000	330.30 HT	Doppelachslast,11/22,1/10Halter	H	13,0	11	100	740	740	71		D20	252	
66850000	330.30 N	1/15,13/13	V		14	80	900	1000	111	28x34	28x34	E2	184
66397000	330.30 N	8/22,1/10Halter	H		8	100	740	740	28		D21	186	
66981000	330.30 N	8/22,1/10Halter	H	10,5	8	100	740	740	99		D20	186	
66387000	330.30 N	Doppelachslast,11/22,1/10Halter	H	13,0	11	100	740	740	71		D20	252	
66389000	330.30 N	11/22,1/10Halter	H		11	100	730	730	29		D1.1	252	
66850000	330.30 NW	1/15,13/13	V		14	80	900	1000	111	28x34	28x34	E2	184
66397000	330.30 NW	8/22,1/10Halter	H		8	100	740	740	28		D21	186	
66981000	330.30 NW	8/22,1/10Halter	H	10,5	8	100	740	740	99		D20	186	
66387000	330.30 NW	Doppelachslast,11/22,1/10Halter	H	13,0	11	100	740	740	71		D20	252	
66389000	330.30 NW	11/22,1/10Halter	H		11	100	730	730	29		D1.1	252	
66620000	330.32 AN	14/13	V		14	80	900	1000	130	R25	R25	A32	182
66919000	330.32 AN	18/18,1/10Halter	H		18	100	780	780	41		D20	334	
66620000	330.32 ANW	14/13	V		14	80	900	1000	130	R25	R25	A32	182
66850000	330.32 ANW	1/15,13/13	V		14	80	900	1000	111	28x34	28x34	E2	184
66387000	330.32 ANW	Doppelachslast,11/22,1/10Halter	H	13,0	11	100	740	740	71		D20	252	
66919000	330.32 ANW	18/18,1/10Halter	H		18	100	780	780	41		D20	334	
66970000	330.35	4/23	V		4	80	950	950	143	28x34	28x34	A20	115
66606000	330.35	1/15,13/13	V	7,5	14	80	950	950	90	28x34	28x34	A64	184
66387000	330.35	Doppelachslast,11/22,1/10Halter	H	13,0	11	100	740	740	71		D20	252	
66389000	330.35	11/22,1/10Halter	H		11	100	730	730	29		D1.1	252	
66970000	330.35 H	4/23	V		4	80	950	950	143	28x34	28x34	A20	115
66606000	330.35 H	1/15,13/13	V	7,5	14	80	950	950	90	28x34	28x34	A64	184
66790000	330.35 H	14/13	V		14	80	950	950	100	R25	R25	A32	182
66387000	330.35 H	Doppelachslast,11/22,1/10Halter	H	13,0	11	100	740	740	71		D20	252	
66389000	330.35 H	11/22,1/10Halter	H		11	100	730	730	29		D1.1	252	
66919000	330.35 H	18/18,1/10Halter	H		18	100	780	780	41		D20	334	
66970000	330.35 HT	4/23	V		4	80	950	950	143	28x34	28x34	A20	115
66704000	330.35 HT	9/14	V		9	80	950	950	123	R25	R25	A11	126
66606000	330.35 HT	1/15,13/13	V	7,5	14	80	950	950	90	28x34	28x34	A64	184
66387000	330.35 HT	Doppelachslast,11/22,1/10Halter	H	13,0	11	100	740	740	71		D20	252	
66919000	330.35 HT	18/18,1/10Halter	H		18	100	780	780	41		D20	334	
66606000	330.35 HW	1/15,13/13	V	7,5	14	80	950	950	90	28x34	28x34	A64	184
66790000	330.35 HW	14/13	V		14	80	950	950	100	R25	R25	A32	182
66387000	330.35 HW	Doppelachslast,11/22,1/10Halter	H	13,0	11	100	740	740	71		D20	252	
66919000	330.35 HW	18/18,1/10Halter	H		18	100	780	780	41		D20	334	
66970000	330.36	4/23	V		4	80	950	950	143	28x34	28x34	A20	115
66906000	330.36	9/14	V		9	80	950	950	146	28x34	28x34	A64	126
66606000	330.36	1/15,13/13	V	7,5	14	80	950	950	90	28x34	28x34	A64	184
66969000	330.36	1/10Pl.,5/24,1/10Halter	H		5	100	740	740	84		D6	152	
66973000	330.36	6/24,1/10Halter	H		6	100	720	720	87		D6	179	
66397000	330.36	8/22,1/10Halter	H		8	100	740	740	28		D21	186	
66981000	330.36	8/22,1/10Halter	H	10,5	8	100	740	740	99		D20	186	
66387000	330.36	Doppelachslast,11/22,1/10Halter	H	13,0	11	100	740	740	71		D20	252	
66389000	330.36	11/22,1/10Halter	H		11	100	730	730	29		D1.1	252	
66970000	330.36 AH	4/23	V		4	80	950	950	143	28x34	28x34	A20	115
66606000	330.36 AH	1/15,13/13	V	7,5	14	80	950	950	90	28x34	28x34	A64	184
66790000	330.36 AH	14/13	V		14	80	950	950	100		R25	A32	182
66387000	330.36 AH	Doppelachslast,11/22,1/10Halter	H	13,0	11	100	740	740	71		D20	252	
66919000	330.36 AH	18/18,1/10Halter	H		18	100	780	780	41		D20	334	

330

IVECO

340

Artikel.Nr.	Fahrzeugtyp	Info		Achsl.	Blattzahl	Breite	Lx/L1	Ly/L2	Spr./ Kr.	Buchsen vorn	Buchsen hinten	Form	Paket- stärke
Art.-No.	Type			Axle Load	Leaves	Width			FreeArch /Crank	Bush front	Bush rear	Shape	Total height
66970000	330.36 AHT	4/23	V		4	80	950	950	143	28x34	28x34	A20	115
66704000	330.36 AHT	9/14	V		9	80	950	950	123	R25	R25	A11	126
66387000	330.36 AHT	Doppelachslast,11/22,1/10Halter	H	13,0	11	100	740	740	71			D20	252
66919000	330.36 AHT	18/18,1/10Halter	H		18	100	780	780	41			D20	334
66970000	330.36 H	4/23	V		4	80	950	950	143	28x34	28x34	A20	115
66906000	330.36 H	9/14	V		9	80	950	950	146	28x34	28x34	A64	126
66606000	330.36 H	1/15,13/13	V	7,5	14	80	950	950	90	28x34	28x34	A64	184
67167000	330.36 H	3/26,1/53,1/10Halter	H	13,0	4	100	730	730	75			D4	150
66969000	330.36 H	1/10Pl.,5/24,1/10Halter	H		5	100	740	740	84			D6	152
66973000	330.36 H	6/24,1/10Halter	H		6	100	720	720	87			D6	179
66397000	330.36 H	8/22,1/10Halter	H		8	100	740	740	28			D21	186
66981000	330.36 H	8/22,1/10Halter	H	10,5	8	100	740	740	99			D20	186
66387000	330.36 H	Doppelachslast,11/22,1/10Halter	H	13,0	11	100	740	740	71			D20	252
66389000	330.36 H	11/22,1/10Halter	H		11	100	730	730	29			D1.1	252
66620000	330.40 ANWT	14/13	V		14	80	900	1000	130	R25	R25	A32	182
66929000	330.40 ANWT	13/20,1/10Halter	H		13	100	815	815	41			D20	270
66910000	340.34 AH	4/22	V		4	80	760	760	113	28	28	A20	100
66608000	340.34 AH	1/15,12/11	V		13	80	760	760	145	28x34	28x34	A32	147
66397000	340.34 AH	8/22,1/10Halter	H		8	100	740	740	28			D21	186
66981000	340.34 AH	8/22,1/10Halter	H	10,5	8	100	740	740	99			D20	186

DAILY

IVECO

DAILY

Artikel.Nr.	Fahrzeugtyp	Info	Achsl.	Blattzahl	Breite	Lx/L1	Ly/L2	Spr./ Kr.	Buchsen vorn	Buchsen hinten	Form	Paket- stärke	
Art.-No.	Type		Axle Load	Leaves	Width			FreeArch /Crank	Bush front	Bush rear	Shape	Total height	
67373000	29L CAMPER	1/24	H	1,9	1	80	750	750	192	16x40	16x40	A1	24
67393000	29L CAMPER	1/24	H	2,0	1	80	750	750	172	16x44	16x44	A1	24
67371000	29L10	1/24	H	2,0	1	80	750	750	137	16x40	16x40	A1	24
67387000	29L10	1/	H	2,0	1	80	750	722	113	16x40	16x40	A28	24
67389000	29L10	1/	H	2,0	1	80	750	722	101	16x40	16x40	A28	24
67393000	29L10	1/24	H	2,0	1	80	750	750	172	16x44	16x44	A1	24
67395000	29L10	1/24	H	2,0	1	80	750	750	137	16x44	16x44	A1	24
67441000	29L10		H	2,0	1	80	755	755	195	16x40	16x40	A1	24
67463000	29L12	1/24	L		1	80	750/28 4	330	73	16x40		L8.5	24
67387000	29L12	1/	H	2,0	1	80	750	722	113	16x40	16x40	A28	24
67389000	29L12	1/	H	2,0	1	80	750	722	101	16x40	16x40	A28	24
67393000	29L12	1/24	H	2,0	1	80	750	750	172	16x44	16x44	A1	24
67395000	29L12	1/24	H	2,0	1	80	750	750	137	16x44	16x44	A1	24
67441000	29L12		H	2,0	1	80	755	755	195	16x40	16x40	A1	24
67395000	29L13	1/24	H	2,0	1	80	750	750	137	16x44	16x44	A1	24
67351000	29L9	1/22	H		1	80	750	750	126			A1	22
67353000	29L9	1/22	H	3,2	1	80	750	750	172			A1	22
67361000	29L9	1/	H		1	80	750	750	137	16x40	16x40	A1	24
67371000	29L9	1/24	H	2,0	1	80	750	750	137	16x40	16x40	A1	24
67373000	29L9	1/24	H	1,9	1	80	750	750	192	16x40	16x40	A1	24
67393000	29L9	1/24	H	2,0	1	80	750	750	172	16x44	16x44	A1	24
67389000	29L9	1/	H	2,0	1	80	750	722	101	16x40	16x40	A28	24
67395000	29L9	1/24	H	2,0	1	80	750	750	137	16x44	16x44	A1	24
67191000	30.10 TURBO D.	3/9,2/15	H		5	60	700	715	153			E2	57
67199000	30.10 TURBO D.	4/9,2/15	H		6	60	700	715	172	16x40	16x40	E2	66
67191000	30.8	3/9,2/15	H		5	60	700	715	153			E2	57
67273000	30.8	3/9,2/15	H		5	60	700	715	153	16x38	24x30	E2	57
67295000	30.8	3/9,2/15	H		5	60	700	715	153	16x38	24x38	E2	57
67191000	30.8 NEW	3/9,2/15	H		5	60	700	715	153			E2	57
67199000	30.8 NEW	4/9,2/15	H		6	60	700	715	172	16x40	16x40	E2	66
67273000	32.8	3/9,2/15	H		5	60	700	715	153	16x38	24x30	E2	57
67295000	32.8	3/9,2/15	H		5	60	700	715	153	16x38	24x38	E2	57
67275000	32.8	3/9,2/15	H	3,2	6	60	700	715	160	16x38	24x30	E2	66
67297000	32.8	3/9,2/15	H		6	60	700	715	160	16x38	24x38	E2	66
66979000	35.10	2/15,1/25	H		3	60	700	715	156			A65	
67199000	35.10	4/9,2/15	H		6	60	700	715	172	16x40	16x40	E2	66
67455000	35.10	4/9,5/9	H		9	60	700	715	165	16x40	16x40	A28	81
67329000	35.10 BOFROST	1/P,1/25,1/P	H		1	60	700	715	114	16x40	16x40	E1	25
67465000	35.10 NEW	1/24	H		1	60	700	715		16	16	E1	
67467000	35.10 NEW	1/24	H		2	60				16x40	16x40	E2	
67183000	35.10 NEW	4/9,2/15	H		6	60	700	715	147	16x40	16x40	E2	66
67199000	35.10 NEW	4/9,2/15	H		6	60	700	715	172	16x40	16x40	E2	66
67143000	35.10 NEW	4/9,3/15	H		7	60	700	715	132	16x40	16x40	E2	81
67467000	35.10 TURBO D.	1/24	H		2	60				16x40	16x40	E2	
67183000	35.10 TURBO D.	4/9,2/15	H		6	60	700	715	147	16x40	16x40	E2	66
67199000	35.10 TURBO D.	4/9,2/15	H		6	60	700	715	172	16x40	16x40	E2	66
67143000	35.10 TURBO D.	4/9,3/15	H		7	60	700	715	132	16x40	16x40	E2	81
67179000	35.10 TURBO D.	4/9,3/15	H	3,0	7	60	700	715	140	16x40	16x40	E2	81
67455000	35.10 TURBO D.	4/9,5/9	H		9	60	700	715	165	16x40	16x40	A28	81
67329000	35.12 BOFROST	1/P,1/25,1/P	H		1	60	700	715	114	16x40	16x40	E1	25
67465000	35.12 TURBO D.	1/24	H		1	60	700	715		16	16	E1	
67467000	35.12 TURBO D.	1/24	H		2	60				16x40	16x40	E2	
67183000	35.12 TURBO D.	4/9,2/15	H		6	60	700	715	147	16x40	16x40	E2	66
67199000	35.12 TURBO D.	4/9,2/15	H		6	60	700	715	172	16x40	16x40	E2	66
67143000	35.12 TURBO D.	4/9,3/15	H		7	60	700	715	132	16x40	16x40	E2	81
67455000	35.12 TURBO D.	4/9,5/9	H		9	60	700	715	165	16x40	16x40	A28	81

DAILY

IVECO

DAILY

Artikel.Nr.	Fahrzeugtyp	Info	Achsl.	Blattzahl	Breite	Lx/L1	Ly/L2	Spr./Kr.	Buchsen vorn	Buchsen hinten	Form	Paketstärke
Art.-No.	Type		Axle Load	Leaves	Width			FreeArch/Crank	Bush front	Bush rear	Shape	Total height
67199000	35.8	4/9,2/15	H		60	700	715	172	16x40	16x40	E2	66
67277000	35.8	4/9,2/15	H	3,2	60	700	715	172	16x38	24x38	E2	66
67279000	35.8	4/9,2/15	H	3,2-3,6	60	700	715	172	16x38	24x30	E2	66
67281000	35.8	4/9,2/15	H	2,8	60	700	715	130	16x38	24x30	E2	66
67183000	35.8 RESTYLING	4/9,2/15	H		60	700	715	147	16x40	16x40	E2	66
67467000	35.8 NEW	1/24	H		60				16x40	16x40	E2	
67183000	35.8 NEW	4/9,2/15	H		60	700	715	147	16x40	16x40	E2	66
67199000	35.8 NEW	4/9,2/15	H		60	700	715	172	16x40	16x40	E2	66
67143000	35.8 NEW	4/9,3/15	H		60	700	715	132	16x40	16x40	E2	81
67290000	35.8H	4/10	V		60	650	680	67	16x38	24x30	E1	40
67290000	35.8H	4/10	V		60	650	680	67	16x38	24x30	E1	40
67143000	35.8H	4/9,3/15	H		60	700	715	132	16x40	16x40	E2	81
67143000	35.8H	4/9,3/15	H		60	700	715	132	16x40	16x40	E2	81
67285000	35.8H	4/9,3/15	H		60	700	715	132	16x38	24x30	E2	81
67285000	35.8H	4/9,3/15	H		60	700	715	132	16x38	24x30	E2	81
67363000	35C10	2/19	H		60	700	715	134	16x40	16x40	E1	41
67377000	35C10	2/19	H		60	700	715	134	16x44	16x44	E1	41
67399000	35C10	2/22	H	3,1	60	700	715	142	16x40	16x40	E1	47
67403000	35C10	2/22	H	3,1	60	700	715	142	16x44	16x44	E1	47
67471000	35C10		H	3,1	60	700	715		16x43	16x43	E2	
67183000	35C10	4/9,2/15	H		60	700	715	147	16x40	16x40	E2	66
67199000	35C10	4/9,2/15	H		60	700	715	172	16x40	16x40	E2	66
67461000	35C10	4/9,2/15	H		60	700	715	147	16x43	16x43	E2	66
67143000	35C10	4/9,3/15	H		60	700	715	132	16x40	16x40	E2	81
67397000	35C10	4/9,3/15	H		60	700	715	132	16x44	16x44	E2	81
67469000	35C10	4/9,3/15	H		60	700	715		16x43	16x43	E2	
67437000	35C10	6/9,6/8,1/9Pl.	H		60	700	715	168	16x44	16x44	A28	111
67437900	35C10	6/9,6/8,1/9Pl.	H		60	700	715	168	16x40	16x40	A28	111
67447000	35C10	7/9,6/8,1/9Pl.	H		60	700	715		16x43	16x43	A28	
67350000	35C11	1/20	V		80	1370		84			D19	20
67352000	35C11	1/24	V		80	1370					D19	24
67335000	35C11	2/19,1/25Pl.	H		60	700	715	134	16x44	16x44	E1	63
67363000	35C11	2/19	H		60	700	715	134	16x40	16x40	E1	41
67365000	35C11	2/19,1/25Pl.	H		60	700	715	134	16x40	16x40	E1	63
67377000	35C11	2/19	H		60	700	715	134	16x44	16x44	E1	41
67183000	35C11	4/9,2/15	H		60	700	715	147	16x40	16x40	E2	66
67199000	35C11	4/9,2/15	H		60	700	715	172	16x40	16x40	E2	66
67461000	35C11	4/9,2/15	H		60	700	715	147	16x43	16x43	E2	66
67143000	35C11	4/9,3/15	H		60	700	715	132	16x40	16x40	E2	81
67397000	35C11	4/9,3/15	H		60	700	715	132	16x44	16x44	E2	81
67469000	35C11	4/9,3/15	H		60	700	715		16x43	16x43	E2	
67437000	35C11	6/9,6/8,1/9Pl.	H		60	700	715	168	16x44	16x44	A28	111
67437900	35C11	6/9,6/8,1/9Pl.	H		60	700	715	168	16x40	16x40	A28	111
67447000	35C11	7/9,6/8,1/9Pl.	H		60	700	715		16x43	16x43	A28	
67349000	35C12	1/29	H		60	700	715	128	16x44	16x44	E1	
67335000	35C12	2/19,1/25Pl.	H		60	700	715	134	16x44	16x44	E1	63
67363000	35C12	2/19	H		60	700	715	134	16x40	16x40	E1	41
67365000	35C12	2/19,1/25Pl.	H		60	700	715	134	16x40	16x40	E1	63
67377000	35C12	2/19	H		60	700	715	134	16x44	16x44	E1	41
67399000	35C12	2/22	H	3,1	60	700	715	142	16x40	16x40	E1	47
67403000	35C12	2/22	H	3,1	60	700	715	142	16x44	16x44	E1	47
67471000	35C12		H	3,1	60	700	715		16x43	16x43	E2	
67183000	35C12	4/9,2/15	H		60	700	715	147	16x40	16x40	E2	66
67199000	35C12	4/9,2/15	H		60	700	715	172	16x40	16x40	E2	66
67461000	35C12	4/9,2/15	H		60	700	715	147	16x43	16x43	E2	66
67143000	35C12	4/9,3/15	H		60	700	715	132	16x40	16x40	E2	81

DAILY

IVECO

DAILY

Artikel.Nr.	Fahrzeugtyp	Info	Achsl.	Blattzahl	Breite	Lx/L1	Ly/L2	Spr./ Kr.	Buchsen vorn	Buchsen hinten	Form	Paket- stärke	
Art.-No.	Type		Axle Load	Leaves	Width			FreeArch /Crank	Bush front	Bush rear	Shape	Total height	
67397000	35C12	4/9,3/15	H		7	60	700	715	132	16x44	16x44	E2	81
67469000	35C12	4/9,3/15	H		7	60	700	715		16x43	16x43	E2	
67350000	35C13	1/20	V		1	80	1370		84			D19	20
67352000	35C13	1/24	V		1	80	1370					D19	24
67335000	35C13	2/19,1/25Pl.	H		2	60	700	715	134	16x44	16x44	E1	63
67363000	35C13	2/19	H		2	60	700	715	134	16x40	16x40	E1	41
67365000	35C13	2/19,1/25Pl.	H		2	60	700	715	134	16x40	16x40	E1	63
67377000	35C13	2/19	H		2	60	700	715	134	16x44	16x44	E1	41
67399000	35C13	2/22	H	3,1	2	60	700	715	142	16x40	16x40	E1	47
67403000	35C13	2/22	H	3,1	2	60	700	715	142	16x44	16x44	E1	47
67471000	35C13		H	3,1	2	60	700	715		16x43	16x43	E2	
67183000	35C13	4/9,2/15	H		6	60	700	715	147	16x40	16x40	E2	66
67199000	35C13	4/9,2/15	H		6	60	700	715	172	16x40	16x40	E2	66
67461000	35C13	4/9,2/15	H		6	60	700	715	147	16x43	16x43	E2	66
67143000	35C13	4/9,3/15	H		7	60	700	715	132	16x40	16x40	E2	81
67397000	35C13	4/9,3/15	H		7	60	700	715	132	16x44	16x44	E2	81
67469000	35C13	4/9,3/15	H		7	60	700	715		16x43	16x43	E2	
67437000	35C13	6/9,6/8,1/9Pl.	H		12	60	700	715	168	16x44	16x44	A28	111
67437900	35C13	6/9,6/8,1/9Pl.	H		12	60	700	715	168	16x40	16x40	A28	111
67350000	35C15	1/20	V		1	80	1370		84			D19	20
67352000	35C15	1/24	V		1	80	1370					D19	24
67349000	35C15	1/29	H		1	60	700	715	128	16x44	16x44	E1	
67363000	35C15	2/19	H		2	60	700	715	134	16x40	16x40	E1	41
67365000	35C15	2/19,1/25Pl.	H		2	60	700	715	134	16x40	16x40	E1	63
67377000	35C15	2/19	H		2	60	700	715	134	16x44	16x44	E1	41
67399000	35C15	2/22	H	3,1	2	60	700	715	142	16x40	16x40	E1	47
67403000	35C15	2/22	H	3,1	2	60	700	715	142	16x44	16x44	E1	47
67471000	35C15		H	3,1	2	60	700	715		16x43	16x43	E2	
67183000	35C15	4/9,2/15	H		6	60	700	715	147	16x40	16x40	E2	66
67199000	35C15	4/9,2/15	H		6	60	700	715	172	16x40	16x40	E2	66
67461000	35C15	4/9,2/15	H		6	60	700	715	147	16x43	16x43	E2	66
67143000	35C15	4/9,3/15	H		7	60	700	715	132	16x40	16x40	E2	81
67397000	35C15	4/9,3/15	H		7	60	700	715	132	16x44	16x44	E2	81
67469000	35C15	4/9,3/15	H		7	60	700	715		16x43	16x43	E2	
67437000	35C15	6/9,6/8,1/9Pl.	H		12	60	700	715	168	16x44	16x44	A28	111
67437900	35C15	6/9,6/8,1/9Pl.	H		12	60	700	715	168	16x40	16x40	A28	111
67447000	35C15	7/9,6/8,1/9Pl.	H		13	60	700	715		16x43	16x43	A28	
67350000	35C9	1/20	V		1	80	1370		84			D19	20
67352000	35C9	1/24	V		1	80	1370					D19	24
67349000	35C9	1/29	H		1	60	700	715	128	16x44	16x44	E1	
67445000	35C9	1/27+Pl.	H		1	60	700	715		16	16	E1	
67335000	35C9	2/19,1/25Pl.	H		2	60	700	715	134	16x44	16x44	E1	63
67363000	35C9	2/19	H		2	60	700	715	134	16x40	16x40	E1	41
67365000	35C9	2/19,1/25Pl.	H		2	60	700	715	134	16x40	16x40	E1	63
67377000	35C9	2/19	H		2	60	700	715	134	16x44	16x44	E1	41
67399000	35C9	2/22	H	3,1	2	60	700	715	142	16x40	16x40	E1	47
67403000	35C9	2/22	H	3,1	2	60	700	715	142	16x44	16x44	E1	47
67471000	35C9		H	3,1	2	60	700	715		16x43	16x43	E2	
67183000	35C9	4/9,2/15	H		6	60	700	715	147	16x40	16x40	E2	66
67199000	35C9	4/9,2/15	H		6	60	700	715	172	16x40	16x40	E2	66
67461000	35C9	4/9,2/15	H		6	60	700	715	147	16x43	16x43	E2	66
67437000	35C9	6/9,6/8,1/9Pl.	H		12	60	700	715	168	16x44	16x44	A28	111
67437900	35C9	6/9,6/8,1/9Pl.	H		12	60	700	715	168	16x40	16x40	A28	111
67447000	35C9	7/9,6/8,1/9Pl.	H		13	60	700	715		16x43	16x43	A28	
67373000	35S CAMPER	1/24	H	1,9	1	80	750	750	192	16x40	16x40	A1	24
67393000	35S CAMPER	1/24	H	2,0	1	80	750	750	172	16x44	16x44	A1	24
67441000	35S CAMPER		H	2,0	1	80	755	755	195	16x40	16x40	A1	24

DAILY

IVECO

DAILY

Artikel.Nr.	Fahrzeugtyp	Info	Achsl.	Blattzahl	Breite	Lx/L1	Ly/L2	Spr./Kr.	Buchsen vorn	Buchsen hinten	Form	Paketstärke	
Art.-No.	Type		Axle Load	Leaves	Width			FreeArch /Crank	Bush front	Bush rear	Shape	Total height	
67371000	35S10	1/24	H	2,0	1	80	750	750	137	16x40	16x40	A1	24
67387000	35S10	1/	H	2,0	1	80	750	722	113	16x40	16x40	A28	24
67389000	35S10	1/	H	2,0	1	80	750	722	101	16x40	16x40	A28	24
67393000	35S10	1/24	H	2,0	1	80	750	750	172	16x44	16x44	A1	24
67395000	35S10	1/24	H	2,0	1	80	750	750	137	16x44	16x44	A1	24
67441000	35S10		H	2,0	1	80	755	755	195	16x40	16x40	A1	24
67353000	35S11	1/22	H	3,2	1	80	750	750	172			A1	22
67355000	35S11	1/	H	3,5	1	80	750	750	150	16x40	16x40	A1	24
67357000	35S11	1/	H	1,9	1	80	750	750	183	16x40	16x40	A1	20
67361000	35S11	1/	H		1	80	750	750	137	16x40	16x40	A1	24
67371000	35S11	1/24	H	2,0	1	80	750	750	137	16x40	16x40	A1	24
67373000	35S11	1/24	H	1,9	1	80	750	750	192	16x40	16x40	A1	24
67389000	35S11	1/	H	2,0	1	80	750	722	101	16x40	16x40	A28	24
67393000	35S11	1/24	H	2,0	1	80	750	750	172	16x44	16x44	A1	24
67395000	35S11	1/24	H	2,0	1	80	750	750	137	16x44	16x44	A1	24
67441000	35S11		H	2,0	1	80	755	755	195	16x40	16x40	A1	24
67359000	35S11	1/20,1/20	H	2	80	750	750	750	173	16x40	16x40	A9	43
67463000	35S11	1/24	L	1	80	750/284	330	73	16x40		L8.5	24	
67375000	35S11 PASSO	1/24	H	1	80	750	750	750	150	16x40	16x40	A1	24
67395000	35S11 PASSO	1/24	H	2,0	1	80	750	750	137	16x44	16x44	A1	24
67371000	35S12	1/24	H	2,0	1	80	750	750	137	16x40	16x40	A1	24
67387000	35S12	1/	H	2,0	1	80	750	722	113	16x40	16x40	A28	24
67389000	35S12	1/	H	2,0	1	80	750	722	101	16x40	16x40	A28	24
67393000	35S12	1/24	H	2,0	1	80	750	750	172	16x44	16x44	A1	24
67395000	35S12	1/24	H	2,0	1	80	750	750	137	16x44	16x44	A1	24
67441000	35S12		H	2,0	1	80	755	755	195	16x40	16x40	A1	24
67353000	35S13	1/22	H	3,2	1	80	750	750	172			A1	22
67355000	35S13	1/	H	3,5	1	80	750	750	150	16x40	16x40	A1	24
67357000	35S13	1/	H	1,9	1	80	750	750	183	16x40	16x40	A1	20
67361000	35S13	1/	H		1	80	750	750	137	16x40	16x40	A1	24
67371000	35S13	1/24	H	2,0	1	80	750	750	137	16x40	16x40	A1	24
67373000	35S13	1/24	H	1,9	1	80	750	750	192	16x40	16x40	A1	24
67389000	35S13	1/	H	2,0	1	80	750	722	101	16x40	16x40	A28	24
67393000	35S13	1/24	H	2,0	1	80	750	750	172	16x44	16x44	A1	24
67395000	35S13	1/24	H	2,0	1	80	750	750	137	16x44	16x44	A1	24
67441000	35S13		H	2,0	1	80	755	755	195	16x40	16x40	A1	24
67359000	35S13	1/20,1/20	H	2	80	750	750	750	173	16x40	16x40	A9	43
67463000	35S13	1/24	L	1	80	750	330	73	16x40		L8.5	24	
67375000	35S13 PASSO	1/24	H	1	80	750	750	750	150	16x40	16x40	A1	24
67395000	35S13 PASSO	1/24	H	2,0	1	80	750	750	137	16x44	16x44	A1	24
67371000	35S15	1/24	H	2,0	1	80	750	750	137	16x40	16x40	A1	24
67373000	35S15	1/24	H	1,9	1	80	750	750	192	16x40	16x40	A1	24
67387000	35S15	1/	H	2,0	1	80	750	722	113	16x40	16x40	A28	24
67393000	35S15	1/24	H	2,0	1	80	750	750	172	16x44	16x44	A1	24
67395000	35S15	1/24	H	2,0	1	80	750	750	137	16x44	16x44	A1	24
67441000	35S15		H	2,0	1	80	755	755	195	16x40	16x40	A1	24
67463000	35S15	1/24	L	1	80	750	330	73	16x40		L8.5	24	
67353000	35S9	1/22	H	3,2	1	80	750	750	172			A1	22
67355000	35S9	1/	H	3,5	1	80	750	750	150	16x40	16x40	A1	24
67357000	35S9	1/	H	1,9	1	80	750	750	183	16x40	16x40	A1	20
67361000	35S9	1/	H		1	80	750	750	137	16x40	16x40	A1	24
67371000	35S9	1/24	H	2,0	1	80	750	750	137	16x40	16x40	A1	24
67373000	35S9	1/24	H	1,9	1	80	750	750	192	16x40	16x40	A1	24
67375000	35S9	1/24	H	1	80	750	750	750	150	16x40	16x40	A1	24
67387000	35S9	1/	H	2,0	1	80	750	722	113	16x40	16x40	A28	24
67389000	35S9	1/	H	2,0	1	80	750	722	101	16x40	16x40	A28	24
67393000	35S9	1/24	H	2,0	1	80	750	750	172	16x44	16x44	A1	24

DAILY

IVECO

DAILY

Artikel.Nr.	Fahrzeugtyp	Info	Achsl.	Blattzahl	Breite	Lx/L1	Ly/L2	Spr./ Kr.	Buchsen vorn	Buchsen hinten	Form	Paket- stärke	
Art.-No.	Type		Axle Load	Leaves	Width			FreeArch /Crank	Bush front	Bush rear	Shape	Total height	
67395000	35S9	1/24	H	2,0	1	80	750	750	137	16x44	16x44	A1	24
67441000	35S9		H	2,0	1	80	755	755	195	16x40	16x40	A1	24
67359000	35S9	1/20,1/20	H		2	80	750	750	173	16x40	16x40	A9	43
67463000	35S9	1/24	L		1	80	750	330	73	16x40		L8.5	24
67375000	35S9 PASSO	1/24	H		1	80	750	750	150	16x40	16x40	A1	24
67395000	35S9 PASSO	1/24	H	2,0	1	80	750	750	137	16x44	16x44	A1	24
67101000	40.10	4/9,3/15	H		7	60	700	715	125	16x39	24x30	E2	84
67109000	40.10	4/9,3/16	H		7	60	700	715	142	16x39	24x30	E2	84
67187000	40.10 TURBOD.	9/9	H		9	60	700	715	146	16x40	16x40	E1	81
67187000	40.10W	9/9	H		9	60	700	715	146	16x40	16x40	E1	81
67143000	40.8	4/9,3/15	H		7	60	700	715	132	16x40	16x40	E2	81
67179000	40.8	4/9,3/15	H	3,0	7	60	700	715	140	16x40	16x40	E2	81
67285000	40.8	4/9,3/15	H		7	60	700	715	132	16x38	24x30	E2	81
67143000	40.8 NEW	4/9,3/15	H		7	60	700	715	132	16x40	16x40	E2	81
67179000	40.8 NEW	4/9,3/15	H	3,0	7	60	700	715	140	16x40	16x40	E2	81
67397000	40.8 NEW	4/9,3/15	H		7	60	700	715	132	16x44	16x44	E2	81
67469000	40.8 NEW	4/9,3/15	H		7	60	700	715		16x43	16x43	E2	
67290000	40.8H	4/10	V		4	60	650	680	67	16x38	24x30	E1	40
67143000	40.8H	4/9,3/15	H		7	60	700	715	132	16x40	16x40	E2	81
67285000	40.8H	4/9,3/15	H		7	60	700	715	132	16x38	24x30	E2	81
67399000	40C11	2/22	H	3,1	2	60	700	715	142	16x40	16x40	E1	47
67403000	40C11	2/22	H	3,1	2	60	700	715	142	16x44	16x44	E1	47
67143000	40C11	4/9,3/15	H		7	60	700	715	132	16x40	16x40	E2	81
67399000	40C13	2/22	H	3,1	2	60	700	715	142	16x40	16x40	E1	47
67403000	40C13	2/22	H	3,1	2	60	700	715	142	16x44	16x44	E1	47
67143000	40C13	4/9,3/15	H		7	60	700	715	132	16x40	16x40	E2	81
67437000	40C13	6/9,6/8,1/9PI.	H		12	60	700	715	168	16x44	16x44	A28	111
67437900	40C13	6/9,6/8,1/9PI.	H		12	60	700	715	168	16x40	16x40	A28	111
67399000	40C15	2/22	H	3,1	2	60	700	715	142	16x40	16x40	E1	47
67403000	40C15	2/22	H	3,1	2	60	700	715	142	16x44	16x44	E1	47
67471000	40C15		H	3,1	2	60	700	715		16x43	16x43	E2	
67143000	40C15	4/9,3/15	H		7	60	700	715	132	16x40	16x40	E2	81
67397000	40C15	4/9,3/15	H		7	60	700	715	132	16x44	16x44	E2	81
67469000	40C15	4/9,3/15	H		7	60	700	715		16x43	16x43	E2	
67437000	40C15	6/9,6/8,1/9PI.	H		12	60	700	715	168	16x44	16x44	A28	111
67437900	40C15	6/9,6/8,1/9PI.	H		12	60	700	715	168	16x40	16x40	A28	111
67447000	40C15	7/9,6/8,1/9PI.	H		13	60	700	715		16x43	16x43	A28	
66989000	45.10	4/9,3/15	H		7	60	700	715	140	16x39	24x30	E2	81
66989000	45.10	4/9,3/15	H		7	60	700	715	140	16x39	24x30	E2	81
67179000	45.10	4/9,3/15	H	3,0	7	60	700	715	140	16x40	16x40	E2	81
67179000	45.10	4/9,3/15	H	3,0	7	60	700	715	140	16x40	16x40	E2	81
67379000	45.10	8/9	H		8	60	700	715	195	16x40	16x40	E1	72
67379000	45.10	8/9	H		8	60	700	715	195	16x40	16x40	E1	72
67179000	45.10 NEW	4/9,3/15	H	3,0	7	60	700	715	140	16x40	16x40	E2	81
67179000	45.10 NEW	4/9,3/15	H	3,0	7	60	700	715	140	16x40	16x40	E2	81
67303000	45.10 NEW	9/9	H		9	60	700	715	191	16x40	16x40	E1	81
67303000	45.10 NEW	9/9	H		9	60	700	715	191	16x40	16x40	E1	81
67405000	45.10 NEW	9/9	H		9	60	700	715	191	16x44	16x44	E1	81
67405000	45.10 NEW	9/9	H		9	60	700	715	191	16x44	16x44	E1	81
67473000	45.10 NEW	9/9	H		9	60	700	715	191	16x43	16x43	E1	81
67473000	45.10 NEW	9/9	H		9	60	700	715	191	16x43	16x43	E1	81
67383000	45C11	2/22	H		2	60	700	715	133	16x44	16x44	E1	47
67475000	45C11	2/22	H		2	60	700	715	133	16x40	16x40	E1	44
67179000	45C11	4/9,3/15	H	3,0	7	60	700	715	140	16x40	16x40	E2	81
67383000	45C13	2/22	H		2	60	700	715	133	16x44	16x44	E1	47
67475000	45C13	2/22	H		2	60	700	715	133	16x40	16x40	E1	44
67179000	45C13	4/9,3/15	H	3,0	7	60	700	715	140	16x40	16x40	E2	81

DAILY

IVECO

DAILY

Artikel.Nr.	Fahrzeugtyp	Info	Achsl.	Blattzahl	Breite	Lx/L1	Ly/L2	Spr./Kr.	Buchsen vorn	Buchsen hinten	Form	Paketstärke
Art.-No.	Type		Axle Load	Leaves	Width			FreeArch/Crank	Bush front	Bush rear	Shape	Total height
67381000	45C13	7/9,6/8	H	13	60	700	715	173	16x40	16x40	A28	174
67383000	45C15	2/22	H	2	60	700	715	133	16x44	16x44	E1	47
67475000	45C15	2/22	H	2	60	700	715	133	16x40	16x40	E1	44
67179000	45C15	4/9,3/15	H	7	60	700	715	140	16x40	16x40	E2	81
67381000	45C15	7/9,6/8	H	13	60	700	715	173	16x40	16x40	A28	174
67109000	49.10	4/9,3/16	H	7	60	700	715	142	16x39	24x30	E2	84
67189000	49.10	4/9,3/16	H	7	60	700	715	140	16x40	16x40	E2	84
67227000	49.10	4/9,3/16	H	7	60	700	715	140	16x38	24x30	E2	84
67381000	49.10	7/9,6/8	H	13	60	700	715	173	16x40	16x40	A28	174
67305000	49.10	1/35,1/9,P/40	L	2	60	700/229	340/90	53/240	16x40	16x40	L19	84
67307000	49.10	1/35,1/9,P/20	L	2	60	700/229	340/90	53/240	16x40		L19	64
66979000	49.10 RESTYLING	2/15,1/25	H	3	60	700	715	156			A65	
67189000	49.10 RESTYLING	4/9,3/16	H	7	60	700	715	140	16x40	16x40	E2	84
67227000	49.10 RESTYLING	4/9,3/16	H	7	60	700	715	140	16x38	24x30	E2	84
66979000	49.10NEW	2/15,1/25	H	3	60	700	715	156			A65	
67189000	49.10NEW	4/9,3/16	H	7	60	700	715	140	16x40	16x40	E2	84
67303000	49.10NEW	9/9	H	9	60	700	715	191	16x40	16x40	E1	81
67405000	49.10NEW	9/9	H	9	60	700	715	191	16x44	16x44	E1	81
67473000	49.10NEW	9/9	H	9	60	700	715	191	16x43	16x43	E1	81
67179000	49.10TURBOD.	4/9,3/15	H	7	60	700	715	140	16x40	16x40	E2	81
67189000	49.10TURBOD.	4/9,3/16	H	7	60	700	715	140	16x40	16x40	E2	84
67301000	49.10TURBOD.	5/9,3/17	H	8	60	700	715	117	16x40	16x40	E2	96
67303000	49.10TURBOD.	9/9	H	9	60	700	715	191	16x40	16x40	E1	81
67405000	49.10TURBOD.	9/9	H	9	60	700	715	191	16x44	16x44	E1	81
67305000	49.10TURBOD.	1/35,1/9,P/40	L	2	60	700/229	340/90	53/240	16x40	16x40	L19	84
67305000	49.12	1/35,1/9,P/40	L	2	60	700/229	340/90	53/240	16x40	16x40	L19	84
67307000	49.12	1/35,1/9,P/20	L	2	60	700/229	340/90	53/240	16x40		L19	64
66979000	49.12RESTYLING	2/15,1/25	H	3	60	700	715	156			A65	
67305000	49.12TURBOD.	1/35,1/9,P/40	L	2	60	700/229	340/90	53/240	16x40	16x40	L19	84
66979000	49.12TURBOD.	2/15,1/25	H	3	60	700	715	156			A65	
67189000	49.12TURBOD.	4/9,3/16	H	7	60	700	715	140	16x40	16x40	E2	84
67301000	49.12TURBOD.	5/9,3/17	H	8	60	700	715	117	16x40	16x40	E2	96
67303000	49.12TURBOD.	9/9	H	9	60	700	715	191	16x40	16x40	E1	81
67405000	49.12TURBOD.	9/9	H	9	60	700	715	191	16x44	16x44	E1	81
67369000	50C11	3/22	H	3	60	700	715	106	16x40	16x40	E1	72
67407000	50C11	3/22	H	3	60	700	715	106	16x44	16x44	E1	72
67179000	50C11	4/9,3/15	H	7	60	700	715	140	16x40	16x40	E2	81
67189000	50C11	4/9,3/16	H	7	60	700	715	140	16x40	16x40	E2	84
67439000	50C11	4/9,3/16	H	7	60	700	715	140	16x43	16x43	E2	84
67451000	50C11		L		60						L9.2	
67453000	50C11		L		60						L9.1	
67381000	50C12	7/9,6/8	H	13	60	700	715	173	16x40	16x40	A28	174
67447000	50C12	7/9,6/8,1/9Pl.	H	13	60	700	715		16x43	16x43	A28	
67369000	50C13	3/22	H	3	60	700	715	106	16x40	16x40	E1	72
67407000	50C13	3/22	H	3	60	700	715	106	16x44	16x44	E1	72
67189000	50C13	4/9,3/16	H	7	60	700	715	140	16x40	16x40	E2	84
67439000	50C13	4/9,3/16	H	7	60	700	715	140	16x43	16x43	E2	84
67437000	50C13	6/9,6/8,1/9Pl.	H	12	60	700	715	168	16x44	16x44	A28	111
67381000	50C13	7/9,6/8	H	13	60	700	715	173	16x40	16x40	A28	174
67451000	50C13		L		60						L9.2	
67453000	50C13		L		60						L9.1	
67369000	50C14	3/22	H	3	60	700	715	106	16x40	16x40	E1	72
67407000	50C14	3/22	H	3	60	700	715	106	16x44	16x44	E1	72
67189000	50C14	4/9,3/16	H	7	60	700	715	140	16x40	16x40	E2	84
67439000	50C14	4/9,3/16	H	7	60	700	715	140	16x43	16x43	E2	84
67405000	50C14	9/9	H	9	60	700	715	191	16x44	16x44	E1	81
67473000	50C14	9/9	H	9	60	700	715	191	16x43	16x43	E1	81

DAILY

IVECO

DAILY

Artikel.Nr.	Fahrzeugtyp	Info	Achsl.	Blattzahl	Breite	Lx/L1	Ly/L2	Spr./Kr.	Buchsen vorn	Buchsen hinten	Form	Paketstärke	
Art.-No.	Type		Axle Load	Leaves	Width			FreeArch/Crank	Bush front	Bush rear	Shape	Total height	
67381000	50C14	7/9,6/8	H	3,0	13	60	700	715	173	16x40	16x40	A28	174
67447000	50C14	7/9,6/8,1/9Pl.	H		13	60	700	715		16x43	16x43	A28	
67369000	50C15	3/22	H		3	60	700	715	106	16x40	16x40	E1	72
67407000	50C15	3/22	H		3	60	700	715	106	16x44	16x44	E1	72
67189000	50C15	4/9,3/16	H		7	60	700	715	140	16x40	16x40	E2	84
67439000	50C15	4/9,3/16	H		7	60	700	715	140	16x43	16x43	E2	84
67405000	50C15	9/9	H		9	60	700	715	191	16x44	16x44	E1	81
67473000	50C15	9/9	H		9	60	700	715	191	16x43	16x43	E1	81
67437000	50C15	6/9,6/8,1/9Pl.	H		12	60	700	715	168	16x44	16x44	A28	111
67381000	50C15	7/9,6/8	H		13	60	700	715	173	16x40	16x40	A28	174
67447000	50C15	7/9,6/8,1/9Pl.	H		13	60	700	715		16x43	16x43	A28	
67155000	59.12	1/39,1/10	L		2	70	700/229	340/90	44/236	16x40		L19	58
67189000	59.12TURBOD.	4/9,3/16	H		7	60	700	715	140	16x40	16x40	E2	84
67151000	59.12TURBOD.	3/14,1/22	H		4	70	700	715	133			E2	64
67150000	59.12TURBOD.	4/,2/	H		6	70	700	715	123			E2	80
67181000	59.12TURBOD.	4/11,2/18	H		6	70	700	715	123	16x40	16x40	E2	80
67155000	59.12TURBOD.	1/39,1/10	L	2	70	700/229	340/90	44/236	16x40		L19	58	
67347000	60C11CARRO	4/11,2/22	H	6	70	700	715	110	16x40	16x40	E2	88	
67347000	60C15CARRO	4/11,2/22	H	6	70	700	715	110	16x40	16x40	E2	88	
67485000	60C15CARRO	10/9,10/7	H	17	70	700	715	132	16x40	16x40	A66	160	
67333000	65C11	2/19,1/28	H	3	70	700	715	126	16x40	16x40	A65	75	
67347000	65C11	4/11,2/22	H	6	70	700	715	110	16x40	16x40	E2	88	
67485000	65C11	10/9,10/7	H	20	70	700	715	132	16x40	16x40	A66	160	
67487000	65C11	10/9,10/7	H	20	70	700	715	132	16x43	16x43	A66	160	
67491000	65C11	Lenkerlinks	L	1	70						L9.2		
67493000	65C11	Lenkerrechts	L	1	70						L9.1		
67333000	65C15	2/19,1/28	H	3	70	700	715	126	16x40	16x40	A65	75	
67347000	65C15	4/11,2/22	H	6	70	700	715	110	16x40	16x40	E2	88	
67485000	65C15	10/9,10/7	H	20	70	700	715	132	16x40	16x40	A66	160	
67487000	65C15	10/9,10/7	H	20	70	700	715	132	16x43	16x43	A66	160	
67481000	65C15	Lenkerlinks	L	1	70				16		L9.2		
67483000	65C15	Lenkerrechts	L	1	70				16		L9.1		
67491000	65C15	Lenkerlinks	L	1	70						L9.2		
67493000	65C15	Lenkerrechts	L	1	70						L9.1		
67333000	65C17	2/19,1/28	H	3	70	700	715	126	16x40	16x40	A65	75	
67347000	65C17	4/11,2/22	H	6	70	700	715	110	16x40	16x40	E2	88	
67485000	65C17	10/9,10/7	H	20	70	700	715	132	16x40	16x40	A66	160	
67487000	65C17	10/9,10/7	H	20	70	700	715	132	16x43	16x43	A66	160	
67481000	65C17	Lenkerlinks	L	1	70				16		L9.2		
67483000	65C17	Lenkerrechts	L	1	70				16		L9.1		
67493000	65C17	Lenkerrechts	L	1	70						L9.1		

DUCATO	IVECO	DUCATO
---------------	--------------	---------------

Artikel.Nr.	Fahrzeugtyp	Info		Achsl.	Blattzahl	Breite	Lx/L1	Ly/L2	Spr./Kr.	Buchsen vorn	Buchsen hinten	Form	Paketstärke	
Art.-No.	Type			Axle Load	Leaves	Width			FreeArch/Crank	Bush front	Bush rear	Shape	Total height	
67139000	10-13QLI	2/8,2/13	H	1,8	4	65	650	650	104	16x38	R31	A5	46	
67341000	10-13QLI	2/8,2/13	H		4	65	650	650	140	16x38	R31	A5	46	
67313000	10QLI	1/17	H		1	80	715	715	105	16x50	16x41	A1	17	
67431000	11QLI	1/17	H		1	80	715	715	126	16x47	16x40	A1	17	
67315000	14QLI	1/17	H		1	80	715	715	112	16x50	16x41	A28	17	
67331000	14QLI	1/17	H		1	80	715	715	103	16x50	16x41	A1	17	
67331000	15QLI	1/17	H		1,8	1	80	715	715	103	16x50	16x41	A1	17
67141000	18QLI	2/9,2/9,Ducato	H		4	65	650	650	126	16x38	R31	A5	48	
67315000	18QLI	1/17	H		1	80	715	715	112	16x50	16x41	A28	17	
67317000	18QLI	1/17	H		1	80	715	715	103	16x50	16x41	A28	17	
67331000	18QLI	1/17	H		1,8	1	80	715	715	103	16x50	16x41	A1	17
67427000	250L		H		1	70	715	715		R65	R40	A28	18	
67433000	CAMPER	1/21	H		1	80	715	715	118	16x47	16x40	A1	21	
67345000	CAMPER	2/17	H		2	80	715	715	125	16x46	16x40	A22	37	
67141000	MAXI 18QLI	2/9,2/9,Ducato	H		4	65	650	650	126	16x38	R31	A5	48	
67429000	MAXI 18QLI	1/9,1/8,2/13	H	4	65	650	650	116	16x38	R31	A5	47		
67311000	PANORAMA	1/17	H	1	80	715	715	109	16x50	16x41	A1	17		
67435000	PANORAMA	1/17	H	1	80	715	715	123	16x47	16x40	A1	17		

EUROCARGO

IVECO

EUROCARGO

Artikel.Nr.	Fahrzeugtyp	Info	Achsl.	Blattzahl	Breite	Lx/L1	Ly/L2	Spr./ Kr.	Buchsen vorn	Buchsen hinten	Form	Paket- stärke
Art.-No.	Type		Axle Load	Leaves	Width			FreeArch /Crank	Bush front	Bush rear	Shape	Total height
67108000	65E10	2/23,1/20Pl.	V	2	70	857	857	129	16x47	16x47	A28	72
67108900	65E10	2/23,1/20Pl.	V	2	70	857	857	129	16x45	16x45	A28	72
67114000	65E10	2/13,3/14	V	5	70	857	857	137	16	16	A28	68
67117000	65E10	2/16,1/36,1/26Pl.	H	3	70	835	835	140	16	16	A5	103
67115000	65E10	4/12,2/23	H	6	70	835	835	156	16	16	A5	94
67108000	65E12	2/23,1/20Pl.	V	2	70	857	857	129	16x47	16x47	A28	72
67108900	65E12	2/23,1/20Pl.	V	2	70	857	857	129	16x45	16x45	A28	72
67114000	65E12	2/13,3/14	V	5	70	857	857	137	16	16	A28	68
67117000	65E12	2/16,1/36,1/26Pl.	H	3	70	835	835	140	16	16	A5	103
67115000	65E12	4/12,2/23	H	6	70	835	835	156	16	16	A5	94
67127000	65E12	4/12,3/22	H	7	70	835	835	161	16x40	16x40	A5	114
67114000	65E12H	2/13,3/14	V	5	70	857	857	137	16	16	A28	68
67114000	65E12H	2/13,3/14	V	5	70	857	857	137	16	16	A28	68
67127000	65E12H	4/12,3/22	H	7	70	835	835	161	16x40	16x40	A5	114
67127000	65E12H	4/12,3/22	H	7	70	835	835	161	16x40	16x40	A5	114
67304000	65E13 TECT.	1/29,P/35	V	1	70	857	857	142	16x49	16x49	A28	69
67304900	65E13 TECT.	1/29,P/35	V	1	70	857	857	142	16x49	16x49	A28	69
67108900	65E13 TECT.	2/23,1/20Pl.	V	2	70	857	857	129	16x45	16x45	A28	72
67148000	65E13 TECT.	2/23,1/13Pl.	V	2	70	857	857	143	16x45	16x45	A28	59
67337000	65E13 TECT.	1/29,1/33,P/15	H	2	70	835	835	148	16x49	16x49	A5	83
67337900	65E13 TECT.	1/29,1/33,P/15	H	2	70	835	835	148	16x49	16x49	A5	83
67117000	65E13 TECT.	2/16,1/36,1/26Pl.	H	3	70	835	835	140	16	16	A5	103
67108000	65E14	2/23,1/20Pl.	V	2	70	857	857	129	16x47	16x47	A28	72
67108900	65E14	2/23,1/20Pl.	V	2	70	857	857	129	16x45	16x45	A28	72
67124000	65E14	2/23,1/Pl.20	V	2	70	857	857	145	16x47	16x47	A28	72
67114000	65E14	2/13,3/14	V	5	70	857	857	137	16	16	A28	68
67117000	65E14	2/16,1/36,1/26Pl.	H	3	70	835	835	140	16	16	A5	103
67115000	65E14	4/12,2/23	H	6	70	835	835	156	16	16	A5	94
67304000	65E15 TECT.	1/29,P/35	V	1	70	857	857	142	16x49	16x49	A28	69
67304900	65E15 TECT.	1/29,P/35	V	1	70	857	857	142	16x49	16x49	A28	69
67108900	65E15 TECT.	2/23,1/20Pl.	V	2	70	857	857	129	16x45	16x45	A28	72
67148000	65E15 TECT.	2/23,1/13Pl.	V	2	70	857	857	143	16x45	16x45	A28	59
67337000	65E15 TECT.	1/29,1/33,P/15	H	2	70	835	835	148	16x49	16x49	A5	83
67337900	65E15 TECT.	1/29,1/33,P/15	H	2	70	835	835	148	16x49	16x49	A5	83
67117000	65E15 TECT.	2/16,1/36,1/26Pl.	H	3	70	835	835	140	16	16	A5	103
67108000	75E12	2/23,1/20Pl.	V	2	70	857	857	129	16x47	16x47	A28	72
67108900	75E12	2/23,1/20Pl.	V	2	70	857	857	129	16x45	16x45	A28	72
67124000	75E12	2/23,1/Pl.20	V	2	70	857	857	145	16x47	16x47	A28	72
67190000	75E12	2/23	V	2	70	857	857	143	16x45	16x45	A28	46
67114000	75E12	2/13,3/14	V	5	70	857	857	137	16	16	A28	68
67354000	75E12	2/12,4/13,2	V	6	70	857	857	143	16x46	16x46	A28	76
67119000	75E12	2/16,1/40,1/27Pl.	H	3	70	835	835	147	16x45	16x45	A5	108
67127000	75E12	4/12,3/22	H	7	70	835	835	161	16x40	16x40	A5	114
67354000	75E12K TECT	2/12,4/13,2	V	6	70	857	857	143	16x46	16x46	A28	76
67354000	75E12K TECT	2/12,4/13,2	V	6	70	857	857	143	16x46	16x46	A28	76
67343000	75E12K TECT	4/12,3/22	H	7	70	835	835	161	16x36	16x36	A5	114
67343000	75E12K TECT	4/12,3/22	H	7	70	835	835	161	16x36	16x36	A5	114
67354000	75E13	2/12,4/13,2	V	6	70	857	857	143	16x46	16x46	A28	76
67309000	75E13	1/29,1/33,P/30	H	2	70	835	835	148	16x49	16x49	A10	98
67343000	75E13	4/12,3/22	H	7	70	835	835	161	16x36	16x36	A5	114
67304000	75E13 TECT.	1/29,P/35	V	1	70	857	857	142	16x49	16x49	A28	69
67304900	75E13 TECT.	1/29,P/35	V	1	70	857	857	142	16x49	16x49	A28	69
67306000	75E13 TECT.	1/29,P/25	V	2,0	1	70	857	142	16x49	16x49	A28	64
67306900	75E13 TECT.	1/29,P/25	V	2,0	1	70	857	142	16x49	16x49	A28	64
67124000	75E13 TECT.	2/23,1/Pl.20	V	2,8	2	70	857	145	16x47	16x47	A28	72
67114000	75E13 TECT.	2/13,3/14	V	5	70	857	857	137	16	16	A28	68
67126000	75E13 TECT.	2/12,4/13	V	6	70	857	857	149	16	16	A28	76

EUROCARGO

IVECO

EUROCARGO

Artikel.Nr.	Fahrzeugtyp	Info	Achsl.	Blattzahl	Breite	Lx/L1	Ly/L2	Spr./ Kr.	Buchsen vorn	Buchsen hinten	Form	Paket- stärke	
Art.-No.	Type		Axle Load	Leaves	Width			FreeArch /Crank	Bush front	Bush rear	Shape	Total height	
67354000	75E13 TECT.	2/12,4/13,2	V		6	70	857	857	143	16x46	16x46	A28	76
67309000	75E13 TECT.	1/29,1/33,P/30	H		2	70	835	835	148	16x49	16x49	A10	98
67309900	75E13 TECT.	1/29,1/33,P/30	H		2	70	835	835	148	16x49	16x49	A10	98
67119000	75E3 TECT.	2/16,1/40,1/27Pl.	H		3	70	835	835	147	16x45	16x45	A5	108
67127000	75E13 TECT.	4/12,3/22	H		7	70	835	835	161	16x40	16x40	A5	114
67343000	75E13 TECT.	4/12,3/22	H		7	70	835	835	161	16x36	16x36	A5	114
67108000	75E14	2/23,1/20Pl.	V		2	70	857	857	129	16x47	16x47	A28	72
67108900	75E14	2/23,1/20Pl.	V		2	70	857	857	129	16x45	16x45	A28	72
67124000	75E14	2/23,1/Pl.20	V	2,8	2	70	857	857	145	16x47	16x47	A28	72
67190000	75E14	2/23	V		2	70	857	857	143	16x45	16x45	A28	46
67114000	75E14	2/13,3/14	V		5	70	857	857	137	16	16	A28	68
67126000	75E14	2/12,4/13	V		6	70	857	857	149	16	16	A28	76
67354000	75E14	2/12,4/13,2	V		6	70	857	857	143	16x46	16x17	A28	76
67119000	75E14	2/16,1/40,1/27Pl.	H		3	70	835	835	147	16x45	16x45	A5	108
67127000	75E14	4/12,3/22	H		7	70	835	835	161	16x40	16x40	A5	114
67343000	75E14	4/12,3/22	H		7	70	835	835	161	16x36	16x36	A5	114
67354000	75E14K TECT	2/12,4/13,2	V		6	70	857	857	143	16x46	18x19	A28	76
67343000	75E14K TECT	4/12,3/22	H		7	70	835	835	161	16x36	16x36	A5	114
67108900	75E15	2/23,1/20Pl.	V		2	70	857	857	129	16x45	16x45	A28	72
67120000	75E15	2/22	V		2	70	857	857	151	16	16	A28	44
67124000	75E15	2/23,1/Pl.20	V	2,8	2	70	857	857	145	16x47	16x47	A28	72
67190000	75E15	2/23	V		2	70	857	857	143	16x45	16x45	A28	46
67114000	75E15	2/13,3/14	V		5	70	857	857	137	16	16	A28	68
67118000	75E15	6/13	V		6	70	857	857	142	16	16	A56	78
67126000	75E15	2/12,4/13	V		6	70	857	857	149	16	16	A28	76
67354000	75E15	2/12,4/13,2	V		6	70	857	857	143	16x46	16x46	A28	76
67309000	75E15	1/29,1/33,P/30	H		2	70	835	835	148	16x49	16x49	A10	98
67119000	75E15	2/16,1/40,1/27Pl.	H		3	70	835	835	147	16x45	16x45	A5	108
67121000	75E15	2/16,1/40	H		3	70	835	835	150	16x45	16x45	A5	81
67127000	75E15	4/12,3/22	H		7	70	835	835	161	16x40	16x40	A5	114
67304000	75E15 TECT.	1/29,P/35	V		1	70	857	857	142	16x49	16x49	A28	69
67304900	75E15 TECT.	1/29,P/35	V		1	70	857	857	142	16x49	16x49	A28	69
67306000	75E15 TECT.	1/29,P/25	V	2,0	1	70	857	857	142	16x49	16x49	A28	64
67306900	75E15 TECT.	1/29,P/25	V	2,0	1	70	857	857	142	16x49	16x49	A28	64
67124000	75E15 TECT.	2/23,1/Pl.20	V	2,8	2	70	857	857	145	16x47	16x47	A28	72
67114000	75E15 TECT.	2/13,3/14	V		5	70	857	857	137	16	16	A28	68
67126000	75E15 TECT.	2/12,4/13	V		6	70	857	857	149	16	16	A28	76
67314000	75E15 TECT.	2/12,4/13	V		6	70	857	857	143	16x49	16x49	A28	76
67354000	75E15 TECT.	2/12,4/13,2	V		6	70	857	857	143	16x46	16x46	A28	76
67309000	75E15 TECT.	1/29,1/33,P/30	H		2	70	835	835	148	16x49	16x49	A10	98
67309900	75E15 TECT.	1/29,1/33,P/30	H		2	70	835	835	148	16x49	16x49	A10	98
67119000	75E15 TECT.	2/16,1/40,1/27Pl.	H		3	70	835	835	147	16x45	16x45	A5	108
67127000	75E15 TECT.	4/12,3/22	H		7	70	835	835	161	16x40	16x40	A5	114
67343000	75E15 TECT.	4/12,3/22	H		7	70	835	835	161	16x36	16x36	A5	114
67354000	75E15K TECT	2/12,4/13,2	V		6	70	857	857	143	16x46	16x46	A28	76
67343000	75E15K TECT	4/12,3/22	H		7	70	835	835	161	16x36	16x36	A5	114
67306000	75E17 TECT.	1/29,P/25	V	2,0	1	70	857	857	142	16x49	16x49	A28	64
67306900	75E17 TECT.	1/29,P/25	V	2,0	1	70	857	857	142	16x49	16x49	A28	64
67124000	75E17 TECT.	2/23,1/Pl.20	V	2,8	2	70	857	857	145	16x47	16x47	A28	72
67114000	75E17 TECT.	2/13,3/14	V		5	70	857	857	137	16	16	A28	68
67126000	75E17 TECT.	2/12,4/13	V		6	70	857	857	149	16	16	A28	76
67354000	75E17 TECT.	2/12,4/13,2	V		6	70	857	857	143	16x46	16x46	A28	76
67309000	75E17 TECT.	1/29,1/33,P/30	H		2	70	835	835	148	16x49	16x49	A10	98
67309900	75E17 TECT.	1/29,1/33,P/30	H		2	70	835	835	148	16x49	16x49	A10	98
67119000	75E17 TECT.	2/16,1/40,1/27Pl.	H		3	70	835	835	147	16x45	16x45	A5	108
67127000	75E17 TECT.	4/12,3/22	H		7	70	835	835	161	16x40	16x40	A5	114
67343000	75E17 TECT.	4/12,3/22	H		7	70	835	835	161	16x36	16x36	A5	114

EUROCARGO

IVECO

EUROCARGO

Artikel.Nr.	Fahrzeugtyp	Info	Achsl.	Blattzahl	Breite	Lx/L1	Ly/L2	Spr./ Kr.	Buchsen vorn	Buchsen hinten	Form	Paket- stärke
Art.-No.	Type		Axle Load	Leaves	Width			FreeArch /Crank	Bush front	Bush rear	Shape	Total height
67354000	75E18	2/12,4/13,2	V	6	70	857	857	143	16x46	16x46	A28	76
67309000	75E18	1/29,1/33,P/30	H	2	70	835	835	148	16x49	16x49	A10	98
67304000	75E18 TECT.	1/29,P/35	V	1	70	857	857	142	16x49	16x49	A28	69
67304900	75E18 TECT.	1/29,P/35	V	1	70	857	857	142	16x49	16x49	A28	69
67306000	75E18 TECT.	1/29,P/25	V	1	70	857	857	142	16x49	16x49	A28	64
67306900	75E18 TECT.	1/29,P/25	V	2,0	1	70	857	142	16x49	16x49	A28	64
67124000	75E18 TECT.	2/23,1/Pl.20	V	2,8	2	70	857	145	16x47	16x47	A28	72
67126000	75E18 TECT.	2/12,4/13	V	6	70	857	857	149	16	16	A28	76
67354000	75E18 TECT.	2/12,4/13,2	V	6	70	857	857	143	16x46	16x46	A28	76
67309000	75E18 TECT.	1/29,1/33,P/30	H	2	70	835	835	148	16x49	16x49	A10	98
67309900	75E18 TECT.	1/29,1/33,P/30	H	2	70	835	835	148	16x49	16x46	A10	98
67119000	75E18 TECT.	2/16,1/40,1/27Pl.	H	3	70	835	835	147	16x45	16x45	A5	108
67127000	75E18 TECT.	4/12,3/22	H	7	70	835	835	161	16x40	16x40	A5	114
67343000	75E18 TECT.	4/12,3/22	H	7	70	835	835	161	16x36	16x36	A5	114
67120000	80E15	2/22	V	2	70	857	857	151	16	16	A28	44
67122000	80E15	2/23	V	2	70	857	857	129	16	16	A28	46
67124000	80E15	2/23,1/Pl.20	V	2,8	2	70	857	145	16x47	16x47	A28	72
67156000	80E15	2/22	V	2	70	857	857	150	16x45	16x45	A28	53
67190000	80E15	2/23	V	2	70	857	857	143	16x45	16x45	A28	46
67118000	80E15	6/13	V	6	70	857	857	142	16	16	A56	78
67121000	80E15	2/16,1/40	H	3	70	835	835	150	16x45	16x45	A5	81
67193000	80E15	2/17,1/40	H	3	70	835	835	156	16	16	A5	74
67113000	80E15	5/14,1/8Pl.,8/9	H	5,1	13	70	835	167	16x16	45x45	A28	150
67401000	80E15	5/14,1/P,8/9	H	13	70	835	835	161	16x49	16x49	A28	150
67304000	80E15 TECT.	1/29,P/35	V	1	70	857	857	142	16x49	16x49	A28	69
67304900	80E15 TECT.	1/29,P/35	V	1	70	857	857	142	16x49	16x49	A28	69
67337000	80E15 TECT.	1/29,1/33,P/15	H	2	70	835	835	148	16x49	16x49	A5	83
67337900	80E15 TECT.	1/29,1/33,P/15	H	2	70	835	835	148	16x49	16x49	A5	83
67310000	80E15K TECT	6/13	V	6	70	857	857	133	16x49	16x49	A28	78
67310900	80E15K TECT	6/13	V	6	70	857	857	133	16x49	16x49	A28	78
67401000	80E15K TECT	5/14,1/P,8/9	H	13	70	835	835	161	16x49	16x49	A28	150
67120000	80E18	2/22	V	2	70	857	857	151	16	16	A28	44
67122000	80E18	2/23	V	2	70	857	857	129	16	16	A28	46
67190000	80E18	2/23	V	2	70	857	857	143	16x45	16x45	A28	46
67118000	80E18	6/13	V	6	70	857	857	142	16	16	A56	78
67121000	80E18	2/16,1/40	H	3	70	835	835	150	16x45	16x45	A5	81
67193000	80E18	2/17,1/40	H	3	70	835	835	156	16	16	A5	74
67113000	80E18	5/14,1/8Pl.,8/9	H	5,1	13	70	835	167	16x16	45x45	A28	150
67401000	80E18	5/14,1/P,8/9	H	13	70	835	835	161	16x49	16x49	A28	150
67304000	80E18 TECT.	1/29,P/35	V	1	70	857	857	142	16x49	16x49	A28	69
67304900	80E18 TECT.	1/29,P/35	V	1	70	857	857	142	16x49	16x49	A28	69
67337000	80E18 TECT.	1/29,1/33,P/15	H	2	70	835	835	148	16x49	16x49	A5	83
67337900	80E18 TECT.	1/29,1/33,P/15	H	2	70	835	835	148	16x49	16x49	A5	83
67310000	80E18K TECT	6/13	V	6	70	857	857	133	16x49	16x49	A28	78
67310900	80E18K TECT	6/13	V	6	70	857	857	133	16x49	16x49	A28	78
67401000	80E18K TECT	5/14,1/P,8/9	H	13	70	835	835	161	16x49	16x49	A28	150
67156000	80E18NEF	2/22	V	2	70	857	857	150	16x45	16x45	A28	53
67120000	80E21	2/22	V	2	70	857	857	151	16	16	A28	44
67122000	80E21	2/23	V	2	70	857	857	129	16	16	A28	46
67156000	80E21	2/22	V	2	70	857	857	150	16x45	16x45	A28	53
67190000	80E21	2/23	V	2	70	857	857	143	16x45	16x45	A28	46
67118000	80E21	6/13	V	6	70	857	857	142	16	16	A56	78
67121000	80E21	2/16,1/40	H	3	70	835	835	150	16x46	16x45	A5	81
67113000	80E21	5/14,1/8Pl.,8/9	H	5,1	13	70	835	167	16x16	45x45	A28	150
67401000	80E21	5/14,1/P,8/9	H	13	70	835	835	161	16x49	16x49	A28	150
67304000	80E21 TECT.	1/29,P/35	V	1	70	857	857	142	16x49	16x49	A28	69
67304900	80E21 TECT.	1/29,P/35	V	1	70	857	857	142	16x49	16x49	A28	69

EUROCARGO

IVECO

EUROCARGO

Artikel.Nr.	Fahrzeugtyp	Info	Achsl.	Blattzahl	Breite	Lx/L1	Ly/L2	Spr./Kr.	Buchsen vorn	Buchsen hinten	Form	Paketstärke
Art.-No.	Type		Axle Load	Leaves	Width			FreeArch/Crank	Bush front	Bush rear	Shape	Total height
67337000	80E21 TECT.	1/29,1/33,P/15	H		70	835	835	148	16x49	16x49	A5	83
67337900	80E21 TECT.	1/29,1/33,P/15	H		70	835	835	148	16x49	16x49	A5	83
67310000	80E21K TECT	6/13	V		70	857	857	133	16x49	16x49	A28	78
67310900	80E21K TECT	6/13	V		70	857	857	133	16x49	16x49	A28	78
67401000	80E21K TECT	5/14,1/P,8/9	H		70	835	835	161	16x49	16x49	A28	150
67156000	80E21NEF	2/22	V		70	857	857	150	16x45	16x45	A28	53
67304000	80EL15 TECT	1/29,P/35	V		70	857	857	142	16x49	16x49	A28	69
67304900	80EL15 TECT	1/29,P/35	V		70	857	857	142	16x49	16x49	A28	69
67124000	80EL15 TECT	2/23,1/Pl.20	V	2,8	70	857	857	145	16x47	16x47	A28	72
67337000	80EL15 TECT	1/29,1/33,P/15	H		70	835	835	148	16x49	16x49	A5	83
67337900	80EL15 TECT	1/29,1/33,P/15	H		70	835	835	148	16x49	16x49	A5	83
67304000	80EL17 TECT	1/29,P/35	V		70	857	857	142	16x49	16x49	A28	69
67304900	80EL17 TECT	1/29,P/35	V		70	857	857	142	16x49	16x49	A28	69
67124000	80EL17 TECT	2/23,1/Pl.20	V	2,8	70	857	857	145	16x47	16x47	A28	72
67337000	80EL17 TECT	1/29,1/33,P/15	H		70	835	835	148	16x49	16x49	A5	83
67337900	80EL17 TECT	1/29,1/33,P/15	H		70	835	835	148	16x49	16x49	A5	83
67172000	95E15	1/17,3/20	V		80	808	808	132	20x57	20x57	A53	77
67184000	95E15	6/13,1/10Pl.	V		80	808	808	106	20x57	20x57	A28	88
67173000	95E15	2/23,1/Pl.,3/14,2/Pl.	H		80	833	833	164	20x57	20x57	A2	
67197000	95E15	5/14,1/P,8/9,2/P	H		80	836	836	161	20	20	A28	
67172000	95E18W	1/17,3/20	V		80	808	808	132	20x57	20x57	A53	77
67173000	95E18W	2/23,1/Pl.,3/14,2/Pl.	H		80	833	833	164	20x57	20x57	A2	
67171000	95E18W	3/22,1/Pl.,3/19,2/Pl.	H		80	835	835	179	20x57	20x57	A2	
67172000	95E21	1/17,3/20	V		80	808	808	132	20x57	20x57	A53	77
67184000	95E21	6/13,1/10Pl.	V		80	808	808	106	20x57	20x57	A28	88
67173000	95E21	2/23,1/Pl.,3/14,2/Pl.	H		80	833	833	164	20x57	20x57	A2	
67197000	95E21	5/14,1/P,8/9,2/P	H		80	836	836	161	20	20	A28	
67123000	95K	6/14,1/8Pl.,10/9	H		70	835	835	154	16	16	A28	182
67409000	95K TECTOR	6/14,10/9	H		70	835	835	148	16x49	16x49	A28	174
67409900	95K TECTOR	6/14,10/9	H		70	835	835	148	16x49	16x49	A28	174
67122000	100E15	2/23	V		70	857	857	129	16	16	A28	46
67148000	100E15	2/23,1/13Pl.	V		70	857	857	143	16x45	16x45	A28	59
67190000	100E15	2/23	V		70	857	857	143	16x45	16x45	A28	46
67118000	100E15	6/13	V		70	857	857	142	16	16	A56	78
67126000	100E15	2/12,4/13	V		70	857	857	149	16	16	A28	76
67193000	100E15	2/17,1/40	H		70	835	835	156	16	16	A5	74
67127000	100E15	4/12,3/22	H		70	835	835	161	16x40	16x40	A5	114
67123000	100E15	6/14,1/8Pl.,10/9	H		70	835	835	154	16	16	A28	182
67306000	100E15 TECT	1/29,P/25	V	2,0	70	857	857	142	16x49	16x49	A28	64
67306900	100E15 TECT	1/29,P/25	V	2,0	70	857	857	142	16x49	16x49	A28	64
67339000	100E15 TECT	1/29,1/36,P/10	H		70	835	835	148	16x49	16x49	A10	81
67339900	100E15 TECT	1/29,1/36,P/10	H		70	835	835	148	16x49	16x49	A10	81
67118000	100E15K	6/13	V		70	857	857	142	16	16	A56	78
67123000	100E15K	6/14,1/8Pl.,10/9	H		70	835	835	154	16	16	A28	182
67310000	100E15K TEC	6/13	V		70	857	857	133	16x49	16x49	A28	78
67310900	100E15K TEC	6/13	V		70	857	857	133	16x49	16x49	A28	78
67409000	100E15K TEC	6/14,10/9	H		70	835	835	148	16x49	16x49	A28	174
67409900	100E15K TEC	6/14,10/9	H		70	835	835	148	16x49	16x49	A28	174
67148000	100E15NEF	2/23,1/13Pl.	V		70	857	857	143	16x45	16x45	A28	59
67306000	100E17 TECT	1/29,P/25	V	2,0	70	857	857	142	16x49	16x49	A28	64
67306900	100E17 TECT	1/29,P/25	V	2,0	70	857	857	142	16x49	16x49	A28	64
67118000	100E17 TECT	6/13	V		70	857	857	142	16	16	A56	78
67310000	100E17 TECT	6/13	V		70	857	857	133	16x49	16x49	A28	78
67310900	100E17 TECT	6/13	V		70	857	857	133	16x49	16x49	A28	78
67339000	100E17 TECT	1/29,1/36,P/10	H		70	835	835	148	16x49	16x49	A10	81
67339900	100E17 TECT	1/29,1/36,P/10	H		70	835	835	148	16x49	16x49	A10	81
67123000	100E17 TECT	6/14,1/8Pl.,10/9	H		70	835	835	154	16	16	A28	182

EUROCARGO

IVECO

EUROCARGO

Artikel.Nr.	Fahrzeugtyp	Info	Achsl.	Blattzahl	Breite	Lx/L1	Ly/L2	Spr./ Kr.	Buchsen vorn	Buchsen hinten	Form	Paket- stärke	
Art.-No.	Type		Axle Load	Leaves	Width			FreeArch /Crank	Bush front	Bush rear	Shape	Total height	
67409000	100E17 TECT	6/14,10/9	H	16	70	835	835	148	16x49	16x49	A28	174	
67409900	100E17 TECT	6/14,10/9	H	16	70	835	835	148	16x49	16x49	A28	174	
67306000	100E18	1/29,P/25	V	2,0	1	70	857	857	142	16x49	16x49	A28	64
67122000	100E18	2/23	V	2	70	857	857	129	16	16	A28	46	
67148000	100E18	2/23,1/13Pl.	V	2	70	857	857	143	16x45	16x45	A28	59	
67190000	100E18	2/23	V	2	70	857	857	143	16x45	16x45	A28	46	
67118000	100E18	6/13	V	6	70	857	857	142	16	16	A56	78	
67337000	100E18	1/29,1/33,P/15	H	2	70	835	835	148	16x49	16x49	A5	83	
67339000	100E18	1/29,1/36,P/10	H	2	70	835	835	148	16x49	16x48	A10	81	
67125000	100E18	2/17,1/40	H	3	70	835	835	145	16	16	A5	74	
67193000	100E18	2/17,1/40	H	3	70	835	835	156	16	16	A5	74	
6712300	100E18	6/14,1/8Pl.,10/9	H	16	70	835	835	154	16	16	A28	182	
67406000	100E18		L	2	70					Logout	L20		
6730400	100E18 TECT	1/29,P/35	V	2,0	1	70	857	857	142	16x49	16x49	A28	69
6730600	100E18 TECT	1/29,P/25	V	2,0	1	70	857	857	142	16x49	16x49	A28	64
67306900	100E18 TECT	1/29,P/25	V	2,0	1	70	857	857	142	16x49	16x49	A28	64
67148000	100E18 TECT	2/23,1/13Pl.	V	2	70	857	857	143	16x45	16x45	A28	59	
67156000	100E18 TECT	2/22	V	2	70	857	857	150	16x45	16x46	A28	53	
67118000	100E18 TECT	6/13	V	6	70	857	857	142	16	16	A56	78	
67310000	100E18 TECT	6/13	V	6	70	857	857	133	16x49	16x49	A28	78	
67310900	100E18 TECT	6/13	V	6	70	857	857	133	16x49	16x49	A28	78	
67410000	100E18 TECT		V	3	80				20x57	20x57	A28		
67337000	100E18 TECT	1/29,1/33,P/15	H	2	70	835	835	148	16x49	16x49	A5	83	
67337900	100E18 TECT	1/29,1/33,P/15	H	2	70	835	835	148	16xx49	16x49	A5	83	
67339000	100E18 TECT	1/29,1/36,P/10	H	2	70	835	835	148	16x49	16x49	A10	81	
67339900	100E18 TECT	1/29,1/36,P/10	H	2	70	835	835	148	16x49	16x49	A10	81	
67121000	100E18 TECT	2/16,1/40	H	3	70	835	835	150	16x45	16x45	A5	81	
67193000	100E18 TECT	2/17,1/40	H	3	70	835	835	156	16	16	A5	74	
67123000	100E18 TECT	6/14,1/8Pl.,10/9	H	16	70	835	835	154	16	16	A28	182	
67409000	100E18 TECT	6/14,10/9	H	16	70	835	835	148	16x49	16x49	A28	174	
67409900	100E18 TECT	6/14,10/9	H	16	70	835	835	148	16x49	16x49	A28	174	
67173000	100E18 TECT	2/23,1/Pl.,3/14,2/Pl.	H	5	80	833	833	164	20x57	20x57	A2		
67408000	100E18 TECT	Lenkervorn	L	2	70				16x45	16x45	L20		
67118000	100E18K	6/13	V	6	70	857	857	142	16	16	A56	78	
67123000	100E18K	6/14,1/8Pl.,10/9	H	16	70	835	835	154	16	16	A28	182	
67310000	100E18K TEC	6/13	V	6	70	857	857	133	16x49	16x49	A28	78	
67310900	100E18K TEC	6/13	V	6	70	857	857	133	1x649	16x49	A28	78	
67409000	100E18K TEC	6/14,10/9	H	16	70	835	835	148	16x49	16x49	A28	174	
67409900	100E18K TEC	6/14,10/9	H	16	70	835	835	148	16x49	16x49	A28	174	
67148000	100E18NEF	2/23,1/13Pl.	V	2	70	857	857	143	16x45	16x45	A28	59	
67148000	100E21	2/23,1/13Pl.	V	2	70	857	857	143	16x45	16x45	A28	59	
67190000	100E21	2/23	V	2	70	857	857	143	16x45	16x45	A28	46	
67118000	100E21	6/13	V	6	70	857	857	142	16	16	A56	78	
67193000	100E21	2/17,1/40	H	3	70	835	835	156	16	16	A5	74	
67123000	100E21	6/14,1/8Pl.,10/9	H	16	70	835	835	154	16	16	A28	182	
67304000	100E21 TECT	1/29,P/35	V	2,0	1	70	857	857	142	16x49	16x49	A28	69
67306000	100E21 TECT	1/29,P/25	V	2,0	1	70	857	857	142	16x49	16x49	A28	64
67306900	100E21 TECT	1/29,P/25	V	2,0	1	70	857	857	142	16x49	16x49	A28	64
67148000	100E21 TECT	2/23,1/13Pl.	V	2	70	857	857	143	16x45	16x45	A28	59	
67156000	100E21 TECT	2/22	V	2	70	857	857	150	16x45	16x45	A28	53	
67118000	100E21 TECT	6/13	V	6	70	857	857	142	16	16	A56	78	
67310900	100E21 TECT	6/13	V	6	70	857	857	133	16x49	16x49	A28	78	
67410000	100E21 TECT		V	3	80				20x57	20x57	A28		
67172000	100E21 TECT	1/17,3/20	V	4	80	808	808	132	20x57	20x57	A53	77	
67339000	100E21 TECT	1/29,1/36,P/10	H	2	70	835	835	148	16x49	16x49	A10	81	
67339900	100E21 TECT	1/29,1/36,P/10	H	2	70	835	835	148	16x49	16x49	A10	81	
67193000	100E21 TECT	2/17,1/40	H	3	70	835	835	156	16	16	A5	74	

EUROCARGO

IVECO

EUROCARGO

Artikel.Nr.	Fahrzeugtyp	Info	Achsl.	Blattzahl	Breite	Lx/L1	Ly/L2	Spr./Kr.	Buchsen vorn	Buchsen hinten	Form	Paketstärke	
Art.-No.	Type		Axle Load	Leaves	Width			FreeArch/Crank	Bush front	Bush rear	Shape	Total height	
67123000	100E21 TECT	6/14,1/8Pl.,10/9	H	2,0	16	70	835	835	154	16	A28	182	
67409000	100E21 TECT	6/14,10/9	H		16	70	835	835	148	16x49	16x49	A28	174
67409900	100E21 TECT	6/14,10/9	H		16	70	835	835	148	16x49	16x49	A28	174
67173000	100E21 TECT	2/23,1/Pl.,3/14,2/Pl.	H		5	80	833	833	164	20x57	20x57	A2	
67123000	100E21K	6/14,1/8Pl.,10/9	H		16	70	835	835	154	16	16	A28	182
67409000	100E21K	6/14,10/9	H		16	70	835	835	148	16x49	16x49	A28	174
67409900	100E21K	6/14,10/9	H		16	70	835	835	148	16x49	16x49	A28	174
67148000	100E21NEF	2/23,1/13Pl.	V		2	70	857	857	143	16x45	16x45	A28	59
67306000	100E22	1/29,P/25	V		1	70	857	857	142	16x49	16x49	A28	64
67337000	100E22	1/29,1/33,P/15	H		2	70	835	835	148	16x49	16x49	A5	83
67339000	100E22	1/29,1/36,P/10	H		2	70	835	835	148	16x49	16x49	A10	81
67479000	100E22	Lenkerhinten	L		1							L8.5	
67406000	100E22		L		2	70						L20	
67118000	100K	6/13	V		6	70	857	857	142	16	16	A56	78
67128000	120E15	2/24	V		2	80	879	879	129	20x57	20x57	A28	48
67130000	120E15	6/14	V		6	80	880	880	110	20x57	20x57	A28	84
67129000	120E15	2/23,1/38	H		3	80	840	840	159	20x57	20x57	A5	84
67131000	120E15	2/14,3/16,1/8,11/10,1/15	H		16	80	840	840	151	20x57	20x57	A28	209
67128000	120E15 TECT	2/24	V		2	80	879	879	129	20x57	20x57	A28	48
67129000	120E15 TECT	2/23,1/38	H		3	80	840	840	159	20x57	20x57	A5	84
67130000	120E15H	6/14	V	6	80	880	880	110	20x57	20x57	A28	84	
67131000	120E15H	2/14,3/16,1/8,11/10,1/15	H	16	80	840	840	151	20x57	20x57	A28	209	
67120000	120E18	2/22	V	2	70	857	857	151	16	16	A28	44	
67312000	120E18	2/26	V	2	70	857	857	100	20x57	20x57	A28	61	
67128000	120E18	2/24	V	2	80	879	879	129	20x57	20x57	A28	48	
67130000	120E18	6/14	V	6	80	880	880	110	20x57	20x57	A28	84	
67121000	120E18	2/16,1/40	H	3	70	835	835	150	16x45	16x45	A5	81	
67385000	120E18	2/25,1/40	H	3	70	835	835	130	20x57	20x57	A9	102	
67129000	120E18	2/23,1/38	H	3	80	840	840	159	20x57	20x57	A5	84	
67131000	120E18	2/14,3/16,1/8,11/10,1/15	H	16	80	840	840	151	20x57	20x57	A28	209	
67489000	120E18	Lenkerlinks	L	1							L9.2		
67499000	120E18	Lenkerrechts	L	1							L9.1		
66918000	120E18	1/23,1/30,Lenkervorn	L	2	80	887	887	110	20x57	20x57	L20	53	
66938000	120E18	1/23,1/30,Lenkervorn	L	2	80	887	869		20x57	20x57	L20	62	
67128000	120E18 TECT	2/24	V	2	80	879	879	129	20x57	20x57	A28	48	
67129000	120E18 TECT	2/23,1/38	H	3	80	840	840	159	20x57	20x57	A5	84	
67130000	120E18H	6/14	V	6	80	880	880	110	20x57	20x57	A28	84	
67131000	120E18H	2/14,3/16,1/8,11/10,1/15	H	16	80	840	840	151	20x57	20x57	A28	209	
67120000	120E23	2/22	V	2	70	857	857	151	16	16	A28	44	
67118000	120E23	6/13	V	6	70	857	857	142	16	16	A56	78	
67128000	120E23	2/24	V	2	80	879	879	129	20x57	20x57	A28	48	
67130000	120E23	6/14	V	6	80	880	880	110	20x57	20x57	A28	84	
67121000	120E23	2/16,1/40	H	3	70	835	835	150	16x45	16x45	A5	81	
67113000	120E23	5/14,1/8Pl.,8/9	H	5,1	13	70	835	835	167	16x16	45x45	A28	150
67129000	120E23	2/23,1/38	H	3	80	840	840	159	20x57	20x57	A5	84	
67131000	120E23	2/14,3/16,1/8,11/10,1/15	H	16	80	840	840	151	20x57	20x57	A28	209	
66918000	120E23	1/23,1/30,Lenkervorn	L	2	80	887	887	110	20x57	20x57	L20	53	
66938000	120E23	1/23,1/30,Lenkervorn	L	2	80	887	869		20x57	20x57	L20	62	
67128000	120E23 TECT	2/24	V	2	80	879	879	129	20x57	20x57	A28	48	
67129000	120E23 TECT	2/23,1/38	H	3	80	840	840	159	20x57	20x57	A5	84	
67129000	120E24 TECT	2/23,1/38	H	3	80	840	840	159	20x57	20x57	A5	84	
67128000	120E28 TECT	2/24	V	2	80	879	879	129	20x57	20x57	A28	48	
67129000	120E28 TECT	2/23,1/38	H	3	80	840	840	159	20x57	20x57	A5	84	
66918000	120EFP PNEU	1/23,1/30,Lenkervorn	L	2	80	887	887	110	20x57	20x57	L20	53	
66938000	120EFP PNEU	1/23,1/30,Lenkervorn	L	2	80	887	869		20x57	20x57	L20	62	
67385000	120EL15	2/25,1/40	H	3	70	835	835	130	20x57	20x57	A9	102	
67312000	120EL15 TEC	2/26	V	2	70	857	857	100	20x57	20x57	A28	61	

EUROCARGO

IVECO

EUROCARGO

Artikel.Nr.	Fahrzeugtyp	Info	Achsl.	Blattzahl	Breite	Lx/L1	Ly/L2	Spr./ Kr.	Buchsen vorn	Buchsen hinten	Form	Paket- stärke
Art.-No.	Type		Axle Load	Leaves	Width			FreeArch /Crank	Bush front	Bush rear	Shape	Total height
67385000	120EL15 TEC	2/25,1/40	H	3	70	835	835	130	20x57	20x57	A9	102
67385000	120EL18	2/25,1/40	H	3	70	835	835	130	20x57	20x57	A9	102
67312000	120EL18 TEC	2/26	V	2	70	857	857	100	20x57	20x57	A28	61
67385000	120EL18 TEC	2/25,1/40	H	3	70	835	835	130	20x57	20x57	A9	102
67385000	120EL21	2/25,1/40	H	3	70	835	835	130	20x57	20x57	A9	102
67312000	120EL21 TEC	2/26	V	2	70	857	857	100	20x57	20x57	A28	61
67385000	120EL21 TEC	2/25,1/40	H	3	70	835	835	130	20x57	20x57	A9	102
67190000	130E15	2/23	V	2	70	857	857	143	16x45	16x45	A28	46
67132000	130E15	3/21	V	3	80	880	880	132	20x57	20x57	A28	75
67130000	130E15	6/14	V	6	80	880	880	110	20x57	20x57	A28	84
67133000	130E15	2/24,1/37	H	3	80	840	840	155	20x57	20x57	A5	85
67131000	130E15	2/14,3/16,1/8,11/10,1/15	H	16	80	840	840	151	20x57	20x57	A28	209
67190000	130E18	2/23	V	2	70	857	857	143	16x45	16x45	A28	46
67132000	130E18	3/21	V	3	80	880	880	132	20x57	20x57	A28	75
67158000	130E18	3/21	V	3	80	879	879	142	20x57	20x57	A28	75
67130000	130E18	6/14	V	6	80	880	880	110	20x57	20x57	A28	84
67133000	130E18	2/24,1/37	H	3	80	840	840	155	20x57	20x57	A5	85
67131000	130E18	2/14,3/16,1/8,11/10,1/15	H	16	80	840	840	151	20x57	20x57	A28	209
6713500	130E18 CREW	3/23,1/38	H	4	80	840	840	132	20x57	20x57	A9	107
6713200	130E18 TECT	3/21	V	3	80	880	880	132	20x57	20x57	A28	75
67158000	130E18 TECT	3/21	V	3	80	879	879	142	20x57	20x57	A28	75
67190000	130E23	2/23	V	2	70	857	857	143	16x45	16x45	A28	46
67132000	130E23	3/21	V	3	80	880	880	132	20x57	20x57	A28	75
67130000	130E23	6/14	V	6	80	880	880	110	20x57	20x57	A28	84
67133000	130E23	2/24,1/37	H	3	80	840	840	155	20x57	20x57	A5	85
67131000	130E23	2/14,3/16,1/8,11/10,1/15	H	16	80	840	840	151	20x57	20x57	A28	209
66918000	130E23	1/23,1/30,Lenkervorn	L	2	80	887	887	110	20x57	20x57	L20	53
66938000	130E23	1/23,1/30,Lenkervorn	L	2	80	887	869		20x57	20x57	L20	62
67132000	130E24 TECT	3/21	V	3	80	880	880	132	20x57	20x57	A28	75
67158000	130E24 TECT	3/21	V	3	80	879	879	142	20x57	20x57	A28	75
67132000	130E28 TECT	3/21	V	3	80	880	880	132	20x57	20x57	A28	75
67158000	130E28 TECT	3/21	V	3	80	879	879	142	20x57	20x57	A28	75
67172000	135E18	1/17,3/20	V	4	80	808	808	132	20x57	20x57	A53	77
67402000	135E18		V	7	80				20x57	20x57	A59	
67411000	135E18	3/22,1/8,3/19,1/25Pl.,1/29Pl.	H	5	80	833	833	153	20x57	20x57	A2	209
67477000	135E18	5/1/?	H	5/	80	835	835		20x57	20x57	A2	
67411000	135E18W	3/22,1/8,3/19,1/25Pl.,1/29Pl.	H	5	80	833	833	153	20x57	20x57	A2	209
67172000	135E22W	1/17,3/20	V	4	80	808	808	132	20x57	20x57	A53	77
67171000	135E22W	3/22,1/Pl.,3/19,2/Pl.	H	6	80	835	835	179	20x57	20x57	A2	
67172000	135E23	1/17,3/20	V	4	80	808	808	132	20x57	20x57	A53	77
67411000	135E23	3/22,1/8,3/19,1/25Pl.,1/29Pl.	H	5	80	833	833	153	20x57	20x57	A2	209
67171000	135E23	3/22,1/Pl.,3/19,2/Pl.	H	6	80	835	835	179	20x57	20x57	A2	
67477000	135E23	5/1/?	H	5/	80	835	835		20x57	20x57	A2	
67411000	135E23W	3/22,1/8,3/19,1/25Pl.,1/29Pl.	H	5	80	833	833	153	20x57	20x57	A2	209
67132000	150E15	3/21	V	3	80	880	880	132	20x57	20x57	A28	75
67162000	150E15	2/14,4/16	V	6	80	879	879	102	20x57	20x57	A28	92
67134000	150E15	8/13	V	8	80	879	879	136	20x57	20x57	A28	104
67135000	150E15	3/23,1/38	H	4	80	840	840	132	20x57	20x57	A9	107
67137000	150E15	7/15,P/8,11/10	H	18	80	840	840	157	20x57	20x57	A28	223
67159000	150E15H	7/16,1/8Pl.,11/10	H	18	80	840	840	146	20x57	20x57	A28	230
67132000	150E18	3/21	V	3	80	880	880	132	20x57	20x57	A28	75
67158000	150E18	3/21	V	3	80	879	879	142	20x57	20x57	A28	75
67162000	150E18	2/14,4/16	V	6	80	879	879	102	20x57	20x57	A28	92
67134000	150E18	8/13	V	8	80	879	879	136	20x57	20x57	A28	104
67135000	150E18	3/23,1/38	H	4	80	840	840	132	20x57	20x57	A9	107
67137000	150E18	7/15,P/8,11/10	H	18	80	840	840	157	20x57	20x57	A28	223
67132000	150E18 TECT	3/21	V	3	80	880	880	132	20x57	20x57	A28	75

EUROCARGO

IVECO

EUROCARGO

Artikel.Nr.	Fahrzeugtyp	Info	Achsl.	Blattzahl	Breite	Lx/L1	Ly/L2	Spr./Kr.	Buchsen vorn	Buchsen hinten	Form	Paketstärke
Art.-No.	Type		Axle Load	Leaves	Width			FreeArch/Crank	Bush front	Bush rear	Shape	Total height
67158000	150E18 TECT	3/21	V	3	80	879	879	142	20x57	20x57	A28	75
67159000	150E18H	7/16,1/8Pl.,11/10	H	18	80	840	840	146	20x57	20x57	A28	230
67132000	150E23	3/21	V	3	80	880	880	132	20x57	20x57	A28	75
67162000	150E23	2/14,4/16	V	6	80	879	879	102	20	20	A28	92
67134000	150E23	8/13	V	8	80	879	879	136	20x57	20x57	A28	104
67135000	150E23	3/23,1/38	H	4	80	840	840	132	20x57	20x57	A9	107
67137000	150E23	7/15,P/8,11/10	H	18	80	840	840	157	20x57	20x57	A28	223
66918000	150E23	1/23,1/30,Lenkervorn	L	2	80	887	887	110	20x57	20x57	L20	53
66938000	150E23	1/23,1/30,Lenkervorn	L	2	80	887	869		20x57	20x57	L20	62
67159000	150E23H	7/16,1/8Pl.,11/10	H	18	80	840	840	146	20x57	20x57	A28	230
67158000	150E24	3/21	V	3	80	879	879	142	20x57	20x57	A28	75
67132000	150E24 TECT	3/21	V	3	80	880	880	132	20x57	20x57	A28	75
67158000	150E24 TECT	3/21	V	3	80	879	879	142	20x57	20x57	A28	75
67132000	150E27	3/21	V	3	80	880	880	132	20x57	20x57	A28	75
67162000	150E27	2/14,4/16	V	6	80	879	879	102	20	20	A28	92
67134000	150E27	8/13	V	8	80	879	879	136	20x57	20x57	A28	104
67135000	150E27	3/23,1/38	H	4	80	840	840	132	20x57	20x57	A9	107
67137000	150E27	7/15,P/8,11/10	H	18	80	840	840	157	20x57	20x57	A28	223
66918000	150E27	1/23,1/30,Lenkervorn	L	2	80	887	887	110	20x57	20x57	L20	53
66938000	150E27	1/23,1/30,Lenkervorn	L	2	80	887	869		20x57	20x57	L20	62
67158000	150E28	3/21	V	3	80	879	879	142	20x57	20x57	A28	75
67132000	150E28 TECT	3/21	V	3	80	880	880	132	20x57	20x57	A28	75
67158000	150E28 TECT	3/21	V	3	80	879	879	142	20x57	20x57	A28	75
67135000	150E28 TECT	3/23,1/38	H	4	80	840	840	132	20x57	20x57	A9	107
66918000	150EFP PNEU	1/23,1/30,Lenkervorn	L	2	80	887	887	110	20x57	20x57	L20	53
66938000	150EFP PNEU	1/23,1/30,Lenkervorn	L	2	80	887	869		20x57	20x57	L20	62
67162000	150K	2/14,4/16	V	6	80	879	879	102	20x57	20x57	A28	92
66988000	170E15	1/19,3/21,1/13Pl.	V	4	80	879	879	186	20x57	20x57	A12	110
66934000	170E15	6/16,5,1/13	V	7	80	879	879	161	20x57	20x57	A31	112
67135000	170E15	3/23,1/38	H	4	80	840	840	132	20x57	20x57	A9	107
66988000	170E18	1/19,3/21,1/13Pl.	V	4	80	879	879	186	20x57	20x57	A12	110
66934000	170E18	6/16,5,1/13	V	7	80	879	879	161	20x57	20x57	A31	112
67135000	170E18	3/23,1/38	H	4	80	840	840	132	20x57	20x57	A9	107
67161000	170E18	3/24,1/38	H	4	80	840	840	128	20x57	20x57	A50	110
67159000	170E18	7/16,1/8Pl.,11/10	H	18	80	840	840	146	20x57	20x57	A28	230
66988000	170E23	1/19,3/21,1/13Pl.	V	4	80	879	879	186	20x57	20x57	A12	110
66934000	170E23	6/16,5,1/13	V	7	80	879	879	161	20x57	20x57	A31	112
67135000	170E23	3/23,1/38	H	4	80	840	840	132	20x57	20x57	A9	107
67161000	170E23	3/24,1/38	H	4	80	840	840	128	20x57	20x57	A50	110
67159000	170E23	7/16,1/8Pl.,11/10	H	18	80	840	840	146	20x57	20x57	A28	230
66988000	170E27	1/19,3/21,1/13Pl.	V	4	80	879	879	186	20x57	20x57	A12	110
66934000	170E27	6/16,5,1/13	V	7	80	879	879	161	20x57	20x57	A31	112
67161000	170E27	3/24,1/38	H	4	80	840	840	128	20x57	20x57	A50	110
67120000	180E21	2/22	V	2	70	857	857	151	16	16	A28	44
67121000	180E21	2/16,1/40	H	3	70	835	835	150	16x45	16x45	A5	81
66988000	180E24 TECT	1/19,3/21,1/13Pl.	V	4	80	879	879	186	20x57	20x57	A12	110
66988000	180E28 TECT	1/19,3/21,1/13Pl.	V	4	80	879	879	186	20x57	20x57	A12	110
67190000	260E23	2/23	V	2	70	857	857	143	16x45	16x45	A28	46
67136000	260E23	2/22	V	2	80	879	879	142	20x57	20x57	A28	44
67133000	260E23	2/24,1/37	H	3	80	840	840	155	20x57	20x57	A5	85
66988000	260E27	1/19,3/21,1/13Pl.	V	4	80	879	879	186	20x57	20x57	A12	110
66934000	260E27	6/16,5,1/13	V	7	80	879	879	161	20x57	20x57	A31	112
67164000	320E27	3/20	V	3	80	879	879	159	20x57	20x57	A28	60
67135000	320E27	3/23,1/38	H	4	80	840	840	132	20x57	20x57	A9	107
67164000	320E28	3/20	V	3	80	879	879	159	20x57	20x57	A28	60

EUROSTAR

IVECO

EUROSTAR

Artikel-Nr.	Fahrzeugtyp	Info	Achsl.	Blattzahl	Breite	Lx/L1	Ly/L2	Spr./ Kr.	Buchsen vorn	Buchsen hinten	Form	Paket- stärke
Art.-No.	Type		Axle Load	Leaves	Width			FreeArch/ Crank	Bush front	Bush rear	Shape	Total height
67144000	180E38	1/22,2/24	V		90	950	950	198	20x62	20x62	A28	83
66924000	190E38	1/21,2/23	V		90	950	950	196	20x62	20x62	A28	79
67144000	190E38	1/22,2/24	V		90	950	950	198	20x62	20x62	A28	83
67182000	190E38	1/24,2/25	V		90	950	950	178	20x62	20x62	A53	74
67366000	190E38	1/100x22;1/90x40,Lenkervorn	L		100	961	944	181	20x62	20x37	L20	71
66924000	190E42	1/21,2/23	V		90	950	950	196	20x62	20x62	A28	79
67144000	190E42	1/22,2/24	V		90	950	950	198	20x62	20x62	A28	83
67182000	190E42	1/24,2/25	V		90	950	950	178	20x62	20x62	A53	74
67163000	190E42	3/21,1/36	H		100	900	900	171	20x62	20x62	A50	99
67165000	190E42	3/21,1/40	H		100	900	900	171	20x62	20x62	A50	103
67366000	190E42	1/100x22;1/90x40,Lenkervorn	L		100	961	944	181	20x62	20x37	L20	71
67152000	190E43	2/29	V	7,5	90	950	945	189	20x62	20x62	A54	58
67152000	190E47	2/29	V	7,5	90	950	945	189	20x62	20x62	A54	58
66924000	190E47	1/21,2/23	V		90	950	950	196	20x62	20x62	A28	79
67144000	190E47	1/22,2/24	V		90	950	950	198	20x62	20x62	A28	83
67182000	190E47	1/24,2/25	V		90	950	950	178	20x62	20x62	A53	74
67163000	190E47	3/21,1/36	H		100	900	900	171	20x62	20x62	A50	99
67165000	190E47	3/21,1/40	H		100	900	900	171	20x62	20x62	A50	103
67366000	190E47	1/100x22;1/90x40,Lenkervorn	L		100	961	944	181	20x62	20x37	L20	71
66924000	190E52	1/21,2/23	V		90	950	950	196	20x62	20x62	A28	79
67144000	190E52	1/22,2/24	V		90	950	950	198	20x62	20x62	A28	83
67182000	190E52	1/24,2/25	V		90	950	950	178	20x62	20x62	A53	74
67163000	190E52	3/21,1/36	H		100	900	900	171	20x62	20x62	A50	99
67165000	190E52	3/21,1/40	H		100	900	900	171	20x62	20x62	A50	103
67152000	240E38	2/29	V	7,5	90	950	945	189	20x62	20x62	A54	58
67144000	240E38	1/22,2/24	V		90	950	950	198	20x62	20x62	A28	83
67182000	240E38	1/24,2/25	V		90	950	950	178	20x62	20x62	A53	74
67366000	240E38	1/100x22;1/90x40,Lenkervorn	L		100	961	944	181	20x62	20x37	L20	71
66916000	240E38	1/25,1/40,Lenkervorn	L		90	961	943	175	20x62	20x62	L20	65
67144000	240E42	1/22,2/24	V		90	950	950	198	20x62	20x62	A28	83
67182000	240E42	1/24,2/25	V		90	950	950	178	20x62	20x62	A53	74
67366000	240E42	1/100x22;1/90x40,Lenkervorn	L		100	961	944	181	20x62	20x37	L20	71
66916000	240E42	1/25,1/40,Lenkervorn	L		90	961	943	175	20x62	20x62	L20	65
66926000	240E47	1/25,2/26	V	8,0	90	950	950	153	20x60	20x60	A28	89
67144000	240E47	1/22,2/24	V		90	950	950	198	20x62	20x62	A28	83
67182000	240E47	1/24,2/25	V		90	950	950	178	20x62	20x62	A53	74
67147000	240E47	3/31,1/10Halter	H		100	660	950	94			D6	109
67413000	240E47	3/43,1/10Halter	H		100	670	955	81			D1.1	145
67366000	240E47	1/100x22;1/90x40,Lenkervorn	L		100	961	944	181	20x62	20x37	L20	71
66916000	240E47	1/25,1/40,Lenkervorn	L		90	961	943	175	20x62	20x62	L20	65
67144000	240E52	1/22,2/24	V		90	950	950	198	20x62	20x62	A28	83
67182000	240E52	1/24,2/25	V		90	950	950	178	20x62	20x62	A53	74
67366000	240E52	1/100x22;1/90x40,Lenkervorn	L		100	961	944	181	20x62	20x37	L20	71
66916000	240E52	1/25,1/40,Lenkervorn	L		90	961	943	175	20x62	20x62	L20	65
66397000	260E38	8/22,1/10Halter	H		100	740	740	28			D21	186
67379000	260E38	8/9	H		60	700	715	195	16x40	16x40	E1	72
67144000	260E42	1/22,2/24	V		90	950	950	198	20x62	20x62	A28	83
67182000	260E42	1/24,2/25	V		90	950	950	178	20x62	20x62	A53	74
66916000	260E42	1/25,1/40,Lenkervorn	L		90	961	943	175	20x62	20x62	L20	65
66379000	260E42	7/22,1/10Halter	H		100	740	740	33			D1.1	164
66397000	260E42	8/22,1/10Halter	H		100	740	740	28			D21	186
67152000	260E43	2/29	V	7,5	90	950	945	189	20x62	20x62	A54	58
67152000	260E47	2/29	V	7,5	90	950	945	189	20x62	20x62	A54	58
67144000	260E47	1/22,2/24	V		90	950	950	198	20x62	20x62	A28	83
67182000	260E47	1/24,2/25	V		90	950	950	178	20x62	20x62	A53	74
67366000	260E47	1/100x22;1/90x40,Lenkervorn	L		100	961	944	181	20x62	20x37	L20	71
66916000	260E47	1/25,1/40,Lenkervorn	L		90	961	943	175	20x62	20x62	L20	65

EUROSTAR

IVECO

EUROSTAR

Artikel.Nr.	Fahrzeugtyp	Info	Achsl.	Blattzahl	Breite	Lx/L1	Ly/L2	Spr./Kr.	Buchsen vorn	Buchsen hinten	Form	Paketstärke	
Art.-No.	Type		Axle Load	Leaves	Width			FreeArch/Crank	Bush front	Bush rear	Shape	Total height	
67144000	260E52	1/22,2/24	V	7,5	3	90	950	950	198	20x62	20x62	A28	83
67182000	260E52	1/24,2/25	V		3	90	950	950	178	20x62	20x62	A53	74
67366000	260E52	1/100x22;1/90x40,Lenkervorn	L		2	100	961	944	181	20x62	20x37	L20	71
66916000	260E52	1/25,1/40,Lenkervorn	L		2	90	961	943	175	20x62	20x62	L20	65
66924000	400E38	1/21,2/23	V		3	90	950	950	196	20x62	20x62	A28	79
67145000	400E38	1/28,1/32	L		2	90	670	228	21	20x62		L21	
66924000	400E42	1/21,2/23	V		3	90	950	950	196	20x62	20x62	A28	79
67144000	400E42	1/22,2/24	V		3	90	950	950	198	20x62	20x62	A28	83
67163000	400E42	3/21,1/36	H		4	100	900	900	171	20x62	20x62	A50	99
67145000	400E42	1/28,1/32	L		2	90	670	228	21	20x62		L21	
67152000	400E47	2/29	V		2	90	950	945	189	20x62	20x62	A54	58
66922000	400E52	1/23,2/24	V		3	80	924	924	183	20x57	20x57	A28	71
66924000	400E52	1/21,2/23	V		3	90	950	950	196	20x62	20x62	A28	79
67144000	400E52	1/22,2/24	V		3	90	950	950	198	20x62	20x62	A28	83
67163000	400E52	3/21,1/36	H		4	100	900	900	171	20x62	20x62	A50	99
66924000	440E38	1/21,2/23	V	3	90	950	950	196	20x62	20x62	A28	79	
67144000	440E38	1/22,2/24	V	3	90	950	950	198	20x62	20x62	A28	83	
67182000	440E38	1/24,2/25	V	3	90	950	950	178	20x62	20x62	A53	74	
67163000	440E38	3/21,1/36	H	4	100	900	900	171	20x62	20x62	A50	99	
66379000	440E38	7/22,1/10Halter	H	7	100	740	740	33			D1.1	164	
66397000	440E38	8/22,1/10Halter	H	8	100	740	740	28			D21	186	
67366000	440E38	1/100x22;1/90x40,Lenkervorn	L	2	100	961	944	181	20x62	20x37	L20	71	
67138000	440E38	1/25,1/40,Lenkervorn	L	2	90	950	931	109	20x62	20x62	L20	71	
67152000	440E39	2/29	V	7,5	2	90	950	945	189	20x62	20x62	A54	58
67154000	440E39	2/29	V	8,0	2	90	950	945	191	20x62	20x62	A28	58
66936000	440E39	1/25,1/40	L	2	90	950	931	109	20x62	20x62	L20	71	
67152000	440E42	2/29	V	7,5	2	90	950	945	189	20x62	20x62	A54	58
66924000	440E42	1/21,2/23	V	3	90	950	950	196	20x62	20x62	A28	79	
66926000	440E42	1/25,2/26	V	8,0	3	90	950	153	20x60	20x60	A28	89	
66986000	440E42	3/25	V	3	90	950	950	175	20x62	20x62	A1	87	
67144000	440E42	1/22,2/24	V	3	90	950	950	198	20x62	20x62	A28	83	
67182000	440E42	1/24,2/25	V	3	90	950	950	178	20x62	20x62	A53	74	
67138000	440E42	1/25,1/40,Lenkervorn	L	2	90	950	931	109	20x62	20x62	L20	71	
67163000	440E42	3/21,1/36	H	4	100	900	900	171	20x62	20x62	A50	99	
67165000	440E42	3/21,1/40	H	4	100	900	900	171	20x62	20x62	A50	103	
66379000	440E42	7/22,1/10Halter	H	7	100	740	740	33			D1.1	164	
67366000	440E42	1/100x22;1/90x40,Lenkervorn	L	2	100	961	944	181	20x62	20x37	L20	71	
66916000	440E42	1/25,1/40,Lenkervorn	L	2	90	961	943	175	20x62	20x62	L20	65	
67152000	440E43	2/29	V	7,5	2	90	950	945	189	20x62	20x62	A54	58
66936000	440E43	1/25,1/40	L	2	90	950	931	109	20x62	20x62	L20	71	
67152000	440E47	2/29	V	7,5	2	90	950	945	189	20x62	20x62	A54	58
66924000	440E47	1/21,2/23	V	3	90	950	950	196	20x62	20x62	A28	79	
67144000	440E47	1/22,2/24	V	3	90	950	950	198	20x62	20x62	A28	83	
67182000	440E47	1/24,2/25	V	3	90	950	950	178	20x62	20x62	A53	74	
67163000	440E47	3/21,1/36	H	4	100	900	900	171	20x62	20x62	A50	99	
67165000	440E47	3/21,1/40	H	4	100	900	900	171	20x62	20x62	A50	103	
67366000	440E47	1/100x22;1/90x40,Lenkervorn	L	2	100	961	944	181	20x62	20x37	L20	71	
66916000	440E47	1/25,1/40,Lenkervorn	L	2	90	961	943	175	20x62	20x62	L20	65	
67138000	440E47	1/25,1/40,Lenkervorn	L	2	90	950	931	109	20x62	20x62	L20	71	
67152000	440E52	2/29	V	7,5	2	90	950	945	189	20x62	20x62	A54	58
66924000	440E52	1/21,2/23	V	3	90	950	950	196	20x62	20x62	A28	79	
67144000	440E52	1/22,2/24	V	3	90	950	950	198	20x62	20x62	A28	83	
67182000	440E52	1/24,2/25	V	3	90	950	950	178	20x62	20x62	A53	74	
66971000	440E52	1/10Pl.,5/24,1/10Halter	H	4	100	740	740	85			D6	125	
67163000	440E52	3/21,1/36	H	4	100	900	900	171	20x62	20x62	A50	99	
67165000	440E52	3/21,1/40	H	4	100	900	900	171	20x62	20x62	A50	103	
66969000	440E52	1/10Pl.,5/24,1/10Halter	H	5	100	740	740	84			D6	152	

EUROSTAR**IVECO****EUROSTAR**

Artikel.Nr.	Fahrzeugtyp	Info	Achsl.	Blattzahl	Breite	Lx/L1	Ly/L2	Spr./ Kr.	Buchsen vorn	Buchsen hinten	Form	Paket- stärke
Art.-No.	Type		Axle Load	Leaves	Width			FreeArch /Crank	Bush front	Bush rear	Shape	Total height
66379000	440E52	7/22,1/10Halter	H	7	100	740	740	33			D1.1	164
67366000	440E52	1/100x22;1/90x40,Lenkervorn	L	2	100	961	944	181	20x62	20x37	L20	71
66916000	440E52	1/25,1/40,Lenkervorn	L	2	90	961	943	175	20x62	20x62	L20	65



EUROTECH

IVECO

EUROTECH

Artikel.Nr.	Fahrzeugtyp	Info	Achsl.	Blattzahl	Breite	Lx/L1	Ly/L2	Spr./ Kr.	Buchsen vorn	Buchsen hinten	Form	Paket- stärke	
Art.-No.	Type		Axle Load	Leaves	Width			FreeArch /Crank	Bush front	Bush rear	Shape	Total height	
67159000	150EH	7/16,1/8Pl.,11/10	H	18	80	840	840	146	20x57	20x57	A28	230	
67161000	170E23	3/24,1/38	H	4	80	840	840	128	20x57	20x57	A50	110	
67159000	170E23	7/16,1/8Pl.,11/10	H	18	80	840	840	146	20x57	20x57	A28	230	
67161000	170E27	3/24,1/38	H	4	80	840	840	128	20x57	20x57	A50	110	
67159000	170E27	7/16,1/8Pl.,11/10	H	18	80	840	840	146	20x57	20x57	A28	230	
67159000	170EK	7/16,1/8Pl.,11/10	H	18	80	840	840	146	20x57	20x57	A28	230	
67169000	175ET	3/24,1/33	H	4	80	840	840	136	20x57	20x57	A50	105	
67169000	176ET	3/24,1/33	H	4	80	840	840	136	20x57	20x57	A50	105	
67142000	180E24	1/23,2/25	V	3	80	924	924	172	20	20	A28	73	
67140000	180E24	8/16	V	8	80	924	924	120	20	20	A28	128	
67146000	180E24	2/15,6/16	V	8	80	924	924	123	20	20	A28	126	
67161000	180E24	3/24,1/38	H	4	80	840	840	128	20x57	20x57	A50	110	
67159000	180E24	7/16,1/8Pl.,11/10	H	18	80	840	840	146	20x57	20x57	A28	230	
67142000	180E27	1/23,2/25	V	3	80	924	924	172	20	20	A28	73	
67140000	180E27	8/16	V	8	80	924	924	120	20	20	A28	128	
67146000	180E27	2/15,6/16	V	8	80	924	924	123	20	20	A28	126	
67161000	180E27	3/24,1/38	H	4	80	840	840	128	20x57	20x57	A50	110	
67159000	180E27	7/16,1/8Pl.,11/10	H	18	80	840	840	146	20x57	20x57	A28	230	
66928000	180E30	3/26	V	3	80	924	924	142	20x57	20x57	A28	78	
67142000	180E30	1/23,2/25	V	3	80	924	924	172	20	20	A28	73	
67146000	180E30	2/15,6/16	V	8	80	924	924	123	20	20	A28	126	
67161000	180E30	3/24,1/38	H	4	80	840	840	128	20x57	20x57	A50	110	
67159000	180E30	7/16,1/8Pl.,11/10	H	18	80	840	840	146	20x57	20x57	A28	230	
67142000	180E34	1/23,2/25	V	3	80	924	924	172	20	20	A28	73	
67146000	180E34	2/15,6/16	V	8	80	924	924	123	20	20	A28	126	
67144000	180E34	1/22,2/24	V	3	90	950	950	198	20x62	20x62	A28	83	
67163000	180E34	3/21,1/36	H	4	100	900	900	171	20x62	20x62	A50	99	
67161000	180E34	3/24,1/38	H	4	80	840	840	128	20x57	20x57	A50	110	
67159000	180E34	7/16,1/8Pl.,11/10	H	18	80	840	840	146	20x57	20x57	A28	230	
67366000	180E34	1/100x22;1/90x40,Lenkervorn	L	2	100	961	944	181	20x62	20x37	L20	71	
67144000	MP180E34	1/22,2/24	V	3	90	950	950	198	20x62	20x62	A28	83	
67163000	MP180E34	3/21,1/36	H	4	100	900	900	171	20x62	20x62	A50	99	
66928000	MT180E34	3/26	V	3	80	924	924	142	20x57	20x57	A28	78	
67142000	MT180E34	1/23,2/25	V	3	80	924	924	172	20	20	A28	73	
67146000	MT180E34	2/15,6/16	V	8	80	924	924	123	20	20	A28	126	
67161000	MT180E34	3/24,1/38	H	4	80	840	840	128	20x57	20x57	A50	110	
67159000	MT180E34	7/16,1/8Pl.,11/10	H	18	80	840	840	146	20x57	20x57	A28	230	
67144000	180E38	1/22,2/24	V	3	90	950	950	198	20x62	20x62	A28	83	
67163000	180E38	3/21,1/36	H	4	100	900	900	171	20x62	20x62	A50	99	
66916000	180E38	1/25,1/40,Lenkervorn	L	2	90	961	943	175	20x62	20x62	L20	65	
67144000	180E42	1/22,2/24	V	3	90	950	950	198	20x62	20x62	A28	83	
67163000	180E42	3/21,1/36	H	4	100	900	900	171	20x62	20x62	A50	99	
66928000	190E24	3/26	V	3	80	924	924	142	20x57	20x57	A28	78	
67140000	190E24	8/16	V	8	80	924	924	120	20	20	A28	128	
67146000	190E24	2/15,6/16	V	8	80	924	924	123	20	20	A28	126	
67152000	190E24	2/29	V	7,5	2	90	950	945	189	20x62	20x62	A54	58
67302000	190E24	8/15	V	8	90	950	950	156	20x60	20x60	A65	120	
67417000	190E24	10/15	H	10	100	900	675	131	20x62	20x62	A59	150	
67391000	190E24	11/12,1/12Pl.,8/11	H	13,0	19	100	900	180	20x62	20x62	F7	232	
67153000	190E24	3/26,1/41	H	4	80	840	840	104	20x57	20x57	A48	119	
67157000	190E24	2/16,5/18,1/8Pl.,9/11	H	16	80	840	840	132	20x57	20x57	A28	229	
67140000	190E24K	8/16	V	8	80	924	924	120	20	20	A28	128	
66928000	190E27	3/26	V	3	80	924	924	142	20x57	20x57	A28	78	
67140000	190E27	8/16	V	8	80	924	924	120	20	20	A28	128	
67146000	190E27	2/15,6/16	V	8	80	924	924	123	20	20	A28	126	
67153000	190E27	3/26,1/41	H	4	80	840	840	104	20x57	20x57	A48	119	
67157000	190E27	2/16,5/18,1/8Pl.,9/11	H	16	80	840	840	132	20x57	20x57	A28	229	

EUROTECH

IVECO

EUROTECH

Artikel.Nr.	Fahrzeugtyp	Info	Achsl.	Blattzahl	Breite	Lx/L1	Ly/L2	Spr./ Kr.	Buchsen vorn	Buchsen hinten	Form	Paket- stärke
Art.-No.	Type		Axle Load	Leaves	Width			FreeArch/ Crank	Bush front	Bush rear	Shape	Total height
67140000	190E27K	8/16	V	8	80	924	924	120	20	20	A28	128
66928000	190E30	3/26	V	3	80	924	924	142	20x57	20x57	A28	78
67140000	190E30	8/16	V	8	80	924	924	120	20	20	A28	128
67153000	190E30	3/26,1/41	H	4	80	840	840	104	20x57	20x57	A48	119
67157000	190E30	2/16,5/18,1/8Pl.,9/11	H	16	80	840	840	132	20x57	20x57	A28	229
67140000	190E30K	8/16	V	8	80	924	924	120	20	20	A28	128
67152000	190E31	2/29	V	7,5	2	90	945	189	20x62	20x62	A54	58
67417000	190E31	10/15	H	10	100	900	675	131	20x62	20x62	A59	150
66924000	190E34	1/21,2/23	V	3	90	950	950	196	20x62	20x62	A28	79
67144000	190E34	1/22,2/24	V	3	90	950	950	198	20x62	20x62	A28	83
67182000	190E34	1/24,2/25	V	3	90	950	950	178	20x62	20x62	A53	74
67163000	190E34	3/21,1/36	H	4	100	900	900	171	20x62	20x62	A50	99
67165000	190E34	3/21,1/40	H	4	100	900	900	171	20x62	20x62	A50	103
67366000	190E34	1/100x22;1/90x40,Lenkervorn	L	2	100	961	944	181	20x62	20x37	L20	71
66916000	190E34	1/25,1/40,Lenkervorn	L	2	90	961	943	175	20x62	20x62	L20	65
67138000	190E34	1/25,1/40,Lenkervorn	L	2	90	950	931	109	20x62	20x62	L20	71
67152000	190E35	2/29	V	7,5	2	90	945	189	20x62	20x62	A54	58
66924000	190E38	1/21,2/23	V	3	90	950	950	196	20x62	20x62	A28	79
67144000	190E38	1/22,2/24	V	3	90	950	950	198	20x62	20x62	A28	83
67182000	190E38	1/24,2/25	V	3	90	950	950	178	20x62	20x62	A53	74
67165000	190E38	3/21,1/40	H	4	100	900	900	171	20x62	20x62	A50	103
67366000	190E38	1/100x22;1/90x40,Lenkervorn	L	2	100	961	944	181	20x62	20x37	L20	71
67138000	190E38	1/25,1/40,Lenkervorn	L	2	90	950	931	109	20x62	20x62	L20	71
67152000	190E39	2/29	V	7,5	2	90	945	189	20x62	20x62	A54	58
66924000	190E42	1/21,2/23	V	3	90	950	950	196	20x62	20x62	A28	79
66926000	190E42	1/25,2/26	V	8,0	3	90	950	153	20x60	20x60	A28	89
67144000	190E42	1/22,2/24	V	3	90	950	950	198	20x62	20x62	A28	83
67182000	190E42	1/24,2/25	V	3	90	950	950	178	20x62	20x62	A53	74
67302000	190E42	8/15	V	8	90	950	950	156	20x60	20x60	A65	120
67163000	190E42	3/21,1/36	H	4	100	900	900	171	20x62	20x62	A50	99
67165000	190E42	3/21,1/40	H	4	100	900	900	171	20x62	20x62	A50	103
67415000	190E42	10/12,7/11	H	11,5	17	100	900	180	20x62	20x62	F7	197
67391000	190E42	11/12,1/12Pl.,8/11	H	13,0	19	100	900	180	20x62	20x62	F7	232
67415000	MH190E24	10/12,7/11	H	11,5	17	100	900	180	20	20	F7	197
67415000	MH190E30	10/12,7/11	H	11,5	17	100	900	180	20x62	20x62	F7	197
67415000	MH190E38	10/12,7/11	H	11,5	17	100	900	180	20x62	20x62	F7	197
67144000	MP 190E30	1/22,2/24	V	3	90	950	950	198	20x62	20x62	A28	83
67165000	MP 190E30	3/21,1/40	H	4	100	900	900	171	20x62	20x62	A50	103
66928000	MT190E30	3/26	V	3	80	924	924	142	20x57	20x57	A28	78
67140000	MT190E30	8/16	V	8	80	924	924	120	20	20	A28	128
67146000	MT190E30	2/15,6/16	V	8	80	924	924	123	20	20	A28	126
67153000	MT190E30	3/26,1/41	H	4	80	840	840	104	20x57	20x57	A48	119
67157000	MT190E30	2/16,5/18,1/8Pl.,9/11	H	16	80	840	840	132	20x57	20x57	A28	229
67152000	240E25	2/29	V	7,5	2	90	945	189	20x62	20x62	A54	58
67147000	240E25	3/31,1/10Halter	H	3	100	660	950	94			D6	109
67413000	240E25	3/43,1/10Halter	H	3	100	670	955	81			D1.1	145
67144000	240E30	1/22,2/24	V	3	90	950	950	198	20x62	20x62	A28	83
67182000	240E30	1/24,2/25	V	3	90	950	950	178	20x62	20x62	A53	74
66926000	240E34	1/25,2/26	V	8,0	3	90	950	153	20x60	20x60	A28	89
67144000	240E34	1/22,2/24	V	3	90	950	950	198	20x62	20x62	A28	83
67182000	240E34	1/24,2/25	V	3	90	950	950	178	20x62	20x62	A53	74
67147000	240E34	3/31,1/10Halter	H	3	100	660	950	94			D6	109
67413000	240E34	3/43,1/10Halter	H	3	100	670	955	81			D1.1	145
66969000	240E34	1/10Pl.,5/24,1/10Halter	H	5	100	740	740	84			D6	152
67366000	240E34	1/100x22;1/90x40,Lenkervorn	L	2	100	961	944	181	20x62	20x37	L20	71
66916000	240E34	1/25,1/40,Lenkervorn	L	2	90	961	943	175	20x62	20x62	L20	65
66926000	240E38	1/25,2/26	V	8,0	3	90	950	153	20x60	20x60	A28	89

EUROTECH

IVECO

EUROTECH

Artikel.Nr.	Fahrzeugtyp	Info	Achsl.	Blattzahl	Breite	Lx/L1	Ly/L2	Spr./Kr.	Buchsen vorn	Buchsen hinten	Form	Paketstärke	
Art.-No.	Type		Axle Load	Leaves	Width			FreeArch/Crank	Bush front	Bush rear	Shape	Total height	
67144000	240E38	1/22,2/24	V	8,0	3	90	950	950	198	20x62	20x62	A28	83
67182000	240E38	1/24,2/25	V	8,0	3	90	950	950	178	20x62	20x62	A53	74
67147000	240E38	3/31,1/10Halter	H	8,0	3	100	660	950	94			D6	109
67413000	240E38	3/43,1/10Halter	H	8,0	3	100	670	955	81			D1.1	145
67366000	240E38	1/100x22;1/90x40,Lenkervorn	L	8,0	2	100	961	944	181	20x62	20x37	L20	71
66916000	240E38	1/25,1/40,Lenkervorn	L	8,0	2	90	961	943	175	20x62	20x62	L20	65
66926000	240E42	1/25,2/26	V	8,0	3	90	950	950	153	20x60	20x60	A28	89
67144000	240E42	1/22,2/24	V	8,0	3	90	950	950	198	20x62	20x62	A28	83
67182000	240E42	1/24,2/25	V	8,0	3	90	950	950	178	20x62	20x62	A53	74
67147000	240E42	3/31,1/10Halter	H	8,0	3	100	660	950	94			D6	109
67413000	240E42	3/43,1/10Halter	H	8,0	3	100	670	955	81			D1.1	145
66969000	240E42	1/10Pl.,5/24,1/10Halter	H	8,0	5	100	740	740	84			D6	152
67366000	240E42	1/100x22;1/90x40,Lenkervorn	L	8,0	2	100	961	944	181	20x62	20x37	L20	71
66916000	240E42	1/25,1/40,Lenkervorn	L	8,0	2	90	961	943	175	20x62	20x62	L20	65
67366000	240E52	1/100x22;1/90x40,Lenkervorn	L	8,0	2	100	961	944	181	20x62	20x37	L20	71
67152000	260E24	2/29	V	7,5	2	90	950	945	189	20x62	20x62	A54	58
67147000	260E24	3/31,1/10Halter	H	7,5	3	100	660	950	94			D6	109
67152000	260E31	2/29	V	7,5	2	90	950	945	189	20x62	20x62	A54	58
67147000	260E31	3/31,1/10Halter	H	7,5	3	100	660	950	94			D6	109
67152000	260E35	2/29	V	7,5	2	90	950	945	189	20x62	20x62	A54	58
67144000	260E38	1/22,2/24	V	7,5	3	90	950	950	198	20x62	20x62	A28	83
67182000	260E38	1/24,2/25	V	7,5	3	90	950	950	178	20x62	20x62	A53	74
66379000	260E38	7/22,1/10Halter	H	7,5	7	100	740	740	33			D1.1	164
66397000	260E38	8/22,1/10Halter	H	7,5	8	100	740	740	28			D21	186
66916000	260E38	1/25,1/40,Lenkervorn	L	7,5	2	90	961	943	175	20x62	20x62	L20	65
67152000	260E39	2/29	V	7,5	2	90	950	945	189	20x62	20x62	A54	58
66926000	260E42	1/25,2/26	V	8,0	3	90	950	950	153	20x60	20x60	A28	89
67144000	260E42	1/22,2/24	V	8,0	3	90	950	950	198	20x62	20x62	A28	83
67182000	260E42	1/24,2/25	V	8,0	3	90	950	950	178	20x62	20x62	A53	74
66971000	260E42	1/10Pl.,5/24,1/10Halter	H	8,0	4	100	740	740	85			D6	125
66379000	260E42	7/22,1/10Halter	H	8,0	7	100	740	740	33			D1.1	164
66397000	260E42	8/22,1/10Halter	H	8,0	8	100	740	740	28			D21	186
67152000	260E43	2/29	V	7,5	2	90	950	945	189	20x62	20x62	A54	58
67149000	260Y	4/27,1/10Halter	H	7,5	4	90	742	742	86			D1.1	130
66922000	325E27	1/23,2/24	V	7,5	3	80	924	924	183	20x57	20x57	A28	71
67169000	325E27	3/24,1/33	H	7,5	4	80	840	840	136	20x57	20x57	A50	105
66922000	400E30	1/23,2/24	V	7,5	3	80	924	924	183	20x57	20x57	A28	71
67161000	400E30	3/24,1/38	H	7,5	4	80	840	840	128	20x57	20x57	A50	110
67169000	400E30	3/24,1/33	H	7,5	4	80	840	840	136	20x57	20x57	A50	105
66922000	400E34	1/23,2/24	V	7,5	3	80	924	924	183	20x57	20x57	A28	71
67152000	400E34	2/29	V	7,5	2	90	950	945	189	20x62	20x62	A54	58
66924000	400E34	1/21/2/23	V	7,5	3	90	950	950	196	20x62	20x62	A28	79
67144000	400E34	1/22,2/24	V	7,5	3	90	950	950	198	20x62	20x62	A28	83
67163000	400E34	3/21,1/36	H	7,5	4	100	900	900	171	20x62	20x62	A50	99
67161000	400E34	3/24,1/38	H	7,5	4	80	840	840	128	20x57	20x57	A50	110
67366000	400E34	1/100x22;1/90x40,Lenkervorn	L	7,5	2	100	961	944	181	20x62	20x37	L20	71
66916000	400E34	1/25,1/40,Lenkervorn	L	7,5	2	90	961	943	175	20x62	20x62	L20	65
67145000	400E34	1/28,1/32	L	7,5	2	90	670	228	21	20x62		L21	
66924000	MP400E34	1/21/2/23	V	7,5	3	90	950	950	196	20x62	20x62	A28	79
67144000	MP400E34	1/22,2/24	V	7,5	3	90	950	950	198	20x62	20x62	A28	83
66916000	MP400E34	1/25,1/40,Lenkervorn	L	7,5	2	90	961	943	175	20x62	20x62	L20	65
67145000	MP400E34	1/28,1/32	L	7,5	2	90	670	228	21	20x62		L21	
67163000	MP400E34	3/21,1/36	H	7,5	4	100	900	900	171	20x62	20x62	A50	99
66922000	MT400E34	1/23,2/24	V	7,5	3	80	924	924	183	20x57	20x57	A28	71
67161000	MT400E34	3/24,1/38	H	7,5	4	80	840	840	128	20x57	20x57	A50	110
67169000	MT400E34	3/24,1/33	H	7,5	4	80	840	840	136	20x57	20x57	A50	105
66924000	400E38	1/21/2/23	V	8,0	3	90	950	950	196	20x62	20x62	A28	79

EUROTECH

IVECO

EUROTECH

Artikel.Nr.	Fahrzeugtyp	Info	Achsl.	Blattzahl	Breite	Lx/L1	Ly/L2	Spr./ Kr.	Buchsen vorn	Buchsen hinten	Form	Paket- stärke
Art.-No.	Type		Axle Load	Leaves	Width			FreeArch /Crank	Bush front	Bush rear	Shape	Total height
67144000	400E38	1/22,2/24	V	3	90	950	950	198	20x62	20x62	A28	83
67163000	400E38	3/21,1/36	H	4	100	900	900	171	20x62	20x62	A50	99
66916000	400E38	1/25,1/40,Lenkervorn	L	2	90	961	943	175	20x62	20x62	L20	65
67145000	400E38	1/28,1/32	L	2	90	670	228	21	20x62		L21	
66924000	400E42	1/21/2/23	V	3	90	950	950	196	20x62	20x62	A28	79
67144000	400E42	1/22,2/24	V	3	90	950	950	198	20x62	20x62	A28	83
67163000	400E42	3/21,1/36	H	4	100	900	900	171	20x62	20x62	A50	99
66916000	400E42	1/25,1/40,Lenkervorn	L	2	90	961	943	175	20x62	20x62	L20	65
67152000	440E31	2/29	V	7,5	2	90	945	189	20x62	20x62	A54	58
67152000	440E34	2/29	V	7,5	2	90	945	189	20x62	20x62	A54	58
66924000	440E34	1/21/2/23	V	3	90	950	950	196	20x62	20x62	A28	79
67144000	440E34	1/22,2/24	V	3	90	950	950	198	20x62	20x62	A28	83
67182000	440E34	1/24,2/25	V	3	90	950	950	178	20x62	20x62	A53	74
67163000	440E34	3/21,1/36	H	4	100	900	900	171	20x62	20x62	A50	99
67165000	440E34	3/21,1/40	H	4	100	900	900	171	20x62	20x62	A50	103
67366000	440E34	1/100x22;1/90x40,Lenkervorn	L	2	100	961	944	181	20x62	20x37	L20	71
66916000	440E34	1/25,1/40,Lenkervorn	L	2	90	961	943	175	20x62	20x62	L20	65
67138000	440E34	1/25,1/40,Lenkervorn	L	2	90	950	931	109	20x62	20x62	L20	71
67152000	440E35	2/29	V	7,5	2	90	945	189	20x62	20x62	A54	58
67152000	440E38	2/29	V	7,5	2	90	945	189	20x62	20x62	A54	58
66924000	440E38	1/21/2/23	V	3	90	950	950	196	20x62	20x62	A28	79
67144000	440E38	1/22,2/24	V	3	90	950	950	198	20x62	20x62	A28	83
67182000	440E38	1/24,2/25	V	3	90	950	950	178	20x62	20x62	A53	74
66971000	440E38	1/10Pl.,5/24,1/10Halter	H	4	100	740	740	85			D6	125
67163000	440E38	3/21,1/36	H	4	100	900	900	171	20x62	20x62	A50	99
66969000	440E38	1/10Pl.,5/24,1/10Halter	H	5	100	740	740	84			D6	152
66379000	440E38	7/22,1/10Halter	H	7	100	740	740	33			D1.1	164
66397000	440E38	8/22,1/10Halter	H	8	100	740	740	28			D21	186
66916000	440E38	1/25,1/40,Lenkervorn	L	2	90	961	943	175	20x62	20x62	L20	65
67138000	440E38	1/25,1/40,Lenkervorn	L	2	90	950	931	109	20x62	20x62	L20	71
67152000	440E39	2/29	V	7,5	2	90	945	189	20x62	20x62	A54	58
67154000	440E39	2/29	V	8,0	2	90	945	191	20x62	20x62	A28	58
67152000	440E42	2/29	V	7,5	2	90	945	189	20x62	20x62	A54	58
66924000	440E42	1/21/2/23	V	3	90	950	950	196	20x62	20x62	A28	79
66926000	440E42	1/25,2/26	V	8,0	3	90	950	153	20x60	20x60	A28	89
66986000	440E42	3/25	V	3	90	950	950	175	20x62	20x62	A1	87
67144000	440E42	1/22,2/24	V	3	90	950	950	198	20x62	20x62	A28	83
67182000	440E42	1/24,2/25	V	3	90	950	950	178	20x62	20x62	A53	74
67302000	440E42	8/15	V	8	90	950	950	156	20x60	20x60	A65	120
67147000	440E42	3/31,1/10Halter	H	3	100	660	950	94			D6	109
66971000	440E42	1/10Pl.,5/24,1/10Halter	H	4	100	740	740	85			D6	125
67163000	440E42	3/21,1/36	H	4	100	900	900	171	20x62	20x62	A50	99
67165000	440E42	3/21,1/40	H	4	100	900	900	171	20x62	20x62	A50	103
66969000	440E42	1/10Pl.,5/24,1/10Halter	H	5	100	740	740	84			D6	152
66397000	440E42	8/22,1/10Halter	H	8	100	740	740	28			D21	186
67415000	440E42	10/12,7/11	H	11,5	17	100	900	180	20x62	20x62	F7	197
67391000	440E42	11/12,1/12Pl.,8/11	H	13,0	19	100	900	180	20x62	20x62	F7	232
67366000	440E42	1/100x22;1/90x40,Lenkervorn	L	2	100	961	944	181	20x62	20x37	L20	71
66916000	440E42	1/25,1/40,Lenkervorn	L	2	90	961	943	175	20x62	20x62	L20	65
67138000	440E42	1/25,1/40,Lenkervorn	L	2	90	950	931	109	20x62	20x62	L20	71
67152000	440E43	2/29	V	7,5	2	90	945	189	20x62	20x62	A54	58
66397000	440E52	8/22,1/10Halter	H	8	100	740	740	28			D21	186

EUROTRAKKER

IVECO

EUROTRAKKER

Artikel.Nr.	Fahrzeugtyp	Info	Achsl.	Blattzahl	Breite	Lx/L1	Ly/L2	Spr./Kr.	Buchsen vorn	Buchsen hinten	Form	Paketstärke
Art.-No.	Type		Axle Load	Leaves	Width			FreeArch/Crank	Bush front	Bush rear	Shape	Total height
67165000	180E25	3/21,1/40	H		100	900	900	171	20x62	20x62	A50	103
66926000	190E30	1/25,2/26	V	8,0	90	950	950	153	20x60	20x60	A28	89
66984000	190E30	1/27,2/28	V	9,0	90	950	950	146	20x60	20x60	A28	95
66986000	190E30	3/25	V	3	90	950	950	175	20x62	20x62	A1	87
67302000	190E30	8/15	V	8	90	950	950	156	20x60	20x60	A65	120
67195000	190E30	3/26,1/40	H	4	100	900	900	126	20	20	A50	118
67319000	190E30	8/17,1/Pl.,6/15	H	13,0	100	900	900	115	20x62	20x62	A60	
66926000	190E31	1/25,2/26	V	8,0	90	950	950	153	20x60	20x60	A28	89
67302000	190E31	8/15	V	8	90	950	950	156	20x60	20x60	A65	120
67319000	190E31	8/17,1/Pl.,6/15	H	13,0	100	900	900	115	20x62	20x62	A60	
66926000	190E34	1/25,2/26	V	8,0	90	950	950	153	20x60	20x60	A28	89
66986000	190E34	3/25	V	3	90	950	950	175	20x62	20x62	A1	87
67302000	190E34	8/15	V	8	90	950	950	156	20x60	20x60	A65	120
67195000	190E34	3/26,1/40	H	4	100	900	900	126	20	20	A50	118
67319000	190E34	8/17,1/Pl.,6/15	H	13,0	100	900	900	115	20x62	20x62	A60	
66926000	190E37	1/25,2/26	V	8,0	90	950	950	153	20x60	20x60	A28	89
66986000	190E37	3/25	V	3	90	950	950	175	20x62	20x62	A1	87
67302000	190E37	8/15	V	8	90	950	950	156	20x60	20x60	A65	120
67195000	190E37	3/26,1/40	H	4	100	900	900	126	20	20	A50	118
67319000	190E37	8/17,1/Pl.,6/15	H	13,0	100	900	900	115	20x62	20x62	A60	
66926000	190E42	1/25,2/26	V	8,0	90	950	950	153	20x60	20x60	A28	89
66984000	190E42	1/27,2/28	V	9,0	90	950	950	146	20x60	20x60	A28	95
66986000	190E42	3/25	V	3	90	950	950	175	20x62	20x62	A1	87
67302000	190E42	8/15	V	8	90	950	950	156	20x60	20x60	A65	120
67195000	190E42	3/26,1/40	H	4	100	900	900	126	20	20	A50	118
67319000	190E42	8/17,1/Pl.,6/15	H	13,0	100	900	900	115	20x62	20x62	A60	
67391000	190E42	11/12,1/12Pl.,8/11	H	13,0	100	900	900	180	20x62	20x62	F7	232
66926000	260E30	1/25,2/26	V	8,0	90	950	950	153	20x60	20x60	A28	89
66986000	260E30	3/25	V	3	90	950	950	175	20x62	20x62	A1	87
67302000	260E30	8/15	V	8	90	950	950	156	20x60	20x60	A65	120
67177000	260E30	3/26,1/43,1/10Halter	H	10,5	100	730	730	87			D4	136
66981000	260E30	8/22,1/10Halter	H	10,5	100	740	740	99			D20	186
66926000	260E30H	1/25,2/26	V	8,0	90	950	950	153	20x60	20x60	A28	89
67177000	260E31	3/26,1/43,1/10Halter	H	10,5	100	730	730	87			D4	136
66926000	260E34	1/25,2/26	V	8,0	90	950	950	153	20x60	20x60	A28	89
66986000	260E34	3/25	V	3	90	950	950	175	20x62	20x62	A1	87
67302000	260E34	8/15	V	8	90	950	950	156	20x60	20x60	A65	120
67177000	260E34	3/26,1/43,1/10Halter	H	10,5	100	730	730	87			D4	136
66981000	260E34	8/22,1/10Halter	H	10,5	100	740	740	99			D20	186
67177000	260E35	3/26,1/43,1/10Halter	H	10,5	100	730	730	87			D4	136
66926000	260E37	1/25,2/26	V	8,0	90	950	950	153	20x60	20x60	A28	89
66986000	260E37	3/25	V	3	90	950	950	175	20x62	20x62	A1	87
67302000	260E37	8/15	V	8	90	950	950	156	20x60	20x60	A65	120
67177000	260E37	3/26,1/43,1/10Halter	H	10,5	100	730	730	87			D4	136
66981000	260E37	8/22,1/10Halter	H	10,5	100	740	740	99			D20	186
66926000	260E37HW	1/25,2/26	V	8,0	90	950	950	153	20x60	20x60	A28	89
66986000	260E38	3/25	V	3	90	950	950	175	20x62	20x62	A1	87
67302000	260E38	8/15	V	8	90	950	950	156	20x60	20x60	A65	120
67177000	260E38	3/26,1/43,1/10Halter	H	10,5	100	730	730	87			D4	136
66926000	260E42	1/25,2/26	V	8,0	90	950	950	153	20x60	20x60	A28	89
66986000	260E42	3/25	V	3	90	950	950	175	20x62	20x62	A1	87
67177000	260E42	3/26,1/43,1/10Halter	H	10,5	100	730	730	87			D4	136
66981000	260E42	8/22,1/10Halter	H	10,5	100	740	740	99			D20	186
67177000	260E44	3/26,1/43,1/10Halter	H	10,5	100	730	730	87			D4	136
66986000	260E47	3/25	V	3	90	950	950	175	20x62	20x62	A1	87
67302000	260E47	8/15	V	8	90	950	950	156	20x60	20x60	A65	120
67177000	260E47	3/26,1/43,1/10Halter	H	10,5	100	730	730	87			D4	136

EUROTRAKKER

IVECO

EUROTRAKKER

Artikel.Nr.	Fahrzeugtyp	Info	Achsl.	Blattzahl	Breite	Lx/L1	Ly/L2	Spr./ Kr.	Buchsen vorn	Buchsen hinten	Form	Paket- stärke	
Art.-No.	Type		Axle Load	Leaves	Width			FreeArch /Crank	Bush front	Bush rear	Shape	Total height	
67177000	260E48	3/26,1/43,1/10Halter	H	10,5	4	100	730	730	87			D4	136
66926000	330E34	1/25,2/26	V	8,0	3	90	950	950	153	20x60	20x60	A28	89
67302000	330E34	8/15	V		8	90	950	950	156	20x60	20x60	A65	120
67167000	330E34	3/26,1/53,1/10Halter	H	13,0	4	100	730	730	75			D4	150
66387000	330E34	Doppelachslast,11/22,1/10Halter	H	13,0	11	100	740	740	71			D20	252
66926000	330E34HW	1/25,2/26	V	8,0	3	90	950	950	153	20x60	20x60	A28	89
66926000	330E37	1/25,2/26	V	8,0	3	90	950	950	153	20x60	20x60	A28	89
67302000	330E37	8/15	V		8	90	950	950	156	20x60	20x60	A65	120
67167000	330E37	3/26,1/53,1/10Halter	H	13,0	4	100	730	730	75			D4	150
66387000	330E37	Doppelachslast,11/22,1/10Halter	H	13,0	11	100	740	740	71			D20	252
66926000	330E37HW	1/25,2/26	V	8,0	3	90	950	950	153	20x60	20x60	A28	89
66926000	340E34	1/25,2/26	V	8,0	3	90	950	950	153	20x60	20x60	A28	89
66932000	340E34	3/25	V		3	90	760	760	86	20x62	20x62	A20	87
66874000	340E34	9/13	V		9	90	760	760	83	20x62	20x62	A62	117
67177000	340E34	3/26,1/43,1/10Halter	H	10,5	4	100	730	730	87			D4	136
66981000	340E34	8/22,1/10Halter	H	10,5	8	100	740	740	99			D20	186
66926000	340E35	1/25,2/26	V	8,0	3	90	950	950	153	20x60	20x60	A28	89
66926900	340E35	1/25,2/26	V	8,0	3	90	950	950	153	37x60	20x60	A53	89
67177000	340E35	3/26,1/43,1/10Halter	H	10,5	4	100	730	730	87			D4	136
66932000	340E37	3/25	V		3	90	760	760	86	20x62	20x62	A20	87
66874000	340E37	9/13	V		9	90	760	760	83	20x62	20x62	A62	117
67177000	340E37	3/26,1/43,1/10Halter	H	10,5	4	100	730	730	87			D4	136
66981000	340E37	8/22,1/10Halter	H	10,5	8	100	740	740	99			D20	186
67177000	340E38	3/26,1/43,1/10Halter	H	10,5	4	100	730	730	87			D4	136
66926000	340E42	1/25,2/26	V	8,0	3	90	950	950	153	20x60	20x60	A28	89
66932000	340E42	3/25	V		3	90	760	760	86	20x62	20x62	A20	87
66874000	340E42	9/13	V		9	90	760	760	83	20x62	20x62	A62	117
67177000	340E42	3/26,1/43,1/10Halter	H	10,5	4	100	730	730	87			D4	136
66981000	340E42	8/22,1/10Halter	H	10,5	8	100	740	740	99			D20	186
67177000	340E44	3/26,1/43,1/10Halter	H	10,5	4	100	730	730	87			D4	136
66389000	360E42	11/22,1/10Halter	H		11	100	730	730	29			D1.1	252
66932000	360Y	3/25	V		3	90	760	760	86	20x62	20x62	A20	87
66926000	380E31	1/25,2/26	V	8,0	3	90	950	950	153	20x60	20x60	A28	89
67302000	380E31	8/15	V		8	90	950	950	156	20x60	20x60	A65	120
67308000	380E31	9/16	V	8,5	9	90	950	950	140	20x60	20x60	A65	144
67167000	380E31	3/26,1/53,1/10Halter	H	13,0	4	100	730	730	75			D4	150
67419000	380E31	4/53,1/10Halter	H		4	100	760	760	54			D1.1	234
67185000	380E31	13/22,1/10Halter	H	16,0	13	100	730	730	73			D1.1	296
66926000	380E34	1/25,2/26	V	8,0	3	90	950	950	153	20x60	20x60	A28	89
67302000	380E34	8/15	V		8	90	950	950	156	20x60	20x60	A65	120
67167000	380E34	3/26,1/53,1/10Halter	H	13,0	4	100	730	730	75			D4	150
67419000	380E34	4/53,1/10Halter	H		4	100	760	760	54			D1.1	234
66387000	380E34	Doppelachslast,11/22,1/10Halter	H	13,0	11	100	740	740	71			D20	252
67185000	380E34	13/22,1/10Halter	H	16,0	13	100	730	730	73			D1.1	296
66926000	380E34H	1/25,2/26	V	8,0	3	90	950	950	153	20x60	20x60	A28	89
67167000	380E35	3/26,1/53,1/10Halter	H	13,0	4	100	730	730	75			D4	150
66926000	380E37	1/25,2/26	V	8,0	3	90	950	950	153	20x60	20x60	A28	89
67302000	380E37	8/15	V		8	90	950	950	156	20x60	20x60	A65	120
67167000	380E37	3/26,1/53,1/10Halter	H	13,0	4	100	730	730	75			D4	150
67419000	380E37	4/53,1/10Halter	H		4	100	760	760	54			D1.1	234
66387000	380E37	Doppelachslast,11/22,1/10Halter	H	13,0	11	100	740	740	71			D20	252
67185000	380E37	13/22,1/10Halter	H	16,0	13	100	730	730	73			D1.1	296
66926000	380E37H	1/25,2/26	V	8,0	3	90	950	950	153	20x60	20x60	A28	89
67167000	380E38	3/26,1/53,1/10Halter	H	13,0	4	100	730	730	75			D4	150
66926000	380E42	1/25,2/26	V	8,0	3	90	950	950	153	20x60	20x60	A28	89
67302000	380E42	8/15	V		8	90	950	950	156	20x60	20x60	A65	120
67167000	380E42	3/26,1/53,1/10Halter	H	13,0	4	100	730	730	75			D4	150

EUROTRAKKER

IVECO

EUROTRAKKER

Artikel.Nr.	Fahrzeugtyp	Info	Achsl.	Blattzahl	Breite	Lx/L1	Ly/L2	Spr./Kr.	Buchsen vorn	Buchsen hinten	Form	Paketstärke
Art.-No.	Type		Axle Load	Leaves	Width			FreeArch/Crank	Bush front	Bush rear	Shape	Total height
67419000	380E42	4/53,1/10Halter	H		100	760	760	54			D1.1	234
66387000	380E42	Doppelachslast,11/22,1/10Halter	H	13,0	100	740	740	71			D20	252
67185000	380E42	13/22,1/10Halter	H	16,0	100	730	730	73			D1.1	296
66926000	380E42H	1/25,2/26	V	8,0	90	950	950	153	20x60	20x60	A28	89
67167000	380E44	3/26,1/53,1/10Halter	H	13,0	100	730	730	75			D4	150
67302000	380E47	8/15	V		90	950	950	156	20x60	20x60	A65	120
67167000	380E47	3/26,1/53,1/10Halter	H	13,0	100	730	730	75			D4	150
67167000	380E48	3/26,1/53,1/10Halter	H	13,0	100	730	730	75			D4	150
66926000	400E31	1/25,2/26	V	8,0	90	950	950	153	20x60	20x60	A28	89
67302000	400E31	8/15	V		90	950	950	156	20x60	20x60	A65	120
67319000	400E31	8/17,1/Pl.,6/15	H	13,0	100	900	900	115	20x62	20x62	A60	
66926000	400E34	1/25,2/26	V	8,0	90	950	950	153	20x60	20x60	A28	89
66986000	400E34	3/25	V		90	950	950	175	20x62	20x62	A1	87
67302000	400E34	8/15	V		90	950	950	156	20x60	20x60	A65	120
67319000	400E34	8/17,1/Pl.,6/15	H	13,0	100	900	900	115	20x62	20x62	A60	
66926000	400E34HT	1/25,2/26	V	8,0	90	950	950	153	20x60	20x60	A28	89
66926000	400E37	1/25,2/26	V	8,0	90	950	950	153	20x60	20x60	A28	89
66986000	400E37	3/25	V		90	950	950	175	20x62	20x62	A1	87
67302000	400E37	8/15	V		90	950	950	156	20x60	20x60	A65	120
67319000	400E37	8/17,1/Pl.,6/15	H	13,0	100	900	900	115	20x62	20x62	A60	
66926000	400E42	1/25,2/26	V	8,0	90	950	950	153	20x60	20x60	A28	89
66986000	400E42	3/25	V		90	950	950	175	20x62	20x62	A1	87
67302000	400E42	8/15	V		90	950	950	156	20x60	20x60	A65	120
67319000	400E42	8/17,1/Pl.,6/15	H	13,0	100	900	900	115	20x62	20x62	A60	
66926000	410E37	1/25,2/26	V	8,0	90	950	950	153	20x60	20x60	A28	89
66932000	410E37	3/25	V		90	760	760	86	20x62	20x62	A20	87
66874000	410E37	9/13	V		90	760	760	83	20x62	20x62	A62	117
67167000	410E37	3/26,1/53,1/10Halter	H	13,0	100	730	730	75			D4	150
67419000	410E37	4/53,1/10Halter	H		100	760	760	54			D1.1	234
67185000	410E37	13/22,1/10Halter	H	16,0	100	730	730	73			D1.1	296
66926000	410E42	1/25,2/26	V	8,0	90	950	950	153	20x60	20x60	A28	89
66932000	410E42	3/25	V		90	760	760	86	20x62	20x62	A20	87
66874000	410E42	9/13	V		90	760	760	83	20x62	20x62	A62	117
67167000	410E42	3/26,1/53,1/10Halter	H	13,0	100	730	730	75			D4	150
67419000	410E42	4/53,1/10Halter	H		100	760	760	54			D1.1	234
67185000	410E42	13/22,1/10Halter	H	16,0	100	730	730	73			D1.1	296
67167000	410E44	3/26,1/53,1/10Halter	H	13,0	100	730	730	75			D4	150
67167000	410E48	3/26,1/53,1/10Halter	H	13,0	100	730	730	75			D4	150
66986000	440E34	3/25	V		90	950	950	175	20x62	20x62	A1	87
67177000	440E34	3/26,1/43,1/10Halter	H	10,5	100	730	730	87			D4	136
66926000	440E37	1/25,2/26	V	8,0	90	950	950	153	20x60	20x60	A28	89
66986000	440E37	3/25	V		90	950	950	175	20x62	20x62	A1	87
67302000	440E37	8/15	V		90	950	950	156	20x60	20x60	A65	120
67177000	440E37	3/26,1/43,1/10Halter	H	10,5	100	730	730	87			D4	136
66981000	440E37	8/22,1/10Halter	H	10,5	100	740	740	99			D20	186
66926000	440E37HT	1/25,2/26	V	8,0	90	950	950	153	20x60	20x60	A28	89
67177000	440E38	3/26,1/43,1/10Halter	H	10,5	100	730	730	87			D4	136
66926000	440E42	1/25,2/26	V	8,0	90	950	950	153	20x60	20x60	A28	89
66932000	440E42	3/25	V		90	760	760	86	20x62	20x62	A20	87
66986000	440E42	3/25	V		90	950	950	175	20x62	20x62	A1	87
67302000	440E42	8/15	V		90	950	950	156	20x60	20x60	A65	120
67167000	440E42	3/26,1/53,1/10Halter	H	13,0	100	730	730	75			D4	150
67177000	440E42	3/26,1/43,1/10Halter	H	10,5	100	730	730	87			D4	136
66981000	440E42	8/22,1/10Halter	H	10,5	100	740	740	99			D20	186
67185000	440E42	13/22,1/10Halter	H	16,0	100	730	730	73			D1.1	296
67177000	440E44	3/26,1/43,1/10Halter	H	10,5	100	730	730	87			D4	136
67302000	480E31	8/15	V		90	950	950	156	20	20	A65	120

EUROTRAKKER

IVECO

EUROTRAKKER

Artikel.Nr.	Fahrzeugtyp	Info	Achsl.	Blattzahl	Breite	Lx/L1	Ly/L2	Spr./ Kr.	Buchsen vorn	Buchsen hinten	Form	Paket- stärke
Art.-No.	Type		Axle Load	Leaves	Width			FreeArch /Crank	Bush front	Bush rear	Shape	Total height
67302000	480E34	8/15	V	8	90	950	950	156	20x60	20x60	A65	120
66387000	560E42	Doppelachslast,11/22,1/10Halter	H	13,0	100	740	740	71	R60	R60	D20	252
66926000	720E37	1/25,2/26	V	8,0	90	950	950	153	20x60	20x60	A28	89
67302000	720E37	8/15	V	8	90	950	950	156	20x60	20x60	A65	120
67167000	720E37	3/26,1/53,1/10Halter	H	13,0	100	730	730	75			D4	150
67419000	720E37	4/53,1/10Halter	H	4	100	760	760	54			D1.1	234
66387000	720E37	Doppelachslast,11/22,1/10Halter	H	13,0	100	740	740	71			D20	252
67185000	720E37	13/22,1/10Halter	H	16,0	100	730	730	73			D1.1	296
66926000	720E37HT	1/25,2/26	V	8,0	90	950	950	153	20x60	20x60	A28	89
66926000	720E42	1/25,2/26	V	8,0	90	950	950	153	20x60	20x60	A28	89
67302000	720E42	8/15	V	8	90	950	950	156	20x60	20x60	A65	120
67167000	720E42	3/26,1/53,1/10Halter	H	13,0	100	730	730	75			D4	150
67419000	720E42	4/53,1/10Halter	H	4	100	760	760	54			D1.1	234
66387000	720E42	Doppelachslast,11/22,1/10Halter	H	13,0	100	740	740	71			D20	252
67185000	720E42	13/22,1/10Halter	H	16,0	100	730	730	73			D1.1	296
67167000	720E44	3/26,1/53,1/10Halter	H	13,0	100	730	730	75			D4	150
67302000	720E47	8/15	V	8	90	950	950	156	20x60	20x60	A65	120
67167000	720E47	3/26,1/53,1/10Halter	H	13,0	100	730	730	75			D4	150