



DAF
SCANIA
VOLVO

TYPENLISTE
CATALOGUE

FEDERN
LEAF SPRINGS



2010
MADE IN EU

TES GROUP S.A.

UL. POZNAŃSKA 169

62-080 TARNOWO PODGÓRNE, POLAND

**TEL. +48 (61) 65 711 00, +48 (61) 65 711 01
+48 (61) 65 711 05, +48 (61) 65 711 10**

FAX +48 (61) 65 711 11

HANDLOWY@TES.PL, WWW.TES.PL

INHALTSVERZEICHNIS CONTENTS

IDENTIFICATION, IDENTIFIZIERUNG	3
DAF	5
FORMEN; SHAPES	6
400	10
MB 200	11
CF62-CF85	12
F45-F75	13
F85	14
F95	15
F500-F1100	16
F1200-F1900	17
F2000-F2200	18
F2300	19
F2500-F2817	20
F3300-F3600	22
TT2100	23
XF75-XF95	24
SCANIA	25
FORMEN; SHAPES	26
82	30
92	32
93	37
94	50
111	52
112	53
113	57
114	63
124	65
142	66
143	69
144	74

INHALTSVERZEICHNIS CONTENTS

VOLVO	77
FORMEN; SHAPES	78
F4	84
F6	85
F7	86
F10	88
F12	90
F16	92
FE	93
FH12	94
FL4	95
FL6	96
FL7	98
FL10	100
FLC	102
FM7	103
FM9	104
FM10	105
FM12	106
FS7	107
N7	108
N10	109
N12	110
NH12	111
NL10	112
NL12	113

IDENTIFICATION IDENTIFIZIERUNG

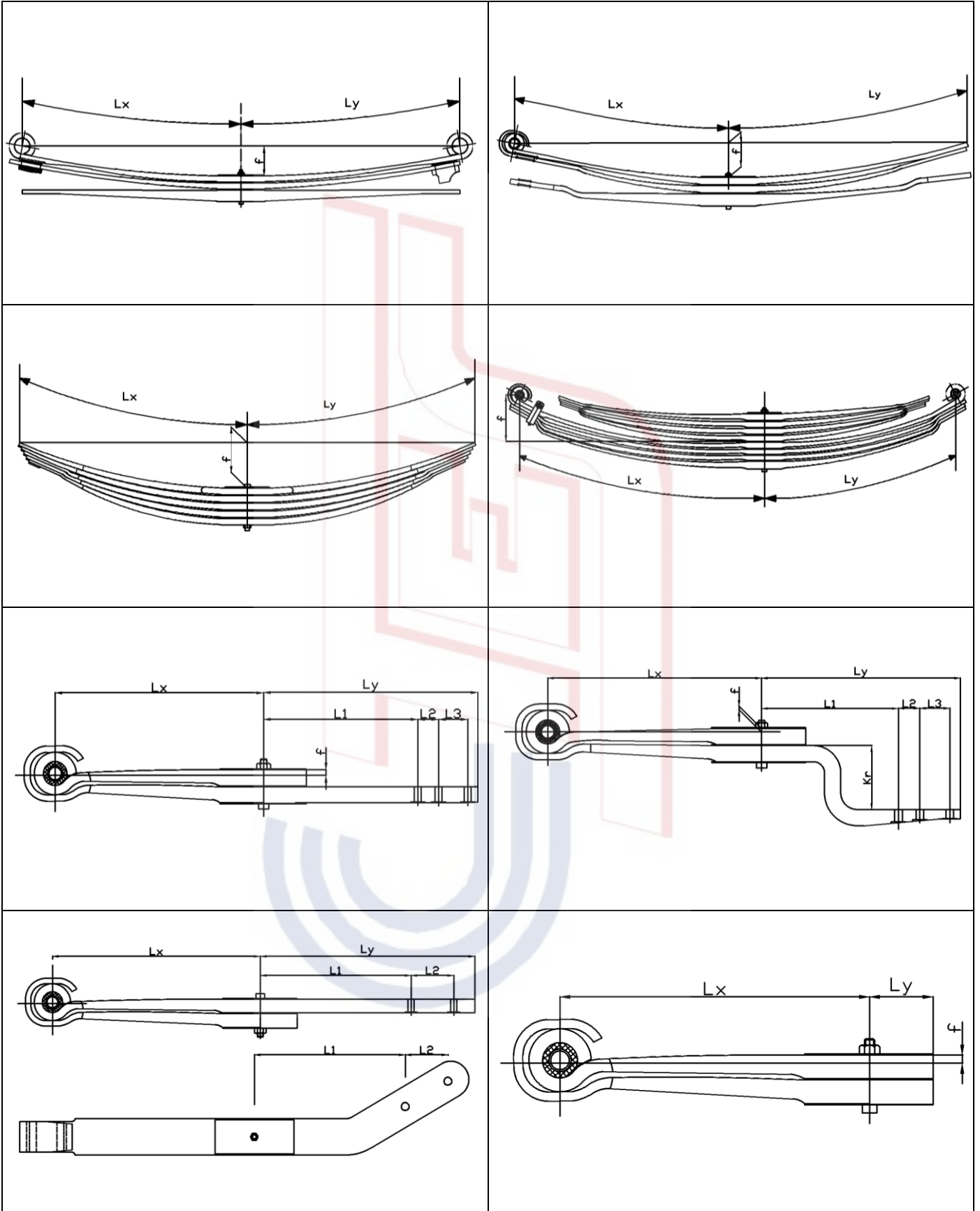

IDENTIFICATION IDENTIFIZIERUNG

Heading of catalogue	Kopfspalte der Typenliste	Заголовки в таблице типов рессор
Article no.	Artikel-Nr.	Артикул Ио.
suitable for vehicle type	passend für Fahrzeugtype	Предназначена для типа автомобиля
V = front spring	V = Vorderfeder	V = передняя рессора
H = rear spring	H = Hinterfeder	H = задняя рессора
T = part of the complete spring(main spring)	T = Teil aus kompletter Feder (Hauptfeder)	T = деталь из комплектной рессоры
Z = helper spring, detached	Z = Zusatzfeder, lose	Z = дополнительная рессора, отдельная
L = trailing arm for air suspension	L = Lenkerfeder	L= подруливающая рессора
Number of leaves	Blattzahl	Количество листов
Width largeur	Breite	Ширина
Length	Lange	Длина
front	vorn	передняя
rear	hinten	задняя
Free arch	Sprengung, unbelastet	Прогиб рессоры в ненагруженном состоянии
Inside diameter of bushes	Buchsen-innen	Внутренний диаметр втулки
front	vorne	передняя
rear	hinten	задняя
R = eye without bush	R = Rolle ohne Buchse	R= ролик без втулки
Shape	Form	Форма
Remarks, info	Bemerkungen, info	Примечания
Weight on the axle	Achslast	нагрузка на ось

DAF



DAF FORMEN; SHAPES

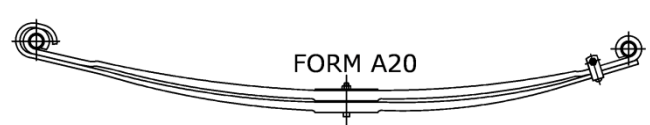
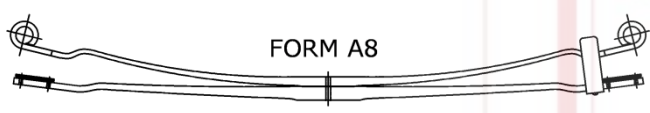
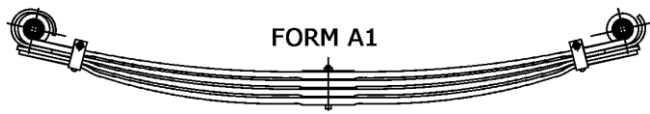

DAF FORMEN; SHAPES

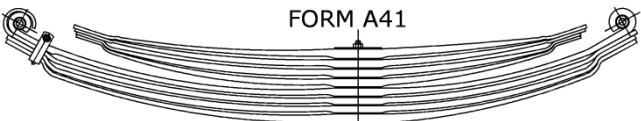
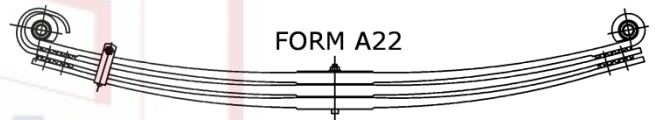
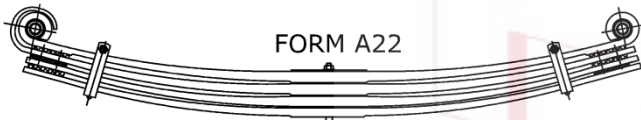
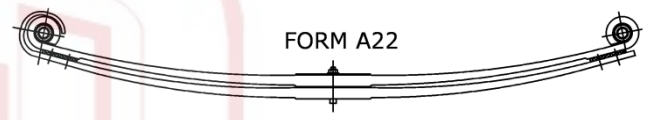
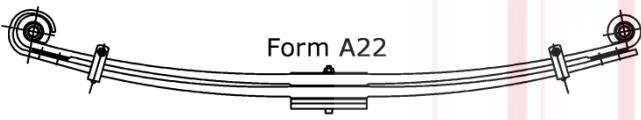
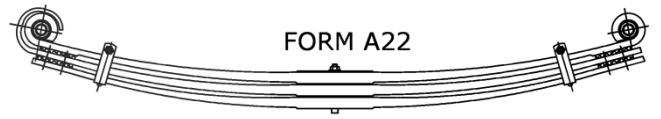
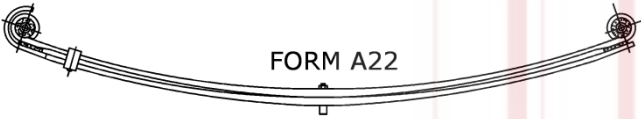
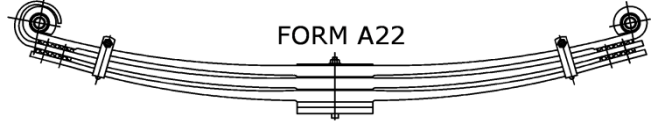

DAF FORMEN; SHAPES

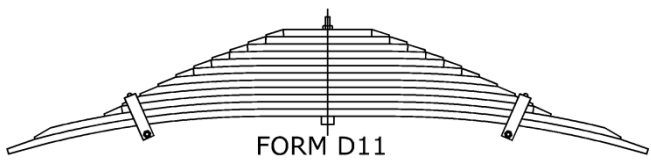
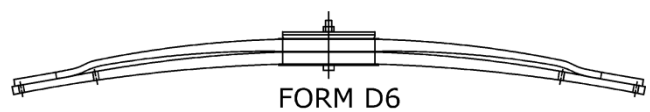
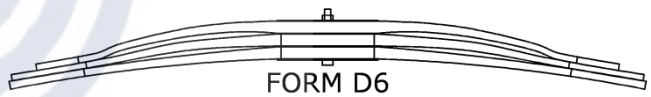
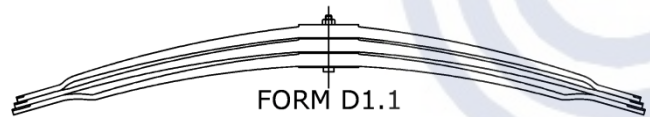
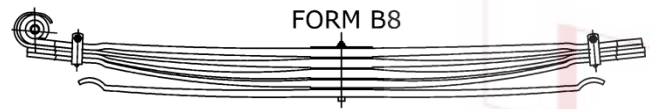
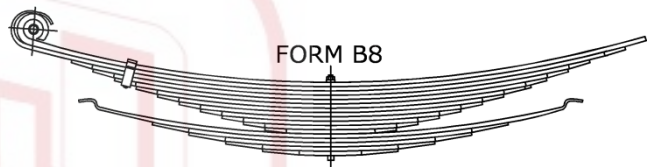
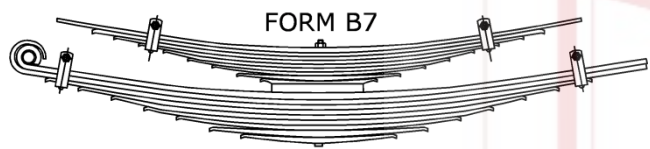
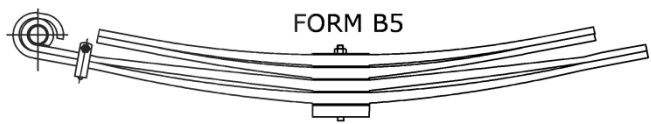
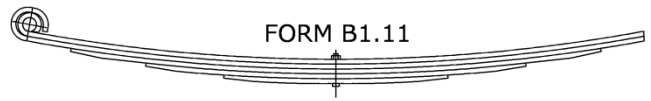
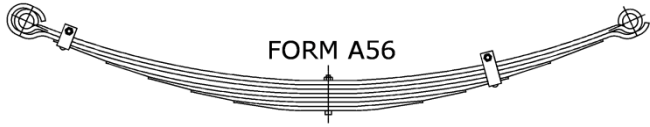

DAF FORMEN; SHAPES

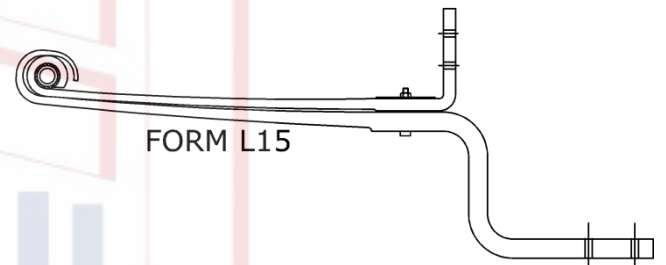
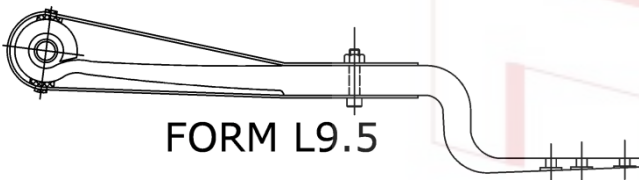
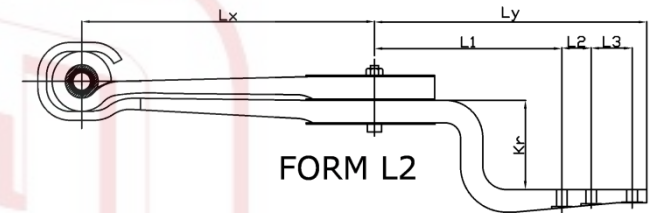
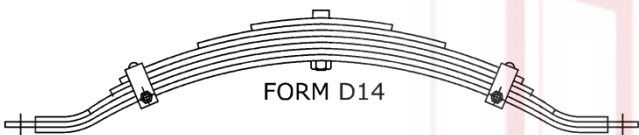
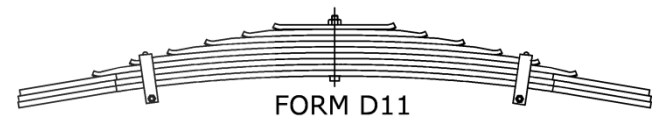
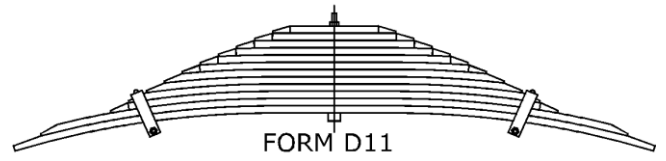
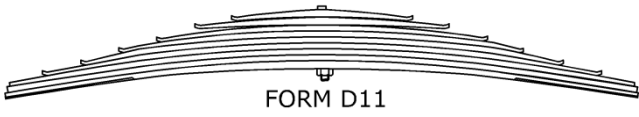

400	DAF	400
------------	------------	------------

Artikel.Nr.	Fahrzeugtyp	Info		Achsl.	Blattzahl	Breite	Lx/L1	Ly/L2	Spr.	Kr.	Buchsen vorn	Buchsen hinten	Form	Paket- stärke
Art.-No.	Type			Axle Load	Leaves	Width			Free Arch	Crank	Bush front	Bush rear	Shape	Total height
29180000	400	1/19,1/0,5Pl.	V	3,1	1	60	615	640	120		19xR40	19xR40	A1	19
29183000	400	1/23	H		1	75	661	688	177		19xR70	19xR40	A1	23
29181000	400	1/20	H		1	75	660	660	74		19xR70	19xR70	A28	20



MB200	DAF	MB200
--------------	------------	--------------

Artikel.Nr.	Fahrzeugtyp	Info		Achsl.	Blattzahl	Breite	Lx/L1	Ly/L2	Spr.	Kr.	Buchsen vorn	Buchsen hinten	Form	Paket- stärke
Art.-No.	Type			Axle Load	Leaves	Width			Free Arch	Crank	Bush front	Bush rear	Shape	Total height
29189000	MB200	12/12,2/10Pl.	H		12	100	820	820	130		R45	R45	A1	164
29185000	MB200	2/12,5/11,6/10	H		13	100	902	902	130		R55	R55	A1	139
29187000	MB200	13/11	H		13	100	828	828	80		R55	R55	A1	143
29384000	MB200	3/11,9/10	V		12	100	821	821	200		R55	R55	A1	123
29386000	MB200	3/11,10/10	V		13	100	817	817	186		R55	R55	A1	133
29388000	MB200	10/11	V		10	100	828	828	100		R55	R55	A1	110
29290000	MB200	3/20	V		3	100	820	820	170		R55	R55	A22	69
29297000	MB200	4/20	H		4	100	900	900	145		R55	R55	A22	96
29315000	MB200	4/21	H		4	100	900	900	135		R55	R55	A22	96
29347000	MB205	4/25	H		4	100	900	900	118		R55	R55	A1	116
29370000	MB205	3/18	V		3	100	818	818	203		R55	R55	A1	66
29332000	MB230	3/23,1/25Pl.	V		3	80	845	845	120		R45	R45	A1	103
29345000	MB230	4/23	H		4	100	900	900	124		22xR55	22xR55	A22	104
29397000	SB2100	10/16	H		10	100	900	900	146		35xR42	35xR42	A1	160
29350000	SB2100	9/15	V		9	80	845	845	98		25xR32	25xR32	A28	135
29317000	TB2105	10/16	H		10	100	900	900	75		35xR42	35xR42	A26	163
29322000	TB2105	8/15,Pl.	V		8	80	845	845	102		25xR32	25xR32	A56	135
29441000	BUS	1/48	L		1	100	795 415	615 140	51	105	30xR57		L9.5	54

CF65	DAF	CF85
-------------	------------	-------------

Artikel.Nr.	Fahrzeugtyp	Info		Achsl.	Blattzahl	Breite	Lx/L1	Ly/L2	Spr.	Kr.	Buchsen vorn	Buchsen hinten	Form	Paketstärke
Art.-No.	Type			Axle Load	Leaves	Width			Free Arch	Crank	Bush front	Bush rear	Shape	Total height
29356000	CF65	1/27,1/29	V	6,7	2	80	900	900	177				A22	60
29393000	CF65	2/32,1/20	H		3	100	900	1000	125		32		B5	88
29383000	CF75	1/21,3/23	H		4	100	660	600	608				A20	
29356000	CF75	1/27,1/29	V	6,7	2	80	900	900	177				A22	60
29340000	CF75	1/28,1/30	V	7,1	2	80	900	900	172		24xR60	24xR60	A22	58
29342000	CF75	1/28,1/31	V	7,5	2	80	900	900	160		24xR60	24xR60	A22	65
29392000	CF75	1/29,2/30	V		3	80	900	900			24xR60	24xR60	A22	
29381000	CF75	1/30,1/31,1/38	H	11,5	3	100	900	1000	112				B10	99
29346000	CF85	2/19	V		2	80	900	820	68		R49	R49	A28	
29389000	CF85	1/30,1/31,1/38	H	13,0	3	100	900	900	118				A8	99
29383000	CF85	1/21,3/23	H		4	100	660	600	608				A20	
29354000	CF85	1/31,1/32	V	7,1	2	80	900	900	106				A22	63
29356000	CF85	1/27,1/29	V	6,7	2	80	900	900	177				A22	60
29340000	CF85	1/28,1/30	V	7,1	2	80	900	900	172		24xR60	24xR60	A22	58
29342000	CF85	1/28,1/32	V	7,5	2	80	900	900	160		24xR60	24xR60	A22	65
29344000	CF85	1/28,1/33	V	7,5	2	80	900	900	136		24xR60	24xR60	A22	69
29366000	CF85	1/29,2/31	V	9,0	3	80	900		113		24xR60	24xR60	A22	100
29392000	CF85	1/29,2/30	V		3	80	900	900			24xR60	24xR60	A22	
29381000	CF85	1/30,1/31,1/38	H	11,5	3	100	900	1000	112				B10	99
29387000	CF85	1/33,1/35,1/43	H	13,0	3	100	900	1000	101				B10	111

F45	DAF	F75
------------	------------	------------

Artikel.Nr.	Fahrzeugtyp	Info		Achsl.	Blattzahl	Breite	Lx/L1	Ly/L2	Spr.	Kr.	Buchsen vorn	Buchsen hinten	Form	Paketstärke
Art.-No.	Type			Axle Load	Leaves	Width			Free Arch	Crank	Bush front	Bush rear	Shape	Total height
29170000	FA45	2/24	V	3,4	2	75	870	870	150		R45	R45	A1	48
29374000	FA45	1/30	V		1	75	870	870	120		16	16	A1	30
29175000	FA45	39870	H	5,0	2	75	870	870	125		16	16	A1	52
29171000	FA45	2/26,Pl/10,1/38	H	7,2	3	75	870	870	125		R45	R45	A44	100
29140000	LF45	1/30; f.Typ130E06, 150E08, 180E08	V		1	75	950	950	110				A28	30
29142000	LF45	1/30,f.Typ150E10	V		1	75	950	950	110				A28	30
29144000	LF45	1/30, f.Typ170E10,180E10	V		1	75	950	950	110				A28	30
29146000	LF45	1/30, f.Typ220E10	V		1	75	950	950	110		16	16	A28	30
29143000	LF45	1/34,1/40, f.Typ170E10,180E10	H		2	75	875	875	107		16	16	A8	74
29147000	LF45	1/ ,1/ ,f.Typ170E10,180E10	H		2	75	875	875			16	16	A8	75
29141000	LF45	1/34,f.Typ130E06, 150E08,180E08	H		1	75	875	875	100		16xR16		A20	34
29395000	F55	2/32,1/40			3	75	950	950					A5	
29304000	F65	3/28	V	7,5	3	80	900	900	118		26xR38	26xR38	A22	93
29358000	F65	3/28	V	5,6	3	80	900	900	87		26xR39	26xR39	A22	93
29304000	F75	3/28	V	7,5	3	80	900	900	118		26xR38	26xR38	A22	93
29358000	F75	3/28	V	5,6	3	80	900	900	87		26xR39	26xR39	A22	93
29373000	F75	1/22,3/23	H		4	100	660	600	47		32xR49	32xR49	A20	103
29379000	F75	1/22,3/23	H		4	100	662	596	47		32xR37	37xR49	A20	106
29415000	FA75	3/31,2/22	H	11,5	5	100	900	1000	105		32		B7	152
29324000	FAS75	3/27,1/23Pl.	V	6,5	3	80	865	865	118		26xR39	26xR39	A20	113
29330000	FAS75	4/25	V	7,5	4	80	865	865	125		26xR39	26xR39	A20	112
29380000	FAS75	4/26	V	8,0	4	80	865	865	125		26xR39	26xR39	A20	116
29305000	FAS75	6/26	H	10,0	6	90	780	780	34				D11	167
29324000	FAT75	3/27,1/23Pl.	V	6,5	3	80	865	865	118		26xR39	26xR39	A20	113
29330000	FAT75	4/25	V	7,5	4	80	865	865	125		26xR39	26xR39	A20	112
29364000	FAT75	2/31,1/23Pl.	V	6,4	2	80	900	900	118		26xR39	26xR39	A22	91
29372000	FAT75	2/32,1/23Pl.	V	6,5	2	80	900	900	121		26xR39	26xR39	A22	93
29385000	FAT75	6/29	H	13,0	6	90	780	780					D11	184

F85

DAF

F85

Artikel.Nr.	Fahrzeugtyp	Info		Achsl.	Blattzahl	Breite	Lx/L1	Ly/L2	Spr.	Kr.	Buchsen vorn	Buchsen hinten	Form	Paketstärke
Art.-No.	Type			Axle Load	Leaves	Width			Free Arch	Crank	Bush front	Bush rear	Shape	Total height
29348000	F85	3/27	V		3	80	865	865	130				A20	
29380000	F85	4/26	V	8,0	4	80	865	865	125		26xR39	26xR39	A20	116
29318000	F85	3/28	V		3	80	900	900	118		26xR31	26xR31	A22	
29336000	F85	3/30	V	7,1	3	80	900	900	107		26xR39	26xR39	A22	99
29358000	F85	3/28	V	5,6	3	80	900	900	87		26xR39	26xR39	A22	93
29364000	F85	2/36,1/23Pl.	V	6,4	2	80	900	900	118		26xR39	26xR39	A22	91
29372000	F85	2/36,1/23Pl.	V	6,5	2	80	900	900	121		26xR39	26xR39	A22	93
29304000	FA85	3/28	V	7,5	3	80	900	900	118		26xR38	26xR38	A22	93
29415000	FA85	3/31,2/22	H	11,5	5	100	900	1000	105		32		B7	152
29328000	FAD85	2/31,1/47Pl.	V		2	80	865	865	116		26xR38	26xR38	A20	115
29324000	FAD85	3/27,1/23Pl.	V	6,5	3	80	865	865	118		26xR39	26xR39	A20	113
29330000	FAD85	4/25	V	7,5	4	80	865	865	125		26xR39	26xR39	A20	112
29380000	FAD85	4/26	V	8,0	4	80	865	865	125		26xR39	26xR39	A20	116
29325000	FAD85	6/29	H	13,0	6	90	780	780					D11	184
29385000	FAD85	6/29	H	13,0	6	90	780	780					D11	184
29334000	FAS85	4/28	V	8,0	4	80	900	900	88		26xR39	26xR39	A22	124
29328000	FAT85	2/31,1/47Pl.	V		2	80	865	865	116		26xR38	26xR38	A20	115
29324000	FAT85	3/27,1/23Pl.	V	6,5	3	80	865	865	118		26xR39	26xR39	A20	113
29330000	FAT85	4/25	V	7,5	4	80	865	865	125		26xR39	26xR39	A20	112
29305000	FAT85	6/26	H	10,0	6	90	780	780	34				D11	167
29385000	FAT85	6/29	H	13,0	6	90	780	780					D11	184

F95	DAF	F95
------------	------------	------------

Artikel.Nr.	Fahrzeugtyp	Info		Achsl.	Blattzahl	Breite	Lx/L1	Ly/L2	Spr.	Kr.	Buchsen vorn	Buchsen hinten	Form	Paketstärke
Art.-No.	Type			Axle Load	Leaves	Width			Free Arch	Crank	Bush front	Bush rear	Shape	Total height
29380000	F95	4/26	V	8,0	4	80	865	865	125		26xR39	26xR39	A20	116
29300000	F95	3/25,P/18	V		3	80	845	845	123		25xR32	25xR32	A22	103
29312000	F95	3/24,Pl.	V		3	80	845	845	127		25xR32	25xR32	A22	95
29336000	F95	3/30	V	7,1	3	80	900	900	107		26xR39	26xR39	A22	99
29358000	F95	3/28	V	5,6	3	80	900	900	87		26xR39	26xR39	A22	93
29306000	F95	3/26	V		3	80	900	900	126		30xR46	30xR46	A22	87
29314000	F95	9/15,MEBU25x32	V		9	80	845	845	98		25xR32	25xR32	A26	135
29339000	F95	4/25	H		4	100	900	900	85		35xR42	35xR42	A1	127
29363000	F95	4/25	H		4	100	803	737	43		32xR48		A20	
29391000	F95	4/29	H		4	100	803	807	47		32xR49	R50	A20	128
29375000	F95	4/32	H		4	100	900	900	67		32xR49	32xR49	A20	140
29327000	F95	4/28	H		4	100	803	807	63		32xR49	34xR50	A20	124
29357000	F95	3/30	H	11,0	3	100	803	807	98		32xR49	34xR50	A20	99
29311000	F95	3/32	H		3	100	900	900	140		35xR42	35xR42	A20	105
29369000	F95	4/25	H	9,0	4	100	803	667	66		32xR37	37xR49	A20	112
29319000	F95	4/24,MEBU35x42	H		4	100	720	570	86		35xR42	35xR42	A22	108
29335000	F95	4/28	H		4	100	720	570	92		35xR42	35xR42	A22	108
29331000	F95	2/31,2/22	H		4	100	900	1000	90		22xR46		B7	128
29333000	F95	3/31,2/22	H		5	100	900	1000	80		32xR49		B7	152
29337000	F95	4/21,Pl./22,4/16,Pl./16	H		8	100	800	900	125		35xR42		B7	216
29377000	F95	2/35,2/22,1/26Pl.	H	12,5	4	100	900	1000	71				B5	140
29304000	FA95	3/28	V	7,5	3	80	900	900	118		26xR38	26xR38	A22	93
29415000	FA95	3/31,2/22	H	11,5	5	100	900	1000	105		32		B7	152
29330000	FAD95	4/25	V	7,5	4	80	865	865	125		26xR39	26xR39	A20	112
29304000	FAG95	3/28	V	7,5	3	80	900	900	118		26xR38	26xR38	A22	93
29334000	FAK95	4/28	V	8,0	4	80	900	900	88		26xR39	26xR39	A22	124
29304000	FAR95	3/28	V	7,5	3	80	900	900	118		26xR38	26xR38	A22	93
29304000	FAS95	3/28	V	7,5	3	80	900	900	118		26xR38	26xR38	A22	93
29334000	FAS95	4/28	V	8,0	4	80	900	900	88		26xR39	26xR39	A22	124
29330000	FAT95	4/25	V	7,5	4	80	865	865	125		26xR39	26xR39	A20	112
29305000	FAT95	6/26	H	10,0	6	90	780	780	34				D11	167
29309000	FAT95	6/26	H	10,0	6	90	780	780	34				D11	166
29313000	FAT95	6/29	H	13,0	6	90	780	780					D11	184
29325000	FAT95	6/29	H	13,0	6	90	780	780					D11	184
29385000	FAT95	6/29	H	13,0	6	90	780	780					D11	184
29308000	FT95	3/28	V	7,1	3	80	900	900	118		26	26	A22	93
29329000	FT95	3/32	H	11,5	3	100	900	900	84		32xR49	32xR49	A22	105
29304000	FTG95	3/28	V	7,5	3	80	900	900	118		26xR38	26xR38	A22	93
29304000	FTT95	3/28	V	7,5	3	80	900	900	118		26xR38	26xR38	A22	93
29367000	FTT95	4/30	H	9,0	4	90	800	800	32				D6	132

F500	DAF	F1100
-------------	------------	--------------

Artikel.Nr.	Fahrzeugtyp	Info		Achsl.	Blattzahl	Breite	Lx/L1	Ly/L2	Spr.	Kr.	Buchsen vorn	Buchsen hinten	Form	Paket- stärke
Art.-No.	Type			Axle Load	Leaves	Width			Free Arch	Crank	Bush front	Bush rear	Shape	Total height
29152000	FA500/ FA700	3/10+3/11	V		6	70	785	950	215		22		B1.11	63
29117000	FA500/ FA700	2/11+2/12+2/14	H		6	70	700	860	190		25		B1.11	74
29374000	FA600/ FA800	1/30	V		1	75	870	870	120		16	16	A1	30
29175000	FA600/ FA800	2/26	H	5,0	2	75	870	870	125		16	16	A1	52
29170000	FA800/ FA1000	2/24	V	3,4	2	75	870	870	150		R45	R45	A1	48
29171000	FA800/ FA1000	2/26,PL./10,1/38	H	7,2	3	75	870	870	125		R45	R45	A44	100
29150000	FA900/ FA1100	6/10+2/11	V		8	70	785	940	215		22		B1.11	82
29115000	FA900/ FA1100	6/10+4/14	H		10	70	700	880	185		25		B8	116

F1200	DAF	F1900
--------------	------------	--------------

Artikel.Nr.	Fahrzeugtyp	Info	Achsl.	Blattzahl	Breite	Lx/L1	Ly/L2	Spr.	Kr.	Buchsen vorn	Buchsen hinten	Form	Paketstärke
Art.-No.	Type		Axle Load	Leaves	Width			Free Arch	Crank	Bush front	Bush rear	Shape	Total height
29104000	FA1200	5/13	V	5	80	750	850	120		25	25	A1	65
29118000	FA1200	4/15	V	4	80	750	850	120		25	25	A1	60
29207000	FA1200	8/15	H	8	80	750	750	110		25	25	A1	120
29106000	FA1300	6/10,2/11,Pl./16	V	8	80	785	950	225		25		B1.11	98
29116000	FA1300	7/10+2/11+Pl./16	V	9	80	785	950	225		25		B1.11	108
29121000	FA1300	7/11,1/13,3/16, (7/4)	H	11	80	800	990	225		30		B1.11	138
29104000	FA1400	5/13	V	5	80	750	850	120		25	25	A1	65
29207000	FA1400	8/15	H	8	80	750	750	110		25	25	A1	120
29108000	FA1500	3/10+7/11+Pl./12	V	10	80	785	950	200		25		B1.11	110
29123000	FA1500	8/11+5/16	H	13	80	800	990	185		30		B1.11	168
29119000	FG1500	9/13,4/13,Pl.	H	13	100	575	669	14		35xR42		B1.11	169
29123000	FT1500	8/11+5/16	H	13	80	800	990	185		30		B1.11	168
29210000	FA1600	8/11	V	8	80	700	780	105		25xR32		B1.11	88
29211000	FA1600	9/12,7/10,1/10Pl.	H	15	80	700	790	97		25		B7	188
29210000	FAS1600	8/11	V	8	80	700	780	105		25xR32		B1.11	88
29219000	FAS1600	10/12	H	10	80	755	557	87		R42	R70	A1	120
29212000	FG1600	7/13	V	7	80	700	780	105		25xR32		B1.11	91
29205000	FG1600	10/14	H	10	80	565	660	40		25		B1.11	140
29349000	FGG1600	4/24	H	4	80	720	570	63		25xR32	25xR32	A1	108
29214000	FT1600	7/12	V	7	80	800	800	117		25	25	A1	84
29211000	FT1600	9/12,7/10,1/10Pl.	H	15	80	700	790	97		25		B7	188
29320000	FA1700	2/23,2Pl./13	V	2	70	835	995	160		20		B4	78
29306000	FA1700	3/26	V	3	80	900	900	126		30xR46	30xR46	A22	87
29338000	FA1700	2/27,2Pl./13	V	2	80	900	900	151		30xR46	30xR46	A22	86
29331000	FA1700	2/31,2/22	H	4	100	900	1000	90		22xR46		B7	128
29210000	FA1800	8/11	V	8	80	700	780	105		25xR32		B1.11	88
29231000	FA1800	10/13,8/10	H	18	100	750	840	130		35xR42		B7	210
29212000	FAV1800	7/13	V	7	80	700	780	105		25xR32		B1.11	91
29316000	FA1900	3/25	V	3	80	900	900	137		30	30	A22	84
29331000	FA1900	2/31,2/22	H	4	100	900	1000	90		22xR46		B7	128

F2000	DAF	F2200
--------------	------------	--------------

Artikel.Nr.	Fahrzeugtyp	Info		Achsl.	Blattzahl	Breite	Lx/L1	Ly/L2	Spr.	Kr.	Buchsen vorn	Buchsen hinten	Form	Paketstärke
Art.-No.	Type			Axle Load	Leaves	Width			Free Arch	Crank	Bush front	Bush rear	Shape	Total height
29090000	FA2000	9/13	V		9	80	753	753	100		25xR32	25xR32	A1	117
29156000	FA2000	9/13	V		9	80	750	750	110		25xR32	25xR32	A1	117
29232000	FA2000	9/13	V		9	80	750	750	85		25xR32	25xR32	A1	117
29077000	FA2000	9/13,Pl./13,5/11	H		14	100	750	840	122		35xR42		B7	185
29252000	FAD2000	8/14,Pl./10	V		8	80	750	750	105		25	25	A1	122
29236000	FAD2000	8/14,Pl./10	V		8	80	750	750	105		25xR32	25xR32	A1	122
29234000	FAS2000	3/13+3/14+3/13	V		9	80	750	750	110		25xR32	25xR32	A1	130
29413000	FAS2000	12/13	H		12	100	762	762	105		35	R70	A1	156
29323000	FAS2000	8/14	H		8	100	780	610	110		35xR42	34xR49	A1	112
29247000	FAS2000		H		12	100	770	765	115		60	35	A1	156
29257000	FAS2000	12/13	H		12	100	770	765	113		R70	35xR42	A1	156
29089000	FAS2000	8/14	H		8	100	780	610			35xR42	50xR70	A1	112
29229000	FAS2000	12/13	H		12	100	762	762	120		35	60	A1	156
29252000	FAT2000	8/14,Pl./10	V		8	80	750	750	105		25	25	A1	122
29236000	FAT2000	8/14,Pl./10	V		8	80	750	750	105		25xR32	25xR32	A1	122
29237000	FAT2000	11/18,Betonmischer	H		11	100	778	778	195				D14	198
29239000	FAT2000	10/18,Betonmischer	H		10	100	778	778	195				D14	180
29119000	FGG2000	9/13,4/13,Pl.	H		13	100	575	669	14		35xR42		B1.11	169
29230000	FT2000	9/13	V		9	80	825	825	128		25	25	A1	117
29216000	FT2000	6/15,1/13Pl.	V		6	80	825	855	125		25xR32	25xR32	A26	103
29099000	FT2000	7/13,2Pl./13,4/10,2Pl./13	H		11	100	750	950	165		35		B7	183
29257000	F2100	12/13	H		12	100	770	765	113		R70	35xR42	A1	156
29119000	F2100	9/13,4/13,Pl.	H		13	100	575	669	14		35xR42		B1.11	169
29156000	FA2100	9/13	V		9	80	750	750	110		25xR32	25xR32	A1	117
29162000	FA2100	9/13	V		9	80	750	750	115		25xR32	25xR32	A1	117
29271000	FA2100	5/15,Pl./15,4/13	H		9	100	800	905	147		35xR42		B5	142
29281000	FA2100	6/15,Pl./15,4/13	H		10	100	800	905	163		35xR42		B5	157
29321000	FA2100	6/15,Pl./15,5/13	H		11	100	800	905	163		35xR42		B5	170
29307000	FAG2100	4/15	H		4	80	620	930	160		25xR32		B1.11	60
29156000	FAS2100	9/13	V		9	80	750	750	110		25xR32	25xR32	A1	117
29162000	FAS2100	9/13	V		9	80	750	750	115		25xR32	25xR32	A1	117
29359000	FAS2100	9/13	H		9	100	780	550	96		35	R70	A1	117
29323000	FAS2100	8/14	H		8	100	780	610	110		35xR42	34xR49	A1	112
29089000	FAS2100	8/14	H		8	100	780	610			35xR42	50xR70	A1	112
29252000	FAT2100	8/14,1/10Pl.	V		8	80	750	750	105		25	25	A1	122
29305000	FAT2100	6/26	H	10,0	6	90	780	780	34				D11	167
29325000	FAT2100	6/29	H	13,0	6	90	780	780					D11	184
29158000	FGG2100	2/16,4/15,1/15Pl.	V		6	80	845	845	140		25xR32	25xR32	A26	107
29307000	FGG2100	4/15	H		4	80	620	930	160		25xR32		B1.11	60
29353000	FGG2100	1/33,1/54	L	10,0	2	100	910	600	64		35xR42		L15.1	96
29292000	FT2100	3/23+P/24	V		3	80	845	845	118		25xR32	25xR32	A1	103
29264000	FT2100	3/23+P/24	V		3	80	845	845	118		25xR32	25xR32	A22	103
29300000	FT2100	3/25+P/18	V		3	80	845	845	123		25xR32	25xR32	A22	103
29158000	FT2100	2/16,4/15,1/15Pl.	V		6	80	845	845	140		25xR32	25xR32	A26	107
29216000	FT2100	6/15,1/13Pl.	V		6	80	825	855	125		25xR32	25xR32	A26	103
29277000	FT2100	3/25,3/20	H	13,0	6	100	900	900	162		35	35	A3	156
29279000	FT2100	3/20,3/20	H	11,0	6	100	900	900	190		35xR42	35xR42	A3	141
29291000	FT2100	3/20,3/20	H		6	100	900	900	190		35xR42	35xR42	A3	141
29301000	FT2100	3/25,3/20	H	13,0	6	100	900	900	165		35xR42	35xR42	A3	156
29234000	FA2200	3/13+3/14+3/13	V		9	80	750	750	110		25xR32	25xR32	A1	130
29077000	FA2200	9/13,Pl./13,5/11	H		14	100	750	840	122		35xR42		B7	185
29234000	FAS2200	3/13+3/14+3/13	V		9	80	750	750	110		25xR32	25xR32	A1	130
29236000	FAT2200	8/14+Pl./10	V		8	80	750	750	105		25xR32	25xR32	A1	122
29237000	FAT2200	11/18	H		11	100	778	778	195				D14	198
29216000	FT2200	6/15,1/13Pl.	V		6	80	825	855	125		25xR32	25xR32	A26	103

F2300	DAF	F2300
--------------	------------	--------------

Artikel.Nr. Art.-No.	Fahrzeugtyp Type	Info		Achsl. Axle Load	Blattzahl Leaves	Breite Width	Lx/L1	Ly/L2	Spr. Free Arch	Kr. Crank	Buchsen vorn Bush front	Buchsen hinten Bush rear	Form Shape	Paket stärke Total height
29119000	F2300	9/13,4/13,Pl.	H		13	100	575	669	14		35xR42		B1.11	169
29237000	F2300	11/18,Betonmischer	H		11	100	778	778	195				D14	198
29239000	F2300	10/18,Betonmischer	H		10	100	778	778	195				D14	180
29156000	FA2300	9/13	V		9	80	750	750	110		25xR32	25xR32	A1	117
29162000	FA2300	9/13	V		9	80	750	750	115		25xR32	25xR32	A1	117
29271000	FA2300	5/15,Pl./15,4/13	H		9	100	800	905	147		35xR42		B5	142
29281000	FA2300	6/15,Pl./15,4/13	H		10	100	800	905	163		35xR42		B5	157
29321000	FA2300	6/15,Pl./15,5/13	H		11	100	800	905	163		35xR42		B5	170
29173000	FAG2300	2/40	H		2	100	900	900	140		35	35	A1	86
29311000	FAG2300	3/32	H		3	100	900	900	140		35xR42	35xR42	A20	105
29156000	FAS2300	9/13	V		9	80	750	750	110		25xR32	25xR32	A1	117
29162000	FAS2300	9/13	V		9	80	750	750	115		25xR32	25xR32	A1	117
29323000	FAS2300	8/14	H		8	100	780	610	110		35xR42	34xR49	A1	112
29257000	FAS2300	12/13	H		12	100	770	765	113		R70	35xR42	A1	156
29252000	FAT2300	8/14,Pl./10	V		8	80	750	750	105		25	25	A1	122
29236000	FAT2300	8/14,Pl./10	V		8	80	750	750	105		25xR32	25xR32	A1	122
29305000	FAT2300	6/26	H	10,0	6	90	780	780	34				D11	167
29309000	FAT2300	6/26	H	10,0	6	90	780	780	34				D11	166
29313000	FAT2300	6/29	H	13,0	6	90	780	780					D11	184
29325000	FAT2300	6/29	H	13,0	6	90	780	780					D11	184
29385000	FAT2300	6/29	H	13,0	6	90	780	780					D11	184
29319000	FGG2300		H		4	100	720	570	86		35xR42	35xR42	A22	108
29335000	FGG2300	4/24	H		4	100	720	570	92		35xR42	35xR42	A22	108
29292000	FT2300	3/23+P/24	V		3	80	845	845	118		25xR32	25xR32	A1	103
29264000	FT2300	3/23+P/24	V		3	80	845	845	118		25xR32	25xR32	A22	103
29300000	FT2300	3/25+P/18	V		3	80	845	845	123		25xR32	25xR32	A22	103
29158000	FT2300	2/16,4/15,1/15Pl.	V		6	80	845	845	140		25xR32	25xR32	A26	107
29216000	FT2300	6/15,1/13Pl.	V		6	80	825	855	125		25xR32	25xR32	A26	103
29351000	FT2300	1/29,1/43	L		2	100	803	610	115		35		L2	78
29355000	FT2300	1/33,1/54	L		2	100	910	615	75	282	35xR42		L2	96
29360000	FT2300	1/33,1/54	L		2	100	910	615	75	282	35xR42		L2	96
29277000	FT2300	3/25,3/20	H	13,0	6	100	900	900	162		35	35	A3	156
29279000	FT2300	3/20,3/20	H	11,0	6	100	900	900	190		35xR42	35xR42	A3	141
29291000	FT2300	3/20,3/20	H		6	100	900	900	190		35xR42	35xR42	A3	141
29301000	FT2300	3/25,3/20	H	13,0	6	100	900	900	165		35xR42	35xR42	A3	156

F2500	DAF	F2817
--------------	------------	--------------

Artikel.Nr.	Fahrzeugtyp	Info		Achsl.	Blattzahl	Breite	Lx/L1	Ly/L2	Spr.	Kr.	Buchsen vorn	Buchsen hinten	Form	Paketstärke
Art.-No.	Type			Axle Load	Leaves	Width			Free Arch	Crank	Bush front	Bush rear	Shape	Total height
29156000	FA2500	9/13	V		9	80	750	750	110		25xR32	25xR32	A1	117
29162000	FA2500	9/13	V		9	80	750	750	115		25xR32	25xR32	A1	117
29271000	FA2500	5/15,Pl./15,4/13	H		9	100	800	905	147		35xR42		B5	142
29281000	FA2500	6/15,Pl./15,4/13	H		10	100	800	905	163		35xR42		B5	157
29321000	FA2500	6/15,Pl./15,5/13	H		11	100	800	905	163		35xR42		B5	170
29173000	FAG2500	2/40	H		2	100	900	900	140		35	35	A1	86
29311000	FAG2500	3/32	H		3	100	900	900	140		35xR42	35xR42	A20	105
29323000	FAS2500	8/14	H		8	100	780	610	110		35xR42	34xR49	A1	112
29257000	FAS2500	12/13	H		12	100	770	765	113		R70	35xR42	A1	156
29252000	FAT2500	8/14,1/10Pl.	V		8	80	750	750	105		25	25	A1	122
29305000	FAT2500	6/26	H	10,0	6	90	780	780	34				D11	167
29309000	FAT2500	6/26	H	10,0	6	90	780	780	34				D11	166
29313000	FAT2500	6/29	H	13,0	6	90	780	780					D11	184
29325000	FAT2500	6/29	H	13,0	6	90	780	780					D11	184
29385000	FAT2500	6/29	H	13,0	6	90	780	780					D11	184
29319000	FGG2500	4/24	H		4	100	720	570	86		35xR42	35xR42	A22	108
29335000	FGG2500	4/24	H		4	100	720	570	92		35xR42	35xR42	A22	108
29292000	FT2500	3/23+P/24	V		3	80	845	845	118		25xR32	25xR32	A1	103
29264000	FT2500	3/23+P/24	V		3	80	845	845	118		25xR32	25xR32	A22	103
29300000	FT2500	3/25+P/18	V		3	80	845	845	123		25xR32	25xR32	A22	103
29158000	FT2500	2/26,4/15,Pl.	V		6	80	845	845	140		25xR32	25xR32	A26	107
29277000	FT2500	3/25,3/20	H	13,0	6	100	900	900	162		35	35	A3	156
29279000	FT2500	3/20,3/20	H	11,0	6	100	900	900	190		35xR42	35xR42	A3	141
29291000	FT2500	3/20,3/20	H		6	100	900	900	190		35xR42	35xR42	A3	141
29301000	FT2500	3/25,3/20	H	13,0	6	100	900	900	165		35xR42	35xR42	A3	156
29244000	FA2600	6/15,1/10Pl.	V		6	100	812	812	120		35xR42	35xR42	A26	100
29248000	FA2600	6/15,1/10Pl.	V		6	100	812	812	110		35xR42	35xR42	A26	105
29302000	FA2600	7/15	V		7	100	812	812	125		35xR42	35xR42	A26	105
29241000	FA2600		H		9/4/1	100	806	900	135		35		B7	198
29244000	FAD2600	6/15,1/10Pl.	V		6	100	812	812	120		35xR42	35xR42	A26	100
29248000	FAD2600	6/15,1/10Pl.	V		6	100	812	812	110		35xR42	35xR42	A26	105
29242000	FT2600	6/15,2Pl./10	V		6	100	900	900	141		35	35	A26	110
29241000	FT2600		H		9/4/1	100	806	900	135		35		B7	198
29304000	FT2700	3/28	V	7,5	3	80	900	900	118		26xR38	26xR38	A22	93
29358000	FT2700	3/28	V	5,6	3	80	900	900	87		26xR39	26xR39	A22	93
29298000	FA2800	3/24+2P/11	V		3	100	812	812	107		35xR42	35xR42	A22	103
29244000	FA2800	6/15,1/10Pl.	V		6	100	812	812	120		35xR42	35xR42	A26	100
29248000	FA2800	6/15,1/10Pl.	V		6	100	812	812	110		35xR42	35xR42	A26	105
29302000	FA2800	7/15	V		7	100	812	812	125		35xR42	35xR42	A26	105
29271000	FA2800	5/15,Pl./15,4/13	H		9	100	800	905	147		35xR42		B5	142
29281000	FA2800	6/15,Pl./15,4/13	H		10	100	800	905	163		35xR42		B5	157
29321000	FA2800	6/15,Pl./15,5/13	H		11	100	800	905	163		35xR42		B5	170
29367000	FAT2800	4/30	H	9,0	4	90	800	800	32				D6	132
29305000	FAT2800	6/26	H	10,0	6	90	780	780	34				D11	167
29309000	FAT2800	6/26	H	10,0	6	90	780	780	34				D11	166
29313000	FAT2800	6/29	H	13,0	6	90	780	780					D11	184
29325000	FAT2800	6/29	H	13,0	6	90	780	780					D11	184
29165000	FAT2800	12/20	H		12	90	886	886	60		R25	R25	D11	240
29244000	FAT2800	6/15,1/10Pl.	V		6	100	812	812	120		35xR42	35xR42	A26	100
29248000	FAT2800	6/15,1/10Pl.	V		6	100	812	812	110		35xR42	35xR42	A26	105
29302000	FAT2800	7/15	V		7	100	812	812	125		35xR42	35xR42	A26	105
29157000	FAT2800	3/18,8/20	H		11	100	764	764	170				D14	214
29237000	FAT2800	11/18	H		11	100	778	778	195				D14	198
29239000	FAT2800	10/18	H		10	100	778	778	195				D14	180
29260000	FT2800	3/21+P/28	V		3	100	900	900	145		35xR42	35xR42	A20	100
29294000	FT2800	3/21+P/28	V		3	100	900	900	156		35xR42	35xR42	A22	100
29296000	FT2800	3/23+P/22	V		3	100	900	900	130		35xR42	35xR42	A22	100

F2500	DAF	F2817
--------------	------------	--------------

Artikel.Nr.	Fahrzeugtyp	Info		Achsl.	Blattzahl	Breite	Lx/L1	Ly/L2	Spr.	Kr.	Buchsen vorn	Buchsen hinten	Form	Paket- stärke
Art.-No.	Type			Axle Load	Leaves	Width			Free Arch	Crank	Bush front	Bush rear	Shape	Total height
29289000	FT2800	4/20,4/20	H		8	100	900	900			35xR42	35xR42	A41	187
29277000	FT2800	3/25,3/20	H	13,0	6	100	900	900	162		35	35	A3	156
29279000	FT2800	3/20,3/20	H	11,0	6	100	900	900	190		35xR42	35xR42	A3	141
29291000	FT2800	3/20,3/20	H		6	100	900	900	190		35xR42	35xR42	A3	141
29301000	FT2800	3/25,3/20	H	13,0	6	100	900	900	165		35xR42	35xR42	A3	156
29303000	FT2800	4/20,4/20	H	13,0	8	100	900	900	189		35xR42	35xR42	A3	187
29165000	FTT2800	12/20	H		12	90	886	886	60		R25	R25	D11	240
29260000	FTT2800	3/21+P/28	V		3	100	900	900	145		35xR42	35xR42	A20	100
29294000	FTT2800	3/21+P/28	V		3	100	900	900	156		35xR42	35xR42	A22	100
29337000	FA2805	4/21,Pl./22,4/16,Pl./16	H		8	100	800	900	125		35xR42		B7	216
29163000	FAT2817	10/24	H		10	90	946	946	103		R25	R25	D1.1	240



F3300	DAF	F3600
--------------	------------	--------------

Artikel.Nr.	Fahrzeugtyp	Info		Achsl.	Blattzahl	Breite	Lx/L1	Ly/L2	Spr.	Kr.	Buchsen vorn	Buchsen hinten	Form	Paketstärke
Art.-No.	Type			Axle Load	Leaves	Width			Free Arch	Crank	Bush front	Bush rear	Shape	Total height
29341000	F3300	4/22	H		4	100	780	610	130		R42	R50	A1	
29298000	FA3300	3/24+2P/11	V		3	100	812	812	107		35xR42	35xR42	A22	103
29244000	FA3300	6/15,1/10Pl.	V		6	100	812	812	120		35xR42	35xR42	A26	100
29248000	FA3300	6/15,1/10Pl.	V		6	100	812	812	110		35xR42	35xR42	A26	105
29302000	FA3300	7/15	V		7	100	812	812	125		35xR42	35xR42	A26	105
29337000	FA3300	4/21,Pl./22,4/16,Pl./16	H		8	100	800	900	125		35xR42		B7	216
29271000	FA3300	5/15,Pl./15,4/13	H		9	100	800	905	147		35xR42		B5	142
29281000	FA3300	6/15,Pl./15,4/13	H		10	100	800	905	163		35xR42		B5	157
29321000	FA3300	6/15,Pl./15,5/13	H		11	100	800	905	163		35xR42		B5	170
29244000	FAS3300	6/15,1/10Pl.	V		6	100	812	812	120		35xR42	35xR42	A26	100
29248000	FAS3300	6/15,1/10Pl.	V		6	100	812	812	110		35xR42	35xR42	A26	105
29302000	FAS3300	7/15	V		7	100	812	812	125		35xR42	35xR42	A26	105
29323000	FAS3300	8/14	H		8	100	780	610	110		35xR42	34xR49	A1	112
29367000	FAT3300	4/30	H	9,0	4	90	800	800	32				D6	132
29305000	FAT3300	6/26	H	10,0	6	90	780	780	34				D11	167
29309000	FAT3300	6/26	H	10,0	6	90	780	780	34				D11	166
29313000	FAT3300	6/29	H	13,0	6	90	780	780					D11	184
29325000	FAT3300	6/29	H	13,0	6	90	780	780					D11	184
29302000	FAT3300	7/15	V		7	100	812	812	125		35xR42	35xR42	A26	105
29296000	FT3300	3/23+P/22	V		3	100	900	900	130		35xR42	35xR42	A22	100
29279000	FT3300	3/20,3/20	H	11,0	6	100	900	900	190		35xR42	35xR42	A3	141
29301000	FT3300	3/25,3/20	H	13,0	8	100	900	900	165		35xR42	35xR42	A3	156
29303000	FT3300	4/20,4/20	H	13,0	8	100	900	900	189		35xR42	35xR42	A3	187
29341000	F3600	4/22	H		4	100	780	610	130		R42	R50	A1	
29298000	FA3600	3/24+2P/11	V		3	100	812	812	107		35xR42	35xR42	A22	103
29244000	FA3600	6/15,1/10Pl.	V		6	100	812	812	120		35xR42	35xR42	A26	100
29248000	FA3600	6/15,1/10Pl.	V		6	100	812	812	110		35xR42	35xR42	A26	105
29302000	FA3600	7/15	V		7	100	812	812	125		35xR42	35xR42	A26	105
29337000	FA3600	4/21,Pl./22,4/16,Pl./16	H		8	100	800	900	125		35xR42		B7	216
29321000	FA3600	6/15,Pl./15,5/13	H		11	100	800	905	163		35xR42		B5	170
29244000	FAS3600	6/15,1/10Pl.	V		6	100	812	812	120		35xR42	35xR42	A26	100
29248000	FAS3600	6/15,1/10Pl.	V		6	100	812	812	110		35xR42	35xR42	A26	105
29302000	FAS3600	7/15	V		7	100	812	812	125		35xR42	35xR42	A26	105
29323000	FAS3600	8/14	H		8	100	780	610	110		35xR42	34xR49	A1	112
29305000	FAT3600	6/26	H	10,0	6	90	780	780	34				D11	167
29309000	FAT3600	6/26	H	10,0	6	90	780	780	34				D11	166
29313000	FAT3600	6/29	H	13,0	6	90	780	780					D11	184
29325000	FAT3600	6/29	H	13,0	6	90	780	780					D11	184
29244000	FAT3600	6/15,1/10Pl.	V		6	100	812	812	120		35xR42	35xR42	A26	100
29248000	FAT3600	6/15,1/10Pl.	V		6	100	812	812	110		35xR42	35xR42	A26	105
29296000	FT3600	3/23+P/22	V		3	100	900	900	130		35xR42	35xR42	A22	100
29360000	FT3600	1/33,1/54	L		2	100	910	615	75	282	35xR42		L2	96
29279000	FT3600	3/20,3/20	H	11,0	6	100	900	900	190		35xR42	35xR42	A3	141
29301000	FT3600	3/25,3/20	H	13,0	6	100	900	900	165		35xR42	35xR42	A3	156
29303000	FT3600	4/20,4/20	H	13,0	8	100	900	900	189		35xR42	35xR42	A3	187

TT2100	DAF	TT2100
---------------	------------	---------------

Artikel.Nr.	Fahrzeugtyp	Info		Achsl.	Blattzahl	Breite	Lx/L1	Ly/L2	Spr.	Kr.	Buchsen vorn	Buchsen hinten	Form	Paket- stärke
Art.-No.	Type			Axle Load	Leaves	Width			Free Arch	Crank	Bush front	Bush rear	Shape	Total height
29326000	TT2100		V		4/1	80	845	845	151		26	26	A1	104



XF75	DAF	XF95
-------------	------------	-------------

Artikel.Nr.	Fahrzeugtyp	Info		Achsl.	Blattzahl	Breite	Lx/L1	Ly/L2	Spr.	Kr.	Buchsen vorn	Buchsen hinten	Form	Paket- stärke
Art.-No.	Type			Axle Load	Leaves	Width			Free Arch	Crank	Bush front	Bush rear	Shape	Total height
29342000	XF75	1/28,1/31	V	7,5	2	80	900	900	160		24xR60	24xR60	A1	
29383000	XF75	1/21,3/23	H		4	100	660	600	608				A20	
29340000	XF95	1/28,1/30	V	7,1	2	80	900	900	172		24xR60	24xR60	A22	58
29342000	XF95	1/28,1/31	V	7,5	2	80	900	900	160		24xR60	24xR60	A22	65
29344000	XF95	1/31,1/32	V	7,5	2	80	900	900	136		24xR60	24xR60	A22	69
29346000	XF95	2/19	V		2	80	900	820	68		R49	R49	A28	
29352000	XF95	3/31	V		3	80	900	900			24xR60	24xR60	A22	102
29354000	XF95	1/31,1/32	V	7,1	2	80	900	900	106				A22	63
29366000	XF95	1/29,2/31	V	9,0	3	80	900	900	113		24xR60	24xR60	A22	100
29372000	XF95	2/32,P/23	V	6,5	2	80	900	900	121		26xR39	26xR39	A22	93
29381000	XF95	1/30,1/31,1/38	H	11,5	3	100	900	1000	112				B10	99
29383000	XF95	1/21,3/23	H		4	100	660	600	608				A20	
29387000	XF95	1/33,1/35,1/43	H	13,0	3	100	900	1000	101				B10	111
29389000	XF95	1/30,1/31,1/38	H	13,0	3	100	900	900	118				A10	99

SCANIA



SCANIA

FORMEN; SHAPE

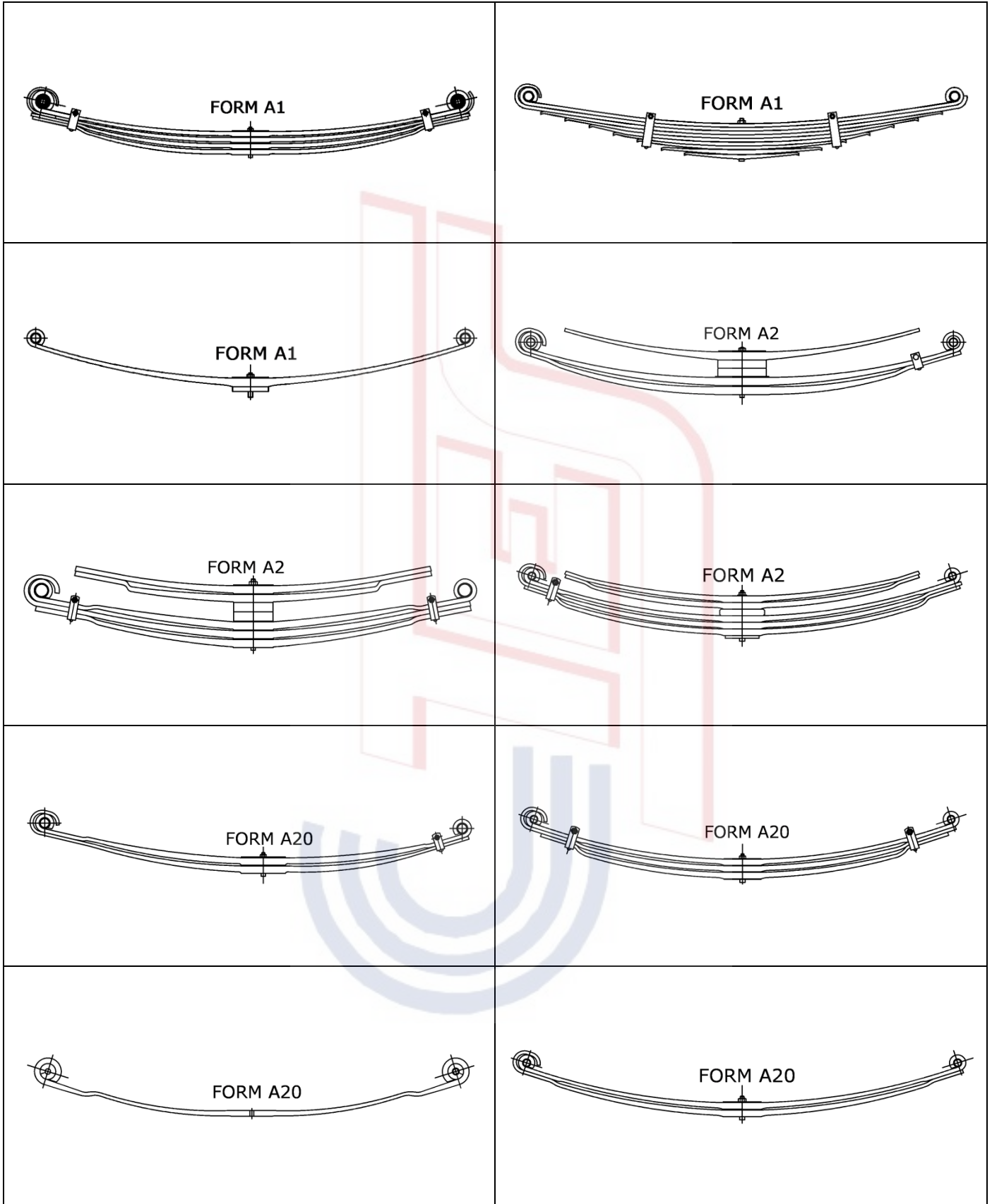

SCANIA

FORMEN; SHAPE

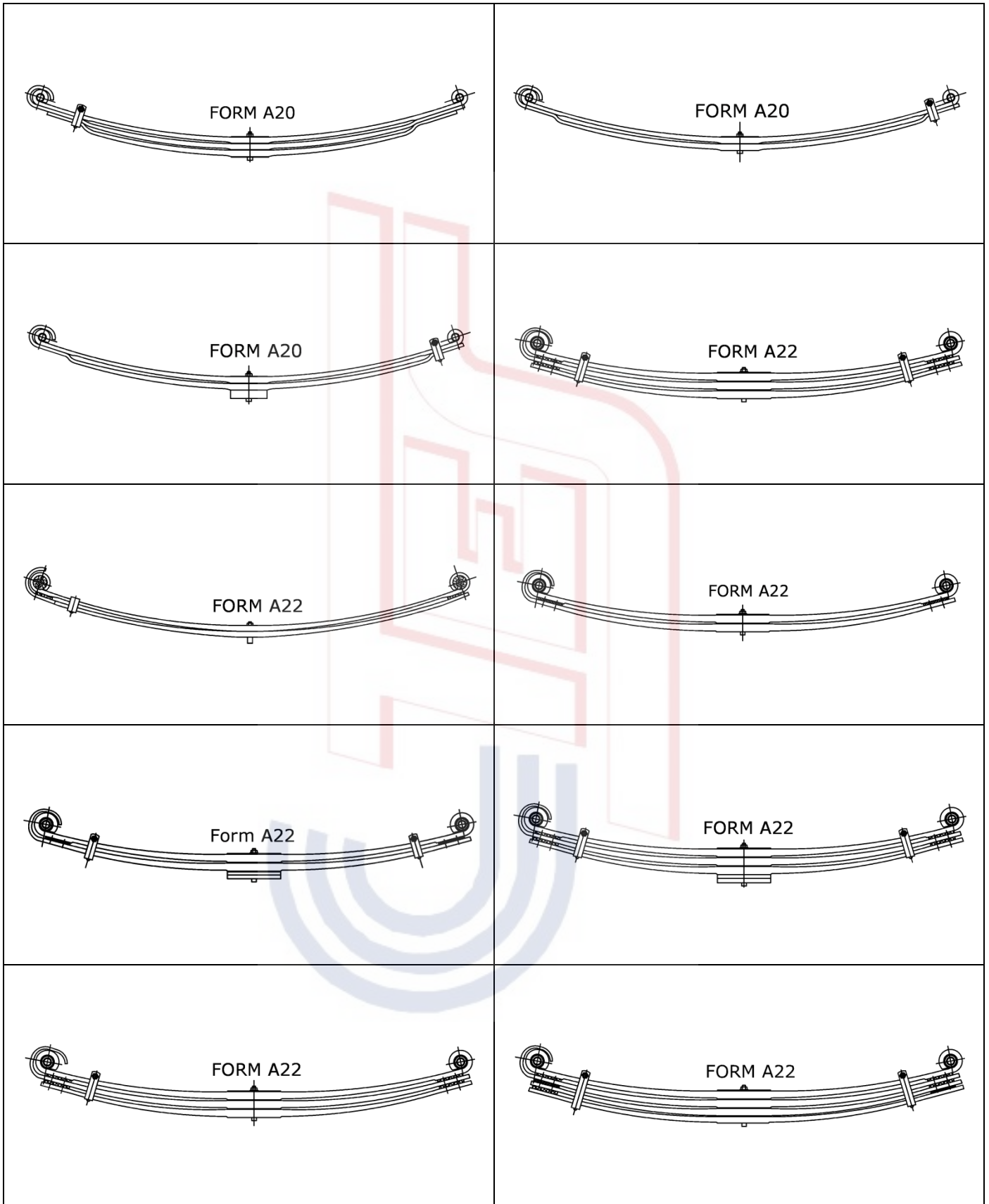

SCANIA

FORMEN; SHAPE

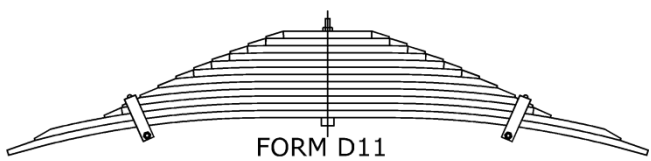
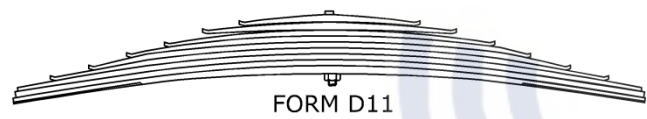
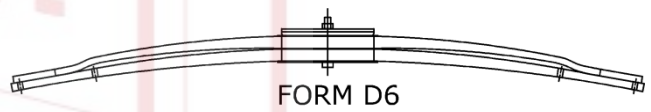
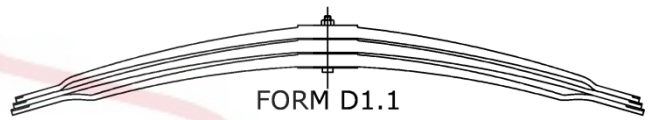
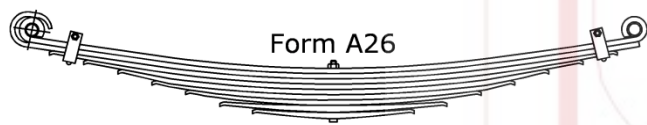
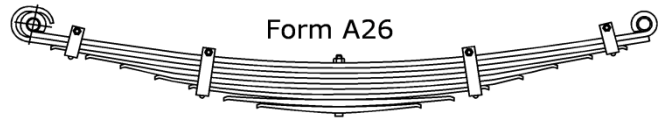
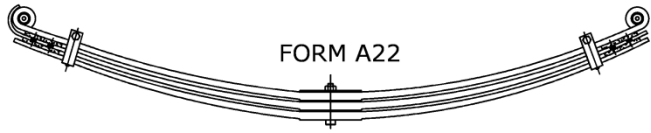

SCANIA

FORMEN; SHAPE

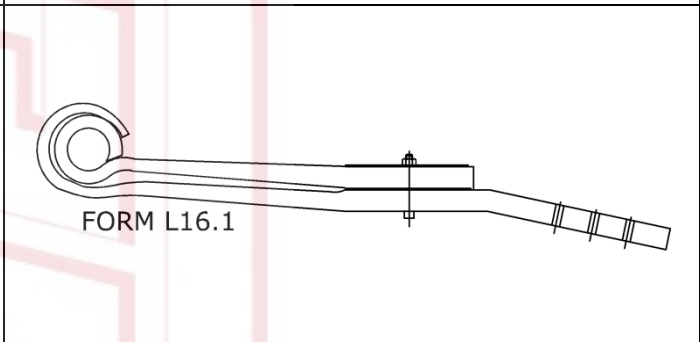
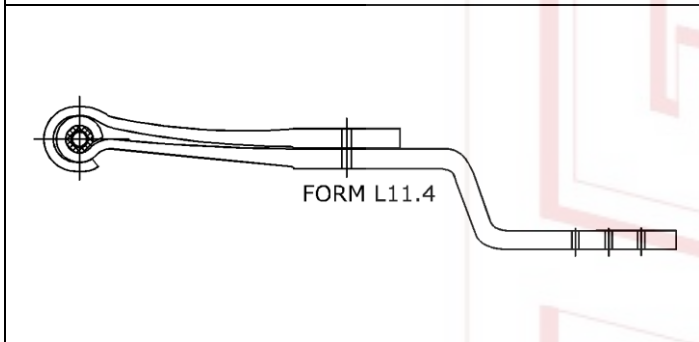
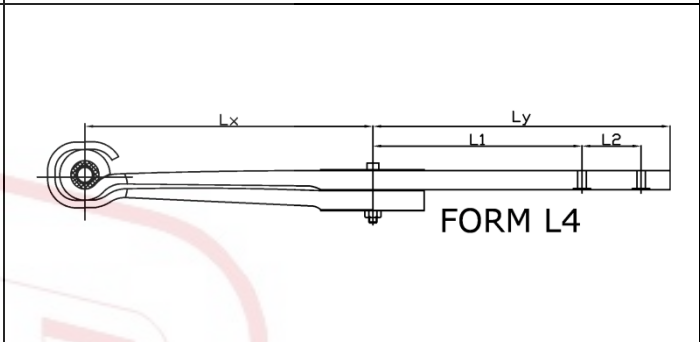
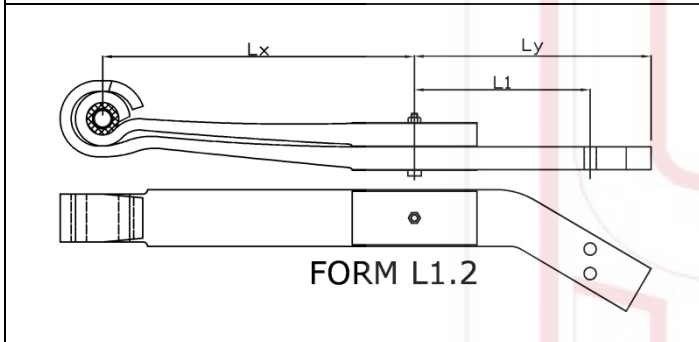
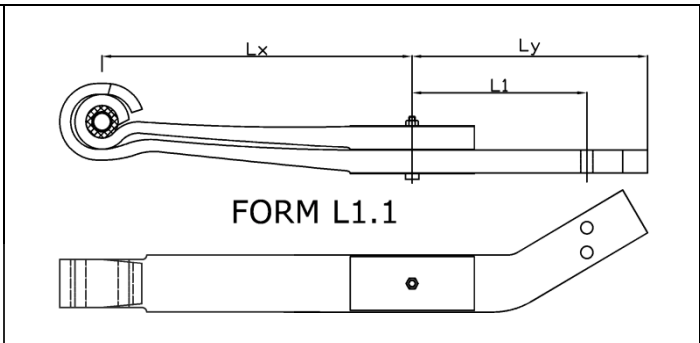
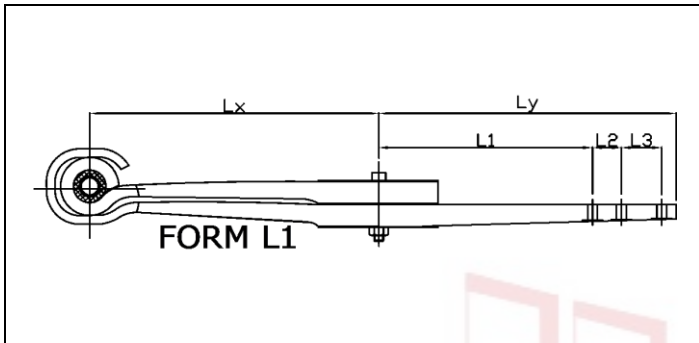

Artikel.Nr.	Fahrzeugtyp	Info		Achsl.	Blattzahl	Breite	Lx/L1/L3	Ly/L2/L3	Spr./ Kr.	Buchsen vorn	Buchsen hinten	Form	Paket- stärke
Art.-No.	Type			Axle Load	Leaves	Width			Free Arch/ Crank	Bush front	Bush rear	Shape	Total height
90124000	G82M 4x2A G82M 6x2A P82M 4x2A P82MA 4x2A	2/28	V		2	90	910	910	147	R 36	R 36	A1	
90126000	G82M 4x2A G82M 6x2A P82M 4x2A P82MA 4x2A	2/30	V		2	90	910	910	133	R 36	R 36	A20	66
90100000	G82M 6x2A G82MA 4x2A P82M 4x2 P82M 4x2A P82MA 4x2 P82MA 4x2A T82M 4x2	3/23	V	6,0	3	90	910	910	168	R 36	R 36	A20	75
90102000	G82M 6x2A P82H 4x2 P82MA 4x2 P82MA 4x2A T82H 4x2	3/24	V	6,5	3	90	910	910	162	R 36	R 36	A20	78
90108000	G82H P82H T82H	3/26	V	7,0	3	90	910	910	159	R 36	R 36	A20	87
90106000	G82M 4x2 P82M 4x2 P82MA 4x2 T82M 4x2	6/15+P/15	V	6,0	6	90	910	910	180	R 36	R 36	A26	105
90114000	G82MD 6x2	5/17	V	6,0	5	90	910	910	120	R 36	R 36	A1	85
90094000	G82MA 4x2A P82H 4x2 P82M 4x2 P82M 6x2V T82H 4x2	7/15	V	6,5	7	90	910	910	170	R 36	R 36	A26	105
90104000	G82H 4x2 P82H 4x2 T82H 4x2	8/15	V	7,0	8	90	910	910	175	R 36	R 36	A26	120
90067000	G82H 6x2 P82H 6x2 T82H 6x2	3/22	H		3	100	760	760	46	R 46	R 46	A20	74
90077000	G82H 6x2 G82M 6x2 P82H 6x2 P82M 6x2 T82H 6x2 T82M 6x2	4/22	H	18	4	100	760	760	125	R 46	R 46	A20	97
90007000	G82M 6x4 FB P82M 6x4 FB	5/15	H		5	90	620	780		R 46	R 46	A26	75
90005000	G82M 6x4 FB P82M 6x4 FB	5/15	H		5	90	780	620		R 46	R 46	A26	75
90079000	G82H 4x2 P82H 4x2 T82H 4x2	3/26,2/26Pl.,2/30	H	13,0	5	90	890	890	156	R 46	R 46	A2	205
90101000	P82M 4x2 P82MA 4x2 T82H 4x2 T82M 4x2	3/24,2/26,2/30	H	10	5	90	890	890	177	R 46	R 46	A2	199
90027000	G82M 6x4 FB P82M 6x4 FB	7/15	H		7	90	780	620	107	R 46	R 46	A26	105
90029000	G82M 6x4 FB P82M 6x4 FB	7/15	H		7	90	620	780	107	R 46	R 46	A26	105
90037000	G82M 6x4 FB G82MD 6x2 P82M 6x4 FB	8/15	H	9,0	8	90	620	780	105	R 46	R 46	A26	120
90035000	G82M 6x4 FB G82MD 6x2 P82M 6x4 FB	8/15	H	9,0	8	90	780	620	105	R 46	R 46	A26	120
90109000	G82H 6x2 P82H 6x2 T82H 6x2	1/15,10/13	H	20,0	11	100	760	760	140	R 46	R 46	A1	145
90081000	G82H 6x2 P82H 6x2 T82H 6x2	1/13,11/11	H	17	12	100	760	760	46	R 46	R 46	A1	134

Artikel.Nr.	Fahrzeugtyp	Info		Achsl.	Blattzahl	Breite	Lx/L1/L3	Ly/L2/L3	Spr./ Kr.	Buchsen vorn	Buchsen hinten	Form	Paket- stärke
Art.-No.	Type			Axle Load	Leaves	Width			Free Arch/ Crank	Bush front	Bush rear	Shape	Total height
90117000	G82M 4x2	5/17	T	10,5	5	90	890	890	135	R 46	R 46	A1	85
90097000	P82M 4x2 T82M 4x2	7/15	T		7	90	890	890	180	R 46	R 46	A26	105
90105000	G82M 4x2 P82M 4x2 P82M 6x2 T82H 4x2	7/15	T	11,0	7	90	890	890	180	R 46	R 46	A26	105
90105000	T82M 4x2	7/15	T	11,0	7	90	890	890	180	R 46	R 46	A26	105
90115000	G82H 4x2 P82H 4x2 T82H 4x2	9/15	T	13,0	9	90	890	890	185	R 46	R 46	A26	135
90113000	G82M 4x2	5/15	Z	10,5	5	90	730	730	90			D1.1	75
90089000	P82M 4x2 T82M 4x2	6/13	Z		6	90	730	730	120			D11	78
90107000	G82H 4x2 G82M 4x2 P82H 4x2 P82M 4x2 T82H 4x2 T82M 4x2	6/14	Z	11,0	6	90	730	730	119			D11	84
90161000	G82M 4x2A G82M 6x2A G82MA 4x2A P82M 4x2A P82M 6x2A P82MA 4x2A	1/43,1/40	L	10,5	2	120	702/186	353/142	50	30xR65		L4	89
90157000	G82M 4x2PA P82M 4x2PA	1/43,1/40	L	10,5	2	120	704/186	353/142	60	30xR65		L4	89
90133000	G82M 4x2PA P82M 4x2PA	2/40	L		2	120	705/186	345/142	-55	30xR65		L4	86
90111000	G82M 4x2A G82M 6x2A G82MA 4x2A P82M 4x2A P82M 6x2A P82MA 4x2A	2/40	L	10,5	2	120	705/185	345/140	43	30xR65		L4	86

Artikel.Nr.	Fahrzeugtyp	Info		Achsl.	Blattzahl	Breite	Lx/L1	Ly/L2	Spr./ Kr.	Buchsen vorn	Buchsen hinten	Form	Paket- stärke
Art.-No.	Type			Axle Load	Leaves	Width			Free Arch/ Crank	Bush front	Bush rear	Shape	Total height
90100000	G92M 4x2 P92M 4x2 R92M 4x2 T92M 4x2	3/23	V	6,0	3	90	910	910	168	R 36	R 36	A20	75
90102000	G92H 4x2 G92H 6x2 G92M 4x2 G92MA 4x2 P92H 4x2 P92H 6x2 P92M 4x2 P92MA 4x2 R92H 4x2 R92H 6x2 R92M 4x2 R92MA 4x2 T92H 4x2 T92H 6x2 T92M 4x2 T92MA 4x2	3/24	V	6,5	3	90	910	910	162	R 36	R 36	A20	78
90108000	G92H 4x2 G92H 6x2 P92H 4x2 P92H 6x2 R92H 4x2 R92H 6x2 T92H 4x2 T92H 6x2	3/26	V	7,0	3	90	910	910	159	R 36	R 36	A20	87
90114000	G92MD P92MD R92MD	5/17	V	6,0	5	90	910	910	120	R 36	R 36	A1	85
90106000	G92M 4x2 G92MA 4x2 P92M 4x2 P92MA 4x2 R92M 4x2 R92MA 4x2 T92M 4x2 T92MA 4x2	6/15+P/15	V	6,0	6	90	910	910	180	R 36	R 36	A26	105
90094000	G92H 4x2 G92H 6x2 G92HB 4x2 G92HB 6x2 G92M 4x2 G92MA 4x2 P92H 4x2 P92H 6x2 P92HB 4x2 P92HB 6x2 P92M 4x2 P92MA 4x2 R92H 4x2 R92H 6x2 R92HB 4x2 R92HB 6x2 R92M 4x2 R92MA 4x2 T92H 4x2 T92H 6x2 T92HB 4x2 T92HB 6x2 T92M 4x2 T92MA 4x2	7/15	V	6,5	7	90	910	910	170	R 36	R 36	A26	105

Artikel.Nr.	Fahrzeugtyp	Info		Achsl.	Blattzahl	Breite			Spr./Kr.	Buchsen vorn	Buchsen hinten	Form	Paketstärke
Art.-No.	Type			Axle Load	Leaves	Width	Lx/L1	Ly/L2	Free Arch/Crank	Bush front	Bush rear	Shape	Total height
90104000	G92H 4x2 G92H 6x2 G92HB 4x2 G92HB 6x2 P92H 4x2 P92H 6x2 P92HB 4x2 P92HB 6x2 R92H 4x2 R92H 6x2 R92HB 4x2 R92HB 6x2 T92H 4x2 T92H 6x2 T92HB 4x2 T92HB 6x2	8/15	V	7,0	8	90	910	910	175	R 36	R 36	A26	120
90007000	G92 M6x4FB P92 M6x4FB R92 M6x4FB	5/15	H		5	90	620	780		R 46	R 46	A26	75
90005000	G92M 6x4FB P92M 6x4FB R92M 6x4FB	5/15	H		5	90	780	620		R 46	R 46	A26	75
90079000	G92H 4x2 G92H 6x2/4HST G92MA 4x2 G92MA 6x2/4HST P92H 4x2 P92H 6x2/4HST P92MA 4x2 P92MA 6x2/4HST R92H 4x2 R92H 6x2/4HST R92MA 4x2 R92MA 6x2/4HST T92H 4x2 T92H 6x2/4HST T92MA 4x2 T92MA 6x2/4HST	3/26,2/26,2/30	H	13,0	5	90	890	890	156	R 46	R 46	A2	205
90101000	G92H 4x2 G92H 6x2/4HST G92M 4x2 G92M 6x2/4HST G92MA 4x2 G92MA 6x2/4HST P92H 4x2 P92H 6x2/4HST P92M 4x2 P92M 6x2/4HST P92MA 4x2 P92MA 6x2/4HST R92H 4x2 R92H 6x2/4HST R92M 4x2 R92M 6x2/4HST R92MA 4x2 R92MA 6x2/4HST T92H 4x2 T92H 6x2/4HST T92M 4x2 T92M 6x2/4HST T92MA 4x2 T92MA 6x2/4HST	3/24,2/26,2/30	H	10,0	5	90	890	890	177	R 46	R 46	A2	199
90029000	G92M 6x4FB P92M 6x4FB R92M 6x4FB	7/15	H		7	90	620	780	107	R 46	R 46	A26	105
90027000	G92M 6x4FB P92M 6x4FB R92M 6x4FB	7/15	H		7	90	780	620	107	R 46	R 46	A26	105
90037000	G92M 6x4FB P92M 6x4FB R92M 6x4FB	8/15	H	9,0	8	90	620	780	105	R 46	R 46	A26	120

Artikel.Nr.	Fahrzeugtyp	Info		Achsl.	Blattzahl	Breite			Spr./ Kr.	Buchsen vorn	Buchsen hinten	Form	Paket- stärke
Art.-No.	Type			Axle Load	Leaves	Width	Lx/L1	Ly/L2	Free Arch/ Crank	Bush front	Bush rear	Shape	Total height
90035000	G92M 4x2 G92M 6x2/4R G92M 6x4FB G92MA 4x2 G92MA 6x2/4R G92MD 4x2 G92MD 6x2/4R P92M 4x2 P92M 6x2/4R P92M 6x4FB P92MA 4x2 P92MA 6x2/4R P92MD 4x2 P92MD 6x2/4R R92M 4x2 R92M 6x2/4R R92M 6x4FB R92MA 4x2 R92MA 6x2/4R R92MD 4x2 R92MD 6x2/4R T92M 4x2 T92M 6x2/4R T92MA 4x2 T92MA 6x2/4R T92MD 4x2 T92MD 6x2/4R	8/15	H	9,0	8	90	780	620	105	R 46	R 46	A26	120
90077000	G92H 6x2 G92M 6x2 P92H 6x2 P92M 6x2 R92H 6x2 R92M 6x2 T92H 6x2 T92M 6x2	4/22	H	18	4	100	760	760	125	R 46	R 46	A20	97
90095000	G92 6x4BB P92 6x4BB R92 6x4BB	8/20	H	20	8	100	743	743	65			D11	160
90143000	G92HB 6x2 P92HB 6x2 R92HB 6x2	9/15	H		9	100	760	760		R 46	R 46	A1	135
90121000	G92 6x4BB P92 6x4BB R92 6x4BB	10/15	H		10	100	743	743	65			D11	150
90109000	G92H 6x2 G92M 6x2 P92H 6x2 P92M 6x2 R92H 6x2 R92M 6x2 T92H 6x2 T92M 6x2	1/15,10/13	H	20,0	11	100	760	760	140	R 46	R 46	A1	145
90091000	G92 6x4BB P92 6x4BB R92 6x4BB	12/15	H	20	12	100	743	743	74			D11	180
90039000	G92H 6x2 P92H 6x2 R92H 6x2 T92H 6x2	1/13,11/11	H	8,5	12	100	760	760	164	R 46	R 46	A1	134
90081000	G92H 6x2 P92H 6x2 R92H 6x2 T92H 6x2	1/13,11/11	H	2x8,5	12	100	760	760	154	R 46	R 46	A1	134
90117000	G92M 4x2 G92M 6x2/4 R G92MA 4x2 G92MA 6x2/4R P92M 4x2 P92M 6x2/4R P92MA 4x2 P92MA 6x2/4R R92M 4x2 R92M 6x2/4R R92MA 4x2 R92MA 6x2/4R	5/17	T		5	90	890	890	135	R 46	R 46	A1	85

Artikel.Nr.	Fahrzeugtyp	Info		Achsl.	Blattzahl	Breite	Lx/L1	Ly/L2	Spr./ Kr.	Buchsen vorn	Buchsen hinten	Form	Paket- stärke
Art.-No.	Type			Axle Load	Leaves	Width			Free Arch/ Crank	Bush front	Bush rear	Shape	Total height
90105000	G92H 4x2 G92H 6x2/4R G92M 4x2 G92M 6x2/4R G92MA 4x2 G92MA 6x2/4R P92H 4x2 P92H 6x2/4R P92M 4x2 P92M 6x2/4R P92MA 4x2 P92MA 6x2/4R R92H 4x2 R92H 6x2/4R R92M 4x2 R92M 6x2/4R R92MA 4x2 R92MA 6x2/4R T92H 4x2 T92H 6x2/4R T92M 4x2 T92M 6x2/4R T92MA 4x2 T92MA 6x2/4R	7/15	T	11,0	7	90	890	890	180	R 46	R 46	A26	105
90115000	G92H 4x2 G92H 6x2/4R P92H 4x2 P92H 6x2/4R R92H 4x2 R92H 6x2/4R T92H 4x2 T92H 6x2/4R	9/15	T	13,0	9	90	890	890	185	R 46	R 46	A26	135
90113000	G92M 4x2 G92M 6x2/4R G92MA 4x2 G92MA 6x2/4R P92M 4x2 P92M 6x2/4R P92MA 4x2 P92MA 6x2/4R R92M 4x2 R92M 6x2/4R R92MA 4x2 R92MA 6x2/4R	5/15	Z		5	90	730	730	90			D1.1	75
90107000	G92H 4x2 G92H 6x2/4R G92M 4x2 G92M 6x2/4R G92MA 4x2 G92MA 6x2/4R P92H 4x2 P92H 6x2/4R P92M 4x2 P92M 6x2/4R P92MA 4x2 P92MA 6x2/4R R92H 4x2 R92H 6x2/4R R92M 4x2 R92M 6x2/4R R92MA 4x2 R92MA 6x2/4R T92H 4x2 T92H 6x2/4R T92M 4x2 T92M 6x2/4R T92MA 4x2 T92MA 6x2/4R	6/14	Z	11,0	6	90	730	730	119			D11	84
90151000	G92MA 6x2/4HST ARA 55 P92MA 6x2/4HST ARA 55 R92MA 6x2/4HST ARA 55		L		2	90	450	415		R46		L11.4	
90153000	G92M 6x2 ASA70 P92M 6x2 ASA 70 R92M 6x2 ASA70	2/42	L		2	100	690	260	-42	30		L16.1	90

92

SCANIA

92

Artikel.Nr.	Fahrzeugtyp	Info		Achsl.	Blattzahl	Breite			Spr./ Kr.	Buchsen vorn	Buchsen hinten	Form	Paket- stärke
Art.-No.	Type			Axle Load	Leaves	Width	Lx/L1	Ly/L2	Free Arch/ Crank	Bush front	Bush rear	Shape	Total height
90161000	G92M 4x2 G92M 6x2 ASA60 G92MA 4x2 G92MD 4x2 P92M 4x2 P92M 6x2 ASA 60 P92MA 4x2 P92MD 4x2 R92M 4x2 R92M 6x2 ASA60 R92MA 4x2 R92MD 4x2	1/43,1/40	L	10,5	2	120	702/ 186	353/ 142	50	30xR65		L4	89
90157000	G92M 4x2 G92M 6x2 ASA60 G92M 6x2 ASA70 G92MA 4x2 G92MD 4x2 P92M 4x2 P92M 6x2 ASA 60 P92M 6x2 ASA 70 P92MA 4x2 P92MD 4x2 R92M 4x2 R92M 6x2 ASA60 R92M 6x2 ASA70 R92MA 4x2 R92MD 4x2	1/43,1/40	L		2	120	704/ 186	353/ 142	60	30xR65		L4	89
90111000	G92M 4x2 G92M 6x2 ASA60 G92MA 4x2 G92MD 4x2 P92M 4x2 P92M 6x2 ASA 60 P92MA 4x2 P92MD 4x2 R92M 4x2 R92M 6x2 ASA60 R92MA 4x2 R92MD 4x2	2/40	L	10,5	2	120	705/ 185	345/ 140	43	30xR65		L4	86
90133000	G92M 4x2 G92M 6x2 ASA60 G92M 6x2 ASA70 G92MA 4x2 G92MD 4x2 P92M 4x2 P92M 6x2 ASA 60 P92M 6x2 ASA 70 P92MA 4x2 P92MD 4x2 R92M 4x2 R92M 6x2 ASA 60 R92M 6x2 ASA70 R92MA 4x2 R92MD 4x2	2/40	L		2	120	705/ 186	345/ 142	-55	30xR65		L4	86

93**SCANIA****93**

Artikel.Nr.	Fahrzeugtyp	Info		Achsl.	Blattzahl	Breite	Lx/L1	Ly/L2	Spr./ Kr.	Buchsen vorn	Buchsen hinten	Form	Paket- stärke
Art.-No.	Type			Axle Load	Leaves	Width			Free Arch/ Crank	Bush front	Bush rear	Shape	Total height
90124000	G93HB 6x2 G93HL 4x2 G93HL 6x2 G93HL 6x2/4 G93HL 6x4BB G93HL 6x4FB G93MA 4x2 G93MA 6x2/4 G93ML 4x2 G93ML 6x2 G93ML 6x2/4 P93HB 6x2 P93HL 4x2 P93HL 6x2 P93HL 6x2/4 P93HL 6x4BB P93HL 6x4FB P93MA 4x2 P93MA 6x2/4 P93ML 4x2 P93ML 6x2 P93ML 6x2/4 R93HB 6x2 R93HL 4x2 R93HL 6x2 R93HL 6x2/4 R93HL 6x4BB R93HL 6x4FB R93MA 4x2 R93MA 6x2/4 R93ML 4x2 R93ML 6x2 R93ML 6x2/4 T93HB 6x2 T93HL 4x2 T93HL 6x2 T93HL 6x2/4 T93HL 6x4BB T93HL 6x4FB T93MA 4x2 T93MA 6x2/4 T93ML 4x2 T93ML 6x2 T93ML 6x2/4	2/28	V		2	90	910	910	147	R 36	R 36	A1	62

93

SCANIA

93

Artikel.Nr.	Fahrzeugtyp	Info		Achsl.	Blattzahl	Breite	Lx/L1	Ly/L2	Spr./ Kr.	Buchsen vorn	Buchsen hinten	Form	Paket- stärke
Art.-No.	Type			Axle Load	Leaves	Width			Free Arch/ Crank	Bush front	Bush rear	Shape	Total height
90126000	G93HB 6x2 G93HL 4x2 G93HL 6x2 G93HL 6x2/4 G93HL 6x4BB G93HL 6x4FB G93MA 4x2 G93MA 6x2/4 G93ML 4x2 G93ML 6x2 G93ML 6x2/4 P93HB 6x2 P93HL 4x2 P93HL 6x2 P93HL 6x2/4 P93HL 6x4BB P93HL 6x4FB P93MA 4x2 P93MA 6x2/4 P93ML 4x2 P93ML 6x2 P93ML 6x2/4 R93HB 6x2 R93HL 4x2 R93HL 6x2 R93HL 6x2/4 R93HL 6x4BB R93HL 6x4FB R93MA 4x2 R93MA 6x2/4 R93ML 4x2 R93ML 6x2 R93ML 6x2/4 T93HB 6x2 T93HL 4x2 T93HL 6x2 T93HL 6x2/4 T93HL 6x4BB T93HL 6x4FB T93MA 4x2 T93MA 6x2/4 T93ML 4x2 T93ML 6x2 T93ML 6x2/4	2/30	V		2	90	910	910	133	R 36	R 36	A20	66

93**SCANIA****93**

Artikel.Nr.	Fahrzeugtyp	Info		Achsl.	Blattzahl	Breite	Lx/L1	Ly/L2	Spr./ Kr.	Buchsen vorn	Buchsen hinten	Form	Paket- stärke
Art.-No.	Type			Axle Load	Leaves	Width			Free Arch/ Crank	Bush front	Bush rear	Shape	Total height
90128000	G93HB 6x2 G93HL 4x2 G93HL 6x2 G93HL 6x2/4 G93HL 6x4BB G93HL 6x4FB G93MA 4x2 G93MA 6x2/4 G93ML 4x2 G93ML 6x2 G93ML 6x2/4 P93HB 6x2 P93HL 4x2 P93HL 6x2 P93HL 6x2/4 P93HL 6x4BB P93HL 6x4FB P93MA 4x2 P93MA 6x2/4 P93ML 4x2 P93ML 6x2 P93ML 6x2/4 R93HB 6x2 R93HL 4x2 R93HL 6x2 R93HL 6x2/4 R93HL 6x4BB R93HL 6x4FB R93MA 4x2 R93MA 6x2/4 R93ML 4x2 R93ML 6x2 R93ML 6x2/4 T93HB 6x2 T93HL 4x2 T93HL 6x2 T93HL 6x2/4 T93HL 6x4BB T93HL 6x4FB T93MA 4x2 T93MA 6x2/4 T93ML 4x2 T93ML 6x2 T93ML 6x2/4	2/32	V	7,5	2	90	910	910	125	R 36	R 36	A20	70

93

SCANIA

93

Artikel.Nr.	Fahrzeugtyp	Info		Achsl.	Blattzahl	Breite			Spr./ Kr.	Buchsen vorn	Buchsen hinten	Form	Paket- stärke
Art.-No.	Type			Axle Load	Leaves	Width	Lx/L1	Ly/L2	Free Arch/ Crank	Bush front	Bush rear	Shape	Total height
90116000	G93HB 6x2 G93HL 4x2 G93HL 6x2 G93HL 6x2/4 G93HL 6x4BB G93HL 6x4FB G93MA 4x2 G93MA 6x2/4 G93ML 4x2 G93ML 6x2 G93ML 6x2/4 P93HB 6x2 P93HL 4x2 P93HL 6x2 P93HL 6x2/4 P93HL 6x4BB P93HL 6x4FB P93MA 4x2 P93MA 6x2/4 P93ML 4x2 P93ML 6x2 P93ML 6x2/4 R93HB 6x2 R93HL 4x2 R93HL 6x2 R93HL 6x2/4 R93HL 6x4BB R93HL 6x4FB R93MA 4x2 R93MA 6x2/4 R93ML 4x2 R93ML 6x2 R93ML 6x2/4 T93HB 6x2 T93HL 4x2 T93HL 6x2 T93HL 6x2/4 T93HL 6x4BB T93HL 6x4FB T93MA 4x2 T93MA 6x2/4 T93ML 4x2 T93ML 6x2 T93ML 6x2/4	3/29	V	8,5	3	90	910	910	137	R 36	R 36	A20	96
90130000	G93ML 8x4FB P93ML 8x4FB R93ML 8x4FB	4/22	V	2x6,5	4	90	715	910	130	R 36	R 36	A20	100
90132000	G93ML 8x4FB P93ML 8x4FB R93ML 8x4FB	4/22	V	2x6,5	4	90	910	715	130	R 36	R 36	A20	100
90138000	G93HL 4x2 G93HL 6x2 G93HL 6x2/4 G93HL 6x4BB	4/28	V		4	90	910	910	116	R 36	R 36	A20	122

93**SCANIA****93**

Artikel.Nr.	Fahrzeugtyp	Info		Achsl.	Blattzahl	Breite	Lx/L1	Ly/L2	Spr./ Kr.	Buchsen vorn	Buchsen hinten	Form	Paket- stärke
Art.-No.	Type			Axle Load	Leaves	Width			Free Arch/ Crank	Bush front	Bush rear	Shape	Total height
90114000	G93HB 6x2	5/17	V	6,0	5	90	910	910	120	R 36	R 36	A1	85
	G93HL 4x2	5/17											
	G93HL 6x2	5/17											
	G93HL 6x2/4	5/17											
	G93HL 6x4BB	5/17											
	G93HL 6x4FB	5/17											
	G93MA 4x2	5/17											
	G93MA 6x2/4	5/17											
	G93ML 4x2	5/17											
	G93ML 6x2	5/17											
	G93ML 6x2/4	5/17											
	P93HB 6x2	5/17											
	P93HL 4x2	5/17											
	P93HL 6x2	5/17											
	P93HL 6x2/4	5/17											
	P93HL 6x4BB	5/17											
	P93HL 6x4FB	5/17											
	P93MA 4x2	5/17											
	P93MA 6x2/4	5/17											
	P93ML 4x2	5/17											
	P93ML 6x2	5/17											
	P93ML 6x2/4	5/17											
	R93HB 6x2	5/17											
	R93HL 4x2	5/17											
	R93HL 6x2	5/17											
	R93HL 6x2/4	5/17											
	R93HL 6x4BB	5/17											
	R93HL 6x4FB	5/17											
	R93MA 4x2	5/17											
	R93MA 6x2/4	5/17											
	R93ML 4x2	5/17											
	R93ML 6x2	5/17											
	R93ML 6x2/4	5/17											

93

SCANIA

93

Artikel.Nr.	Fahrzeugtyp	Info		Achsl.	Blattzahl	Breite	Lx/L1	Ly/L2	Spr./ Kr.	Buchsen vorn	Buchsen hinten	Form	Paket- stärke
Art.-No.	Type			Axle Load	Leaves	Width			Free Arch/ Crank	Bush front	Bush rear	Shape	Total height
90106000	G93HB 6x2	6/15+P/15	V	6,0	6	90	910	910	180	R 36	R 36	A26	105
	G93HL 4x2	6/15+P/15											
	G93HL 6x2	6/15+P/15											
	G93HL 6x2/4	6/15+P/15											
	G93HL 6x4BB	6/15+P/15											
	G93HL 6x4FB	6/15+P/15											
	G93MA 4x2	6/15+P/15											
	G93MA 6x2/4	6/15+P/15											
	G93ML 4x2	6/15+P/15											
	G93ML 6x2	6/15+P/15											
	G93ML 6x2/4	6/15+P/15											
	P93HB 6x2	6/15+P/15											
	P93HL 4x2	6/15+P/15											
	P93HL 6x2	6/15+P/15											
	P93HL 6x2/4	6/15+P/15											
	P93HL 6x4BB	6/15+P/15											
	P93HL 6x4FB	6/15+P/15											
	P93MA 4x2	6/15+P/15											
	P93MA 6x2/4	6/15+P/15											
	P93ML 4x2	6/15+P/15											
	P93ML 6x2	6/15+P/15											
	P93ML 6x2/4	6/15+P/15											
	R93HB 6x2	6/15+P/15											
	R93HL 4x2	6/15+P/15											
	R93HL 6x2	6/15+P/15											
	R93HL 6x2/4	6/15+P/15											
	R93HL 6x4BB	6/15+P/15											
	R93HL 6x4FB	6/15+P/15											
	R93MA 4x2	6/15+P/15											
	R93MA 6x2/4	6/15+P/15											
	R93ML 4x2	6/15+P/15											
	R93ML 6x2	6/15+P/15											
	R93ML 6x2/4	6/15+P/15											
	T93HB 6x2	6/15+P/15											
	T93HL 4x2	6/15+P/15											
	T93HL 6x2	6/15+P/15											
	T93HL 6x2/4	6/15+P/15											
	T93HL 6x4BB	6/15+P/15											
	T93HL 6x4FB	6/15+P/15											
	T93MA 4x2	6/15+P/15											
	T93MA 6x2/4	6/15+P/15											
	T93ML 4x2	6/15+P/15											
	T93ML 6x2	6/15+P/15											

93

SCANIA

93

Artikel.Nr.	Fahrzeugtyp	Info		Achsl.	Blattzahl	Breite	Lx/L1	Ly/L2	Spr./ Kr.	Buchsen vorn	Buchsen hinten	Form	Paket- stärke
Art.-No.	Type			Axle Load	Leaves	Width			Free Arch/ Crank	Bush front	Bush rear	Shape	Total height
90094000	G93HB 6x2	7/15	V	6,5	7	90	910	910	170	R 36	R 36	A26	105
	G93HL 4x2	7/15											
	G93HL 6x2	7/15											
	G93HL 6x2/4	7/15											
	G93HL 6x4BB	7/15											
	G93HL 6x4FB	7/15											
	G93MA 4x2	7/15											
	G93MA 6x2/4	7/15											
	G93ML 4x2	7/15											
	G93ML 6x2	7/15											
	G93ML 6x2/4	7/15											
	P93HB 6x2	7/15											
	P93HL 4x2	7/15											
	P93HL 6x2	7/15											
	P93HL 6x2/4	7/15											
	P93HL 6x4BB	7/15											
	P93HL 6x4FB	7/15											
	P93MA 4x2	7/15											
	P93MA 6x2/4	7/15											
	P93ML 4x2	7/15											
	P93ML 6x2	7/15											
	P93ML 6x2/4	7/15											
	R93HB 6x2	7/15											
	R93HL 4x2	7/15											
	R93HL 6x2	7/15											
	R93HL 6x2/4	7/15											
	R93HL 6x4BB	7/15											
	R93HL 6x4FB	7/15											
	R93MA 4x2	7/15											
	R93MA 6x2/4	7/15											
	R93ML 4x2	7/15											
	R93ML 6x2	7/15											
	R93ML 6x2/4	7/15											
	T93HB 6x2	7/15											
	T93HL 4x2	7/15											
	T93HL 6x2	7/15											
	T93HL 6x2/4	7/15											
	T93HL 6x4BB	7/15											
	T93HL 6x4FB	7/15											
	T93MA 4x2	7/15											
	T93MA 6x2/4	7/15											
	T93ML 4x2	7/15											
	T93ML 6x2	7/15											
	T93ML 6x2/4	7/15											

93

SCANIA

93

Artikel.Nr.	Fahrzeugtyp	Info		Achsl.	Blattzahl	Breite	Lx/L1	Ly/L2	Spr./ Kr.	Buchsen vorn	Buchsen hinten	Form	Paket- stärke
Art.-No.	Type			Axle Load	Leaves	Width			Free Arch/ Crank	Bush front	Bush rear	Shape	Total height
90135000	G93HL 4x2 G93HL 6x2/4HST G93HL 6x2/4VST G93MA 4x2 G93MA 6x2/4HST G93MA 6x2/4VST G93ML 6x2/4HST G93ML 6x2/4VST G93ML4x2 P93HL 4x2 P93HL 6x2/4HST P93HL 6x2/4VST P93MA 4x2 P93MA 6x2/4HST P93MA 6x2/4VST P93ML4x2 R93HL 4x2 R93HL 6x2/4HST R93HL 6x2/4VST R93MA 4x2 R93MA 6x2/4HST R93MA 6x2/4VST R93ML 6x2/4HST R93ML 6x2/4VST R93ML4x2 T93HL 4x2 T93HL 6x2/4HST T93HL 6x2/4VST T93MA 4x2 T93MA 6x2/4HST T93MA 6x2/4VST T93ML 6x2/4HST T93ML 6x2/4VST T93ML4x2	2/34,2/34Pl.,1/34	H		3	90	890	890	145	R 46	R 46	A2	179
90007000	G93HL 6x4FB G93ML 8x4FB P93HL 6x4FB P93ML 8x4FB R93HL 6x4FB R93ML 8x4FB	5/15	H		5	90	620	780		R 46	R 46	A26	75
90005000	G93HL 6x4FB G93ML 8x4FB P93HL 6x4FB P93ML 8x4FB R93HL 6x4FB R93ML 8x4FB	5/15	H		5	90	780	620		R 46	R 46	A26	75
90029000	G93HL 6x4FB G93ML 8x4FB P93HL 6x4FB P93ML 8x4FB R93HL 6x4FB R93ML 8x4FB	7/15	H		7	90	620	780	107	R 46	R 46	A26	105
90027000	G93HL 6x4FB G93ML 8x4FB P93HL 6x4FB P93ML 8x4FB R93HL 6x4FB R93ML 8x4FB	7/15	H		7	90	780	620	107	R 46	R 46	A26	105
90037000	G93HL 6x4FB G93ML 8x4FB P93HL 6x4FB P93ML 8x4FB R93HL 6x4FB R93ML 8x4FB	8/15	H	9,0	8	90	620	780	105	R 46	R 46	A26	120

Artikel.Nr.	Fahrzeugtyp	Info		Achsl.	Blattzahl	Breite			Spr./ Kr.	Buchsen vorn	Buchsen hinten	Form	Paket- stärke
Art.-No.	Type			Axle Load	Leaves	Width	Lx/L1	Ly/L2	Free Arch/ Crank	Bush front	Bush rear	Shape	Total height
90035000	G93HL 6x4FB G93ML 4x2 G93ML 6x2/4HST G93ML 6x2/4VST G93ML 8x4FB P93HL 6x4FB P93ML 4x2 P93ML 6x2/4HST P93ML 6x2/4VST P93ML 8x4FB R93HL 6x4FB R93ML 4x2 R93ML 6x2/4HST R93ML 6x2/4VST R93ML 8x4FB T93ML 4x2 T93ML 6x2/4HST T93ML 6x2/4VST	8/15	H	9,0	8	90	780	620	105	R 46	R 46	A26	120
90147000	G93HL 6x4FB G93ML 8x4FB P93HL 6x4FB P93ML 8x4FB R93HL 6x4FB R93ML 8x4FB	9/15	H		9	90	620	780	105	R 46	R 46	A26	135
90145000	G93HL 6x4FB G93ML 8x4FB P93HL 6x4FB P93ML 8x4FB R93HL 6x4FB R93ML 8x4FB	9/15	H		9	90	780	620	105	R 46	R 46	A26	135
90131000	G93HL/ML 6x2 P93HL 6x2 P93ML 6x2 R93HL 6x2 R93ML 6x2 T93HL 6x2 T93ML 6x2	4/23	H	20,0	4	100	760	760	130	R 46	R 46	A20	101
90141000	G93HL 6x2 G93ML 6x2 P93HL 6x2 R93HL 6x2 R93ML 6x2 T93HL 6x2 T93ML 6x2	5/22	H		5	100	760	760	119	R 46	R 46	A20	121
90095000	G93HL 6x4BB P93HL 6x4BB R93HL 6x4BB T93HL 6x4BB	8/20	H	20	8	100	743	743	65			D11	160
90143000	G93HB 6x2 P93HB 6x2 R93HB 6x2	9/15	H		9	100	760	760		R 46	R 46	A1	135
90093000	G93HL 6x4BB P93HL 6x4BB R93HL 6x4BB T93HL 6x4BB	10/20	H	25	10	100	743	743	70			D11	200
90121000	G93HL 6x4BB P93HL 6x4BB R93HL 6x4BB T93HL 6x4BB	10/15	H		10	100	743	743	65			D11	150
90109000	G93HL 6x2 G93ML 6x2 P93HL 6x2 P93ML 6x2 R93HL 6x2 R93ML 6x2 T93HL 6x2 T93ML 6x2	1/15,10/13	H	20,0	11	100	760	760	140	R 46	R 46	A1	145
90091000	G93HL 6x4BB P93HL 6x4BB R93HL 6x4BB T93HL 6x4BB	12/15	H	20	12	100	743	743	74			D11	180
90119000	G93HL 6x4BB P93HL 6x4BB R93HL 6x4BB T93HL 6x4BB	12/20	H	2x14,5	12	100	743	743	65			D11	240

93	SCANIA	93
-----------	---------------	-----------

Artikel.Nr.	Fahrzeugtyp	Info		Achsl.	Blattzahl	Breite	Lx/L1	Ly/L2	Spr./Kr.	Buchsen vorn	Buchsen hinten	Form	Paketstärke
Art.-No.	Type			Axle Load	Leaves	Width			Free Arch/Crank	Bush front	Bush rear	Shape	Total height
90039000	G93HL 6x2 G93ML 6x2 P93HL 6x2 P93ML 6x2 R93HL 6x2 R93ML 6x2 T93HL 6x2 T93ML 6x2	1/13,11/11	H	8,5	12	100	760	760	164	R 46	R 46	A1	134
90081000	G93HL 6x2 G93ML 6x2 P93HL 6x2 P93ML 6x2 R93HL 6x2 R93ML 6x2 T93HL 6x2 T93ML 6x2	1/13,11/11	H	17	12	100	760	760	154	R 46	R 46	A1	134
90117000	G93ML 4x2 G93ML 6x2/4HST G93ML 6x2/4VST	5/17	T		5	90	890	890	135	R 46	R 46	A1	85
90105000	G93HL 4x2 G93HL 6x2/4HST G93HL 6x2/4VST G93MA 4x2 G93MA 6x2/4HST G93MA 6x2/4VST G93ML 4x2 G93ML 6x2/4HST G93ML 6x2/4VST P93HL 4x2 P93HL 6x2/4HST P93HL 6x2/4VST P93MA 4x2 P93MA 6x2/4HST P93MA 6x2/4VST P93ML 4x2 P93ML 6x2/4HST P93ML 6x2/4VST R93HL 4x2 R93HL 6x2/4HST R93HL 6x2/4VST R93MA 4x2 R93MA 6x2/4HST R93MA 6x2/4VST R93ML 4x2 R93ML 6x2/4HST R93ML 6x2/4VST T93HL 4x2 T93HL 6x2/4HST T93HL 6x2/4VST T93MA 4x2 T93MA 6x2/4HST T93MA 6x2/4VST T93ML 4x2 T93ML 6x2/4HST T93ML 6x2/4VST	7/15	T	11,0	7	90	890	890	180	R 46	R 46	A26	105

Artikel.Nr.	Fahrzeugtyp	Info		Achsl.	Blattzahl	Breite			Spr./ Kr.	Buchsen vorn	Buchsen hinten	Form	Paket- stärke
Art.-No.	Type			Axle Load	Leaves	Width	Lx/L1	Ly/L2	Free Arch/ Crank	Bush front	Bush rear	Shape	Total height
90115000	G/P/R/T93HL 4x2 G93HL 6x2/4HST G93HL 6x2/4VST G93MA 6x2/4HST G93MA 6x2/4VST G93ML 6x2/4HST G93ML 6x2/4VST G93ML4x2 P93HL 6x2/4HST P93HL 6x2/4VST P93MA 4x2 P93MA 6x2/4HST P93MA 6x2/4VST P93ML 6x2/4HST P93ML 6x2/4VST P93ML4x2 R93HL 6x2/4HST R93HL 6x2/4VST R93MA 4x2 R93MA 6x2/4HST R93MA 6x2/4VST R93ML 6x2/4HST R93ML 6x2/4VST R93ML4x2 T93HL 6x2/4HST T93HL 6x2/4VST T93MA 4x2 T93MA 6x2/4HST T93MA 6x2/4VST T93ML 6x2/4HST T93ML 6x2/4VST T93ML4x2	9/15	T	13,0	9	90	890	890	185	R 46	R 46	A26	135
90113000	G93ML 4x2 G93ML 6x2/4HST G93ML 6x2/4VST P93ML 4x2 P93ML 6x2/4HST P93ML 6x2/4VST R93ML 4x2 R93ML 6x2/4HST R93ML 6x2/4VST	5/15	Z		5	90	730	730	90			D1.1	75
90107000	G93HL 4x2 G93HL 6x2/4HST G93HL 6x2/4VST G93MA 4x2 G93MA 6x2/4HST G93MA 6x2/4VST G93ML 6x2/4HST G93ML 6x2/4VST G93ML4x2 P93HL 4x2 P93HL 6x2/4HST P93HL 6x2/4VST P93MA 4x2 P93MA 6x2/4HST P93MA 6x2/4VST P93ML 6x2/4HST P93ML 6x2/4VST P93ML4x2 R93HL 4x2 R93HL 6x2/4HST R93HL 6x2/4VST R93MA 4x2 R93MA 6x2/4HST R93MA 6x2/4VST R93ML 6x2/4HST R93ML 6x2/4VST R93ML4x2 T93HL 4x2 T93HL 6x2/4HST T93HL 6x2/4VST T93MA 4x2 T93MA 6x2/4HST T93MA 6x2/4VST T93ML 6x2/4HST T93ML 6x2/4VST T93ML4x2	6/14	Z	11,0	6	90	730	730	119			D11	84

93

SCANIA

93

Artikel.Nr.	Fahrzeugtyp	Info		Achsl.	Blattzahl	Breite			Spr./ Kr.	Buchsen vorn	Buchsen hinten	Form	Paket- stärke
Art.-No.	Type			Axle Load	Leaves	Width	Lx/L1	Ly/L2	Free Arch/ Crank	Bush front	Bush rear	Shape	Total height
90151000	G93MA 6x2/4HST G93MA 6x2/4VST G93ML 6x2/4HST G93ML 6x2/4VST P93MA 6x2/4HST P93MA 6x2/4VST R93MA 6x2/4HST R93MA 6x2/4VST R93ML 6x2/4HST R93ML 6x2/4VST		L		2	90	450	415		R 46		L11.4	
90163000	G93MA 6x2/4HST G93MA 6x2/4VST G93ML 6x2/4HST G93ML 6x2/4VST P93MA 6x2/4HST P93MA 6x2/4VST R93MA 6x2/4HST R93MA 6x2/4VST R93ML 6x2/4HST R93ML 6x2/4VST	3/24	L		3	90	450/ 220	425/ 105	10	R 46			78
90153000	G93ML 6x2 G93ML 6x2A R93ML 6x2 R93ML 6x2A	2/42	L		2	100	690	260	-42	30		L16.1	90
90159000	G93HL 6x2/4 G93ML 4x2 G93ML 6x2 G93ML 6x2/4 P93HL 6x2/4 P93ML 4x2 R93HL 6x2/4 R93ML 4x2 R93ML 6x2 R93ML 6x2/4	1/47,1/44	L		2	100	690/ 190	260/ 50	50	30xR65		L1	97
90157000	G93HL 4x2 G93HL 6x2/4 G93MA 4x2 G93MA 6x2/4 G93ML 4x2 G93ML 6x2 G93ML 6x2/4 G93ML 6x2A P93HL 4x2 P93HL 6x2/4 P93MA 4x2 P93MA 6x2/4 P93ML 4x2 R93HL 4x2 R93HL 6x2/4 R93MA 4x2 R93MA 6x2/4 R93ML 4x2 R93ML 6x2 R93ML 6x2/4 R93ML 6x2A	1/43,1/40	L		2	120	704/ 186	353/ 142	60	30xR65		L4	89
90133000	G93HL 4x2 G93HL 6x2/4 G93MA 4x2 G93MA 6x2/4 G93ML 4x2 G93ML 6x2 G93ML 6x2/4 G93ML 6x2A P93HL 4x2 P93HL 6x2/4 P93MA 4x2 P93MA 6x2/4 P93ML 4x2 R93HL 4x2 R93HL 6x2/4 R93MA 4x2 R93MA 6x2/4 R93ML 4x2 R93ML 6x2 R93ML 6x2/4 R93ML 6x2A	2/40	L		2	120	705/ 186	345/ 142	-55	30xR65		L4	86

Artikel.Nr.	Fahrzeugtyp	Info		Achsl.	Blattzahl	Breite			Spr./ Kr.	Buchsen vorn	Buchsen hinten	Form	Paket- stärke
Art.-No.	Type			Axle Load	Leaves	Width	Lx/L1	Ly/L2	Free Arch/ Crank	Bush front	Bush rear	Shape	Total height
90126000	94D 4x2 94D 6x2 94D 6x2/4 94G 4x2 94G 6x2 94G 6x4 94G 8x2 94G 8x4 94L 4x2 94L 6x2 94L 6x2/4 94L 6x4	2/30	V		2	90	910	910	133	R 36	R 36	A20	66
90128000	94D 4x2 94D 6x2 94D 6x2/4 94G 4x2 94G 6x2 94G 6x4 94G 8x2 94G 8x4 94L 4x2 94L 6x2 94L 6x2/4 94L 6x4	2/32	V	7,5	2	90	910	910	125	R 36	R 36	A20	70
90116000	94D 4x2 94D 6x2 94D 6x2/4 94G 4x2 94G 6x2 94G 6x4 94G 8x2 94G 8x4 94L 4x2 94L 6x2 94L 6x2/4 94L 6x4	3/29	V	8,5	3	90	910	910	137	R 36	R 36	A20	96
90094000	94D 4x2 94D 6x2 94D 6x2/4 94G 4x2 94G 6x2 94G 6x4 94G 8x4 94L 4x2 94L 6x2 94L 6x2/4 94L 6x4	7/15	V	6,5	7	90	910	910	170	R 36	R 36	A26	105
90038000	94D 4x2 94D 6x2 94D 6x2/4 94G 4x2 94G 6x2 94G 6x4 94G 8x4 94L 4x2 94L 6x2 94L 6x2/4 94L 6x4	9/15	V	8,5	9	90	910	910	170	R 36	R 36	A26	135
90171000	94G 6x4 94G 8x4	4/30	H		4	90	770	770				D6	128
90173000	94G 6x4 94G 8x4	4/41	H		4	90	770	770	56			D6	172
90175000	94G 6x4 94G 8x4	4/41	H		4	90	770	770	83			D6	172
90141000	94G 6x2 94G 8x2	5/22	H		5	100	760	760	119	R 46	R 46	A20	121
90079000	94D 4x2 94G 4x2	3/26,2/30Pl.,2/26	H	13,0	5	90	890	890	156	R 46	R 46	A2	205
90109000	94G 6x2 94G 8x2	1/15,10/13	H	20,0	11	100	760	760	140	R 46	R 46	A1	145
90105000	94D 4x2 94G 4x2	7/15	T	11,0	7	90	890	890	180	R 46	R 46	A26	105
90115000	94D 4x2 94G 4x2	9/15	T	13,0	9	90	890	890	185	R 46	R 46	A26	135

94

SCANIA

94

Artikel.Nr.	Fahrzeugtyp	Info		Achsl.	Blattzahl	Breite			Spr./ Kr.	Buchsen vorn	Buchsen hinten	Form	Paket- stärke
Art.-No.	Type			Axle Load	Leaves	Width	Lx/L1	Ly/L2	Free Arch/ Crank	Bush front	Bush rear	Shape	Total height
90107000	94D 4x2 94G 4x2	6/14	Z	11,0	6	90	730	730	119			D11	84
90163000	94D 6x2/4 94L 6x2/4	3/24	L		3	90	450/ 220	425/ 105	10	R 46			78
90191000	94D 4x2 94D 6x2 94D 6x2/4 94G 4x2 94G 6x2 94G 6x4 94G 8x2 94G 8x4 94L 4x2 94L 6x2 94L 6x2/4 94L 6x4	1/47,1/44	L		2	100	707/ 221	410/ 70	120	30xR65		L1.2	97
90193000	94D 4x2 94D 6x2 94D 6x2/4 94G 4x2 94G 6x2 94G 6x4 94G 8x2 94G 8x4 94L 4x2 94L 6x2 94L 6x2/4 94L 6x4	1/47,1/44	L		2	100	707/ 291	410/ 70	120	30xR65		L1.1	97
90185000	94D 4x2 94D 6x2 94D 6x2/4 94G 4x2 94G 6x2 94G 6x4 94G 8x2 94G 8x4 94L 4x2 94L 6x2 94L 6x2/4 94L 6x4	1/47,1/44	L		2	100	707/292	405/70		R 64		L1.1	
90181000	94D 4x2 94D 6x2 94D 6x2/4 94G 4x2 94G 6x2 94G 6x4 94G 8x2 94G 8x4 94L 4x2 94L 6x2 94L 6x2/4 94L 6x4	1/47,1/44	L		2	100	707/222	405/70		R 64		L1.2	97
90187000	94D 4x2 94D 6x2 94D 6x2/4 94G 4x2 94G 6x2 94G 6x4 94G 8x2 94G 8x4 94L 4x2 94L 6x2 94L 6x2/4 94L 6x4	1/47,1/44	L		2	100	707/ 221	410/ 70	67	30xR65		L1.2	97

111

SCANIA

111

Artikel.Nr.	Fahrzeugtyp	Info		Achsl.	Blattzahl	Breite			Spr./ Kr.	Buchsen vorn	Buchsen hinten	Form	Paket- stärke
Art.-No.	Type			Axle Load	Leaves	Width	Lx/L1	Ly/L2	Free Arch/ Crank	Bush front	Bush rear	Shape	Total height
90060000	LB111 LB111S LBS111	3/20	V	6,5	3	90	850	850	166	R 36	R 36	A20	69
90112000	LB111 LB111S LBS111	3/24	V	7,0	3	90	850	850	155	R 36	R 36	A1	87
90080000	LB111 LBT111	9/13	V		9	90	850	850	165	R 36	R 36	A1	117
90092000	LB111 LBT111	10/13	V		10	90	850	850	175	R 36	R 36	A1	130
90069000	LB111 LB111S	3/21,2/21Pl.,2/21	H	11,0	5	90	760	760	137	R 46	R 46	A2	159
90085000	LB111 LB111S	3/21,2/21Pl.,2/21	H	11,0	5	90	760	760	159	R 46	R 46	A2	159
90083000	LB111 LB111S	3/25,2/20Pl.,2/25	H	13,0	5	90	890	890	177	R 46	R 46	A2	185
90087000	LB111 LB111S	3/25,2/20Pl.,2/25	H	13,0	5	90	890	890	177	R 46	R 46	A2	185
90061000	LB111 LB111S	3/21,2/10Pl.,3/17	H		6	90	760	760	104	R 46	R 46	A2	149
90029000	LBT111FB	7/15	H		7	90	620	780	105	R 46	R 46	A26	105
90027000	LBT111FB	7/15	H		7	90	780	620	105	R 46	R 46	A26	105
90037000	LBT111FB	8/15	H	9,0	8	90	620	780	120	R 46	R 46	A26	120
90035000	LBT111FB	8/15	H	9,0	8	90	780	620	120	105	R 46	A26	120
90051000	LB111	1/13,14/11	H		15	90	760	760	154	R 46	R 46	A1	167
90067000	LBS111	3/22	H		3	100	760	760	123	R 46	R 46	A20	74
90077000	LBS111	4/22	H	18	4	100	760	760	125	R 46	R 46	A20	97
90095000	LBT111BB	8/20	H	20	8	100	743	743	65			D11	160
90093000	LBT111BB	10/20	H	25	10	100	743	743	70			D11	200
90121000	LBT111BB	10/15	H		10	100	743	743	65			D11	150
90109000	LBS111	1/15,10/13	H	20,0	11	100	760	760	140	R 46	R 46	A1	145
90091000	LBT111BB	12/15	H	20	12	100	743	743	74			D11	180
90081000	LBS111	1/13,11/11	H	17	12	100	760	760	154	R 46	R 46	A1	134
90065000	LB111 LB111S		T		3	90	760	760	104	R 46	R 46	A20	72
90041000	LB111	1/13,10/11	T		11	90	760	760	170	R 46	R 46	A1	123
90123000	LB111	1/13:10/11	T		11	90	760	760	170	R 46	R 46	A1	123
90127000	LB111	15/11	T		15	90	760	760	154	R 46	R 46	A1	167
90129000	LB111	1/13+14/11	T		15	90	760	760	154	R 46	R 46	A1	167
90137000	LB111		T		17	90	760	760		R 46	R 46	A1	
90139000	LB111		T		17	90	760	760		R 46	R 46	A1	
90049000	LB111	9/10	Z		9	90	625	625	107	R 46	R 46	D1.1	90

Artikel.Nr.	Fahrzeugtyp	Info		Achsl.	Blattzahl	Breite	Lx/L1	Ly/L2	Spr./ Kr.	Buchsen vorn	Buchsen hinten	Form	Paket- stärke
Art.-No.	Type			Axle Load	Leaves	Width			Free Arch/ Crank	Bush front	Bush rear	Shape	Total height
90100000	G112M 6x2A P112M 6x2A R112M 6x2A T112M 6x2A	3/23	V	6,0	3	90	910	910	168	R 36	R 36	A20	75
90102000	G112M 4x2 G112M 4x2A G112M 6x2A P112H 4x2 P112H 6x2 P112M 4x2 P112M 4x2A P112M 6x2A P112MA 4x2 P112MA 4x2A P112MA 6x2A R112H 6x2 R112M 4x2 R112M 4x2A R112M 6x2A R112MA 4x2A T112H 4x2 T112H 6x2 T112M 4x2 T112M 4x2A T112M 6x2A	3/24	V	6,5	3	90	910	910	162	R 36	R 36	A20	78
90108000	G112H 4x2 G112H 6x2 G112M 4x2 G112M 6x2 P112H 4x2 P112H 6x2 P112M 4x2 P112M 6x2 R112H 4x2 R112H 6x2 R112M 4x2 R112M 6x2 T112H 4x2 T112H 6x2 T112M 4x2 T112M 6x2	3/26	V	7,0	3	90	910	910	159	R 36	R 36	A20	87
90116000	T112AM70	3/29	V	8,5	3	90	910	910	137	R 36	R 36	A20	96
90106000	G112M P112M R112M T112M	6/15+P/15	V	6,0	6	90	910	910	180	R 36	R 36	A26	105
90094000	P112M 4x2 P112M 6x4 P112MA 4x2 R112H 6x2 R112H 6x4 R112M 4x2 R112M 6x4	7/15	V	6,5	7	90	910	910	170	R 36	R 36	A26	105
90104000	P112E 6x4 P112H 4x2 P112H 6x2 P112H 6x2V R112E 6x4 R112H 6x2 R112H 6x4 T112E 6x4 T112H 4x2 T112H 6x2 T112H 6x4	8/15	V	7,0	8	90	910	910	175	R 36	R 36	A26	120
90038000	T112AM70	9/15	V	8,5	9	90	910	910	170	R 36	R 36	A26	135
90120000	G/P/R112H 6x2V G112H 8x2 G112H 8x4 P112H 8x2 P112H 8x4 R112H 8x2 R112H 8x4	9/13	V	2x6,5	9	90	910	715	155	R 36	R 36	A1	117

112

SCANIA

112

Artikel.Nr.	Fahrzeugtyp	Info		Achsl.	Blattzahl	Breite			Spr./ Kr.	Buchsen vorn	Buchsen hinten	Form	Paket- stärke
Art.-No.	Type			Axle Load	Leaves	Width	Lx/L1	Ly/L2	Free Arch/ Crank	Bush front	Bush rear	Shape	Total height
90122000	G112H 6x2V G112H 8x2 G112H 8x4 P112H 6x2V P112H 8x2 P112H 8x4 R112H 6x2V R112H 8x2 R112H 8x4	9/13	V	2x6,5	9	90	715	910	168	R 36	R 36	A1	117
90005000	G112M 6x4FB P112M 6x4FB R112M 6x4FB	5/15	H		5	90	780	620		R 46	R 46	A26	75
90007000	G112M 6x4FB P112M 6x4FB R112M 6x4FB	5/15	H		5	90	620	780		R 46	R 46	A26	75
90079000	G112H 4x2 G112M 4x2 G112MA 4x2 P112H 4x2 P112M 4x2 P112MA 4x2 R112H 4x2 R112M 4x2 R112MA 4x2 T112H 4x2 T112M 4x2 T112MA 4x2	3/26,2/30Pl.,2/26	H	13,0	5	90	890	890	156	R 46	R 46	A2	205
90101000	G112H 4x2 G112M 4x2 G112MA 4x2 P112H 4x2 P112M 4x2 P112MA 4x2 R112H 4x2 R112M 4x2 R112MA 4x2 T112H 4x2 T112M 4x2 T112MA 4x2	3/24,2/26,2/30	H	10,0	5	90	890	890	177	R 46	R 46	A2	199
90027000	G112M 6x4FB P112M 6x4FB R112M 6x4FB	7/15	H		7	90	780	620	107	R 46	R 46	A26	105
90029000	G112M 6x4FB P112M 6x4FB R112M 6x4FB	7/15	H		7	90	620	780	107	R 46	R 46	A26	105
90035000	G112M 6x4FB P112M 6x4FB R112M 6x4FB	8/15	H	9,0	8	90	780	620	105	R 46	R 46	A26	120
90037000	G112M 6x4FB P112M 6x4FB R112M 6x4FB	8/15	H H H	9,0	8	90	620	780	105	R 46	R 46	A26	120
90077000	G112H 6x2AD100 G112H 6x2 AD90 P112H 6x2AD100 P112H 6x2 AD90 R112H 6x2AD100 R112H 6x2 AD 90 T112H 6x2AD100 T112H 6x2 AD 90	4/22	H	18	4	100	760	760	125	R 46	R 46	A20	97
90095000	G112H 6x4BB G112H 8x4BB P112H 6x4BB P112H 8x4BB R112H 6x4BB R112H 8x4BB T112H 6x4BB T112H 8x4BB	8/20	H	20	8	100	743	743	65			D11	160
90093000	G112E 6x4BB P112E 6x4BB R112E 6x4BB T112E 6x4BB	10/20	H	25	10	100	743	743	70			D11	200

112

SCANIA

112

Artikel.Nr.	Fahrzeugtyp	Info		Achsl.	Blattzahl	Breite			Spr./ Kr.	Buchsen vorn	Buchsen hinten	Form	Paket- stärke
Art.-No.	Type			Axle Load	Leaves	Width	Lx/L1	Ly/L2	Free Arch/ Crank	Bush front	Bush rear	Shape	Total height
90121000	G112H 6x4BB G112H 8x4BB P112H 6x4BB P112H 8x4BB R112H 6x4BB R112H 8x4BB T112H 6x4BB T112H 8x4BB	10/15	H		10	100	743	743	65			D11	150
90109000	G112H 6x2AD100 G112H 6x2 AD90 G112H 8x2AD100 G112H 8x2 AD90 P112H 6x2AD100 P112H 6x2 AD90 P112H 8x2AD100 P112H 8x2 AD90 R112H 6x2AD100 R112H 6x2 AD 90 R112H 8x2AD100 R112H 8x2 AD 90 T112H 6x2AD100 T112H 6x2 AD 90 T112H 8x2AD100	1/15,10/13	H	20,0	11	100	760	760	140	R 46	R 46	A1	145
90091000	G112H 6x4BB G112H 8x4BB P112H 6x4BB P112H 8x4BB R112H 6x4BB R112H 8x4BB T112H 6x4BB T112H 8x4BB	12/15	H	20	12	100	743	743	74			D11	180
90119000	G112E 6x4BB P112E 6x4BB R112E 6x4BB T112E 6x4BB	12/20	H	2x14,5	12	100	743	743	65			D11	240
90039000	G112H 6x2AD100 G112H 6x2 AD90 G112H 8x2AD100 G112H 8x2 AD90 P112H 6x2AD100 P112H 6x2 AD90 P112H 8x2AD100 P112H 8x2 AD90 R112H 6x2AD100 R112H 6x2 AD 90 R112H 8x2AD100 R112H 8x2 AD 90 T112H 6x2AD100 T112H 6x2 AD 90 T112H 8x2AD100	1/13,11/11	H	8,5	12	100	760	760	164	R 46	R 46	A1	134
90081000	G112H 6x2AD100 G112H 6x2 AD90 P112H 6x2AD100 P112H 6x2 AD90 R112H 6x2AD100 R112H 6x2 AD 90 T112H 6x2AD100 T112H 6x2 AD 90	1/13,11/11	H	17	12	100	760	760	154	R 46	R 46	A1	134
90117000	G112M 4x2	5/17	T		5	90	890	890	135	R 46	R 46	A1	85
90097000	P112M 4x2 R112M 4x2 T112M 4x2	7/15	T	10,5	7	90	890	890	180	R 46	R 46	A26	105
90105000	G112H 4x2 G112H 6x2V P112H 4x2 P112H 6x2V R112H 4x2 R112H 6x2V T112H 4x2 T112H 6x2V	7/15	T	11,0	7	90	890	890	180	R 46	R 46	A26	105
90115000	G112H 4x2 P112H 4x2 R112H 4x2 T112H 4x2	9/15	T	13,0	9	90	890	890	185	R 46	R 46	A26	135

112

SCANIA

112

Artikel.Nr.	Fahrzeugtyp	Info		Achsl.	Blattzahl	Breite	Lx/L1	Ly/L2	Spr./ Kr.	Buchsen vorn	Buchsen hinten	Form	Paket- stärke
Art.-No.	Type			Axle Load	Leaves	Width			Free Arch/ Crank	Bush front	Bush rear	Shape	Total height
90125000	G112E 4x2 P112E 4x2 R112E 4x2 T112E 4x2	12/15	T	10,5	12	90	890	890	90 120 119	R 46	R 46	A1	180
90113000	G112M 4x2	5/15	Z		5	90	730	730				D1.1	75
90089000	P112M 4x2 R112M 4x2 T112M 4x2	6/13	Z		6	90	730	730				D11	78
90107000	G112H 4x2 G112H 6x2V G112M 4x2 P112H 4x2 P112H 6x2V P112M 4x2 R112H 4x2 R112H 6x2V R112M 4x2 T112H 4x2 T112H 6x2V T112M 4x2	6/14	Z	11,0	6	90	730	730				D11	84
90161000	P112M 4x2A P112M 6x2A P112MA 4x2A R112M 4x2A R112M 6x2A R112MA 4x2A	1/43,1/40	L	10,5	2	120	702/ 186	353/ 142	50	30xR65		L4	89
90111000	P112M 4x2A P112M 6x2A P112MA 4x2A R112M 4x2A R112M 6x2A R112MA 4x2A	2/40	L	10,5	2	120	705/ 185	345/ 140	43	30xR65		L4	86

113

SCANIA

113

Artikel.Nr.	Fahrzeugtyp	Info		Achsl.	Blattzahl	Breite	Lx/L1	Ly/L2	Spr./Kr.	Buchsen vorn	Buchsen hinten	Form	Paketstärke
Art.-No.	Type			Axle Load	Leaves	Width			Free Arch/Crank	Bush front	Bush rear	Shape	Total height
90124000	P113EL 4x2 P113EL 6x4 BB P113HL 4x2 P113HL 6x2 P113HL 6x4BB P113ML 4x2 R113EL 4x2 R113EL 6x4 BB R113HL 4x2 R113HL 6x2 R113HL 6x4BB T113EL 4x2 T113EL 6x4 BB T113HL 4x2 T113HL 6x2 T113HL 6x4BB	2/28	V		2	90	910	910	147	R 36	R 36	A1	62
90126000	P113EL 4x2 P113EL 6x4 BB P113HL 4x2 P113HL 6x2 P113HL 6x4BB P113ML 4x2 R113EL 4x2 R113EL 6x4 BB R113HL 4x2 R113HL 6x2 R113HL 6x4BB T113EL 4x2 T113EL 6x4 BB T113HL 4x2 T113HL 6x2 T113HL 6x4BB	2/30	V		2	90	910	910	133	R 36	R 36	A20	66
90128000	P113EL 4x2 P113EL 6x4 BB P113HL 4x2 P113HL 6x2 P113HL 6x4BB P113ML 4x2 R113EL 4x2 R113EL 6x4 BB R113HL 4x2 R113HL 6x2 R113HL 6x4BB T113EL 4x2 T113EL 6x4 BB T113HL 4x2 T113HL 6x2 T113HL 6x4BB	2/32	V	7,5	2	90	910	910	125	R 36	R 36	A20	70
90116000	P113EL 4x2 P113EL 6x4 BB P113HL 4x2 P113HL 6x2 P113HL 6x4BB P113ML 4x2 R113EL 4x2 R113EL 6x4 BB R113HL 4x2 R113HL 6x2 R113HL 6x4BB T113EL 4x2 T113EL 6x4 BB T113HL 4x2 T113HL 6x2 T113HL 6x4BB	3/29	V	8,5	3	90	910	910	137	R 36	R 36	A20	96
90130000	P113	4/22	V	2x6,5	4	90	715	910	130	R 36	R 36	A20	100
90132000	P113	4/22	V	2x6,5	4	90	910	715	130	R 36	R 36	A20	100

113

SCANIA

113

Artikel.Nr.	Fahrzeugtyp	Info		Achsl.	Blattzahl	Breite			Spr./ Kr.	Buchsen vorn	Buchsen hinten	Form	Paket- stärke
Art.-No.	Type			Axle Load	Leaves	Width	Lx/L1	Ly/L2	Free Arch/ Crank	Bush front	Bush rear	Shape	Total height
90106000	P113EL 4x2 P113EL 6x4 BB P113HL 4x2 P113HL 6x2 P113HL 6x4BB P113ML 4x2 R113EL 4x2 R113EL 6x4 BB R113HL 4x2 R113HL 6x2 R113HL 6x4BB T113EL 4x2 T113EL 6x4 BB T113HL 4x2 T113HL 6x2 T113HL 6x4BB	6/15+P/15	V	6,0	6	90	910	910	180	R 36	R 36	A26	105
90094000	P113EL 4x2 P113EL 6x4 BB P113HL 4x2 P113HL 6x2 P113HL 6x4BB P113ML 4x2 R113EL 4x2 R113EL 6x4 BB R113HL 4x2 R113HL 6x2 R113HL 6x4BB T113EL 4x2 T113EL 6x4 BB T113HL 4x2 T113HL 6x2 T113HL 6x4BB	7/15	V	6,5	7	90	910	910	170	R 36	R 36	A26	105
90104000	P113EL 4x2 P113EL 6x4 BB P113HL 4x2 P113HL 6x2 P113HL 6x4BB P113ML 4x2 R113EL 4x2 R113EL 6x4 BB R113HL 4x2 R113HL 6x2 R113HL 6x4BB T113EL 4x2 T113EL 6x4 BB T113HL 4x2 T113HL 6x2 T113HL 6x4BB	8/15	V	7,0	8	90	910	910	175	R 36	R 36	A26	120
90038000	P113EL 4x2 P113EL 6x4 BB P113HL 4x2 P113HL 6x2 P113HL 6x4BB P113ML 4x2 R113EL 4x2 R113EL 6x4 BB R113HL 4x2 R113HL 6x2 R113HL 6x4BB T113EL 4x2 T113EL 6x4 BB T113HL 4x2 T113HL 6x2 T113HL 6x4BB	9/15	V	8,5	9	90	910	910	170	R 36	R 36	A26	135
90120000	P113 8x2 P113 8x4 R113 8x2 R113 8x4 P113 8x2 P113 8x4 R113 8x2 R113 8x4	9/13	V	2x6,5	9	90	910	715	155	R 36	R 36	A1	117

Artikel.Nr.	Fahrzeugtyp	Info		Achsl.	Blattzahl	Breite	Lx/L1	Ly/L2	Spr./ Kr.	Buchsen vorn	Buchsen hinten	Form	Paket- stärke
Art.-No.	Type			Axle Load	Leaves	Width			Free Arch/ Crank	Bush front	Bush rear	Shape	Total height
90135000	P113HL 4x2 AD100 P113HL 4x2 AD90 P113HL6x2/4AD100 P113HL 6x2/4AD90 P113MA 4x2AD100 P113MA 4x2 AD90 P113MA 6x2/4AD100 P113MA 6x2/4 AD 90 P113ML 4x2 AD100 P113ML 4x2 AD90 P113ML 6x2/4 AD100 P113ML 6x2/4 AD90 R113HL 4x2 AD100 R113HL 4x2 AD90 R113HL 6x2/4 AD100 R113HL 6x2/4 AD100 R113HL 6x2/4 AD90 R113HL 6x2/4 AD90 R113MA 4x2 AD100 R113MA 4x2 AD90 R113MA 6x2/4 AD100 R113MA 6x2/4 AD90 R113ML 6x2/4 AD100 R113ML 6x2/4 AD90 T113HL 4x2 AD100 T113HL 4x2 AD90 T113HL 6x2/4 AD100 T113HL 6x2/4 AD90 T113MA 4x2 AD100 T113MA 4x2 AD90 T113ML 6x2/4 AD 100 T113ML 6x2/4 AD90	2/34,2/34Pl.,1/34	H		3	90	890	890	145	R 46	R 46	A2	179
90005000	P113ML 6x4FB R113ML 6x4FB	5/15	H		5	90	780	620		R 46	R 46	A26	75
90007000	P113ML 6x4FB R113ML 6x4FB	5/15	H		5	90	620	780		R 46	R 46	A26	75
90079000	P113HL 4x2 AD100 P113HL 4x2 AD90 P113HL 6x2/4 AD100 P113HL 6x2/4 AD90 P113MA 4x2 AD100 P113MA 4x2 AD90 P113MA 6x2/4 AD 100 P113MA 6x2/4 AD 90 P113ML 4x2 AD100 P113ML 4x2 AD90 P113ML 6x2/4 AD100 P113ML 6x2/4 AD90 R113HL 4x2 AD100 R113HL 4x2 AD90 R113HL 6x2/4 AD100 R113HL 6x2/4 AD100 R113HL 6x2/4 AD90 R113HL 6x2/4 AD90 R113MA 4x2 AD100 R113MA 4x2 AD90 R113MA 6x2/4 AD100 R113MA 6x2/4 AD90 R113ML 6x2/4 AD100 R113ML 6x2/4 AD90 T113HL 4x2 AD100 T113HL 4x2 AD90 T113HL 6x2/4 AD 100 T113HL 6x2/4 AD90 T113MA 4x2 AD100 T113MA 4x2 AD90 T113ML 6x2/4 AD100 T113ML 6x2/4 AD90	3/26,2/30Pl.,2/26	H	13,0	5	90	890	890	156	R 46	R 46	A2	205
90027000	P113ML 6x4FB R113ML 6x4FB	7/15	H		7	90	780	620	107	R 46	R 46	A26	105
90029000	P113ML 6x4FB R113ML 6x4FB	7/15	H		7	90	620	780	107	R 46	R 46	A26	105
90035000	P113ML 6x4FB R113ML 6x4FB	8/15	H	9,0	8	90	780	620	105	R 46	R 46	A26	120

113

SCANIA

113

Artikel.Nr.	Fahrzeugtyp	Info		Achsl.	Blattzahl	Breite			Spr./ Kr.	Buchsen vorn	Buchsen hinten	Form	Paket- stärke
Art.-No.	Type			Axle Load	Leaves	Width	Lx/L1	Ly/L2	Free Arch/ Crank	Bush front	Bush rear	Shape	Total height
90037000	P113ML 6x4FB R113ML 6x4FB	8/15	H	9,0	8	90	620	780	105	R 46	R 46	A26	120
90145000	P113ML 6x4FB R113ML 6x4FB	9/15	H		9	90	780	620	105	R 46	R 46	A26	135
90147000	P113ML 6x4FB R113ML 6x4FB	9/15	H		9	90	620	780	105	R 46	R 46	A26	135
90131000	P113HL 6x2 P113HL 8x2 P113ML 6x2 P113ML 8x2 R113H L8x2 R113HL 6x2 R113ML 8x2 T113HL 6x2 T113HL8x2 T113ML 8x2	4/23	H	20,0	4	100	760	760	130	R 46	R 46	A20	101
90141000	P113HL 6x2 P113HL 8x2 P113ML 6x2 P113ML 8x2 R113H L8x2 R113HL 6x2 R113ML 8x2 T113HL 6x2 T113HL8x2 T113ML 8x2	5/22	H		5	100	760	760	119	R 46	R 46	A20	121
90095000	P113HL AD90 6x4BB P113HL AD90 8x4BB R113HL AD90 6x4BB R113HL AD90 8x4BB T113HL AD90 6x4BB T113HL AD90 8x4BB	8/20	H	20	8	100	743	743	65			D11	160
90093000	P113EL AD100 6x4BB P113EL AD100 8x4BB P113HL AD100 6x4BB P113HL AD100 8x4BB R113EL AD100 6x4BB R113EL AD100 8x4BB R113HL AD100 6x4BB R113HL AD100 8x4BB T113EL AD100 6x4BB T113EL AD100 8x4BB T113HL AD100 6x4BB T113HL AD100 8x4BB	10/20	H	25	10	100	743	743	70			D11	200
90121000	P113HL AD90 6x4BB P113HL AD90 8x4BB R113HL AD90 6x4BB R113HL AD90 8x4BB T113HL AD90 6x4BB T113HL AD90 8x4BB	10/15	H		10	100	743	743	65			D11	150
90149000	P113ML 6x2 P113ML 8x2 R113ML 8x2 T113ML 8x2	10/13	H		10	100	760	760		R 46	R 46	A1	130
90109000	P113HL 6x2 AD100 P113HL 6x2 AD90 P113HL 8x2 AD100 P113HL 8x2 AD90 P113ML 6x2 AD100 P113ML 6x2 AD90 P113ML 8x2 AD100 P113ML 8x2 AD90 P113ML 8x2 AD90 R113HL 6x2 AD100 R113HL 6x2 AD90 R113HL 8x2 AD100 R113HL 8x2 AD90 R113ML 8x2 AD100 R113ML 8x2 AD90 T113HL 6x2 AD100 T113HL 6x2 AD90 T113HL 8x2 AD100 T113HL 8x2 AD90 T113ML 8x2 AD100 T113ML 8x2 AD90	1/15,10/13	H	20,0	11	100	760	760	140	R 46	R 46	A1	145

Artikel.Nr.	Fahrzeugtyp	Info		Achsl.	Blattzahl	Breite	Lx/L1	Ly/L2	Spr./ Kr.	Buchsen vorn	Buchsen hinten	Form	Paket- stärke
Art.-No.	Type			Axle Load	Leaves	Width			Free Arch/ Crank	Bush front	Bush rear	Shape	Total height
90039000	P113HL 6x2 AD100 P113HL 6x2 AD90 P113HL 8x2 AD100 P113HL 8x2 AD90 P113ML 6x2 AD100 P113ML 6x2 AD90 P113ML 8x2 AD100 P113ML 8x2 AD90 R113HL 6x2 AD100 R113HL 6x2 AD90 R113HL 8x2 AD100 R113HL 8x2 AD90 R113ML 6x2 AD90 R113ML 8x2 AD100 R113ML 8x2 AD90 T113HL 6x2 AD100 T113HL 6x2 AD90 T113HL 8x2 AD100 T113HL 8x2 AD90 T113ML 6x2 AD90 T113ML 8x2 AD100 T113ML 8x2 AD90	1/13,11/11	H	8,5	12	100	760	760	164	R 46	R 46	A1	134
90081000	P113HL 6x2 AD100 P113HL 6x2 AD90 P113HL 8x2 AD100 P113HL 8x2 AD90 P113ML 6x2 AD100 P113ML 6x2 AD90 P113ML 8x2 AD100 P113ML 8x2 AD90 R113HL 6x2 AD100 R113HL 6x2 AD90 R113HL 8x2 AD100 R113HL 8x2 AD90 R113ML 6x2 AD90 R113ML 8x2 AD100 R113ML 8x2 AD90 T113HL 6x2 AD100 T113HL 6x2 AD90 T113HL 8x2 AD100 T113HL 8x2 AD90 T113ML 6x2 AD90 T113ML 8x2 AD100 T113ML 8x2 AD90	1/13,11/11	H	17	12	100	760	760	154	R 46	R 46	A1	134
90091000	P113HL AD90 6x4BB P113HL AD90 8x4BB R113HL AD90 6x4BB R113HL AD90 8x4BB T113HL AD90 6x4BB T113HL AD90 8x4BB	12/15	H	20	12	100	743	743	74			D11	180
90119000	P113EL AD100 6x4BB P113EL AD100 8x4BB P113HL AD100 6x4BB P113HL AD100 8x4BB R113EL AD100 6x4BB R113EL AD100 8x4BB R113HL AD100 6x4BB R113HL AD100 8x4BB T113EL AD100 6x4BB T113EL AD100 8x4BB T113HL AD100 6x4BB T113HL AD100 8x4BB	12/20	H	2x14,5	12	100	743	743	65			D11	240
90105000	P113HL 4x2 P113HL 6x2/4 P113MA 4x2 P113MA 6x2/4 P113ML 4x2 P113ML 6x2/4 R113HL 4x2 R113HL 6x2/4 R113HL 6x2/4 R113MA 4x2 R113MA 6x2/4 R113ML 6x2/4 T113HL 4x2 T113HL/MA 6x2/4 T113MA 4x2	7/15	T	11,0	7	90	890	890	180	R 46	R 46	A26	105

113

SCANIA

113

Artikel.Nr.	Fahrzeugtyp	Info		Achsl.	Blattzahl	Breite			Spr./ Kr.	Buchsen vorn	Buchsen hinten	Form	Paket- stärke
Art.-No.	Type			Axle Load	Leaves	Width	Lx/L1	Ly/L2	Free Arch/ Crank	Bush front	Bush rear	Shape	Total height
90115000	P113HL 4x2 P113HL 6x2/4 P113MA 4x2 P113MA 6x2/4 P113ML 4x2 P113ML 6x2/4 R113HL 4x2 R113HL 6x2/4 R113HL 6x2/4 R113MA 4x2 R113MA 6x2/4 R113ML 6x2/4 T113HL 4x2 T113HL 6x2/4 T113MA 4x2 T113ML 6x2/4	9/15	T	13,0	9	90	890	890	185	R 46	R 46	A26	135
90125000	P113EL 4x2 P113EL 6x2/4 R113EL 4x2 R113EL 6x2/4 T113EL 4x2 T113EL 6x2/4	12/15	T		12	90	890	890		R 46	R 46	A1	180
90107000	P113EL 4x2 P113EL 6x2/4 P113HL 4x2 P113HL 6x2/4 P113MA 4x2 P113MA 6x2/4 P113ML 4x2 P113ML 6x2/4 R113EL 4x2 R113EL 6x2/4 R113HL 4x2 R113HL 6x2/4 R113HL 6x2/4 R113MA 4x2 R113MA 6x2/4 R113ML 6x2/4 T113EL 4x2 T113EL 6x2/4 T113HL 4x2 T113HL 6x2/4 T113MA 4x2 T113ML 6x2/4	6/14	Z	11,0	6	90	730	730	119			D11	84
90151000	P113M 6x2/4		L		2	90	450	415		R 46		L11.4	
90153000	P113ML 6x2A ASA70 R113ML 6x2A ASA70	2/42	L		2	100	690	260	-42	30		L16.1	90
90159000	P113ML 6x2B R113ML 6x2B	1/47,1/44	L		2	100	690	260	50	30xR65		L1	97
90111000	P113	2/40	L	10,5	2	120	705	345	43	30xR65		L4	86
90133000	P113MA 4x2A P113ML 4x2A P113ML 6x2A ASA70 R113MA 4x2A R113ML 6x2A ASA70 T113MA 4x2A	2/40	L		2	120	705	345	-55	30xR65		L4	86
90157000	P113MA 4x2A P113ML 4x2A P113ML 6x2A ASA70 R113MA 4x2A T113MA 4x2A	1/43,1/40	L		2	120	704	353	60	30xR65		L4	89
90161000	P113	1/43,1/40	L	10,5	2	120	702	353	50	30xR65		L4	89

Artikel.Nr.	Fahrzeugtyp	Info		Achsl.	Blattzahl	Breite			Spr./ Kr.	Buchsen vorn	Buchsen hinten	Form	Paket- stärke
Art.-No.	Type			Axle Load	Leaves	Width	Lx/L1	Ly/L2	Free Arch/ Crank	Bush front	Bush rear	Shape	Total height
90126000	114G 4x2 114G 6x2 114G 6x4 114G 8x2 114G 8x4 114L 4x2 114L 6x2 114L 6x2/4 114L 6x4	2/30	V		2	90	910	910	133	R 36	R 36	A20	66
90128000	114G 4x2 114G 6x2 114G 6x4 114G 8x2 114G 8x4 114L 4x2 114L 6x2 114L 6x2/4 114L 6x4	2/32	V	7,5	2	90	910	910	125	R 36	R 36	A20	70
90116000	114G 4x2 114G 6x2 114G 6x4 114G 8x2 114G 8x4 114L 4x2 114L 6x2 114L 6x2/4 114L 6x4	3/29	V	8,5	3	90	910	910	137	R 36	R 36	A20	96
90094000	114G 4x2 114G 6x2 114G 6x4 114G 8x4 114L 4x2 114L 6x2 114L 6x2/4 114L 6x4	7/15	V	6,5	7	90	910	910	170	R 36	R 36	A26	105
90038000	114G 4x2 114G 6x2 114G 6x4 114G 8x4 114L 4x2 114L 6x2 114L 6x2/4 114L 6x4	9/15	V	8,5	9	90	910	910	170	R 36	R 36	A26	135
90171000	114G 6x4 114G 8x4	4/30	H		4	90	770	770				D6	128
90173000	114G 6x4 114G 8x4	4/41	H		4	90	770	770	56			D6	172
90175000	114G 6x4 114G 8x4	4/41	H		4	90	770	770	83			D6	172
90079000	114G 4x2	3/26,2/30Pl.,2/26	H	13,0	5	90	890	890	156	R 46	R 46	A2	205
90141000	114G 6x2 114G 8x2	5/22	H		5	100	760	760	119	R 46	R 46	A20	121
90109000	114G 6x2 114G 8x2	1/15,10/13	H	20,0	11	100	760	760	140	R 46	R 46	A1	145
90105000	114G 4x2	7/15	T	11,0	7	90	890	890	180	R 46	R 46	A26	105
90115000	114G 4x2	9/15	T	13,0	9	90	890	890	185	R 46	R 46	A26	135
90107000	114G 4x2	6/14	Z	11,0	6	90	730	730	119			D11	84
90163000	114L 6x2/4	3/24	L		3	90	450	425	10	R 46			78
90181000	114G 4x2 114G 6x2 114G 6x4 114G 8x2 114G 8x4 114L 4x2 114L 6x2 114L 6x2/4 114L 6x4	1/47,1/44	L		2	100	707	405		R 64		L1.2	97

114

SCANIA

114

Artikel.Nr.	Fahrzeugtyp	Info		Achsl.	Blattzahl	Breite			Spr./ Kr.	Buchsen vorn	Buchsen hinten	Form	Paket- stärke
Art.-No.	Type			Axle Load	Leaves	Width	Lx/L1	Ly/L2	Free Arch/ Crank	Bush front	Bush rear	Shape	Total height
90185000	114G 4x2 114G 6x2 114G 6x4 114G 8x2 114G 8x4 114L 4x2 114L 6x2 114L 6x2/4 114L 6x4	1/47,1/44	L		2	100	707	405		R 64		L1.1	
90187000	114G 4x2 114G 6x2 114G 6x4 114G 8x2 114G 8x4 114L 4x2 114L 6x2 114L 6x2/4 114L 6x4	1/47,1/44	L		2	100	707/ 221	410/ 70	67	30xR65		L1.2	97
90189000	114G 4x2 114G 6x2 114G 6x4 114G 8x2 114G 8x4 114L 4x2 114L 6x2 114L 6x2/4 114L 6x4	1/47,1/44	L		2	100	707/ 291	410/ 70	67	30xR65		L1.1	97
90191000	114G 4x2 114G 6x2 114G 6x4 114G 8x2 114G 8x4 114L 4x2 114L 6x2 114L 6x2/4 114L 6x4	1/47,1/44	L		2	100	707/ 221	410/70	120	30xR65		L1.2	97
90193000	114G 4x2 114G 6x2 114G 6x4 114G 8x2 114G 8x4 114L 4x2 114L 6x2 114L 6x2/4 114L 6x4	1/47,1/44	L		2	100	707/ 291	410/ 70	120	30xR65		L1.1	97

Artikel.Nr.	Fahrzeugtyp	Info		Achsl.	Blattzahl	Breite	Lx/L1	Ly/L2	Spr./ Kr.	Buchsen vorn	Buchsen hinten	Form	Paket- stärke
Art.-No.	Type			Axle Load	Leaves	Width			Free Arch/ Crank	Bush front	Bush rear	Shape	Total height
90128000	124L 4x2 124L 6x2	2/32	V	7,5	2	90	910	910	125	R 36	R 36	A20	70
90116000	124L 4x2 124L 6x2	3/29	V	8,5	3	90	910	910	137	R 36	R 36	A20	96
90138000	124L 4x2 124L 6x2	4/28	V		4	90	910	910	116	R 36	R 36	A20	122
90159000	124L 4x2 124L 6x2	1/47,1/44	L		2	100	690	260	50	30xR65		L1	97



Artikel.Nr.	Fahrzeugtyp	Info		Achsl.	Blattzahl	Breite	Lx/L1	Ly/L2	Spr./ Kr.	Buchsen vorn	Buchsen hinten	Form	Paket- stärke
Art.-No.	Type			Axle Load	Leaves	Width			Free Arch/ Crank	Bush front	Bush rear	Shape	Total height
90100000	R142M 6x2A R142MA 4x2A	3/23	V	6,0	3	90	910	910	168	R 36	R 36	A20	75
90102000	R142H 4x2 R142H 6x2 R142M 4x2 R142M 4x2A R142M 6x2A R142MA 4x2 R142MA 4x2A T142H 4x2 T142H 6x2 T142M 4x2 T142M 4x2A T142M 6x2A T142MA 4x2 T142MA 4x2A	3/24	V	6,5	3	90	910	910	162	R 36	R 36	A20	78
90108000	R142H 6x2 T142H 6x2	3/26	V	7,0	3	90	910	910	159	R 36	R 36	A20	87
90106000	R142M R142MA	6/15+P/15	V	6,0	6	90	910	910	180	R 36	R 36	A26	105
90094000	R142H 4x2 R142H 6x2 R142H 6x4 R142M 4x2 R142M 6x2 R142M 6x4 R142MA 4x2 R142MA 6x2 T142H 4x2 T142H 6x2 T142H 6x4 T142M 4x2 T142M 6x2 T142M 6x4 T142MA 4x2 T142MA 6x2	7/15	V	6,5	7	90	910	910	170	R 36	R 36	A26	105
90104000	R142E 6x4 R142H 4x2 R142H 6x2 R142H 6x4 T142E 6x4 T142H 4x2 T142H 6x2 T142H 6x4	8/15	V	7,0	8	90	910	910	175	R 36	R 36	A26	120
90038000	R142 AM70 T142 AM70	9/15	V	8,5	9	90	910	910	170	R 36	R 36	A26	135
90005000	R142M 6x4FB	5/15	H		5	90	780	620		R 46	R 46	A26	75
90007000	R142M 6x4FB	5/15	H		5	90	620	780		R 46	R 46	A26	75
90079000	R142H/MA 4x2 T142H/MA 4x2	3/26,2/30Pl.,2/26	H	13,0	5	90	890	890	156	R 46	R 46	A2	205
90101000	R142H/M 4x2	3/24,2/26,2/30	H	10,0	5	90	890	890	177	R 46	R 46	A2	199
90027000	R142M 6x4FB	7/15	H		7	90	780	620	107	R 46	R 46	A26	105
90029000	R142M 6x4FB	7/15	H		7	90	620	780	107	R 46	R 46	A26	105
90035000	R142M 6x4FB	8/15	H	9,0	8	90	780	620	105	R 46	R 46	A26	120
90037000	R142M 6x4FB	8/15	H	9,0	8	90	620	780	105	R 46	R 46	A26	120
90077000	R142H 6x2 AD100 R142H 6x2 AD90 R142M 6x2 AD100 R142M 6x2 AD90 T142H 6x2 AD100 T142H 6x2 AD90 T142M 6x2 AD 100 T142M 6x2 AD 90	4/22	H	18	4	100	760	760	125	R 46	R 46	A20	97
90095000	R142H 6x4BB R142H 8x4BB T142H 6x4BB T142H 8x4BB	8/20	H	20	8	100	743	743	65			D11	160
90093000	R142H 6x4BB R142H 8x4BB T142H 6x4BB T142H 8x4BB	10/20	H	25	10	100	743	743	70			D11	200

Artikel.Nr.	Fahrzeugtyp	Info		Achsl.	Blattzahl	Breite			Spr./ Kr.	Buchsen vorn	Buchsen hinten	Form	Paket- stärke
Art.-No.	Type			Axle Load	Leaves	Width	Lx/L1	Ly/L2	Free Arch/ Crank	Bush front	Bush rear	Shape	Total height
90121000	R142H 6x4BB R142H 8x4BB T142H 6x4BB T142H 8x4BB	10/15	H		10	100	743	743	65			D11	150
90149000	R142M 6x2 HJB28	10/13	H		10	100	760	760		R 46	R 46	A1	130
90109000	R142H 6x2 AD100 R142H 6x2 AD90 T142H 6x2 AD100 T142H 6x2 AD90	1/15,10/13	H	20,0	11	100	760	760	140	R 46	R 46	A1	145
90039000	R142H 6x2 AD100 R142H 6x2 AD90 T142H 6x2 AD100 T142H 6x2 AD90	1/13,11/11	H	8,5	12	100	760	760	164	R 46	R 46	A1	134
90091000	R142H 6x4BB R142H 8x4BB T142H 6x4BB T142H 8x4BB	12/15	H	20	12	100	743	743	74			D11	180
90119000	R142E 6x4BB R142E 8x4BB T142E 6x4BB T142E 8x4BB	12/20	H	2x14,5	12	100	743	743	65			D11	240
90097000	R142M 4x2 R142M 6x2/4HST R142MA 4x2 R142MA 6x2/4HST	7/15	T	10,5	7	90	890	890	180	R 46	R 46	A26	105
90105000	R142H 4x2 R142H 6x2/4HST R142M 4x2 R142M 6x2/4HST R142MA 4x2 R142MA 6x2/4HST T142H 4x2 T142H 6x2/4HST T142M 4x2 T142M 6x2/4HST T142MA 4x2 T142MA 6x2/4HST	7/15	T	11,0	7	90	890	890	180	R 46	R 46	A26	105
90115000	R142H 4x2 R142H 6x2/4HST R142M 4x2 R142M 6x2/4HST R142MA 4x2 R142MA 6x2/4HST T142H 4x2 T142H 6x2/4HST T142M 4x2 T142M 6x2/4HST T142MA 4x2 T142MA 6x2/4HST	9/15	T	13,0	9	90	890	890	185	R 46	R 46	A26	135
90089000	R142M 4x2 R142M 6x2/4HST R142MA 4x2 R142MA 6x2/4HST	6/13	Z	10,5	6	90	730	730	120			D11	78
90107000	R142H 4x2 R142H 6x2/4HST R142M 4x2 R142M 6x2/4HST R142MA 4x2 R142MA 6x2/4HST T142H 4x2 T142H 6x2/4HST T142M 4x2 T142M 6x2/4HST T142MA 4x2 T142MA 6x2/4HST	6/14	Z	11,0	6	90	730	730	119			D11	84
90151000	R142MA 6x2/4HST ARA 5		L		2	90	450	415		R 46		L11.4	
90153000	R142M 6x2 ASA70	2/42	L		2	100	690	260	-42	30		L16.1	90
90111000	R142M 4x2 R142M 6x2 ASA60 R142MA 4x2	2/40	L	10,5	2	120	705/ 185	345/ 140	43	30xR65		L4	86

142**SCANIA****142**

Artikel.Nr.	Fahrzeugtyp	Info		Achsl.	Blattzahl	Breite	Lx/L1	Ly/L2	Spr./ Kr.	Buchsen vorn	Buchsen hinten	Form	Paket- stärke
Art.-No.	Type			Axle Load	Leaves	Width			Free Arch/ Crank	Bush front	Bush rear	Shape	Total height
90133000	R142M 4x2 R142M 6x2 R142MA 4x2	2/40	L	10,5	2	120	705/ 186	345/ 142	-55	30x65		L4	86
90157000	R142M 4x2 R142M 6x2 ASA 60 R142M 6x2 ASA70 R142MA 4x2	1/43,1/40	L		2	120	704/ 186	353/ 142	60	30x65		L4	89
90161000	R142M 4x2 R142M 6x2 ASA60 R142MA 4x2	1/43,1/40	L		2	120	702/ 186	353/ 142	50	30x65		L4	89

143

SCANIA

143

Artikel.Nr.	Fahrzeugtyp	Info		Achsl.	Blattzahl	Breite	Lx/L1	Ly/L2	Spr./ Kr.	Buchsen vorn	Buchsen hinten	Form	Paket- stärke
Art.-No.	Type			Axle Load	Leaves	Width			Free Arch/ Crank	Bush front	Bush rear	Shape	Total height
90124000	R143EL 6x4 R143HL 4x2 R143HL 6x2 R143HL 6x4 R143MA 6x2/4 R143ML 4x2 R143ML 6x2 R143ML 6x4 R143ML 6x4BB R143ML 6x4FB T143EL 6x4 T143HL 4x2 T143HL 6x2 T143HL 6x4 T143MA 4x2 T143MA 6x2/4 T143ML 4x2 T143ML 6x2 T143ML 6x4 T143ML 6x4BB T143ML 6x4FB	2/28	V		2	90	910	910	147	R 36	R 36	A1	62
90126000	R143EL 6x4 R143HL 4x2 R143HL 6x2 R143HL 6x4 R143MA 6x2/4 R143ML 4x2 R143ML 6x2 R143ML 6x4 R143ML 6x4BB R143ML 6x4FB T143EL 6x4 T143HL 4x2 T143HL 6x2 T143HL 6x4 T143MA 4x2 T143MA 6x2/4 T143ML 4x2 T143ML 6x2 T143ML 6x4 T143ML 6x4BB T143ML 6x4FB	2/30	V		2	90	910	910	133	R 36	R 36	A20	66
90128000	R143EL 6x4 R143HL 4x2 R143HL 6x2 R143HL 6x4 R143MA 6x2/4 R143ML 4x2 R143ML 6x2 R143ML 6x4 R143ML 6x4BB R143ML 6x4FB T143EL 6x4 T143HL 4x2 T143HL 6x2 T143HL 6x4 T143MA 4x2 T143MA 6x2/4 T143ML 4x2 T143ML 6x2 T143ML 6x4 T143ML 6x4BB T143ML 6x4FB	2/32	V	7,5	2	90	910	910	125	R 36	R 36	A20	70

143

SCANIA

143

Artikel.Nr.	Fahrzeugtyp	Info		Achsl.	Blattzahl	Breite	Lx/L1	Ly/L2	Spr./ Kr.	Buchsen vorn	Buchsen hinten	Form	Paket- stärke
Art.-No.	Type			Axle Load	Leaves	Width			Free Arch/ Crank	Bush front	Bush rear	Shape	Total height
90116000	R143EL 6x4 R143HL 4x2 R143HL 6x2 R143HL 6x4 R143MA 6x2/4 R143ML 4x2 R143ML 6x2 R143ML 6x4 R143ML 6x4BB R143ML 6x4FB T143EL 6x4 T143HL 4x2 T143HL 6x2 T143HL 6x4 T143MA 4x2 T143MA 6x2/4 T143ML 4x2 T143ML 6x2 T143ML 6x4 T143ML 6x4BB T143ML 6x4FB	3/29	V	8,5	3	90	910	910	137	R 36	R 36	A20	96
90130000	R143EL 8x4 R143HL 8x2	4/22	V	2x6,5	4	90	715	910	130	R 36	R 36	A20	100
90132000	R143EL 8x4 R143HL 8x2	4/22	V	2x6,5	4	90	910	715	130	R 36	R 36	A20	100
90106000	R143EL 6x4 R143HL 4x2 R143HL 6x2 R143HL 6x4 R143MA 6x2/4 R143ML 4x2 R143ML 6x2 R143ML 6x4 R143ML 6x4BB R143ML 6x4FB	6/15+P/15	V	6,0	6	90	910	910	180	R 36	R 36	A26	105
90094000	R143EL 6x4 R143HL 4x2 R143HL 6x2 R143HL 6x4 R143MA 6x2/4 R143ML 4x2 R143ML 6x2 R143ML 6x4 R143ML 6x4BB R143ML 6x4FB T143EL 6x4 T143HL 4x2 T143HL 6x2 T143HL 6x4 T143MA 4x2 T143MA 6x2/4 T143ML 4x2 T143ML 6x2 T143ML 6x4 T143ML 6x4BB T143ML 6x4FB	7/15	V	6,5	7	90	910	910	170	R 36	R 36	A26	105

Artikel.Nr.	Fahrzeugtyp	Info		Achsl.	Blattzahl	Breite			Spr./ Kr.	Buchsen vorn	Buchsen hinten	Form	Paket- stärke
Art.-No.	Type			Axle Load	Leaves	Width	Lx/L1	Ly/L2	Free Arch/ Crank	Bush front	Bush rear	Shape	Total height
90104000	R143EL 6x4 R143HL 4x2 R143HL 6x2 R143HL 6x4 R143MA 6x2/4 R143ML 4x2 R143ML 6x2 R143ML 6x4 R143ML 6x4BB R143ML 6x4FB T143EL 6x4 T143HL 4x2 T143HL 6x2 T143HL 6x4 T143MA 4x2 T143MA 6x2/4 T143ML 4x2 T143ML 6x2 T143ML 6x4 T143ML 6x4BB T143ML 6x4FB	8/15	V	7,0	8	90	910	910	175	R 36	R 36	A26	120
90038000	R143EL 6x4 R143HL 4x2 R143HL 6x2 R143HL 6x4 R143MA 6x2/4 R143ML 4x2 R143ML 6x2 R143ML 6x4 R143ML 6x4BB R143ML 6x4FB T143EL 6x4 T143HL 4x2 T143HL 6x2 T143HL 6x4 T143MA 4x2 T143MA 6x2/4 T143ML 4x2 T143ML 6x2 T143ML 6x4 T143ML 6x4BB T143ML 6x4FB	9/15	V	8,5	9	90	910	910	170	R 36	R 36	A26	135
90120000	R143HL 8x2 R143HL 8x2	9/13	V	2x6,5	9	90	910	715	155	R 36	R 36	A1	117
90135000	R143HL 4x2 R143MA 6x2/4 R143ML 4x2 T143HL 4x2 T143MA 6x2/4 T143ML 4x2	2/34,2/34Pl.,1/34	H		3	90	890	890	145	R 46	R 46	A2	179
90171000	R143HL 6x4BB R143ML 6x4BB	4/30	H		4	90	770	770				D6	128
90173000	R143HL 6x4BB R143ML 6x4BB	4/41	H		4	90	770	770	56			D6	172
90175000	R143HL 6x4BB R143ML 6x4BB	4/41	H		4	90	770	770	83			D6	172
90005000	R143ML 6x4FB	5/15	H		5	90	780	620		R 46	R 46	A26	75
90007000	R143ML 6x4FB	5/15	H		5	90	620	780		R 46	R 46	A26	75
90079000	R143HL 4x2 R143MA 6x2/4 R143ML 4x2 T143HL 4x2 T143MA 6x2/4 T143ML 4x2	3/26,2/30Pl.,2/26	H	13,0	5	90	890	890	156	R 46	R 46	A2	205
90027000	R143ML 6x4FB	7/15	H		7	90	780	620	107	R 46	R 46	A26	105
90029000	R143ML 6x4FB	7/15	H		7	90	620	780	107	R 46	R 46	A26	105
90035000	R143ML 6x4FB	8/15	H	9,0	8	90	780	620	105	R 46	R 46	A26	120
90037000	R143ML 6x4FB	8/15	H	9,0	8	90	620	780	105	R 46	R 46	A26	120
90145000	R143ML 6x4FB	9/15	H		9	90	780	620	105	R 46	R 46	A26	135
90147000	R143ML 6x4FB	9/15	H		9	90	620	780	105	R 46	R 46	A26	135

143

SCANIA

143

Artikel.Nr.	Fahrzeugtyp	Info		Achsl.	Blattzahl	Breite			Spr./ Kr.	Buchsen vorn	Buchsen hinten	Form	Paket- stärke
Art.-No.	Type			Axle Load	Leaves	Width	Lx/L1	Ly/L2	Free Arch/ Crank	Bush front	Bush rear	Shape	Total height
90131000	R143HL 6x2 R143HL 8x2 R143ML 6x2 R143ML 8x2 T143HL 6x2 T143HL 8x2 T143ML 6x2 T143ML 8x2	4/23	H	20,0	4	100	760	760	130	R 46	R 46	A20	101
90141000	R143HL 6x2 R143HL 8x2 R143ML 6x2 R143ML 8x2 T143HL 6x2 T143HL 8x2 T143ML 6x2 T143ML 8x2	5/22	H		5	100	760	760	119	R 46	R 46	A20	121
90095000	R143HL 6x4BB T143HL 6x4BB	8/20	H	20	8	100	743	743	65			D11	160
90093000	R143EL 6x4BB R143EL 8x4 R143HL 6x4BB T143EL 6x4BB T143EL 8x4 T143HL 6x4BB	10/20	H	25	10	100	743	743	70			D11	200
90121000	R143HL 6x4BB T143HL 6x4BB	10/15	H		10	100	743	743	65			D11	150
90149000	R143ML 6x2 R143ML 8x2	10/13	H		10	100	760	760		R 46	R 46	A1	130
90109000	R143HL 6x2 R143HL 8x2 R143ML 6x2 R143ML 8x2 T143HL 6x2 T143HL 8x2 T143ML 6x2 T143ML 8x2	1/15,10/13	H	20,0	11	100	760	760	140	R 46	R 46	A1	145
90039000	R143HL 6x2 R143HL 8x2 R143ML 6x2 R143ML 8x2 T143HL 6x2 T143HL 8x2 T143ML 6x2 T143ML 8x2	1/13,11/11	H	8,5	12	100	760	760	164	R 46	R 46	A1	134
90081000	R143HL 6x2 R143HL 8x2 R143ML 6x2 R143ML 8x2 T143HL 6x2 T143HL 8x2 T143ML 6x2 T143ML 8x2	1/13,11/11	H	17	12	100	760	760	154	R 46	R 46	A1	134
90091000	R143HL 6x4BB T143HL 6x4BB	12/15	H	20	12	100	743	743	74			D11	180
90119000	R143EL 6x4BB R143EL 8x4 R143HL 6x4BB T143EL 6x4BB T143EL 8x4 T143HL 6x4BB	12/20	H	2x14,5	12	100	743	743	65			D11	240
90105000	R143HL 4x2 R143HL 6x2/4 R143ML 4x2 R143ML 6x2/4 T143HL 4x2 T143HL 6x2/4 T143MA 4x2 T143ML 4x2 T143ML 6x2/4	7/15	T	11,0	7	90	890	890	180	R 46	R 46	A26	105

143

SCANIA

143

Artikel.Nr.	Fahrzeugtyp	Info		Achsl.	Blattzahl	Breite	Lx/L1	Ly/L2	Spr./ Kr.	Buchsen vorn	Buchsen hinten	Form	Paket- stärke
Art.-No.	Type			Axle Load	Leaves	Width			Free Arch/ Crank	Bush front	Bush rear	Shape	Total height
90115000	R143HL 4x2 R143HL 6x2/4 R143ML 4x2 R143ML 6x2/4 T143HL 4x2 T143HL 6x2/4 T143MA 4x2 T143ML 4x2 T143ML 6x2/4	9/15	T	13,0	9	90	890	890	185	R 46	R 46	A26	135
90107000	R/T143HL 4x2 R/T143HL 6x2/4 R/T143MA 6x2/4 R/T143ML 4x2 R/T143ML 6x2/4 T143MA 4x2	6/14	Z	11,0	6	90	730	730	119			D11	84
90151000	R143MA 6x2/4		L		2	90	450	415		R 46		L11.4	
90163000	R143MA 6x2/4	3/24	L		3	90	450/ 220	425/ 105	10	R 46			78
90153000	R143ML 6x2A	2/42	L		2	100	690	260	-42	30		L16.1	90
90159000	R143HL 6x2 R143HL 6x4 R143HL 8x2 R143ML 4x2 R143ML 6x4	1/47,1/44	L		2	100	690/ 190	260/ 50	50	30xR65		L1	97
90133000	R143HL 4x2A R143MA 6x2/4 R143ML 4x2A R143ML 6x2A ASA 70	2/40	L		2	120	705/ 186	345/ 142	-55	30xR65		L4	86
90157000	R143HL 4x2A R143MA 6x2/4 R143ML 4x2A R143ML 6x2A ASA 70	1/43,1/40	L		2	120	704/ 186	353/ 142	60	30xR65		L4	89

Artikel.Nr.	Fahrzeugtyp	Info		Achsl.	Blattzahl	Breite			Spr./ Kr.	Buchsen vorn	Buchsen hinten	Form	Paket- stärke
Art.-No.	Type			Axle Load	Leaves	Width	Lx/L1	Ly/L2	Free Arch/ Crank	Bush front	Bush rear	Shape	Total height
90126000	R144G 4x2 R144G 6x2 R144G 6x4 R144G 8x2	2/30	V		2	90	910	910	133	R 36	R 36	A20	66
90128000	R144G 4x2 R144G 6x2 R144G 6x4 R144G 8x2 R144L 4x2 R144L 6x2 R144L 6x2/4	2/32	V	7,5	2	90	910	910	125	R 36	R 36	A20	70
90116000	R144G 4x2 R144G 6x2 R144G 6x4 R144G 8x2 R144L 4x2 R144L 6x2 R144L 6x2/4	3/29	V	8,5	3	90	910	910	137	R 36	R 36	A20	96
90094000	R144G 4x2 R144G 6x2 R144G 6x4	7/15	V	6,5	7	90	910	910	170	R 36	R 36	A26	105
90038000	R144G 4x2 R144G 6x2 R144G 6x4	9/15	V	8,5	9	90	910	910	170	R 36	R 36	A26	135
90171000	R144G 6x4	4/30	H		4	90	770	770				D6	128
90173000	R144G 6x4	4/41	H		4	90	770	770	56			D6	172
90175000	R144G 6x4	4/41	H		4	90	770	770	83			D6	172
90079000	R144G 4x2	3/26,2/30Pl.,2/26	H	13,0	5	90	890	890	156	R 46	R 46	A2	205
90141000	R144G 6x2 R144G 8x2	5/22	H		5	100	760	760	119	R 46	R 46	A20	121
90199000	144C 6X4 144C 8X4	8/30	H		8	90	795	795				D1.1	240
90169000	144C 6X4 144C 8X4	10/25	H	26,3	10	90	795	795	70			D1.1	250
90109000	R144G 6x2 R144G 8x2	1/15,10/13	H	20,0	11	100	760	760	140	R 46	R 46	A1	145
90167000	144C 6X4 144C 8X4	12/20	H	21,3	12	90	795	795	84			D1.1	240
90115000	R144G 4x2	9/15	T	13,0	9	90	890	890	185	R 46	R 46	A26	135
90107000	R144G 4x2	6/14	Z	11,0	6	90	730	730	119			D11	84
90159000	R144G 4x2 R144G 6x2 R144L 4x2 R144L 6x2	1/47,1/44	L		2	100	690/ 190	260/ 50	50	30x65		L1	97
90187000	R144G 6x4 R144G 8x2	1/47,1/44	L		2	100	707/ 221	410/ 70	67	30x65		L1.2	97
90189000	R144G 6x4 R144G 8x2 R144L 6x2/4	1/47,1/44	L		2	100	707/ 291	410/ 70	67	30x65		L1.1	97
90181000	R144G 6x4 R144G 8x2	1/47,1/44	L		2	100	707/222	405/70		R 64		L1.2	97
90185000	R144G 6x4 R144G 8x2	1/47,1/44	L		2	100	707/292	405/70		R 64		L1.1	
90191000	R144G 6x4 R144G 8x2	1/47,1/44	L		2	100	707/ 221	410/ 70	120	30xR65		L1.2	97
90193000	R144G 6x4 R144G 8x2	1/47,1/44	L		2	100	707/ 291	410/ 70	120	30xR65		L1.1	97
90201000	R144G 6x4 R144G 8x2	1/47,1/44	L		2	100	725/ 290	411/ 70	96	30xR65		L1.1	97
90203000	R144G 6x4 R144G 8x2	1/47,1/44	L		2	100	725/ 290	411/ 70	96	30xR65		L1.2	97

SCANIA

Artikel.Nr.	Fahrzeugtyp	Info		Achsl.	Blattzahl	Breite	Lx/L1	Ly/L2	Spr./ Kr.	Buchsen vorn	Buchsen hinten	Form	Paket- stärke
Art.-No.	Type			Axle Load	Leaves	Width			Free Arch/ Crank	Bush front	Bush rear	Shape	Total height
90136000		2/32	V	7,5	2	70	770	1050				A20	70
90140000			V		2	90	910	910		R36	R36	A22	
90197000		10/20	H		10	90	770	770	85			D11	200



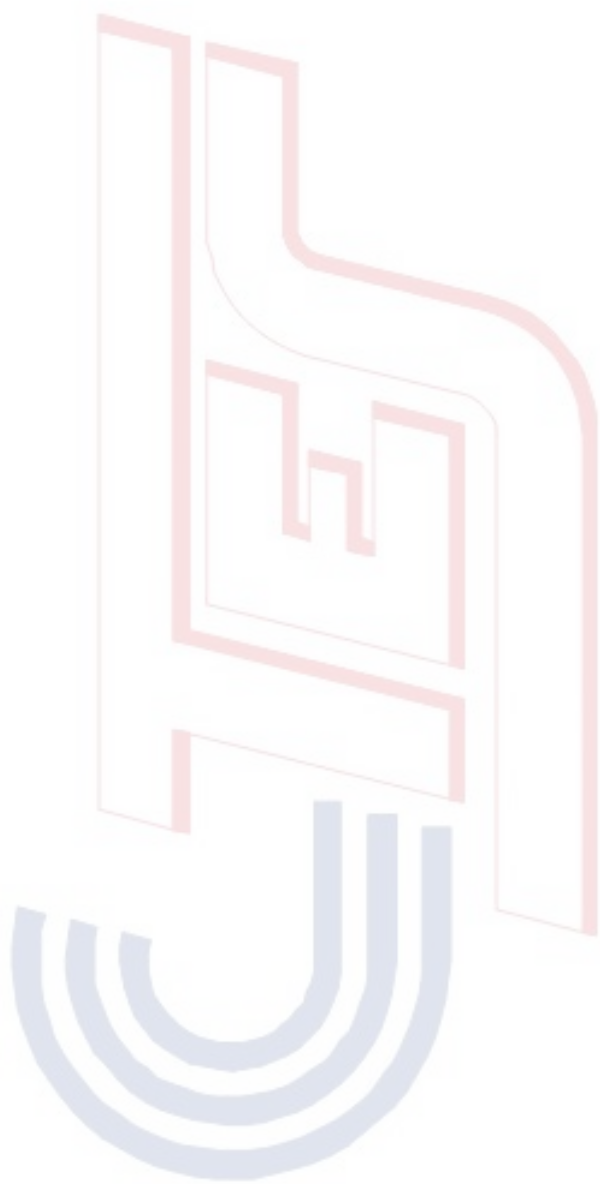

VOLVO



VOLVO

FORMEN; SHAPE

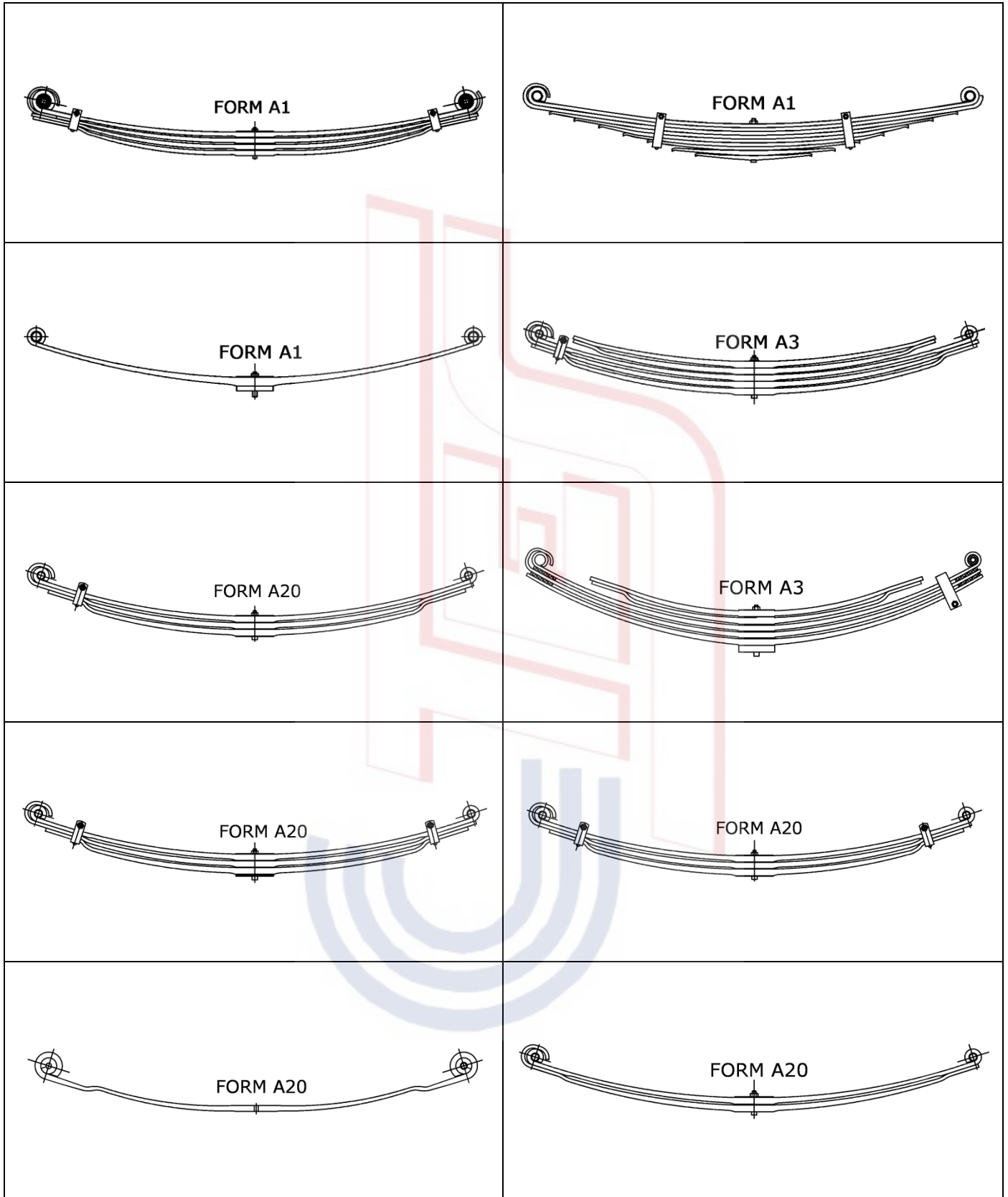

VOLVO

FORMEN; SHAPE

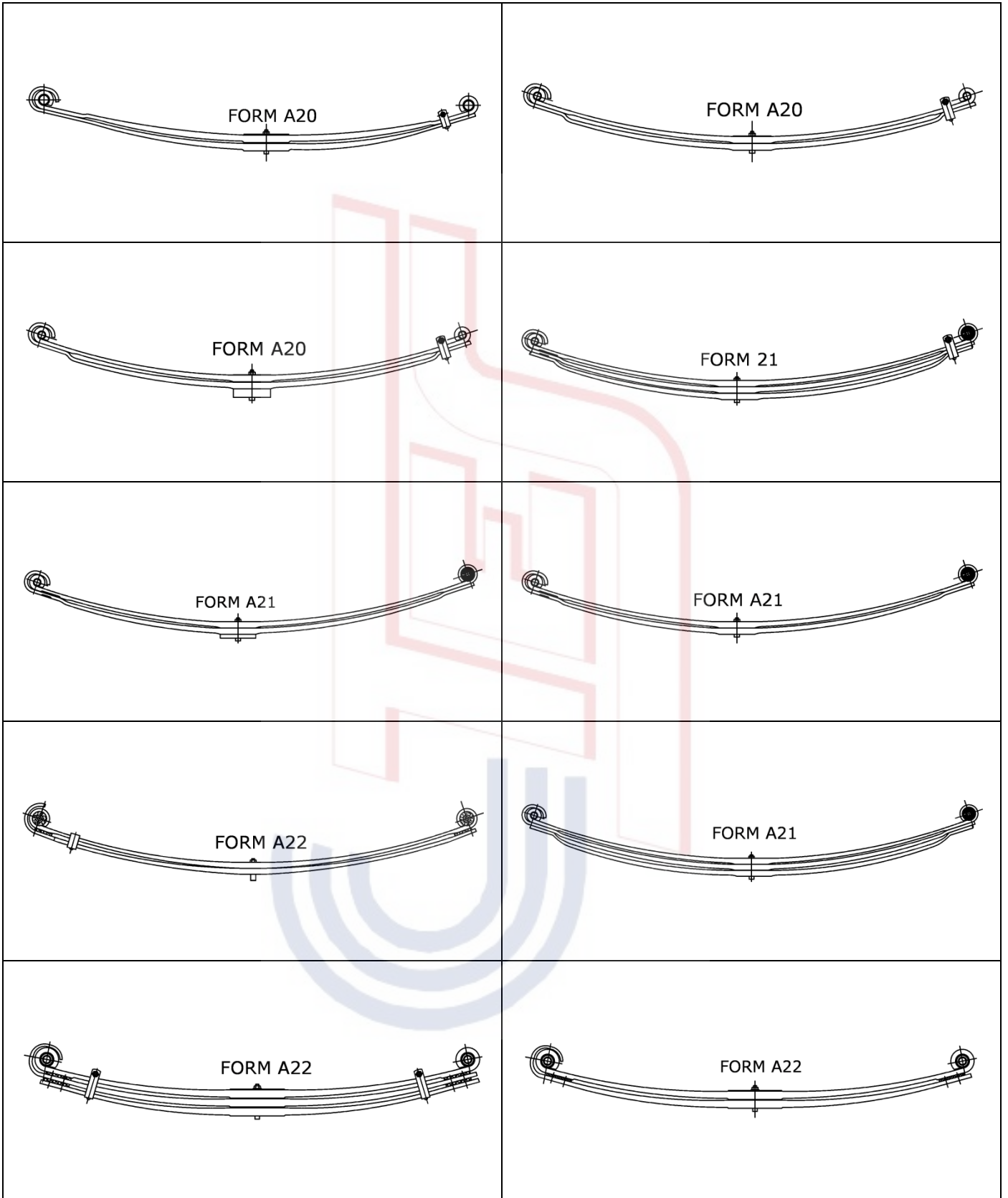

VOLVO

FORMEN; SHAPE

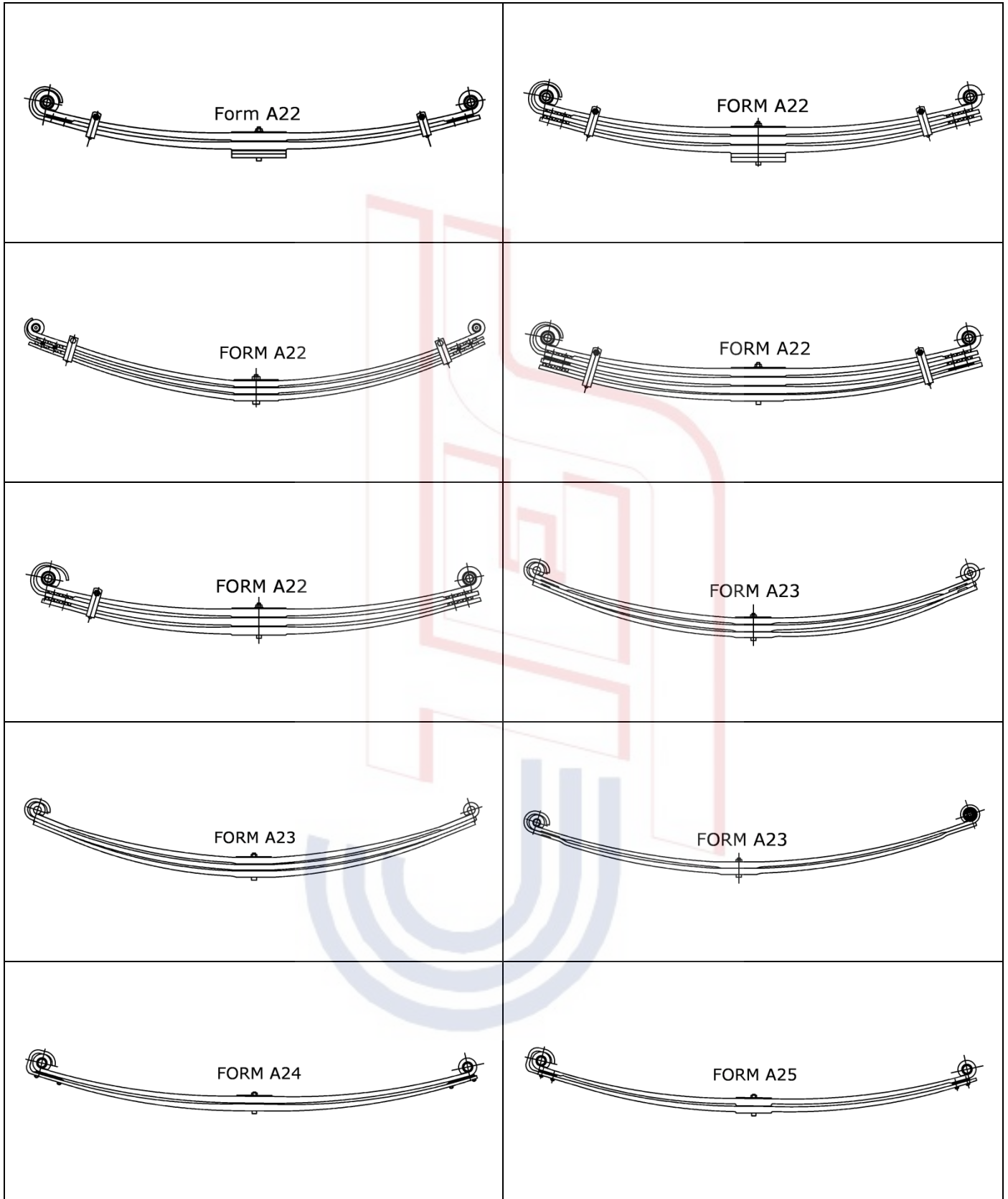

VOLVO

FORMEN; SHAPE

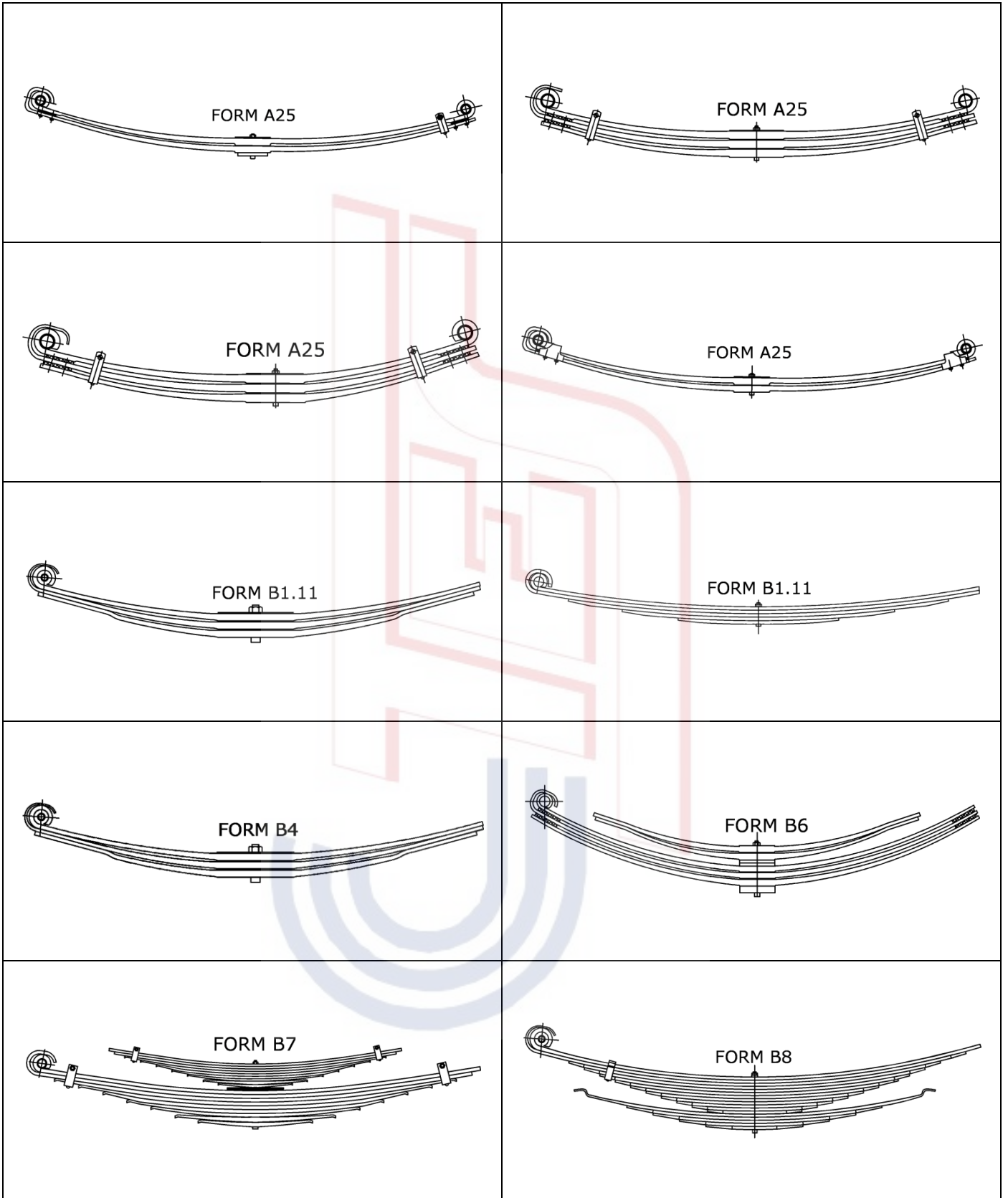

VOLVO

FORMEN; SHAPE

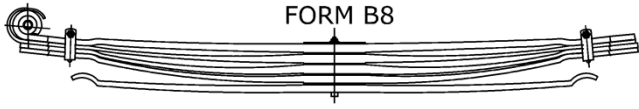

FORM B8

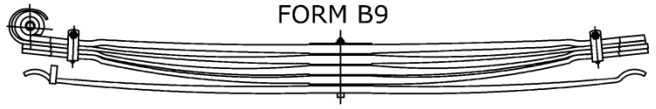

FORM B9

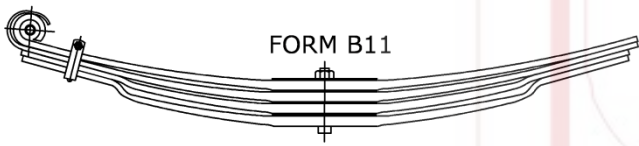

FORM B11



FORM B12



FORM B12

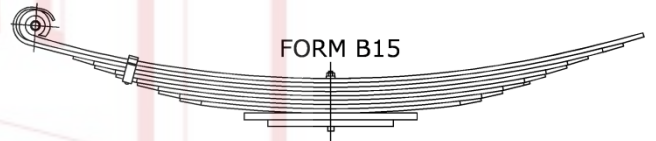

FORM B15

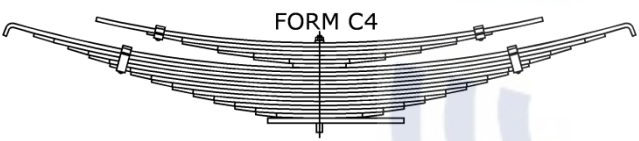

FORM C4

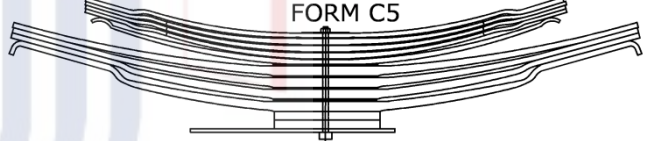

FORM C5

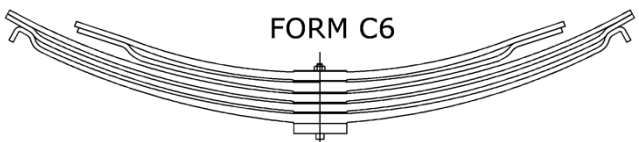

FORM C6



FORM D1.1

VOLVO

FORMEN; SHAPE

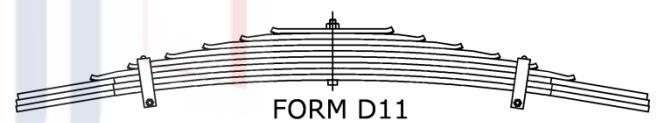
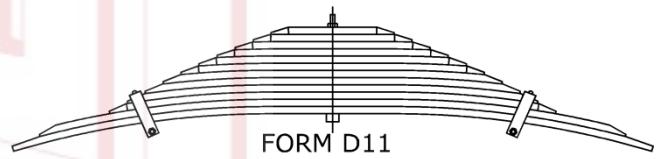
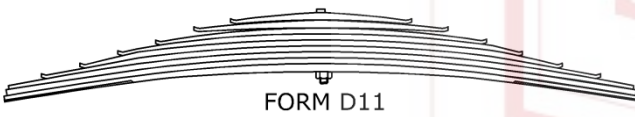
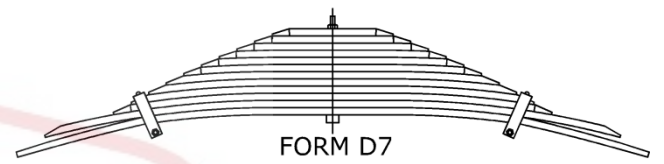
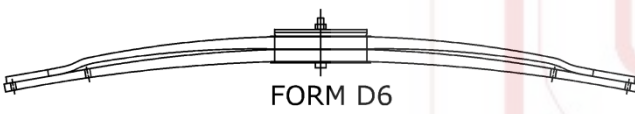
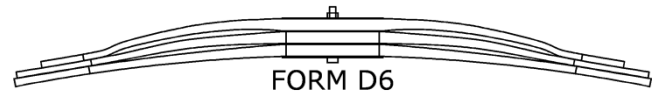
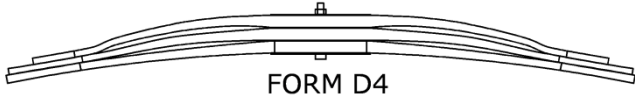

F4	VOLVO	F4
-----------	--------------	-----------

Artikel.Nr.	Fahrzeugtyp	Info		Achsl.	Blattzahl	Breite	Lx/L1	Ly/L2	Spr.	Buchsen vorn	Buchsen hinten	Form	Paketstärke
Art.-No.	Type			Axle Load	Leaves	Width			Free Arch	Bush front	Bush rear	Shape	Total height
09506000	F406	6/11	V		6	70	785	1075	220	22		B1.11	66
09516000	F406	6/11+P/11	V		6	70	785	1075	220	R40		B1.11	77
09506000	F407	6/11	V		6	70	785	1075	220	22		B1.11	66
09516000	F407	6/11+P/11	V		6	70	785	1075	220	R40		B1.11	77
09516000	F408	6/11+P/11	V		6	70	785	1075	220	R40		B1.11	77



F6	VOLVO	F6
-----------	--------------	-----------

Artikel.Nr.	Fahrzeugtyp	Info		Achsl.	Blattzahl	Breite			Spr.	Buchsen vorn	Buchsen hinten	Form	Paket stärke
Art.-No.	Type			Axle Load	Leaves	Width	Lx/L1	Ly/L2	Free Arch	Bush front	Bush rear	Shape	Total height
09518000	F607	7/12+2P/12	V		7	70	785	1075	108	22	R40	B1.11	108
09531000	F607	8/10+4/15	H		12	70	700	850	140	R40	R40	B15	140
09518000	F608	7/12+2P/12	V		7	70	785	1075	108	22	R40	B1.11	108
09531000	F608	8/10+4/15	H		12	70	700	850	140	R40	R40	B15	140
09518000	F609	7/12+2P/12	V		7	70	785	1075	108	22	R40	B1.11	108
09531000	F609	8/10+4/15	H		12	70	700	850	140	R40	R40	B15	140
09514000	F610	2/14+4/13+P/12	V		6	70	785	1045	92	R40	R40	B1.11	92
09656000	F610		V		6	70	785	1045	80	R40	R40	B1.11	80
09531000	F610	8/10+4/15	H		12	70	700	850	140	R40	R40	B15	140
09541000	F610	10/7	H		17	70	700	820	163	R40	R40	B7	163
09520000	F611	5/14	V		5	80	785	1075	70	R45	R45	B1.11	70
09500000	F611	7/1	V		7								
09508000	F611	7/1	V		7								
09529000	F611	8/4	H		12	70						B8	
09535000	F611	8/1/5/1	H		13	80	800	950	172	R45	R45	B7	172
09543000	F611	9/6	H		15	80	800	950	174	R45	R45	B7	174
09522000	F612	5/15	V		5	80	785	1045	75	R45	R45	B1.11	75
09524000	F612	6/15	V		6	80	785	1045	90	R45	R45	B1.11	90
09502000	F612	8/12	V		8	80	785	1075	96	R45	R45	B1.11	96
09510000	F612	8/12+P/12	V		8	80	785	1075	108	R45	R45	B1.11	108
09527000	F612	10/12+4/16	H		14	80	800	950	184	R45	R45	B8	184
09543000	F612	9/6	H		15	80	800	950	174	R45	R45	B7	174
09545000	F612	10/6	H		16	80	800	950	191	R45	R45	B7	192
09577000	F612	10/6	H		16	80	800	950	186	R45	R45	B7	186
09522000	F613	5/15	V		5	80	785	1045	75	R45	R45	B1.11	75
09524000	F613	6/15	V		6	80	785	1045	90	R45	R45	B1.11	90
09502000	F613	8/12	V		8	80	785	1075	96	R45	R45	B1.11	96
09510000	F613	8/12+P/12	V		8	80	785	1075	108	R45	R45	B1.11	108
09527000	F613	10/12+4/16	H		14	80	800	950	184	R45	R45	B8	184
09545000	F613	10/6	H		16	80	800	950	191	R45	R45	B7	192
09577000	F613	10/6	H		16	80	800	950	186	R45	R45	B7	186
09522000	F614	5/15	V		5	80	785	1045	75	R45	R45	B1.11	75
09524000	F614	6/15	V		6	80	785	1045	90	R45	R45	B1.11	90
09577000	F614		H		16	80	800	950	186	R45	R45	B7	186
09545000	F614		H		16	80	800	950	191	R45	R45	B7	192
09512000	F615	4/15	V		5	100	935	1035	82	R45	R45	B1.11	82

F7	VOLVO	F7
-----------	--------------	-----------

Artikel.Nr.	Fahrzeugtyp	Info		Achsl.	Blattzahl	Breite	Lx/L1	Ly/L2	Spr.	Buchsen vorn	Buchsen hinten	Form	Paket stärke
Art.-No.	Type			Axle Load	Leaves	Width			Free Arch	Bush front	Bush rear	Shape	Total height
09574000	F7	9/14	V	7,5	9	100	850	1030	145	D36x3xR45		B1.11	126
09474000	F7 4x2	3/22+P/22	V	6,5	3	100	845	1030	140	D36x3xR45		B11	97
09568000	F7 4x2	3/22+P/22	V	6,5	3	100	845	1030	191	D36x3xR45		B4	97
09588000	F7 4x2	3/22+P/22	V		3	100	845	1030	163	D36x3xR45		B4	97
09494000	F7 4x2	6/14,1/6	V		7	100	850	1030		xR45		B1.11	90
09492000	F7 4x2	8/14	V	6,5	8	100	850	1030	143	D36x3xR45		B1.11	112
09495000	F7 4x2		H	10,0	9							B1.11	
09581000	F7 4x2	9/14	H	10,5	9	100	828	828				D1.1	126
09583000	F7 4x2	11/14	H	11,5	11	100	828	828	65			D1.1	154
09467000	F7 4x2S	3/25	H	10,0	3	100	885	1025	198	D36x3xR45		B11	87
09481000	F7 4x2S	4/22+1/35	H	13,0	5	100	885	1025	90	D36x3xR45		B8	137
09465000	F7 4x2S	4/22+1/35	H	13,0	5	100	885	1025	165	D36x3xR45		B9	137
09483000	F7 4x2	3/1/2	H	10,0	5	100	975	975	190			C6	143
09641000	F7 4x2	3/21,3/20	H	13,0	6	100	975	975	195			C5	144
09475000	F7 4x2	3/21,3/20,P/10	H	13,0	6	100	975	975				C6	
09649000	F7 4x2	3/21,4/20,2P/20,P/10	H	13,0	7	100	980	980	170			C5	214
09515000	F7 4x2	5/17,1/10,4/13	H	10,0	10	100	1000	1000	170			C4	147
09441000	F7 4x2	5/1/4/1	H	10,0	11	100	1000	1000				C4	159
09457000	F7 4x2	5/P/6/P	H	13	11	100	1000	1000	179			C6	204
09517000	F7 4x2	5/17,1/10,2/15,4/14	H	13,0	12	100	1007	1007	179			C4	181
09474000	F7 6x2	3/22+P/22	V	6,5	3	100	845	1030	140	D36x3xR45		B11	97
09534000	F7 6x2	4/22	V	6,5	4	100	850	1025	175	D36x3xR45		B11	104
09494000	F7 6x2	6/14,1/6	V		7	100	850	1030		xR45		B1.11	90
09492000	F7 6x2	8/14	V	6,5	8	100	850	1030	143	D36x3xR45		B1.11	112
09651000	F7 6x2	4/32	H	18,0	4	80	640	960	25			D1.1	136
09645000	F7 6x2	5/32	H	18,0	5	80	640	960	20			D1.1	170
09463000	F7 6x2	5/22	H	9,0	5	100	840	990	145	D36x3xR45		B12	125
09499000	F7 6x2		H	2X9	8	100	840	990				B1.11	136
09474000	F7 6x4	3/22+P/22	V	6,5	3	100	845	1030	140	D36x3xR45		B11	97
09568000	F7 6x4	3/22+P/22	V	6,5	3	100	845	1030	191	D36x3xR45		B4	97
09588000	F7 6x4	3/22+P/22	V		3	100	845	1030	163	D36x3xR45		B4	97
09494000	F7 6x4	6/14,1/6	V		7	100	850	1030		xR45		B1.11	90
09492000	F7 6x4	8/14	V	6,5	8	100	850	1030	143	D36x3xR45		B1.11	112
09645000	F7 6x4	5/32	H	18,0	5	80	640	960	20			D1.1	170
09653000	F7 6x4	5/26	H	18,0	5	90	778	778				D11	192
09507000	F7 6x4	8/24	H	20,0	8	90	778	778	50			D11	192
09549000	F7 6x4	2/54,2P/8	H	20,0	2	90	780	780	43			D6	130
09585000	F7 6x4	8/24	H	20,0	8	90	790	790	55			D11	192
09589000	F7 6x4	5/26	H	17,0	5	90	793	793	70			D1.1	130
09579000	F7 6x4	2/52,P/15	H	8,5	2	90	795	795	41			D6	125
09505000	F7 6x4		H	18,0	9	100						D1.1	
09513000	F7 6x4	10/11	H	18,0	10	100						D1.1	
09538000	F7 8x2	2/24	V		2	100	575	825	73	D36x3xR45		B11	51
09632000	F7 8x2	2/24	V		2	100	575	825		R45		B4	
09578000	F7 8x2	8/10	V		8	100	575	825	115	D36x3xR45		B1.11	86
09622000	F7 8x2	9/11,1/10	V		10	100	575	825		R45		B1.11	109
09536000	F7 8x2	2/29	V		2	100	848	850	77	D36x3xR45		B11	61
09630000	F7 8x2	2/29	V		2	100	850	850				B4	
09576000	F7 8x2	6/14	V		6	100	850	850	105	D36x3xR45		B1.11	84
09620000	F7 8x2	2/15,6/14	V		8	100	850	850		R45		B1.11	114
09463000	F7 8x2	5/22	H	9,0	5	100	840	990	145	D36x3xR45		B12	125
09499000	F7 8x2		H	2X9	8	100	840	990				B1.11	136
09538000	F7 8x4	2/24	V		2	100	575	825	73	D36x3xR45		B11	51
09632000	F7 8x4	2/24	V		2	100	575	825		R45		B4	
09578000	F7 8x4	8/10	V		8	100	575	825	115	D36x3xR45		B1.11	86

F7	VOLVO	F7
-----------	--------------	-----------

Artikel.Nr.	Fahrzeugtyp	Info		Achsl.	Blattzahl	Breite			Spr.	Buchsen vorn	Buchsen hinten	Form	Paket stärke
Art.-No.	Type			Axle Load	Leaves	Width	Lx/L1	Ly/L2	Free Arch	Bush front	Bush rear	Shape	Total height
09622000	F7 8x4	9/11,1/10	V		10	100	575	825		R45		B1.11	109
09536000	F7 8x4	2/29	V		2	100	848	850	77	D36x3xR45		B11	61
09630000	F7 8x4	2/29	V		2	100	850	850		R45		B4	
09576000	F7 8x4	6/14	V		6	100	850	850	105	D36x3xR45		B1.11	84
09620000	F7 8x4	2/15,6/14	V		8	100	850	850		R45		B1.11	114
09645000	F7 8x4	5/32	H	18,0	5	80	640	960	20			D1.1	170
09653000	F7 8x4	5,26	H	18,0	5	90	778	778				D11	192
09507000	F7 8x4	8/24	H	20,0	8	90	778	778	50			D11	192
09585000	F7 8x4	8/24	H	20,0	8	90	790	790	55			D11	192
09589000	F7 8x4	5/26	H	17,0	5	90	793	793	70			D1.1	130
09547000	F7 8x4	2/27,P/30	H	18,0	2	90	848	848	19			D6	126
09563000	F7 8x4	2/54,P/12	H	13,0	2	90	860	860	17			D6	126
09505000	F7 8x4		H	18,0	9	100						D1.1	
09643000	F7 8x4	9/28	H		9	100						D1.1	252
09513000	F7 8x4	10/11	H	18,0	10	100						D1.1	



F10	VOLVO	F10
------------	--------------	------------

Artikel.Nr.	Fahrzeugtyp	Info		Achsl.	Blattzahl	Breite	Lx/L1	Ly/L2	Spr.	Buchsen vorn	Buchsen hinten	Form	Paket stärke
Art.-No.	Type			Axle Load	Leaves	Width			Free Arch	Bush front	Bush rear	Shape	Total height
09580000	F10 4x2	2/30	V	6,5	2	100	891	815	125	D36x3xR45	D36x3xR45	A20	66
09582000	F10	3/27	V	7,5	3	100	891	815	106	D36x3xR45	D36x3xR45	A20	90
09584000	F10 4x2	10/13	V	7,5	10	100	891	815	165	D36x3xR45	D36x3xR45	A1	130
09488000	F10 4x2	10/12	V	6,5	10	100	930	1040	215	D36x3xR45		B1.11	120
09528000	F10	3/26	V	7,5	3	100	935	815	163	D36x3xR45	D36x3xR45	A20	87
09548000	F10 4x2	3/25	V	6,5	3	100	935	815	141	D36x3xR45	D36x3xR45	A20	87
09526000	F10 4x2	3/25	V	7,5	3	100	935	815	145	D36x3xR45	D36x3xR45	A22	84
09550000	F10 4x2	3/22,P/13	V	6,5	3	100	935	815	175	D36x3xR45	D36x3xR45	A22	88
09460000	F10 4x2	3/23,P/10	V	6,5	3	100	935	1025	146	D36x3xR45		B11	88
09490000	F10 4x2	2/18+2/19+2P/11	V	6,5	4	100	935	1045	165	D36x3xR45		B4	96
09566000	F10 4x2	10/13	V	7,5	10	100	935	815	172	D36x3xR45	D36x3xR45	A1	130
09572000	F10 4x2	10/12	V	6,5	10	100	935	815	155	D36x3xR45	D36x3XR45	A1	120
09586000	F10 4x2	10/12	V	6,5	10	100	935	1035	195	D36x3xR45		B1.11	120
09583000	F10 4x2	11/14	H	11,5	11	100	828	828	65			D1.1	154
09467000	F10 4x2	3/25	H	10,0	3	100	885	1025	198	D36x3xR45		B11	87
09481000	F10 4x2	4/22+1/35	H	13,0	5	100	885	1025	90	D36x3xR45		B8	137
09465000	F10 4x2	4/22+1/35	H	13,0	5	100	885	1025	165	D36x3xR45		B9	137
09559000	F10 4x2	3/32	H	13,0	3	100	895	820	119	R55	D36x3xR55	A25	105
09483000	F10 4x2	3/1/2	H	10,0	5	100	975	975	190			C6	143
09641000	F10 4x2	3/21,3/20	H	13,0	6	100	975	975	195			C5	144
09475000	F10 4x2	3/21,3/20,P/10	H	13,0	6	100	975	975				C6	
09649000	F10 4x2	3/21,4/20,2P/20, P/10	H	13,0	7	100	980	980	170			C5	214
09515000	F10 4x2	5/17,1/10,4/13	H	10,0	10	100	1000	1000	170			C4	147
09457000	F10 4x2	5/P/6/P	H	13	11	100	1000	1000	179			C6	204
09517000	F10 4x2	5/17,1/10,2/15,4/14	H	13,0	12	100	1007	1007	179			C4	181
09511000	F10 4x2	14/10,1/10,11/10	H	13,0	26	100	1025	1025	275			C4	260
09599500	F10 4x2		L		2	100	760	1025		S24		L17	
09580000	F10 6x2	2/30	V	6,5	2	100	891	815	125	D36x3xR45	D36x3xR45	A20	66
09584000	F10 6x2	10/13	V	7,5	10	100	891	815	165	D36x3xR45	D36x3xR45	A1	130
09488000	F10 6x2	10/12	V	6,5	10	100	930	1040	215	D36x3xR45		B1.11	120
09548000	F10 6x2	3/25	V	6,5	3	100	935	815	141	D36x3xR45	D36x3xR45	A20	87
09526000	F10 6x2	3/25	V	7,5	3	100	935	815	145	D36x3xR45	D36x3xR45	A22	84
09550000	F10 6x2	3/22,P/13	V	6,5	3	100	935	815	175	D36x3xR45	D36x3xR45	A22	88
09460000	F10 6x2	3/23,P/10	V	6,5	3	100	935	1025	146	D36x3xR45		B11	88
09490000	F10 6x2	2/18+2/19+2P/11	V	6,5	4	100	935	1045	165	D36x3xR45		B4	96
09566000	F10 6x2	10/13	V	7,5	10	100	935	815	172	D36x3xR45	D36x3xR45	A1	130
09572000	F10 6x2	10/12	V	6,5	10	100	935	815	155	D36x3xR45	D36x3XR45	A1	120
09586000	F10 6x2	10/12	V	6,5	10	100	935	1035	195	D36x3xR45		B1.11	120
09651000	F10 6x2	4/32	H	18,0	4	80	640	960	25			D1.1	136
09645000	F10 6x2	5/32	H	18,0	5	80	640	960	20			D1.1	170
09655000	F10 6x2	3/30	H	18,0	3	100	840	990	130	D36x3xR45		B12	99
09463000	F10 6x2	5/22	H	9,0	5	100	840	990	145	D36x3xR45		B12	125
09463100	F10 6x2	6/22	H	10,0	6	100	840	990	150	D36xR45		B12	150
09497000	F10 6x2	8/17	H	18,0	8	100	845	930	110	D36x3xR45		B1.11	136
09599500	F10 6x2		L		2	100	760	1025		S24		L17	
09580000	F10 6x4	2/30	V	6,5	2	100	891	815	125	D36x3xR45	D36x3xR45	A20	66
09584000	F10 6x4	10/13	V	7,5	10	100	891	815	165	D36x3xR45	D36x3xR45	A1	130
09488000	F10 6x4	10/12	V	6,5	10	100	930	1040	215	D36x3xR45		B1.11	120
09548000	F10 6x4	3/25	V	6,5	3	100	935	815	141	D36x3xR45	D36x3xR45	A20	87
09526000	F10 6x4	3/25	V	7,5	3	100	935	815	145	D36x3xR45	D36x3xR45	A22	84
09550000	F10 6x4	3/22,P/13	V	6,5	3	100	935	815	175	D36x3xR45	D36x3xR45	A22	88
09460000	F10 6x4	3/23,P/10	V	6,5	3	100	935	1025	146	D36x3xR45		B11	88
09490000	F10 6x4	2/18+2/19+2P/11	V	6,5	4	100	935	1045	165	D36x3xR45		B4	96
09566000	F10 6x4	10/13	V	7,5	10	100	935	815	172	D36x3xR45	D36x3xR45	A1	130
09572000	F10 6x4	10/12	V	6,5	10	100	935	815	155	D36x3xR45	D36x3XR45	A1	120

F10	VOLVO	F10
------------	--------------	------------

Artikel.Nr.	Fahrzeugtyp	Info		Achsl.	Blattzahl	Breite			Spr.	Buchsen vorn	Buchsen hinten	Form	Paket stärke
Art.-No.	Type			Axle Load	Leaves	Width	Lx/L1	Ly/L2	Free Arch	Bush front	Bush rear	Shape	Total height
09586000	F10 6x4	10/12	V	6,5	10	100	935	1035	195	D36x3xR45		B1.11	120
09507000	F10 6x4	8/24	H	20,0	8	90	778	778	50			D11	192
09549000	F10 6x4	2/54,2P/8	H	20,0	2	90	780	780	43			D6	130
09585000	F10 6x4	8/24	H	20,0	8	90	790	790	55			D11	192
09589000	F10 6x4	5/26	H	17,0	5	90	793	793	70			D1.1	130
09565000	F10 6x4	9/26	H	20,0	9	90	793	793	70			D11	234
09587000	F10 6x4	2/45	H	17,0	2	90	795	795	52			D1.1	96
09579000	F10 6x4	2/52,P/15	H	8,5	2	90	795	795	41			D6	125
09513000	F10 6x4	10/11	H	18,0	10	100						D1.1	



F12	VOLVO	F12
------------	--------------	------------

Artikel.Nr.	Fahrzeugtyp	Info		Achsl.	Blattzahl	Breite	Lx/L1	Ly/L2	Spr.	Buchsen vorn	Buchsen hinten	Form	Paket stärke
Art.-No.	Type			Axle Load	Leaves	Width			Free Arch	Bush front	Bush rear	Shape	Total height
09580000	F12 4x2	2/30	V	6,5	2	100	891	815	125	D36x3xR45	D36x3xR45	A20	66
09582000	F12 4x2	3/27	V	7,5	3	100	891	815	106	D36x3xR45	D36x3xR45	A20	90
09614000	F12 4x2	4/27	V	7,5	4	100	891	815	101	D36x3xR45	D36x3xR45	A20	120
09584000	F12 4x2	10/13	V	7,5	10	100	891	815	165	D36x3xR45	D36x3xR45	A1	130
09488000	F12 4x2	10/12	V	6,5	10	100	930	1040	215	D36x3xR45		B1.11	120
09528000	F12 4x2	3/26	V	7,5	3	100	935	815	163	D36x3xR45	D36x3xR45	A20	87
09548000	F12 4x2	3/25	V	6,5	3	100	935	815	141	D36x3xR45	D36x3xR45	A20	87
09526000	F12 4x2	3/25	V	7,5	3	100	935	815	145	D36x3xR45	D36x3xR45	A22	84
09550000	F12 4x2	3/22,P/13	V	6,5	3	100	935	815	175	D36x3xR45	D36x3xR45	A22	88
09460000	F12 4x2	3/23,P/10	V	6,5	3	100	935	1025	146	D36x3xR45		B11	88
09476000	F12 4x2	4/23	V	7,5	4	100	935	1025	153	D36x3xR45		B11	104
09490000	F12 4x2	2/18+2/19+2P/11	V	6,5	4	100	935	1045	165	D36x3xR45		B4	96
09566000	F12 4x2	10/13	V	7,5	10	100	935	815	172	D36x3xR45	D36x3xR45	A1	130
09572000	F12 4x2	10/12	V	6,5	10	100	935	815	155	D36x3xR45	D36x3xR45	A1	120
09586000	F12 4x2	10/12	V	6,5	10	100	935	1035	195	D36x3xR45		B1.11	120
09583000	F12 4x2	11/14	H	11,5	11	100	828	828	65			D1.1	154
09467000	F12 4x2	3/25	H	10,0	3	100	885	1025	198	D36x3xR45		B11	87
09481000	F12 4x2	4/22+1/35	H	13,0	5	100	885	1025	90	D36x3xR45		B8	137
09465000	F12 4x2	4/22+1/35	H	13,0	5	100	885	1025	165	D36x3xR45		B9	137
09559000	F12 4x2	3/32	H	13,0	3	100	895	820	119	R55	D36x3xR55	A25	105
09483000	F12 4x2	3/1/2	H	10,0	5	100	975	975	190			C6	143
09641000	F12 4x2	3/21,3/20	H	13,0	6	100	975	975	195			C5	144
09649000	F12 4x2	3/21,4/20,2P/20, P/10	H	13,0	7	100	980	980	170			C5	214
09515000	F12 4x2	5/17,1/10,4/13	H	10,0	10	100	1000	1000	170			C4	147
09457000	F12 4x2	5/P/6/P	H	13	11	100	1000	1000	179			C6	204
09517000	F12 4x2	5/17,1/10,2/15,4 /14	H	13,0	12	100	1007	1007	179			C4	181
09661000	F12 4x2	15/10,2P/10,6/11	H	10,0	21	100	1025	1025				C4	236
09511000	F12 4x2	14/10,1/10,11/10	H	13,0	26	100	1025	1025	275			C4	260
09599800	F12 4x2		L		2	100	760	1025		S24		L17	
09580000	F12 6x2	2/30	V	6,5	2	100	891	815	125	D36x3xR45	D36x3xR45	A20	66
09582000	F12 6x2	3/27	V	7,5	3	100	891	815	106	D36x3xR45	D36x3xR45	A20	90
09614000	F12 6x2	4/27	V	7,5	4	100	891	815	101	D36x3xR45	D36x3xR45	A20	120
09584000	F12 6x2	10/13	V	7,5	10	100	891	815	165	D36x3xR45	D36x3xR45	A1	130
09488000	F12 6x2	10/12	V	6,5	10	100	930	1040	215	D36x3xR45		B1.11	120
09528000	F12 6x2	3/26	V	7,5	3	100	935	815	163	D36x3xR45	D36x3xR45	A20	87
09548000	F12 6x2	3/25	V	6,5	3	100	935	815	141	D36x3xR45	D36x3xR45	A20	87
09526000	F12 6x2	3/25	V	7,5	3	100	935	815	145	D36x3xR45	D36x3xR45	A22	84
09550000	F12 6x2	3/22,P/13	V	6,5	3	100	935	815	175	D36x3xR45	D36x3xR45	A22	88
09476000	F12 6x2	4/23	V	7,5	4	100	935	1025	153	D36x3xR45		B11	104
09490000	F12 6x2	2/18+2/19+2P/11	V	6,5	4	100	935	1045	165	D36x3xR45		B4	96
09566000	F12 6x2	10/13	V	7,5	10	100	935	815	172	D36x3xR45	D36x3xR45	A1	130
09572000	F12 6x2	10/12	V	6,5	10	100	935	815	155	D36x3xR45	D36x3xR45	A1	120
09586000	F12 6x2	10/12	V	6,5	10	100	935	1035	195	D36x3xR45		B1.11	120
09651000	F12 6x2	4/32	H	18,0	4	80	640	960	25			D1.1	136
09645000	F12 6x2	5/32	H	18,0	5	80	640	960	20			D1.1	170
09589000	F12 6x2	5/26	H	17,0	5	90	793	793	70			D1.1	130
09587000	F12 6x2	2/45	H	17,0	2	90	795	795	52			D1.1	96
09655000	F12 6x2	3/30	H	18,0	3	100	840	990	130	D36x3xR45		B12	99
09463000	F12 6x2	5/22	H	9,0	5	100	840	990	145	D36x3xR45		B12	125
09463100	F12 6x2	6/22	H	10,0	6	100	840	990	150	D36xR45		B12	150
09497000	F12 6x2	8/17	H	18,0	8	100	845	930	110	D36x3xR45		B1.11	136
09580000	F12 6x4	2/30	V	6,5	2	100	891	815	125	D36x3xR45	D36x3xR45	A20	66
09582000	F12 6x4	3/27	V	7,5	3	100	891	815	106	D36x3xR45	D36x3xR45	A20	90
09614000	F12 6x4	4/27	V	7,5	4	100	891	815	101	D36x3xR45	D36x3xR45	A20	120
09584000	F12 6x4	10/13	V	7,5	10	100	891	815	165	D36x3xR45	D36x3xR45	A1	130

F12	VOLVO	F12
------------	--------------	------------

Artikel.Nr.	Fahrzeugtyp	Info		Achsl.	Blattzahl	Breite			Spr.	Buchsen vorn	Buchsen hinten	Form	Paket stärke
Art.-No.	Type			Axle Load	Leaves	Width	Lx/L1	Ly/L2	Free Arch	Bush front	Bush rear	Shape	Total height
09488000	F12 6x4	10/12	V	6,5	10	100	930	1040	215	D36x3xR45		B1.11	120
09528000	F12 6x4	3/26	V	7,5	3	100	935	815	163	D36x3xR45	D36x3xR45	A20	87
09548000	F12 6x4	3/25	V	6,5	3	100	935	815	141	D36x3xR45	D36x3xR45	A20	87
09526000	F12 6x4	3/25	V	7,5	3	100	935	815	145	D36x3xR45	D36x3xR45	A22	84
09550000	F12 6x4	3/22,P/13	V	6,5	3	100	935	815	175	D36x3xR45	D36x3xR45	A22	88
09460000	F12 6x4	3/23,P/10	V	6,5	3	100	935	1025	146	D36x3xR45		B11	88
09476000	F12 6x4	4/23	V	7,5	4	100	935	1025	153	D36x3xR45		B11	104
09490000	F12 6x4	2/18+2/19+2P/11	V	6,5	4	100	935	1045	165	D36x3xR45		B4	96
09566000	F12 6x4	10/13	V	7,5	10	100	935	815	172	D36x3xR45	D36x3xR45	A1	130
09572000	F12 6x4	10/12	V	6,5	10	100	935	815	155	D36x3xR45	D36x3XR45	A1	120
09586000	F12 6x4	10/12	V	6,5	10	100	935	1035	195	D36x3xR45		B1.11	120
09507000	F12 6x4	8/24	H	20,0	8	90	778	778	50			D11	192
09549000	F12 6x4	2/54,2P/8	H	20,0	2	90	780	780	43			D6	130
09585000	F12 6x4	8/24	H	20,0	8	90	790	790	55			D11	192
09509000	F12 6x4	9/26	H	26,0	9	90	790	790	55			D1.1	234
09565000	F12 6x4	9/26	H	20,0	9	90	793	793	70			D11	234
09579000	F12 6x4	2/52,P/15	H	8,5	2	90	795	795	41			D6	125
09513000	F12 6x4	10/11	H	18,0	10	100						D1.1	
09548000	F12 8x2	3/25	V	6,5	3	100	935	815	141	D36x3xR45	D36x3xR45	A20	87
09526000	F12 8x2	3/25	V	7,5	3	100	935	815	145	D36x3xR45	D36x3xR45	A22	84
09550000	F12 8x2	3/22,P/13	V	6,5	3	100	935	815	175	D36x3xR45	D36x3xR45	A22	88
09566000	F12 8x2	10/13	V	7,5	10	100	935	815	172	D36x3xR45	D36x3xR45	A1	130
09572000	F12 8x2	10/12	V	6,5	10	100	935	815	155	D36x3xR45	D36x3XR45	A1	120
09548000	F12 8x4	3/25	V	6,5	3	100	935	815	141	D36x3xR45	D36x3xR45	A20	87
09526000	F12 8x4	3/25	V	7,5	3	100	935	815	145	D36x3xR45	D36x3xR45	A22	84
09550000	F12 8x4	3/22,P/13	V	6,5	3	100	935	815	175	D36x3xR45	D36x3xR45	A22	88
09566000	F12 8x4	10/13	V	7,5	10	100	935	815	172	D36x3xR45	D36x3xR45	A1	130
09572000	F12 8x4	10/12	V	6,5	10	100	935	815	155	D36x3xR45	D36x3XR45	A1	120

F16	VOLVO	F16
------------	--------------	------------

Artikel.Nr.	Fahrzeugtyp	Info		Achsl.	Blattzahl	Breite	Lx/L1	Ly/L2	Spr.	Buchsen vorn	Buchsen hinten	Form	Paket
Art.-No.	Type			Axle Load	Leaves	Width			Free Arch	Bush front	Bush rear	Shape	Total height
09580000	F16 4x2	2/30	V	6,5	2	100	891	815	125	D36x3xR45	D36x3xR45	A20	66
09582000	F16 4x2	3/27	V	7,5	3	100	891	815	106	D36x3xR45	D36x3xR45	A20	90
09614000	F16 4x2	4/27	V	7,5	4	100	891	815	101	D36x3xR45	D36x3xR45	A20	120
09641000	F16 4x2	3/21,3/20	H	13,0	6	100	975	975	195			C5	144
09649000	F16 4x2	3/21,4/20,2P/20, P/10	H	13,0	7	100	980	980	170			C5	214
09517000	F16 4x2	5/17,1/10,2/15,4/14	H	13,0	12	100	1007	1007	179			C4	181
09580000	F16 6x2	2/30	V	6,5	2	100	891	815	125	D36x3xR45	D36x3xR45	A20	66
09582000	F16 6x2	3/27	V	7,5	3	100	891	815	106	D36x3xR45	D36x3xR45	A20	90
09614000	F16 6x2	4/27	V	7,5	4	100	891	815	101	D36x3xR45	D36x3xR45	A20	120
09645000	F16 6x2	5/32	H	18,0	5	80	640	960	20			D1.1	170
09655000	F16 6x2	3/30	H	18,0	3	100	840	990	130	D36x3xR45		B12	99
09463000	F16 6x2	5/22	H	9,0	5	100	840	990	145	D36x3xR45		B12	125
09463100	F16 6x2	6/22	H	10,0	6	100	840	990	150	D36xR45		B12	150
09580000	F16 6x4	2/30	V	6,5	2	100	891	815	125	D36x3xR45	D36x3xR45	A20	66
09582000	F16 6x4	3/27	V	7,5	3	100	891	815	106	D36x3xR45	D36x3xR45	A20	90
09614000	F16 6x4	4/27	V	7,5	4	100	891	815	101	D36x3xR45	D36x3xR45	A20	120
09585000	F16 6x4	8/24	H	20,0	8	90	790	790	55			D11	192
09589000	F16 6x4	5/26	H	17,0	5	90	793	793	70			D1.1	130
09565000	F16 6x4	9/26	H	20,0	9	90	793	793	70			D11	234
09587000	F16 6x4	2/45	H	17,0	2	90	795	795	52			D1.1	96
09579000	F16 6x4	2/52,P/15	H	17,0	2	90	795	795	41			D6	125

FE	VOLVO	FE
-----------	--------------	-----------

Artikel.Nr.	Fahrzeugtyp	Info		Achsl.	Blattzahl	Breite	Lx/L1	Ly/L2	Spr.	Buchsen vorn	Buchsen hinten	Form	Paket stärke
Art.-No.	Type			Axle Load	Leaves	Width			Free Arch	Bush front	Bush rear	Shape	Total height
09742000	FE	2/30,Silentblock	V		2	90	940	900		S24xD60	S24xR60	A22	
09736000	FE	2/28,Silentblock	V		2	90	940	900		S24	S24	A1	



FH12	VOLVO	FH12
-------------	--------------	-------------

Artikel.Nr.	Fahrzeugtyp	Info		Achsl.	Blattzahl	Breite	Lx/L1	Ly/L2	Spr.	Buchsen vorn	Buchsen hinten	Form	Paket stärke
Art.-No.	Type			Axle Load	Leaves	Width			Free Arch	Bush front	Bush rear	Shape	Total height
09652000	FH12/16	1/22,2/24	V		3	100	795	795	130	D36xR45	D36xR45	A21	79
09692000	FH12/16	1/24,2/25	V		3	100	795	795	113	D36xR45	D36xR45	A23	83
09714000	FH12/16	1/22,2/24,Silentb lock	V		3	100	795	795	126	S20xR50	S20xR50	A23	79
09740000	FH12/16	1/24,2/25,Silentb lock	V		3	100	795	795	115	S20xD50	S20xR50	A23	80
09658000	FH12/16	3/12,8/14	V		3	100	795	795	130	D36x3xR45	D34x4xR45	D1.1	79
09654000	FH12/16	2/32	V		2	100	990	900	145	D36xR45	D36xR45	A21	70
09688000	FH12/16	2/32	V		2	100	990	900	147	D36xR45	D36xR45	A21	70
09618000	FH12/16	2/35	V		2	100	990	900	130	D34xR45	D34xR45	A23	76
09644000	FH12/16	2/32	V	8,0	2	100	990	900	118	D36x3x45	D36x3xR45	A23	70
09646000	FH12/16	2/30	V	7,1	2	100	990	900	141	D36x3x45	D36x3xR45	A23	66
09664000	FH12/16	2/30	V	7,1	2	100	990	900	141	D34x4xR45	D34x4xR45	A23	66
09666000	FH12/16	2/32	V		2	100	990	900	118	D34x4xR45	D34x4xR45	A23	70
09700000	FH12/16	2/35	V	7,1	2	100	990	900	112	D34	D34	A23	76
09712000	FH12/16	2/32,Silentblock	V	8,0	2	100	990	900	124	S20xR50	S20xR50	A23	70
09716000	FH12/16	2/35	V	7,1	2	100	990	900		R45	R45	A23	
09718000	FH12/16		V	7,1	2	100	990	900		D36xR45	D36xR45	A23	
09722000	FH12/16	2/30	V	7,1	2	100	990	900	142	S20xD50	S20xR50	A23	64
09734000	FH12/16	2/32,Silentblock	V	8,0	2	100	990	900	118	S20xD50	S20xR50	A23	70
09642000	FH12/16	2/30	V	7,1	2	100	990	900	141	D36x3x45	D36x3xR45	A24	66
09662000	FH12/16	2/30	V	7,1	2	100	990	900	141	D34x4xR45	D34x4xR45	A24	66
09640000	FH12/16	1/28+1/30	V	6,7	2	100	990	900	141	D36x3x45	D36x3xR45	A25	64
09680000	FH12/16	1/28,1/30	V	6,7	2	100	990	900	141	D36xR45	D36xR45	A25	64
09704000	FH12/16	2/33	V		2	100	990	900	112	D36xR45	D36xR45	A25	72
09702000	FH12/16	2/30,1/26	V	9,0	3	100	990	900	150	D34	D34	A20	95
09648000	FH12/16	2/32,1/26	V	8,6	3	100	990	900	118	D36x3x45	D36x3xR45	A21	99
09668000	FH12/16	2/32,1/26	V	8,6	3	100	990	900	118	D34x4xR45	D36xR45	A21	99
09696000	FH12/16	2/30,1/26	V	9,0	3	100	990	900	134	D34xR45	D34xR45	A21	95
09720000	FH12/16	2/30,1/26	V	9,0	3	100	990	900	142	S20xD50	S20xR50	A21	92
09732000	FH12/16	2/32,1/26,Silentb lock	V	8,6	3	100	990	900	118	S20xD50	S20xR50	A21	99
09686000	FH12/16	6/15	V	9,0	6	100	990	900	230	D34	D34	A20	90
09706000	FH12/16	6/15	V	9,0	6	100	990	900	230	D36	D36	A20	90
09701000	FH12/16	1/16,14/14	H	13,0	15								
09621000	FH12/16	2/45+1/68	H		3	75	815	815	55			D4	158
09675000	FH12/16	2/43+1/55	H	10,0	3	75	815	815	73			D4	147
09679000	FH12/16	2/49,1/55	H	26,0	3	75	815	815				D4	157
09681000	FH12/16	2/47,1/55	H	6,7	3	75	815	815	70			D4	155
09625000	FH12/16	11/26	H		11	75	815	815	49			D7	286
09631000	FH12/16	4/32	H	17,0	4	75	820	820	90			D1.1	
09633000	FH12/16	2/24	H	19,0	5	75	820	820	90			D1.1	
09703000	FH12/16	9/26	H	23,0	9	75	830	830	41			D7	234
09637000	FH12/16	11/26	H	23,0	11	75	830	830				D7	286
09709000	FH12/16	2/30,P/17,1/42	H	13,0	3	90						B8	
09623000	FH12/16	9/26	H		9	90	815	815	47			D7	234
09635000	FH12/16	9/26	H	13,0	9	90	830	830	56			D7	234
09639000	FH12/16	11/26	H	23,0	11	90	830	830				D7	286
09691000	FH12/16	3/32	H	11,5	3	90	910	820	148	S26		B4	
09693000	FH12/16	3/35	H	13,0	3	90	910	820	130	S26		B4	
09695000	FH12/16	2/35+1/45	H		3	90	910	820	127	S26		B8	
09669000	FH12/16	5/24	H	9,5	5	100	840	1025	148	D36x3xR45		B12	135
09671000	FH12/16	5/24	H	10,5	5	100	840	1015	148	D36x3xR45		B12	135
09671100	FH12/16	6/24	H		6	100	840	1015	148	R45		B12	162

FL4	VOLVO	FL4
------------	--------------	------------

Artikel.Nr.	Fahrzeugtyp	Info		Achsl.	Blattzahl	Breite	Lx/L1	Ly/L2	Spr.	Buchsen vorn	Buchsen hinten	Form	Paket stärke
Art.-No.	Type			Axle Load	Leaves	Width			Free Arch	Bush front	Bush rear	Shape	Total height
09600000	FL4	5/13	V	2,9	5		850	850				A1	65
09602000	FL4		V	2,9	1	80	850	850				A1	29
09604000	FL4	2/13/14	V	3,2	5	80	850	850		R45	S16xR46	A1	68
09601000	FL4	6/11,3/14	H		9		700	700				A1	108
09603000	FL4	3/21+P/21	H		3	80	700	700	130	R45	S16	A1	93



FL6	VOLVO	FL6
------------	--------------	------------

Artikel.Nr.	Fahrzeugtyp	Info		Achsl.	Blattzahl	Breite	Lx/L1	Ly/L2	Spr.	Buchsen vorn	Buchsen hinten	Form	Paket stärke
Art.-No.	Type			Axle Load	Leaves	Width			Free Arch	Bush front	Bush rear	Shape	Total height
09612000	FL608	1/33,P/16	V	4,1	1	80	850	850	115	D36x3xR45	D36x3xR45	A1	56
09610000	FL608	2/15,3/14	V	4,1	5	80	850	850	88	R45	S16xR46	A1	72
09708000	FL608	1/22	V		1	80	900	1015		D36	D36	A1	25
09605000	FL608	3/22+P/22	H	5,2	3	80	800	800	159	S16	S16	A1	97
09607000	FL608		H	5,2	9	80	800	800				A1	
09612000	FL609	1/33,P/16	V	4,1	1	80	850	850	115	D36x3xR45	D36x3xR45	A1	56
09610000	FL609	2/15,3/14	V	4,1	5	80	850	850	88	R45	S16xR46	A1	72
09708000	FL609	1/22	V		1	80	900	1015		D36	D36	A1	25
09605000	FL609	3/22+P/22	H	5,2	3	80	800	800	159	S16	S16	A1	97
09607000	FL609		H	5,2	9	80	800	800				A1	
09612000	FL610	1/33,P/16	V	4,1	1	80	850	850	115	D36x3xR45	D36x3xR45	A1	56
09610000	FL610	2/15,3/14	V	4,1	5	80	850	850	88	R45	S16xR46	A1	72
09708000	FL610	1/22	V		1	80	900	1015		D36	D36	A1	25
09605000	FL610	3/22+P/22	H	5,2	3	80	800	800	159	S16	S16	A1	97
09615000	FL610	3/22,P/25,1/25	H	7,2	4	80	800	800	175	S16	S16	A27	125
09673000	FL610	3/22,P/25,1/25	H	7,2	4	80	800	800	175	16	S16	A27	125
09607000	FL610		H	5,2	9	80	800	800				A1	
09613000	FL610	9/12,6/11	H	7,2	15	80	800	800		R45	R45	A27	174
09612000	FL611	1/33,P/16	V	4,1	1	80	850	850	115	D36x3xR45	D36x3xR45	A1	56
09610000	FL611	2/15,3/14	V	4,1	5	80	850	850	88	R45	S16xR46	A1	72
09708000	FL611	1/22	V		1	80	900	1015		D36	D36	A1	25
09605000	FL611	3/22+P/22	H	5,2	3	80	800	800	159	S16	S16	A1	97
09615000	FL611	3/22,P/25,1/25	H	7,2	4	80	800	800	175	S16	S16	A27	125
09673000	FL611	3/22,P/25,1/25	H	7,2	4	80	800	800	175	16	S16	A27	125
09607000	FL611		H	5,2	9	80	800	800				A1	
09613000	FL611	9/12,6/11	H	7,2	15	80	800	800		R45	R45	A27	174
09708000	FL612	1/22	V		1	80	900	1015		D36	D36	A1	25
09608000	FL612	1/36,P/20	V	4,1	1	80	900	900	138	D36x3xR45	R45	A1	59
09660000	FL612	2/29	V	5,0	2	80	900	900	151	D36x3xR45	D36x3xR45	A20	64
09606000	FL612	2/17+3/16	V	5,0	5	80	900	900	120	R45	S16	A1	82
09619000	FL612	10/14	H	9,2	10	80	650	650		D36xR50	D36xR50	A1	140
09617000	FL612	3/22,1/P,1/25,1/P	H	7,8	4	80	800	800	175	25	S16	A27	147
09611000	FL612	3/22,P/22,2/23	H	9,2	5	80	800	800	175	R45	S16	A3	149
09609000	FL612	10/12,6/12	H	9,2	16	80	800	800	165	R45	S16	A27	192
09708000	FL613	1/22	V		1	80	900	1015		D36	D36	A1	25
09608000	FL613	1/36,P/20	V	4,1	1	80	900	900	138	D36x3xR45	R45	A1	59
09660000	FL613	2/29	V	5,0	2	80	900	900	151	D36x3xR45	D36x3xR45	A20	64
09606000	FL613	2/17+3/16	V	5,0	5	80	900	900	120	R45	S16	A1	82
09619000	FL613	10/14	H	9,2	10	80	650	650		D36xR50	D36xR50	A1	140
09611000	FL613	3/22,P/22,2/23	H	9,2	5	80	800	800	175	R45	S16	A3	149
09609000	FL613	10/12,6/12	H	9,2	16	80	800	800	165	R45	S16	A27	192
09708000	FL614	1/22	V		1	80	900	1015		D36	D36	A1	25
09608000	FL614	1/36,P/20	V	4,1	1	80	900	900	138	D36x3xR45	R45	A1	59
09660000	FL614	2/29	V	5,0	2	80	900	900	151	D36x3xR45	D36x3xR45	A20	64
09606000	FL614	2/17+3/16	V	5,0	5	80	900	900	120	R45	S16	A1	82
09619000	FL614	10/14	H	9,2	10	80	650	650		D36xR50	D36xR50	A1	140
09611000	FL614	3/22,P/22,2/23	H	9,2	5	80	800	800	175	R45	S16	A3	149
09609000	FL614	10/12,6/12	H	9,2	16	80	800	800	165	R45	S16	A27	192
09708000	FL615	1/22	V		1	80	900	1015		D36	D36	A1	25
09660000	FL615	2/29	V	5,0	2	80	900	900	151	D36x3xR45	D36x3xR45	A20	64
09611000	FL615	3/22,P/22,2/23	H	9,2	5	80	800	800	175	R45	S16	A3	149
09609000	FL615	10/12,6/12	H	9,2	16	80	800	800	165	R45	S16	A27	192
09650000	FL616	3/21,4/20,2P/20,P/10	V	7,1	2	100	900	900	149	R36xD50	D36xR50	A20	66
09558000	FL616	2/30	V	6,7	2	100	935	935	171	R50	D36x3xR50	A20	66
09554000	FL616	2/28	V	5,4	2	100	935	935	180	R50	S20xR50	A25	62
09556000	FL616	2/28	V	5,4	2	100	935	935	180	R50	S20xR50	A25	62

FL6	VOLVO	FL6
------------	--------------	------------

Artikel.Nr.	Fahrzeugtyp	Info		Achsl.	Blattzahl	Breite	Lx/L1	Ly/L2	Spr.	Buchsen vorn	Buchsen hinten	Form	Paket stärke
Art. -No.	Type			Axle Load	Leaves	Width			Free Arch	Bush front	Bush rear	Shape	Total height
09560000	FL616	6/17	V	5,4	6	100	940	930	96	R45	D36x3xR50	A1	102
09562000	FL616	6/17	V	5,4	6	100	940	930		R45	D36x3xR50	A1	102
09564000	FL616		V	6,7	7	100	940	930		R45	R50	A1	
09575000	FL616	10/13	H	10,0	10	100	650	650	82	D36x3xR45	D36x3	A1	130
09571000	FL616	3/23,P,2/23,P	H	10,0	5	100	880	880	168	R45xR45	S20	A27	160
09573000	FL616	3/23,P,3/20	H	10,9	6	100	880	880	168	R45xR45	S20	A27	161
09567000	FL616	5/17,P,2/14,2/13,P	H	10,0	9	100	880	880	132	R45xR45	S20xR50	A27	174
09569000	FL616	5/17,P/,6/12	H	10,9	11	100	880	880	132	R45xR45	S20xR50	A27	171
09650000	FL617	3/21,4/20,2P/20,P/10	V	7,1	2	100	900	900	149	R36xD50	D36xR50	A20	66
09558000	FL617	2/30	V	6,7	2	100	935	935	171	R50	D36x3xR50	A20	66
09554000	FL617	2/28	V	5,4	2	100	935	935	180	R50	S20xR50	A25	62
09556000	FL617	2/28	V	5,4	2	100	935	935	180	R50	S20xR50	A25	62
09560000	FL617	6/17	V	5,4	6	100	940	930	96	R45	D36x3xR50	A1	102
09562000	FL617	6/17	V	5,4	6	100	940	930		R45	D36x3xR50	A1	102
09564000	FL617		V	6,7	7	100	940	930		R45	R50	A1	
09575000	FL617	10/13	H	10,0	10	100	650	650	82	D36x3xR45	D36x3	A1	130
09571000	FL617	3/23,P,2/23,P	H	10,0	5	100	880	880	168	R45xR45	S20	A27	160
09573000	FL617	3/23,P,3/20	H	10,9	6	100	880	880	168	R45xR45	S20	A27	161
09567000	FL617	5/17,2/14,2/13	H	10,0	9	100	880	880	132	R45xR45	S20xR50	A27	174
09569000	FL617	5/17,6/12	H	10,9	11	100	880	880	132	R45xR45	S20xR50	A27	171
09650000	FL618	3/21,4/20,2P/20,P/10	V	7,1	2	100	900	900	149	R36xD50	D36xR50	A20	66
09650000	FL620	3/21,4/20,2P/20,P/10	V	7,1	2	100	900	900	149	R36xD50	D36xR50	A20	66
09650000	FL621	3/21,4/20,2P/20,P/10	V	7,1	2	100	900	900	149	R36xD50	D36xR50	A20	66
09650000	FL622	3/21,4/20,2P/20,P/10	V	7,1	2	100	900	900	149	R36xD50	D36xR50	A20	66
09650000	FL623	3/21,4/20,2P/20,P/10	V	7,1	2	100	900	900	149	R36xD50	D36xR50	A20	66
09650000	FL624	3/21,4/20,2P/20,P/10	V	7,1	2	100	900	900	149	R36xD50	D36xR50	A20	66
09650000	FL625	3/21,4/20,2P/20,P/10	V	7,1	2	100	900	900	149	R36xD50	D36xR50	A20	66
09650000	FL626	3/21,4/20,2P/20,P/10	V	7,1	2	100	900	900	149	R36xD50	D36xR50	A20	66

FL7	VOLVO	FL7
------------	--------------	------------

Artikel.Nr.	Fahrzeugtyp	Info		Achsl.	Blattzahl	Breite	Lx/L1	Ly/L2	Spr.	Buchsen vorn	Buchsen hinten	Form	Paket stärke
Art.-No.	Type			Axle Load	Leaves	Width			Free Arch	Bush front	Bush rear	Shape	Total height
09530000	FL7 4x2	2/27+P/12	V	6,5	2	100	935	815	163	D36x3xR45	D36x3xR45	A25	75
09532000	FL7 4x2	2/29+P/20	V	7,5	2	100	935	815	140	D36x3xR45	D36x3xR45	A25	84
09528000	FL7 4x2	3/26	V	7,5	3	100	935	815	163	D36x3xR45	D36x3xR45	A20	87
09566000	FL7 4x2	10/13	V	7,5	10	100	935	815	172	D36x3xR45	D36x3xR45	A1	130
09572000	FL7 4x2	10/12	V	6,5	10	100	935	815	155	D36x3xR45	D36x3xR45	A1	120
09657000	FL7 4x2	3/12,8/14	H	10,0	11	100	720	820	62			D1.1	148
09559000	FL7 4x2	3/32	H	13,0	3	100	895	820	119	R55	D36x3xR55	A25	105
09659000	FL7 4x2	3/21,3/20	H	13,0	6	100	975	975	175			C6	144
09649000	FL7 4x2	3/21,4/20,2P/20, P/10	H	13,0	7	100	980	980	170			C5	214
09515000	FL7 4x2	5/17,1/10,4/13	H	10,0	10	100	1000	1000	170			C4	147
09517000	FL7 4x2	5/17,1/10,2/15,4/14	H	13,0	12	100	1007	1007	179			C4	181
09511000	FL7 4x2	14/10,1/10,11/10	H	13,0	26	100	1025	1025	275			C4	260
09530000	FL7 6x2	2/27+P/12	V	6,5	2	100	935	815	163	D36x3xR45	D36x3xR45	A25	75
09532000	FL7 6x2	2/29+P/20	V	7,5	2	100	935	815	140	D36x3xR45	D36x3xR45	A25	84
09528000	FL7 6x2	3/26	V	7,5	3	100	935	815	163	D36x3xR45	D36x3xR45	A20	87
09566000	FL7 6x2	10/13	V	7,5	10	100	935	815	172	D36x3xR45	D36x3xR45	A1	130
09572000	FL7 6x2	10/12	V	6,5	10	100	935	815	155	D36x3xR45	D36x3xR45	A1	120
09651000	FL7 6x2	4/32	H	18,0	4	80	640	960	25			D1.1	136
09645000	FL7 6x2	5/32	H	18,0	5	80	640	960	20			D1.1	170
09655000	FL7 6x2	3/30	H	18,0	3	100	840	990	130	D36x3xR45		B12	99
09463000	FL7 6x2	5/22	H	9,0	5	100	840	990	145	D36x3xR45		B12	125
09463200	FL7 6x2	5/22	H	9,0	5	100	840	990	160			B12	125
09463100	FL7 6x2	6/22	H	10,0	6	100	840	990	150	D36xR45		B12	150
09463300	FL7 6x2	6/22	H	9,0	6	100	840	990	160			B12	150
09499000	FL7 6x2		H	2X9	8	100	840	990				B1.11	136
09559000	FL7 6x2	3/32	H	13,0	3	100	895	820	119	R55	D36x3xR55	A25	105
09530000	FL7 6x4	2/27+P/12	V	6,5	2	100	935	815	163	D36x3xR45	D36x3xR45	A25	75
09532000	FL7 6x4	2/29+P/20	V	7,5	2	100	935	815	140	D36x3xR45	D36x3xR45	A25	84
09528000	FL7 6x4	3/26	V	7,5	3	100	935	815	163	D36x3xR45	D36x3xR45	A20	87
09566000	FL7 6x4	10/13	V	7,5	10	100	935	815	172	D36x3xR45	D36x3xR45	A1	130
09572000	FL7 6x4	10/12	V	6,5	10	100	935	815	155	D36x3xR45	D36x3xR45	A1	120
09585000	FL7 6x4	8/24	H	20,0	8	90	790	790	55			D11	192
09589000	FL7 6x4	5/26	H	17,0	5	90	793	793	70			D1.1	130
09565000	FL7 6x4	9/26	H	20,0	9	90	793	793	70			D11	234
09587000	FL7 6x4	2/45	H	17,0	2	90	795	795	52			D1.1	96
09579000	FL7 6x4	2/52,P/15	H	8,5	2	90	795	795	41			D6	125
09563000	FL7 6x4	2/54,P/12	H	13,0	2	90	860	860	17			D6	126
09513000	FL7 6x4	10/11	H	18,0	10	100						D1.1	
09546000	FL7 8x2	2/27,P/30	V		2	100	835	815	116	D36x3xR45	D36x3xR45	A25	89
09552000	FL7 8x2	2/54,P/18	V	6,5	2	100	935	815	128	D36x3xR45	D36x3xR45	A22	99
09624000	FL7 8x2	2/29	V		2	100	935	815	130	D36x3xR45	D36x3xR45	A25	99
09463000	FL7 8x2	5/22	H	9,0	5	100	840	990	145	D36x3xR45		B12	125
09463200	FL7 8x2	5/22	H	9,0	5	100	840	990	160			B12	125
09463100	FL7 8x2	6/22	H	10,0	6	100	840	990	150	D36xR45		B12	150
09463300	FL7 8x2	6/22	H	9,0	6	100	840	990	160			B12	150
09499000	FL7 8x2		H	2X9	8	100	840	990				B1.11	136
09546000	FL7 8x4	2/27,P/30	V		2	100	835	815	116	D36x3xR45	D36x3xR45	A25	89
09626000	FL7 8x4	2/27	V		2	100	835	815	120	D36x3xR45	D36x3xR45	A25	60
09552000	FL7 8x4	2/54,P/18	V	6,5	2	100	935	815	128	D36x3xR45	D36x3xR45	A22	99
09624000	FL7 8x4	2/29	V		2	100	935	815	130	D36x3xR45	D36x3xR45	A25	99
09585000	FL7 8x4	8/24	H	20,0	8	90	790	790	55			D11	192
09589000	FL7 8x4	5/26	H	17,0	5	90	793	793	70			D1.1	130
09565000	FL7 8x4	9/26	H	20,0	9	90	793	793	70			D11	234
09587000	FL7 8x4	2/45	H	17,0	2	90	795	795	52			D1.1	96
09579000	FL7 8x4	2/52,P/15	H	8,5	2	90	795	795	41			D6	125

FL7	VOLVO	FL7
------------	--------------	------------

Artikel.Nr.	Fahrzeugtyp	Info		Achsl.	Blattzahl	Breite	Lx/L1	Ly/L2	Spr.	Buchsen vorn	Buchsen hinten	Form	Paket stärke
Art.-No.	Type			Axle Load	Leaves	Width			Free Arch	Bush front	Bush rear	Shape	Total height
09563000	FL7 8x4	2/54,P/12	H	13,0	2	90	860	860	17			D6	126
09513000	FL7 8x4	10/11	H	18,0	10	100						D1.1	



FL10	VOLVO	FL10
-------------	--------------	-------------

Artikel.Nr.	Fahrzeugtyp	Info		Achsl.	Blattzahl	Breite	Lx/L1	Ly/L2	Spr.	Buchsen vorn	Buchsen hinten	Form	Paket stärke
Art.-No.	Type			Axle Load	Leaves	Width			Free Arch	Bush front	Bush rear	Shape	Total height
09530000	FL10 4x2	2/27+P/12	V	6,5	2	100	935	815	163	D36x3xR45	D36x3xR45	A25	75
09532000	FL10 4x2	2/29+P/20	V	7,5	2	100	935	815	140	D36x3xR45	D36x3xR45	A25	84
09528000	FL10 4x2	3/26	V	7,5	3	100	935	815	163	D36x3xR45	D36x3xR45	A20	87
09566000	FL10 4x2	10/13	V	7,5	10	100	935	815	172	D36x3xR45	D36x3xR45	A1	130
09572000	FL10 4x2	10/12	V	6,5	10	100	935	815	155	D36x3xR45	D36x3xR45	A1	120
09616000	FL10 4x2	10/13	V	7,5	10	100	1035	815		R45	R45	A1	130
09657000	FL10 4x2	3/12,8/14	H	10,0	11	100	720	820	62			D1.1	148
09559000	FL10 4x2	3/32	H	13,0	3	100	895	820	119	R55	D36x3xR55	A25	105
09659000	FL10 4x2	3/21,3/20	H	13,0	6	100	975	975	175			C6	144
09649000	FL10 4x2	3/21,4/20,2P/20, P/10	H	13,0	7	100	980	980	170			C5	214
09515000	FL10 4x2	5/17,1/10,4/13	H	10,0	10	100	1000	1000	170			C4	147
09517000	FL10 4x2	5/17,1/10,2/15,4/14	H	13,0	12	100	1007	1007	179			C4	181
09511000	FL10 4x2	14/10,1/10,11/10	H	13,0	26	100	1025	1025	275			C4	260
09530000	FL10 6x2	2/27+P/12	V	6,5	2	100	935	815	163	D36x3xR45	D36x3xR45	A25	75
09532000	FL10 6x2	2/29+P/20	V	7,5	2	100	935	815	140	D36x3xR45	D36x3xR45	A25	84
09528000	FL10 6x2	3/26	V	7,5	3	100	935	815	163	D36x3xR45	D36x3xR45	A20	87
09566000	FL10 6x2	10/13	V	7,5	10	100	935	815	172	D36x3xR45	D36x3xR45	A1	130
09572000	FL10 6x2	10/12	V	6,5	10	100	935	815	155	D36x3xR45	D36x3xR45	A1	120
09616000	FL10 6x2	10/13	V	7,5	10	100	1035	815		R45	R45	A1	130
09651000	FL10 6x2	4/32	H	18,0	4	80	640	960	25			D1.1	136
09645000	FL10 6x2	5/32	H	18,0	5	80	640	960	20			D1.1	170
09657000	FL10 6x2	3/12,8/14	H	10,0	11	100	720	820	62			D1.1	148
09655000	FL10 6x2	3/30	H	18,0	3	100	840	990	130	D36x3xR45		B12	99
09463000	FL10 6x2	5/22	H	9,0	5	100	840	990	145	D36x3xR45		B12	125
09463100	FL10 6x2	6/22	H	10,0	6	100	840	990	150	D36xR45		B12	150
09499000	FL10 6x2		H	2X9	8	100	840	990				B1.11	136
09559000	FL10 6x2	3/32	H	13,0	3	100	895	820	119	R55	D36x3xR55	A25	105
09530000	FL10 6x4	2/27+P/12	V	6,5	2	100	935	815	163	D36x3xR45	D36x3xR45	A25	75
09532000	FL10 6x4	2/29+P/20	V	7,5	2	100	935	815	140	D36x3xR45	D36x3xR45	A25	84
09528000	FL10 6x4	3/26	V	7,5	3	100	935	815	163	D36x3xR45	D36x3xR45	A20	87
09566000	FL10 6x4	10/13	V	7,5	10	100	935	815	172	D36x3xR45	D36x3xR45	A1	130
09572000	FL10 6x4	10/12	V	6,5	10	100	935	815	155	D36x3xR45	D36x3xR45	A1	120
09616000	FL10 6x4	10/13	V	7,5	10	100	1035	815		R45	R45	A1	130
09585000	FL10 6x4	8/24	H	20,0	8	90	790	790	55			D11	192
09589000	FL10 6x4	5/26	H	17,0	5	90	793	793	70			D1.1	130
09565000	FL10 6x4	9/26	H	20,0	9	90	793	793	70			D11	234
09587000	FL10 6x4	2/45	H	17,0	2	90	795	795	52			D1.1	96
09579000	FL10 6x4	2/52,P/15	H	8,5	2	90	795	795	41			D6	125
09563000	FL10 6x4	2/54,P/12	H	13,0	2	90	860	860	17			D6	126
09513000	FL10 6x4	10/11	H	18,0	10	100						D1.1	
09546000	FL10 8x2	2/27,P/30	V		2	100	835	815	116	D36x3xR45	D36x3xR45	A25	89
09626000	FL10 8x2	2/27	V		2	100	835	815	120	D36x3xR45	D36x3xR45	A25	60
09636000	FL10 8x2	3/27	V	7,5	3	100	835	815	120	D36x3xR45	D36x3xR45	A22	90
09552000	FL10 8x2	2/54,P/18	V	6,5	2	100	935	815	128	D36x3xR45	D36x3xR45	A22	99
09624000	FL10 8x2	2/29	V		2	100	935	815	130	D36x3xR45	D36x3xR45	A25	99
09634000	FL10 8x2	3/30	V	7,5	3	100	935	815	103	D36x3xR45	D36x3xR45	A1	99
09463000	FL10 8x2	5/22	H	9,0	5	100	840	990	145	D36x3xR45		B12	125
09463100	FL10 8x2	6/22	H	10,0	6	100	840	990	150	D36xR45		B12	150
09499000	FL10 8x2		H	2X9	8	100	840	990				B1.11	136
09546000	FL10 8x4	2/27,P/30	V		2	100	835	815	116	D36x3xR45	D36x3xR45	A25	89
09626000	FL10 8x4	2/27	V		2	100	835	815	120	D36x3xR45	D36x3xR45	A25	60
09636000	FL10 8x4	3/27	V	7,5	3	100	835	815	120	D36x3xR45	D36x3xR45	A22	90
09552000	FL10 8x4	2/54,P/18	V	6,5	2	100	935	815	128	D36x3xR45	D36x3xR45	A22	99
09624000	FL10 8x4	2/29	V		2	100	935	815	130	D36x3xR45	D36x3xR45	A25	99
09634000	FL10 8x4	3/30	V	7,5	3	100	935	815	103	D36x3xR45	D36x3xR45	A1	99

FL10	VOLVO	FL10
-------------	--------------	-------------

Artikel.Nr.	Fahrzeugtyp	Info		Achsl.	Blattzahl	Breite	Lx/L1	Ly/L2	Spr.	Buchsen vorn	Buchsen hinten	Form	Paket stärke
Art.-No.	Type			Axle Load	Leaves	Width			Free Arch	Bush front	Bush rear	Shape	Total height
09585000	FL10 8x4	8/24	H	20,0	8	90	790	790	55			D11	192
09589000	FL10 8x4	5/26	H	17,0	5	90	793	793	70			D1.1	130
09565000	FL10 8x4	9/26	H	20,0	9	90	793	793	70			D11	234
09587000	FL10 8x4	2/45	H	17,0	2	90	795	795	52			D1.1	96
09579000	FL10 8x4	2/52,P/15	H	8,5	2	90	795	795	41			D6	125
09563000	FL10 8x4	2/54,P/12	H	13,0	2	90	860	860	17			D6	126
09513000	FL10 8x4	10/11	H	18,0	10	100						D1.1	



FLC	VOLVO	FLC
------------	--------------	------------

Artikel.Nr.	Fahrzeugtyp	Info		Achsl.	Blattzahl	Breite	Lx/L1	Ly/L2	Spr.	Buchsen vorn	Buchsen hinten	Form	Paket stärke
Art.-No.	Type			Axle Load	Leaves	Width			Free Arch	Bush front	Bush rear	Shape	Total height
09726000	FLC		V	3,2	1	80	850	850		D36xR45	D36xR45	A1	31
09604000	FLC	2/13/14	V	3,2	5	80	850	850		R45	S16x46	A1	68
09610000	FLC	2/15,3/14	V	4,1	5	80	850	850	88	R45	S16xR46	A1	72
09717000	FLC	9/12	H	5,2	9	80	800	800		S16xR46	S16xD46	A1	108
09543000	FLC	9/ ,6/	H		15	80	800	950	170	R45		B7	174
09683000	FLC	2/29,2P/21	H	5,6	2	80	900	900	145	16x46	S16xD46	A20	106



FM7	VOLVO	FM7
------------	--------------	------------

Artikel.Nr.	Fahrzeugtyp	Info		Achsl.	Blattzahl	Breite	Lx/L1	Ly/L2	Spr.	Buchsen vorn	Buchsen hinten	Form	Paket stärke
Art. -No.	Type			Axle Load	Leaves	Width			Free Arch	Bush front	Bush rear	Shape	Total height
09714000	FM7	1/22,2/24,Silentblock	V		3	100	795	795	126	S20x5R0	S20xR50	A23	79
09658000	FM7	3/12,8/14	V		3	100	795	795	130	D36x3xR45	D34x4xR45	D1.1	79
09688000	FM7	2/32	V		2	100	990	900	147	D36xR45	D36xR45	A21	70
09664000	FM7	2/30	V	7,1	2	100	990	900	141	D34x4xR45	D34x4xR45	A23	66
09666000	FM7	2/32	V		2	100	990	900	118	D34x4xR45	D34x4xR45	A23	70
09700000	FM7	2/35	V	7,1	2	100	990	900	112	D34	D34	A23	76
09712000	FM7	2/32,Silentblock	V	8,0	2	100	990	900	124	S20xR50	S20xR50	A23	70
09716000	FM7	2/35	V	7,1	2	100	990	900		R45	R45	A23	
09722000	FM7	2/30	V	7,1	2	100	990	900	142	S20xD50	S20xR50	A23	64
09734000	FM7	2/32,Silentblock	V	8,0	2	100	990	900	118	S20xD50	S20xR50	A23	70
09662000	FM7	2/30	V	7,1	2	100	990	900	141	D34x4xR45	D34x4xR45	A24	66
09680000	FM7	1/28,1/30	V	6,7	2	100	990	900	141	D36xR45	D36xR45	A25	64
09704000	FM7	2/33	V		2	100	990	900	112	D36xR45	D36xR45	A25	72
09702000	FM7	2/30,1/26	V	9,0	3	100	990	900	150	D34	D34	A20	95
09668000	FM7	2/32,1/26	V	8,6	3	100	990	900	118	D34x4xR45	D36xR45	A21	99
09696000	FM7	2/30,1/26	V	9,0	3	100	990	900	134	D34xR45	D34xR45	A21	95
09720000	FM7	2/30,1/26	V	9,0	3	100	990	900	142	S20xD50	S20xR50	A21	92
09732000	FM7	2/32,1/26,Silentblock	V	8,6	3	100	990	900	118	S20xD50	S20xR50	A21	99
09686000	FM7	6/15	V	9,0	6	100	990	900	230	D34	D34	A20	90
09675000	FM7	2/43+1/55	H	10,0	3	75	815	815	73			D4	147
09679000	FM7	2/49,1/55	H	26,0	3	75	815	815				D4	157
09631000	FM7	4/32	H	17,0	4	75	820	820	90			D1.1	
09633000	FM7	2/24	H	19,0	5	75	820	820	90			D1.1	
09703000	FM7	9/26	H	23,0	9	75	830	830	41			D7	234
09637000	FM7	11/26	H	23,0	11	75	830	830				D7	286
09709000	FM7	2/30,P/17,1/42	H	13,0	3	90						B8	
09635000	FM7	9/26	H	13,0	9	90	830	830	56			D7	234
09639000	FM7	11/26	H	23,0	11	90	830	830				D7	286
09693000	FM7	3/35	H	13,0	3	90	910	820	130	S26		B4	
09695000	FM7	2/35+1/45	H		3	90	910	820	127	S26		B8	
09669000	FM7	5/24	H	9,5	5	100	840	1025	148	D36x3xR45		B12	135
09671000	FM7	5/24	H	10,5	5	100	840	1015	148	D36x3xR45		B12	135
09705000	FM7	4/29	H		4								
09701000	FM7	1/16,14/14	H	13,0	15								

FM9	VOLVO	FM9
------------	--------------	------------

Artikel.Nr.	Fahrzeugtyp	Info		Achsl.	Blattzahl	Breite	Lx/L1	Ly/L2	Spr.	Buchsen vorn	Buchsen hinten	Form	Paket stärke
Art.-No.	Type			Axle Load	Leaves	Width			Free Arch	Bush front	Bush rear	Shape	Total height
09692000	FM9	1/24,2/25	V		3	100	795	795	113	D36xR45	D36xR45	A23	83
09714000	FM9	1/22,2/24,Silentb lock	V		3	100	795	795	126	S20xR50	S20xR50	A23	79
09658000	FM9	3/12,8/14	V		3	100	795	795	130	D36x3xR45	D34x4xR45	D1.1	79
09688000	FM9	2/32	V		2	100	990	900	147	D36xR45	D36xR45	A21	70
09664000	FM9	2/30	V	7,1	2	100	990	900	141	D34x4xR45	D34x4xR45	A23	66
09666000	FM9	2/32	V		2	100	990	900	118	D34x4xR45	D34x4xR45	A23	70
09712000	FM9	2/32,Silentblock	V	8,0	2	100	990	900	124	S20xR50	S20xR50	A23	70
09722000	FM9	2/30	V	7,1	2	100	990	900	142	S20xD50	S20xR50	A23	64
09662000	FM9	2/30	V	7,1	2	100	990	900	141	D34x4xR45	D34x4xR45	A24	66
09680000	FM9	1/28,1/30	V	6,7	2	100	990	900	141	D36xR45	D36xR45	A25	64
09704000	FM9	2/33	V		2	100	990	900	112	D36xR45	D36xR45	A25	72
09668000	FM9	2/32,1/26	V	8,6	3	100	990	900	118	D34x4xR45	D36xR45	A21	99
09696000	FM9	2/30,1/26	V	9,0	3	100	990	900	134	D34xR45	D34xR45	A21	95
09720000	FM9	2/30,1/26	V	9,0	3	100	990	900	142	S20xD50	S20xR50	A21	92
09732000	FM9	2/32,1/26,Silentb lock	V	8,6	3	100	990	900	118	S20xD50	S20xR50	A21	99
09724000	FM9		V	6,0	3	100	990	900		R45	R45	A25	
09686000	FM9	6/15	V	9,0	6	100	990	900	230	D34	D34	A20	90
09713000	FM9	3/35,1/45	H	13,0	4							B8	
09705000	FM9	4/29	H		4								
09701000	FM9	1/16,14/14	H	13,0	15								
09675000	FM9	2/43+1/55	H	10,0	3	75	815	815	73			D4	147
09679000	FM9	2/49,1/55	H	26,0	3	75	815	815				D4	157
09631000	FM9	4/32	H	17,0	4	75	820	820	90			D1.1	
09633000	FM9	2/24	H	19,0	5	75	820	820	90			D1.1	
09703000	FM9	9/26	H	23,0	9	75	830	830	41			D7	234
09637000	FM9	11/26	H	23,0	11	75	830	830				D7	286
09709000	FM9	2/30,P/17,1/42	H	13,0	3	90						B8	
09635000	FM9	9/26	H	13,0	9	90	830	830	56			D7	234
09639000	FM9	11/26	H	23,0	11	90	830	830				D7	286
09693000	FM9	3/35	H	13,0	3	90	910	820	130	S26		B4	
09695000	FM9	2/35+1/45	H		3	90	910	820	127	S26		B8	
09669000	FM9	5/24	H	9,5	5	100	840	1025	148	D36x3xR45		B12	135
09671000	FM9	5/24	H	10,5	5	100	840	1015	148	D36x3xR45		B12	135

FM10	VOLVO	FM10
-------------	--------------	-------------

Artikel.Nr.	Fahrzeugtyp	Info		Achsl.	Blattzahl	Breite	Lx/L1	Ly/L2	Spr.	Buchsen vorn	Buchsen hinten	Form	Paket stärke
Art. -No.	Type			Axle Load	Leaves	Width			Free Arch	Bush front	Bush rear	Shape	Total height
09714000	FM10	1/22,2/24,Silentblock	V		3	100	795	795	126	S20xR50	S20xR50	A23	79
09658000	FM10	3/12,8/14	V		3	100	795	795	130	D36x3xR45	D34x4xR45	D1.1	79
09686000	FM10	6/15	V	9,0	6	100	990	900	230	D34	D34	A20	90
09702000	FM10	2/30,1/26	V	9,0	3	100	990	900	150	D34	D34	A20	95
09668000	FM10	2/32,1/26	V	8,6	3	100	990	900	118	D34x4xR45	D36xR45	A21	99
09688000	FM10	2/32	V		2	100	990	900	147	D36xR45	D36xR45	A21	70
09696000	FM10	2/30,1/26	V	9,0	3	100	990	900	134	D34xR45	D34xR45	A21	95
09720000	FM10	2/30,1/26	V	9,0	3	100	990	900	142	S20xD50	S20xR50	A21	92
09732000	FM10	2/32,1/26,Silentblock	V	8,6	3	100	990	900	118	S20xD50	S20xR50	A21	99
09664000	FM10	2/30	V	7,1	2	100	990	900	141	D34x4xR45	D34x4xR45	A23	66
09666000	FM10	2/32	V		2	100	990	900	118	D34x4xR45	D34x4xR45	A23	70
09700000	FM10	2/35	V	7,1	2	100	990	900	112	D34	D34	A23	76
09712000	FM10	2/32,Silentblock	V	8,0	2	100	990	900	124	S20xR50	S20xR50	A23	70
09716000	FM10	2/35	V	7,1	2	100	990	900		R45	R45	A23	
09722000	FM10	2/30	V	7,1	2	100	990	900	142	S20xD50	S20xR50	A23	64
09734000	FM10	2/32,Silentblock	V	8,0	2	100	990	900	118	S20xD50	S20xR50	A23	70
09662000	FM10	2/30	V	7,1	2	100	990	900	141	D34x4xR45	D34x4xR45	A24	66
09680000	FM10	1/28,1/30	V	6,7	2	100	990	900	141	D36xR45	D36xR45	A25	64
09704000	FM10	2/33	V		2	100	990	900	112	D36xR45	D36xR45	A25	72
09724000	FM10		V	6,0	3	100	990	900		R45	R45	A25	
09705000	FM10	4/29	H		4								
09701000	FM10	1/16,14/14	H	13,0	15								
09669000	FM10	5/24	H	9,5	5	100	840	1025	148	D36x3xR45		B12	135
09671000	FM10	5/24	H	10,5	5	100	840	1015	148	D36x3xR45		B12	135
09675000	FM10	2/43+1/55	H	10,0	3	75	815	815	73			D4	147
09679000	FM10	2/49,1/55	H	26,0	3	75	815	815				D4	157
09631000	FM10	4/32	H	17,0	4	75	820	820	90			D1.1	
09633000	FM10	2/24	H	19,0	5	75	820	820	90			D1.1	
09703000	FM10	9/26	H	23,0	9	75	830	830	41			D7	234
09637000	FM10	11/26	H	23,0	11	75	830	830				D7	286
09709000	FM10	2/30,P/17,1/42	H	13,0	3	90						B8	
09635000	FM10	9/26	H	13,0	9	90	830	830	56			D7	234
09639000	FM10	11/26	H	23,0	11	90	830	830				D7	286
09693000	FM10	3/35	H	13,0	3	90	910	820	130	S26		B4	
09695000	FM10	2/35+1/45	H		3	90	910	820	127	S26		B8	
09711000	FM10	3/35	H		3	90	910	820		S26		B8	

FM12	VOLVO	FM12
-------------	--------------	-------------

Artikel.Nr.	Fahrzeugtyp	Info		Achsl.	Blattzahl	Breite	Lx/L1	Ly/L2	Spr.	Buchsen vorn	Buchsen hinten	Form	Paket stärke
Art.-No.	Type			Axle Load	Leaves	Width			Free Arch	Bush front	Bush rear	Shape	Total height
09692000	FM12	1/24,2/25	V		3	100	795	795	113	D36xR45	D36xR45	A23	83
09714000	FM12	1/22,2/24,Silentblock	V		3	100	795	795	126	S20xR50	S20xR50	A23	79
09658000	FM12	3/12,8/14	V		3	100	795	795	130	D36x3xR45	D34x4xR45	D1.1	79
09688000	FM12	2/32	V		2	100	990	900	147	D36xR45	D36xR45	A21	70
09664000	FM12	2/30	V	7,1	2	100	990	900	141	D34x4xR45	D34x4xR45	A23	66
09666000	FM12	2/32	V		2	100	990	900	118	D34x4xR45	D34x4xR45	A23	70
09700000	FM12	2/35	V	7,1	2	100	990	900	112	D34	D34	A23	76
09712000	FM12	2/32,Silentblock	V	8,0	2	100	990	900	124	S20xR50	S20xR50	A23	70
09716000	FM12	2/35	V	7,1	2	100	990	900		R45	R45	A23	
09722000	FM12	2/30	V	7,1	2	100	990	900	142	S20xD50	S20xR50	A23	64
09734000	FM12	2/32,Silentblock	V	8,0	2	100	990	900	118	S20xD50	S20xR50	A23	70
09662000	FM12	2/30	V	7,1	2	100	990	900	141	D34x4xR45	D34x4xR45	A24	66
09680000	FM12	1/28,1/30	V	6,7	2	100	990	900	141	D36xR45	D36xR45	A25	64
09704000	FM12	2/33	V		2	100	990	900	112	D36xR45	D36xR45	A25	72
09702000	FM12	2/30,1/26	V	9,0	3	100	990	900	150	D34	D34	A20	95
09668000	FM12	2/32,1/26	V	8,6	3	100	990	900	118	D34x4xR45	D36xR45	A21	99
09696000	FM12	2/30,1/26	V	9,0	3	100	990	900	134	D34xR45	D34xR45	A21	95
09720000	FM12	2/30,1/26	V	9,0	3	100	990	900	142	S20xD50	S20xR50	A21	92
09732000	FM12	2/32,1/26,Silentblock	V	8,6	3	100	990	900	118	S20xD50	S20xR50	A21	99
09686000	FM12	6/15	V	9,0	6	100	990	900	230	D34	D34	A20	90
09698000	FM12	3/27	V	8,0	3	100	1090	950	158	D34xR45	D34xR45	A23	90
09710000	FM12	3/28	V	9,0	3	100	1090	950	152	D34xR45	D34xR45	A23	93
09713000	FM12	3/35,1/45	H	13,0	4							B8	
09705000	FM12	4/29	H		4								
09701000	FM12	1/16,14/14	H	13,0	15								
09675000	FM12	2/43+1/55	H	10,0	3	75	815	815	73			D4	147
09679000	FM12	2/49,1/55	H	26,0	3	75	815	815				D4	157
09631000	FM12	4/32	H	17,0	4	75	820	820	90			D1.1	
09633000	FM12	2/24	H	19,0	5	75	820	820	90			D1.1	
09703000	FM12	9/26	H	23,0	9	75	830	830	41			D7	234
09637000	FM12	11/26	H	23,0	11	75	830	830				D7	286
09709000	FM12	2/30,P/17,1/42	H	13,0	3	90						B8	
09707000	FM12	2/30,1/40	H	8,0	3	90	800	910				B8	
09635000	FM12	9/26	H	13,0	9	90	830	830	56			D7	234
09639000	FM12	11/26	H	23,0	11	90	830	830				D7	286
09693000	FM12	3/35	H	13,0	3	90	910	820	130	S26		B4	
09695000	FM12	2/35+1/45	H		3	90	910	820	127	S26		B8	
09711000	FM12	3/35	H		3	90	910	820		S26		B8	
09669000	FM12	5/24	H	9,5	5	100	840	1025	148	D36x3xR45		B12	135
09671000	FM12	5/24	H	10,5	5	100	840	1015	148	D36x3xR45		B12	135

FS7	VOLVO	FS7
------------	--------------	------------

Artikel.Nr.	Fahrzeugtyp	Info		Achsl.	Blattzahl	Breite	Lx/L1	Ly/L2	Spr.	Buchsen vorn	Buchsen hinten	Form	Paket stärke
Art.-No.	Type			Axle Load	Leaves	Width			Free Arch	Bush front	Bush rear	Shape	Total height
09594000	FS7 4x2	2/25	V	5,5	2	100	900	900		D36	D36	A1	
09596000	FS7 4x2	2,27	V	6,0	2	100	900	900		D36	D36	A1	
09592000	FS7 4x2	2/27	V	6,7	2	100	900	900	162	D36xR50	D36x50	A20	60
09650000	FS7 4x2	3/21,4/20,2P/20, P/10	V	7,1	2	100	900	900	149	D36xR50	D36xR50	A20	66
09672000	FS7 4x2	2/30,P/40	V	7,1	2	100	900	900	165	D36x3xR50	D36x3XR50	A20	106
09678000	FS7 4x2	3/26	V	8,0	3	100	900	900		D36	D36x3	A1	
09598000	FS7 4x2		V	6,0	5	100	900	900		D36		A1	
09676000	FS7 4x2	6/17	V	7,1	6	100	900	900	127	D36	D36x3	A1	107
09627000	FS7 4x2	5/23	H	11,5	5	80	650	740	53	D36xR45		B11	130
09593000	FS7 4x2	3/26,P/15,2/26,2 P/15	H	10,9	5	80	880	990	139	D36x45		B6	190
09595000	FS7 4x2	3/26,1/15,3/26	H	13,0	6	80	880	985	139	D36x45		B6	187



N7	VOLVO	N7
-----------	--------------	-----------

Artikel.Nr.	Fahrzeugtyp	Info		Achsl.	Blattzahl	Breite	Lx/L1	Ly/L2	Spr.	Buchsen vorn	Buchsen hinten	Form	Paket stärke
Art.-No.	Type			Axle Load	Leaves	Width			Free Arch	Bush front	Bush rear	Shape	Total height
09488000	N7 4x2	10/12	V	6,5	10	100	930	1040	215	D36x3xR45		B1.11	120
09566000	N7 4x2	10/13	V	7,5	10	100	935	815	172	D36x3xR45	D36x3xR45	A1	130
09572000	N7 4x2	10/12	V	6,5	10	100	935	815	155	D36x3xR45	D36x3XR45	A1	120
09586000	N7 4x2	10/12	V	6,5	10	100	935	1035	195	D36x3xR45		B1.11	120
09450000	N7 4x2	2/18,2/19,4P/11	V	7,5	4	100	940	1045	180	D36x3xR45		B1.11	116
09443000	N7 4x2	2/13,9/12,P/12,9/9	H	10,0	20	90	750	750	145	D36x3xR45	D36x3xR45	A27	227
09515000	N7 4x2	5/17,1/10,4/13	H	10,0	10	100	1000	1000	170			C4	147
09517000	N7 4x2	5/17,1/10,2/15,4/14	H	13,0	12	100	1007	1007	179			C4	181
09511000	N7 4x2	14/10,1/10,11/10	H	13,0	26	100	1025	1025	275			C4	260
09460000	N7 4x4	3/23,P/10	V	6,5	3	100	935	1025	146	D36x3xR45		B11	88
09488000	N7 6x2	10/12	V	6,5	10	100	930	1040	215	D36x3xR45		B1.11	120
09460000	N7 6x2	3/23,P/10	V	6,5	3	100	935	1025	146	D36x3xR45		B11	88
09566000	N7 6x2	10/13	V	7,5	10	100	935	815	172	D36x3xR45	D36x3xR45	A1	130
09572000	N7 6x2	10/12	V	6,5	10	100	935	815	155	D36x3xR45	D36x3XR45	A1	120
09586000	N7 6x2	10/12	V	6,5	10	100	935	1035	195	D36x3xR45		B1.11	120
09450000	N7 6x2	2/18,2/19,4P/11	V	7,5	4	100	940	1045	180	D36x3xR45		B1.11	116
09463000	N7 6x2	5/22	H	9,0	5	100	840	990	145	D36x3xR45		B12	125
09501000	N7 6x2	9/17	H		9	100	840	990	110	D36x3xR45		B12	153
09497000	N7 6x2	8/17	H	18,0	8	100	845	930	110	D36x3xR45		B1.11	136
09488000	N7 6x4	10/12	V	6,5	10	100	930	1040	215	D36x3xR45		B1.11	120
09460000	N7 6x4	3/23,P/10	V	6,5	3	100	935	1025	146	D36x3xR45		B11	88
09566000	N7 6x4	10/13	V	7,5	10	100	935	815	172	D36x3xR45	D36x3xR45	A1	130
09572000	N7 6x4	10/12	V	6,5	10	100	935	815	155	D36x3xR45	D36x3XR45	A1	120
09586000	N7 6x4	10/12	V	6,5	10	100	935	1035	195	D36x3xR45		B1.11	120
09450000	N7 6x4	2/18,2/19,4P/11	V	7,5	4	100	940	1045	180	D36x3xR45		B1.11	116

N10	VOLVO	N10
------------	--------------	------------

Artikel.Nr.	Fahrzeugtyp	Info		Achsl.	Blattzahl	Breite	Lx/L1	Ly/L2	Spr.	Buchsen vorn	Buchsen hinten	Form	Paket
Art.-No.	Type			Axle Load	Leaves	Width			Free Arch	Bush front	Bush rear	Shape	Total height
09548000	N10	3/25	V	6,5	3	100	935	815	141	D36x3xR45	D36x3xR45	A20	87
09526000	N10	3/25	V	7,5	3	100	935	815	145	D36x3xR45	D36x3xR45	A22	84
09566000	N10	10/13	V	7,5	10	100	935	815	172	D36x3xR45	D36x3xR45	A1	130
09572000	N10	10/12	V	6,5	10	100	935	815	155	D36x3xR45	D36x3xR45	A1	120
09586000	N10	10/12	V	6,5	10	100	935	1035	195	D36x3xR45		B1.11	120
09488000	N10 4x2	10/12	V	6,5	10	100	930	1040	215	D36x3xR45		B1.11	120
09528000	N10 4x2	3/26	V	7,5	3	100	935	815	163	D36x3xR45	D36x3xR45	A20	87
09450000	N10 4x2	2/18,2/19,4P/11	V	7,5	4	100	940	1045	180	D36x3xR45		B1.11	116
09443000	N10 4x2	2/13,9/12,P/12,9/9	H	10,0	20	90	750	750	145	D36x3xR45	D36x3xR45	A27	227
09589000	N10 4x2	5/26	H	17,0	5	90	793	793	70			D1.1	130
09587000	N10 4x2	2/45	H	17,0	2	90	795	795	52			D1.1	96
09581000	N10 4x2	9/14	H	10,5	9	100	828	828				D1.1	126
09583000	N10 4x2	11/14	H	11,5	11	100	828	828	65			D1.1	154
09515000	N10 4x2	5/17,1/10,4/13	H	10,0	10	100	1000	1000	170			C4	147
09517000	N10 4x2	5/17,1/10,2/15,4/14	H	13,0	12	100	1007	1007	179			C4	181
09661000	N10 4x2	15/10,2P/10,6/11	H	10,0	21	100	1025	1025				C4	236
09511000	N10 4x2	14/10,1/10,11/10	H	13,0	26	100	1025	1025	275			C4	260
09528000	N10 6x2	3/26	V	7,5	3	100	935	815	163	D36x3xR45	D36x3xR45	A20	87
09489000	N10 6x2	8/24	H	10,0	8	90	752	752	55			D1.1	192
09463000	N10 6x2	5/22	H	9,0	5	100	840	990	145	D36x3xR45		B12	125
09501000	N10 6x2	9/17	H		9	100	840	990	110	D36x3xR45		B12	153
09715000	N10 6x2	9/17	H		9	100	840	990		R45			153
09497000	N10 6x2	8/17	H	18,0	8	100	845	930	110	D36x3xR45		B1.11	136
09528000	N10 6x4	3/26	V	7,5	3	100	935	815	163	D36x3xR45	D36x3xR45	A20	87
09507000	N10 6x4	8/24	H	20,0	8	90	778	778	50			D11	192
09549000	N10 6x4	2/54,2P/8	H	20,0	2	90	780	780	43			D6	130
09585000	N10 6x4	8/24	H	20,0	8	90	790	790	55			D11	192
09509000	N10 6x4	9/26	H	26,0	9	90	790	790	55			D1.1	234
09565000	N10 6x4	9/26	H	20,0	9	90	793	793	70			D11	234
09579000	N10 6x4	2/52,P/15	H	8,5	2	90	795	795	41			D6	125

N12	VOLVO	N12
------------	--------------	------------

Artikel.Nr.	Fahrzeugtyp	Info		Achsl.	Blattzahl	Breite	Lx/L1	Ly/L2	Spr.	Buchsen vorn	Buchsen hinten	Form	Paket stärke
Art.-No.	Type			Axle Load	Leaves	Width			Free Arch	Bush front	Bush rear	Shape	Total height
09528000	N12	3/26	V	7,5	3	100	935	815	163	D36x3xR45	D36x3xR45	A20	87
09548000	N12	3/25	V	6,5	3	100	935	815	141	D36x3xR45	D36x3xR45	A20	87
09526000	N12	3/25	V	7,5	3	100	935	815	145	D36x3xR45	D36x3xR45	A22	84
09566000	N12	10/13	V	7,5	10	100	935	815	172	D36x3xR45	D36x3xR45	A1	130
09488000	N12 4x2	10/12	V	6,5	10	100	930	1040	215	D36x3xR45	D36x3XR45	B1.11	120
09460000	N12 4x2	3/23,P/10	V	6,5	3	100	935	1025	146	D36x3xR45		B11	88
09572000	N12 4x2	10/12	V	6,5	10	100	935	815	155	D36x3xR45		A1	120
09586000	N12 4x2	10/12	V	6,5	10	100	935	1035	195	D36x3xR45		B1.11	120
09450000	N12 4x2	2/18,2/19,4P/11	V	7,5	4	100	940	1045	180	D36x3xR45		B1.11	116
09581000	N12 4x2	9/14	H	10,5	9	100	828	828				D1.1	126
09583000	N12 4x2	11/14	H	11,5	11	100	828	828	65			D1.1	154
09515000	N12 4x2	5/17,1/10,4/13	H	10,0	10	100	1000	1000	170			C4	147
09517000	N12 4x2	5/17,1/10,2/15,4/14	H	13,0	12	100	1007	1007	179			C4	181
09661000	N12 4x2	15/10,2P/10,6/11	H	10,0	21	100	1025	1025				C4	236
09511000	N12 4x2	14/10,1/10,11/10	H	13,0	26	100	1025	1025	275		C4	260	
09488000	N12 6x2	10/12	V	6,5	10	100	930	1040	215	D36x3xR45	D36x3XR45	B1.11	120
09460000	N12 6x2	3/23,P/10	V	6,5	3	100	935	1025	146	D36x3xR45		B11	88
09572000	N12 6x2	10/12	V	6,5	10	100	935	815	155	D36x3xR45		A1	120
09586000	N12 6x2	10/12	V	6,5	10	100	935	1035	195	D36x3xR45		B1.11	120
09450000	N12 6x2	2/18,2/19,4P/11	V	7,5	4	100	940	1045	180	D36x3xR45		B1.11	116
09463000	N12 6x2	5/22	H	9,0	5	100	840	990	145	D36x3xR45		B12	125
09501000	N12 6x2	9/17	H	9	9	100	840	990	110	D36x3xR45		B12	153
09497000	N12 6x2	8/17	H	18,0	8	100	845	930	110	D36x3xR45		B1.11	136
09488000	N12 6x4	10/12	V	6,5	10	100	930	1040	215	D36x3xR45		B1.11	120
09460000	N12 6x4	3/23,P/10	V	6,5	3	100	935	1025	146	D36x3xR45		B11	88
09572000	N12 6x4	10/12	V	6,5	10	100	935	815	155	D36x3xR45	D36x3XR45	A1	120
09586000	N12 6x4	10/12	V	6,5	10	100	935	1035	195	D36x3xR45	B1.11	120	
09450000	N12 6x4	2/18,2/19,4P/11	V	7,5	4	100	940	1045	180	D36x3xR45	B1.11	116	
09489000	N12 6x4	8/24	H	10,0	8	90	752	752	55		D1.1	192	
09507000	N12 6x4	8/24	H	20,0	8	90	778	778	50		D11	192	
09549000	N12 6x4	2/54,2P/8	H	20,0	2	90	780	780	43		D6	130	
09585000	N12 6x4	8/24	H	20,0	8	90	790	790	55		D11	192	
09509000	N12 6x4	9/26	H	26,0	9	90	790	790	55		D1.1	234	
09589000	N12 6x4	5/26	H	17,0	5	90	793	793	70		D1.1	130	
09565000	N12 6x4	9/26	H	20,0	9	90	793	793	70		D11	234	
09587000	N12 6x4	2/45	H	17,0	2	90	795	795	52		D1.1	96	
09579000	N12 6x4	2/52,P/15	H	8,5	2	90	795	795	41		D6	125	

NH12	VOLVO	NH12
-------------	--------------	-------------

Artikel.Nr.	Fahrzeugtyp	Info		Achsl.	Blattzahl	Breite			Spr.	Buchsen vorn	Buchsen hinten	Form	Paket stärke
Art.-No.	Type			Axle Load	Leaves	Width	Lx/L1	Ly/L2	Free Arch	Bush front	Bush rear	Shape	Total height
09692000	NH12	1/24,2/25	V		3	100	795	795	113	D36xR45	D36xR45	A23	83
09658000	NH12	3/12,8/14	V		3	100	795	795	130	D36x3xR45	D34x4xR45	D1.1	79
09664000	NH12	2/30	V	7,1	2	100	990	900	141	D34x4xR45	D34x4xR45	A23	66
09666000	NH12	2/32	V		2	100	990	900	118	D34x4xR45	D34x4xR45	A23	70
09662000	NH12	2/30	V	7,1	2	100	990	900	141	D34x4xR45	D34x4xR45	A24	66
09724000	NH12		V	6,0	3	100	990	900		R45	R45	A25	
09686000	NH12	6/15	V	9,0	6	100	990	900	230	D34	D34	A20	90
09701000	NH12	1/16,14/14	H	13,0	15								
09675000	NH12	2/43+1/55	H	10,0	3	75	815	815	73			D4	147
09679000	NH12	2/49,1/55	H	26,0	3	75	815	815				D4	157
09631000	NH12	4/32	H	17,0	4	75	820	820	90			D1.1	
09633000	NH12	2/24	H	19,0	5	75	820	820	90			D1.1	
09637000	NH12	11/26	H	23,0	11	75	830	830				D7	286
09635000	NH12	9/26	H	13,0	9	90	830	830	56			D7	234
09695000	NH12	2/35+1/45	H		3	90	910	820	127	S26		B8	
09711000	NH12	3/35	H		3	90	910	820		S26		B8	

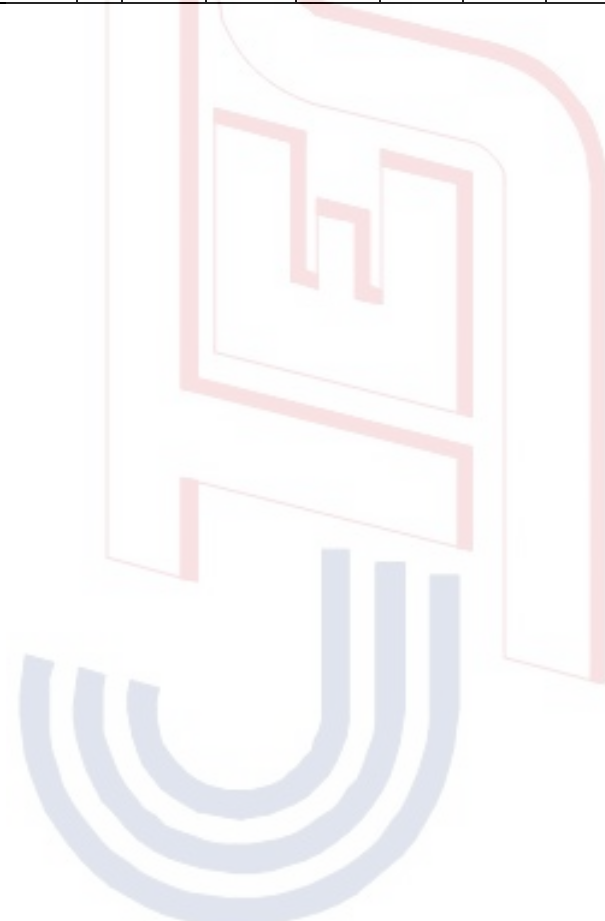

NL10	VOLVO	NL10
-------------	--------------	-------------

Artikel.Nr.	Fahrzeugtyp	Info		Achsl.	Blattzahl	Breite	Lx/L1	Ly/L2	Spr.	Buchsen vorn	Buchsen hinten	Form	Paket
Art.-No.	Type			Axle Load	Leaves	Width			Free Arch	Bush front	Bush rear	Shape	Total height
09728000	NL10		V		10	100				D36xR45	D36xR45	A1	
09730000	NL10		V	9,0	12	100				D36xR45	D36xR45	A1	
09530000	NL10	2/27+P/12	V	6,5	2	100	935	815	163	D36x3xR45	D36x3xR45	A25	75
09532000	NL10	2/29+P/20	V	7,5	2	100	935	815	140	D36x3xR45	D36x3xR45	A25	84
09566000	NL10	10/13	V	7,5	10	100	935	815	172	D36x3xR45	D36x3xR45	A1	130
09572000	NL10	10/12	V	6,5	10	100	935	815	155	D36x3xR45	D36x3xR45	A1	120
09645000	NL10	5/32	H	18,0	5	80	640	960	20			D1.1	170
09585000	NL10	8/24	H	20,0	8	90	790	790	55			D11	192
09589000	NL10	5/26	H	17,0	5	90	793	793	70			D1.1	130
09565000	NL10	9/26	H	20,0	9	90	793	793	70			D11	234
09719000	NL10		H	16,0	11	90	793	793				D11	
09587000	NL10	2/45	H	17,0	2	90	795	795	52			D1.1	96
09579000	NL10	2/52,P/15	H	8,5	2	90	795	795	41			D6	125
09563000	NL10	2/54,P/12	H	13,0	2	90	860	860	17			D6	126
09657000	NL10	3/12,8/14	H	10,0	11	100	720	820	62			D1.1	148
09463000	NL10	5/22	H	9,0	5	100	840	990	145	D36x3xR45		B12	125
09463100	NL10	6/22	H	10,0	6	100	840	990	150	D36xR45		B12	150
09463300	NL10	6/22	H	9,0	6	100	840	990	160			B12	150
09501000	NL10	9/17	H		9	100	840	990	110	D36x3xR45		B12	153
09515000	NL10	5/17,1/10,4/13	H	10,0	10	100	1000	1000	170			C4	147
09517000	NL10	5/17,1/10,2/15,4/14	H	13,0	12	100	1007	1007	179			C4	181
09511000	NL10	14/10,1/10,11/10	H	13,0	26	100	1025	1025	275			C4	260

NL12	VOLVO	NL12
-------------	--------------	-------------

Artikel.Nr.	Fahrzeugtyp	Info		Achsl.	Blattzahl	Breite	Lx/L1	Ly/L2	Spr.	Buchsen vorn	Buchsen hinten	Form	Paket stärke
Art. -No.	Type			Axle Load	Leaves	Width			Free Arch	Bush front	Bush rear	Shape	Total height
09728000	NL12		V		10	100				D36xR45	D36xR45	A1	
09730000	NL12		V	9,0	12	100				D36xR45	D36xR45	A1	
09530000	NL12	2/27+P/12	V	6,5	2	100	935	815	163	D36x3xR45	D36x3xR45	A25	75
09532000	NL12	2/29+P/20	V	7,5	2	100	935	815	140	D36x3xR45	D36x3xR45	A25	84
09566000	NL12	10/13	V	7,5	10	100	935	815	172	D36x3xR45	D36x3xR45	A1	130
09572000	NL12	10/12	V	6,5	10	100	935	815	155	D36x3xR45	D36x3XR45	A1	120
09645000	NL12	5/32	H	18,0	5	80	640	960	20			D1.1	170
09585000	NL12	8/24	H	20,0	8	90	790	790	55			D11	192
09589000	NL12	5/26	H	17,0	5	90	793	793	70			D1.1	130
09565000	NL12	9/26	H	20,0	9	90	793	793	70			D11	234
09719000	NL12		H	16,0	11	90	793	793				D11	
09587000	NL12	2/45	H	17,0	2	90	795	795	52			D1.1	96
09579000	NL12	2/52,P/15	H	8,5	2	90	795	795	41			D6	125
09563000	NL12	2/54,P/12	H	13,0	2	90	860	860	17			D6	126
09657000	NL12	3/12,8/14	H	10,0	11	100	720	820	62			D1.1	148
09463000	NL12	5/22	H	9,0	5	100	840	990	145	D36x3xR45		B12	125
09463100	NL12	6/22	H	10,0	6	100	840	990	150	D36xR45		B12	150
09463300	NL12	6/22	H	9,0	6	100	840	990	160			B12	150
09501000	NL12	9/17	H		9	100	840	990	110	D36x3xR45		B12	153
09515000	NL12	5/17,1/10,4/13	H	10,0	10	100	1000	1000	170			C4	147
09517000	NL12	5/17,1/10,2/15,4/14	H	13,0	12	100	1007	1007	179			C4	181
09511000	NL12	14/10,1/10,11/10	H	13,0	26	100	1025	1025	275			C4	260