

Kupplung
Clutch



Qualität fährt mit.
Quality in motion



www.st-templin.com



NKW Ersatzteile passend für: *Truck spare parts to fit to:*

BERGISCHE ACHSE, DAF, FIAT, FORD, FRUEHAUF, GIGANT,
HENDRICKSON, HUNTON, IKARUS, IVECO MAGIRUS,
KÄSSBOHRER, MAN, MERCEDES, NEOPLAN, RENAULT / RVI,
ROR, SAUER, SCANIA, SCHMITZ, STEYR, TRAILOR, TRILEX,
VOLVO, VW-MAN, WARSTEIN, WEWELER, YORK

Ihr Ansprechpartner für Engineering in den Bereichen:

Federung, Fahrwerk, Achsen, Bremse, Lenkung,
Fahrerhaus, DIN- und Normteile

Your partner for engineering in following areas:

*Suspension, running gear, axles, brake, steering,
driver's cab, DIN parts*

Ihr weiteres Programm an Ersatzteilen:

Elektrik, Rad, Druckluft, Motor und Antrieb, Kraftstoff
und Kühlsystem, Abgasanlage, Anhänger und Aufbauten,
Spiegel, Ladungssicherung, Chemische Produkte, Filter,
Zubehör

Your further programm of spare parts:

*Electrical equipment, wheel, compressed air, engine & drive
line, fuel- and cooling system, exhaust system, trailer parts,
mirrors, protection against shifting cargo, chemical products,
filters, accessories*

Qualität fährt mit.
Quality in motion.



Ihr Systemlieferant *Your full-line supplier*

Mit diesem Katalog werden alle früheren Ausgaben ungültig. Technische Änderungen bleiben vorbehalten. Das Zahlenmaterial des Kataloges wurde sorgfältig erarbeitet. Eine Gewähr für letzte Richtigkeit kann aber nicht übernommen werden. Ersatzansprüche, die also auf den Angaben des Kataloges beruhen, können deshalb nicht anerkannt werden.

Original-Ersatzteilnummern dienen lediglich Vergleichszwecken. Sie dürfen nicht in Lieferscheinen und Rechnungen an die Fahrzeughalter oder Wiederverkäufer erscheinen.

Maßgebend für alle Lieferungen sind unsere Verkaufs-, Lieferungs- und Zahlungsbedingungen.

Dieser Katalog genießt Urheberrecht. Vervielfältigungen, auch auszugsweise, sind nicht gestattet.

With this catalogue all previous editions are no longer valid. Technical alterations reserved. The figures of the catalogue have been elaborated carefully. Nevertheless we cannot guarantee for absolute correctness. Therefore entitlements to compensation cannot be accepted.

Original-numbers (OE-numbers) are only meant to be a means of comparison. They must not appear on delivery notes or invoices that are addressed to vehicle owners or resellers.

Our terms and conditions are decisive for all deliveries. This catalogue ist protected by copyright.

Duplications even in abridged versions are prohibited.

DAF:

| | |
|----------------------------------------------|--------|
| Kupplungssatz Clutch Kit | 5 |
| Kupplungsdruckplatte Clutch Pressure Plate | 5 - 6 |
| Kupplungsscheibe Clutch Disc | 7 - 8 |
| Ausrücklager Releaser | 9 - 10 |

IVECO:

| | |
|----------------------------------------------|---------|
| Kupplungssatz Clutch Kit | 11 |
| Kupplungsdruckplatte Clutch Pressure Plate | 11 - 12 |
| Kupplungsscheibe Clutch Disc | 12 - 14 |
| Ausrücklager Releaser | 14 - 15 |

KAMAZ:

| | |
|----------------------------------------------|----|
| Kupplungssatz Clutch Kit | 16 |
| Kupplungsdruckplatte Clutch Pressure Plate | 16 |

MAN:

| | |
|----------------------------------------------|---------|
| Kupplungssatz Clutch Kit | 17 - 19 |
| Kupplungsdruckplatte Clutch Pressure Plate | 19 - 20 |
| Kupplungsscheibe Clutch Disc | 21 - 24 |
| Ausrücklager Releaser | 24 - 25 |

MAZ:

| | |
|----------------------------------------------|----|
| Kupplungsdruckplatte Clutch Pressure Plate | 26 |
| Ausrücklager Releaser | 26 |

MERCEDES-BENZ:

| | |
|----------------------------------------------|---------|
| Kupplungssatz Clutch Kit | 27 - 31 |
| Kupplungsdruckplatte Clutch Pressure Plate | 31 - 33 |
| Kupplungsscheibe Clutch Disc | 34 - 38 |
| Ausrücklager Releaser | 38 - 41 |

NEOPLAN:

| | |
|----------------------------------------------|---------|
| Kupplungssatz Clutch Kit | 42 |
| Kupplungsdruckplatte Clutch Pressure Plate | 42 |
| Kupplungsscheibe Clutch Disc | 42 - 43 |
| Ausrücklager Releaser | 44 |

RENAULT:

| | |
|----------------------------------------------|---------|
| Kupplungssatz Clutch Kit | 45 - 47 |
| Kupplungsdruckplatte Clutch Pressure Plate | 47 - 48 |
| Kupplungsscheibe Clutch Disc | 48 - 50 |
| Ausrücklager Releaser | 51 - 52 |

SCANIA:

| | |
|----------------------------------------------|---------|
| Kupplungssatz Clutch Kit | 53 - 54 |
| Kupplungsdruckplatte Clutch Pressure Plate | 54 |
| Kupplungsscheibe Clutch Disc | 55 |
| Ausrücklager Releaser | 56 |

VOLVO:

| | |
|----------------------------------------------|---------|
| Kupplungssatz Clutch Kit | 57 - 58 |
| Kupplungsdruckplatte Clutch Pressure Plate | 59 - 60 |
| Kupplungsscheibe Clutch Disc | 60 - 62 |
| Ausrücklager Releaser | 63 - 64 |

Zubehör | Accessories:

| | |
|-----------------------------------------------------------|---------|
| Ausrückgabel, Kupplung | 65 |
| Bolzen Bolt | 65 - 66 |
| Reparatursatz, Ausrücklager Repair Kit, clutch releaser | 66 - 67 |
| Schwungrad Flywheel | 67 - 72 |
| Sicherungsring Circlip | 72 |
| Zahnkranz, Schwungrad Ring Gear, flywheel | 72 - 74 |

VOLVO:

| | |
|--------------------------------------------------------------|-----------|
| Aufsteigend nach St-Nr. Comparison No. Ascending to ST-No. | 75 - 109 |
| Aufsteigend nach Vergleichsnummer Ascending to Comp.-No. | 110 - 146 |

SERVICE-HOTLINE

FON: +49 5156-9610-0

FAX: +49 5156-961196



Kupplungssatz | Clutch Kit

| | | | | |
|------------------------------------------------------------------------------------------------------------------------------------------------------------------------------------------------------------------------------------------------------|------------------------------|-----|------------------------------------------------------------------------------------|---------------------------------------------------------------------|
| Kupplungssatz Clutch Kit | Durchmesser Diameter (mm) | 362 |  | 08.340.1268.1 S Vergl.Nr. Comp.-No. 3400 700 428 |
| | Zähnezahl Number of Teeth | 10 | | |
| passend für to fit to DAF 65 FA / 65 FAV Stückliste Parts List 1x 08.320.1000.340 Kupplungsdruckplatte Pressure Plate 1x 08.270.1000.711 Kupplungsscheibe Clutch Plate 1x 08.290.7000.090 Ausrücklager Releaser, clutch | | | | |

| | | | | |
|---------------------------------------------------------------------------------------------------------------------------------------------------------------------------------------------------------------------------------------------------------------------------------------------------|------------------------------|-----|------------------------------------------------------------------------------------|-----------------------------------------------------------------|
| Kupplungssatz Clutch Kit | Durchmesser Diameter (mm) | 430 |  | 08.340.1108.1 S Vergl.Nr. Comp.-No. 1625 968 |
| | | | | |
| passend für to fit to DAF: 75 CF / 85 / 85 CF / 95 / 95 XF / CF 75 / CF 85 / XF 95 Stückliste Parts List 1x 08.320.1000.702 Kupplungsdruckplatte Pressure Plate 1x 08.270.1000.721 Kupplungsscheibe Clutch Plate 1x 08.290.7000.000 Ausrücklager Releaser, clutch | | | | |

| | | | | |
|------------------------------------------------------------------------------------------------------------------------------------------------------------------------------------------------------------------------------------------------|------------------------------|-----|-------------------------------------------------------------------------------------|-----------------------------------------------------------------|
| Kupplungssatz Clutch Kit | Durchmesser Diameter (mm) | 430 |  | 08.340.1151.1 S Vergl.Nr. Comp.-No. 1625 967 |
| | | | | |
| passend für to fit to DAF: 85 / 95 Stückliste Parts List 1x 08.320.1000.682 Kupplungsdruckplatte Pressure Plate 1x 08.270.1000.803 Kupplungsscheibe Clutch Plate 1x 08.290.7000.040 Ausrücklager Releaser, clutch | | | | |

| | | | | |
|-----------------------------------------------------------------------------------------------------------------------------------------------------------------------------------------------------------------------------------------------------------|------------------------------|-----|--------------------------------------------------------------------------------------|-----------------------------------------------------------------|
| Kupplungssatz Clutch Kit | Durchmesser Diameter (mm) | 430 |  | 08.340.1104.1 S Vergl.Nr. Comp.-No. 1625 966 |
| | | | | |
| passend für to fit to DAF: 85 CF / 95 / 95 XF Stückliste Parts List 1x 08.320.1000.682 Kupplungsdruckplatte Pressure Plate 1x 08.270.1000.721 Kupplungsscheibe Clutch Plate 1x 08.290.7000.040 Ausrücklager Releaser, clutch | | | | |





Kupplungsdruckplatte | Pressure Plate

| | | | | |
|---------------------------------------------------------------------------------------------|------------------------------|-----|--------------------------------------------------------------------------------------|-----------------------------------------------------------------|
| Kupplungsdruckplatte Pressure Plate | Durchmesser Diameter (mm) | 350 |  | 08.320.1000.652 Vergl.Nr. Comp.-No. 0286 877 |
| | | | | |
| passend für to fit to DAF: F; MAN: G / L2000 / M90; RENAULT: G / MANAGER / MIDLINER | | | | |

DAF

**Kupplungsdruckplatte
Pressure Plate**



| Kupplungsdruckplatte Pressure Plate | | | | |
|------------------------------------------------------------------------|------------------------------|-----|--------------------------------------------------------------------------------------|-----------------------------------------------------------------|
| Kupplungsdruckplatte Pressure Plate | Durchmesser Diameter (mm) | 430 |  | 08.320.1000.702 Vergl.Nr. Comp.-No. 1204 205 |
| passend für to fit to DAF: CF / 95 / 95XF / XF95 | | | | |
| Kupplungsdruckplatte Pressure Plate | Durchmesser Diameter (mm) | 430 |  | 08.320.1000.682 Vergl.Nr. Comp.-No. 0078 866 |
| passend für to fit to DAF: F / CF / 95 / 95XF; SCANIA: BUS | | | | |
| Kupplungsdruckplatte Pressure Plate | Durchmesser Diameter (mm) | 395 |  | 08.320.1000.972 Vergl.Nr. Comp.-No. 1375 597 |
| passend für to fit to DAF: LF 45 / 55 / CF 65 / CF 75 | | | | |
| Kupplungsdruckplatte Pressure Plate | Durchmesser Diameter (mm) | 360 |  | 08.320.1000.300 Vergl.Nr. Comp.-No. 0660 306 |
| passend für to fit to DAF: F2100; MERCEDES-BENZ: NG | | | | |
| Kupplungsdruckplatte Pressure Plate | Durchmesser Diameter (mm) | 362 |  | 08.320.1000.340 Vergl.Nr. Comp.-No. 1304 280 |
| passend für to fit to DAF: 65 CF / 65 FA / 65 FAV / CF 65 / LF 45 | | | | |

Kupplungsscheibe | Clutch Plate

| | | | | |
|---------------------------------------------------------------------------------|------------------------------|-------------|--------------------------------------------------------------------------------------|-----------------------------------|
| Kupplungsscheibe Clutch Plate | Durchmesser Diameter (mm) | 350 |  | 08.270.1000.540 |
| | Zähnezahl Number of Teeth | 10 | | |
| passend für to fit to DAF: F; MERCEDES-BENZ: SK | Nabenprofil Hub Profile | 3/4"-10N | | Vergl.Nr. Comp.-No. 096 001 |
| | | | | |
| Kupplungsscheibe Clutch Plate | Durchmesser Diameter (mm) | 362 |  | 08.270.1000.711 |
| | Zähnezahl Number of Teeth | 10 | | |
| passend für to fit to DAF: 65CF; MAN: F2000 / L2000 / M2000 | Nabenprofil Hub Profile | 1 1/2" -10N | | Vergl.Nr. Comp.-No. 1307 569 |
| | | | | |
| Kupplungsscheibe Clutch Plate | Durchmesser Diameter (mm) | 362 |  | 08.270.1000.721 |
| | Zähnezahl Number of Teeth | 10 | | |
| passend für to fit to DAF: CF / 95 / 95XF | Nabenprofil Hub Profile | 1 1/2" -10N | | Vergl.Nr. Comp.-No. 078 867 |
| | | | | |
| Kupplungsscheibe Clutch Plate | Durchmesser Diameter (mm) | 362 |  | 08.270.1000.693 |
| | Zähnezahl Number of Teeth | 10 | | |
| passend für to fit to DAF LF / MAN L 2000 / M 2000 / TGA | Nabenprofil Hub Profile | 1 1/2" 10N | | Vergl.Nr. Comp.-No. 1400 510 |
| | | | | |
| Kupplungsscheibe Clutch Plate | Durchmesser Diameter (mm) | 380 |  | 08.270.1000.583 |
| | Zähnezahl Number of Teeth | 10 | | |
| passend für to fit to DAF: SB BUS; MAGIRUS: 230/260; MAN: M90 / SL / SÜ | Nabenprofil Hub Profile | 1 3/4"-10N | | Vergl.Nr. Comp.-No. 1348 133 |
| | | | | |
| Kupplungsscheibe Clutch Plate | Durchmesser Diameter (mm) | 380 |  | 08.270.1000.520 |
| | Zähnezahl Number of Teeth | 10 | | |
| passend für to fit to MERCEDES-BENZ: NG | Nabenprofil Hub Profile | 3/4"-10N | | Vergl.Nr. Comp.-No. 1331 326 |
| | | | | |
| Kupplungsscheibe Clutch Plate | Durchmesser Diameter (mm) | 395 |  | 08.270.1000.673 |
| | Zähnezahl Number of Teeth | 10 | | |
| passend für to fit to DAF: LF 45 / 55 / CF 65 | Nabenprofil Hub Profile | 1 1/2"-10N | | Vergl.Nr. Comp.-No. 1375 593 |
| | | | | |
| Kupplungsscheibe Clutch Plate | Durchmesser Diameter (mm) | 395 |  | 08.270.1000.683 |
| | Zähnezahl Number of Teeth | 10 | | |
| passend für to fit to DAF: CF 65 / 75 | Nabenprofil Hub Profile | 1 3/4"-10N | | Vergl.Nr. Comp.-No. 1447 243 |
| | | | | |

| Kupplungsscheibe Clutch Plate | | | | |
|---------------------------------------------------------------------------------------------------------------------------------------------------------------------------|------------------------------|------------|--------------------------------------------------------------------------------------|-----------------------------------|
| Kupplungsscheibe Clutch Plate | Durchmesser Diameter (mm) | 420 |  | 08.270.1000.553 |
| | Zähnezahl Number of Teeth | 10 | | |
| passend für to fit to DAF: 85 / A-SERIE / F-SERIE; RENAULT: BUS | Nabenprofil Hub Profile | 1 3/4"-10N | | Vergl.Nr. Comp.-No. 0165 495 |
| | | | | |
| Kupplungsscheibe Clutch Plate | Durchmesser Diameter (mm) | 420 |  | 08.270.1000.803 |
| | Zähnezahl Number of Teeth | 10 | | |
| passend für to fit to DAF: 85 / 95 | Nabenprofil Hub Profile | 2"-10N | | Vergl.Nr. Comp.-No. 0755 079 |
| | | | | |
| Kupplungsscheibe Clutch Plate | Durchmesser Diameter (mm) | 430 |  | 08.270.1000.761 |
| | Zähnezahl Number of Teeth | 10 | | |
| passend für to fit to DAF: 75 CF / 85 CF / F 85 / F 95; IVECO: EUROSTAR / EUROTECH / EUROTRAK- KER | Nabenprofil Hub Profile | 2" -10N | | Vergl.Nr. Comp.-No. 1303 702 |
| | | | | |
| Kupplungsscheibe Clutch Plate | Durchmesser Diameter (mm) | 430 |  | 08.270.1000.633 |
| | Zähnezahl Number of Teeth | 10 | | |
| passend für to fit to DAF: SB BUS; MAN: LIONS COACH / ÜL; MERCEDES-BENZ: CONECTO (O 345) / O 404 / TOURISMO (O 350) / TRAVEGO (O 580); NEOPLAN: TRENDLINER | Nabenprofil Hub Profile | 2"-10N | | Vergl.Nr. Comp.-No. 1140 537 |
| | | | | |
| Kupplungsscheibe Clutch Plate | Durchmesser Diameter (mm) | 430 |  | 08.270.1000.500 |
| | Zähnezahl Number of Teeth | 10 | | |
| passend für to fit to DAF: SB BUS; MAN: TGA / BUS; MERCEDES-BENZ: TRAVEGO | Nabenprofil Hub Profile | 2"-10N | | Vergl.Nr. Comp.-No. 1440 715 |
| | | | | |

| Ausrücklager Releaser, clutch | | | | |
|-----------------------------------------------------------------------------------------------------------------------------------------------------------------------------|------------------------------------------|-------|---------------------------------------------------------------------------------------|-----------------------------------------------------------------|
| Ausrücklager Releaser, clutch | Innendurchmesser Inner Diameter (mm) | 45,5 |  | 08.290.7000.090 Vergl.Nr. Comp.-No. 1267 988 |
| | Aussendurchmesser Outer Diameter (mm) | 95 | | |
| passend für to fit to DAF: F; IVECO: EUROFIRE / MK / PPA; MAN: G / L2000 / M90; RENAULT: MIDLI- NER | Breite Width (mm) | 31,5 | | |
| | | | | |
| Ausrücklager Releaser, clutch | Innendurchmesser Inner Diameter (mm) | 57 |  | 08.290.7000.060 Vergl.Nr. Comp.-No. 658 418 |
| | Aussendurchmesser Outer Diameter (mm) | 110 | | |
| passend für to fit to IVECO: 260 / 300; MAN: M 90 / SL II / SR / SÜ / ÜL; RENAULT: MIDLINER | Breite Width (mm) | 37 | | |
| | | | | |
| Ausrücklager Releaser, clutch | Innendurchmesser Inner Diameter (mm) | 57,2 |  | 08.290.7000.160 Vergl.Nr. Comp.-No. 113 365 |
| | Aussendurchmesser Outer Diameter (mm) | 102 | | |
| passend für to fit to DAF: F; IVECO: PPA; MAN: SR 240/280 | Breite Width (mm) | 39,5 | | |
| | | | | |
| Ausrücklager Releaser, clutch | Innendurchmesser Inner Diameter (mm) | 60,5 |  | 08.290.7000.000 Vergl.Nr. Comp.-No. 1250 710 |
| | Aussendurchmesser Outer Diameter (mm) | 126,6 | | |
| passend für to fit to DAF: CF / XF; MAN: F90 / F2000 / TGA / BUS | Breite Width (mm) | 98,2 | | |
| | | | | |
| Ausrücklager Releaser, clutch | Innendurchmesser Inner Diameter (mm) | 60,6 |  | 08.290.7000.040 Vergl.Nr. Comp.-No. 1287 806 |
| | Aussendurchmesser Outer Diameter (mm) | 131,8 | | |
| passend für to fit to DAF: F / CF / 95 / 95XF; BOVA: FUTURA | Breite Width (mm) | 39 | | |
| | | | | |
| Ausrücklager Releaser, clutch | Innendurchmesser Inner Diameter (mm) | 60,6 |  | 08.290.7000.300 Vergl.Nr. Comp.-No. 070 763 |
| | Aussendurchmesser Outer Diameter (mm) | 131,8 | | |
| passend für to fit to MERCEDES-BENZ: 2433 | Breite Width (mm) | 39 | | |
| | | | | |
| Ausrücklager Releaser, clutch | Innendurchmesser Inner Diameter (mm) | 63,2 |  | 08.290.7000.020 Vergl.Nr. Comp.-No. 1615 927 |
| | Aussendurchmesser Outer Diameter (mm) | 126,6 | | |
| passend für to fit to IVECO: EUROCARGO / EUROSTAR / EUROTECH / EUROTRAKKER / STRALIS; MAN: TGA / BUS; MERCEDES-BENZ: BUS; RENAULT: ARES / MAGNUM / PREMIUM | Breite Width (mm) | 104,3 | | |
| | | | | |

DAF

**Ausrücklager
Releaser, cluth**



Ausrücklager | Releaser, cluth

Ausrücklager

Releaser, cluth

passend für | to fit to

DAF CF 75 / CF 85 / F 85 / F95; MAN F
2000 / F 90 / TGA; RENAULT: KERAX



08.290.7000.420

Vergl.Nr. | Comp.-No.

1303 707



Kupplungssatz | Clutch Kit

| | | | | |
|-------------------------------------------------------------------------------------------------------------------------------------------------------------------------------------------------------------------------------------------------------------------------------------------------|------------------------------|-----|--------------------------------------------------------------------------------------|------------------------------------------------------------------|
| Kupplungssatz Clutch Kit | Durchmesser Diameter (mm) | 310 |  | 08.340.1102.1 S Vergl.Nr. Comp.-No. 0190 4754 |
| passend für to fit to IVECO: EUROCARGO / EUROFIRE; RENAULT TRUCKS: MIDLINER / MIDLUM Stückliste Parts List 1x 08.320.1000.752 Kupplungsdruckplatte Pressure Plate 1x 08.270.1000.781 Kupplungsscheibe Clutch Plate 1x 08.290.7000.140 Ausrücklager Releaser, clutch | | | | |
| Kupplungssatz Clutch Kit | Durchmesser Diameter (mm) | 430 |  | 08.340.1103.1 S Vergl.Nr. Comp.-No. 0190 4779 |
| passend für to fit to IVECO: EUROSTAR / EUROTECH / EU- ROTRAKKER / TURBOSTAR Stückliste Parts List 1x 08.320.1000.792 Kupplungsdruckplatte Pressure Plate 1x 08.270.1000.761 Kupplungsscheibe Clutch Plate 1x 08.290.7000.020 Ausrücklager Releaser, clutch | | | | |
| Kupplungssatz Clutch Kit | Durchmesser Diameter (mm) | 430 |  | 08.340.1119.1 S Vergl.Nr. Comp.-No. 0190 4780 |
| passend für to fit to IVECO: EUROSTAR / EUROTECH / STRALIS Stückliste Parts List 1x 08.320.1000.792 Kupplungsdruckplatte Pressure Plate 1x 08.270.1000.603 Kupplungsscheibe Clutch Plate 1x 08.290.7000.020 Ausrücklager Releaser, clutch | | | | |
| Kupplungssatz Clutch Kit | Durchmesser Diameter (mm) | 430 |  | 08.340.1267.1 S Vergl.Nr. Comp.-No. 0190 8517 |
| passend für to fit to IVECO: P/PA Stückliste Parts List 1x 08.320.1000.270 Kupplungsdruckplatte Pressure Plate 1x 08.270.1000.603 Kupplungsscheibe Clutch Plate 1x 08.290.7000.020 Ausrücklager Releaser, clutch | | | Zähnezahl Number of Teeth 10 | |

Kupplungsdruckplatte | Pressure Plate

| | | | | |
|---------------------------------------------------------------------|------------------------------|-----|--------------------------------------------------------------------------------------|------------------------------------------------------------------|
| Kupplungsdruckplatte Pressure Plate | Durchmesser Diameter (mm) | 310 |  | 08.320.1000.752 Vergl.Nr. Comp.-No. 9840 0708 |
| passend für to fit to IVECO: EUROCARGO; RENAULT: MIDLI- NER | | | | |

| Kupplungsdruckplatte Pressure Plate | | | |
|-----------------------------------------------------------------------------------------|------------------------------|-----|---------------------------------------------------------------------------------------------------------------------------------------------------------------|
| Kupplungsdruckplatte Pressure Plate | Durchmesser Diameter (mm) | 430 |  <p>08.320.1000.792</p> <p>Vergl.Nr. Comp.-No. 0190 4751</p> |
| passend für to fit to IVECO: EUROSTAR / EUROTECH / STRALIS; MAN: F90 / F2000 / BUS | | | |
| Kupplungsdruckplatte Pressure Plate | Durchmesser Diameter (mm) | 395 |  <p>08.320.1000.972</p> <p>Vergl.Nr. Comp.-No. 5040 3994</p> |
| passend für to fit to DAF: LF 45 / 55 / CF 65 / CF 75 | | | |
| Kupplungsdruckplatte Pressure Plate | Durchmesser Diameter (mm) | 330 |  <p>08.320.1000.602</p> <p>Vergl.Nr. Comp.-No. 0190 3890</p> |
| passend für to fit to MERCEDES-BENZ: UNIMOG / 814-1617 | | | |
| Kupplungsdruckplatte Pressure Plate | Durchmesser Diameter (mm) | 430 |  <p>08.320.1000.622</p> <p>Vergl.Nr. Comp.-No. 0190 3853</p> |
| passend für to fit to MERCEDES-BENZ: 1632-2632 | | | |

| Kupplungsscheibe Clutch Plate | | | |
|----------------------------------------------------------------------------|------------------------------|-------------|-----------------------------------------------------------------------------------------------------------------------------------------------------------------|
| Kupplungsscheibe Clutch Plate | Durchmesser Diameter (mm) | 310 |  <p>08.270.1000.781</p> <p>Vergl.Nr. Comp.-No. 500 358 237</p> |
| | Zähnezahl Number of Teeth | 10 | |
| passend für to fit to IVECO: EUROCARGO; RENAULT: MIDLNER | Nabenprofil Hub Profile | 1 1/2" -10N | |
| Kupplungsscheibe Clutch Plate | Durchmesser Diameter (mm) | 350 |  <p>08.270.1000.811</p> <p>Vergl.Nr. Comp.-No. 0126 0096</p> |
| | Zähnezahl Number of Teeth | 10 | |
| passend für to fit to MAGIRUS: 110-180 / SATURN; MERCEDES-BENZ: O 302 | Nabenprofil Hub Profile | 32x40 -10N | |
| Kupplungsscheibe Clutch Plate | Durchmesser Diameter (mm) | 350 |  <p>08.270.1000.540</p> <p>Vergl.Nr. Comp.-No. 0190 3854</p> |
| | Zähnezahl Number of Teeth | 10 | |
| passend für to fit to DAF: F; MERCEDES-BENZ: SK | Nabenprofil Hub Profile | 3/4"-10N | |

| Kupplungsscheibe Clutch Plate | | | | |
|---------------------------------------------------------------------------------|------------------------------|------------|--------------------------------------------------------------------------------------|------------------------------------|
| Kupplungsscheibe Clutch Plate | Durchmesser Diameter (mm) | 380 |  | 08.270.1000.583 |
| | Zähnezahl Number of Teeth | 10 | | |
| passend für to fit to DAF: SB BUS; MAGIRUS: 230/260; MAN: M90 / SL / SÜ | Nabenprofil Hub Profile | 1 3/4"-10N | | Vergl.Nr. Comp.-No. 0190 3871 |
| Kupplungsscheibe Clutch Plate | Durchmesser Diameter (mm) | 380 |  | 08.270.1000.533 |
| | Zähnezahl Number of Teeth | 10 | | |
| passend für to fit to IVECO: EUROFIRE; MAN: M90 | Nabenprofil Hub Profile | 1 3/4"10N | | Vergl.Nr. Comp.-No. 0126 1902 |
| Kupplungsscheibe Clutch Plate | Durchmesser Diameter (mm) | 380 |  | 08.270.1000.530 |
| | Zähnezahl Number of Teeth | 10 | | |
| passend für to fit to MERCEDES-BENZ: O 317 | Nabenprofil Hub Profile | 46x45-10N | | Vergl.Nr. Comp.-No. 0127 1999 |
| Kupplungsscheibe Clutch Plate | Durchmesser Diameter (mm) | 395 |  | 08.270.1000.673 |
| | Zähnezahl Number of Teeth | 10 | | |
| passend für to fit to DAF: LF 45 / 55 / CF 65 | Nabenprofil Hub Profile | 1 1/2"-10N | | Vergl.Nr. Comp.-No. 5040 4993 |
| Kupplungsscheibe Clutch Plate | Durchmesser Diameter (mm) | 400 |  | 08.270.1000.503 |
| | Zähnezahl Number of Teeth | 10 | | |
| passend für to fit to IVECO: EUROTECH / STRALIS | Nabenprofil Hub Profile | 2"-10N | | Vergl.Nr. Comp.-No. 0190 4796 |
| Kupplungsscheibe Clutch Plate | Durchmesser Diameter (mm) | 400 |  | 08.270.1000.911 |
| | Zähnezahl Number of Teeth | 10 | | |
| passend für to fit to IVECO: EUROTECH / STAR / TRAKKER | Nabenprofil Hub Profile | 2"-10N | | Vergl.Nr. Comp.-No. 9849 5998 |
| Kupplungsscheibe Clutch Plate | Durchmesser Diameter (mm) | 420 |  | 08.270.1000.681 |
| | Zähnezahl Number of Teeth | 10 | | |
| passend für to fit to IVECO: P/PA / P/PA-HAUBENFAHRZEUGE / TURBOTECH | Nabenprofil Hub Profile | 1 3/4"-10 | | Vergl.Nr. Comp.-No. 0190 3836 |
| Kupplungsscheibe Clutch Plate | Durchmesser Diameter (mm) | 420 |  | 08.270.1000.510 |
| | Zähnezahl Number of Teeth | 10 | | |
| passend für to fit to MERCEDES-BENZ: SK | Nabenprofil Hub Profile | 2"-10N | | Vergl.Nr. Comp.-No. |

| Kupplungsscheibe Clutch Plate | | | | |
|----------------------------------------------------------------------------------------------------------|-----------------|------------|-------------------------------------------------------------------------------------|----------------------------------------|
| Kupplungsscheibe Clutch Plate | Durchmesser | 430 |  | 08.270.1000.901 |
| | Diameter (mm) | | | |
| | Zähnezahl | 10 | | |
| | Number of Teeth | | | |
| passend für to fit to | Nabenprofil | 1 3/4"-10N | | |
| IVECO: EUROTECH / STRALIS | Hub Profile | | | Vergl.Nr. Comp.-No. 9849 5997 |
| Kupplungsscheibe Clutch Plate | Durchmesser | 430 |  | 08.270.1000.761 |
| | Diameter (mm) | | | |
| | Zähnezahl | 10 | | |
| | Number of Teeth | | | |
| passend für to fit to | Nabenprofil | 2" -10N | | |
| DAF: 75 CF / 85 CF / F 85 / F 95; IVECO: EUROSTAR / EUROTECH / EUROTRAK- KER | Hub Profile | | | Vergl.Nr. Comp.-No. 0190 4711 |
| Kupplungsscheibe Clutch Plate | Durchmesser | 430 |  | 08.270.1000.603 |
| | Diameter (mm) | | | |
| | Zähnezahl | 10 | | |
| | Number of Teeth | | | |
| passend für to fit to | Nabenprofil | 2"-10N | | |
| IVECO: EUROTECH / STRALIS | Hub Profile | | | Vergl.Nr. Comp.-No. 5003 72 079 |
| Kupplungsscheibe Clutch Plate | Durchmesser | 430 |  | 08.270.1000.881 |
| | Diameter (mm) | | | |
| | Zähnezahl | 10 | | |
| | Number of Teeth | | | |
| passend für to fit to | Nabenprofil | 2"-10N | | |
| MAN; F90 / F2000 / M90 / TGA; NEOPLAN: N113-N526; RENAULT ARES / ILIADE / KERAX / MAGNUM / PREMIUM | Hub Profile | | | Vergl.Nr. Comp.-No. 4202 2207 E64 |

| Ausrücklager Releaser, clutch | | | | |
|-------------------------------------------------------------------------------------|---------------------|------|--------------------------------------------------------------------------------------|------------------------------------|
| Ausrücklager Releaser, clutch | Innendurchmesser | 44,5 |  | 08.290.7000.140 |
| | Inner Diameter (mm) | | | |
| | Aussendurchmesser | 92 | | |
| | Outer Diameter (mm) | | | |
| passend für to fit to | Breite | 36,5 | | |
| IVECO: EUROCARGO; RENAULT: MIDLI- NER | Width (mm) | | | Vergl.Nr. Comp.-No. 9843 4871 |
| Ausrücklager Releaser, clutch | Innendurchmesser | 45,5 |  | 08.290.7000.090 |
| | Inner Diameter (mm) | | | |
| | Aussendurchmesser | 95 | | |
| | Outer Diameter (mm) | | | |
| passend für to fit to | Breite | 31,5 | | |
| DAF: F; IVECO: EUROFIRE / MK / PPA; MAN: G / L2000 / M90; RENAULT: MIDLI- NER | Width (mm) | | | Vergl.Nr. Comp.-No. 0247 5546 |
| Ausrücklager Releaser, clutch | Innendurchmesser | 57 |  | 08.290.7000.060 |
| | Inner Diameter (mm) | | | |
| | Aussendurchmesser | 110 | | |
| | Outer Diameter (mm) | | | |
| passend für to fit to | Breite | 37 | | |
| IVECO: 260 / 300; MAN: M 90 / SL II / SR / SÜ / ÜL; RENAULT: MIDLINER | Width (mm) | | | Vergl.Nr. Comp.-No. 0010 0128 |

Ausrücklager | Releaser, cluth

| | | | | |
|--------------------------------------------------------------------------------------------------------------------------------------------------|---------------------|-------|-------------------------------------------------------------------------------------|------------------------------------------------------------------|
| Ausrücklager | Innendurchmesser | 57,2 |  | 08.290.7000.160 Vergl.Nr. Comp.-No. 0190 3899 |
| Releaser, cluth | Inner Diameter (mm) | | | |
| | Aussendurchmesser | 102 | | |
| | Outer Diameter (mm) | | | |
| passend für to fit to | Breite | 39,5 | | |
| DAF: F; IVECO: PPA; MAN: SR 240/280 | Width (mm) | | | |
| Ausrücklager | Innendurchmesser | 63,2 |  | 08.290.7000.020 Vergl.Nr. Comp.-No. 0180 5282 |
| Releaser, cluth | Inner Diameter (mm) | | | |
| | Aussendurchmesser | 126,6 | | |
| | Outer Diameter (mm) | | | |
| passend für to fit to | Breite | 104,3 | | |
| IVECO: EUROCARGO / EUROSTAR / EUROTECH / EUROTRAKKER / STRALIS; MAN: TGA / BUS; MERCEDES-BENZ: BUS; RENAULT: ARES / MAGNUM / PREMIUM | Width (mm) | | | |

KAMAZ





Kupplungssatz Clutch Kit



| Kupplungssatz Clutch Kit | | | | |
|----------------------------------------------------------|------------------------------|-----|------------------------------------------------------------------------------------|---------------------------------------------------------------------|
| Kupplungssatz Clutch Kit | Durchmesser Diameter (mm) | 430 |  | 08.340.1124.1 S Vergl.Nr. Comp.-No. 3400 700 344 |
| passend für to fit to KAMAZ | | | | |
| Stückliste Parts List | | | | |
| 1x 08.320.1000.250 Kupplungsdruckplatte Pressure Plate | | | | |
| 1x 08.270.1000.723 Kupplungsscheibe Clutch Plate | | | | |
| 1x 08.290.7000.000 Ausrücklager Releaser, cluth | | | | |
| Kupplungssatz Clutch Kit | Durchmesser Diameter (mm) | 430 |  | 08.340.1125.1 S Vergl.Nr. Comp.-No. 3400 700 345 |
| passend für to fit to KAMAZ | | | | |
| Stückliste Parts List | | | | |
| 1x 08.320.1000.250 Kupplungsdruckplatte Pressure Plate | | | | |
| 1x 08.270.1000.723 Kupplungsscheibe Clutch Plate | | | | |
| 1x 08.290.7000.000 Ausrücklager Releaser, cluth | | | | |
| Kupplungsdruckplatte Pressure Plate | | | | |
| Kupplungsdruckplatte Pressure Plate | Durchmesser Diameter (mm) | 430 | | 08.320.1000.250 Vergl.Nr. Comp.-No. 3482 083 118 |
| passend für to fit to KAMAZ | | | | |

Kupplungssatz | Clutch Kit

| | | | |
|----------------------------------------------------------------------------------------------------------------------------------------------------------------------------------------------------------------------------------------------------------------------------------------------------------------------------------------------------------------------------|--|--------------------------------------------------------------------------------------|------------------------------------------------------------------------------|
| <p>Kupplungssatz Clutch Kit</p> <p>Durchmesser 362 Diameter (mm)</p> <p>Zähnezahl 10 Number of Teeth</p> <p>passend für to fit to MAN: L 2000 / M 2000 / TGL</p> <p>Stückliste Parts List 1x 08.320.1000.280 Kupplungsdruckplatte Pressure Plate 1x 08.270.1000.693 Kupplungsscheibe Clutch Plate</p> | |  | <p>08.340.1240.1 S</p> <p>Vergl.Nr. Comp.-No. 3400 700 303</p> |
| <p>Kupplungssatz Clutch Kit</p> <p>Durchmesser 395 Diameter (mm)</p> <p>Zähnezahl 10 Number of Teeth</p> <p>passend für to fit to MAN: M 2000 / TGM</p> <p>Stückliste Parts List 1x 08.320.1000.862 Kupplungsdruckplatte Pressure Plate 1x 08.270.1000.771 Kupplungsscheibe Clutch Plate</p> | |  | <p>08.340.1229.1 S</p> <p>Vergl.Nr. Comp.-No. 3400 700 302</p> |
| <p>Kupplungssatz Clutch Kit</p> <p>Durchmesser 400 Diameter (mm)</p> <p>Zähnezahl 10 Number of Teeth</p> <p>passend für to fit to MAN: F90</p> <p>Stückliste Parts List 1x 08.320.1000.982 Kupplungsdruckplatte Pressure Plate 1x 08.270.1000.912 Kupplungsscheibe Clutch Plate 1x 08.290.7000.000 Ausrücklager Releaser, clutch</p> | |  | <p>08.340.1223.1 S</p> <p>Vergl.Nr. Comp.-No. 3400 121 901</p> |
| <p>Kupplungssatz Clutch Kit</p> <p>Durchmesser 430 Diameter (mm)</p> <p>passend für to fit to MAN: F 2000 / F 90 / F 90 UNTERFLUR / M 90</p> <p>Stückliste Parts List 1x 08.320.1000.792 Kupplungsdruckplatte Pressure Plate 1x 08.270.1000.851 Kupplungsscheibe Clutch Plate 1x 08.290.7000.000 Ausrücklager Releaser, clutch</p> | |  | <p>08.340.1109.1 S</p> <p>Vergl.Nr. Comp.-No. 81.30005.9016</p> |
| <p>Kupplungssatz Clutch Kit</p> <p>Durchmesser 430 Diameter (mm)</p> <p>passend für to fit to MAN: F 2000 / F 90 / F 90 UNTERFLUR / M 90</p> <p>Stückliste Parts List 1x 08.320.1000.792 Kupplungsdruckplatte Pressure Plate 1x 08.270.1000.881 Kupplungsscheibe Clutch Plate 1x 08.290.7000.000 Ausrücklager Releaser, clutch</p> | |  | <p>08.340.1111.1 S</p> <p>Vergl.Nr. Comp.-No. 81.30005.9013</p> |

| Kupplungssatz Clutch Kit | | | | |
|---------------------------------------------------------------------------------------------------------------------------------------------------------------------------------------------------------------------------------------|-----------------|-----|--------------------------------------------------------------------------------------|----------------------------------------|
| Kupplungssatz Clutch Kit | Durchmesser | 362 |  | 08.340.1270.1 S |
| | Diameter (mm) | | | |
| | Zähnezahl | 10 | | Vergl.Nr. Comp.-No. 3400 121 801 |
| | Number of Teeth | | | |
| passend für MAN F 2000; L 2000; M 2000 L; M 90 Stückliste Parts List 1 x 08.320.1000.360 Kupplungsdruckplatte Clutch Pressure Plate 1 x 08.270.1000.711 Kupplungsscheibe Clutch Plate | | | | |
| Kupplungssatz Clutch Kit | Durchmesser | 430 |  | 08.340.1112.1 S |
| | Diameter (mm) | | | |
| passend für to fit to MAN: TGA Stückliste Parts List 1x 08.320.1000.822 Kupplungsdruckplatte Pressure Plate 1x 08.270.1000.881 Kupplungsscheibe Clutch Plate 1x 08.290.7000.000 Ausrücklager Releaser, cluth | | | | |
| Kupplungssatz Clutch Kit | Durchmesser | 430 |  | 08.340.1115.1 S |
| | Diameter (mm) | | | |
| passend für to fit to MAN: TGA Stückliste Parts List 1x 08.320.1000.822 Kupplungsdruckplatte Pressure Plate 1x 08.290.7000.000 Ausrücklager Releaser, cluth | | | | |
| Kupplungssatz Clutch Kit | Durchmesser | 430 |  | 08.340.1247.1 S |
| | Diameter (mm) | | | |
| | Zähnezahl | 10 | | Vergl.Nr. Comp.-No. 81.30000.6577 |
| | Number of Teeth | | | |
| passend für to fit to MAN: TGA Stückliste Parts List 1x 08.320.1000.842 Kupplungsdruckplatte Pressure Plate 1x 08.270.1000.813 Kupplungsscheibe Clutch Plate 1x 08.290.7000.000 Ausrücklager Releaser, cluth | | | | |
| Kupplungssatz Clutch Kit | Durchmesser | 430 |  | 08.340.1113.1 S |
| | Diameter (mm) | | | |
| passend für to fit to MAN: TGA Stückliste Parts List 1x 08.320.1000.822 Kupplungsdruckplatte Pressure Plate 1x 08.270.1000.881 Kupplungsscheibe Clutch Plate 1x 08.290.7000.020 Ausrücklager Releaser, cluth | | | | |

Kupplungssatz | Clutch Kit

| | | | | |
|------------------------------------------------------------------------------------------------------------------------------------------------------------------------------------------------------------------------------------------------------------------------------------------|------------------------------|-----|------------------------------------------------------------------------------------|----------------------------------------|
| Kupplungssatz Clutch Kit | Durchmesser Diameter (mm) | 430 |  | 08.340.1248.1 S |
| | Zähnezahl Number of Teeth | 10 | | Vergl.Nr. Comp.-No. 81.30000.6572 |
| passend für to fit to MAN: TGA / LION'S COACH; NEOPLAN; TOURLINER / STARLINER Stückliste Parts List 1x 08.320.1000.842 Kupplungsdruckplatte Pressure Plate 1x 08.270.1000.813 Kupplungsscheibe Clutch Plate 1x 08.290.7000.020 Ausrücklager Releaser, clutch | | | | |

Kupplungsdruckplatte | Pressure Plate

| | | | | |
|----------------------------------------------------------------------------------------------|------------------------------|-----|---------------------------------------------------------------------------------------|-----------------------------------------|
| Kupplungsdruckplatte Pressure Plate | Durchmesser Diameter (mm) | 395 |  | 08.320.1000.672 |
| | | | | Vergl.Nr. Comp.-No. 81.30305.0198 |
| passend für to fit to MAN: F2000 / L2000 / M2000 / TGA | | | | |
| Kupplungsdruckplatte Pressure Plate | Durchmesser Diameter (mm) | 430 |  | 08.320.1000.822 |
| | | | | Vergl.Nr. Comp.-No. 81.30305.0205 |
| passend für to fit to MAN: TGA / LION'S COACH | | | | |
| Kupplungsdruckplatte Pressure Plate | Durchmesser Diameter (mm) | 430 |  | 08.320.1000.842 |
| | | | | Vergl.Nr. Comp.-No. 81.30305.0204 |
| passend für to fit to MAN: LION'S COACH / TGA | | | | |
| Kupplungsdruckplatte Pressure Plate | Durchmesser Diameter (mm) | 350 |  | 08.320.1000.652 |
| | | | | Vergl.Nr. Comp.-No. 81.30.305.0162 |
| passend für to fit to DAF: F; MAN: G / L2000 / M90; RENAULT: G / MANAGER / MIDLINER | | | | |
| Kupplungsdruckplatte Pressure Plate | Durchmesser Diameter (mm) | 430 |  | 08.320.1000.792 |
| | | | | Vergl.Nr. Comp.-No. 81.30.000.6587 |
| passend für to fit to IVECO: EUROSTAR / EUROTECH / STRA- LIS; MAN: F90 / F2000 / BUS | | | | |
| Kupplungsdruckplatte Pressure Plate | Durchmesser Diameter (mm) | 380 |  | 08.320.1000.962 |
| | | | | Vergl.Nr. Comp.-No. 81.30305.0079 |
| passend für to fit to MAN: BUS | | | | |

**Kupplungsdruckplatte
Pressure Plate**





| Kupplungsdruckplatte Pressure Plate | | | |
|---------------------------------------------------------------------------------------|------------------------------|--------|--------------------------------------------------------------------------------------------------------------------------------------------------------------------|
| Kupplungsdruckplatte Pressure Plate | Durchmesser Diameter (mm) | 400 |  <p>08.320.1000.932</p> <p>Vergl.Nr. Comp.-No. 81.30000.7220</p> |
| passend für to fit to MAN: F2000 / TGA | | | |
| Kupplungsdruckplatte Pressure Plate | Durchmesser Diameter (mm) | 400 |  <p>08.320.1000.982</p> <p>Vergl.Nr. Comp.-No. 81.30305.0176</p> |
| passend für to fit to MAN: F90 | | | |
| Kupplungsdruckplatte Pressure Plate | Durchmesser Diameter (mm) | 395 |  <p>08.320.1000.862</p> <p>Vergl.Nr. Comp.-No. 81.30305.0216</p> |
| passend für to fit to MERCEDES-BENZ: ATEGO / AXOR | | | |
| Kupplungsdruckplatte Pressure Plate | Durchmesser Diameter (mm) | 420 |  <p>08.320.1000.200</p> <p>Vergl.Nr. Comp.-No. 81.30305.0084</p> |
| passend für to fit to MERCEDES-BENZ: SK; NEOPLAN N113- N940; EVOBUS S130-S220 | | | |
| Kupplungsdruckplatte Pressure Plate | Durchmesser Diameter (mm) | 430 |  <p>08.320.1000.622</p> <p>Vergl.Nr. Comp.-No. 81.30305.0111</p> |
| passend für to fit to MERCEDES-BENZ: 1632-2632 | | | |
| Kupplungsdruckplatte Pressure Plate | Durchmesser Diameter (mm) | 362 |  <p>08.320.1000.280</p> <p>Vergl.Nr. Comp.-No. 81.30305.0232</p> |
| passend für to fit to MAN: L 2000 / TGL; AVIA: D-LINE | | | |
| Kupplungsdruckplatte Pressure Plate | Durchmesser Diameter (mm) | 430 |  <p>08.320.1000.350</p> <p>Vergl.Nr. Comp.-No. 81.30305.6028</p> |
| passend für to fit to MAN: SR; MERCEDES-BENZ: NG | | | |
| Kupplungsdruckplatte Clutch Pressure Plate | Durchmesser Diameter (mm) | 362 |  <p>08.320.1000.360</p> <p>Vergl.Nr. Comp.-No. 81.30305.0201</p> |
| | KenngroÙe Parameter | MFZ362 | |
| passend für MAN F 2000; L 2000; M 2000 L; M 90 | | | |

Kupplungsscheibe | Clutch Plate

| | | | | |
|-----------------------------------------------------------------------------------------------------------------------------------------|--------------------------------------------------------------------------------------------------------------|-----------------------------------------|--------------------------------------------------------------------------------------|------------------------------------------------------------------------------|
| <p>Kupplungsscheibe Clutch Plate</p> <p>passend für to fit to MAN: L2000; RENAULT: MIDLINER</p> | <p>Durchmesser Diameter (mm)</p> <p>Zähnezahl Number of Teeth</p> <p>Nabenprofil Hub Profile</p> | <p>350</p> <p>10</p> <p>1 1/2"-10N</p> |  | <p>08.270.1000.573</p> <p>Vergl.Nr. Comp.-No. 81.30301.0375</p> |
| <p>Kupplungsscheibe Clutch Plate</p> <p>passend für to fit to MERCEDES-BENZ: LN2 / MK / NG</p> | <p>Durchmesser Diameter (mm)</p> <p>Zähnezahl Number of Teeth</p> <p>Nabenprofil Hub Profile</p> | <p>350</p> <p>10</p> <p>1 3/4"-10N</p> |  | <p>08.270.1000.563</p> <p>Vergl.Nr. Comp.-No. 81.30000.6336</p> |
| <p>Kupplungsscheibe Clutch Plate</p> <p>passend für to fit to DAF: 65CF; MAN: F2000 / L2000 / M2000</p> | <p>Durchmesser Diameter (mm)</p> <p>Zähnezahl Number of Teeth</p> <p>Nabenprofil Hub Profile</p> | <p>362</p> <p>10</p> <p>1 1/2" -10N</p> |  | <p>08.270.1000.711</p> <p>Vergl.Nr. Comp.-No. 81.30301.0001</p> |
| <p>Kupplungsscheibe Clutch Plate</p> <p>passend für to fit to DAF LF / MAN L 2000 / M 2000 / TGA</p> | <p>Durchmesser Diameter (mm)</p> <p>Zähnezahl Number of Teeth</p> <p>Nabenprofil Hub Profile</p> | <p>362</p> <p>10</p> <p>1 1/2" 10N</p> |  | <p>08.270.1000.693</p> <p>Vergl.Nr. Comp.-No. 81.30301.0411</p> |
| <p>Kupplungsscheibe Clutch Plate</p> <p>passend für to fit to MAN: M90 / M2000; MERCEDES-BENZ: LN-REIHE; RENAULT: G-REIHE</p> | <p>Durchmesser Diameter (mm)</p> <p>Zähnezahl Number of Teeth</p> <p>Nabenprofil Hub Profile</p> | <p>380</p> <p>10</p> <p>1 3/4"-10N</p> |  | <p>08.270.1000.941</p> <p>Vergl.Nr. Comp.-No. 81.30301.0121</p> |
| <p>Kupplungsscheibe Clutch Plate</p> <p>passend für to fit to DAF: SB BUS; MAGIRUS: 230/260; MAN: M90 / SL / SÜ</p> | <p>Durchmesser Diameter (mm)</p> <p>Zähnezahl Number of Teeth</p> <p>Nabenprofil Hub Profile</p> | <p>380</p> <p>10</p> <p>1 3/4"-10N</p> |  | <p>08.270.1000.583</p> <p>Vergl.Nr. Comp.-No. 0421.316.00</p> |
| <p>Kupplungsscheibe Clutch Plate</p> <p>passend für to fit to IVECO: EUROFIRE; MAN: M90</p> | <p>Durchmesser Diameter (mm)</p> <p>Zähnezahl Number of Teeth</p> <p>Nabenprofil Hub Profile</p> | <p>380</p> <p>10</p> <p>1 3/4"10N</p> |  | <p>08.270.1000.533</p> <p>Vergl.Nr. Comp.-No. 81.30301.0283</p> |
| <p>Kupplungsscheibe Clutch Plate</p> <p>passend für to fit to MERCEDES-BENZ: SK; RENAULT: F10 / F12 / N10 / N12</p> | <p>Durchmesser Diameter (mm)</p> <p>Zähnezahl Number of Teeth</p> <p>Nabenprofil Hub Profile</p> | <p>380</p> <p>10</p> <p>2"-10N</p> |  | <p>08.270.1000.951</p> <p>Vergl.Nr. Comp.-No. 81.30301.0235</p> |

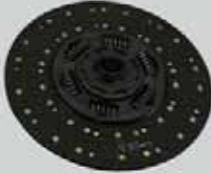
| Kupplungsscheibe Clutch Plate | | | | |
|-----------------------------------------------------------------------------------------------------|------------------------------|-------------|--------------------------------------------------------------------------------------|----------------------------------------------------------------------|
| Kupplungsscheibe Clutch Plate passend für to fit to MERCEDES-BENZ: O 317 | Durchmesser Diameter (mm) | 380 |  | 08.270.1000.530 Vergl.Nr. Comp.-No. 81.30301.0088 |
| | Zähnezahl Number of Teeth | 10 | | |
| | Nabenprofil Hub Profile | 46x45-10N | | |
| | | | | |
| Kupplungsscheibe Clutch Plate passend für to fit to MAN: F2000 / L2000 / M2000 / TGA | Durchmesser Diameter (mm) | 395 |  | 08.270.1000.771 Vergl.Nr. Comp.-No. 81.30301.0378 |
| | Zähnezahl Number of Teeth | 10 | | |
| | Nabenprofil Hub Profile | 1 3/4" -10N | | |
| | | | | |
| Kupplungsscheibe Clutch Plate passend für to fit to MAN: EL / F90 | Durchmesser Diameter (mm) | 400 |  | 08.270.1000.903 Vergl.Nr. Comp.-No. 81.30301.0347 |
| | Zähnezahl Number of Teeth | 10 | | |
| | Nabenprofil Hub Profile | 1 3/4"-10N | | |
| | | | | |
| Kupplungsscheibe Clutch Plate passend für to fit to MAN: F2000 / TGA | Durchmesser Diameter (mm) | 400 |  | 08.270.1000.643 Vergl.Nr. Comp.-No. 81.30000.7220 |
| | Zähnezahl Number of Teeth | 10 | | |
| | Nabenprofil Hub Profile | 2"-10N | | |
| | | | | |
| Kupplungsscheibe Clutch Plate passend für to fit to MAN: F90 | Durchmesser Diameter (mm) | 400 |  | 08.270.1000.931 Vergl.Nr. Comp.-No. 81.30301.0346 |
| | Zähnezahl Number of Teeth | 10 | | |
| | Nabenprofil Hub Profile | 2"-10N | | |
| | | | | |
| Kupplungsscheibe Clutch Plate passend für to fit to MERCEDES-BENZ: ACTROS | Durchmesser Diameter (mm) | 400 |  | 08.270.1000.821 Vergl.Nr. Comp.-No. 015 250 83 03 |
| | Zähnezahl Number of Teeth | 18 | | |
| | Nabenprofil Hub Profile | 85x96 -8N | | |
| | | | | |
| Kupplungsscheibe Clutch Plate passend für to fit to MAN; NEOPLAN; EVOBUS | Durchmesser Diameter (mm) | 420 |  | 08.270.1000.751 Vergl.Nr. Comp.-No. 81.30301.0112 |
| | Zähnezahl Number of Teeth | 10 | | |
| | Nabenprofil Hub Profile | 1 3/4" -10N | | |
| | | | | |
| Kupplungsscheibe Clutch Plate passend für to fit to MAN: SR | Durchmesser Diameter (mm) | 420 |  | 08.270.1000.653 Vergl.Nr. Comp.-No. 81.30301.0191 |
| | Zähnezahl Number of Teeth | 10 | | |
| | Nabenprofil Hub Profile | 1 3/4"-10N | | |
| | | | | |

| Kupplungsscheibe Clutch Plate | | | | |
|--------------------------------------------------------------------------------------------------------------------------------------------------------------------|------------------------------|-----|--------------------------------------------------------------------------------------|----------------------------------------------------------------------|
| Kupplungsscheibe Clutch Plate | Durchmesser Diameter (mm) | 430 |  | 08.270.1000.831 Vergl.Nr. Comp.-No. 81.30000.6587 |
| | Zähnezahl Number of Teeth | 10 | | |
| passend für to fit to MAN: BUS N / NL / CENTRO; MERCEDES-BENZ: SK-REIHE | | | | |
| Kupplungsscheibe Clutch Plate | Durchmesser Diameter (mm) | 430 |  | 08.270.1000.851 Vergl.Nr. Comp.-No. 81.30301.0364 |
| | Zähnezahl Number of Teeth | 10 | | |
| passend für to fit to MAN: F90 / F2000 | | | | |
| Kupplungsscheibe Clutch Plate | Durchmesser Diameter (mm) | 430 |  | 08.270.1000.633 Vergl.Nr. Comp.-No. 81.30000.6602 |
| | Zähnezahl Number of Teeth | 10 | | |
| passend für to fit to DAF: SB BUS; MAN: LIONS COACH / ÜL; MERCEDES-BENZ: CONECTO (O 345) / O 404 / TOURISMO (O 350) / TRAVEGO (O 580); NEOPLAN: TRENDLINER | | | | |
| Kupplungsscheibe Clutch Plate | Durchmesser Diameter (mm) | 430 |  | 08.270.1000.791 Vergl.Nr. Comp.-No. 81.30000.6601 |
| | Zähnezahl Number of Teeth | 10 | | |
| passend für to fit to MAN: NÜ / SÜ / ÜL; MERCEDES-BENZ: 1424-2534 / TOURISMO / CITARO | | | | |
| Kupplungsscheibe Clutch Plate | Durchmesser Diameter (mm) | 430 |  | 08.270.1000.613 Vergl.Nr. Comp.-No. 0001 144 060 |
| | Zähnezahl Number of Teeth | 10 | | |
| passend für to fit to RENAULT: KERAX / MAGNUM / MAJOR MANAGER / MAXTER / PREMIUM | | | | |
| Kupplungsscheibe Clutch Plate | Durchmesser Diameter (mm) | 430 |  | 08.270.1000.813 Vergl.Nr. Comp.-No. 81.30301.0466 |
| | Zähnezahl Number of Teeth | 10 | | |
| passend für to fit to MAN: LION'S COACH / LION'S STAR / TGA; NEOPLAN: STARLINER / TOURLINER | | | | |
| Kupplungsscheibe Clutch Plate | Durchmesser Diameter (mm) | 430 |  | 08.270.1000.500 Vergl.Nr. Comp.-No. 81.30301.0325 |
| | Zähnezahl Number of Teeth | 10 | | |
| passend für to fit to DAF: SB BUS; MAN: TGA / BUS; MERCEDES-BENZ: TRAVEGO | | | | |

Kupplungsscheibe | Clutch Plate

| | | | | |
|-------------------------------------------------------------------------------------------------------------------------------------|------------------------------|--------|------------------------------------------------------------------------------------|----------------------------------------|
| Kupplungsscheibe Clutch Plate | Durchmesser Diameter (mm) | 430 |  | 08.270.1000.881 |
| | Zähnezahl Number of Teeth | 10 | | |
| passend für to fit to MAN; F90 / F2000 / M90 / TGA; NEOPLAN: N113-N526; RENAULT ARES / ILIADE / KERAX / MAGNUM / PREMIUM | Nabenprofil Hub Profile | 2"-10N | | Vergl.Nr. Comp.-No. 81.30301.0217 |

Ausrücklager | Releaser, clutch

| | | | | |
|----------------------------------------------------------------------------------------------------------------|------------------------------------------|------|------------------------------------------------------------------------------------|-----------------------------------------|
| Ausrücklager Releaser, clutch | Innendurchmesser Inner Diameter (mm) | 45,5 |  | 08.290.7000.090 |
| | Aussendurchmesser Outer Diameter (mm) | 95 | | |
| passend für to fit to DAF: F; IVECO: EUROFIRE / MK / PPA; MAN: G / L2000 / M90; RENAULT: MIDLI- NER | Breite Width (mm) | 31,5 | | Vergl.Nr. Comp.-No. 81.30.550.0044 |

| | | | | |
|-----------------------------------------------------------------------------------------------------|------------------------------------------|-----|-------------------------------------------------------------------------------------|-----------------------------------------|
| Ausrücklager Releaser, clutch | Innendurchmesser Inner Diameter (mm) | 57 |  | 08.290.7000.060 |
| | Aussendurchmesser Outer Diameter (mm) | 110 | | |
| passend für to fit to IVECO: 260 / 300; MAN: M 90 / SL II / SR / SÜ / ÜL; RENAULT: MIDLINER | Breite Width (mm) | 37 | | Vergl.Nr. Comp.-No. 81.30.550.0026 |

| | | | | |
|----------------------------------------------------------------|------------------------------------------|------|---------------------------------------------------------------------------------------|-----------------------------------------|
| Ausrücklager Releaser, clutch | Innendurchmesser Inner Diameter (mm) | 57,2 |  | 08.290.7000.160 |
| | Aussendurchmesser Outer Diameter (mm) | 102 | | |
| passend für to fit to DAF: F; IVECO: PPA; MAN: SR 240/280 | Breite Width (mm) | 39,5 | | Vergl.Nr. Comp.-No. 81.30.550.0035 |

| | | | | |
|-------------------------------------|------------------------------------------|------|---------------------------------------------------------------------------------------|----------------------------------------|
| Ausrücklager Releaser, clutch | Innendurchmesser Inner Diameter (mm) | 57,2 |  | 08.290.7000.250 |
| | Aussendurchmesser Outer Diameter (mm) | 102 | | |
| passend für to fit to MAN: F90 | Breite Width (mm) | 66,6 | | Vergl.Nr. Comp.-No. 81.30550.0056 |

| | | | | |
|---------------------------------------------------------------|------------------------------------------|------|---------------------------------------------------------------------------------------|----------------------------------------|
| Ausrücklager Releaser, clutch | Innendurchmesser Inner Diameter (mm) | 57,2 |  | 08.290.7000.290 |
| | Aussendurchmesser Outer Diameter (mm) | 102 | | |
| passend für to fit to MAN: 8.192-22.192; RENAULT: SAVIEM | Breite Width (mm) | 74,5 | | Vergl.Nr. Comp.-No. 81.30000.6336 |

| | | | | |
|----------------------------------------------|------------------------------------------|------|--------------------------------------------------------------------------------------|----------------------------------------|
| Ausrücklager Releaser, clutch | Innendurchmesser Inner Diameter (mm) | 57,2 |  | 08.290.7000.280 |
| | Aussendurchmesser Outer Diameter (mm) | 110 | | |
| passend für to fit to MAN: SG / SL / SÜ | Breite Width (mm) | 40 | | Vergl.Nr. Comp.-No. 81.30550.0052 |

| Ausrücklager Releaser, clutch | | | | |
|------------------------------------------------------------------------------------------------------------------------------------------------------------------------------------------------------------------------------------------------------|------------------------------------------|-----------------------------|--------------------------------------------------------------------------------------|----------------------------------------------------------------------|
| Ausrücklager Releaser, clutch | Innendurchmesser Inner Diameter (mm) | 60,5 |  | 08.290.7000.000 Vergl.Nr. Comp.-No. 81.30000.6587 |
| | Aussendurchmesser Outer Diameter (mm) | 126,6 | | |
| passend für to fit to DAF: CF / XF; MAN: F90 / F2000 / TGA / BUS | Breite Width (mm) | 98,2 | | |
| | | | | |
| Ausrücklager Releaser, clutch | Innendurchmesser Inner Diameter (mm) | 63,2 |  | 08.290.7000.020 Vergl.Nr. Comp.-No. 36.30550.0001 |
| | Aussendurchmesser Outer Diameter (mm) | 126,6 | | |
| passend für to fit to IVECO: EUROCARGO / EUROSTAR / EUROTECH / EUROTRAKKER / STRALIS; MAN: TGA / BUS; MERCEDES-BENZ: BUS; RENAULT: ARES / MAGNUM / PREMIUM | Breite Width (mm) | 104,3 | | |
| | | | | |
| Ausrücklager Releaser, clutch | | |  | 08.290.7000.410 Vergl.Nr. Comp.-No. 81.30000.7220 |
| passend für to fit to RENAULT: KERAX / MAGNUM / PREMIUM; MAN F 2000 / TGA | | | | |
| Ausrücklager Releaser, clutch | | |  | 08.290.7000.420 Vergl.Nr. Comp.-No. 81.30550.0080 |
| passend für to fit to DAF CF 75 / CF 85 / F 85 / F95; MAN F 2000 / F 90 / TGA; RENAULT: KERAX | | | | |
| Ausrücklager Releaser, clutch | Info | Montagesatz Assembly Kit |  | 08.290.7000.550 Vergl.Nr. Comp.-No. 20 571 945 |
| passend für to fit to MERCEDES-BENZ: ACTROS / ACTROS MP2 / ATEGO / ECONIC; RENAULT: C / G / MAGNUM / MAJOR / MANAGER / MAXTER / R - SCANIA SERIE 2 / SERIE 3 / SERIE 4; VOLVO: 9700 / 9900 / B 12 / FH 12 / FL 10 / FL 12 / FM 12 / FM 7 / FM 9 | | | | |
| Ausrücklager Releaser, clutch | Kenngroße Parameter | KZIZ-5 |  | 08.290.7000.560 Vergl.Nr. Comp.-No. 270566 |
| passend für to fit to MAN: LION'S STAR; MERCEDES-BENZ: O404; NEOPLAN: STARLINER | | | | |

MAZ

**Kupplungsdruckplatte
Pressure Plate**



| Kupplungsdruckplatte Pressure Plate | | | | |
|----------------------------------------------------------|------------------------------|-----|--|------------------------------------------------------------------|
| Kupplungsdruckplatte Pressure Plate | Durchmesser Diameter (mm) | 362 | | 08.320.1000.260 Vergl.Nr. Comp.-No. 431202003 |
| passend für to fit to MAZ | | | | |
| Kupplungsdruckplatte Pressure Plate | Durchmesser Diameter (mm) | 430 | | 08.320.1000.270 Vergl.Nr. Comp.-No. 193853 |
| passend für to fit to AUWÄRTER; BOVA; MAZ; VAN HOOL | | | | |

| Ausrücklager Releaser, clutch | | | | |
|----------------------------------|------------------------|-------|--|----------------------------------------------------------------|
| Ausrücklager Releaser, clutch | Kenngröße Parameter | KZI-3 | | 08.290.7000.470 Vergl.Nr. Comp.-No. 5196701 |
| passend für to fit to MAZ | | | | |

Kupplungssatz | Clutch Kit

| | | | |
|---------------------------------------------------------------------------------------------------------------------------------------------------------------------------------------------------------------------------------------------------------|------------------------------|-----|----------------------------------------|
| Kupplungssatz Clutch Kit | Durchmesser Diameter (mm) | 350 | 08.340.1207.1 S |
| passend für to fit to MERCEDES-BENZ: LK/LN2 / MK / NG Stückliste Parts List 1x 08.320.1000.742 Kupplungsdruckplatte Pressure Plate 1x 08.290.7000.050 Ausrücklager Releaser, clutch | | | Vergl.Nr. Comp.-No. 020 250 53 01 |
| Kupplungssatz Clutch Kit | Durchmesser Diameter (mm) | 350 | 08.340.1263.1 S |
| passend für to fit to MERCEDES-BENZ: MK Stückliste Parts List 1x 08.320.1000.742 Kupplungsdruckplatte Pressure Plate 1x 08.270.1000.563 Kupplungsscheibe Clutch Plate 1x 08.290.7000.050 Ausrücklager Releaser, clutch | | | Vergl.Nr. Comp.-No. 020 250 54 01 |
| Kupplungssatz Clutch Kit | Durchmesser Diameter (mm) | 360 | 08.340.1266.1 S |
| passend für to fit to MERCEDES-BENZ: NG Stückliste Parts List 1x 08.270.1000.540 Kupplungsscheibe Clutch Plate 1x 08.320.1000.300 Kupplungsdruckplatte Pressure Plate 1x 08.290.7000.050 Ausrücklager Releaser, clutch | | | Vergl.Nr. Comp.-No. 3400 125 101 |
| Kupplungssatz Clutch Kit | Durchmesser Diameter (mm) | 362 | 08.340.1122.1 S |
| passend für to fit to MERCEDES-BENZ: ATEGO / VARIO / LK/LN2 / UNIMOG Stückliste Parts List 1x 08.320.1000.290 Kupplungsdruckplatte Pressure Plate 1x 08.270.1000.691 Kupplungsscheibe Clutch Plate | | | Vergl.Nr. Comp.-No. 018 250 94 01 |
| Kupplungssatz Clutch Kit | Durchmesser Diameter (mm) | 362 | 08.340.1222.1 S |
| passend für to fit to MERCEDES-BENZ: LK/LN2 Stückliste Parts List 1x 08.320.1000.290 Kupplungsdruckplatte Pressure Plate 1x 08.270.1000.691 Kupplungsscheibe Clutch Plate 1x 08.290.7000.050 Ausrücklager Releaser, clutch | | | Vergl.Nr. Comp.-No. 3400 121 401 |

MERCEDES-BENZ

Kupplungssatz Clutch Kit





| Kupplungssatz Clutch Kit | | | | |
|-------------------------------------------------------------------------------------------------------------------------------------------|------------------------------|-----|--------------------------------------------------------------------------------------|----------------------------------------------------------------------|
| Kupplungssatz Clutch Kit | Durchmesser Diameter (mm) | 395 |  | 08.340.1117.1 S Vergl.Nr. Comp.-No. 018 250 95 01 |
| passend für to fit to MERCEDES-BENZ: ATEGO / AXOR | | | | |
| Stückliste Parts List 1x 08.320.1000.862 Kupplungsdruckplatte Pressure Plate 1x 08.270.1000.991 Kupplungsscheibe Clutch Plate | | | | |
| Kupplungssatz Clutch Kit | Durchmesser Diameter (mm) | 395 |  | 08.340.1116.1 S Vergl.Nr. Comp.-No. 019 250 65 01 |
| passend für to fit to MERCEDES-BENZ: ATEGO / AXOR | | | | |
| Stückliste Parts List 1x 08.270.1000.991 Kupplungsscheibe Clutch Plate 1x 08.320.1000.852 Kupplungsdruckplatte Pressure Plate | | | | |
| Kupplungssatz Clutch Kit | Durchmesser Diameter (mm) | 400 |  | 08.340.1105.1 S Vergl.Nr. Comp.-No. 018 250 97 01 |
| passend für to fit to MERCEDES-BENZ: ACTROS / ACTROS MP2 | | | | |
| Stückliste Parts List 1x 08.320.1000.722 Kupplungsdruckplatte Pressure Plate 1x 08.270.1000.731 Kupplungsscheibe Clutch Plate | | | | |
| Kupplungssatz Clutch Kit | Durchmesser Diameter (mm) | 400 |  | 08.340.1106.1 S Vergl.Nr. Comp.-No. 020 250 45 01 |
| passend für to fit to MERCEDES-BENZ: SK | | | | |
| Stückliste Parts List 1x 08.320.1000.692 Kupplungsdruckplatte Pressure Plate 1x 08.290.7000.130 Ausrücklager Releaser, clutch | | | | |
| Kupplungssatz Clutch Kit | Durchmesser Diameter (mm) | 420 |  | 08.340.1205.1 S Vergl.Nr. Comp.-No. 1800 125 301 |
| passend für to fit to MERCEDES-BENZ: NG / SK | | | | |
| Stückliste Parts List 1x 08.320.1000.200 Kupplungsdruckplatte Pressure Plate 1x 08.290.7000.080 Ausrücklager Releaser, clutch | | | | |
| Kupplungssatz Clutch Kit | Durchmesser Diameter (mm) | 430 |  | 08.340.1002.1 S Vergl.Nr. Comp.-No. 3400 122 701 |
| passend für to fit to MERCEDES-BENZ: ACTROS | | | | |

Kupplungssatz | Clutch Kit

| | | | |
|-----------------------------------------------------------------------------------------------------------------------------------------------------------------------------------------------------------------------------------------------|---------------------------------------------------------------------|--------------------------------------------------------------------------------------|----------------------------------------------------------------------|
| Kupplungssatz Clutch Kit | Durchmesser 430 Diameter (mm) |  | 08.340.1121.1 S Vergl.Nr. Comp.-No. 019 250 02 01 |
| passend für to fit to MERCEDES-BENZ: ACTROS / ACTROS MP2 Stückliste Parts List 1x 08.270.1000.971 Kupplungsscheibe Clutch Plate | | | |
| Kupplungssatz Clutch Kit | Durchmesser 430 Diameter (mm) |  | 08.340.1000.1 S Vergl.Nr. Comp.-No. |
| passend für to fit to MERCEDES-BENZ: SK Stückliste Parts List 08.320.1000.210 Kupplungsdruckplatte Pressure Plate 08.270.1000.500 Kupplungsscheibe Clutch Plate 08.290.7000.070 Ausrücklager Releaser, clutch | | | |
| Kupplungssatz Clutch Kit | Durchmesser 430 Diameter (mm) |  | 08.340.1206.1 S Vergl.Nr. Comp.-No. 001 250 97 01 |
| passend für to fit to MERCEDES-BENZ: ACTROS / ACTROS MP2 / AXOR | | | |
| Kupplungssatz Clutch Kit | Durchmesser 430 Diameter (mm) Zähnezahl 18 Number of Teeth |  | 08.340.1262.1 S Vergl.Nr. Comp.-No. 018 250 98 01 |
| passend für to fit to MERCEDES-BENZ: ATEGO / AXOR 2 Stückliste Parts List 1x 08.320.1000.230 Kupplungsdruckplatte Pressure Plate 1x 08.270.1000.971 Kupplungsscheibe Clutch Plate | | | |
| Kupplungssatz Clutch Kit | Durchmesser 430 Diameter (mm) |  | 08.340.1001.1 S Vergl.Nr. Comp.-No. 020 250 50 01 |
| passend für to fit to MERCEDES-BENZ: MK / NG / SK Stückliste Parts List 1x 08.320.1000.210 Kupplungsdruckplatte Pressure Plate 1x 08.290.7000.070 Ausrücklager Releaser, clutch | | | |

| Kupplungssatz Clutch Kit | | | |
|---------------------------------------------------------------------------------------------------------------------------------------------------------------------------------------------------------------------------------------------------------------------------------------------------------------------------------------------------------------------------------------------------|--|--------------------------------------------------------------------------------------|------------------------------------------------------------------------------|
| <p>Kupplungssatz Clutch Kit</p> <p>Durchmesser Diameter (mm)</p> <p>430</p> <p>passend für to fit to MERCEDES-BENZ: MK / O 303 / O 404 / SK</p> <p>Stückliste Parts List 1x 08.320.1000.210 Kupplungsdruckplatte Pressure Plate 1x 08.270.1000.671 Kupplungsscheibe Clutch Plate 1x 08.290.7000.190 Ausrücklager Releaser, clutch</p> | |  | <p>08.340.1006.1 S</p> <p>Vergl.Nr. Comp.-No. 020 250 48 01</p> |
| <p>Kupplungssatz Clutch Kit</p> <p>Durchmesser Diameter (mm)</p> <p>430</p> <p>passend für to fit to MERCEDES-BENZ: MK / O 303 / SK</p> <p>Stückliste Parts List 1x 08.320.1000.210 Kupplungsdruckplatte Pressure Plate 1x 08.270.1000.831 Kupplungsscheibe Clutch Plate 1x 08.290.7000.190 Ausrücklager Releaser, clutch</p> | |  | <p>08.340.1004.1 S</p> <p>Vergl.Nr. Comp.-No. 020 250 47 01</p> |
| <p>Kupplungssatz Clutch Kit</p> <p>Durchmesser Diameter (mm)</p> <p>430</p> <p>passend für to fit to MERCEDES-BENZ: MK / SK</p> <p>Stückliste Parts List 1x 08.320.1000.210 Kupplungsdruckplatte Pressure Plate 1x 08.290.7000.070 Ausrücklager Releaser, clutch</p> | |  | <p>08.340.1005.1 S</p> <p>Vergl.Nr. Comp.-No. 020 250 49 01</p> |
| <p>Kupplungssatz Clutch Kit</p> <p>Durchmesser Diameter (mm)</p> <p>430</p> <p>passend für to fit to MERCEDES-BENZ: MK / SK</p> <p>Stückliste Parts List 1x 08.320.1000.210 Kupplungsdruckplatte Pressure Plate 1x 08.270.1000.791 Kupplungsscheibe Clutch Plate 1x 08.290.7000.070 Ausrücklager Releaser, clutch</p> | |  | <p>08.340.1203.1 S</p> <p>Vergl.Nr. Comp.-No. 020 250 52 01</p> |
| <p>Kupplungssatz Clutch Kit</p> <p>Durchmesser Diameter (mm)</p> <p>430</p> <p>Zähnezahl Number of Teeth</p> <p>10</p> <p>passend für to fit to MERCEDES-BENZ: SK</p> <p>Stückliste Parts List 1x 08.320.1000.612 Kupplungsdruckplatte Pressure Plate 1x 08.270.1000.981 Kupplungsscheibe Clutch Plate 1x 08.290.7000.130 Ausrücklager Releaser, clutch</p> | |  | <p>08.340.1227.1 S</p> <p>Vergl.Nr. Comp.-No. 3400 127 901</p> |

Kupplungssatz | Clutch Kit

| | | | | |
|---------------------------------------------------------------------------------------------------------------------------------------------------------------------------------------------------------------------------------------------------------------|------------------------------|-----|------------------------------------------------------------------------------------|----------------------------------------------------------------------|
| Kupplungssatz Clutch Kit | Durchmesser Diameter (mm) | 430 |  | 08.340.1118.1 S Vergl.Nr. Comp.-No. 020 250 51 01 |
| <p>passend für to fit to MERCEDES-BENZ: SK</p> <p>Stückliste Parts List 1x 08.320.1000.612 Kupplungsdruckplatte Pressure Plate 1x 08.270.1000.981 Kupplungsscheibe Clutch Plate 1x 08.290.7000.070 Ausrücklager Releaser, cluth</p> | | | | |
| Kupplungssatz Clutch Kit | Durchmesser Diameter (mm) | 430 |  | 08.340.1202.1 S Vergl.Nr. Comp.-No. 3400 128 001 |
| <p>passend für to fit to MERCEDES-BENZ: TOURISMO / O 303 / O 340 / O 350 / O 403 / O 404</p> <p>Stückliste Parts List 1x 08.320.1000.210 Kupplungsdruckplatte Pressure Plate 1x 08.290.7000.130 Ausrücklager Releaser, cluth</p> | | | | |

Kupplungsdruckplatte | Pressure Plate

| | | | | |
|---------------------------------------------------------------------|------------------------------|-----|---------------------------------------------------------------------------------------|----------------------------------------------------------------------|
| Kupplungsdruckplatte Pressure Plate | Durchmesser Diameter (mm) | 330 |  | 08.320.1000.602 Vergl.Nr. Comp.-No. 002 250 87 04 |
| <p>passend für to fit to MERCEDES-BENZ: UNIMOG / 814-1617</p> | | | | |
| Kupplungsdruckplatte Pressure Plate | Durchmesser Diameter (mm) | 330 |  | 08.320.1000.632 Vergl.Nr. Comp.-No. 003 250 40 04 |
| <p>passend für to fit to MERCEDES-BENZ: 817-1517</p> | | | | |
| Kupplungsdruckplatte Pressure Plate | Durchmesser Diameter (mm) | 350 |  | 08.320.1000.742 Vergl.Nr. Comp.-No. 004 250 24 04 |
| <p>passend für to fit to MERCEDES-BENZ: 817-2420</p> | | | | |
| Kupplungsdruckplatte Pressure Plate | Durchmesser Diameter (mm) | 380 |  | 08.320.1000.220 Vergl.Nr. Comp.-No. 000 250 19 04 |
| <p>passend für to fit to MERCEDES-BENZ: SK</p> | | | | |
| Kupplungsdruckplatte Pressure Plate | Durchmesser Diameter (mm) | 380 |  | 08.320.1000.802 Vergl.Nr. Comp.-No. 000 250 00 04 |
| <p>passend für to fit to MERCEDES-BENZ: SK</p> | | | | |

MERCEDES-BENZ

Kupplungsdruckplatte Pressure Plate









| Kupplungsdruckplatte Pressure Plate | | | | |
|---------------------------------------------------------------------------------------|------------------------------|-----|---------------------------------------------------------------------------------------|----------------------------------------------------------------------|
| Kupplungsdruckplatte Pressure Plate | Durchmesser Diameter (mm) | 395 |  | 08.320.1000.852 Vergl.Nr. Comp.-No. 006 250 34 04 |
| passend für to fit to MERCEDES-BENZ: ATEGO / AXOR | | | | |
| Kupplungsdruckplatte Pressure Plate | Durchmesser Diameter (mm) | 395 |  | 08.320.1000.862 Vergl.Nr. Comp.-No. 006 250 32 04 |
| passend für to fit to MERCEDES-BENZ: ATEGO / AXOR | | | | |
| Kupplungsdruckplatte Pressure Plate | Durchmesser Diameter (mm) | 400 |  | 08.320.1000.722 Vergl.Nr. Comp.-No. 006 250 47 04 |
| passend für to fit to MERCEDES-BENZ: ACTROS | | | | |
| Kupplungsdruckplatte Pressure Plate | Durchmesser Diameter (mm) | 400 |  | 08.320.1000.692 Vergl.Nr. Comp.-No. 004 250 44 04 |
| passend für to fit to MERCEDES-BENZ: ACTROS / SK | | | | |
| Kupplungsdruckplatte Pressure Plate | Durchmesser Diameter (mm) | 420 |  | 08.320.1000.200 Vergl.Nr. Comp.-No. 002 250 32 04 |
| passend für to fit to MERCEDES-BENZ: SK; NEOPLAN N113- N940; EVOBUS S130-S220 | | | | |
| Kupplungsdruckplatte Pressure Plate | Durchmesser Diameter (mm) | 430 |  | 08.320.1000.210 Vergl.Nr. Comp.-No. 004 250 46 04 |
| passend für to fit to MERCEDES-BENZ: SK / O303 - O404 / CITARO | | | | |
| Kupplungsdruckplatte Pressure Plate | Durchmesser Diameter (mm) | 430 |  | 08.320.1000.622 Vergl.Nr. Comp.-No. 002 250 03 04 |
| passend für to fit to MERCEDES-BENZ: 1632-2632 | | | | |
| Kupplungsdruckplatte Pressure Plate | Durchmesser Diameter (mm) | 430 |  | 08.320.1000.612 Vergl.Nr. Comp.-No. 004 250 89 04 |
| passend für to fit to MERCEDES-BENZ: SK | | | | |

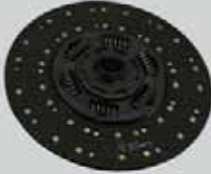

| Kupplungsdruckplatte Pressure Plate | | | |
|------------------------------------------------------------------------------|------------------------------|-----|--------------------------------------------------------------------------------------|
| Kupplungsdruckplatte Pressure Plate | Durchmesser Diameter (mm) | 430 |  |
| passend für to fit to MERCEDES-BENZ: ACTROS / AXOR | | | 08.320.1000.240 Vergl.Nr. Comp.-No. 005 250 64 04 |
| Kupplungsdruckplatte Pressure Plate | Durchmesser Diameter (mm) | 430 |  |
| passend für to fit to MERCEDES-BENZ: ACTROS / ATEGO / ECONIC | | | 08.320.1000.230 Vergl.Nr. Comp.-No. 005 250 93 04 |
| Kupplungsdruckplatte Pressure Plate | Durchmesser Diameter (mm) | 362 |  |
| passend für to fit to MERCEDES-BENZ: ATEGO / LK/LN2 / UNIMOG / VARIO | | | 08.320.1000.290 Vergl.Nr. Comp.-No. 006 250 67 04 |
| Kupplungsdruckplatte Pressure Plate | Durchmesser Diameter (mm) | 360 |  |
| passend für to fit to DAF: F2100; MERCEDES-BENZ: NG | | | 08.320.1000.300 Vergl.Nr. Comp.-No. 002 250 75 04 |
| Kupplungsdruckplatte Pressure Plate | Durchmesser Diameter (mm) | 430 |  |
| | | | 08.320.1000.812 Vergl.Nr. Comp.-No. |
| Kupplungsdruckplatte Pressure Plate | Durchmesser Diameter (mm) | 430 |  |
| passend für to fit to MAN: SR; MERCEDES-BENZ: NG | | | 08.320.1000.350 Vergl.Nr. Comp.-No. 3482 124 534 |

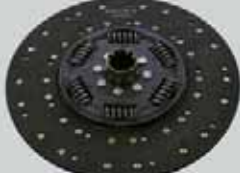
| Kupplungsscheibe Clutch Plate | | | | |
|-----------------------------------------------------------------------------------------------------------------------|------------------------------|------------|---------------------------------------------------------------------------------------|----------------------------------------------------------------------|
| Kupplungsscheibe Clutch Plate passend für to fit to MERCEDES-BENZ: LP / T2/L | Durchmesser Diameter (mm) | 250 |  | 08.270.1000.580 Vergl.Nr. Comp.-No. 000 250 63 03 |
| | Zähnezahl Number of Teeth | 10 | | |
| | Nabenprofil Hub Profile | 26x32-10N | | |
| | | | | |
| Kupplungsscheibe Clutch Plate passend für to fit to MERCEDES-BENZ: LK/LN2 / NG / LP / T2/L / T2/LN1 | Durchmesser Diameter (mm) | 280 |  | 08.270.1000.570 Vergl.Nr. Comp.-No. 000 250 05 03 |
| | Zähnezahl Number of Teeth | 10 | | |
| | Nabenprofil Hub Profile | 28x35-10N | | |
| | | | | |
| Kupplungsscheibe Clutch Plate passend für to fit to MERCEDES-BENZ: 711-1813 | Durchmesser Diameter (mm) | 310 |  | 08.270.1000.801 Vergl.Nr. Comp.-No. 001 250 60 03 |
| | Zähnezahl Number of Teeth | 10 | | |
| | Nabenprofil Hub Profile | 28x35 -10N | | |
| | | | | |
| Kupplungsscheibe Clutch Plate passend für to fit to MERCEDES-BENZ: LK/LN2 / LP / NG | Durchmesser Diameter (mm) | 310 |  | 08.270.1000.560 Vergl.Nr. Comp.-No. 001 250 59 03 |
| | Zähnezahl Number of Teeth | 10 | | |
| | Nabenprofil Hub Profile | 28x35-10N | | |
| | | | | |
| Kupplungsscheibe Clutch Plate passend für to fit to MERCEDES-BENZ: LK / NG | Durchmesser Diameter (mm) | 330 |  | 08.270.1000.550 Vergl.Nr. Comp.-No. 003 250 84 03 |
| | Zähnezahl Number of Teeth | 10 | | |
| | Nabenprofil Hub Profile | 28x35-10N | | |
| | | | | |
| Kupplungsscheibe Clutch Plate passend für to fit to MERCEDES-BENZ: LN2 / MK / NG | Durchmesser Diameter (mm) | 350 |  | 08.270.1000.563 Vergl.Nr. Comp.-No. 008 250 08 03 |
| | Zähnezahl Number of Teeth | 10 | | |
| | Nabenprofil Hub Profile | 1 3/4"-10N | | |
| | | | | |
| Kupplungsscheibe Clutch Plate passend für to fit to MAGIRUS: 110-180 / SATURN; MERCEDES-BENZ: O 302 | Durchmesser Diameter (mm) | 350 |  | 08.270.1000.811 Vergl.Nr. Comp.-No. 000 250 32 03 |
| | Zähnezahl Number of Teeth | 10 | | |
| | Nabenprofil Hub Profile | 32x40 -10N | | |
| | | | | |
| Kupplungsscheibe Clutch Plate passend für to fit to DAF: F; MERCEDES-BENZ: SK | Durchmesser Diameter (mm) | 350 |  | 08.270.1000.540 Vergl.Nr. Comp.-No. 003 250 56 03 |
| | Zähnezahl Number of Teeth | 10 | | |
| | Nabenprofil Hub Profile | 3/4"-10N | | |
| | | | | |

| Kupplungsscheibe Clutch Plate | | | | |
|----------------------------------------------------------------------------------------|------------------------------|-----|--------------------------------------------------------------------------------------|----------------------------------------------------------------------|
| Kupplungsscheibe Clutch Plate | Durchmesser Diameter (mm) | 362 |  | 08.270.1000.691 Vergl.Nr. Comp.-No. 017 250 05 03 |
| | Zähnezahl Number of Teeth | 18 | | |
| passend für to fit to MERCEDES-BENZ: ATEGO / UNIMOG / VARIO | | | | |
| Kupplungsscheibe Clutch Plate | Durchmesser Diameter (mm) | 380 |  | 08.270.1000.941 Vergl.Nr. Comp.-No. 003 250 95 03 |
| | Zähnezahl Number of Teeth | 10 | | |
| passend für to fit to MAN: M90 / M2000; MERCEDES-BENZ: LN-REIHE; RENAULT: G-REIHE | | | | |
| Kupplungsscheibe Clutch Plate | Durchmesser Diameter (mm) | 380 |  | 08.270.1000.951 Vergl.Nr. Comp.-No. 004 250 96 03 |
| | Zähnezahl Number of Teeth | 10 | | |
| passend für to fit to MERCEDES-BENZ: SK; RENAULT: F10 / F12 / N10 / N12 | | | | |
| Kupplungsscheibe Clutch Plate | Durchmesser Diameter (mm) | 380 |  | 08.270.1000.600 Vergl.Nr. Comp.-No. 008 250 16 03 |
| | Zähnezahl Number of Teeth | 10 | | |
| passend für to fit to MERCEDES-BENZ: NG | | | | |
| Kupplungsscheibe Clutch Plate | Durchmesser Diameter (mm) | 380 |  | 08.270.1000.610 Vergl.Nr. Comp.-No. 007 250 50 03 |
| | Zähnezahl Number of Teeth | 10 | | |
| passend für to fit to MERCEDES-BENZ: NG | | | | |
| Kupplungsscheibe Clutch Plate | Durchmesser Diameter (mm) | 380 |  | 08.270.1000.520 Vergl.Nr. Comp.-No. 002 250 97 03 |
| | Zähnezahl Number of Teeth | 10 | | |
| passend für to fit to MERCEDES-BENZ: NG | | | | |
| Kupplungsscheibe Clutch Plate | Durchmesser Diameter (mm) | 430 |  | 08.270.1000.620 Vergl.Nr. Comp.-No. 009 250 43 03 |
| | Zähnezahl Number of Teeth | 10 | | |
| passend für to fit to MERCEDES-BENZ: SK | | | | |
| Kupplungsscheibe Clutch Plate | Durchmesser Diameter (mm) | 380 |  | 08.270.1000.530 Vergl.Nr. Comp.-No. 000 250 92 03 |
| | Zähnezahl Number of Teeth | 10 | | |
| passend für to fit to MERCEDES-BENZ: O 317 | | | | |

| Kupplungsscheibe Clutch Plate | | | | |
|------------------------------------------------------------|------------------------------|----------------------------|---------------------------------------------------------------------------------------|----------------------------------------|
| Kupplungsscheibe Clutch Plate | Durchmesser Diameter (mm) | 395 |  | 08.270.1000.991 |
| | Zähnezahl Number of Teeth | 18 | | |
| passend für to fit to MERCEDES-BENZ: ATEGO / AXOR | | Nabenprofil Hub Profile | VOLVO | Vergl.Nr. Comp.-No. 015 250 46 03 |
| Kupplungsscheibe Clutch Plate | Durchmesser Diameter (mm) | 400 |  | 08.270.1000.630 |
| | Zähnezahl Number of Teeth | 10 | | |
| passend für to fit to MERCEDES-BENZ: ACTROS / SK | | | | Vergl.Nr. Comp.-No. 007 250 60 03 |
| Kupplungsscheibe Clutch Plate | Durchmesser Diameter (mm) | 400 |  | 08.270.1000.661 |
| | Zähnezahl Number of Teeth | 10 | | |
| passend für to fit to MERCEDES-BENZ: ACTROS / SK | | Nabenprofil Hub Profile | 2"-10N | Vergl.Nr. Comp.-No. 008 250 13 03 |
| Kupplungsscheibe Clutch Plate | Durchmesser Diameter (mm) | 400 |  | 08.270.1000.731 |
| | Zähnezahl Number of Teeth | 18 | | |
| passend für to fit to MERCEDES-BENZ: ACTROS | | Nabenprofil Hub Profile | 45x50 -18N | Vergl.Nr. Comp.-No. 015 250 79 03 |
| Kupplungsscheibe Clutch Plate | Durchmesser Diameter (mm) | 400 |  | 08.270.1000.821 |
| | Zähnezahl Number of Teeth | 18 | | |
| passend für to fit to MERCEDES-BENZ: ACTROS | | Nabenprofil Hub Profile | 85x96 -8N | Vergl.Nr. Comp.-No. 015 250 83 03 |
| Kupplungsscheibe Clutch Plate | Durchmesser Diameter (mm) | 420 |  | 08.270.1000.590 |
| | Zähnezahl Number of Teeth | 10 | | |
| passend für to fit to MERCEDES-BENZ: NG / O407 / O408 | | Nabenprofil Hub Profile | 1 3/4"-10N | Vergl.Nr. Comp.-No. 002 250 99 03 |
| Kupplungsscheibe Clutch Plate | Durchmesser Diameter (mm) | 420 |  | 08.270.1000.510 |
| | Zähnezahl Number of Teeth | 10 | | |
| passend für to fit to MERCEDES-BENZ: SK | | Nabenprofil Hub Profile | 2"-10N | Vergl.Nr. Comp.-No. |
| Kupplungsscheibe Clutch Plate | Durchmesser Diameter (mm) | 420 |  | 08.270.1000.650 |
| | Zähnezahl Number of Teeth | 10 | | |
| passend für to fit to MERCEDES-BENZ | | Nabenprofil Hub Profile | 36x45 | Vergl.Nr. Comp.-No. 002 250 33 03 |

| Kupplungsscheibe Clutch Plate | | | | |
|--------------------------------------------------------------------------------------------------------------------------------------------------------------------|------------------------------|-----|--------------------------------------------------------------------------------------|----------------------------------------------------------------------|
| Kupplungsscheibe Clutch Plate | Durchmesser Diameter (mm) | 430 |  | 08.270.1000.831 Vergl.Nr. Comp.-No. 009 250 19 03 |
| | Zähnezahl Number of Teeth | 10 | | |
| passend für to fit to MAN: BUS N / NL / CENTRO; MERCEDES-BENZ: SK-REIHE | | | | |
| Kupplungsscheibe Clutch Plate | Durchmesser Diameter (mm) | 430 |  | 08.270.1000.671 Vergl.Nr. Comp.-No. 008 250 19 03 |
| | Zähnezahl Number of Teeth | 10 | | |
| passend für to fit to MERCEDES-BENZ: SK / O 303 / O 404 / OH | | | | |
| Kupplungsscheibe Clutch Plate | Durchmesser Diameter (mm) | 430 |  | 08.270.1000.633 Vergl.Nr. Comp.-No. 016 250 35 03 |
| | Zähnezahl Number of Teeth | 10 | | |
| passend für to fit to DAF: SB BUS; MAN: LIONS COACH / ÜL; MERCEDES-BENZ: CONECTO (O 345) / O 404 / TOURISMO (O 350) / TRAVEGO (O 580); NEOPLAN: TRENDLINER | | | | |
| Kupplungsscheibe Clutch Plate | Durchmesser Diameter (mm) | 430 |  | 08.270.1000.981 Vergl.Nr. Comp.-No. 010 250 57 03 |
| | Zähnezahl Number of Teeth | 10 | | |
| passend für to fit to MERCEDES-BENZ: SK | | | | |
| Kupplungsscheibe Clutch Plate | Durchmesser Diameter (mm) | 430 |  | 08.270.1000.881 Vergl.Nr. Comp.-No. 018 250 80 03 |
| | Zähnezahl Number of Teeth | 10 | | |
| passend für to fit to MAN: F90 / F2000 / M90 / TGA; NEOPLAN: N113-N526; RENAULT ARES / ILIADE / KERAX / MAGNUM / PREMIUM | | | | |
| Kupplungsscheibe Clutch Plate | Durchmesser Diameter (mm) | 430 |  | 08.270.1000.791 Vergl.Nr. Comp.-No. 009 250 20 03 |
| | Zähnezahl Number of Teeth | 10 | | |
| passend für to fit to MAN: NÜ / SÜ / ÜL; MERCEDES-BENZ: 1424-2534 / TOURISMO / CITARO | | | | |
| Kupplungsscheibe Clutch Plate | Durchmesser Diameter (mm) | 430 |  | 08.270.1000.500 Vergl.Nr. Comp.-No. 007 250 58 03 |
| | Zähnezahl Number of Teeth | 10 | | |
| passend für to fit to DAF: SB BUS; MAN: TGA / BUS; MERCEDES-BENZ: TRAVEGO | | | | |

| Kupplungsscheibe Clutch Plate | | | | |
|-------------------------------------------------------------------------------------------------|------------------------------|-----------|-------------------------------------------------------------------------------------|----------------------------------------------------------------------|
| Kupplungsscheibe Clutch Plate passend für to fit to MERCEDES-BENZ: ACTROS / AXOR | Durchmesser Diameter (mm) | 430 |  | 08.270.1000.640 Vergl.Nr. Comp.-No. 015 250 71 03 |
| | Zähnezahl Number of Teeth | 18 | | |
| | Nabenprofil Hub Profile | 45x50 | | |
| | | | | |
| Kupplungsscheibe Clutch Plate passend für to fit to MERCEDES-BENZ: ACTROS | Durchmesser Diameter (mm) | 430 |  | 08.270.1000.971 Vergl.Nr. Comp.-No. 020 250 44 03 |
| | Zähnezahl Number of Teeth | 18 | | |
| | Nabenprofil Hub Profile | 45x50-18N | | |
| | | | | |

| Ausrücklager Releaser, clutch | | | | |
|------------------------------------------------------------------------------------------------------------------------------|------------------------------------------|------|--------------------------------------------------------------------------------------|----------------------------------------------------------------------|
| Ausrücklager Releaser, clutch passend für to fit to MERCEDES-BENZ: L407 / L408 | Innendurchmesser Inner Diameter (mm) | 34,1 |  | 08.290.7000.100 Vergl.Nr. Comp.-No. 001 250 01 15 |
| | Aussendurchmesser Outer Diameter (mm) | 62,5 | | |
| | Breite Width (mm) | 24,5 | | |
| | | | | |
| Ausrücklager Releaser, clutch passend für to fit to MERCEDES-BENZ: L408-1813 | Innendurchmesser Inner Diameter (mm) | 42,2 |  | 08.290.7000.240 Vergl.Nr. Comp.-No. 312 250 13 15 |
| | Aussendurchmesser Outer Diameter (mm) | 81,6 | | |
| | Breite Width (mm) | 41 | | |
| | | | | |
| Ausrücklager Releaser, clutch passend für to fit to MERCEDES-BENZ: 609-811 | Innendurchmesser Inner Diameter (mm) | 42,2 |  | 08.290.7000.120 Vergl.Nr. Comp.-No. 000 250 95 15 |
| | Aussendurchmesser Outer Diameter (mm) | 88,2 | | |
| | Breite Width (mm) | 47,5 | | |
| | | | | |
| Ausrücklager Releaser, clutch passend für to fit to MERCEDES-BENZ: LK/LN2 / LP / NG / O 301 / O 402 / T2/L | Innendurchmesser Inner Diameter (mm) | 42,2 |  | 08.290.7000.030 Vergl.Nr. Comp.-No. 000 250 42 15 |
| | Aussendurchmesser Outer Diameter (mm) | 92 | | |
| | Breite Width (mm) | 31,5 | | |
| | | | | |
| Ausrücklager Releaser, clutch passend für to fit to MERCEDES-BENZ: 408-1617 | Innendurchmesser Inner Diameter (mm) | 42,2 |  | 08.290.7000.200 Vergl.Nr. Comp.-No. 000 250 17 15 |
| | Aussendurchmesser Outer Diameter (mm) | 92 | | |
| | Breite Width (mm) | 38,2 | | |
| | | | | |

Ausrücklager | Releaser, clutch

| | | | | |
|----------------------------------------------------------------------------------------------------------|------------------------------------------|-------|---------------------------------------------------------------------------------------|----------------------------------------------------------------------|
| Ausrücklager Releaser, clutch | Innendurchmesser Inner Diameter (mm) | 54 |  | 08.290.7000.110 Vergl.Nr. Comp.-No. 000 250 64 15 |
| passend für to fit to MERCEDES-BENZ: 1924 / 1928 / 2624 | Aussendurchmesser Outer Diameter (mm) | 110 | | |
| | Breite Width (mm) | 91,5 | | |
| | | | | |
| Ausrücklager Releaser, clutch | Innendurchmesser Inner Diameter (mm) | 54,05 |  | 08.290.7000.170 Vergl.Nr. Comp.-No. 320 250 00 15 |
| passend für to fit to MERCEDES-BENZ: 1424-2624 | Aussendurchmesser Outer Diameter (mm) | 113 | | |
| | Breite Width (mm) | 45 | | |
| | | | | |
| Ausrücklager Releaser, clutch | Innendurchmesser Inner Diameter (mm) | 54,2 |  | 08.290.7000.220 Vergl.Nr. Comp.-No. 000 250 76 15 |
| passend für to fit to MERCEDES-BENZ: 1222-2425 | Aussendurchmesser Outer Diameter (mm) | 110 | | |
| | Breite Width (mm) | 62 | | |
| | | | | |
| Ausrücklager Releaser, clutch | Innendurchmesser Inner Diameter (mm) | 54,2 |  | 08.290.7000.080 Vergl.Nr. Comp.-No. 000 250 19 15 |
| passend für to fit to MERCEDES-BENZ: 1019-4645 / O303- O405; NEOPLAN: N113-N416; BOVA: FUTURA | Aussendurchmesser Outer Diameter (mm) | 110 | | |
| | Breite Width (mm) | 71 | | |
| | | | | |
| Ausrücklager Releaser, clutch | Innendurchmesser Inner Diameter (mm) | 54,5 |  | 08.290.7000.190 Vergl.Nr. Comp.-No. 001 250 81 15 |
| passend für to fit to MERCEDES-BENZ: SK | Aussendurchmesser Outer Diameter (mm) | 126,6 | | |
| | Breite Width (mm) | 101 | | |
| | | | | |
| Ausrücklager Releaser, clutch | Innendurchmesser Inner Diameter (mm) | 54,6 |  | 08.290.7000.050 Vergl.Nr. Comp.-No. 000 250 70 15 |
| passend für to fit to MERCEDES-BENZ: 811-2420 | Aussendurchmesser Outer Diameter (mm) | 110 | | |
| | Breite Width (mm) | 40 | | |
| | | | | |
| Ausrücklager Releaser, clutch | Innendurchmesser Inner Diameter (mm) | 60 |  | 08.290.7000.150 Vergl.Nr. Comp.-No. 000 250 73 15 |
| passend für to fit to MERCEDES-BENZ: 1628-4436 | Aussendurchmesser Outer Diameter (mm) | 110 | | |
| | Breite Width (mm) | 104,2 | | |
| | | | | |

MERCEDES-BENZ

Ausrücklager Releaser, clutch



| Ausrücklager Releaser, clutch | | | | |
|------------------------------------------------------------------------------------------------------------------------------------------------------------------------------------------------------------------------|------------------------------------------|-------|---------------------------------------------------------------------------------------|----------------------------------------------------------------------|
| Ausrücklager Releaser, clutch passend für to fit to MERCEDES-BENZ: 1632-4844 | Innendurchmesser Inner Diameter (mm) | 60,1 |  | 08.290.7000.180 Vergl.Nr. Comp.-No. 000 250 75 15 |
| | Aussendurchmesser Outer Diameter (mm) | 102 | | |
| | Breite Width (mm) | 58,5 | | |
| | | | | |
| Ausrücklager Releaser, clutch passend für to fit to MERCEDES-BENZ: 2433 | Innendurchmesser Inner Diameter (mm) | 60,6 |  | 08.290.7000.300 Vergl.Nr. Comp.-No. 001 250 04 15 |
| | Aussendurchmesser Outer Diameter (mm) | 131,8 | | |
| | Breite Width (mm) | 39 | | |
| | | | | |
| Ausrücklager Releaser, clutch passend für to fit to MERCEDES-BENZ: ACTROS / CITARO | Innendurchmesser Inner Diameter (mm) | 60,8 |  | 08.290.7000.130 Vergl.Nr. Comp.-No. 001 250 06 15 |
| | Aussendurchmesser Outer Diameter (mm) | 126,6 | | |
| | Breite Width (mm) | 101 | | |
| | | | | |
| Ausrücklager Releaser, clutch passend für to fit to MERCEDES-BENZ: SK | Innendurchmesser Inner Diameter (mm) | 60,8 |  | 08.290.7000.270 Vergl.Nr. Comp.-No. 000 250 92 15 |
| | Aussendurchmesser Outer Diameter (mm) | 126,6 | | |
| | Breite Width (mm) | 137 | | |
| | | | | |
| Ausrücklager Releaser, clutch passend für to fit to MERCEDES-BENZ: SK / CITARO | Innendurchmesser Inner Diameter (mm) | 60,8 |  | 08.290.7000.070 Vergl.Nr. Comp.-No. 001 250 05 15 |
| | Aussendurchmesser Outer Diameter (mm) | 126,6 | | |
| | Breite Width (mm) | 137 | | |
| | | | | |
| Ausrücklager Releaser, clutch passend für to fit to IVECO: EURO CARGO / EURO STAR / EUROTECH / EURO TRAKKER / STRALIS; MAN: TGA / BUS; MERCEDES-BENZ: BUS; RENAULT: ARES / MAGNUM / PREMIUM | Innendurchmesser Inner Diameter (mm) | 63,2 |  | 08.290.7000.020 Vergl.Nr. Comp.-No. 000 254 30 08 |
| | Aussendurchmesser Outer Diameter (mm) | 126,6 | | |
| | Breite Width (mm) | 104,3 | | |
| | | | | |
| Ausrücklager Releaser, clutch passend für to fit to MERCEDES-BENZ: ACTROS / ACTROS MP2 / ATEGO / ECONIC | | |  | 08.290.7000.500 Vergl.Nr. Comp.-No. 002 250 41 15 |
| | | | | |

Ausrücklager | Releaser, clutch

| | | |
|-------------------------------------------------------------------------------------------------------------------------------------------------------------------------------------------------------------------------------------------------------------------------------------------------------------------|------------------------------------------------------------------------------------------------------------------------|------------------------------------------------------------------------------|
| <p>Ausrücklager Releaser, clutch</p> <p>passend für to fit to MERCEDES-BENZ: ACTROS / ACTROS MP2</p> |  | <p>08.290.7000.510</p> <p>Vergl.Nr. Comp.-No. 002 250 68 15</p> |
| <p>Ausrücklager Releaser, clutch</p> <p>Info</p> <p>passend für to fit to MERCEDES-BENZ: ACTROS / ACTROS MP2 / ATEGO / ECONIC; RENAULT: C / G / MAGNUM / MAJOR / MANAGER / MAXTER / R - SCANIA SERIE 2 / SERIE 3 / SERIE 4; VOLVO: 9700 / 9900 / B 12 / FH 12 / FL 10 / FL 12 / FM 12 / FM 7 / FM 9</p> | <p>Montagesatz Assembly Kit</p>  | <p>08.290.7000.550</p> <p>Vergl.Nr. Comp.-No. 20 571 945</p> |
| <p>Ausrücklager Releaser, clutch</p> <p>KenngroÙe Parameter</p> <p>passend für to fit to MAN: LION'S STAR; MERCEDES-BENZ: O404; NEOPLAN: STARLINER</p> | <p>KZIZ-5</p>  | <p>08.290.7000.560</p> <p>Vergl.Nr. Comp.-No. 001 250 96 15</p> |

NEOPLAN





Kupplungssatz Clutch Kit



| Kupplungssatz Clutch Kit | | | |
|-----------------------------------------------------------------------------------------------------------------------------------------------------------------------------------------------------------------------------------------------------------------------------------------------------------------------------------------------------------------|------------------------------|-----|------------------------------------------------------------------------------------|
| Kupplungssatz Clutch Kit | Durchmesser Diameter (mm) | 430 |  |
| | Zähnezahl Number of Teeth | 10 | |
| <p>passend für to fit to MAN: TGA / LION'S COACH; NEOPLAN; TOURLINER / STARLINER</p> <p>Stückliste Parts List 1x 08.320.1000.842 Kupplungsdruckplatte Pressure Plate 1x 08.270.1000.813 Kupplungsscheibe Clutch Plate 1x 08.290.7000.020 Ausrücklager Releaser, clutch</p> | | | |
| | | | 08.340.1248.1 S Vergl.Nr. Comp.-No. 81.30000.6572 |

| Kupplungsdruckplatte Pressure Plate | | | |
|----------------------------------------------------------------------------------------------------------------------|------------------------------|-----|-------------------------------------------------------------------------------------|
| Kupplungsdruckplatte Pressure Plate | Durchmesser Diameter (mm) | 420 |  |
| | | | |
| <p>passend für to fit to MERCEDES-BENZ: SK; NEOPLAN N113- N940; EVOBUS S130-S220</p> | | | |
| | | | 08.320.1000.200 Vergl.Nr. Comp.-No. 20297 |



| Kupplungsscheibe Clutch Plate | | | |
|-------------------------------------------------------------------------------|------------------------------|-----------|---------------------------------------------------------------------------------------|
| Kupplungsscheibe Clutch Plate | Durchmesser Diameter (mm) | 310 |  |
| | Zähnezahl Number of Teeth | 10 | |
| <p>passend für to fit to MERCEDES-BENZ: LK/LN2 / LP / NG</p> | | | |
| | Nabenprofil Hub Profile | 28x35-10N | 08.270.1000.560 Vergl.Nr. Comp.-No. 0401.20264 |
| Kupplungsscheibe Clutch Plate | Durchmesser Diameter (mm) | 330 |  |
| | Zähnezahl Number of Teeth | 10 | |
| <p>passend für to fit to MERCEDES-BENZ: LK / NG</p> | | | |
| | Nabenprofil Hub Profile | 28x35-10N | 08.270.1000.550 Vergl.Nr. Comp.-No. 003 250 84 03 |
| Kupplungsscheibe Clutch Plate | Durchmesser Diameter (mm) | 350 |  |
| | Zähnezahl Number of Teeth | 10 | |
| <p>passend für to fit to DAF: F; MERCEDES-BENZ: SK</p> | | | |
| | Nabenprofil Hub Profile | 3/4"-10N | 08.270.1000.540 Vergl.Nr. Comp.-No. 100127 |
| Kupplungsscheibe Clutch Plate | Durchmesser Diameter (mm) | 400 |  |
| | Zähnezahl Number of Teeth | 10 | |
| <p>passend für to fit to MERCEDES-BENZ: ACTROS / SK</p> | | | |
| | Nabenprofil Hub Profile | 2"-10N | 08.270.1000.661 Vergl.Nr. Comp.-No. 0421.342.00 |





| Kupplungsscheibe Clutch Plate | | | | |
|-----------------------------------------------------------------------------------------------------------------------------------------------------------------|------------------------------|-----|--------------------------------------------------------------------------------------|----------------------------------------------------------------------|
| Kupplungsscheibe Clutch Plate | Durchmesser Diameter (mm) | 400 |  | 08.270.1000.630 Vergl.Nr. Comp.-No. 0421.323.00 |
| | Zähnezahl Number of Teeth | 10 | | |
| passend für to fit to MERCEDES-BENZ: ACTROS / SK | | | | |
| Kupplungsscheibe Clutch Plate | Durchmesser Diameter (mm) | 420 |  | 08.270.1000.751 Vergl.Nr. Comp.-No. 0421.307.00 |
| | Zähnezahl Number of Teeth | 10 | | |
| passend für to fit to MAN; NEOPLAN; EVOBUS | | | | |
| Kupplungsscheibe Clutch Plate | Durchmesser Diameter (mm) | 420 |  | 08.270.1000.590 Vergl.Nr. Comp.-No. 101647 |
| | Zähnezahl Number of Teeth | 10 | | |
| passend für to fit to MERCEDES-BENZ: NG / O407 / O408 | | | | |
| Kupplungsscheibe Clutch Plate | Durchmesser Diameter (mm) | 420 |  | 08.270.1000.650 Vergl.Nr. Comp.-No. 0401.145.00 |
| | Zähnezahl Number of Teeth | 10 | | |
| passend für to fit to MERCEDES-BENZ | | | | |
| Kupplungsscheibe Clutch Plate | Durchmesser Diameter (mm) | 430 |  | 08.270.1000.813 Vergl.Nr. Comp.-No. 81.30301.0466 |
| | Zähnezahl Number of Teeth | 10 | | |
| passend für to fit to MAN: LION'S COACH / LION'S STAR / TGA; NEOPLAN: STARLINER / TOURLINER | | | | |
| Kupplungsscheibe Clutch Plate | Durchmesser Diameter (mm) | 430 |  | 08.270.1000.881 Vergl.Nr. Comp.-No. 81.30301.0217 |
| | Zähnezahl Number of Teeth | 10 | | |
| passend für to fit to MAN; F90 / F2000 / M90 / TGA; NEOPLAN: N113-N526; RENAULT ARES / ILIADE / KERAX / MAGNUM / PREMIUM | | | | |
| Kupplungsscheibe Clutch Plate | Durchmesser Diameter (mm) | 430 |  | 08.270.1000.633 Vergl.Nr. Comp.-No. 11010031 |
| | Zähnezahl Number of Teeth | 10 | | |
| passend für to fit to DAF: SB BUS; MAN: LIONS COACH / ÜL; MERCEDES-BENZ: CONECTO (O 345) / O 404 / TOURISMO (O 350) / TRAVEGO (O 580); NEOPLAN: TRENDLINER | | | | |

NEOPLAN

Ausrücklager Releaser, clutch



| Ausrücklager Releaser, clutch | | | | |
|----------------------------------------------------------------------------------------------------------|---------------------|--------|------------------------------------------------------------------------------------|----------------------------------------------------------------------|
| Ausrücklager | Innendurchmesser | 42,2 |  | 08.290.7000.030 Vergl.Nr. Comp.-No. 000 250 42 15 |
| Releaser, clutch | Inner Diameter (mm) | | | |
| | Aussendurchmesser | 92 | | |
| | Outer Diameter (mm) | | | |
| passend für to fit to MERCEDES-BENZ: LK/LN2 / LP / NG / O 301 / O 402 / T2/L | Breite | 31,5 | | |
| | Width (mm) | | | |
| Ausrücklager | Innendurchmesser | 54,2 |  | 08.290.7000.080 Vergl.Nr. Comp.-No. 11000033 |
| Releaser, clutch | Inner Diameter (mm) | | | |
| | Aussendurchmesser | 110 | | |
| | Outer Diameter (mm) | | | |
| passend für to fit to MERCEDES-BENZ: 1019-4645 / O303- O405; NEOPLAN: N113-N416; BOVA: FUTURA | Breite | 71 | | |
| | Width (mm) | | | |
| Ausrücklager | Kenngroße | KZIZ-5 |  | 08.290.7000.560 Vergl.Nr. Comp.-No. 0421.510.00 |
| Releaser, clutch | Parameter | | | |
| | | | | |
| | | | | |
| passend für to fit to MAN: LION'S STAR; MERCEDES-BENZ: O404; NEOPLAN: STARLINER | | | | |



| Kupplungssatz Clutch Kit | | | |
|----------------------------------------------------------------------------------------------------------------------------------------------------------------------------------------------------------------------------------------------------------------------------------------------------------------------|------------------------------|-----|------------------------------------------------------------------------------------------------------------------------------------------------------------------|
| Kupplungssatz Clutch Kit | Durchmesser Diameter (mm) | 310 |  <p>08.340.1102.1 S</p> <p>Vergl.Nr. Comp.-No. 0190 4754</p> |
| <p>passend für to fit to</p> <p>IVECO: EUROCARGO / EUROFIRE; RENAULT TRUCKS: MIDLINER / MIDLUM</p> <p>Stückliste Parts List</p> <p>1x 08.320.1000.752 Kupplungsdruckplatte Pressure Plate 1x 08.270.1000.781 Kupplungsscheibe Clutch Plate 1x 08.290.7000.140 Ausrücklager Releaser, cluth</p> | | | |
| Kupplungssatz Clutch Kit | Durchmesser Diameter (mm) | 400 |  <p>08.340.1246.1 S</p> <p>Vergl.Nr. Comp.-No. 3400 700 340</p> |
| <p>passend für to fit to</p> <p>RENAULT: KERAX / MAGNUM</p> <p>Stückliste Parts List</p> <p>1x 08.320.1000.902 Kupplungsdruckplatte Pressure Plate 1x 08.270.1000.912 Kupplungsscheibe Clutch Plate 1x 08.290.7000.400 Ausrücklager Releaser, cluth</p> | | | |
| Kupplungssatz Clutch Kit | Durchmesser Diameter (mm) | 400 |  <p>08.340.1221.1 S</p> <p>Vergl.Nr. Comp.-No. 5001 843 361</p> |
| <p>passend für to fit to</p> <p>RENAULT: KERAX / MAGNUM / PREMIUM</p> <p>Stückliste Parts List</p> <p>1x 08.320.1000.902 Kupplungsdruckplatte Pressure Plate 1x 08.270.1000.841 Kupplungsscheibe Clutch Plate 1x 08.290.7000.400 Ausrücklager Releaser, cluth</p> | | | |
| Kupplungssatz Clutch Kit | Durchmesser Diameter (mm) | 400 |  <p>08.340.1241.1 S</p> <p>Vergl.Nr. Comp.-No. 3400 700 311</p> |
| <p>passend für to fit to</p> <p>RENAULT: KERAX / MAGNUM / PREMIUM</p> <p>Stückliste Parts List</p> <p>1x 08.320.1000.902 Kupplungsdruckplatte Pressure Plate 1x 08.270.1000.912 Kupplungsscheibe Clutch Plate 1x 08.290.7000.410 Ausrücklager Releaser, cluth</p> | | | |
| Kupplungssatz Clutch Kit | Durchmesser Diameter (mm) | 430 |  <p>08.340.1242.1 S</p> <p>Vergl.Nr. Comp.-No. 3400 700 330</p> |
| <p>passend für to fit to</p> <p>RENAULT: ILLIADE / KERAX</p> <p>Stückliste Parts List</p> <p>1x 08.320.1000.922 Kupplungsdruckplatte Pressure Plate 1x 08.270.1000.881 Kupplungsscheibe Clutch Plate 1x 08.290.7000.400 Ausrücklager Releaser, cluth</p> | | | |

| Kupplungssatz Clutch Kit | | | |
|---------------------------------------------------------------------------------------------------------------------------------------------------------------------------------------------------------------------------------------------------------------------------|------------------------------|-----|-------------------------------------------------------------------------------------|
| Kupplungssatz Clutch Kit | Durchmesser Diameter (mm) | 430 |  |
| | Zähnezahl Number of Teeth | 20 | |
| passend für to fit to RENAULT: ILLIADE / KERAX / MAGNUM / PREMIUM Stückliste Parts List 1x 08.320.1000.922 Kupplungsdruckplatte Pressure Plate 1x 08.270.1000.593 Kupplungsscheibe Clutch Plate 1x 08.290.7000.400 Ausrücklager Releaser, clutch | | | |
| | | | 08.340.1224.1 S Vergl.Nr. Comp.-No. 3400 123 401 |
| Kupplungssatz Clutch Kit | Durchmesser Diameter (mm) | 430 |  |
| | Zähnezahl Number of Teeth | 10 | |
| passend für to fit to RENAULT: ILLIADE / KERAX / PREMIUM Stückliste Parts List 1x 08.320.1000.922 Kupplungsdruckplatte Pressure Plate 1x 08.270.1000.623 Kupplungsscheibe Clutch Plate 1x 08.290.7000.400 Ausrücklager Releaser, clutch | | | |
| | | | 08.340.1260.1 S Vergl.Nr. Comp.-No. 5001 859 387 |
| Kupplungssatz Clutch Kit | Durchmesser Diameter (mm) | 430 |  |
| | Zähnezahl Number of Teeth | 20 | |
| passend für to fit to RENAULT: KERAX / MAGNUM / PREMIUM Stückliste Parts List 1x 08.320.1000.922 Kupplungsdruckplatte Pressure Plate 1x 08.270.1000.593 Kupplungsscheibe Clutch Plate 1x 08.290.7000.390 Ausrücklager Releaser, clutch | | | |
| | | | 08.340.1249.1 S Vergl.Nr. Comp.-No. 5001 486 489 |
| Kupplungssatz Clutch Kit | Durchmesser Diameter (mm) | 430 | |
| | Zähnezahl Number of Teeth | 10 | |
| passend für to fit to RENAULT: KERAX / MAGNUM / PREMIUM Stückliste Parts List 1x 08.320.1000.922 Kupplungsdruckplatte Pressure Plate 1x 08.270.1000.881 Kupplungsscheibe Clutch Plate 1x 08.290.7000.430 Ausrücklager Releaser, clutch | | | |
| | | | 08.340.1245.1 S Vergl.Nr. Comp.-No. 3400 700 334 |
| Kupplungssatz Clutch Kit | Durchmesser Diameter (mm) | 430 | |
| | Zähnezahl Number of Teeth | 10 | |
| passend für to fit to RENAULT: KERAX / PREMIUM Stückliste Parts List 1x 08.320.1000.922 Kupplungsdruckplatte Pressure Plate 1x 08.270.1000.613 Kupplungsscheibe Clutch Plate 1x 08.290.7000.430 Ausrücklager Releaser, clutch | | | |
| | | | 08.340.1261.1 S Vergl.Nr. Comp.-No. 3400 700 410 |







Kupplungssatz | Clutch Kit





| | | | | |
|-------------------------------------------------------------------------------------------------------------------------------------------------------------------------------------------------|------------------------------|-----|-------------------------------------------------------------------------------------|---------------------------------------|
| Kupplungssatz Clutch Kit | Durchmesser Diameter (mm) | 430 |  | 08.340.1243.1 S |
| passend für to fit to RENAULT: MAGNUM | Zähnezahl Number of Teeth | 10 | | Vergl.Nr. Comp.-No. 3400 700 331 |
| Stückliste Parts List 1x 08.320.1000.922 Kupplungsdruckplatte Pressure Plate 1x 08.270.1000.603 Kupplungsscheibe Clutch Plate 1x 08.290.7000.390 Ausrücklager Releaser, clutch | | | | |
| Kupplungssatz Clutch Kit | Durchmesser Diameter (mm) | 430 |  | 08.340.1244.1 S |
| passend für to fit to RENAULT: MAGNUM / PREMIUM | Zähnezahl Number of Teeth | 10 | | Vergl.Nr. Comp.-No. 3400 700 332 |
| Stückliste Parts List 1x 08.320.1000.922 Kupplungsdruckplatte Pressure Plate 1x 08.270.1000.881 Kupplungsscheibe Clutch Plate 1x 08.290.7000.020 Ausrücklager Releaser, clutch | | | | |
| Kupplungssatz Clutch Kit | Durchmesser Diameter (mm) | 430 |  | 08.340.1265.1 S |
| passend für to fit to VOLVO: FH 12; RENAULT: PREMIUM | Zähnezahl Number of Teeth | 10 | | Vergl.Nr. Comp.-No. 85 000 542 |
| Stückliste Parts List 1x 08.320.1000.892 Kupplungsdruckplatte Pressure Plate 1x 08.270.1000.793 Kupplungsscheibe Clutch Plate | | | | |





Kupplungsdruckplatte | Pressure Plate

| | | | | |
|-----------------------------------------------------------------------------------|------------------------------|-----|---------------------------------------------------------------------------------------|---------------------------------------|
| Kupplungsdruckplatte Pressure Plate | Durchmesser Diameter (mm) | 400 |  | 08.320.1000.902 |
| passend für to fit to RENAULT: KERAX / MAGNUM / PREMIUM | | | | Vergl.Nr. Comp.-No. 5010 244 093 |
| Kupplungsdruckplatte Pressure Plate | Durchmesser Diameter (mm) | 310 |  | 08.320.1000.752 |
| passend für to fit to IVECO: EUROCARGO; RENAULT: MIDL- NER | | | | Vergl.Nr. Comp.-No. 9840 0708 |
| Kupplungsdruckplatte Pressure Plate | Durchmesser Diameter (mm) | 430 |  | 08.320.1000.922 |
| passend für to fit to RENAULT: ARES / ILIADE / KERAX / MA- GNUM / PREMIUM | | | | Vergl.Nr. Comp.-No. 5010 244 097 |

| Kupplungsdruckplatte Pressure Plate | | | |
|----------------------------------------|------------------------------|-----|----------------------------------------------------------------------------------------------------------------------------------------------------------------|
| Kupplungsdruckplatte Pressure Plate | Durchmesser Diameter (mm) | 380 |  <p>08.320.1000.962</p> <p>Vergl.Nr. Comp.-No. 5000 841 312</p> |
| passend für to fit to MAN: BUS | | | |

| Kupplungsscheibe Clutch Plate | | | |
|----------------------------------------------------------------------------------------|------------------------------|-------------|------------------------------------------------------------------------------------------------------------------------------------------------------------------|
| Kupplungsscheibe Clutch Plate | Durchmesser Diameter (mm) | 310 |  <p>08.270.1000.781</p> <p>Vergl.Nr. Comp.-No. 5000 677 308</p> |
| passend für to fit to IVECO: EUROCARGO; RENAULT: MIDLINER | Zähnezahl Number of Teeth | 10 | |
| | Nabenprofil Hub Profile | 1 1/2" -10N | |
| Kupplungsscheibe Clutch Plate | Durchmesser Diameter (mm) | 350 |  <p>08.270.1000.573</p> <p>Vergl.Nr. Comp.-No. 5010 244 077</p> |
| passend für to fit to MAN: L2000; RENAULT: MIDLINER | Zähnezahl Number of Teeth | 10 | |
| | Nabenprofil Hub Profile | 1 1/2"-10N | |
| Kupplungsscheibe Clutch Plate | Durchmesser Diameter (mm) | 350 |  <p>08.270.1000.563</p> <p>Vergl.Nr. Comp.-No. 5000 295 069</p> |
| passend für to fit to MERCEDES-BENZ: LN2 / MK / NG | Zähnezahl Number of Teeth | 10 | |
| | Nabenprofil Hub Profile | 1 3/4"-10N | |
| Kupplungsscheibe Clutch Plate | Durchmesser Diameter (mm) | 380 |  <p>08.270.1000.941</p> <p>Vergl.Nr. Comp.-No. 5000 289 010</p> |
| passend für to fit to MAN: M90 / M2000; MERCEDES-BENZ: LN-REIHE; RENAULT: G-REIHE | Zähnezahl Number of Teeth | 10 | |
| | Nabenprofil Hub Profile | 1 3/4"-10N | |
| Kupplungsscheibe Clutch Plate | Durchmesser Diameter (mm) | 380 |  <p>08.270.1000.951</p> <p>Vergl.Nr. Comp.-No. 1667 929</p> |
| passend für to fit to MERCEDES-BENZ: SK; RENAULT: F10 / F12 / N10 / N12 | Zähnezahl Number of Teeth | 10 | |
| | Nabenprofil Hub Profile | 2"-10N | |
| Kupplungsscheibe Clutch Plate | Durchmesser Diameter (mm) | 380 |  <p>08.270.1000.520</p> <p>Vergl.Nr. Comp.-No. 5000 559 741</p> |
| passend für to fit to MERCEDES-BENZ: NG | Zähnezahl Number of Teeth | 10 | |
| | Nabenprofil Hub Profile | 3/4"-10N | |

| Kupplungsscheibe Clutch Plate | | | | |
|----------------------------------------------------------------------------------------------------|------------------------------|------------------------|---------------------------------------------------------------------------------------|---------------------------------------|
| Kupplungsscheibe Clutch Plate | Durchmesser Diameter (mm) | 380 |  | 08.270.1000.530 |
| | Zähnezahl Number of Teeth | 10 | | |
| passend für to fit to MERCEDES-BENZ: O 317 | Nabenprofil Hub Profile | 46x45-10N | | Vergl.Nr. Comp.-No. 0023 618 037 |
| | | | | |
| Kupplungsscheibe Clutch Plate | Durchmesser Diameter (mm) | 400 |  | 08.270.1000.912 |
| | Zähnezahl Number of Teeth | 10 | | |
| passend für to fit to RENAULT: KERAX / MAGNUM / PREMIUM | Nabenprofil Hub Profile | 2 ^{1/4} "-10N | | Vergl.Nr. Comp.-No. 5010 452 026 |
| | | | | |
| Kupplungsscheibe Clutch Plate | Durchmesser Diameter (mm) | 400 |  | 08.270.1000.841 |
| | Zähnezahl Number of Teeth | 20 | | |
| passend für to fit to RENAULT: KERAX / MAGNUM / PREMIUM | Nabenprofil Hub Profile | 50x55 -20N | | Vergl.Nr. Comp.-No. 5000 677 165 |
| | | | | |
| Kupplungsscheibe Clutch Plate | Durchmesser Diameter (mm) | 420 |  | 08.270.1000.751 |
| | Zähnezahl Number of Teeth | 10 | | |
| passend für to fit to MAN; NEOPLAN; EVOBUS | Nabenprofil Hub Profile | 1 3/4" -10N | | Vergl.Nr. Comp.-No. 5000 822 629 |
| | | | | |
| Kupplungsscheibe Clutch Plate | Durchmesser Diameter (mm) | 420 |  | 08.270.1000.553 |
| | Zähnezahl Number of Teeth | 10 | | |
| passend für to fit to DAF: 85 / A-SERIE / F-SERIE; RENAULT: BUS | Nabenprofil Hub Profile | 1 3/4"-10N | | Vergl.Nr. Comp.-No. 0001 141 034 |
| | | | | |
| Kupplungsscheibe Clutch Plate | Durchmesser Diameter (mm) | 420 |  | 08.270.1000.590 |
| | Zähnezahl Number of Teeth | 10 | | |
| passend für to fit to MERCEDES-BENZ: NG / O407 / O408 | Nabenprofil Hub Profile | 1 3/4"-10N | | Vergl.Nr. Comp.-No. 5000 587 571 |
| | | | | |
| Kupplungsscheibe Clutch Plate | Durchmesser Diameter (mm) | 420 |  | 08.270.1000.593 |
| | Zähnezahl Number of Teeth | 20 | | |
| passend für to fit to RENAULT: ARES / ILIADE / KERAX / MA- GNUM / MAJOR / MAXTER / PREMIUM | Nabenprofil Hub Profile | 50x55-20N | | Vergl.Nr. Comp.-No. 5010 244 184 |
| | | | | |
| Kupplungsscheibe Clutch Plate | Durchmesser Diameter (mm) | 430 |  | 08.270.1000.623 |
| | Zähnezahl Number of Teeth | 10 | | |
| passend für to fit to RENAULT: ARES / ILIADE / KERAX / MA- GNUM / MAJOR / MAXTER / PREMIUM | Nabenprofil Hub Profile | 1 3/4"-10N | | Vergl.Nr. Comp.-No. 5000 059 526 |
| | | | | |

| Kupplungsscheibe Clutch Plate | | | | |
|-------------------------------------------------------------------------------------------------------------------------------------|------------------------------|-----|--------------------------------------------------------------------------------------|---------------------------------------------------------------------|
| Kupplungsscheibe Clutch Plate | Durchmesser Diameter (mm) | 430 |  | 08.270.1000.613 Vergl.Nr. Comp.-No. 0001 144 060 |
| | Zähnezahl Number of Teeth | 10 | | |
| passend für to fit to RENAULT: KERAX / MAGNUM / MAJOR MANAGER / MAXTER / PREMIUM | | | | |
| Kupplungsscheibe Clutch Plate | Durchmesser Diameter (mm) | 430 |  | 08.270.1000.881 Vergl.Nr. Comp.-No. 5001 866 621 |
| | Zähnezahl Number of Teeth | 10 | | |
| passend für to fit to MAN; F90 / F2000 / M90 / TGA; NEOPLAN: N113-N526; RENAULT ARES / ILIADE / KERAX / MAGNUM / PREMIUM | | | | |
| Kupplungsscheibe Clutch Plate | Durchmesser Diameter (mm) | 430 |  | 08.270.1000.793 Vergl.Nr. Comp.-No. 1521 716 |
| | Zähnezahl Number of Teeth | 10 | | |
| passend für to fit to RENAULT: PREMIUM - VOLVO: FH 12 | | | | |
| Kupplungsscheibe Clutch Plate | Durchmesser Diameter (mm) | 430 |  | 08.270.1000.783 Vergl.Nr. Comp.-No. 7420 707 025 |
| | Zähnezahl Number of Teeth | 24 | | |
| passend für to fit to RENAULT: MAGNUM - VOLVO: FH 12 | | | | |
| Kupplungsscheibe Clutch Plate | Durchmesser Diameter (mm) | 430 |  | 08.270.1000.823 Vergl.Nr. Comp.-No. 7420 725 523 |
| | Zähnezahl Number of Teeth | 24 | | |
| passend für to fit to RENAULT MAGNUM | | | | |
| Kupplungsscheibe Clutch Plate | Durchmesser Diameter (mm) | 430 |  | 08.270.1000.523 Vergl.Nr. Comp.-No. 7420 707 024 |
| | Zähnezahl Number of Teeth | 24 | | |
| passend für to fit to VOLVO: B12; RENAULT: MAGNUM | | | | |

Ausrücklager | Releaser, clutch

| | | | | |
|--------------------------------------------------------------------------------------------------------------------------------------------------------------------|------------------------------------------|-------|---------------------------------------------------------------------------------------|---------------------------------------------------------------------|
| Ausrücklager Releaser, clutch | Innendurchmesser Inner Diameter (mm) | 44,5 |  | 08.290.7000.140 Vergl.Nr. Comp.-No. 5000 677 180 |
| | Aussendurchmesser Outer Diameter (mm) | 92 | | |
| passend für to fit to IVECO: EUROCARGO; RENAULT: MIDLINER | Breite Width (mm) | 36,5 | | |
| | | | | |
| Ausrücklager Releaser, clutch | Innendurchmesser Inner Diameter (mm) | 45,5 |  | 08.290.7000.090 Vergl.Nr. Comp.-No. 5000 058 221 |
| | Aussendurchmesser Outer Diameter (mm) | 95 | | |
| passend für to fit to DAF: F; IVECO: EUROFIRE / MK / PPA; MAN: G / L2000 / M90; RENAULT: MIDLINER | Breite Width (mm) | 31,5 | | |
| | | | | |
| Ausrücklager Releaser, clutch | Innendurchmesser Inner Diameter (mm) | 57 |  | 08.290.7000.060 Vergl.Nr. Comp.-No. 5000 251 362 |
| | Aussendurchmesser Outer Diameter (mm) | 110 | | |
| passend für to fit to IVECO: 260 / 300; MAN: M 90 / SL II / SR / SÜ / ÜL; RENAULT: MIDLINER | Breite Width (mm) | 37 | | |
| | | | | |
| Ausrücklager Releaser, clutch | Innendurchmesser Inner Diameter (mm) | 57,2 |  | 08.290.7000.160 Vergl.Nr. Comp.-No. 0001 141 035 |
| | Aussendurchmesser Outer Diameter (mm) | 102 | | |
| passend für to fit to DAF: F; IVECO: PPA; MAN: SR 240/280 | Breite Width (mm) | 39,5 | | |
| | | | | |
| Ausrücklager Releaser, clutch | Innendurchmesser Inner Diameter (mm) | 57,2 |  | 08.290.7000.250 Vergl.Nr. Comp.-No. 5000 807 806 |
| | Aussendurchmesser Outer Diameter (mm) | 102 | | |
| passend für to fit to MAN: F90 | Breite Width (mm) | 66,6 | | |
| | | | | |
| Ausrücklager Releaser, clutch | Innendurchmesser Inner Diameter (mm) | 57,2 |  | 08.290.7000.290 Vergl.Nr. Comp.-No. 5001 001 622 |
| | Aussendurchmesser Outer Diameter (mm) | 102 | | |
| passend für to fit to MAN: 8.192-22.192; RENAULT: SAVIEM | Breite Width (mm) | 74,5 | | |
| | | | | |
| Ausrücklager Releaser, clutch | Innendurchmesser Inner Diameter (mm) | 63,2 |  | 08.290.7000.020 Vergl.Nr. Comp.-No. 5001 858 682 |
| | Aussendurchmesser Outer Diameter (mm) | 126,6 | | |
| passend für to fit to IVECO: EUROCARGO / EUROSTAR / EUROTECH / EUROTRAKKER / STRALIS; MAN: TGA / BUS; MERCEDES-BENZ: BUS; RENAULT: ARES / MAGNUM / PREMIUM | Breite Width (mm) | 104,3 | | |
| | | | | |

RENAULT

Ausrücklager Releaser, clutch



| Ausrücklager Releaser, clutch | | | | |
|---------------------------------------------------------------------------------------------------------------------------------------------------------------------------------------------------------------------------------------------------------------------|------|-----------------------------|-------------------------------------------------------------------------------------|---------------------------------------------------------------------|
| Ausrücklager Releaser, clutch | Info | Montagesatz Assembly Kit |  | 08.290.7000.550 Vergl.Nr. Comp.-No. 5001 825 649 |
| passend für to fit to MERCEDES-BENZ: ACTROS / ACTROS MP2 / ATEGO / ECONIC; RENAULT: C / G / MAGNUM / MAJOR / MANAGER / MAXTER / R - SCANIA SERIE 2 / SERIE 3 / SERIE 4; VOLVO: 9700 / 9900 / B 12 / FH 12 / FL 10 / FL 12 / FM 12 / FM 7 / FM 9 | | | | |
| Ausrücklager Releaser, clutch | | |  | 08.290.7000.390 Vergl.Nr. Comp.-No. 5010 244 086 |
| passend für to fit to RENAULT: KERAX / MAGNUM / PREMIUM | | | | |
| Ausrücklager Releaser, clutch | | |  | 08.290.7000.400 Vergl.Nr. Comp.-No. 5010 244 017 |
| passend für to fit to RENAULT: KERAX / MAGNUM / PREMIUM | | | | |
| Ausrücklager Releaser, clutch | | | | 08.290.7000.430 Vergl.Nr. Comp.-No. 5010 245 457 |
| passend für to fit to RENAULT: KERAX / MAGNUM / PREMIUM | | | | |

| Kupplungssatz Clutch Kit | | | |
|-----------------------------------------------------------------------------------------------------------------------------------------------------------------------------------------|--------------------------------------------------------------|---------------------------------------------------------------------|--------------------------------------------------------------------------------------|
| Kupplungssatz Clutch Kit | Durchmesser Diameter (mm) | 430 |  |
| passend für to fit to SCANIA: BUS SERIE 3 / SERIE 2 / SERIE 3 Stückliste Parts List 1x 08.320.1000.762 Kupplungsdruckplatte Pressure Plate | | 08.340.1208.1 S Vergl.Nr. Comp.-No. 3400 125 901 | |
| Kupplungssatz Clutch Kit | Durchmesser Diameter (mm) | 430 |  |
| passend für to fit to SCANIA: SERIE 3 Stückliste Parts List 1x 08.320.1000.712 Kupplungsdruckplatte Pressure Plate 1x 08.290.7000.340 Ausrücklager Releaser, clutch | | 08.340.1204.1 S Vergl.Nr. Comp.-No. 3400 700 425 | |
| Kupplungssatz Clutch Kit | Durchmesser Diameter (mm) Zähnezahl Number of Teeth | 430 22 |  |
| passend für to fit to SCANIA: SERIE 3 Stückliste Parts List 1x 08.270.3003.610 Kupplungsscheibe Clutch Plate 1x 08.320.1000.872 Kupplungsdruckplatte Pressure Plate | | 08.340.1225.1 S Vergl.Nr. Comp.-No. 3400 123 801 | |
| Kupplungssatz Clutch Kit | Durchmesser Diameter (mm) | 430 |  |
| passend für to fit to SCANIA: SERIE 3 Stückliste Parts List 1x 08.270.3003.600 Kupplungsscheibe Clutch Plate 1x 08.320.1000.872 Kupplungsdruckplatte Pressure Plate | | 08.340.1153.1 S Vergl.Nr. Comp.-No. 3400 123 701 | |
| Kupplungssatz Clutch Kit | Durchmesser Diameter (mm) | 430 |  |
| passend für to fit to SCANIA: SERIE 4 Stückliste Parts List 08.270.3003.600 Kupplungsscheibe Clutch Plate 1x 08.320.1000.772 Kupplungsdruckplatte Pressure Plate | | 08.340.1123.1 S Vergl.Nr. Comp.-No. 3400 710 004 | |

| Kupplungssatz Clutch Kit | | | |
|---------------------------------------------------------------------------------------------------------------------------------------|------------------------------|-----|----------------------------------------------------------------------------------------------------------------------------------------------------------------|
| Kupplungssatz Clutch Kit | Durchmesser Diameter (mm) | 430 |  <p>08.340.1107.1 S</p> <p>Vergl.Nr. Comp.-No. 3400 122 001</p> |
| passend für to fit to SCANIA: SERIE 4 Stückliste Parts List 1x 08.320.1000.772 Kupplungsdruckplatte Pressure Plate | | | |

| Kupplungsdruckplatte Pressure Plate | | | |
|-----------------------------------------------------------------|------------------------------|-----|----------------------------------------------------------------------------------------------------------------------------------------------------------------|
| Kupplungsdruckplatte Pressure Plate | Durchmesser Diameter (mm) | 400 |  <p>08.320.1000.662</p> <p>Vergl.Nr. Comp.-No. 1 335 281</p> |
| passend für to fit to SCANIA: 3ER / 4ER | | | |
| Kupplungsdruckplatte Pressure Plate | Durchmesser Diameter (mm) | 430 |  <p>08.320.1000.762</p> <p>Vergl.Nr. Comp.-No. 1 102 425</p> |
| passend für to fit to SCANIA: 2ER / 3ER | | | |
| Kupplungsdruckplatte Pressure Plate | Durchmesser Diameter (mm) | 430 |  <p>08.320.1000.712</p> <p>Vergl.Nr. Comp.-No. 1 113 870</p> |
| passend für to fit to SCANIA: 3ER / 4ER | | | |
| Kupplungsdruckplatte Pressure Plate | Durchmesser Diameter (mm) | 430 |  <p>08.320.1000.772</p> <p>Vergl.Nr. Comp.-No. 1 341 687</p> |
| passend für to fit to SCANIA: 4ER | | | |
| Kupplungsdruckplatte Pressure Plate | Durchmesser Diameter (mm) | 430 |  <p>08.320.1000.872</p> <p>Vergl.Nr. Comp.-No. 1 322 780</p> |
| passend für to fit to SCANIA: SERIE 3 | | | |
| Kupplungsdruckplatte Pressure Plate | Durchmesser Diameter (mm) | 430 |  <p>08.320.1000.682</p> <p>Vergl.Nr. Comp.-No. 11009965</p> |
| passend für to fit to DAF: F / CF / 95 / 95XF; SCANIA: BUS | | | |
| Kupplungsdruckplatte Pressure Plate | Durchmesser Diameter (mm) | 395 |  <p>08.320.1000.972</p> <p>Vergl.Nr. Comp.-No. 1375 597</p> |
| passend für to fit to DAF: LF 45 / 55 / CF 65 / CF 75 | | | |

| Kupplungsscheibe Clutch Plate | | | | |
|-------------------------------------------------------------------------|-----------------|------------|--------------------------------------------------------------------------------------|--------------------------------------|
| Kupplungsscheibe Clutch Plate | Durchmesser | 400 |  | 08.270.1000.861 |
| | Diameter (mm) | | | |
| | Zähnezahl | 22 | | |
| | Number of Teeth | | | |
| passend für to fit to SCANIA: SERIE 3 | Nabenprofil | 41x45 -22N | | |
| | Hub Profile | | | Vergl.Nr. Comp.-No. 1 335 282 |
| Kupplungsscheibe Clutch Plate | Durchmesser | 400 |  | 08.270.1000.663 |
| | Diameter (mm) | | | |
| | Zähnezahl | 24 | | |
| | Number of Teeth | | | |
| passend für to fit to SCANIA: SERIE 3 / SERIE 4 | Nabenprofil | 46x50-24N | | |
| | Hub Profile | | | Vergl.Nr. Comp.-No. 1 349 349 |
| Kupplungsscheibe Clutch Plate | Durchmesser | 420 |  | 08.270.1000.553 |
| | Diameter (mm) | | | |
| | Zähnezahl | 10 | | |
| | Number of Teeth | | | |
| passend für to fit to DAF: 85 / A-SERIE / F-SERIE; RENAULT: BUS | Nabenprofil | 1 3/4"-10N | | |
| | Hub Profile | | | Vergl.Nr. Comp.-No. 190 326 |
| Kupplungsscheibe Clutch Plate | Durchmesser | 430 |  | 08.270.3003.610 |
| | Diameter (mm) | | | |
| | Zähnezahl | 22 | | |
| | Number of Teeth | | | |
| passend für to fit to SCANIA 2ER / 3ER | Nabenprofil | 41x45-22N | | |
| | Hub Profile | | | Vergl.Nr. Comp.-No. 1 304 781 |
| Kupplungsscheibe Clutch Plate | Durchmesser | 430 |  | 08.270.1000.703 |
| | Diameter (mm) | | | |
| | Zähnezahl | 24 | | |
| | Number of Teeth | | | |
| passend für to fit to SCANIA: PRT / SERIE 4 | Nabenprofil | 46x50-24N | | |
| | Hub Profile | | | Vergl.Nr. Comp.-No. 1 436 695 |
| Kupplungsscheibe Clutch Plate | Durchmesser | 430 |  | 08.270.3003.600 |
| | Diameter (mm) | | | |
| | Zähnezahl | 24 | | |
| | Number of Teeth | | | |
| passend für to fit to SCANIA 3ER / 4ER | Nabenprofil | | | |
| | Hub Profile | | | Vergl.Nr. Comp.-No. 1 111 148 |
| Kupplungsscheibe Clutch Plate | Durchmesser | 430 |  | 08.270.1000.620 |
| | Diameter (mm) | | | |
| | Zähnezahl | 10 | | |
| | Number of Teeth | | | |
| passend für to fit to MERCEDES-BENZ: SK | Nabenprofil | | | |
| | Hub Profile | | | Vergl.Nr. Comp.-No. 0421.341.10 |



| Ausrücklager Releaser, cluth | | | | |
|---------------------------------------------------------------------------------------------------------------------------------------------------------------------------------------------------------------------------------------------------------------------|------------------------------------------|-----------------------------|--------------------------------------------------------------------------------------|------------------------------------------------------------------|
| Ausrücklager Releaser, cluth | Innendurchmesser Inner Diameter (mm) | 60,5 |  | 08.290.7000.230 Vergl.Nr. Comp.-No. 1 321 260 |
| | Aussendurchmesser Outer Diameter (mm) | 126,6 | | |
| passend für to fit to SCANIA: SERIE 2 / SERIE 3 | Breite Width (mm) | 95 | | |
| | | | | |
| Ausrücklager Releaser, cluth | Innendurchmesser Inner Diameter (mm) | 60,8 |  | 08.290.7000.340 Vergl.Nr. Comp.-No. 1 393 161 |
| | Aussendurchmesser Outer Diameter (mm) | 126,6 | | |
| passend für to fit to SCANIA: SERIE 3 | Breite Width (mm) | 91,5 | | |
| | | | | |
| Ausrücklager Releaser, cluth | Info | Montagesatz Assembly Kit |  | 08.290.7000.550 Vergl.Nr. Comp.-No. 1 393 187 |
| passend für to fit to MERCEDES-BENZ: ACTROS / ACTROS MP2 / ATEGO / ECONIC; RENAULT: C / G / MAGNUM / MAJOR / MANAGER / MAXTER / R - SCANIA SERIE 2 / SERIE 3 / SERIE 4; VOLVO: 9700 / 9900 / B 12 / FH 12 / FL 10 / FL 12 / FM 12 / FM 7 / FM 9 | | | | |
| | | | | |
| | | | | |
| Ausrücklager Releaser, cluth | Kenngroße Parameter | KZISZ-5 |  | 08.290.7000.380 Vergl.Nr. Comp.-No. 1 479 576 |
| passend für to fit to SCANIA: 4ER / PRT | | | | |
| | | | | |
| | | | | |

| Kupplungssatz Clutch Kit | | | |
|-----------------------------------------------------------------------------------------------------------------------------------------------------------------------------------------------------------------|------------------------------|-----|--------------------------------------------------------------------------------------|
| Kupplungssatz Clutch Kit | Durchmesser Diameter (mm) | 400 |  |
| | Zähnezahl Number of Teeth | 10 | |
| passend für to fit to VOLVO: B 7 / B 10 / B 12 Stückliste Parts List 1x 08.320.1000.942 Kupplungsdruckplatte Pressure Plate 1x 08.270.1000.513 Kupplungsscheibe Clutch Plate | | | |
| | | | 08.340.1226.1 S Vergl.Nr. Comp.-No. 85 000 185 |
| Kupplungssatz Clutch Kit | Durchmesser Diameter (mm) | 400 |  |
| | Zähnezahl Number of Teeth | 10 | |
| passend für to fit to VOLVO: FH 12 / FH 16 / FM 12 Stückliste Parts List 1x 08.320.1000.952 Kupplungsdruckplatte Pressure Plate 1x 08.270.1000.961 Kupplungsscheibe Clutch Plate | | | |
| | | | 08.340.1150.1 S Vergl.Nr. Comp.-No. 85 000 313 |
| Kupplungssatz Clutch Kit | Durchmesser Diameter (mm) | 400 |  |
| | Zähnezahl Number of Teeth | 24 | |
| passend für to fit to VOLVO: FH 12 / FM 12 / FM 12H Stückliste Parts List 1x 08.270.1000.523 Kupplungsscheibe Clutch Plate 1x 08.320.1000.952 Kupplungsdruckplatte Pressure Plate | | | |
| | | | 08.340.1269.1 S Vergl.Nr. Comp.-No. 3400 700 422 |
| Kupplungssatz Clutch Kit | Durchmesser Diameter (mm) | 400 |  |
| | Zähnezahl Number of Teeth | 10 | |
| passend für to fit to VOLVO: FH 16 | | | |
| | | | 08.340.1000.33S Vergl.Nr. Comp.-No. 1669 135 |
| Kupplungssatz Clutch Kit | Durchmesser Diameter (mm) | 400 |  |
| | Zähnezahl Number of Teeth | 10 | |
| passend für to fit to VOLVO: FL 10 / FS 7 Stückliste Parts List 1x 08.320.1000.882 Kupplungsdruckplatte Pressure Plate 1x 08.270.1000.921 Kupplungsscheibe Clutch Plate | | | |
| | | | 08.340.1228.1 S Vergl.Nr. Comp.-No. 8113 803 |
| Kupplungssatz Clutch Kit | Durchmesser Diameter (mm) | 430 |  |
| | Zähnezahl Number of Teeth | 10 | |
| passend für to fit to VOLVO: B 10 / FH 12 / FL 12 / FM 12 Stückliste Parts List 1x 08.320.1000.732 Kupplungsdruckplatte Pressure Plate 1x 08.270.1000.701 Kupplungsscheibe Clutch Plate | | | |
| | | | 08.340.1101.1 S Vergl.Nr. Comp.-No. 8112 191 |

| Kupplungssatz Clutch Kit | | | |
|------------------------------------------------------------------------------------------------------------------------------------------------------------------------------------------------------------|------------------------------|-----|--------------------------------------------------------------------------------------|
| Kupplungssatz Clutch Kit | Durchmesser Diameter (mm) | 430 |  |
| | Zähnezahl Number of Teeth | 10 | |
| passend für to fit to VOLVO: B 10 / FL 10 / N 10 Stückliste Parts List 1x 08.320.1000.642 Kupplungsdruckplatte Pressure Plate 1x 08.270.1000.891 Kupplungsscheibe Clutch Plate | | | 08.340.1220.1 S Vergl.Nr. Comp.-No. 8112 160 |
| Kupplungssatz Clutch Kit | Durchmesser Diameter (mm) | 430 |  |
| | | | |
| passend für to fit to VOLVO: B 7 / FM 7 / FM 10 Stückliste Parts List 1x 08.320.1000.732 Kupplungsdruckplatte Pressure Plate 1x 08.270.1000.741 Kupplungsscheibe Clutch Plate | | | 08.340.1209.1 S Vergl.Nr. Comp.-No. 8113 824 |
| Kupplungssatz Clutch Kit | Durchmesser Diameter (mm) | 430 |  |
| | | | |
| passend für to fit to VOLVO: FH 12 / FM 12 / FM 7 Stückliste Parts List 1x 08.320.1000.832 Kupplungsdruckplatte Pressure Plate 1x 08.270.1000.701 Kupplungsscheibe Clutch Plate | | | 08.340.1114.1 S Vergl.Nr. Comp.-No. 8113 811 |
| Kupplungssatz Clutch Kit | Durchmesser Diameter (mm) | 430 |  |
| | | | |
| passend für to fit to VOLVO: FH 12 / FM 12 / FM 9 Stückliste Parts List 1x 08.320.1000.832 Kupplungsdruckplatte Pressure Plate 1x 08.270.1000.523 Kupplungsscheibe Clutch Plate | | | 08.340.1152.1 S Vergl.Nr. Comp.-No. 85 000 268 |
| Kupplungssatz Clutch Kit | Durchmesser Diameter (mm) | 430 |  |
| | Zähnezahl Number of Teeth | 10 | |
| passend für to fit to VOLVO: FH 12; RENAULT: PREMIUM Stückliste Parts List 1x 08.320.1000.892 Kupplungsdruckplatte Pressure Plate 1x 08.270.1000.793 Kupplungsscheibe Clutch Plate | | | 08.340.1265.1 S Vergl.Nr. Comp.-No. 85 000 542 |

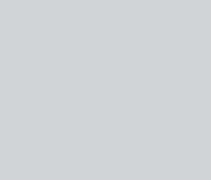
| Kupplungsdruckplatte Pressure Plate | | | | |
|---------------------------------------------------------------|------------------------------|-----|---------------------------------------------------------------------------------------|-----------------------------------------------------------------|
| Kupplungsdruckplatte Pressure Plate | Durchmesser Diameter (mm) | 400 |  | 08.320.1000.882 Vergl.Nr. Comp.-No. 1668 665 |
| passend für to fit to VOLVO: FL | | | | |
| Kupplungsdruckplatte Pressure Plate | Durchmesser Diameter (mm) | 430 |  | 08.320.1000.642 Vergl.Nr. Comp.-No. 1527 517 |
| passend für to fit to VOLVO: B10 / B12 / FL | | | | |
| Kupplungsdruckplatte Pressure Plate | Durchmesser Diameter (mm) | 430 |  | 08.320.1000.892 Vergl.Nr. Comp.-No. 1521 713 |
| passend für to fit to VOLVO: FH 12 | | | | |
| Kupplungsdruckplatte Pressure Plate | Durchmesser Diameter (mm) | 430 |  | 08.320.1000.832 Vergl.Nr. Comp.-No. 3192 201 |
| passend für to fit to VOLVO: FH 12 / FM 7 / FM 9 / FM 12 | | | | |
| Kupplungsdruckplatte Pressure Plate | Durchmesser Diameter (mm) | 430 |  | 08.320.1000.732 Vergl.Nr. Comp.-No. 1521 721 |
| passend für to fit to VOLVO: B7 / B12 / FH / FM | | | | |
| Kupplungsdruckplatte Pressure Plate | Durchmesser Diameter (mm) | 400 |  | 08.320.1000.942 Vergl.Nr. Comp.-No. 1668 927 |
| passend für to fit to VOLVO: B7 / B10 / B12 | | | | |
| Kupplungsdruckplatte Pressure Plate | Durchmesser Diameter (mm) | 400 |  | 08.320.1000.952 Vergl.Nr. Comp.-No. 1521 714 |
| passend für to fit to VOLVO: FH / FM | | | | |
| Kupplungsdruckplatte Pressure Plate | Durchmesser Diameter (mm) | 400 |  | 08.320.1000.310 Vergl.Nr. Comp.-No. 1521 725 |
| passend für to fit to VOLVO: FH 12 / FH 16 / FM 12 | | | | |

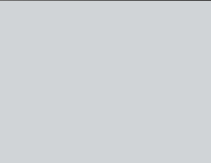
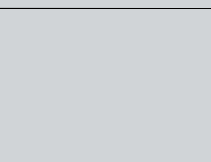
| Kupplungsdruckplatte Pressure Plate | | | |
|-------------------------------------------------|------------------------------|-----|------------------------------------------------------------------------------------|
| Kupplungsdruckplatte Pressure Plate | Durchmesser Diameter (mm) | 400 |  |
| passend für to fit to VOLVO: FH 16 | | | |
| | | | 08.320.1000.320 |
| | | | Vergl.Nr. Comp.-No. 1669 134 |
| Kupplungsdruckplatte Pressure Plate | Durchmesser Diameter (mm) | 430 |  |
| passend für to fit to VOLVO: FH 12 / FM 12 | | | |
| | | | 08.320.1000.992 |
| | | | Vergl.Nr. Comp.-No. 1521 718 |

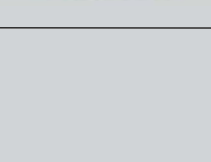
| Kupplungsscheibe Clutch Plate | | | |
|------------------------------------------------------------------------------|------------------------------|-------------|--------------------------------------------------------------------------------------|
| Kupplungsscheibe Clutch Plate | Durchmesser Diameter (mm) | 350 |  |
| passend für to fit to VOLVO: B10 / FL / N / NL | Zähnezahl Number of Teeth | 10 | |
| | Nabenprofil Hub Profile | 2"-10N | 08.270.1000.543 |
| | | | Vergl.Nr. Comp.-No. 1526 047 |
| Kupplungsscheibe Clutch Plate | Durchmesser Diameter (mm) | 350 |  |
| passend für to fit to VOLVO F7 / FL 10 | Zähnezahl Number of Teeth | 10 | |
| | Nabenprofil Hub Profile | 2"-10N | 08.270.1000.753 |
| | | | Vergl.Nr. Comp.-No. 1526 046 |
| Kupplungsscheibe Clutch Plate | Durchmesser Diameter (mm) | 380 |  |
| passend für to fit to VOLVO FH 12 / FL 12 / FM 12 | Zähnezahl Number of Teeth | 8 | |
| | Nabenprofil Hub Profile | 88,5x102-8N | 08.270.1000.843 |
| | | | Vergl.Nr. Comp.-No. 1668 375 |
| Kupplungsscheibe Clutch Plate | Durchmesser Diameter (mm) | 380 |  |
| passend für to fit to MERCEDES-BENZ: SK; RENAULT: F10 / F12 / N10 / N12 | Zähnezahl Number of Teeth | 10 | |
| | Nabenprofil Hub Profile | 2"-10N | 08.270.1000.951 |
| | | | Vergl.Nr. Comp.-No. 1667 929 |
| Kupplungsscheibe Clutch Plate | Durchmesser Diameter (mm) | 380 |  |
| passend für to fit to VOLVO FH 12 / FL 12 / FM 12 | Zähnezahl Number of Teeth | 10 | |
| | Nabenprofil Hub Profile | 2"-10N | 08.270.1000.833 |
| | | | Vergl.Nr. Comp.-No. 1669 141 |

Kupplungsscheibe | Clutch Plate

| | | | | |
|---------------------------------------------------------------------------------------------------|--------------------------------------------------------------------------------------------------------------|----------------------------------------|--------------------------------------------------------------------------------------|---------------------------------------------------------------------------|
| <p>Kupplungsscheibe Clutch Plate</p> <p>passend für to fit to VOLVO: FH12 / FH16</p> | <p>Durchmesser Diameter (mm)</p> <p>Zähnezahl Number of Teeth</p> <p>Nabenprofil Hub Profile</p> | <p>400</p> <p>8</p> <p>85x98-8N</p> |  | <p>08.270.1000.713</p> <p>Vergl.Nr. Comp.-No. 8171 497</p> |
| <p>Kupplungsscheibe Clutch Plate</p> <p>passend für to fit to VOLVO: B7 / B10 / B12</p> | <p>Durchmesser Diameter (mm)</p> <p>Zähnezahl Number of Teeth</p> <p>Nabenprofil Hub Profile</p> | <p>400</p> <p>10</p> <p>1 3/4"-10N</p> |  | <p>08.270.1000.513</p> <p>Vergl.Nr. Comp.-No. 1668 929</p> |
| <p>Kupplungsscheibe Clutch Plate</p> <p>passend für to fit to VOLVO: FL</p> | <p>Durchmesser Diameter (mm)</p> <p>Zähnezahl Number of Teeth</p> <p>Nabenprofil Hub Profile</p> | <p>400</p> <p>10</p> <p>2"-10N</p> |  | <p>08.270.1000.891</p> <p>Vergl.Nr. Comp.-No. 1527 519</p> |
| <p>Kupplungsscheibe Clutch Plate</p> <p>passend für to fit to VOLVO FH 16</p> | <p>Durchmesser Diameter (mm)</p> <p>Zähnezahl Number of Teeth</p> <p>Nabenprofil Hub Profile</p> | <p>400</p> <p>10</p> <p>2"-10N</p> |  | <p>08.270.1000.773</p> <p>Vergl.Nr. Comp.-No. 1669 139</p> |
| <p>Kupplungsscheibe Clutch Plate</p> <p>passend für to fit to VOLVO F 16</p> | <p>Durchmesser Diameter (mm)</p> <p>Zähnezahl Number of Teeth</p> <p>Nabenprofil Hub Profile</p> | <p>400</p> <p>10</p> <p>2"-10N</p> |  | <p>08.270.1000.853</p> <p>Vergl.Nr. Comp.-No. 1655 878</p> |
| <p>Kupplungsscheibe Clutch Plate</p> <p>passend für to fit to VOLVO FH 16</p> | <p>Durchmesser Diameter (mm)</p> <p>Zähnezahl Number of Teeth</p> <p>Nabenprofil Hub Profile</p> | <p>400</p> <p>10</p> <p>2"-10N</p> |  | <p>08.270.1000.763</p> <p>Vergl.Nr. Comp.-No. 85 000 311</p> |
| <p>Kupplungsscheibe Clutch Plate</p> <p>passend für to fit to VOLVO: FL</p> | <p>Durchmesser Diameter (mm)</p> <p>Zähnezahl Number of Teeth</p> <p>Nabenprofil Hub Profile</p> | <p>400</p> <p>10</p> <p>2"-10N</p> |  | <p>08.270.1000.921</p> <p>Vergl.Nr. Comp.-No. 1668 667</p> |
| <p>Kupplungsscheibe Clutch Plate</p> <p>passend für to fit to VOLVO: FH / FM</p> | <p>Durchmesser Diameter (mm)</p> <p>Zähnezahl Number of Teeth</p> <p>Nabenprofil Hub Profile</p> | <p>400</p> <p>10</p> <p>2"-10N</p> |  | <p>08.270.1000.961</p> <p>Vergl.Nr. Comp.-No. 1521 717</p> |



| Kupplungsscheibe Clutch Plate | | | | |
|----------------------------------------------------------------------------------------------------|------------------------------|-----------|--------------------------------------------------------------------------------------|-------------------------------------------------------------------|
| Kupplungsscheibe Clutch Plate passend für to fit to VOLVO: B7 / B10 / FL / FM | Durchmesser Diameter (mm) | 430 |  | 08.270.1000.741 Vergl.Nr. Comp.-No. 1524 768 |
| | Zähnezahl Number of Teeth | 10 | | |
| | Nabenprofil Hub Profile | 2" -10N | | |
| | | | | |
| Kupplungsscheibe Clutch Plate passend für to fit to VOLVO: B10 / B12 / FH / FM | Durchmesser Diameter (mm) | 430 |  | 08.270.1000.701 Vergl.Nr. Comp.-No. 1524 771 |
| | Zähnezahl Number of Teeth | 10 | | |
| | Nabenprofil Hub Profile | 2"-10N | | |
| | | | | |
| Kupplungsscheibe Clutch Plate passend für to fit to RENAULT: PREMIUM - VOLVO: FH 12 | Durchmesser Diameter (mm) | 430 |  | 08.270.1000.793 Vergl.Nr. Comp.-No. 1521 716 |
| | Zähnezahl Number of Teeth | 10 | | |
| | Nabenprofil Hub Profile | 2"-10N | | |
| | | | | |
| Kupplungsscheibe Clutch Plate passend für to fit to VOLVO: B12; RENAULT: MAGNUM | Durchmesser Diameter (mm) | 430 |  | 08.270.1000.523 Vergl.Nr. Comp.-No. 3191 766 |
| | Zähnezahl Number of Teeth | 24 | | |
| | Nabenprofil Hub Profile | 46x50-24N | | |
| | | | | |
| Kupplungsscheibe Clutch Plate passend für to fit to RENAULT: MAGNUM - VOLVO: FH 12 | Durchmesser Diameter (mm) | 430 |  | 08.270.1000.783 Vergl.Nr. Comp.-No. 20 525 015 |
| | Zähnezahl Number of Teeth | 24 | | |
| | Nabenprofil Hub Profile | 46x50-24N | | |
| | | | | |

Ausrücklager | Releaser, clutch

| | | | | |
|----------------------------------------------------------------------------------------------------------------|------------------------------------------|-------|---------------------------------------------------------------------------------------|-----------------------------------------------------------------|
| Ausrücklager Releaser, clutch | Innendurchmesser Inner Diameter (mm) | 45,5 |  | 08.290.7000.090 Vergl.Nr. Comp.-No. 685611 |
| passend für to fit to DAF: F; IVECO: EUROFIRE / MK / PPA; MAN: G / L2000 / M90; RENAULT: MIDLI- NER | Aussendurchmesser Outer Diameter (mm) | 95 | | |
| | Breite Width (mm) | 31,5 | | |
| | | | | |
| Ausrücklager Releaser, clutch | Innendurchmesser Inner Diameter (mm) | 58,2 |  | 08.290.7000.260 Vergl.Nr. Comp.-No. 1655 288 |
| passend für to fit to VOLVO: B7 / B10 / FL | Aussendurchmesser Outer Diameter (mm) | 115 | | |
| | Breite Width (mm) | 54,3 | | |
| | | | | |
| Ausrücklager Releaser, clutch | Innendurchmesser Inner Diameter (mm) | 58,2 |  | 08.290.7000.320 Vergl.Nr. Comp.-No. 1655 287 |
| passend für to fit to VOLVO: FL 6 | Aussendurchmesser Outer Diameter (mm) | 115 | | |
| | Breite Width (mm) | 72 | | |
| | | | | |
| Ausrücklager Releaser, clutch | Innendurchmesser Inner Diameter (mm) | 58,5 |  | 08.290.7000.310 Vergl.Nr. Comp.-No. 1668 930 |
| passend für to fit to VOLVO: FS 7 | Aussendurchmesser Outer Diameter (mm) | 126,6 | | |
| | Breite Width (mm) | 77 | | |
| | | | | |
| Ausrücklager Releaser, clutch | Innendurchmesser Inner Diameter (mm) | 58,5 |  | 08.290.7000.360 Vergl.Nr. Comp.-No. 3192 226 |
| passend für to fit to VOLVO: B 7 | Aussendurchmesser Outer Diameter (mm) | 126,6 | | |
| | Breite Width (mm) | 84 | | |
| | | | | |
| Ausrücklager Releaser, clutch | Innendurchmesser Inner Diameter (mm) | 66,1 |  | 08.290.7000.330 Vergl.Nr. Comp.-No. 1527 695 |
| passend für to fit to VOLVO: B / F / G / N | Aussendurchmesser Outer Diameter (mm) | 115 | | |
| | Breite Width (mm) | 72 | | |
| | | | | |
| Ausrücklager Releaser, clutch | Innendurchmesser Inner Diameter (mm) | 66,8 |  | 08.290.7000.350 Vergl.Nr. Comp.-No. 1672 945 |
| passend für to fit to VOLVO: FH | Aussendurchmesser Outer Diameter (mm) | 126,6 | | |
| | Breite Width (mm) | 74 | | |
| | | | | |

| Ausrücklager Releaser, clucth | | | | |
|------------------------------------------------------------------------------------------------------------------------------------------------------------------------------------------------------------------------------------------------------|------------------------------------------|-----------------------------|--------------------------------------------------------------------------------------|-------------------------------------------------------------------|
| Ausrücklager Releaser, clucth | Innendurchmesser Inner Diameter (mm) | 66,8 |  | 08.290.7000.010 Vergl.Nr. Comp.-No. 1655 732 |
| passend für to fit to VOLVO: B7 / FL7 / FL10 / FS7 | Aussendurchmesser Outer Diameter (mm) | 126,6 | | |
| | Breite Width (mm) | 86,5 | | |
| | | | | |
| Ausrücklager Releaser, clucth | | |  | 08.290.7000.490 Vergl.Nr. Comp.-No. 1672 944 |
| passend für to fit to VOLVO: 9700 / 9900 / FH 12 / FH 16 / FL 10 / FL 12 / FM 12 / FM 9 | | | | |
| Ausrücklager Releaser, clucth | | |  | 08.290.7000.520 Vergl.Nr. Comp.-No. 20 569 153 |
| passend für to fit to VOLVO: 9700 / 9900 / B 12 / FH 12 / FL 12 / FM 12 / FM 7 / FM 9 | | | | |
| Ausrücklager Releaser, clucth | | | | 08.290.7000.530 Vergl.Nr. Comp.-No. 20 569 151 |
| passend für to fit to VOLVO: 9700 / 9900 / FH 12 / FH 16 / FM 12 / FM 9 | | | | |
| Ausrücklager Releaser, clucth | | |  | 08.290.7000.540 Vergl.Nr. Comp.-No. 20 569 155 |
| passend für to fit to VOLVO: FH 12 / FM 12 / FM 7 | | | | |
| Ausrücklager Releaser, clucth | Info | Montagesatz Assembly Kit |  | 08.290.7000.550 Vergl.Nr. Comp.-No. 20 571 945 |
| passend für to fit to MERCEDES-BENZ: ACTROS / ACTROS MP2 / ATEGO / ECONIC; RENAULT: C / G / MAGNUM / MAJOR / MANAGER / MAXTER / R - SCANIA SERIE 2 / SERIE 3 / SERIE 4; VOLVO: 9700 / 9900 / B 12 / FH 12 / FL 10 / FL 12 / FM 12 / FM 7 / FM 9 | | | | |

Ausrückgabel, Kupplung | Release Fork, clutch

| | | |
|-------------------------------------------------------------------------------------------------------------------------------------------------------------------------------------------------|--------------------------------------------------------------------------------------|------------------------------------------------------------------------------|
| <p>Ausrückgabel, Kupplung Release Fork, clutch</p> <p>passend für to fit to MAN</p> | | <p>08.290.0909.300</p> <p>Vergl.Nr. Comp.-No. 81.30560.0057</p> |
| <p>Ausrückgabel, Kupplung Release Fork, clutch</p> <p>passend für to fit to MAN</p> | | <p>08.290.0909.310</p> <p>Vergl.Nr. Comp.-No. 81.32411.0007</p> |
| <p>Ausrückgabel, Kupplung Release Fork, clutch</p> <p>passend für to fit to Mercedes-Benz</p> <p>für Modell für Modell MK; NG; O 302; O 303; O 340; O 404; SK; TOURISMO</p> |  | <p>08.290.1002.010</p> <p>Vergl.Nr. Comp.-No. 650 250 00 13</p> |
| <p>Ausrückgabel, Kupplung Release Fork, clutch</p> <p>passend für to fit to Mercedes-Benz</p> <p>für Modell für Modell ACTROS</p> |  | <p>08.290.1002.030</p> <p>Vergl.Nr. Comp.-No. 655 250 15 13</p> |

Bolzen | Bolt



| | | | |
|--------|-----------------------|-----|-------------------------------------------------------------------------------------------------------------------------------------------------------------------|
| Bolzen | Aussendurchmesser | 30 |  <p>08.290.1002.000</p> <p>Vergl.Nr. Comp.-No. 650 254 00 06</p> |
| Bolt | Outer Diameter (mm) | | |
| | Länge | 180 | |
| | Length (mm) | | |
| | Aussendurchmesser 1 | 29 | |
| | Outer Diameter 1 (mm) | | |
| | Länge 1 | 120 | |
| | Length 1 (mm) | | |
| | DIN/ISO | 668 | |
| | DIN / ISO | | |

Zubehör | Accessories







Bolzen Bolt

| Bolzen Bolt | | | |
|------------------------------------------|----------------------------------------------|-----|-----------------------------------------------------------------------------------------------------------------------------------------------------------------|
| Bolzen Bolt | Aussendurchmesser Outer Diameter (mm) | 32 |  <p>08.290.1002.060</p> <p>Vergl.Nr. Comp.-No. 655 254 02 06</p> |
| | Länge Length (mm) | 160 | |
| | Aussendurchmesser 1 Outer Diameter 1 (mm) | 36 | |
| | Länge 1 Length 1 (mm) | 100 | |
| | | | |
| Bolzen Bolt | Aussendurchmesser Outer Diameter (mm) | 20 | <p>08.280.1922.000</p> <p>Vergl.Nr. Comp.-No. 385 268 14 74</p> |
| | Länge Length (mm) | 120 | |
| passend für to fit to Mercedes-Benz | | | |
| für Modell für Modell LP | | | |

| Reparatursatz, Ausrücklager Repair Kit, clutch releaser | | |
|------------------------------------------------------------|--------------------------------------------------------------------------------------|------------------------------------------------------------------------------|
| Reparatursatz, Ausrücklager Repair Kit, clutch releaser | | <p>08.290.0909.2 S</p> <p>Vergl.Nr. Comp.-No. 81.30560.6022</p> |
| passend für to fit to MAN | | |
| Reparatursatz, Ausrücklager Repair Kit, clutch releaser |  | <p>08.290.0909.20S</p> <p>Vergl.Nr. Comp.-No. 81.30560.6019</p> |
| passend für to fit to MAN | | |
| Reparatursatz, Ausrücklager Repair Kit, clutch releaser |  | <p>08.290.1928.1 S</p> <p>Vergl.Nr. Comp.-No. 385 250 00 14</p> |
| passend für to fit to MERCEDES-BENZMercedes-Benz | | |
| für Modell für Modell NG; O 303; O 307; SK | | |
| Reparatursatz, Ausrücklager Repair Kit, clutch releaser |  | <p>08.290.1933.1 S</p> <p>Vergl.Nr. Comp.-No. 363 250 01 14</p> |
| passend für to fit to MERCEDES-BENZMercedes-Benz | | |

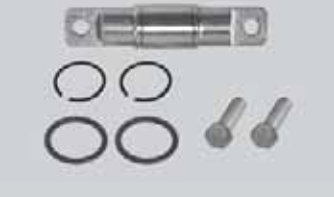
Reparatursatz, Ausrücklager | Repair Kit, clutch releaser

| | | |
|-------------------------------------------------------------------------------------------------------------------------------------------------------------------------------------------------------------------------------------------------------------------------------------------------------------------------------------------------------------------------------------------------------------------------------------|--------------------------------------------------------------------------------------|--------------------------------------------------------------------------------|
| <p>Reparatursatz, Ausrücklager Repair Kit, clutch releaser</p> <p>passend für to fit to MERCEDES-BENZMercedes-Benz</p> <p>Stückliste Parts List 2 x 06.090.1941.020 Lager, Achsschenkel Bearing, stub axle 2 x 08.290.1941.010 Schraube Screw 2 x 11.060.1941.030 Wellendichtring Shaft Oil Seal</p> |  | <p>08.290.1941.1 S</p> <p>Vergl.Nr. Comp.-No. 620 250 02 14</p> |
| <p>Reparatursatz, Ausrücklager Repair Kit, clutch releaser</p> <p>passend für to fit to MERCEDES-BENZMercedes-Benz</p> <p>Stückliste Parts List 1 x 08.290.1002.060 Bolzen Bolt 2 x 08.290.1941.310 Schraube Screw 2 x 08.290.1941.320 Sicherungsring Circlip 2 x 08.290.1941.340 Buchse Bush</p> |  | <p>08.290.1941.3 S</p> <p>Vergl.Nr. Comp.-No. 655 254 02 06 S</p> |
| <p>Reparatursatz, Ausrücklager Repair Kit, clutch releaser</p> <p>passend für to fit to MERCEDES-BENZMercedes-Benz</p> <p>Stückliste Parts List 1 x 08.290.1002.060 Bolzen Bolt 2 x 08.290.1941.310 Schraube Screw 2 x 08.290.1941.320 Sicherungsring Circlip</p> |  | <p>08.290.1941.30S</p> <p>Vergl.Nr. Comp.-No. 655 254 02 06 S</p> |
| <p>Reparatursatz, Ausrücklager Repair Kit, clutch releaser</p> <p>passend für to fit to MERCEDES-BENZMercedes-Benz</p> <p>für Modell für Modell MK; NG; O 302; O 303; O 340; O 404; SK; TOURISMO O 350</p> <p>Stückliste Parts List 4 x 08.290.1941.060 Sicherungsring Circlip 2 x 08.290.1941.070 Buchse Bush 1 x 08.290.1002.000 Bolzen Bolt 2 x 08.290.1941.010 Schraube Screw</p> |  | <p>08.290.1942.1 S</p> <p>Vergl.Nr. Comp.-No. 650 254 00 06 S</p> |

Schwungrad | Flywheel

| | | |
|-------------------------------------------------------------------------------|-----------------------------------------------------------------------------|--------------------------------------------------------------------------|
| <p>Schwungrad Flywheel</p> <p>passend für to fit to IVECO: P/PA</p> | <p>Durchmesser Diameter (mm)</p> <p style="text-align: center;">430</p> | <p>08.150.0812.010</p> <p>Vergl.Nr. Comp.-No. 0469 9030</p> |
|-------------------------------------------------------------------------------|-----------------------------------------------------------------------------|--------------------------------------------------------------------------|

Zubehör | Accessories

Schwungrad Flywheel









| Schwungrad Flywheel | | | |
|----------------------------------------------------------------------------------------|------------------------------|-----|--------------------------------------------------------------------------------------|
| Schwungrad Flywheel | Durchmesser Diameter (mm) | 400 | 08.150.0912.020 |
| | Zähnezahl Number of Teeth | 160 | |
| passend für to fit to MAN: F 90; F 90 Unterflur | | | Vergl.Nr. Comp.-No. 3421 601 013 |
| Schwungrad Flywheel | Durchmesser Diameter (mm) | 430 | 08.150.0912.060 |
| | Zähnezahl Number of Teeth | 160 | |
| passend für to fit to MAN | | | Vergl.Nr. Comp.-No. 3421 601 047 |
| Schwungrad Flywheel | Durchmesser Diameter (mm) | 430 | 08.150.0912.070 |
| | Zähnezahl Number of Teeth | 160 | |
| passend für to fit to MAN | | | Vergl.Nr. Comp.-No. 3421 601 014 |
| Schwungrad Flywheel | Durchmesser Diameter (mm) | 380 |  |
| | Zähnezahl Number of Teeth | 160 | |
| passend für to fit to Mercedes-Benz | | | Vergl.Nr. Comp.-No. 51.02301.7290 |
| für Modell für Modell NG; O 303; O 305; O 307 | | | |
| Schwungrad Flywheel | Durchmesser Diameter (mm) | 420 |  |
| | Zähnezahl Number of Teeth | 160 | |
| passend für to fit to Mercedes-Benz | | | Vergl.Nr. Comp.-No. 51.02301.0307 |
| für Modell für Modell MK; NG; NG; O 303; O 303; O 305; O 307; O 405; O 407; SK | | | |
| Schwungrad Flywheel | Durchmesser Diameter (mm) | 400 |  |
| | Zähnezahl Number of Teeth | 160 | |
| passend für to fit to Mercedes-Benz | | | Vergl.Nr. Comp.-No. 441 030 04 05 |
| für Modell für Modell NG | | | |

| Schwungrad Flywheel | | | | |
|------------------------------------------------------------|-----------------|-----|--------------------------------------------------------------------------------------|----------------------------------------|
| Schwungrad Flywheel | Durchmesser | 430 |  | 08.150.1001.080 |
| | Diameter (mm) | | | |
| passend für to fit to Mercedes-Benz | Zähnezahl | 160 | | Vergl.Nr. Comp.-No. 3421 601 011 |
| | Number of Teeth | | | |
| für Modell für Modell MK; NG; O 303; O 340; O 404; SK | | | | |
| Schwungrad Flywheel | Durchmesser | 390 |  | 08.150.1001.090 |
| | Diameter (mm) | | | |
| passend für to fit to Mercedes-Benz | Zähnezahl | 160 | | Vergl.Nr. Comp.-No. 422 030 05 05 |
| | Number of Teeth | | | |
| für Modell für Modell NG; SK | | | | |
| Schwungrad Flywheel | Durchmesser | 430 |  | 08.150.1001.100 |
| | Diameter (mm) | | | |
| passend für to fit to Mercedes-Benz | Zähnezahl | 160 | | Vergl.Nr. Comp.-No. 3421 601 016 |
| | Number of Teeth | | | |
| für Modell für Modell ACTROS; ACTROS MP2 | | | | |
| Schwungrad Flywheel | Durchmesser | 430 |  | 08.150.1001.110 |
| | Diameter (mm) | | | |
| passend für to fit to Mercedes-Benz | Zähnezahl | 160 | | Vergl.Nr. Comp.-No. 442 030 05 05 |
| | Number of Teeth | | | |
| für Modell für Modell MK; O 340; O 404; SK | | | | |
| Schwungrad Flywheel | Durchmesser | 360 |  | 08.150.1001.120 |
| | Diameter (mm) | | | |
| passend für to fit to Mercedes-Benz | Zähnezahl | 132 | | Vergl.Nr. Comp.-No. 352 030 73 05 |
| | Number of Teeth | | | |
| für Modell für Modell LK/LN2; MB-TRAC; MK; NG; UNIMOG | | | | |

Zubehör | Accessories

Schwungrad Flywheel



| Schwungrad Flywheel | | | | |
|-----------------------------------------------------------------------------|------------------------------|-----|---------------------------------------------------------------------------------------|----------------------------------------------------------------------|
| Schwungrad Flywheel | Durchmesser Diameter (mm) | 310 |  | 08.150.1001.130 Vergl.Nr. Comp.-No. 352 030 39 05 |
| passend für to fit to Mercedes-Benz | Zähnezahl Number of Teeth | 125 | | |
| für Modell für Modell LK/LN2; LP; MB-TRAC; NG; O 301; O 402; UNIMOG | | | | |
| Schwungrad Flywheel | Durchmesser Diameter (mm) | 350 |  | 08.150.1001.140 Vergl.Nr. Comp.-No. 3421 601 004 |
| passend für to fit to Mercedes-Benz | Zähnezahl Number of Teeth | 146 | | |
| für Modell für Modell LK/LN2; T2/LN1; UNIMOG | | | | |
| Schwungrad Flywheel | Durchmesser Diameter (mm) | 350 |  | 08.150.1001.150 Vergl.Nr. Comp.-No. 327 030 02 11 |
| passend für to fit to Mercedes-Benz | | | | |
| für Modell für Modell O 302 | | | | |
| Schwungrad Flywheel | Durchmesser Diameter (mm) | 380 |  | 08.150.1001.160 Vergl.Nr. Comp.-No. 3421 601 007 |
| passend für to fit to Mercedes-Benz | | | | |
| für Modell für Modell LK/LN2; MK | | | | |
| Schwungrad Flywheel | Durchmesser Diameter (mm) | 380 |  | 08.150.1001.170 Vergl.Nr. Comp.-No. 3421 601 001 |
| passend für to fit to Mercedes-Benz | Zähnezahl Number of Teeth | 154 | | |
| Schwungrad Flywheel | Durchmesser Diameter (mm) | 420 |  | 08.150.1001.180 Vergl.Nr. Comp.-No. 3421 601 008 |
| passend für to fit to Mercedes-Benz | | | | |

| Schwungrad Flywheel | | | | |
|------------------------------------------------------------------|------------------------------|-----|--------------------------------------------------------------------------------------|----------------------------------------------------------------------|
| Schwungrad Flywheel | Durchmesser Diameter (mm) | 430 |  | 08.150.1001.190 Vergl.Nr. Comp.-No. 457 030 06 05 |
| passend für to fit to Mercedes-Benz | Zähnezahl Number of Teeth | 160 | | |
| für Modell für Modell AXOR 2 | | | | |
| Schwungrad Flywheel | Durchmesser Diameter (mm) | 360 |  | 08.150.1001.200 Vergl.Nr. Comp.-No. 906 030 32 05 |
| passend für to fit to Mercedes-Benz | | | | |
| für Modell für Modell VARIO | | | | |
| Schwungrad Flywheel | Durchmesser Diameter (mm) | 430 |  | 08.150.3001.400 Vergl.Nr. Comp.-No. 3421 601 019 |
| passend für to fit to SCANIA: Serie 4 | Zähnezahl Number of Teeth | 158 | | |
| Schwungrad Flywheel | Durchmesser Diameter (mm) | 430 |  | 08.150.3001.410 Vergl.Nr. Comp.-No. 324 640 |
| passend für to fit to SCANIA: Bus Serie 3; Serie 4 | Zähnezahl Number of Teeth | 158 | | |
| Schwungrad Flywheel | Durchmesser Diameter (mm) | 430 |  | 08.150.3001.420 Vergl.Nr. Comp.-No. 3421 601 018 |
| passend für to fit to SCANIA: Serie 3 | Zähnezahl Number of Teeth | 163 | | |
| Schwungrad Flywheel | Durchmesser Diameter (mm) | 430 |  | 08.150.3001.430 Vergl.Nr. Comp.-No. 306 993 |
| passend für to fit to SCANIA: Bus Serie 3; Serie 3; Serie 4 | Zähnezahl Number of Teeth | 158 | | |
| Schwungrad Flywheel | Durchmesser Diameter (mm) | 430 |  | 08.150.4250.420 Vergl.Nr. Comp.-No. 5000 663 606 |
| passend für to fit to RENAULT: Manager; Maxter | Zähnezahl Number of Teeth | 148 | | |

Zubehör | Accessories

Schwungrad Flywheel



| Schwungrad Flywheel | | | |
|------------------------------------------------------------|------------------------------|-----|---------------------------------------|
| Schwungrad Flywheel | Durchmesser Diameter (mm) | 430 | 08.150.4250.430 |
| | Zähnezahl Number of Teeth | 148 | |
| passend für to fit to RENAULT: Kerax; Manager; Maxter | | | Vergl.Nr. Comp.-No. 5000 686 610 |
| Schwungrad Flywheel | Durchmesser Diameter (mm) | 430 | 08.150.4250.440 |
| | Zähnezahl Number of Teeth | 148 | |
| passend für to fit to RENAULT: Magnum | | | Vergl.Nr. Comp.-No. 3421 601 023 |

| Sicherungsring Circlip | | | |
|------------------------------------------|------------------------------------------|----|-------------------------------------------------------------------------------------|
| Sicherungsring Circlip | Aussendurchmesser Outer Diameter (mm) | 39 |  |
| | Innendurchmesser Inner Diameter (mm) | 35 | |
| passend für to fit to MERCEDES-BENZ | Dicke/Stärke Thickness (mm) | 2 | Vergl.Nr. Comp.-No. 912009 037200 |

| Zahnkranz, Schwungrad Ring Gear, flywheel | | | |
|---------------------------------------------------------------------------------------------|------------------------------------------|-----|----------------------------------------|
| Zahnkranz, Schwungrad Ring Gear, flywheel | Innendurchmesser Inner Diameter (mm) | 360 | 08.160.S9960000 |
| | Aussendurchmesser Outer Diameter (mm) | 404 | |
| passend für to fit to MERCEDES-BENZ | Dicke/Stärke Thickness (mm) | 16 | Vergl.Nr. Comp.-No. 352 032 13 05 |
| | Zähnezahl Number of Teeth | 132 | |
| Zahnkranz, Schwungrad Ring Gear, flywheel | Innendurchmesser Inner Diameter (mm) | 336 | 08.160.1001.000 |
| | Aussendurchmesser Outer Diameter (mm) | 380 | |
| passend für to fit to Mercedes-Benz | Dicke/Stärke Thickness (mm) | 16 | Vergl.Nr. Comp.-No. 352 032 11 05 |
| für Modell für Modell LK/LN2; LP; NG; O 301; O 302; O 309; O 402; T2/L; T2/LN1; UNIMOG | Zähnezahl Number of Teeth | 125 | |
| Zahnkranz, Schwungrad Ring Gear, flywheel | Innendurchmesser Inner Diameter (mm) | 334 | 08.160.1001.010 |
| | Aussendurchmesser Outer Diameter (mm) | 381 | |
| passend für to fit to Mercedes-Benz | Dicke/Stärke Thickness (mm) | 21 | Vergl.Nr. Comp.-No. 312 032 01 05 |
| | Zähnezahl Number of Teeth | 125 | |

| Zahnkranz, Schwungrad Ring Gear, flywheel | | | | |
|---------------------------------------------------------------------------------------------------------------------------------------------------------------------------------------------------------------------------------------------|---------------------|-----|--------------------------------------------------------------------------------------|----------------------------------------------------------------------|
| Zahnkranz, Schwungrad Ring Gear, flywheel passend für to fit to Mercedes-Benz | Innendurchmesser | 420 |  | 08.160.1001.020 Vergl.Nr. Comp.-No. 315 032 01 05 |
| | Inner Diameter (mm) | | | |
| | Aussendurchmesser | 467 | | |
| | Outer Diameter (mm) | | | |
| | Dicke/Stärke | 22 | | |
| | Thickness (mm) | | | |
| | Zähnezahl | 154 | | |
| | Number of Teeth | | | |
| Zahnkranz, Schwungrad Ring Gear, flywheel passend für to fit to Mercedes-Benz | Innendurchmesser | 335 |  | 08.160.1001.030 Vergl.Nr. Comp.-No. 352 032 01 05 |
| | Inner Diameter (mm) | | | |
| | Aussendurchmesser | 380 | | |
| | Outer Diameter (mm) | | | |
| | Dicke/Stärke | 16 | | |
| | Thickness (mm) | | | |
| | Zähnezahl | 125 | | |
| | Number of Teeth | | | |
| Zahnkranz, Schwungrad Ring Gear, flywheel passend für to fit to Mercedes-Benz für Modell für Modell ACTROS; ACTROS MP2; MK; NG; O 303; O 305; O 307; O 340; O 404; O 405; O 407; O 408; SK; TOURISMO O 350 | Innendurchmesser | 430 |  | 08.160.1001.040 Vergl.Nr. Comp.-No. 403 032 04 05 |
| | Inner Diameter (mm) | | | |
| | Aussendurchmesser | 484 | | |
| | Outer Diameter (mm) | | | |
| | Dicke/Stärke | 19 | | |
| | Thickness (mm) | | | |
| | Zähnezahl | 160 | | |
| | Number of Teeth | | | |
| Zahnkranz, Schwungrad Ring Gear, flywheel passend für to fit to SCANIA | Innendurchmesser | 446 |  | 08.160.3001.480 Vergl.Nr. Comp.-No. 170 069 |
| | Inner Diameter (mm) | | | |
| | Aussendurchmesser | 495 | | |
| | Outer Diameter (mm) | | | |
| | Zähnezahl | 163 | | |
| | Number of Teeth | | | |
| Zahnkranz, Schwungrad Ring Gear, flywheel passend für to fit to VOLVO | Innendurchmesser | 440 |  | 08.160.4004.510 Vergl.Nr. Comp.-No. 0420 794 |
| | Inner Diameter (mm) | | | |
| | Aussendurchmesser | 473 | | |
| | Outer Diameter (mm) | | | |
| | Zähnezahl | 156 | | |
| | Number of Teeth | | | |
| Zahnkranz, Schwungrad Ring Gear, flywheel passend für to fit to VOLVO | Innendurchmesser | 449 |  | 08.160.4004.520 Vergl.Nr. Comp.-No. 8193 939 |
| | Inner Diameter (mm) | | | |
| | Aussendurchmesser | 492 | | |
| | Outer Diameter (mm) | | | |
| | Dicke/Stärke | 17 | | |
| | Thickness (mm) | | | |
| | Zähnezahl | 183 | | |
| | Number of Teeth | | | |

Zubehör | Accessories

Zahnkranz, Schwungrad

Ring Gear, flywheel



Zahnkranz, Schwungrad | Ring Gear, flywheel

| | | | |
|-------------------------|---------------------|-----|------------------------|
| Zahnkranz, Schwungrad | Innendurchmesser | 429 | 08.160.4250.450 |
| Ring Gear, flywheel | Inner Diameter (mm) | | |
| | Aussendurchmesser | 475 | |
| | Outer Diameter (mm) | | |
| passend für to fit to | Zähnezahl | 148 | Vergl.Nr. Comp.-No. |
| RENAULT | Number of Teeth | | 0000141306 |

aufsteigend nach ST-Nr. | ascending to ST-No.

| | | | | | |
|------------------------|---------------|-------|------------------------|---------------|-------|
| 08.150.0812.010 | 0469 9030 | 67 | 08.150.1001.090 | 51.02301.3220 | 69 |
| 08.150.0812.010 | 0479 2154 | 67 | 08.150.1001.100 | 3421 601 016 | 69 |
| 08.150.0812.010 | 3421 601 022 | 67 | 08.150.1001.100 | 541 030 01 05 | 69 |
| 08.150.0912.020 | 3421 601 013 | 67;68 | 08.150.1001.110 | 3421 601 012 | 69 |
| 08.150.0912.020 | 51.02301.7410 | 67;68 | 08.150.1001.110 | 442 030 05 05 | 69 |
| 08.150.0912.060 | 3421 601 047 | 68 | 08.150.1001.110 | 442 030 10 05 | 69 |
| 08.150.0912.060 | 51.02301.5154 | 68 | 08.150.1001.110 | 442 030 19 05 | 69 |
| 08.150.0912.060 | 51.02301.5155 | 68 | 08.150.1001.120 | 3421 601 002 | 69 |
| 08.150.0912.060 | 51.02301.5191 | 68 | 08.150.1001.120 | 352 030 73 05 | 69 |
| 08.150.0912.060 | 51.02301.6032 | 68 | 08.150.1001.130 | 3421 601 003 | 69;70 |
| 08.150.0912.060 | 51.02301.6033 | 68 | 08.150.1001.130 | 352 030 39 05 | 69;70 |
| 08.150.0912.070 | 3421 601 014 | 68 | 08.150.1001.140 | 3421 601 004 | 70 |
| 08.150.0912.070 | 51.02301.7439 | 68 | 08.150.1001.140 | 364 030 01 05 | 70 |
| 08.150.1001.050 | 3421 601 009 | 68 | 08.150.1001.150 | 327 030 02 11 | 70 |
| 08.150.1001.050 | 403 030 13 05 | 68 | 08.150.1001.150 | 3421 601 006 | 70 |
| 08.150.1001.050 | 403 030 16 05 | 68 | 08.150.1001.150 | 360 030 08 11 | 70 |
| 08.150.1001.050 | 51.02301.7290 | 68 | 08.150.1001.160 | 3421 601 007 | 70 |
| 08.150.1001.050 | 51.02301.7295 | 68 | 08.150.1001.160 | 366 030 09 05 | 70 |
| 08.150.1001.050 | 51.02301.7325 | 68 | 08.150.1001.170 | 3421 601 001 | 70 |
| 08.150.1001.060 | 3421 601 010 | 68 | 08.150.1001.170 | 355 030 09 05 | 70 |
| 08.150.1001.060 | 403 030 08 05 | 68 | 08.150.1001.170 | 355 030 13 05 | 70 |
| 08.150.1001.060 | 403 030 14 05 | 68 | 08.150.1001.170 | 355 030 14 05 | 70 |
| 08.150.1001.060 | 447 030 18 05 | 68 | 08.150.1001.180 | 3421 601 008 | 70 |
| 08.150.1001.060 | 51.02301.0307 | 68 | 08.150.1001.180 | 345 030 02 05 | 70 |
| 08.150.1001.060 | 51.02301.7293 | 68 | 08.150.1001.190 | 457 030 06 05 | 70;71 |
| 08.150.1001.060 | 51.02301.7300 | 68 | 08.150.1001.200 | 906 030 32 05 | 71 |
| 08.150.1001.060 | 51.02301.7307 | 68 | 08.150.1001.200 | 906 030 38 05 | 71 |
| 08.150.1001.060 | 51.02301.7326 | 68 | 08.150.3001.400 | 1 388 326 | 71 |
| 08.150.1001.060 | 51.02301.7333 | 68 | 08.150.3001.400 | 1 453 281 | 71 |
| 08.150.1001.060 | 51.02301.7335 | 68 | 08.150.3001.400 | 1 465 411 | 71 |
| 08.150.1001.070 | 3421 601 013 | 68 | 08.150.3001.400 | 1 487 557 | 71 |
| 08.150.1001.070 | 441 030 04 05 | 68 | 08.150.3001.400 | 3421 601 019 | 71 |
| 08.150.1001.080 | 3421 601 011 | 68;69 | 08.150.3001.410 | 324 640 | 71 |
| 08.150.1001.080 | 442 030 02 05 | 68;69 | 08.150.3001.410 | 3421 601 020 | 71 |
| 08.150.1001.080 | 51.02301.5034 | 68;69 | 08.150.3001.420 | 324 642 | 71 |
| 08.150.1001.080 | 51.02301.5068 | 68;69 | 08.150.3001.420 | 3421 601 018 | 71 |
| 08.150.1001.080 | 51.02301.7387 | 68;69 | 08.150.3001.430 | 306 993 | 71 |
| 08.150.1001.080 | 51.02301.7411 | 68;69 | 08.150.3001.430 | 3421 601 024 | 71 |
| 08.150.1001.080 | 51.02301.7414 | 68;69 | 08.150.3001.430 | 393 151 | 71 |
| 08.150.1001.090 | 3421 601 017 | 69 | 08.150.4250.420 | 5000 663 606 | 71 |
| 08.150.1001.090 | 422 030 05 05 | 69 | 08.150.4250.420 | 5000663606 | 71 |
| 08.150.1001.090 | 422 032 00 01 | 69 | 08.150.4250.430 | 5000 686 610 | 71;72 |

Vergleichsliste | Crosslist

aufsteigend nach ST-Nr. | ascending to ST-No.

| | | | | | |
|------------------------|---------------|---------|------------------------|---------------|---------|
| 08.150.4250.430 | 5000686610 | 71;72 | 08.270.1000.500 | 016 250 44 03 | 8;23;37 |
| 08.150.4250.440 | 3421 601 023 | 72 | 08.270.1000.500 | 018 250 93 03 | 8;23;37 |
| 08.150.4250.440 | 5000 666 395 | 72 | 08.270.1000.500 | 019 250 08 03 | 8;23;37 |
| 08.150.4250.440 | 5000666395 | 72 | 08.270.1000.500 | 019 250 68 03 | 8;23;37 |
| 08.160.S9960000 | 352 032 13 05 | 72 | 08.270.1000.500 | 11009992 | 8;23;37 |
| 08.160.1001.000 | 352 032 11 05 | 72 | 08.270.1000.500 | 11079828 | 8;23;37 |
| 08.160.1001.010 | 312 032 01 05 | 72 | 08.270.1000.500 | 1440 715 | 8;23;37 |
| 08.160.1001.010 | 314 032 05 05 | 72 | 08.270.1000.500 | 1614 294 | 8;23;37 |
| 08.160.1001.020 | 315 032 01 05 | 72;73 | 08.270.1000.500 | 1689 145 | 8;23;37 |
| 08.160.1001.030 | 352 032 01 05 | 73 | 08.270.1000.500 | 1862 188 032 | 8;23;37 |
| 08.160.1001.030 | 352 032 06 05 | 73 | 08.270.1000.500 | 1862 215 032 | 8;23;37 |
| 08.160.1001.040 | 403 032 00 05 | 73 | 08.270.1000.500 | 1862 519 243 | 8;23;37 |
| 08.160.1001.040 | 403 032 02 05 | 73 | 08.270.1000.500 | 1862 519 259 | 8;23;37 |
| 08.160.1001.040 | 403 032 03 05 | 73 | 08.270.1000.500 | 1878 002 791 | 8;23;37 |
| 08.160.1001.040 | 403 032 04 05 | 73 | 08.270.1000.500 | 1878 037 858 | 8;23;37 |
| 08.160.1001.040 | 403 032 05 05 | 73 | 08.270.1000.500 | 1878 065 531 | 8;23;37 |
| 08.160.1001.040 | 51.02310.0071 | 73 | 08.270.1000.500 | 1878 080 037 | 8;23;37 |
| 08.160.1001.040 | 51.02310.0073 | 73 | 08.270.1000.500 | 193852 | 8;23;37 |
| 08.160.1001.040 | 51.02310.0096 | 73 | 08.270.1000.500 | 270574 | 8;23;37 |
| 08.160.1001.040 | 51.02310.0097 | 73 | 08.270.1000.500 | 276261 | 8;23;37 |
| 08.160.3001.480 | 1 465 410 | 73 | 08.270.1000.500 | 31250-6480A | 8;23;37 |
| 08.160.3001.480 | 1 487 567 | 73 | 08.270.1000.500 | 500397756 | 8;23;37 |
| 08.160.3001.480 | 170 069 | 73 | 08.270.1000.500 | 632 101 660 | 8;23;37 |
| 08.160.4004.510 | 0420 794 | 73 | 08.270.1000.500 | 81.30301.0325 | 8;23;37 |
| 08.160.4004.520 | 8193 939 | 73 | 08.270.1000.500 | 81.30301.0460 | 8;23;37 |
| 08.160.4250.450 | 0000141306 | 73;74 | 08.270.1000.500 | 81.30301.0503 | 8;23;37 |
| 08.270.1000.500 | 007 250 58 03 | 8;23;37 | 08.270.1000.500 | 81.30301.0506 | 8;23;37 |
| 08.270.1000.500 | 007 250 59 03 | 8;23;37 | 08.270.1000.500 | 81.30301.0507 | 8;23;37 |
| 08.270.1000.500 | 009 250 21 03 | 8;23;37 | 08.270.1000.500 | 81.30301.0511 | 8;23;37 |
| 08.270.1000.500 | 009 250 31 03 | 8;23;37 | 08.270.1000.500 | 81.30301.0545 | 8;23;37 |
| 08.270.1000.500 | 011 250 06 03 | 8;23;37 | 08.270.1000.500 | 81.30301.0546 | 8;23;37 |
| 08.270.1000.500 | 012 250 14 03 | 8;23;37 | 08.270.1000.500 | 81.30301.0547 | 8;23;37 |
| 08.270.1000.500 | 012 250 15 03 | 8;23;37 | 08.270.1000.500 | 81.30301.0549 | 8;23;37 |
| 08.270.1000.500 | 013 250 20 03 | 8;23;37 | 08.270.1000.500 | 81.30301.0559 | 8;23;37 |
| 08.270.1000.500 | 013 250 21 03 | 8;23;37 | 08.270.1000.500 | 81.30301.9506 | 8;23;37 |
| 08.270.1000.500 | 013 250 30 03 | 8;23;37 | 08.270.1000.500 | 81.30301.9547 | 8;23;37 |
| 08.270.1000.500 | 013 250 39 03 | 8;23;37 | 08.270.1000.500 | 81.30301.9549 | 8;23;37 |
| 08.270.1000.500 | 015 250 02 03 | 8;23;37 | 08.270.1000.500 | 8.383.286.000 | 8;23;37 |
| 08.270.1000.500 | 015 250 23 03 | 8;23;37 | 08.270.1000.503 | 0190 4796 | 13 |
| 08.270.1000.500 | 016 250 17 03 | 8;23;37 | 08.270.1000.503 | 123165 | 13 |
| 08.270.1000.500 | 016 250 18 03 | 8;23;37 | 08.270.1000.503 | 1862 390 031 | 13 |
| 08.270.1000.500 | 016 250 43 03 | 8;23;37 | 08.270.1000.503 | 1878 032 032 | 13 |

aufsteigend nach ST-Nr. | ascending to ST-No.

| | | | | | |
|------------------------|---------------|---------|------------------------|---------------|-------------------|
| 08.270.1000.503 | 4211 4448 | 13 | 08.270.1000.520 | 165 497 | 7;35;48 |
| 08.270.1000.503 | 5003 17871 | 13 | 08.270.1000.520 | 1861 460 104 | 7;35;48 |
| 08.270.1000.503 | 5003 92868 | 13 | 08.270.1000.520 | 1861 460 136 | 7;35;48 |
| 08.270.1000.503 | 5003 92872 | 13 | 08.270.1000.520 | 1861 460 137 | 7;35;48 |
| 08.270.1000.503 | 5006000573 | 13 | 08.270.1000.520 | 1861 460 138 | 7;35;48 |
| 08.270.1000.503 | 5006017501 | 13 | 08.270.1000.520 | 1861 494 133 | 7;35;48 |
| 08.270.1000.503 | 5010 556 021 | 13 | 08.270.1000.520 | 1861 494 140 | 7;35;48 |
| 08.270.1000.503 | 5010 556 174 | 13 | 08.270.1000.520 | 1861 494 145 | 7;35;48 |
| 08.270.1000.503 | 5031 7871 | 13 | 08.270.1000.520 | 1861 494 146 | 7;35;48 |
| 08.270.1000.503 | 9843 6139 | 13 | 08.270.1000.520 | 1861 494 149 | 7;35;48 |
| 08.270.1000.503 | 9843 6141 | 13 | 08.270.1000.520 | 1861 599 132 | 7;35;48 |
| 08.270.1000.503 | 9849 9256 | 13 | 08.270.1000.520 | 1861 599 232 | 7;35;48 |
| 08.270.1000.503 | 9943 0265 | 13 | 08.270.1000.520 | 1861 912 032 | 7;35;48 |
| 08.270.1000.513 | 1668 929 | 61 | 08.270.1000.520 | 1861 912 034 | 7;35;48 |
| 08.270.1000.513 | 1862 382 031 | 61 | 08.270.1000.520 | 1861 912 035 | 7;35;48 |
| 08.270.1000.513 | 1878 003 779 | 61 | 08.270.1000.520 | 1862 296 031 | 7;35;48 |
| 08.270.1000.513 | 3192 845 | 61 | 08.270.1000.520 | 1878 000 105 | 7;35;48 |
| 08.270.1000.513 | 8112 662 | 61 | 08.270.1000.520 | 20276 | 7;35;48 |
| 08.270.1000.513 | 85 001 033 | 61 | 08.270.1000.520 | 376 490 | 7;35;48 |
| 08.270.1000.520 | 002 250 97 03 | 7;35;48 | 08.270.1000.520 | 5000 559 741 | 7;35;48 |
| 08.270.1000.520 | 002 250 98 03 | 7;35;48 | 08.270.1000.520 | 5030-105 | 7;35;48 |
| 08.270.1000.520 | 003 250 06 03 | 7;35;48 | 08.270.1000.520 | 5031-335 | 7;35;48 |
| 08.270.1000.520 | 003 250 09 03 | 7;35;48 | 08.270.1000.520 | 503133508 | 7;35;48 |
| 08.270.1000.520 | 003 250 74 03 | 7;35;48 | 08.270.1000.520 | 558 111 | 7;35;48 |
| 08.270.1000.520 | 005 250 43 03 | 7;35;48 | 08.270.1000.520 | 661 066 | 7;35;48 |
| 08.270.1000.520 | 005 250 57 03 | 7;35;48 | 08.270.1000.520 | 740 789 | 7;35;48 |
| 08.270.1000.520 | 005 250 64 03 | 7;35;48 | 08.270.1000.520 | 740 790 | 7;35;48 |
| 08.270.1000.520 | 006 250 45 03 | 7;35;48 | 08.270.1000.520 | 751 952 | 7;35;48 |
| 08.270.1000.520 | 006 250 46 03 | 7;35;48 | 08.270.1000.520 | 81.30301.0134 | 7;35;48 |
| 08.270.1000.520 | 006 250 90 03 | 7;35;48 | 08.270.1000.523 | 1878 000 634 | 50;62 |
| 08.270.1000.520 | 007 250 08 03 | 7;35;48 | 08.270.1000.523 | 3191 766 | 50;62 |
| 08.270.1000.520 | 007 250 09 03 | 7;35;48 | 08.270.1000.523 | 7420 707 024 | 50;62 |
| 08.270.1000.520 | 007 250 10 03 | 7;35;48 | 08.270.1000.523 | 8171 426 | 50;62 |
| 08.270.1000.520 | 010 250 00 03 | 7;35;48 | 08.270.1000.523 | 8172 802 | 50;62 |
| 08.270.1000.520 | 011 250 00 03 | 7;35;48 | 08.270.1000.523 | 85 000 239 | 50;62 |
| 08.270.1000.520 | 011 250 01 03 | 7;35;48 | 08.270.1000.523 | 85 000 241 | 50;62 |
| 08.270.1000.520 | 011 250 02 03 | 7;35;48 | 08.270.1000.523 | 85 000 277 | 50;62 |
| 08.270.1000.520 | 012 250 69 03 | 7;35;48 | 08.270.1000.530 | 000 250 92 03 | 13;21;22;35;48;49 |
| 08.270.1000.520 | 01.23.122 | 7;35;48 | 08.270.1000.530 | 001 250 55 03 | 13;21;22;35;48;49 |
| 08.270.1000.520 | 1331 326 | 7;35;48 | 08.270.1000.530 | 001 250 58 03 | 13;21;22;35;48;49 |
| 08.270.1000.520 | 1347 696 | 7;35;48 | 08.270.1000.530 | 001 250 67 03 | 13;21;22;35;48;49 |
| 08.270.1000.520 | 1395 699 | 7;35;48 | 08.270.1000.530 | 001 250 83 03 | 13;21;22;35;48;49 |

Vergleichsliste | Crosslist

aufsteigend nach ST-Nr. | ascending to ST-No.

| | | | | | |
|------------------------|---------------|-------------------|------------------------|---------------|------------|
| 08.270.1000.530 | 002 250 05 03 | 13;21;22;35;48;49 | 08.270.1000.533 | 0190 4716 | 13;21 |
| 08.270.1000.530 | 0023 618 037 | 13;21;22;35;48;49 | 08.270.1000.533 | 0190 4717 | 13;21 |
| 08.270.1000.530 | 0023 818 037 | 13;21;22;35;48;49 | 08.270.1000.533 | 0247 7136 | 13;21 |
| 08.270.1000.530 | 003 250 51 03 | 13;21;22;35;48;49 | 08.270.1000.533 | 0247 7926 | 13;21 |
| 08.270.1000.530 | 007 250 38 03 | 13;21;22;35;48;49 | 08.270.1000.533 | 0247 7929 | 13;21 |
| 08.270.1000.530 | 0127 1999 | 13;21;22;35;48;49 | 08.270.1000.533 | 0421.330.00 | 13;21 |
| 08.270.1000.530 | 0127 8624 | 13;21;22;35;48;49 | 08.270.1000.533 | 0469 5661 | 13;21 |
| 08.270.1000.530 | 0190 3873 | 13;21;22;35;48;49 | 08.270.1000.533 | 0476 6075 | 13;21 |
| 08.270.1000.530 | 0190 3956 | 13;21;22;35;48;49 | 08.270.1000.533 | 0476 9116 | 13;21 |
| 08.270.1000.530 | 0244 2557 | 13;21;22;35;48;49 | 08.270.1000.533 | 0483 9133 | 13;21 |
| 08.270.1000.530 | 0244 2558 | 13;21;22;35;48;49 | 08.270.1000.533 | 0485 7270 | 13;21 |
| 08.270.1000.530 | 0247 7930 | 13;21;22;35;48;49 | 08.270.1000.533 | 1.068.414 | 13;21 |
| 08.270.1000.530 | 0401.149.00 | 13;21;22;35;48;49 | 08.270.1000.533 | 122 222 | 13;21 |
| 08.270.1000.530 | 0890-374 | 13;21;22;35;48;49 | 08.270.1000.533 | 1861 861 032 | 13;21 |
| 08.270.1000.530 | 1861 219 108 | 13;21;22;35;48;49 | 08.270.1000.533 | 1862 235 031 | 13;21 |
| 08.270.1000.530 | 1861 219 139 | 13;21;22;35;48;49 | 08.270.1000.533 | 1878 000 957 | 13;21 |
| 08.270.1000.530 | 1861 219 142 | 13;21;22;35;48;49 | 08.270.1000.533 | 4201 4718 | 13;21 |
| 08.270.1000.530 | 1861 219 150 | 13;21;22;35;48;49 | 08.270.1000.533 | 469 5661 | 13;21 |
| 08.270.1000.530 | 1861 219 157 | 13;21;22;35;48;49 | 08.270.1000.533 | 81.30301.0283 | 13;21 |
| 08.270.1000.530 | 1861 321 135 | 13;21;22;35;48;49 | 08.270.1000.533 | 81.30301.0284 | 13;21 |
| 08.270.1000.530 | 1861 321 139 | 13;21;22;35;48;49 | 08.270.1000.533 | 81.30301.0285 | 13;21 |
| 08.270.1000.530 | 1878 000 104 | 13;21;22;35;48;49 | 08.270.1000.533 | 81.30301.9284 | 13;21 |
| 08.270.1000.530 | 211 00 338 | 13;21;22;35;48;49 | 08.270.1000.540 | 003 250 56 03 | 7;12;34;42 |
| 08.270.1000.530 | 317 250 04 03 | 13;21;22;35;48;49 | 08.270.1000.540 | 003 250 62 03 | 7;12;34;42 |
| 08.270.1000.530 | 344 250 72 03 | 13;21;22;35;48;49 | 08.270.1000.540 | 004 250 73 03 | 7;12;34;42 |
| 08.270.1000.530 | 4210 2163 | 13;21;22;35;48;49 | 08.270.1000.540 | 005 250 39 03 | 7;12;34;42 |
| 08.270.1000.530 | 5000 789 351 | 13;21;22;35;48;49 | 08.270.1000.540 | 005 250 40 03 | 7;12;34;42 |
| 08.270.1000.530 | 5000 821 820 | 13;21;22;35;48;49 | 08.270.1000.540 | 007 250 30 03 | 7;12;34;42 |
| 08.270.1000.530 | 5031-317 | 13;21;22;35;48;49 | 08.270.1000.540 | 007 250 74 03 | 7;12;34;42 |
| 08.270.1000.530 | 8000 243 160 | 13;21;22;35;48;49 | 08.270.1000.540 | 01.23.104 | 7;12;34;42 |
| 08.270.1000.530 | 81.30301.0088 | 13;21;22;35;48;49 | 08.270.1000.540 | 018 250 37 03 | 7;12;34;42 |
| 08.270.1000.530 | 81.30301.0155 | 13;21;22;35;48;49 | 08.270.1000.540 | 0190 3854 | 7;12;34;42 |
| 08.270.1000.533 | 0126 1902 | 13;21 | 08.270.1000.540 | 0190 3860 | 7;12;34;42 |
| 08.270.1000.533 | 0190 3816 | 13;21 | 08.270.1000.540 | 0190 3953 | 7;12;34;42 |
| 08.270.1000.533 | 0190 3872 | 13;21 | 08.270.1000.540 | 0190 3954 | 7;12;34;42 |
| 08.270.1000.533 | 0190 3874 | 13;21 | 08.270.1000.540 | 0401.113.01 | 7;12;34;42 |
| 08.270.1000.533 | 0190 3877 | 13;21 | 08.270.1000.540 | 096 001 | 7;12;34;42 |
| 08.270.1000.533 | 0190 3900 | 13;21 | 08.270.1000.540 | 100127 | 7;12;34;42 |
| 08.270.1000.533 | 0190 3925 | 13;21 | 08.270.1000.540 | 106-8888 | 7;12;34;42 |
| 08.270.1000.533 | 0190 4713 | 13;21 | 08.270.1000.540 | 112590 | 7;12;34;42 |
| 08.270.1000.533 | 0190 4714 | 13;21 | 08.270.1000.540 | 1348 146R | 7;12;34;42 |
| 08.270.1000.533 | 0190 4715 | 13;21 | 08.270.1000.540 | 1861 274 235 | 7;12;34;42 |

aufsteigend nach ST-Nr. | ascending to ST-No.

| | | | | | |
|------------------------|---------------|------------|------------------------|---------------|-----------|
| 08.270.1000.540 | 1861 274 238 | 7;12;34;42 | 08.270.1000.553 | 0190 3884 | 7;8;49;55 |
| 08.270.1000.540 | 1861 325 106 | 7;12;34;42 | 08.270.1000.553 | 0190 3887 | 7;8;49;55 |
| 08.270.1000.540 | 1861 325 141 | 7;12;34;42 | 08.270.1000.553 | 0190 3936 | 7;8;49;55 |
| 08.270.1000.540 | 1861 531 032 | 7;12;34;42 | 08.270.1000.553 | 0190 3937 | 7;8;49;55 |
| 08.270.1000.540 | 1861 787 031 | 7;12;34;42 | 08.270.1000.553 | 0190 3938 | 7;8;49;55 |
| 08.270.1000.540 | 1861 787 034 | 7;12;34;42 | 08.270.1000.553 | 0190 3939 | 7;8;49;55 |
| 08.270.1000.540 | 1878 001 070 | 7;12;34;42 | 08.270.1000.553 | 0190 3940 | 7;8;49;55 |
| 08.270.1000.540 | 20275 | 7;12;34;42 | 08.270.1000.553 | 0190 3941 | 7;8;49;55 |
| 08.270.1000.540 | 252 683 | 7;12;34;42 | 08.270.1000.553 | 0469 9161 | 7;8;49;55 |
| 08.270.1000.540 | 373 895 | 7;12;34;42 | 08.270.1000.553 | 0473 8961 | 7;8;49;55 |
| 08.270.1000.540 | 4210 2155 | 7;12;34;42 | 08.270.1000.553 | 0473 9151 | 7;8;49;55 |
| 08.270.1000.540 | 503134208 | 7;12;34;42 | 08.270.1000.553 | 0474 1464 | 7;8;49;55 |
| 08.270.1000.540 | 5179629 | 7;12;34;42 | 08.270.1000.553 | 0483 7884 | 7;8;49;55 |
| 08.270.1000.540 | 623 212 | 7;12;34;42 | 08.270.1000.553 | 096 006 | 7;8;49;55 |
| 08.270.1000.540 | 740 794 | 7;12;34;42 | 08.270.1000.553 | 165 495 | 7;8;49;55 |
| 08.270.1000.540 | 8.383.276.000 | 7;12;34;42 | 08.270.1000.553 | 165499 | 7;8;49;55 |
| 08.270.1000.543 | 1526 047 | 60 | 08.270.1000.553 | 1861 206 112 | 7;8;49;55 |
| 08.270.1000.543 | 1527 524 | 60 | 08.270.1000.553 | 1861 206 212 | 7;8;49;55 |
| 08.270.1000.543 | 1655 649 | 60 | 08.270.1000.553 | 1861 206 213 | 7;8;49;55 |
| 08.270.1000.543 | 1668 373 | 60 | 08.270.1000.553 | 1861 206 242 | 7;8;49;55 |
| 08.270.1000.543 | 1861 380 137 | 60 | 08.270.1000.553 | 1861 592 332 | 7;8;49;55 |
| 08.270.1000.543 | 1861 380 339 | 60 | 08.270.1000.553 | 1861 592 333 | 7;8;49;55 |
| 08.270.1000.543 | 1861 640 031 | 60 | 08.270.1000.553 | 1878 001 138 | 7;8;49;55 |
| 08.270.1000.543 | 1861 640 135 | 60 | 08.270.1000.553 | 190 326 | 7;8;49;55 |
| 08.270.1000.543 | 1878 001 080 | 60 | 08.270.1000.553 | 4206 2613 | 7;8;49;55 |
| 08.270.1000.543 | 267 237 | 60 | 08.270.1000.553 | 4210 2413 | 7;8;49;55 |
| 08.270.1000.543 | 5002 243 | 60 | 08.270.1000.553 | 4211 4181 | 7;8;49;55 |
| 08.270.1000.543 | 5100 007 | 60 | 08.270.1000.553 | 6 490 375 | 7;8;49;55 |
| 08.270.1000.543 | 8112 109 | 60 | 08.270.1000.553 | 632 100 110 | 7;8;49;55 |
| 08.270.1000.550 | 003 250 84 03 | 34;42 | 08.270.1000.560 | 001 250 59 03 | 34;42 |
| 08.270.1000.550 | 005 250 53 03 | 34;42 | 08.270.1000.560 | 002 250 04 03 | 34;42 |
| 08.270.1000.550 | 005 250 55 03 | 34;42 | 08.270.1000.560 | 002 250 34 03 | 34;42 |
| 08.270.1000.550 | 007 250 28 03 | 34;42 | 08.270.1000.560 | 003 250 86 03 | 34;42 |
| 08.270.1000.550 | 007 250 29 03 | 34;42 | 08.270.1000.560 | 005 250 06 03 | 34;42 |
| 08.270.1000.550 | 007 250 72 03 | 34;42 | 08.270.1000.560 | 009 250 12 03 | 34;42 |
| 08.270.1000.550 | 011 250 74 03 | 34;42 | 08.270.1000.560 | 009 250 13 03 | 34;42 |
| 08.270.1000.550 | 01.23.118 | 34;42 | 08.270.1000.560 | 01.23.100 | 34;42 |
| 08.270.1000.550 | 1861 571 131 | 34;42 | 08.270.1000.560 | 0401.20264 | 34;42 |
| 08.270.1000.550 | 1861 571 136 | 34;42 | 08.270.1000.560 | 1861 303 209 | 34;42 |
| 08.270.1000.550 | 1861 571 236 | 34;42 | 08.270.1000.560 | 1861 303 216 | 34;42 |
| 08.270.1000.553 | 0001 141 034 | 7;8;49;55 | 08.270.1000.560 | 1861 303 232 | 34;42 |
| 08.270.1000.553 | 0165 495 | 7;8;49;55 | 08.270.1000.560 | 1861 303 246 | 34;42 |

Vergleichsliste | Crosslist

aufsteigend nach ST-Nr. | ascending to ST-No.

| | | | | | |
|------------------------|---------------|----------|------------------------|---------------|------------|
| 08.270.1000.560 | 345 250 74 03 | 34;42 | 08.270.1000.570 | 01.23.138 | 34 |
| 08.270.1000.563 | 005 250 19 03 | 21;34;48 | 08.270.1000.570 | 013 250 54 03 | 34 |
| 08.270.1000.563 | 005 250 24 03 | 21;34;48 | 08.270.1000.570 | 013 250 89 03 | 34 |
| 08.270.1000.563 | 006 250 83 03 | 21;34;48 | 08.270.1000.570 | 1861 174 033 | 34 |
| 08.270.1000.563 | 006 250 84 03 | 21;34;48 | 08.270.1000.570 | 1861 174 034 | 34 |
| 08.270.1000.563 | 008 250 08 03 | 21;34;48 | 08.270.1000.570 | 1861 174 134 | 34 |
| 08.270.1000.563 | 008 250 46 03 | 21;34;48 | 08.270.1000.570 | 1861 254 007 | 34 |
| 08.270.1000.563 | 011 250 81 03 | 21;34;48 | 08.270.1000.570 | 1861 254 034 | 34 |
| 08.270.1000.563 | 1861 498 231 | 21;34;48 | 08.270.1000.570 | 1861 254 037 | 34 |
| 08.270.1000.563 | 1861 498 234 | 21;34;48 | 08.270.1000.570 | 1861 919 034 | 34 |
| 08.270.1000.563 | 1861 498 235 | 21;34;48 | 08.270.1000.570 | 1861 919 035 | 34 |
| 08.270.1000.563 | 1861 714 131 | 21;34;48 | 08.270.1000.570 | 1861 919 134 | 34 |
| 08.270.1000.563 | 1861 714 132 | 21;34;48 | 08.270.1000.570 | 1861 919 139 | 34 |
| 08.270.1000.563 | 1861 714 133 | 21;34;48 | 08.270.1000.570 | 3544 33A1 | 34 |
| 08.270.1000.563 | 1861 962 031 | 21;34;48 | 08.270.1000.573 | 1862 491 031 | 21;48 |
| 08.270.1000.563 | 1861 962 033 | 21;34;48 | 08.270.1000.573 | 1878 001 145 | 21;48 |
| 08.270.1000.563 | 1878 001 144 | 21;34;48 | 08.270.1000.573 | 1898 917 329 | 21;48 |
| 08.270.1000.563 | 5000 295 069 | 21;34;48 | 08.270.1000.573 | 5010 244 077 | 21;48 |
| 08.270.1000.563 | 5001 001 621 | 21;34;48 | 08.270.1000.573 | 5010 244 242 | 21;48 |
| 08.270.1000.563 | 5800 207 047 | 21;34;48 | 08.270.1000.573 | 5010 452 572 | 21;48 |
| 08.270.1000.563 | 81.30000.6336 | 21;34;48 | 08.270.1000.573 | 81.30301.0375 | 21;48 |
| 08.270.1000.563 | 81.30301.0111 | 21;34;48 | 08.270.1000.573 | 81.30301.0461 | 21;48 |
| 08.270.1000.563 | 81.30301.0128 | 21;34;48 | 08.270.1000.580 | 000 250 63 03 | 34 |
| 08.270.1000.563 | 81.30301.0152 | 21;34;48 | 08.270.1000.580 | 001 250 06 03 | 34 |
| 08.270.1000.563 | 81.30301.0247 | 21;34;48 | 08.270.1000.580 | 002 250 35 03 | 34 |
| 08.270.1000.563 | 81.30301.0293 | 21;34;48 | 08.270.1000.580 | 002 250 74 03 | 34 |
| 08.270.1000.563 | 81.30301.9111 | 21;34;48 | 08.270.1000.580 | 007 250 21 03 | 34 |
| 08.270.1000.563 | 81.30301.9152 | 21;34;48 | 08.270.1000.580 | 01.23.114 | 34 |
| 08.270.1000.563 | 81.30301.9247 | 21;34;48 | 08.270.1000.580 | 014 250 94 03 | 34 |
| 08.270.1000.570 | 000 250 05 03 | 34 | 08.270.1000.580 | 0890-359 | 34 |
| 08.270.1000.570 | 000 250 33 03 | 34 | 08.270.1000.580 | 1861 291 006 | 34 |
| 08.270.1000.570 | 000 250 35 03 | 34 | 08.270.1000.580 | 1861 291 033 | 34 |
| 08.270.1000.570 | 001 250 05 03 | 34 | 08.270.1000.580 | 1861 291 036 | 34 |
| 08.270.1000.570 | 001 250 36 03 | 34 | 08.270.1000.580 | 1861 291 136 | 34 |
| 08.270.1000.570 | 001 250 40 03 | 34 | 08.270.1000.580 | 1861 291 251 | 34 |
| 08.270.1000.570 | 004 250 66 03 | 34 | 08.270.1000.583 | 006 250 47 03 | 7;12;13;21 |
| 08.270.1000.570 | 005 250 94 03 | 34 | 08.270.1000.583 | 012 250 02 03 | 7;12;13;21 |
| 08.270.1000.570 | 005 250 95 03 | 34 | 08.270.1000.583 | 012 250 03 03 | 7;12;13;21 |
| 08.270.1000.570 | 007 250 18 03 | 34 | 08.270.1000.583 | 012 250 04 03 | 7;12;13;21 |
| 08.270.1000.570 | 008 250 22 03 | 34 | 08.270.1000.583 | 01.23.134 | 7;12;13;21 |
| 08.270.1000.570 | 008 250 23 03 | 34 | 08.270.1000.583 | 0190 3871 | 7;12;13;21 |
| 08.270.1000.570 | 010 250 85 03 | 34 | 08.270.1000.583 | 0190 3876 | 7;12;13;21 |

aufsteigend nach ST-Nr. | ascending to ST-No.

| | | | | | |
|------------------------|----------------|------------|------------------------|-----------------|----------|
| 08.270.1000.583 | 0190 3946 | 7;12;13;21 | 08.270.1000.590 | 000250202000-00 | 36;43;49 |
| 08.270.1000.583 | 0190 3947 | 7;12;13;21 | 08.270.1000.590 | 002 250 99 03 | 36;43;49 |
| 08.270.1000.583 | 0247 8592 | 7;12;13;21 | 08.270.1000.590 | 003 250 00 03 | 36;43;49 |
| 08.270.1000.583 | 0421.316.00 | 7;12;13;21 | 08.270.1000.590 | 005 250 01 03 | 36;43;49 |
| 08.270.1000.583 | 0421.333.00 | 7;12;13;21 | 08.270.1000.590 | 005 250 02 03 | 36;43;49 |
| 08.270.1000.583 | 1348 133 | 7;12;13;21 | 08.270.1000.590 | 007 250 42 03 | 36;43;49 |
| 08.270.1000.583 | 1861 351 338 | 7;12;13;21 | 08.270.1000.590 | 007 250 43 03 | 36;43;49 |
| 08.270.1000.583 | 1861 351 340 | 7;12;13;21 | 08.270.1000.590 | 01.23.127 | 36;43;49 |
| 08.270.1000.583 | 1861 351 341 | 7;12;13;21 | 08.270.1000.590 | 0401.101.10 | 36;43;49 |
| 08.270.1000.583 | 1861 486 202 | 7;12;13;21 | 08.270.1000.590 | 0401.101.11 | 36;43;49 |
| 08.270.1000.583 | 1861 486 231 | 7;12;13;21 | 08.270.1000.590 | 0401.101.21 | 36;43;49 |
| 08.270.1000.583 | 1861 486 232 | 7;12;13;21 | 08.270.1000.590 | 101647 | 36;43;49 |
| 08.270.1000.583 | 1861 486 233 | 7;12;13;21 | 08.270.1000.590 | 11009713 | 36;43;49 |
| 08.270.1000.583 | 1861 486 234 | 7;12;13;21 | 08.270.1000.590 | 1681 511 201 | 36;43;49 |
| 08.270.1000.583 | 1861 669 001 | 7;12;13;21 | 08.270.1000.590 | 1861 410 021 | 36;43;49 |
| 08.270.1000.583 | 1861 669 002 | 7;12;13;21 | 08.270.1000.590 | 1861 410 035 | 36;43;49 |
| 08.270.1000.583 | 1861 669 003 | 7;12;13;21 | 08.270.1000.590 | 1861 410 040 | 36;43;49 |
| 08.270.1000.583 | 1861 923 003 | 7;12;13;21 | 08.270.1000.590 | 1861 410 041 | 36;43;49 |
| 08.270.1000.583 | 1861 923 103 | 7;12;13;21 | 08.270.1000.590 | 1861 410 045 | 36;43;49 |
| 08.270.1000.583 | 1861 942 033 | 7;12;13;21 | 08.270.1000.590 | 1861 410 046 | 36;43;49 |
| 08.270.1000.583 | 1862 147 032 | 7;12;13;21 | 08.270.1000.590 | 1861 410 068 | 36;43;49 |
| 08.270.1000.583 | 1862 356 031 | 7;12;13;21 | 08.270.1000.590 | 1861 511 202 | 36;43;49 |
| 08.270.1000.583 | 1878 001 152 | 7;12;13;21 | 08.270.1000.590 | 1861 511 232 | 36;43;49 |
| 08.270.1000.583 | 378 012 | 7;12;13;21 | 08.270.1000.590 | 20281 | 36;43;49 |
| 08.270.1000.583 | 387 012 | 7;12;13;21 | 08.270.1000.590 | 5000 587 571 | 36;43;49 |
| 08.270.1000.583 | 4200 3545 | 7;12;13;21 | 08.270.1000.590 | 5000 589 571 | 36;43;49 |
| 08.270.1000.583 | 4202 6470 | 7;12;13;21 | 08.270.1000.590 | 5000 822 147 | 36;43;49 |
| 08.270.1000.583 | 4203 7449 | 7;12;13;21 | 08.270.1000.590 | 632 100 210 | 36;43;49 |
| 08.270.1000.583 | 4203 7450 | 7;12;13;21 | 08.270.1000.590 | 953.2628.030 | 36;43;49 |
| 08.270.1000.583 | 4210 2160 | 7;12;13;21 | 08.270.1000.593 | 0001 152 310 | 49 |
| 08.270.1000.583 | 5253497 | 7;12;13;21 | 08.270.1000.593 | 0001 154 566 | 49 |
| 08.270.1000.583 | 5516382 | 7;12;13;21 | 08.270.1000.593 | 1862 505 331 | 49 |
| 08.270.1000.583 | 61500160002 | 7;12;13;21 | 08.270.1000.593 | 1878 020 241 | 49 |
| 08.270.1000.583 | 632 101 480 | 7;12;13;21 | 08.270.1000.593 | 1878 061 842 | 49 |
| 08.270.1000.583 | 669 372 | 7;12;13;21 | 08.270.1000.593 | 1898 180 391 | 49 |
| 08.270.1000.583 | 740 791 | 7;12;13;21 | 08.270.1000.593 | 1898 917 135 | 49 |
| 08.270.1000.583 | 740 792 | 7;12;13;21 | 08.270.1000.593 | 5000 667 054 | 49 |
| 08.270.1000.583 | 8.383.195.000 | 7;12;13;21 | 08.270.1000.593 | 5000 677 007 | 49 |
| 08.270.1000.583 | 8.383.203.000 | 7;12;13;21 | 08.270.1000.593 | 5000 677 134 | 49 |
| 08.270.1000.583 | 8.383.265.000 | 7;12;13;21 | 08.270.1000.593 | 5000 677 154 | 49 |
| 08.270.1000.583 | 892.00.16.0004 | 7;12;13;21 | 08.270.1000.593 | 5000 677 243 | 49 |
| 08.270.1000.583 | 892.00.16.0007 | 7;12;13;21 | 08.270.1000.593 | 5000 677 244 | 49 |

Vergleichsliste | Crosslist

aufsteigend nach ST-Nr. | ascending to ST-No.

| | | | | | |
|------------------------|---------------|----|------------------------|---------------|----------|
| 08.270.1000.593 | 5000 677 328 | 49 | 08.270.1000.603 | 5003 72 083 | 14 |
| 08.270.1000.593 | 5000 677 343 | 49 | 08.270.1000.603 | 5003 75 057 | 14 |
| 08.270.1000.593 | 5000 788 292 | 49 | 08.270.1000.603 | 5040 18 317 | 14 |
| 08.270.1000.593 | 5010 244 184 | 49 | 08.270.1000.603 | 8.323.291.000 | 14 |
| 08.270.1000.593 | 5010 244 256 | 49 | 08.270.1000.603 | 9843 5804 | 14 |
| 08.270.1000.593 | 5010 244 379 | 49 | 08.270.1000.603 | 9843 5977 | 14 |
| 08.270.1000.593 | 5010 244 412 | 49 | 08.270.1000.603 | 9848 4664 | 14 |
| 08.270.1000.593 | 5010 245 448 | 49 | 08.270.1000.603 | 9849 6006 | 14 |
| 08.270.1000.593 | 5430 013 403 | 49 | 08.270.1000.603 | 9944 5713 | 14 |
| 08.270.1000.593 | 5430 120 506 | 49 | 08.270.1000.603 | 9945 3752 | 14 |
| 08.270.1000.600 | 007 250 46 03 | 35 | 08.270.1000.603 | 9946 3435 | 14 |
| 08.270.1000.600 | 007 250 47 03 | 35 | 08.270.1000.610 | 007 250 49 03 | 35 |
| 08.270.1000.600 | 008 250 16 03 | 35 | 08.270.1000.610 | 007 250 50 03 | 35 |
| 08.270.1000.600 | 008 250 82 03 | 35 | 08.270.1000.610 | 008 250 17 03 | 35 |
| 08.270.1000.600 | 010 250 77 03 | 35 | 08.270.1000.610 | 008 250 83 03 | 35 |
| 08.270.1000.600 | 1862 135 031 | 35 | 08.270.1000.610 | 010 250 78 03 | 35 |
| 08.270.1000.600 | 1862 135 033 | 35 | 08.270.1000.610 | 01.23.108 | 35 |
| 08.270.1000.600 | 1862 135 035 | 35 | 08.270.1000.610 | 1862 138 031 | 35 |
| 08.270.1000.603 | 0190 4729 | 14 | 08.270.1000.610 | 1862 138 032 | 35 |
| 08.270.1000.603 | 0190 4751 | 14 | 08.270.1000.610 | 1862 138 033 | 35 |
| 08.270.1000.603 | 0190 8508 | 14 | 08.270.1000.613 | 0001 144 060 | 23;49;50 |
| 08.270.1000.603 | 0190 8524 | 14 | 08.270.1000.613 | 0001 151 423 | 23;49;50 |
| 08.270.1000.603 | 123156 | 14 | 08.270.1000.613 | 1878 022 841 | 23;49;50 |
| 08.270.1000.603 | 1861 933 031 | 14 | 08.270.1000.613 | 1898 180 395 | 23;49;50 |
| 08.270.1000.603 | 1861 933 032 | 14 | 08.270.1000.613 | 1898 917 153 | 23;49;50 |
| 08.270.1000.603 | 1861 961 131 | 14 | 08.270.1000.613 | 5000 677 053 | 23;49;50 |
| 08.270.1000.603 | 1861 961 133 | 14 | 08.270.1000.613 | 5000 677 055 | 23;49;50 |
| 08.270.1000.603 | 1861 961 135 | 14 | 08.270.1000.613 | 5000 677 254 | 23;49;50 |
| 08.270.1000.603 | 1862 458 031 | 14 | 08.270.1000.613 | 5000 677 285 | 23;49;50 |
| 08.270.1000.603 | 1878 085 741 | 14 | 08.270.1000.613 | 5001 824 450 | 23;49;50 |
| 08.270.1000.603 | 4206 2185 | 14 | 08.270.1000.620 | 009 250 43 03 | 35;55 |
| 08.270.1000.603 | 4206 3099 | 14 | 08.270.1000.620 | 009 250 44 03 | 35;55 |
| 08.270.1000.603 | 4210 0535 | 14 | 08.270.1000.620 | 010 250 55 03 | 35;55 |
| 08.270.1000.603 | 4210 0537 | 14 | 08.270.1000.620 | 011 250 08 03 | 35;55 |
| 08.270.1000.603 | 4210 2091 | 14 | 08.270.1000.620 | 012 250 86 03 | 35;55 |
| 08.270.1000.603 | 4210 2177 | 14 | 08.270.1000.620 | 012 250 88 03 | 35;55 |
| 08.270.1000.603 | 4210 4793 | 14 | 08.270.1000.620 | 012 250 90 03 | 35;55 |
| 08.270.1000.603 | 4210 4983 | 14 | 08.270.1000.620 | 012 250 91 03 | 35;55 |
| 08.270.1000.603 | 4211 4680 | 14 | 08.270.1000.620 | 013 250 38 03 | 35;55 |
| 08.270.1000.603 | 5003 01 459 | 14 | 08.270.1000.620 | 014 250 68 03 | 35;55 |
| 08.270.1000.603 | 5003 72 079 | 14 | 08.270.1000.620 | 015 250 27 03 | 35;55 |
| 08.270.1000.603 | 5003 72 081 | 14 | 08.270.1000.620 | 015 250 32 03 | 35;55 |

aufsteigend nach ST-Nr. | ascending to ST-No.

| | | |
|------------------------|-----------------|------------|
| 08.270.1000.620 | 015 250 95 03 | 35;55 |
| 08.270.1000.620 | 016 250 38 03 | 35;55 |
| 08.270.1000.620 | 016 250 39 03 | 35;55 |
| 08.270.1000.620 | 016 250 49 03 | 35;55 |
| 08.270.1000.620 | 017 250 47 03 | 35;55 |
| 08.270.1000.620 | 017 250 48 03 | 35;55 |
| 08.270.1000.620 | 017 250 49 03 | 35;55 |
| 08.270.1000.620 | 018 250 36 03 | 35;55 |
| 08.270.1000.620 | 0421.341.10 | 35;55 |
| 08.270.1000.620 | 10657411 | 35;55 |
| 08.270.1000.620 | 1862 283 031 | 35;55 |
| 08.270.1000.620 | 1862 283 032 | 35;55 |
| 08.270.1000.620 | 1862 283 133 | 35;55 |
| 08.270.1000.620 | 1862 519 137 | 35;55 |
| 08.270.1000.620 | 1878 002 729 | 35;55 |
| 08.270.1000.623 | 1878 026 241 | 49 |
| 08.270.1000.623 | 5000 059 526 | 49 |
| 08.270.1000.623 | 5000 677 249 | 49 |
| 08.270.1000.623 | 5010 244 091 | 49 |
| 08.270.1000.623 | 5010 244 324 | 49 |
| 08.270.1000.623 | 5010 245 447 | 49 |
| 08.270.1000.623 | 5010 452 507 | 49 |
| 08.270.1000.630 | 007 250 60 03 | 36;42;43 |
| 08.270.1000.630 | 007 250 61 03 | 36;42;43 |
| 08.270.1000.630 | 010 250 88 03 | 36;42;43 |
| 08.270.1000.630 | 010 250 89 03 | 36;42;43 |
| 08.270.1000.630 | 016 250 19 03 | 36;42;43 |
| 08.270.1000.630 | 0421.323.00 | 36;42;43 |
| 08.270.1000.630 | 11009996 | 36;42;43 |
| 08.270.1000.630 | 1862 190 105 | 36;42;43 |
| 08.270.1000.630 | 1862 190 131 | 36;42;43 |
| 08.270.1000.630 | 1862 190 132 | 36;42;43 |
| 08.270.1000.630 | 1862 190 133 | 36;42;43 |
| 08.270.1000.630 | 1862 190 136 | 36;42;43 |
| 08.270.1000.630 | 1878 042 201 | 36;42;43 |
| 08.270.1000.630 | 400250100004-00 | 36;42;43 |
| 08.270.1000.630 | 8.383.281.000 | 36;42;43 |
| 08.270.1000.630 | 8.383.335.000 | 36;42;43 |
| 08.270.1000.630 | 8.383.335.000.0 | 36;42;43 |
| 08.270.1000.630 | 8.383.335.000.2 | 36;42;43 |
| 08.270.1000.630 | 8.389.335.000 | 36;42;43 |
| 08.270.1000.633 | 016 250 35 03 | 8;23;37;43 |

| | | |
|------------------------|---------------|------------|
| 08.270.1000.633 | 016 250 36 03 | 8;23;37;43 |
| 08.270.1000.633 | 016 250 37 03 | 8;23;37;43 |
| 08.270.1000.633 | 016 250 46 03 | 8;23;37;43 |
| 08.270.1000.633 | 017 250 87 03 | 8;23;37;43 |
| 08.270.1000.633 | 018 250 20 03 | 8;23;37;43 |
| 08.270.1000.633 | 018 250 94 03 | 8;23;37;43 |
| 08.270.1000.633 | 019 250 66 03 | 8;23;37;43 |
| 08.270.1000.633 | 020 250 58 03 | 8;23;37;43 |
| 08.270.1000.633 | 11010031 | 8;23;37;43 |
| 08.270.1000.633 | 1140 537 | 8;23;37;43 |
| 08.270.1000.633 | 1878 037 844 | 8;23;37;43 |
| 08.270.1000.633 | 1878 037 857 | 8;23;37;43 |
| 08.270.1000.633 | 1878 039 831 | 8;23;37;43 |
| 08.270.1000.633 | 1878 080 034 | 8;23;37;43 |
| 08.270.1000.633 | 267748 | 8;23;37;43 |
| 08.270.1000.633 | 421035300 | 8;23;37;43 |
| 08.270.1000.633 | 81.30000.6602 | 8;23;37;43 |
| 08.270.1000.633 | 81.30301.0440 | 8;23;37;43 |
| 08.270.1000.633 | 81.30301.0459 | 8;23;37;43 |
| 08.270.1000.633 | 81.30301.0500 | 8;23;37;43 |
| 08.270.1000.633 | 81.30301.0509 | 8;23;37;43 |
| 08.270.1000.633 | 8.383.336.000 | 8;23;37;43 |
| 08.270.1000.633 | 8.383.350.000 | 8;23;37;43 |
| 08.270.1000.640 | 015 250 71 03 | 37;38 |
| 08.270.1000.640 | 015 250 72 03 | 37;38 |
| 08.270.1000.640 | 015 250 73 03 | 37;38 |
| 08.270.1000.640 | 015 250 75 03 | 37;38 |
| 08.270.1000.640 | 015 250 76 03 | 37;38 |
| 08.270.1000.640 | 015 250 77 03 | 37;38 |
| 08.270.1000.640 | 018 250 22 03 | 37;38 |
| 08.270.1000.640 | 018 250 23 03 | 37;38 |
| 08.270.1000.640 | 018 250 24 03 | 37;38 |
| 08.270.1000.640 | 018 250 25 03 | 37;38 |
| 08.270.1000.640 | 018 250 71 03 | 37;38 |
| 08.270.1000.640 | 019 250 30 03 | 37;38 |
| 08.270.1000.640 | 019 250 49 03 | 37;38 |
| 08.270.1000.640 | 019 250 54 03 | 37;38 |
| 08.270.1000.640 | 019 250 57 03 | 37;38 |
| 08.270.1000.640 | 019 250 60 03 | 37;38 |
| 08.270.1000.640 | 019 250 88 03 | 37;38 |
| 08.270.1000.640 | 020 250 15 03 | 37;38 |
| 08.270.1000.640 | 020 250 40 03 | 37;38 |

Vergleichsliste | Crosslist

aufsteigend nach ST-Nr. | ascending to ST-No.

| | | | | | |
|------------------------|---------------|-------|------------------------|---------------|-------|
| 08.270.1000.640 | 020 250 45 03 | 37;38 | 08.270.1000.653 | 81.30301.9191 | 22 |
| 08.270.1000.640 | 020 250 91 03 | 37;38 | 08.270.1000.653 | 81.30301.9201 | 22 |
| 08.270.1000.640 | 020 250 92 03 | 37;38 | 08.270.1000.653 | 81.30301.9232 | 22 |
| 08.270.1000.640 | 022 250 23 01 | 37;38 | 08.270.1000.653 | 81.30301.9246 | 22 |
| 08.270.1000.640 | 1862 519 034 | 37;38 | 08.270.1000.653 | 81.30301.9250 | 22 |
| 08.270.1000.640 | 1862 519 139 | 37;38 | 08.270.1000.653 | 8.383.243.000 | 22 |
| 08.270.1000.640 | 1862 519 240 | 37;38 | 08.270.1000.653 | 8.383.263.000 | 22 |
| 08.270.1000.640 | 1878 000 299 | 37;38 | 08.270.1000.661 | 008 250 13 03 | 36;42 |
| 08.270.1000.640 | 1878 002 730 | 37;38 | 08.270.1000.661 | 008 250 14 03 | 36;42 |
| 08.270.1000.640 | 1878 002 730 | 37;38 | 08.270.1000.661 | 010 250 91 03 | 36;42 |
| 08.270.1000.643 | 0422 6846 | 22 | 08.270.1000.661 | 010 250 92 03 | 36;42 |
| 08.270.1000.643 | 107 206 99 | 22 | 08.270.1000.661 | 0421.342.00 | 36;42 |
| 08.270.1000.643 | 1862 539 031 | 22 | 08.270.1000.661 | 1862 190 106 | 36;42 |
| 08.270.1000.643 | 1878 002 263 | 22 | 08.270.1000.661 | 1862 193 105 | 36;42 |
| 08.270.1000.643 | 1878 002 643 | 22 | 08.270.1000.661 | 1862 193 132 | 36;42 |
| 08.270.1000.643 | 81.30000.7220 | 22 | 08.270.1000.663 | 1 349 349 | 55 |
| 08.270.1000.643 | 81.30301.0392 | 22 | 08.270.1000.663 | 1 390 374 | 55 |
| 08.270.1000.643 | 81.30301.0539 | 22 | 08.270.1000.663 | 1 413 177 | 55 |
| 08.270.1000.643 | 81.30301.0566 | 22 | 08.270.1000.663 | 1862 454 031 | 55 |
| 08.270.1000.643 | 81.30301.9566 | 22 | 08.270.1000.663 | 1878 013 031 | 55 |
| 08.270.1000.650 | 002 250 33 03 | 36;43 | 08.270.1000.663 | 1878 013 132 | 55 |
| 08.270.1000.650 | 010 250 02 03 | 36;43 | 08.270.1000.663 | 1878 043 231 | 55 |
| 08.270.1000.650 | 0401.145.00 | 36;43 | 08.270.1000.663 | 571 224 | 55 |
| 08.270.1000.650 | 1861 410 032 | 36;43 | 08.270.1000.663 | 571 291 | 55 |
| 08.270.1000.650 | 1861 410 047 | 36;43 | 08.270.1000.663 | 571 296 | 55 |
| 08.270.1000.650 | 8.383.145.000 | 36;43 | 08.270.1000.671 | 008 250 19 03 | 37 |
| 08.270.1000.653 | 0401.191.00 | 22 | 08.270.1000.671 | 008 250 20 03 | 37 |
| 08.270.1000.653 | 0421.310.00 | 22 | 08.270.1000.671 | 008 250 36 03 | 37 |
| 08.270.1000.653 | 1861 911 203 | 22 | 08.270.1000.671 | 008 250 37 03 | 37 |
| 08.270.1000.653 | 1861 911 231 | 22 | 08.270.1000.671 | 008 250 51 03 | 37 |
| 08.270.1000.653 | 1861 911 232 | 22 | 08.270.1000.671 | 011 250 04 03 | 37 |
| 08.270.1000.653 | 1861 911 303 | 22 | 08.270.1000.671 | 01.23.130 | 37 |
| 08.270.1000.653 | 632 100 470 | 22 | 08.270.1000.671 | 013 250 26 03 | 37 |
| 08.270.1000.653 | 632 101 110 | 22 | 08.270.1000.671 | 013 250 41 03 | 37 |
| 08.270.1000.653 | 632 101 210 | 22 | 08.270.1000.671 | 015 250 22 03 | 37 |
| 08.270.1000.653 | 81.30301.0191 | 22 | 08.270.1000.671 | 016 250 09 03 | 37 |
| 08.270.1000.653 | 81.30301.0192 | 22 | 08.270.1000.671 | 016 250 10 03 | 37 |
| 08.270.1000.653 | 81.30301.0201 | 22 | 08.270.1000.671 | 016 250 27 03 | 37 |
| 08.270.1000.653 | 81.30301.0208 | 22 | 08.270.1000.671 | 016 250 28 03 | 37 |
| 08.270.1000.653 | 81.30301.0232 | 22 | 08.270.1000.671 | 1862 189 031 | 37 |
| 08.270.1000.653 | 81.30301.0246 | 22 | 08.270.1000.671 | 1862 189 032 | 37 |
| 08.270.1000.653 | 81.30301.0250 | 22 | 08.270.1000.671 | 1862 216 031 | 37 |

aufsteigend nach ST-Nr. | ascending to ST-No.

| | | | | | |
|------------------------|---------------|-------|------------------------|---------------|-------|
| 08.270.1000.671 | 1862 216 032 | 37 | 08.270.1000.691 | 018 250 92 03 | 34;35 |
| 08.270.1000.671 | 8.383.267.000 | 37 | 08.270.1000.691 | 019 250 42 03 | 34;35 |
| 08.270.1000.673 | ATRA243 | 7;13 | 08.270.1000.691 | 019 250 91 03 | 34;35 |
| 08.270.1000.673 | 1375 593 | 7;13 | 08.270.1000.691 | 1878 048 741 | 34;35 |
| 08.270.1000.673 | 1375 593R | 7;13 | 08.270.1000.691 | 1878 052 842 | 34;35 |
| 08.270.1000.673 | 1878 000 036 | 7;13 | 08.270.1000.693 | ATRA242 | 7;21 |
| 08.270.1000.673 | 5040 4993 | 7;13 | 08.270.1000.693 | ATRB 074 | 7;21 |
| 08.270.1000.681 | 0190 3836 | 13 | 08.270.1000.693 | 1400 510 | 7;21 |
| 08.270.1000.681 | 0190 3845 | 13 | 08.270.1000.693 | 1409 478 | 7;21 |
| 08.270.1000.681 | 0190 3862 | 13 | 08.270.1000.693 | 1878 047 333 | 7;21 |
| 08.270.1000.681 | 0190 3865 | 13 | 08.270.1000.693 | 1878 063 531 | 7;21 |
| 08.270.1000.681 | 0190 3879 | 13 | 08.270.1000.693 | 1878 079 331 | 7;21 |
| 08.270.1000.681 | 0190 3881 | 13 | 08.270.1000.693 | 81.30301.0411 | 7;21 |
| 08.270.1000.681 | 0190 3886 | 13 | 08.270.1000.693 | 81.30301.0450 | 7;21 |
| 08.270.1000.681 | 0190 3899 | 13 | 08.270.1000.693 | 81.30301.0468 | 7;21 |
| 08.270.1000.681 | 0190 3911 | 13 | 08.270.1000.693 | 81.30301.0469 | 7;21 |
| 08.270.1000.681 | 0190 3924 | 13 | 08.270.1000.693 | 81.30301.0470 | 7;21 |
| 08.270.1000.681 | 0190 4761 | 13 | 08.270.1000.693 | 81.30301.0490 | 7;21 |
| 08.270.1000.681 | 0190 4762 | 13 | 08.270.1000.693 | 81.30301.0491 | 7;21 |
| 08.270.1000.681 | 0190 4763 | 13 | 08.270.1000.693 | 81.30301.0492 | 7;21 |
| 08.270.1000.681 | 0247 7897 | 13 | 08.270.1000.693 | 81.30301.0520 | 7;21 |
| 08.270.1000.681 | 0299 1587 | 13 | 08.270.1000.693 | 81.30301.0529 | 7;21 |
| 08.270.1000.681 | 0445 7823 | 13 | 08.270.1000.693 | 81.30301.0556 | 7;21 |
| 08.270.1000.681 | 0445 9823 | 13 | 08.270.1000.693 | 81.30301.9492 | 7;21 |
| 08.270.1000.681 | 0469 1736 | 13 | 08.270.1000.701 | 1524 771 | 62 |
| 08.270.1000.681 | 0474 1461 | 13 | 08.270.1000.701 | 1668 537 | 62 |
| 08.270.1000.681 | 1861 560 232 | 13 | 08.270.1000.701 | 1668 672 | 62 |
| 08.270.1000.681 | 1861 560 234 | 13 | 08.270.1000.701 | 1668 983 | 62 |
| 08.270.1000.681 | 4210 0567 | 13 | 08.270.1000.701 | 1878 002 733 | 62 |
| 08.270.1000.681 | 4210 0571 | 13 | 08.270.1000.701 | 1878 054 031 | 62 |
| 08.270.1000.681 | 4210 0576 | 13 | 08.270.1000.701 | 3191 991 | 62 |
| 08.270.1000.681 | 4211 4182 | 13 | 08.270.1000.701 | 8112 194 | 62 |
| 08.270.1000.681 | 5290559 | 13 | 08.270.1000.701 | 8113 054 | 62 |
| 08.270.1000.681 | 5292189 | 13 | 08.270.1000.701 | 8113 225 | 62 |
| 08.270.1000.681 | 55010 | 13 | 08.270.1000.701 | 8113 525 | 62 |
| 08.270.1000.681 | 632 100 090 | 13 | 08.270.1000.703 | 1 436 695 | 55 |
| 08.270.1000.681 | 632 100 410 | 13 | 08.270.1000.703 | 1 749 124 | 55 |
| 08.270.1000.681 | 9445 9823 | 13 | 08.270.1000.703 | 1878 003 065 | 55 |
| 08.270.1000.683 | 1447 243 | 7 | 08.270.1000.703 | 1878 056 732 | 55 |
| 08.270.1000.683 | 1878 000 296 | 7 | 08.270.1000.703 | 571 270 | 55 |
| 08.270.1000.691 | 017 250 05 03 | 34;35 | 08.270.1000.703 | 571 310 | 55 |
| 08.270.1000.691 | 017 250 06 03 | 34;35 | 08.270.1000.711 | 1307 569 | 7;21 |

Vergleichsliste | Crosslist

aufsteigend nach ST-Nr. | ascending to ST-No.

| | | | | | |
|------------------------|---------------|-------|------------------------|---------------|----------|
| 08.270.1000.711 | 1348 131 | 7;21 | 08.270.1000.731 | 019 250 52 03 | 36 |
| 08.270.1000.711 | 1385 520 | 7;21 | 08.270.1000.731 | 019 250 61 03 | 36 |
| 08.270.1000.711 | 1862 528 032 | 7;21 | 08.270.1000.731 | 020 250 94 03 | 36 |
| 08.270.1000.711 | 1862 541 031 | 7;21 | 08.270.1000.731 | 020 250 98 01 | 36 |
| 08.270.1000.711 | 1862 541 032 | 7;21 | 08.270.1000.731 | 1862 190 139 | 36 |
| 08.270.1000.711 | 1878 044 631 | 7;21 | 08.270.1000.731 | 1878 002 024 | 36 |
| 08.270.1000.711 | 81.30301.0001 | 7;21 | 08.270.1000.731 | 1878 005 031 | 36 |
| 08.270.1000.711 | 81.30301.0393 | 7;21 | 08.270.1000.731 | 1878 056 331 | 36 |
| 08.270.1000.711 | 81.30301.0395 | 7;21 | 08.270.1000.741 | 1524 768 | 61;62 |
| 08.270.1000.711 | 81.30301.0475 | 7;21 | 08.270.1000.741 | 1668 671 | 61;62 |
| 08.270.1000.711 | 81.30301.9393 | 7;21 | 08.270.1000.741 | 1673 859 | 61;62 |
| 08.270.1000.713 | 1521 726 | 60;61 | 08.270.1000.741 | 1862 335 032 | 61;62 |
| 08.270.1000.713 | 1878 002 442 | 60;61 | 08.270.1000.741 | 1862 530 231 | 61;62 |
| 08.270.1000.713 | 1878 032 231 | 60;61 | 08.270.1000.741 | 8112 222 | 61;62 |
| 08.270.1000.713 | 1878 032 233 | 60;61 | 08.270.1000.741 | 8112 924 | 61;62 |
| 08.270.1000.713 | 8113 658 | 60;61 | 08.270.1000.741 | 8113 257 | 61;62 |
| 08.270.1000.713 | 8113 993 | 60;61 | 08.270.1000.751 | 0421.307.00 | 22;43;49 |
| 08.270.1000.713 | 8171 497 | 60;61 | 08.270.1000.751 | 0421.308.00 | 22;43;49 |
| 08.270.1000.721 | 078 867 | 7 | 08.270.1000.751 | 1861 639 001 | 22;43;49 |
| 08.270.1000.721 | 1239 659 | 7 | 08.270.1000.751 | 1861 639 004 | 22;43;49 |
| 08.270.1000.721 | 1272 115 | 7 | 08.270.1000.751 | 1861 639 006 | 22;43;49 |
| 08.270.1000.721 | 1287 597 | 7 | 08.270.1000.751 | 1861 639 031 | 22;43;49 |
| 08.270.1000.721 | 130-210-4341 | 7 | 08.270.1000.751 | 1861 639 032 | 22;43;49 |
| 08.270.1000.721 | 1303 560 | 7 | 08.270.1000.751 | 1861 639 035 | 22;43;49 |
| 08.270.1000.721 | 1342 345 | 7 | 08.270.1000.751 | 1861 639 107 | 22;43;49 |
| 08.270.1000.721 | 1362 759 | 7 | 08.270.1000.751 | 1861 639 148 | 22;43;49 |
| 08.270.1000.721 | 1385 522 | 7 | 08.270.1000.751 | 5000 822 629 | 22;43;49 |
| 08.270.1000.721 | 1689 108 | 7 | 08.270.1000.751 | 5336236 | 22;43;49 |
| 08.270.1000.721 | 1878 040 631 | 7 | 08.270.1000.751 | 5483190 | 22;43;49 |
| 08.270.1000.721 | 1878 054 933 | 7 | 08.270.1000.751 | 5609004 | 22;43;49 |
| 08.270.1000.721 | 234502 | 7 | 08.270.1000.751 | 5637071 | 22;43;49 |
| 08.270.1000.721 | 270074 | 7 | 08.270.1000.751 | 81.30301.0112 | 22;43;49 |
| 08.270.1000.721 | 3482 058 203 | 7 | 08.270.1000.751 | 81.30301.0148 | 22;43;49 |
| 08.270.1000.731 | 015 250 79 03 | 36 | 08.270.1000.751 | 81.30301.0162 | 22;43;49 |
| 08.270.1000.731 | 015 250 80 03 | 36 | 08.270.1000.751 | 81.30301.0249 | 22;43;49 |
| 08.270.1000.731 | 015 250 81 03 | 36 | 08.270.1000.751 | 81.30301.9112 | 22;43;49 |
| 08.270.1000.731 | 017 250 03 03 | 36 | 08.270.1000.751 | 81.30301.9148 | 22;43;49 |
| 08.270.1000.731 | 017 250 09 03 | 36 | 08.270.1000.751 | 81.30301.9162 | 22;43;49 |
| 08.270.1000.731 | 017 250 11 03 | 36 | 08.270.1000.751 | 81.30301.9249 | 22;43;49 |
| 08.270.1000.731 | 018 250 11 03 | 36 | 08.270.1000.751 | 8.383.185.000 | 22;43;49 |
| 08.270.1000.731 | 018 250 13 03 | 36 | 08.270.1000.751 | 8.383.260.000 | 22;43;49 |
| 08.270.1000.731 | 018 250 60 03 | 36 | 08.270.1000.751 | 8.383.312.000 | 22;43;49 |

aufsteigend nach ST-Nr. | ascending to ST-No.

| | | | | | |
|------------------------|--------------|------|------------------------|---------------|-------|
| 08.270.1000.753 | 1526 046 | 60 | 08.270.1000.761 | 4210 2093 | 8;14 |
| 08.270.1000.753 | 1527 523 | 60 | 08.270.1000.761 | 4210 2095 | 8;14 |
| 08.270.1000.753 | 1655 648 | 60 | 08.270.1000.761 | 4210 2104 | 8;14 |
| 08.270.1000.753 | 1667 930 | 60 | 08.270.1000.761 | 500 292 646 | 8;14 |
| 08.270.1000.753 | 1668 372 | 60 | 08.270.1000.761 | 500 392 645 | 8;14 |
| 08.270.1000.753 | 1861 437 034 | 60 | 08.270.1000.761 | 9606 2916 | 8;14 |
| 08.270.1000.753 | 1861 437 337 | 60 | 08.270.1000.761 | 9843 5802 | 8;14 |
| 08.270.1000.753 | 1861 641 031 | 60 | 08.270.1000.761 | 9843 5975 | 8;14 |
| 08.270.1000.753 | 1861 641 135 | 60 | 08.270.1000.761 | 9849 6005 | 8;14 |
| 08.270.1000.753 | 1861 641 236 | 60 | 08.270.1000.761 | 9944 5716 | 8;14 |
| 08.270.1000.753 | 1878 001 082 | 60 | 08.270.1000.761 | 9945 3753 | 8;14 |
| 08.270.1000.753 | 267 236 | 60 | 08.270.1000.761 | 9946 3434 | 8;14 |
| 08.270.1000.753 | 5002 241 | 60 | 08.270.1000.763 | 1669 138 | 61 |
| 08.270.1000.753 | 5002 242 | 60 | 08.270.1000.763 | 1862 413 031 | 61 |
| 08.270.1000.753 | 5100 006 | 60 | 08.270.1000.763 | 1878 000 623 | 61 |
| 08.270.1000.753 | 8112 108 | 60 | 08.270.1000.763 | 1878 002 458 | 61 |
| 08.270.1000.753 | 8112 125 | 60 | 08.270.1000.763 | 8112 604 | 61 |
| 08.270.1000.761 | 0190 4711 | 8;14 | 08.270.1000.763 | 85 000 311 | 61 |
| 08.270.1000.761 | 0190 4730 | 8;14 | 08.270.1000.771 | 11010004 | 22 |
| 08.270.1000.761 | 0190 4752 | 8;14 | 08.270.1000.771 | 1862 506 131 | 22 |
| 08.270.1000.761 | 0190 4779 | 8;14 | 08.270.1000.771 | 5654556 | 22 |
| 08.270.1000.761 | 0190 4790 | 8;14 | 08.270.1000.771 | 81.30301.0378 | 22 |
| 08.270.1000.761 | 0190 5840 | 8;14 | 08.270.1000.771 | 81.30301.0524 | 22 |
| 08.270.1000.761 | 0190 8518 | 8;14 | 08.270.1000.771 | 81.30301.0557 | 22 |
| 08.270.1000.761 | 0813 2554 | 8;14 | 08.270.1000.771 | 81.30301.0558 | 22 |
| 08.270.1000.761 | 123762 | 8;14 | 08.270.1000.771 | 81.30301.9378 | 22 |
| 08.270.1000.761 | 1303 702 | 8;14 | 08.270.1000.771 | 81.30301.9557 | 22 |
| 08.270.1000.761 | 1395 696 | 8;14 | 08.270.1000.773 | 1669 139 | 61 |
| 08.270.1000.761 | 151517 | 8;14 | 08.270.1000.773 | 1862 414 031 | 61 |
| 08.270.1000.761 | 1861 998 131 | 8;14 | 08.270.1000.773 | 1878 000 625 | 61 |
| 08.270.1000.761 | 1861 998 133 | 8;14 | 08.270.1000.773 | 1878 002 460 | 61 |
| 08.270.1000.761 | 1861 998 135 | 8;14 | 08.270.1000.773 | 8112 605 | 61 |
| 08.270.1000.761 | 1862 262 101 | 8;14 | 08.270.1000.781 | 1862 309 032 | 12;48 |
| 08.270.1000.761 | 1862 262 131 | 8;14 | 08.270.1000.781 | 1862 309 132 | 12;48 |
| 08.270.1000.761 | 1862 521 131 | 8;14 | 08.270.1000.781 | 1862 398 031 | 12;48 |
| 08.270.1000.761 | 1878 054 951 | 8;14 | 08.270.1000.781 | 1878 000 611 | 12;48 |
| 08.270.1000.761 | 4206 2098 | 8;14 | 08.270.1000.781 | 1878 077 041 | 12;48 |
| 08.270.1000.761 | 4206 2103 | 8;14 | 08.270.1000.781 | 1898 917 207 | 12;48 |
| 08.270.1000.761 | 4206 2916 | 8;14 | 08.270.1000.781 | 500 358 237 | 12;48 |
| 08.270.1000.761 | 4206 4318 | 8;14 | 08.270.1000.781 | 5000 677 308 | 12;48 |
| 08.270.1000.761 | 4210 0356 | 8;14 | 08.270.1000.781 | 5010 244 144 | 12;48 |
| 08.270.1000.761 | 4210 0536 | 8;14 | 08.270.1000.781 | 9840 0707 | 12;48 |

Vergleichsliste | Crosslist

aufsteigend nach ST-Nr. | ascending to ST-No.

| | | |
|------------------------|---------------|-------|
| 08.270.1000.781 | 9840 0717 | 12;48 |
| 08.270.1000.781 | 9841 7693 | 12;48 |
| 08.270.1000.781 | 9846 9384 | 12;48 |
| 08.270.1000.781 | 9846 9386 | 12;48 |
| 08.270.1000.781 | 9849 6861 | 12;48 |
| 08.270.1000.783 | 1878 000 948 | 50;62 |
| 08.270.1000.783 | 20 525 015 | 50;62 |
| 08.270.1000.783 | 3191 767 | 50;62 |
| 08.270.1000.783 | 7420 707 025 | 50;62 |
| 08.270.1000.783 | 8172 803 | 50;62 |
| 08.270.1000.783 | 85 000 238 | 50;62 |
| 08.270.1000.783 | 85 000 240 | 50;62 |
| 08.270.1000.783 | 85 000 279 | 50;62 |
| 08.270.1000.791 | 009 250 20 03 | 23;37 |
| 08.270.1000.791 | 011 250 90 03 | 23;37 |
| 08.270.1000.791 | 012 250 17 03 | 23;37 |
| 08.270.1000.791 | 012 250 18 03 | 23;37 |
| 08.270.1000.791 | 012 250 53 03 | 23;37 |
| 08.270.1000.791 | 012 250 84 03 | 23;37 |
| 08.270.1000.791 | 012 250 85 03 | 23;37 |
| 08.270.1000.791 | 013 250 08 03 | 23;37 |
| 08.270.1000.791 | 013 250 16 03 | 23;37 |
| 08.270.1000.791 | 013 250 17 03 | 23;37 |
| 08.270.1000.791 | 013 250 28 03 | 23;37 |
| 08.270.1000.791 | 013 250 33 03 | 23;37 |
| 08.270.1000.791 | 013 250 35 03 | 23;37 |
| 08.270.1000.791 | 013 250 71 03 | 23;37 |
| 08.270.1000.791 | 014 250 99 03 | 23;37 |
| 08.270.1000.791 | 015 250 00 03 | 23;37 |
| 08.270.1000.791 | 015 250 28 03 | 23;37 |
| 08.270.1000.791 | 015 250 30 03 | 23;37 |
| 08.270.1000.791 | 016 250 14 03 | 23;37 |
| 08.270.1000.791 | 016 250 15 03 | 23;37 |
| 08.270.1000.791 | 016 250 16 03 | 23;37 |
| 08.270.1000.791 | 016 250 30 03 | 23;37 |
| 08.270.1000.791 | 016 250 31 03 | 23;37 |
| 08.270.1000.791 | 016 250 32 03 | 23;37 |
| 08.270.1000.791 | 016 250 33 03 | 23;37 |
| 08.270.1000.791 | 016 250 34 03 | 23;37 |
| 08.270.1000.791 | 016 250 45 03 | 23;37 |
| 08.270.1000.791 | 017 250 84 03 | 23;37 |
| 08.270.1000.791 | 018 250 95 03 | 23;37 |

| | | |
|------------------------|---------------|-------|
| 08.270.1000.791 | 018 250 96 03 | 23;37 |
| 08.270.1000.791 | 018 250 99 03 | 23;37 |
| 08.270.1000.791 | 019 250 32 03 | 23;37 |
| 08.270.1000.791 | 020 250 59 03 | 23;37 |
| 08.270.1000.791 | 0421.354.00 | 23;37 |
| 08.270.1000.791 | 1 Jx046 4770 | 23;37 |
| 08.270.1000.791 | 10725736 | 23;37 |
| 08.270.1000.791 | 11010032 | 23;37 |
| 08.270.1000.791 | 11079872 | 23;37 |
| 08.270.1000.791 | 1862 226 132 | 23;37 |
| 08.270.1000.791 | 1862 226 134 | 23;37 |
| 08.270.1000.791 | 1862 226 136 | 23;37 |
| 08.270.1000.791 | 1862 226 237 | 23;37 |
| 08.270.1000.791 | 1862 369 031 | 23;37 |
| 08.270.1000.791 | 1862 504 041 | 23;37 |
| 08.270.1000.791 | 1878 031 031 | 23;37 |
| 08.270.1000.791 | 1878 031 033 | 23;37 |
| 08.270.1000.791 | 1878 037 840 | 23;37 |
| 08.270.1000.791 | 1878 037 849 | 23;37 |
| 08.270.1000.791 | 1878 037 856 | 23;37 |
| 08.270.1000.791 | 1878 065 632 | 23;37 |
| 08.270.1000.791 | 1878 080 033 | 23;37 |
| 08.270.1000.791 | 42134710 | 23;37 |
| 08.270.1000.791 | 5006005244 | 23;37 |
| 08.270.1000.791 | 81.30000.6601 | 23;37 |
| 08.270.1000.791 | 81.30301.0413 | 23;37 |
| 08.270.1000.791 | 81.30301.0421 | 23;37 |
| 08.270.1000.791 | 81.30301.0439 | 23;37 |
| 08.270.1000.791 | 81.30301.0458 | 23;37 |
| 08.270.1000.791 | 81.30301.0499 | 23;37 |
| 08.270.1000.791 | 81.30301.4485 | 23;37 |
| 08.270.1000.791 | 8.383.321.000 | 23;37 |
| 08.270.1000.793 | 1521 716 | 50;62 |
| 08.270.1000.793 | 1862 298 031 | 50;62 |
| 08.270.1000.793 | 1862 298 234 | 50;62 |
| 08.270.1000.793 | 1862 527 131 | 50;62 |
| 08.270.1000.793 | 1878 032 331 | 50;62 |
| 08.270.1000.793 | 8113 467 | 50;62 |
| 08.270.1000.793 | 8172 354 | 50;62 |
| 08.270.1000.793 | 8172 402 | 50;62 |
| 08.270.1000.793 | 8172 403 | 50;62 |
| 08.270.1000.793 | 8172 801 | 50;62 |

aufsteigend nach ST-Nr. | ascending to ST-No.

| | | | | | |
|------------------------|-----------------|-------|------------------------|---------------|-------|
| 08.270.1000.801 | 001 250 60 03 | 34 | 08.270.1000.811 | 009 250 40 03 | 12;34 |
| 08.270.1000.801 | 002 250 39 03 | 34 | 08.270.1000.811 | 01.23.119 | 12;34 |
| 08.270.1000.801 | 002 250 88 03 | 34 | 08.270.1000.811 | 0126 0096 | 12;34 |
| 08.270.1000.801 | 003 250 82 03 | 34 | 08.270.1000.811 | 0190 3850 | 12;34 |
| 08.270.1000.801 | 003 250 83 03 | 34 | 08.270.1000.811 | 0190 3855 | 12;34 |
| 08.270.1000.801 | 004 250 49 03 | 34 | 08.270.1000.811 | 0190 3948 | 12;34 |
| 08.270.1000.801 | 005 250 07 03 | 34 | 08.270.1000.811 | 0190 3949 | 12;34 |
| 08.270.1000.801 | 008 250 72 03 | 34 | 08.270.1000.811 | 02246046 | 12;34 |
| 08.270.1000.801 | 010 250 86 03 | 34 | 08.270.1000.811 | 0247 6075 | 12;34 |
| 08.270.1000.801 | 01.23.116 | 34 | 08.270.1000.811 | 0247 7936 | 12;34 |
| 08.270.1000.801 | 013 250 82 03 | 34 | 08.270.1000.811 | 0890-261 | 12;34 |
| 08.270.1000.801 | 013 250 92 03 | 34 | 08.270.1000.811 | 1861 234 001 | 12;34 |
| 08.270.1000.801 | 1861 303 213 | 34 | 08.270.1000.811 | 1861 234 004 | 12;34 |
| 08.270.1000.801 | 1861 303 237 | 34 | 08.270.1000.811 | 1861 234 010 | 12;34 |
| 08.270.1000.801 | 1861 303 243 | 34 | 08.270.1000.811 | 1861 258 031 | 12;34 |
| 08.270.1000.801 | 1861 303 248 | 34 | 08.270.1000.811 | 1861 274 233 | 12;34 |
| 08.270.1000.801 | 1861 303 252 | 34 | 08.270.1000.811 | 1861 274 237 | 12;34 |
| 08.270.1000.801 | 345 250 75 03 | 34 | 08.270.1000.811 | 1861 288 135 | 12;34 |
| 08.270.1000.801 | 8.383.156.000 | 34 | 08.270.1000.811 | 1861 288 136 | 12;34 |
| 08.270.1000.801 | 8.383.275.000.0 | 34 | 08.270.1000.811 | 1861 288 147 | 12;34 |
| 08.270.1000.803 | ACU 9333 | 8 | 08.270.1000.811 | 1878 001 074 | 12;34 |
| 08.270.1000.803 | 0755 079 | 8 | 08.270.1000.811 | 1878 054 841 | 12;34 |
| 08.270.1000.803 | 1287 899 | 8 | 08.270.1000.811 | 4210 2154 | 12;34 |
| 08.270.1000.803 | 1348 142 | 8 | 08.270.1000.811 | 5052220 | 12;34 |
| 08.270.1000.803 | 1348 142R | 8 | 08.270.1000.811 | 8751-52-51.35 | 12;34 |
| 08.270.1000.803 | 1395 695 | 8 | 08.270.1000.811 | 8751-52-51.55 | 12;34 |
| 08.270.1000.803 | 1395 695R | 8 | 08.270.1000.813 | 10876696 | 23;43 |
| 08.270.1000.803 | 1861 986 139 | 8 | 08.270.1000.813 | 1878 038 041 | 23;43 |
| 08.270.1000.803 | 1861 986 140 | 8 | 08.270.1000.813 | 20 504 343 | 23;43 |
| 08.270.1000.803 | 223811 | 8 | 08.270.1000.813 | 81.30301.0434 | 23;43 |
| 08.270.1000.803 | 270054 | 8 | 08.270.1000.813 | 81.30301.0445 | 23;43 |
| 08.270.1000.803 | 755 079 | 8 | 08.270.1000.813 | 81.30301.0446 | 23;43 |
| 08.270.1000.811 | K 18035 | 12;34 | 08.270.1000.813 | 81.30301.0466 | 23;43 |
| 08.270.1000.811 | 000 250 32 03 | 12;34 | 08.270.1000.813 | 81.30301.0473 | 23;43 |
| 08.270.1000.811 | 000 250 91 03 | 12;34 | 08.270.1000.813 | 81.30301.0488 | 23;43 |
| 08.270.1000.811 | 001 250 02 03 | 12;34 | 08.270.1000.813 | 81.30301.0508 | 23;43 |
| 08.270.1000.811 | 001 250 27 03 | 12;34 | 08.270.1000.813 | 81.30301.0525 | 23;43 |
| 08.270.1000.811 | 001 250 57 03 | 12;34 | 08.270.1000.813 | 81.30301.0526 | 23;43 |
| 08.270.1000.811 | 001 250 97 03 | 12;34 | 08.270.1000.813 | 81.30301.0527 | 23;43 |
| 08.270.1000.811 | 002 250 13 03 | 12;34 | 08.270.1000.813 | 81.30301.9525 | 23;43 |
| 08.270.1000.811 | 002 250 14 03 | 12;34 | 08.270.1000.821 | 015 250 83 03 | 22;36 |
| 08.270.1000.811 | 004 250 90 03 | 12;34 | 08.270.1000.821 | 015 250 84 03 | 22;36 |

Vergleichsliste | Crosslist

aufsteigend nach ST-Nr. | ascending to ST-No.

| | | | | | |
|------------------------|---------------|-------------|------------------------|---------------|-------------|
| 08.270.1000.821 | 015 250 85 03 | 22;36 | 08.270.1000.831 | 019 250 04 03 | 22;23;36;37 |
| 08.270.1000.821 | 016 250 99 03 | 22;36 | 08.270.1000.831 | 020 250 97 03 | 22;23;36;37 |
| 08.270.1000.821 | 017 250 00 03 | 22;36 | 08.270.1000.831 | 0421.327.10 | 22;23;36;37 |
| 08.270.1000.821 | 017 250 04 03 | 22;36 | 08.270.1000.831 | 10737529 | 22;23;36;37 |
| 08.270.1000.821 | 017 250 13 03 | 22;36 | 08.270.1000.831 | 10739529 | 22;23;36;37 |
| 08.270.1000.821 | 018 250 85 03 | 22;36 | 08.270.1000.831 | 11010005 | 22;23;36;37 |
| 08.270.1000.821 | 019 250 53 03 | 22;36 | 08.270.1000.831 | 1862 226 131 | 22;23;36;37 |
| 08.270.1000.821 | 019 250 59 03 | 22;36 | 08.270.1000.831 | 1862 226 346 | 22;23;36;37 |
| 08.270.1000.821 | 020 250 93 03 | 22;36 | 08.270.1000.831 | 1862 226 511 | 22;23;36;37 |
| 08.270.1000.821 | 10696404 | 22;36 | 08.270.1000.831 | 1862 418 031 | 22;23;36;37 |
| 08.270.1000.821 | 1862 193 139 | 22;36 | 08.270.1000.831 | 1862 494 031 | 22;23;36;37 |
| 08.270.1000.821 | 1862 540 031 | 22;36 | 08.270.1000.831 | 1878 000 055 | 22;23;36;37 |
| 08.270.1000.821 | 1878 002 023 | 22;36 | 08.270.1000.831 | 1878 031 002 | 22;23;36;37 |
| 08.270.1000.821 | 1878 003 031 | 22;36 | 08.270.1000.831 | 1878 031 032 | 22;23;36;37 |
| 08.270.1000.821 | 1878 042 331 | 22;36 | 08.270.1000.831 | 1878 031 048 | 22;23;36;37 |
| 08.270.1000.821 | 1878 056 431 | 22;36 | 08.270.1000.831 | 1878 037 831 | 22;23;36;37 |
| 08.270.1000.821 | 1878 056 432 | 22;36 | 08.270.1000.831 | 1878 037 854 | 22;23;36;37 |
| 08.270.1000.823 | 1878 003 868 | 50 | 08.270.1000.831 | 1878 080 031 | 22;23;36;37 |
| 08.270.1000.823 | 20 484 468 | 50 | 08.270.1000.831 | 81.30000.6587 | 22;23;36;37 |
| 08.270.1000.823 | 20 566 389 | 50 | 08.270.1000.831 | 81.30000.6600 | 22;23;36;37 |
| 08.270.1000.823 | 7420 725 523 | 50 | 08.270.1000.831 | 81.30301.0353 | 22;23;36;37 |
| 08.270.1000.831 | 009 250 19 03 | 22;23;36;37 | 08.270.1000.831 | 81.30301.0377 | 22;23;36;37 |
| 08.270.1000.831 | 011 250 30 03 | 22;23;36;37 | 08.270.1000.831 | 81.30301.0438 | 22;23;36;37 |
| 08.270.1000.831 | 012 250 58 03 | 22;23;36;37 | 08.270.1000.831 | 81.30301.0456 | 22;23;36;37 |
| 08.270.1000.831 | 013 250 13 03 | 22;23;36;37 | 08.270.1000.831 | 81.30301.0457 | 22;23;36;37 |
| 08.270.1000.831 | 013 250 14 03 | 22;23;36;37 | 08.270.1000.831 | 81.30301.0463 | 22;23;36;37 |
| 08.270.1000.831 | 013 250 18 03 | 22;23;36;37 | 08.270.1000.831 | 81.30301.0497 | 22;23;36;37 |
| 08.270.1000.831 | 013 250 25 03 | 22;23;36;37 | 08.270.1000.831 | 81.30301.0498 | 22;23;36;37 |
| 08.270.1000.831 | 013 250 27 03 | 22;23;36;37 | 08.270.1000.831 | 81.30301.9377 | 22;23;36;37 |
| 08.270.1000.831 | 013 250 42 03 | 22;23;36;37 | 08.270.1000.831 | 81.30301.9438 | 22;23;36;37 |
| 08.270.1000.831 | 015 250 39 03 | 22;23;36;37 | 08.270.1000.831 | 81.30301.9457 | 22;23;36;37 |
| 08.270.1000.831 | 015 250 40 03 | 22;23;36;37 | 08.270.1000.833 | 1669 141 | 60 |
| 08.270.1000.831 | 016 250 07 03 | 22;23;36;37 | 08.270.1000.833 | 1862 415 031 | 60 |
| 08.270.1000.831 | 016 250 08 03 | 22;23;36;37 | 08.270.1000.833 | 8112 600 | 60 |
| 08.270.1000.831 | 016 250 12 03 | 22;23;36;37 | 08.270.1000.841 | 1862 379 031 | 49 |
| 08.270.1000.831 | 016 250 13 03 | 22;23;36;37 | 08.270.1000.841 | 5000 677 165 | 49 |
| 08.270.1000.831 | 016 250 25 03 | 22;23;36;37 | 08.270.1000.841 | 5000 677 295 | 49 |
| 08.270.1000.831 | 016 250 26 03 | 22;23;36;37 | 08.270.1000.843 | 1668 375 | 60 |
| 08.270.1000.831 | 016 250 29 03 | 22;23;36;37 | 08.270.1000.843 | 1668 675 | 60 |
| 08.270.1000.831 | 016 250 47 03 | 22;23;36;37 | 08.270.1000.843 | 1669 142 | 60 |
| 08.270.1000.831 | 017 250 85 03 | 22;23;36;37 | 08.270.1000.843 | 1862 248 033 | 60 |
| 08.270.1000.831 | 017 250 90 03 | 22;23;36;37 | 08.270.1000.843 | 8112 601 | 60 |

aufsteigend nach ST-Nr. | ascending to ST-No.

| | | | | | |
|------------------------|---------------|-------------------|------------------------|---------------|-------------------|
| 08.270.1000.851 | 1862 441 031 | 23 | 08.270.1000.881 | 1862 217 335 | 14;23;24;37;43;50 |
| 08.270.1000.851 | 1862 441 131 | 23 | 08.270.1000.881 | 1862 217 337 | 14;23;24;37;43;50 |
| 08.270.1000.851 | 81.30301.0355 | 23 | 08.270.1000.881 | 1878 001 030 | 14;23;24;37;43;50 |
| 08.270.1000.851 | 81.30301.0364 | 23 | 08.270.1000.881 | 1878 023 731 | 14;23;24;37;43;50 |
| 08.270.1000.851 | 81.30301.0376 | 23 | 08.270.1000.881 | 1878 037 834 | 14;23;24;37;43;50 |
| 08.270.1000.851 | 81.30301.0381 | 23 | 08.270.1000.881 | 1878 037 838 | 14;23;24;37;43;50 |
| 08.270.1000.851 | 81.30301.0382 | 23 | 08.270.1000.881 | 1878 080 035 | 14;23;24;37;43;50 |
| 08.270.1000.851 | 81.30301.0385 | 23 | 08.270.1000.881 | 4202 2207 E64 | 14;23;24;37;43;50 |
| 08.270.1000.851 | 81.30301.0386 | 23 | 08.270.1000.881 | 5001 866 621 | 14;23;24;37;43;50 |
| 08.270.1000.851 | 81.30301.0388 | 23 | 08.270.1000.881 | 5010 244 303 | 14;23;24;37;43;50 |
| 08.270.1000.851 | 81.30301.9381 | 23 | 08.270.1000.881 | 5010 244 325 | 14;23;24;37;43;50 |
| 08.270.1000.851 | 81.30301.9386 | 23 | 08.270.1000.881 | 5010 245 455 | 14;23;24;37;43;50 |
| 08.270.1000.853 | 1655 878 | 61 | 08.270.1000.881 | 5010 545 038 | 14;23;24;37;43;50 |
| 08.270.1000.853 | 1655 879 | 61 | 08.270.1000.881 | 5010 545 829 | 14;23;24;37;43;50 |
| 08.270.1000.853 | 1668 677 | 61 | 08.270.1000.881 | 5010 613 657 | 14;23;24;37;43;50 |
| 08.270.1000.853 | 1668 678 | 61 | 08.270.1000.881 | 81.30301.0217 | 14;23;24;37;43;50 |
| 08.270.1000.853 | 1668 981 | 61 | 08.270.1000.881 | 81.30301.0218 | 14;23;24;37;43;50 |
| 08.270.1000.853 | 1668 982 | 61 | 08.270.1000.881 | 81.30301.0219 | 14;23;24;37;43;50 |
| 08.270.1000.853 | 1862 152 031 | 61 | 08.270.1000.881 | 81.30301.0220 | 14;23;24;37;43;50 |
| 08.270.1000.853 | 1862 153 031 | 61 | 08.270.1000.881 | 81.30301.0222 | 14;23;24;37;43;50 |
| 08.270.1000.853 | 1878 087 241 | 61 | 08.270.1000.881 | 81.30301.0223 | 14;23;24;37;43;50 |
| 08.270.1000.853 | 8112 127 | 61 | 08.270.1000.881 | 81.30301.0224 | 14;23;24;37;43;50 |
| 08.270.1000.853 | 8112 128 | 61 | 08.270.1000.881 | 81.30301.0225 | 14;23;24;37;43;50 |
| 08.270.1000.861 | 1 335 282 | 55 | 08.270.1000.881 | 81.30301.0256 | 14;23;24;37;43;50 |
| 08.270.1000.861 | 1 355 282 | 55 | 08.270.1000.881 | 81.30301.0257 | 14;23;24;37;43;50 |
| 08.270.1000.861 | 1862 450 031 | 55 | 08.270.1000.881 | 81.30301.0258 | 14;23;24;37;43;50 |
| 08.270.1000.861 | 571 223 | 55 | 08.270.1000.881 | 81.30301.0289 | 14;23;24;37;43;50 |
| 08.270.1000.881 | 018 250 80 03 | 14;23;24;37;43;50 | 08.270.1000.881 | 81.30301.0322 | 14;23;24;37;43;50 |
| 08.270.1000.881 | 0421.324.00 | 14;23;24;37;43;50 | 08.270.1000.881 | 81.30301.0323 | 14;23;24;37;43;50 |
| 08.270.1000.881 | 1028 8617 | 14;23;24;37;43;50 | 08.270.1000.881 | 81.30301.0325 | 14;23;24;37;43;50 |
| 08.270.1000.881 | 11009997 | 14;23;24;37;43;50 | 08.270.1000.881 | 81.30301.0326 | 14;23;24;37;43;50 |
| 08.270.1000.881 | 1101 0000 | 14;23;24;37;43;50 | 08.270.1000.881 | 81.30301.0327 | 14;23;24;37;43;50 |
| 08.270.1000.881 | 11060226 | 14;23;24;37;43;50 | 08.270.1000.881 | 81.30301.0360 | 14;23;24;37;43;50 |
| 08.270.1000.881 | 11079830 | 14;23;24;37;43;50 | 08.270.1000.881 | 81.30301.0366 | 14;23;24;37;43;50 |
| 08.270.1000.881 | 130-210-4361 | 14;23;24;37;43;50 | 08.270.1000.881 | 81.30301.0369 | 14;23;24;37;43;50 |
| 08.270.1000.881 | 130-210-4381 | 14;23;24;37;43;50 | 08.270.1000.881 | 81.30301.0383 | 14;23;24;37;43;50 |
| 08.270.1000.881 | 1862 108 031 | 14;23;24;37;43;50 | 08.270.1000.881 | 81.30301.0390 | 14;23;24;37;43;50 |
| 08.270.1000.881 | 1862 108 034 | 14;23;24;37;43;50 | 08.270.1000.881 | 81.30301.0391 | 14;23;24;37;43;50 |
| 08.270.1000.881 | 1862 109 034 | 14;23;24;37;43;50 | 08.270.1000.881 | 81.30301.0402 | 14;23;24;37;43;50 |
| 08.270.1000.881 | 1862 217 032 | 14;23;24;37;43;50 | 08.270.1000.881 | 81.30301.0407 | 14;23;24;37;43;50 |
| 08.270.1000.881 | 1862 217 033 | 14;23;24;37;43;50 | 08.270.1000.881 | 81.30301.0408 | 14;23;24;37;43;50 |
| 08.270.1000.881 | 1862 217 235 | 14;23;24;37;43;50 | 08.270.1000.881 | 81.30301.0419 | 14;23;24;37;43;50 |

Vergleichsliste | Crosslist

aufsteigend nach ST-Nr. | ascending to ST-No.

| | | | | | |
|------------------------|---------------|-------------------|------------------------|---------------|----------|
| 08.270.1000.881 | 81.30301.0441 | 14;23;24;37;43;50 | 08.270.1000.903 | 81.30301.0240 | 22 |
| 08.270.1000.881 | 81.30301.0464 | 14;23;24;37;43;50 | 08.270.1000.903 | 81.30301.0241 | 22 |
| 08.270.1000.881 | 81.30301.0501 | 14;23;24;37;43;50 | 08.270.1000.903 | 81.30301.0295 | 22 |
| 08.270.1000.881 | 81.30301.0502 | 14;23;24;37;43;50 | 08.270.1000.903 | 81.30301.0318 | 22 |
| 08.270.1000.881 | 81.30301.0504 | 14;23;24;37;43;50 | 08.270.1000.903 | 81.30301.0319 | 22 |
| 08.270.1000.881 | 81.30301.0505 | 14;23;24;37;43;50 | 08.270.1000.903 | 81.30301.0320 | 22 |
| 08.270.1000.881 | 81.30301.0521 | 14;23;24;37;43;50 | 08.270.1000.903 | 81.30301.0347 | 22 |
| 08.270.1000.881 | 81.30301.0569 | 14;23;24;37;43;50 | 08.270.1000.903 | 81.30301.0351 | 22 |
| 08.270.1000.881 | 81.30301.9322 | 14;23;24;37;43;50 | 08.270.1000.903 | 81.30301.0371 | 22 |
| 08.270.1000.881 | 81.30301.9325 | 14;23;24;37;43;50 | 08.270.1000.903 | 81.30301.0455 | 22 |
| 08.270.1000.881 | 81.30301.9327 | 14;23;24;37;43;50 | 08.270.1000.903 | 81.30301.9351 | 22 |
| 08.270.1000.881 | 81.30301.9360 | 14;23;24;37;43;50 | 08.270.1000.911 | 1862 317 032 | 13 |
| 08.270.1000.881 | 81.30301.9402 | 14;23;24;37;43;50 | 08.270.1000.911 | 4210 2970 | 13 |
| 08.270.1000.881 | 81.30301.9569 | 14;23;24;37;43;50 | 08.270.1000.911 | 4210 4649 | 13 |
| 08.270.1000.881 | 99707793317 | 14;23;24;37;43;50 | 08.270.1000.911 | 4211 2970 | 13 |
| 08.270.1000.891 | 1527 519 | 61 | 08.270.1000.911 | 9843 6159 | 13 |
| 08.270.1000.891 | 1527 521 | 61 | 08.270.1000.911 | 9849 5998 | 13 |
| 08.270.1000.891 | 1655 677 | 61 | 08.270.1000.911 | 9849 9254 | 13 |
| 08.270.1000.891 | 1655 678 | 61 | 08.270.1000.911 | 9943 0263 | 13 |
| 08.270.1000.891 | 1667 256 | 61 | 08.270.1000.912 | 1-31240-905-0 | 49 |
| 08.270.1000.891 | 1861 988 032 | 61 | 08.270.1000.912 | 1862 303 031 | 49 |
| 08.270.1000.891 | 1861 988 033 | 61 | 08.270.1000.912 | 1862 379 032 | 49 |
| 08.270.1000.891 | 1861 988 037 | 61 | 08.270.1000.912 | 5010 452 026 | 49 |
| 08.270.1000.891 | 1861 988 040 | 61 | 08.270.1000.912 | 632 101 600 | 49 |
| 08.270.1000.891 | 8112 106 | 61 | 08.270.1000.912 | 81.30301.0299 | 49 |
| 08.270.1000.891 | 8112 107 | 61 | 08.270.1000.921 | 1521 246 | 61 |
| 08.270.1000.891 | 8112 149 | 61 | 08.270.1000.921 | 1668 667 | 61 |
| 08.270.1000.891 | 8112 159 | 61 | 08.270.1000.921 | 1862 349 031 | 61 |
| 08.270.1000.901 | 0190 4785 | 13;14 | 08.270.1000.921 | 8112 340 | 61 |
| 08.270.1000.901 | 1862 317 031 | 13;14 | 08.270.1000.931 | 1862 157 034 | 22 |
| 08.270.1000.901 | 4210 2168 | 13;14 | 08.270.1000.931 | 1862 157 037 | 22 |
| 08.270.1000.901 | 4210 3321 | 13;14 | 08.270.1000.931 | 1862 364 031 | 22 |
| 08.270.1000.901 | 4210 4991 | 13;14 | 08.270.1000.931 | 81.30301.0242 | 22 |
| 08.270.1000.901 | 9849 5997 | 13;14 | 08.270.1000.931 | 81.30301.0243 | 22 |
| 08.270.1000.901 | 9943 0262 | 13;14 | 08.270.1000.931 | 81.30301.0244 | 22 |
| 08.270.1000.903 | 1862 251 032 | 22 | 08.270.1000.931 | 81.30301.0245 | 22 |
| 08.270.1000.903 | 1862 364 032 | 22 | 08.270.1000.931 | 81.30301.0328 | 22 |
| 08.270.1000.903 | 1862 364 133 | 22 | 08.270.1000.931 | 81.30301.0329 | 22 |
| 08.270.1000.903 | 1862 387 031 | 22 | 08.270.1000.931 | 81.30301.0346 | 22 |
| 08.270.1000.903 | 1878 000 650 | 22 | 08.270.1000.931 | 81.30301.9329 | 22 |
| 08.270.1000.903 | 81.30301.0238 | 22 | 08.270.1000.931 | 81.30301.9346 | 22 |
| 08.270.1000.903 | 81.30301.0239 | 22 | 08.270.1000.941 | 003 250 95 03 | 21;35;48 |

aufsteigend nach ST-Nr. | ascending to ST-No.

| | | | | | |
|------------------------|-----------------|-------------|------------------------|----------------|-------------|
| 08.270.1000.941 | 004 250 52 03 | 21;35;48 | 08.270.1000.951 | 1667 929 | 21;35;48;60 |
| 08.270.1000.941 | 010 250 14 03 | 21;35;48 | 08.270.1000.951 | 1861 584 036 | 21;35;48;60 |
| 08.270.1000.941 | 010 250 22 03 | 21;35;48 | 08.270.1000.951 | 1861 584 110 | 21;35;48;60 |
| 08.270.1000.941 | 01174189 | 21;35;48 | 08.270.1000.951 | 1861 584 137 | 21;35;48;60 |
| 08.270.1000.941 | 1861 488 108 | 21;35;48 | 08.270.1000.951 | 1861 699 104 | 21;35;48;60 |
| 08.270.1000.941 | 1861 488 133 | 21;35;48 | 08.270.1000.951 | 1861 699 131 | 21;35;48;60 |
| 08.270.1000.941 | 1861 488 140 | 21;35;48 | 08.270.1000.951 | 1861 699 135 | 21;35;48;60 |
| 08.270.1000.941 | 1861 488 233 | 21;35;48 | 08.270.1000.951 | 1861 699 136 | 21;35;48;60 |
| 08.270.1000.941 | 1861 585 005 | 21;35;48 | 08.270.1000.951 | 1861 699 137 | 21;35;48;60 |
| 08.270.1000.941 | 1861 591 035 | 21;35;48 | 08.270.1000.951 | 1861 699 138 | 21;35;48;60 |
| 08.270.1000.941 | 1861 591 036 | 21;35;48 | 08.270.1000.951 | 1861 863 201 | 21;35;48;60 |
| 08.270.1000.941 | 1861 591 037 | 21;35;48 | 08.270.1000.951 | 1861 863 232 | 21;35;48;60 |
| 08.270.1000.941 | 1861 591 038 | 21;35;48 | 08.270.1000.951 | 1878 000 968 | 21;35;48;60 |
| 08.270.1000.941 | 1861 862 233 | 21;35;48 | 08.270.1000.951 | 632 100 380 | 21;35;48;60 |
| 08.270.1000.941 | 1878 000 964 | 21;35;48 | 08.270.1000.951 | 632 101 220 | 21;35;48;60 |
| 08.270.1000.941 | 1961 848 032 | 21;35;48 | 08.270.1000.951 | 8112 124 | 21;35;48;60 |
| 08.270.1000.941 | 5000 289 010 | 21;35;48 | 08.270.1000.951 | 81.30301.0235 | 21;35;48;60 |
| 08.270.1000.941 | 5031-319 | 21;35;48 | 08.270.1000.951 | 81.30301.0314 | 21;35;48;60 |
| 08.270.1000.941 | 81.30301.0121 | 21;35;48 | 08.270.1000.951 | 81.30301.9314 | 21;35;48;60 |
| 08.270.1000.941 | 81.30301.0150 | 21;35;48 | 08.270.1000.951 | 8.383.225.000 | 21;35;48;60 |
| 08.270.1000.941 | 81.30301.0169 | 21;35;48 | 08.270.1000.951 | 8.383.262.000 | 21;35;48;60 |
| 08.270.1000.941 | 81.30301.0263 | 21;35;48 | 08.270.1000.951 | 8406-404 | 21;35;48;60 |
| 08.270.1000.941 | 81.30301.0308 | 21;35;48 | 08.270.1000.951 | 8407-439 | 21;35;48;60 |
| 08.270.1000.941 | 81.30301.0337 | 21;35;48 | 08.270.1000.951 | 991.14.16.0007 | 21;35;48;60 |
| 08.270.1000.941 | 81.30301.1008 | 21;35;48 | 08.270.1000.951 | 991.14.16.0032 | 21;35;48;60 |
| 08.270.1000.941 | 81.30301.9121 | 21;35;48 | 08.270.1000.961 | 1521 717 | 61 |
| 08.270.1000.941 | 81.30301.9150 | 21;35;48 | 08.270.1000.961 | 1878 002 437 | 61 |
| 08.270.1000.941 | 81.30301.9263 | 21;35;48 | 08.270.1000.961 | 1878 032 131 | 61 |
| 08.270.1000.941 | 81.30301.9337 | 21;35;48 | 08.270.1000.961 | 1878 032 133 | 61 |
| 08.270.1000.941 | 8433035 | 21;35;48 | 08.270.1000.961 | 503135208 | 61 |
| 08.270.1000.951 | 000250201001-00 | 21;35;48;60 | 08.270.1000.961 | 8113 468 | 61 |
| 08.270.1000.951 | 004 250 96 03 | 21;35;48;60 | 08.270.1000.961 | 8113 947 | 61 |
| 08.270.1000.951 | 005 250 93 03 | 21;35;48;60 | 08.270.1000.961 | 8171 496 | 61 |
| 08.270.1000.951 | 008 250 79 03 | 21;35;48;60 | 08.270.1000.971 | 015 250 98 03 | 38 |
| 08.270.1000.951 | 008 250 80 03 | 21;35;48;60 | 08.270.1000.971 | 015 250 99 03 | 38 |
| 08.270.1000.951 | 008 250 81 03 | 21;35;48;60 | 08.270.1000.971 | 016 250 00 03 | 38 |
| 08.270.1000.951 | 010 250 74 03 | 21;35;48;60 | 08.270.1000.971 | 016 250 01 03 | 38 |
| 08.270.1000.951 | 01.23.124 | 21;35;48;60 | 08.270.1000.971 | 016 250 03 03 | 38 |
| 08.270.1000.951 | 0267 446 | 21;35;48;60 | 08.270.1000.971 | 016 250 04 03 | 38 |
| 08.270.1000.951 | 0401.115.01 | 21;35;48;60 | 08.270.1000.971 | 016 250 05 03 | 38 |
| 08.270.1000.951 | 0421.306.00 | 21;35;48;60 | 08.270.1000.971 | 017 250 67 03 | 38 |
| 08.270.1000.951 | 0890-633 | 21;35;48;60 | 08.270.1000.971 | 017 250 68 03 | 38 |

Vergleichsliste | Crosslist

aufsteigend nach ST-Nr. | ascending to ST-No.

| | | | | | |
|------------------------|---------------|-------|------------------------|---------------|----|
| 08.270.1000.971 | 017 250 69 03 | 38 | 08.270.3003.600 | 1 444 110 | 55 |
| 08.270.1000.971 | 019 250 55 03 | 38 | 08.270.3003.600 | 1 510 032 | 55 |
| 08.270.1000.971 | 019 250 58 03 | 38 | 08.270.3003.600 | 1 749 123 | 55 |
| 08.270.1000.971 | 020 250 19 03 | 38 | 08.270.3003.600 | 1862 326 032 | 55 |
| 08.270.1000.971 | 020 250 44 03 | 38 | 08.270.3003.600 | 1862 461 031 | 55 |
| 08.270.1000.971 | 020 250 46 03 | 38 | 08.270.3003.600 | 1862 461 132 | 55 |
| 08.270.1000.971 | 020 250 89 03 | 38 | 08.270.3003.600 | 1878 003 066 | 55 |
| 08.270.1000.971 | 1862 529 032 | 38 | 08.270.3003.600 | 1878 037 631 | 55 |
| 08.270.1000.971 | 1878 000 117 | 38 | 08.270.3003.600 | 1878 063 231 | 55 |
| 08.270.1000.971 | 1878 002 732 | 38 | 08.270.3003.600 | 571 256 | 55 |
| 08.270.1000.981 | 010 250 57 03 | 37 | 08.270.3003.600 | 571 268 | 55 |
| 08.270.1000.981 | 010 250 58 03 | 37 | 08.270.3003.600 | 571 271 | 55 |
| 08.270.1000.981 | 013 250 74 03 | 37 | 08.270.3003.600 | 571 283 | 55 |
| 08.270.1000.981 | 013 250 79 03 | 37 | 08.270.3003.600 | 571 284 | 55 |
| 08.270.1000.981 | 013 250 87 03 | 37 | 08.270.3003.600 | 571 292 | 55 |
| 08.270.1000.981 | 013 250 88 03 | 37 | 08.270.3003.600 | 571 295 | 55 |
| 08.270.1000.981 | 014 250 76 03 | 37 | 08.270.3003.600 | 571 300 | 55 |
| 08.270.1000.981 | 014 250 77 03 | 37 | 08.270.3003.600 | 571 305 | 55 |
| 08.270.1000.981 | 014 250 78 03 | 37 | 08.270.3003.610 | 1 101 588 | 55 |
| 08.270.1000.981 | 015 250 24 03 | 37 | 08.270.3003.610 | 1 304 781 | 55 |
| 08.270.1000.981 | 016 250 40 03 | 37 | 08.270.3003.610 | 1 318 603 | 55 |
| 08.270.1000.981 | 016 250 41 03 | 37 | 08.270.3003.610 | 1 367 172 | 55 |
| 08.270.1000.981 | 016 250 42 03 | 37 | 08.270.3003.610 | 1 387 021 | 55 |
| 08.270.1000.981 | 016 250 50 03 | 37 | 08.270.3003.610 | 1862 176 033 | 55 |
| 08.270.1000.981 | 1862 453 031 | 37 | 08.270.3003.610 | 1862 176 034 | 55 |
| 08.270.1000.981 | 1878 000 116 | 37 | 08.270.3003.610 | 1862 177 001 | 55 |
| 08.270.1000.981 | 1878 002 735 | 37 | 08.270.3003.610 | 1878 062 944 | 55 |
| 08.270.1000.991 | 015 250 46 03 | 35;36 | 08.270.3003.610 | 364 378 | 55 |
| 08.270.1000.991 | 015 250 63 03 | 35;36 | 08.270.3003.610 | 369 849 | 55 |
| 08.270.1000.991 | 020 250 00 03 | 35;36 | 08.270.3003.610 | 571 254 | 55 |
| 08.270.1000.991 | 021 250 66 03 | 35;36 | 08.270.3003.610 | 571 282 | 55 |
| 08.270.1000.991 | 1878 023 831 | 35;36 | 08.270.3003.610 | 571 285 | 55 |
| 08.270.3003.600 | 1 111 148 | 55 | 08.270.3003.610 | 571 288 | 55 |
| 08.270.3003.600 | 1 210 032 | 55 | 08.270.3003.610 | 571 290 | 55 |
| 08.270.3003.600 | 1 321 253 | 55 | 08.280.1922.000 | 385 268 14 74 | 66 |
| 08.270.3003.600 | 1 321 258 | 55 | 08.290.0909.2 S | 81.30560.6019 | 66 |
| 08.270.3003.600 | 1 324 883 | 55 | 08.290.0909.2 S | 81.30560.6022 | 66 |
| 08.270.3003.600 | 1 340 192 | 55 | 08.290.0909.20S | 81.30560.6019 | 66 |
| 08.270.3003.600 | 1 368 697 | 55 | 08.290.0909.20S | 81.30560.6022 | 66 |
| 08.270.3003.600 | 1 386 931 | 55 | 08.290.0909.300 | 81.30560.0057 | 65 |
| 08.270.3003.600 | 1 409 769 | 55 | 08.290.0909.300 | 81.30560.0063 | 65 |
| 08.270.3003.600 | 1 412 319 | 55 | 08.290.0909.310 | 81.32411.0006 | 65 |

aufsteigend nach ST-Nr. | ascending to ST-No.

| | | | | | |
|------------------------|-----------------|---------|------------------------|---------------|---------------|
| 08.290.0909.310 | 81.32411.0007 | 65 | 08.290.7000.000 | 81.30550.0106 | 9;24;25 |
| 08.290.1002.000 | 650 254 00 06 | 65 | 08.290.7000.000 | 81.30550.0107 | 9;24;25 |
| 08.290.1002.010 | 650 250 00 13 | 65 | 08.290.7000.000 | 81.30550.0109 | 9;24;25 |
| 08.290.1002.010 | 650 250 31 13 | 65 | 08.290.7000.000 | 81.30550.0110 | 9;24;25 |
| 08.290.1002.010 | 650 250 38 13 | 65 | 08.290.7000.000 | 81.30550.0116 | 9;24;25 |
| 08.290.1002.030 | 655 250 15 13 | 65 | 08.290.7000.010 | 1655 732 | 63;64 |
| 08.290.1002.060 | 655 254 02 06 | 65;66 | 08.290.7000.010 | 1655 825 | 63;64 |
| 08.290.1928.1 S | 385 250 00 14 | 66 | 08.290.7000.010 | 1667 258 | 63;64 |
| 08.290.1933.1 S | 363 250 01 14 | 66 | 08.290.7000.010 | 1668 923 | 63;64 |
| 08.290.1941.060 | 912009 037200 | 72 | 08.290.7000.010 | 1669 833 | 63;64 |
| 08.290.1941.1 S | 620 250 02 14 | 66;67 | 08.290.7000.010 | 1672 946 | 63;64 |
| 08.290.1941.3 S | 655 254 02 06 S | 67 | 08.290.7000.010 | 20 571 928 | 63;64 |
| 08.290.1941.30S | 655 254 02 06 S | 67 | 08.290.7000.010 | 3100 002 112 | 63;64 |
| 08.290.1942.1 S | 650 254 00 06 S | 67 | 08.290.7000.010 | 3100 002 118 | 63;64 |
| 08.290.7000.000 | 10628942 | 9;24;25 | 08.290.7000.010 | 3100 002 218 | 63;64 |
| 08.290.7000.000 | 109 458 03 | 9;24;25 | 08.290.7000.010 | 3100 002 220 | 63;64 |
| 08.290.7000.000 | 109 960 15 | 9;24;25 | 08.290.7000.010 | 3100 026 433 | 63;64 |
| 08.290.7000.000 | 1250 710 | 9;24;25 | 08.290.7000.010 | 3192 223 | 63;64 |
| 08.290.7000.000 | 1303 975 | 9;24;25 | 08.290.7000.010 | 8112 159 | 63;64 |
| 08.290.7000.000 | 130-510-0021 | 9;24;25 | 08.290.7000.020 | 000 254 30 08 | 9;15;25;40;51 |
| 08.290.7000.000 | 1362 752 | 9;24;25 | 08.290.7000.020 | 0180 5282 | 9;15;25;40;51 |
| 08.290.7000.000 | 1664 346 | 9;24;25 | 08.290.7000.020 | 0190 4756 | 9;15;25;40;51 |
| 08.290.7000.000 | 31230-1150A | 9;24;25 | 08.290.7000.020 | 0190 4779 | 9;15;25;40;51 |
| 08.290.7000.000 | 3151 000 034 | 9;24;25 | 08.290.7000.020 | 0190 4785 | 9;15;25;40;51 |
| 08.290.7000.000 | 3151 169 031 | 9;24;25 | 08.290.7000.020 | 0190 4796 | 9;15;25;40;51 |
| 08.290.7000.000 | 3151 169 131 | 9;24;25 | 08.290.7000.020 | 0190 5282 | 9;15;25;40;51 |
| 08.290.7000.000 | 3151 169 232 | 9;24;25 | 08.290.7000.020 | 0190 8508 | 9;15;25;40;51 |
| 08.290.7000.000 | 3151 169 332 | 9;24;25 | 08.290.7000.020 | 0190 8518 | 9;15;25;40;51 |
| 08.290.7000.000 | 3151 273 431 | 9;24;25 | 08.290.7000.020 | 0190 8524 | 9;15;25;40;51 |
| 08.290.7000.000 | 503118408 | 9;24;25 | 08.290.7000.020 | 0299 2486 | 9;15;25;40;51 |
| 08.290.7000.000 | 5618023 | 9;24;25 | 08.290.7000.020 | 12 3157 | 9;15;25;40;51 |
| 08.290.7000.000 | 632 101 620 | 9;24;25 | 08.290.7000.020 | 1-31310-011-0 | 9;15;25;40;51 |
| 08.290.7000.000 | 81.30000.6587 | 9;24;25 | 08.290.7000.020 | 1615 927 | 9;15;25;40;51 |
| 08.290.7000.000 | 81.30000.6600 | 9;24;25 | 08.290.7000.020 | 1634 627 | 9;15;25;40;51 |
| 08.290.7000.000 | 81.30550.0063 | 9;24;25 | 08.290.7000.020 | 3151 000 144 | 9;15;25;40;51 |
| 08.290.7000.000 | 81.30550.0067 | 9;24;25 | 08.290.7000.020 | 3151 203 031 | 9;15;25;40;51 |
| 08.290.7000.000 | 81.30550.0071 | 9;24;25 | 08.290.7000.020 | 3151 225 001 | 9;15;25;40;51 |
| 08.290.7000.000 | 81.30550.0073 | 9;24;25 | 08.290.7000.020 | 3151 225 031 | 9;15;25;40;51 |
| 08.290.7000.000 | 81.30550.0077 | 9;24;25 | 08.290.7000.020 | 36.30550.0001 | 9;15;25;40;51 |
| 08.290.7000.000 | 81.30550.0087 | 9;24;25 | 08.290.7000.020 | 4210 2103 | 9;15;25;40;51 |
| 08.290.7000.000 | 81.30550.0088 | 9;24;25 | 08.290.7000.020 | 4210 4476 | 9;15;25;40;51 |
| 08.290.7000.000 | 81.30550.0094 | 9;24;25 | 08.290.7000.020 | 4211 4856 | 9;15;25;40;51 |

Vergleichsliste | Crosslist

aufsteigend nach ST-Nr. | ascending to ST-No.

| | | | | | |
|------------------------|----------------|---------------|------------------------|------------------|------------|
| 08.290.7000.020 | 4254 3362 | 9;15;25;40;51 | 08.290.7000.050 | 3151 272 631 | 39 |
| 08.290.7000.020 | 4255 6650 | 9;15;25;40;51 | 08.290.7000.060 | AL 16333 | 9;14;24;51 |
| 08.290.7000.020 | 500 305 439 | 9;15;25;40;51 | 08.290.7000.060 | EXATRA081 | 9;14;24;51 |
| 08.290.7000.020 | 500 317 617 | 9;15;25;40;51 | 08.290.7000.060 | F281.100.100.010 | 9;14;24;51 |
| 08.290.7000.020 | 500 317 671 | 9;15;25;40;51 | 08.290.7000.060 | H199.104.100.010 | 9;14;24;51 |
| 08.290.7000.020 | 500 335 068 | 9;15;25;40;51 | 08.290.7000.060 | X4155253 | 9;14;24;51 |
| 08.290.7000.020 | 500 397 755 | 9;15;25;40;51 | 08.290.7000.060 | 0010 0128 | 9;14;24;51 |
| 08.290.7000.020 | 5001 858 682 | 9;15;25;40;51 | 08.290.7000.060 | 0126 1558 | 9;14;24;51 |
| 08.290.7000.020 | 5001 864 270 | 9;15;25;40;51 | 08.290.7000.060 | 0126 1558 | 9;14;24;51 |
| 08.290.7000.020 | 5001 873 287 | 9;15;25;40;51 | 08.290.7000.060 | 0139 8598 | 9;14;24;51 |
| 08.290.7000.020 | 500397755 | 9;15;25;40;51 | 08.290.7000.060 | 0244 0924 | 9;14;24;51 |
| 08.290.7000.020 | 504 120 865 | 9;15;25;40;51 | 08.290.7000.060 | 0292 2101 | 9;14;24;51 |
| 08.290.7000.020 | 504091142 | 9;15;25;40;51 | 08.290.7000.060 | 0342 8017 | 9;14;24;51 |
| 08.290.7000.020 | 657310-2 | 9;15;25;40;51 | 08.290.7000.060 | 0401.192.00 | 9;14;24;51 |
| 08.290.7000.020 | 81.30550.0096 | 9;15;25;40;51 | 08.290.7000.060 | 0477 4151 | 9;14;24;51 |
| 08.290.7000.020 | 81.30550.0101 | 9;15;25;40;51 | 08.290.7000.060 | 0478 7273 | 9;14;24;51 |
| 08.290.7000.020 | 81.30550.0102 | 9;15;25;40;51 | 08.290.7000.060 | 0890 238 | 9;14;24;51 |
| 08.290.7000.020 | 81.30550.0104 | 9;15;25;40;51 | 08.290.7000.060 | 0890-340 | 9;14;24;51 |
| 08.290.7000.020 | 9843 6188 | 9;15;25;40;51 | 08.290.7000.060 | 100128 | 9;14;24;51 |
| 08.290.7000.020 | 991.14.16.0033 | 9;15;25;40;51 | 08.290.7000.060 | 148 291 | 9;14;24;51 |
| 08.290.7000.020 | 99707010805 | 9;15;25;40;51 | 08.290.7000.060 | 1851 117 201 | 9;14;24;51 |
| 08.290.7000.030 | 000 250 42 15 | 38;44 | 08.290.7000.060 | 211 80 355 | 9;14;24;51 |
| 08.290.7000.030 | 000 250 46 15 | 38;44 | 08.290.7000.060 | 3151 023 101 | 9;14;24;51 |
| 08.290.7000.030 | 001 250 91 15 | 38;44 | 08.290.7000.060 | 3151 057 001 | 9;14;24;51 |
| 08.290.7000.030 | 001 250 93 15 | 38;44 | 08.290.7000.060 | 3151 057 002 | 9;14;24;51 |
| 08.290.7000.030 | 123311 | 38;44 | 08.290.7000.060 | 3151 066 002 | 9;14;24;51 |
| 08.290.7000.030 | 3151 044 031 | 38;44 | 08.290.7000.060 | 3151 066 032 | 9;14;24;51 |
| 08.290.7000.030 | 3151 602 003 | 38;44 | 08.290.7000.060 | 3151 157 001 | 9;14;24;51 |
| 08.290.7000.030 | 381 250 04 15 | 38;44 | 08.290.7000.060 | 3151 157 002 | 9;14;24;51 |
| 08.290.7000.040 | 1287 806 | 9 | 08.290.7000.060 | 3151 157 102 | 9;14;24;51 |
| 08.290.7000.040 | 1334 350 | 9 | 08.290.7000.060 | 3151 274 831 | 9;14;24;51 |
| 08.290.7000.040 | 212053 | 9 | 08.290.7000.060 | 345.100.100.020 | 9;14;24;51 |
| 08.290.7000.040 | 223810 | 9 | 08.290.7000.060 | 3630-0898-151 | 9;14;24;51 |
| 08.290.7000.040 | 3151 182 102 | 9 | 08.290.7000.060 | 4S2614A | 9;14;24;51 |
| 08.290.7000.040 | 3151 182 103 | 9 | 08.290.7000.060 | 4200 3823 | 9;14;24;51 |
| 08.290.7000.040 | 3151 182 203 | 9 | 08.290.7000.060 | 4200 3834 | 9;14;24;51 |
| 08.290.7000.040 | 3151 182 233 | 9 | 08.290.7000.060 | 5000 251 362 | 9;14;24;51 |
| 08.290.7000.050 | 000 250 70 15 | 39 | 08.290.7000.060 | 5000 456 367 | 9;14;24;51 |
| 08.290.7000.050 | 001 250 22 15 | 39 | 08.290.7000.060 | 5001 001 623 | 9;14;24;51 |
| 08.290.7000.050 | 0401.197.00 | 39 | 08.290.7000.060 | 5030-108 | 9;14;24;51 |
| 08.290.7000.050 | 3151 112 031 | 39 | 08.290.7000.060 | 5031-325 | 9;14;24;51 |
| 08.290.7000.050 | 3151 211 031 | 39 | 08.290.7000.060 | 503132508 | 9;14;24;51 |

aufsteigend nach ST-Nr. | ascending to ST-No.

| | | | | | |
|------------------------|----------------|------------|------------------------|-------------------|---------------|
| 08.290.7000.060 | 5160-52-16.10 | 9;14;24;51 | 08.290.7000.080 | 632 100 450 | 39;44 |
| 08.290.7000.060 | 525426014A00 | 9;14;24;51 | 08.290.7000.090 | ACHL257 | 9;14;24;51;63 |
| 08.290.7000.060 | 5291168 | 9;14;24;51 | 08.290.7000.090 | M408541 | 9;14;24;51;63 |
| 08.290.7000.060 | 5597401 | 9;14;24;51 | 08.290.7000.090 | X 86.0546.9087-09 | 9;14;24;51;63 |
| 08.290.7000.060 | 609 421.0 | 9;14;24;51 | 08.290.7000.090 | 0247 5546 | 9;14;24;51;63 |
| 08.290.7000.060 | 632 100 260 | 9;14;24;51 | 08.290.7000.090 | 0247 5547 | 9;14;24;51;63 |
| 08.290.7000.060 | 632 100 480 | 9;14;24;51 | 08.290.7000.090 | 0256 5803 | 9;14;24;51;63 |
| 08.290.7000.060 | 632 100 560 | 9;14;24;51 | 08.290.7000.090 | 0627 6678 | 9;14;24;51;63 |
| 08.290.7000.060 | 632 101 630 | 9;14;24;51 | 08.290.7000.090 | 1-2123-300-620.00 | 9;14;24;51;63 |
| 08.290.7000.060 | 651332 | 9;14;24;51 | 08.290.7000.090 | 1-2123-300-620.01 | 9;14;24;51;63 |
| 08.290.7000.060 | 658 418 | 9;14;24;51 | 08.290.7000.090 | 1267 988 | 9;14;24;51;63 |
| 08.290.7000.060 | 658 428 | 9;14;24;51 | 08.290.7000.090 | 1310 137 | 9;14;24;51;63 |
| 08.290.7000.060 | 81.30.550.0026 | 9;14;24;51 | 08.290.7000.090 | 1851 151 001 | 9;14;24;51;63 |
| 08.290.7000.060 | 81.30.550.0041 | 9;14;24;51 | 08.290.7000.090 | 279 810 | 9;14;24;51;63 |
| 08.290.7000.060 | 81.30.550.0050 | 9;14;24;51 | 08.290.7000.090 | 3151 015 101 | 9;14;24;51;63 |
| 08.290.7000.060 | 81.30.550.0072 | 9;14;24;51 | 08.290.7000.090 | 3151 015 301 | 9;14;24;51;63 |
| 08.290.7000.060 | 81.30.550.6019 | 9;14;24;51 | 08.290.7000.090 | 3151 015 332 | 9;14;24;51;63 |
| 08.290.7000.060 | 8.383.154.000 | 9;14;24;51 | 08.290.7000.090 | 3151 153 001 | 9;14;24;51;63 |
| 08.290.7000.060 | 990.00.21.0032 | 9;14;24;51 | 08.290.7000.090 | 3151 153 002 | 9;14;24;51;63 |
| 08.290.7000.060 | 990.00.21.0050 | 9;14;24;51 | 08.290.7000.090 | 3151 199 001 | 9;14;24;51;63 |
| 08.290.7000.070 | 001 250 05 15 | 40 | 08.290.7000.090 | 3151 199 002 | 9;14;24;51;63 |
| 08.290.7000.070 | 001 250 48 15 | 40 | 08.290.7000.090 | 352 193 | 9;14;24;51;63 |
| 08.290.7000.070 | 001 250 64 15 | 40 | 08.290.7000.090 | 4200 3396 | 9;14;24;51;63 |
| 08.290.7000.070 | 001 250 65 15 | 40 | 08.290.7000.090 | 4200 3397 | 9;14;24;51;63 |
| 08.290.7000.070 | 001 250 79 15 | 40 | 08.290.7000.090 | 4206 1921 | 9;14;24;51;63 |
| 08.290.7000.070 | 001 250 86 15 | 40 | 08.290.7000.090 | 5000 058 221 | 9;14;24;51;63 |
| 08.290.7000.070 | 001 250 98 15 | 40 | 08.290.7000.090 | 5000 240 864 | 9;14;24;51;63 |
| 08.290.7000.070 | 3151 185 031 | 40 | 08.290.7000.090 | 5000 613 650 | 9;14;24;51;63 |
| 08.290.7000.070 | 3151 242 031 | 40 | 08.290.7000.090 | 5000 677 075 | 9;14;24;51;63 |
| 08.290.7000.070 | 3151 246 031 | 40 | 08.290.7000.090 | 5000 809 155 | 9;14;24;51;63 |
| 08.290.7000.070 | 3151 602 004 | 40 | 08.290.7000.090 | 5001 866 623 | 9;14;24;51;63 |
| 08.290.7000.080 | 000 250 18 15 | 39;44 | 08.290.7000.090 | 5001 866 625 | 9;14;24;51;63 |
| 08.290.7000.080 | 000 250 19 15 | 39;44 | 08.290.7000.090 | 514 454 | 9;14;24;51;63 |
| 08.290.7000.080 | 000 250 25 15 | 39;44 | 08.290.7000.090 | 5516 021 267 | 9;14;24;51;63 |
| 08.290.7000.080 | 000 250 74 15 | 39;44 | 08.290.7000.090 | 5601009 | 9;14;24;51;63 |
| 08.290.7000.080 | 000 250 77 15 | 39;44 | 08.290.7000.090 | 600 80 256 | 9;14;24;51;63 |
| 08.290.7000.080 | 0890-591 | 39;44 | 08.290.7000.090 | 632 100 700 | 9;14;24;51;63 |
| 08.290.7000.080 | 11000033 | 39;44 | 08.290.7000.090 | 659 320 | 9;14;24;51;63 |
| 08.290.7000.080 | 2616014 | 39;44 | 08.290.7000.090 | 685611 | 9;14;24;51;63 |
| 08.290.7000.080 | 3151 000 375 | 39;44 | 08.290.7000.090 | 81.30.550.0044 | 9;14;24;51;63 |
| 08.290.7000.080 | 3151 027 131 | 39;44 | 08.290.7000.090 | 81.30.550.0060 | 9;14;24;51;63 |
| 08.290.7000.080 | 3151 602 002 | 39;44 | 08.290.7000.100 | 000 141 165 | 38 |

Vergleichsliste | Crosslist

aufsteigend nach ST-Nr. | ascending to ST-No.

| | | | | | |
|------------------------|-----------------|-------|------------------------|----------------|---------------|
| 08.290.7000.100 | 001 250 01 15 | 38 | 08.290.7000.160 | 0001 141 035 | 9;14;15;24;51 |
| 08.290.7000.100 | 001 250 02 15 | 38 | 08.290.7000.160 | 0117 2721 | 9;14;15;24;51 |
| 08.290.7000.100 | 001 250 25 15 | 38 | 08.290.7000.160 | 0190 3899 | 9;14;15;24;51 |
| 08.290.7000.100 | 001 250 72 15 | 38 | 08.290.7000.160 | 0190 3936 | 9;14;15;24;51 |
| 08.290.7000.100 | 002 250 05 15 | 38 | 08.290.7000.160 | 0244 3133 | 9;14;15;24;51 |
| 08.290.7000.100 | 123314 | 38 | 08.290.7000.160 | 0247 5629 | 9;14;15;24;51 |
| 08.290.7000.100 | 3151 177 031 | 38 | 08.290.7000.160 | 0247 9048 | 9;14;15;24;51 |
| 08.290.7000.100 | 3151 248 031 | 38 | 08.290.7000.160 | 0401.172.00 | 9;14;15;24;51 |
| 08.290.7000.110 | 000 250 64 15 | 38;39 | 08.290.7000.160 | 1.068.415 | 9;14;15;24;51 |
| 08.290.7000.110 | 3151 000 392 | 38;39 | 08.290.7000.160 | 11009734 | 9;14;15;24;51 |
| 08.290.7000.110 | 3151 043 032 | 38;39 | 08.290.7000.160 | 113 365 | 9;14;15;24;51 |
| 08.290.7000.120 | 000 250 95 15 | 38 | 08.290.7000.160 | 122 222 | 9;14;15;24;51 |
| 08.290.7000.120 | 001 250 08 15 | 38 | 08.290.7000.160 | 123 614 | 9;14;15;24;51 |
| 08.290.7000.120 | 3151 170 131 | 38 | 08.290.7000.160 | 211 00 436 | 9;14;15;24;51 |
| 08.290.7000.120 | 3151 602 005 | 38 | 08.290.7000.160 | 2618559 | 9;14;15;24;51 |
| 08.290.7000.130 | 001 250 06 15 | 40 | 08.290.7000.160 | 30196 | 9;14;15;24;51 |
| 08.290.7000.130 | 001 250 49 15 | 40 | 08.290.7000.160 | 3151 007 303 | 9;14;15;24;51 |
| 08.290.7000.130 | 001 250 66 15 | 40 | 08.290.7000.160 | 3151 101 031 | 9;14;15;24;51 |
| 08.290.7000.130 | 001 250 67 15 | 40 | 08.290.7000.160 | 4200 3473 | 9;14;15;24;51 |
| 08.290.7000.130 | 001 250 80 15 | 40 | 08.290.7000.160 | 4200 3474 | 9;14;15;24;51 |
| 08.290.7000.130 | 001 250 88 15 | 40 | 08.290.7000.160 | 4200 3658 | 9;14;15;24;51 |
| 08.290.7000.130 | 002 250 08 15 | 40 | 08.290.7000.160 | 4202 6898 | 9;14;15;24;51 |
| 08.290.7000.130 | 0421.506.00 | 40 | 08.290.7000.160 | 4202 6899 | 9;14;15;24;51 |
| 08.290.7000.130 | 11010039 | 40 | 08.290.7000.160 | 4206 3184 | 9;14;15;24;51 |
| 08.290.7000.130 | 3151 184 031 | 40 | 08.290.7000.160 | 5030-166 | 9;14;15;24;51 |
| 08.290.7000.130 | 3151 241 031 | 40 | 08.290.7000.160 | 5290558 | 9;14;15;24;51 |
| 08.290.7000.130 | 3151 245 031 | 40 | 08.290.7000.160 | 5304148 | 9;14;15;24;51 |
| 08.290.7000.130 | 400250100002-00 | 40 | 08.290.7000.160 | 5599230 | 9;14;15;24;51 |
| 08.290.7000.130 | 8.383.282.000 | 40 | 08.290.7000.160 | 632 100 150 | 9;14;15;24;51 |
| 08.290.7000.140 | 0190 5274 | 14;51 | 08.290.7000.160 | 651390 | 9;14;15;24;51 |
| 08.290.7000.140 | 1897 917 615 | 14;51 | 08.290.7000.160 | 700 113 365 | 9;14;15;24;51 |
| 08.290.7000.140 | 3151 220 031 | 14;51 | 08.290.7000.160 | 81.30.550.0035 | 9;14;15;24;51 |
| 08.290.7000.140 | 5000 677 180 | 14;51 | 08.290.7000.160 | 81.30.550.0049 | 9;14;15;24;51 |
| 08.290.7000.140 | 5000 677 197 | 14;51 | 08.290.7000.160 | 8.383.189.000 | 9;14;15;24;51 |
| 08.290.7000.140 | 9840 0175 | 14;51 | 08.290.7000.160 | 953.2614.001 | 9;14;15;24;51 |
| 08.290.7000.140 | 9840 0715 | 14;51 | 08.290.7000.170 | 3151 087 041 | 39 |
| 08.290.7000.140 | 9840 0721 | 14;51 | 08.290.7000.170 | 3151 602 001 | 39 |
| 08.290.7000.140 | 9840 2393 | 14;51 | 08.290.7000.170 | 320 250 00 15 | 39 |
| 08.290.7000.140 | 9843 4871 | 14;51 | 08.290.7000.170 | 343 254 00 10 | 39 |
| 08.290.7000.150 | 000 250 73 15 | 39 | 08.290.7000.170 | 400 00 884 | 39 |
| 08.290.7000.150 | 0101.110.06 | 39 | 08.290.7000.170 | 400 00 885 | 39 |
| 08.290.7000.150 | 3151 110 031 | 39 | 08.290.7000.180 | 000 250 75 15 | 39;40 |

aufsteigend nach ST-Nr. | ascending to ST-No.

| | | | | | |
|------------------------|---------------|-------|------------------------|----------------|-------|
| 08.290.7000.180 | 0401.116.10 | 39;40 | 08.290.7000.260 | 3151 824 002 | 63 |
| 08.290.7000.180 | 3151 108 031 | 39;40 | 08.290.7000.270 | 000 250 92 15 | 40 |
| 08.290.7000.180 | 632 100 390 | 39;40 | 08.290.7000.270 | 3151 166 031 | 40 |
| 08.290.7000.180 | 8.383.226.185 | 39;40 | 08.290.7000.280 | 3151 058 001 | 24 |
| 08.290.7000.180 | 8.383.248.000 | 39;40 | 08.290.7000.280 | 632 100 570 | 24 |
| 08.290.7000.190 | 001 250 09 15 | 39 | 08.290.7000.280 | 81.30550.0052 | 24 |
| 08.290.7000.190 | 001 250 47 15 | 39 | 08.290.7000.280 | 990.12.21.0078 | 24 |
| 08.290.7000.190 | 001 250 62 15 | 39 | 08.290.7000.290 | 0421.509.00 | 24;51 |
| 08.290.7000.190 | 001 250 63 15 | 39 | 08.290.7000.290 | 3151 028 001 | 24;51 |
| 08.290.7000.190 | 001 250 81 15 | 39 | 08.290.7000.290 | 3151 067 001 | 24;51 |
| 08.290.7000.190 | 001 250 84 15 | 39 | 08.290.7000.290 | 3151 067 031 | 24;51 |
| 08.290.7000.190 | 001 250 97 15 | 39 | 08.290.7000.290 | 5001 001 622 | 24;51 |
| 08.290.7000.190 | 3151 184 032 | 39 | 08.290.7000.290 | 5800 207 033 | 24;51 |
| 08.290.7000.190 | 3151 241 032 | 39 | 08.290.7000.290 | 81.30000.6336 | 24;51 |
| 08.290.7000.190 | 3151 245 032 | 39 | 08.290.7000.290 | 81.30550.0043 | 24;51 |
| 08.290.7000.200 | 000 250 17 15 | 38 | 08.290.7000.290 | 81.30550.0054 | 24;51 |
| 08.290.7000.200 | 000 250 31 15 | 38 | 08.290.7000.300 | 001 250 04 15 | 9;40 |
| 08.290.7000.200 | 000 250 37 15 | 38 | 08.290.7000.300 | 001 250 45 15 | 9;40 |
| 08.290.7000.200 | 000 250 40 15 | 38 | 08.290.7000.300 | 070 763 | 9;40 |
| 08.290.7000.200 | 123310 | 38 | 08.290.7000.300 | 3151 118 031 | 9;40 |
| 08.290.7000.200 | 3151 033 031 | 38 | 08.290.7000.300 | 3151 182 031 | 9;40 |
| 08.290.7000.220 | 000 250 76 15 | 39 | 08.290.7000.310 | 1668 930 | 63 |
| 08.290.7000.220 | 2617049 | 39 | 08.290.7000.310 | 1668 938 | 63 |
| 08.290.7000.220 | 3151 126 031 | 39 | 08.290.7000.310 | 1669 834 | 63 |
| 08.290.7000.230 | 1 321 260 | 56 | 08.290.7000.310 | 1672 948 | 63 |
| 08.290.7000.230 | 1 393 163 | 56 | 08.290.7000.310 | 3100 002 119 | 63 |
| 08.290.7000.230 | 3100 003 001 | 56 | 08.290.7000.310 | 3100 002 219 | 63 |
| 08.290.7000.230 | 3100 007 001 | 56 | 08.290.7000.310 | 3100 002 449 | 63 |
| 08.290.7000.230 | 3100 007 103 | 56 | 08.290.7000.310 | 3100 002 549 | 63 |
| 08.290.7000.230 | 3100 007 203 | 56 | 08.290.7000.310 | 3192 224 | 63 |
| 08.290.7000.230 | 382 413 | 56 | 08.290.7000.320 | 1655 287 | 63 |
| 08.290.7000.240 | 123312 | 38 | 08.290.7000.320 | 3151 824 003 | 63 |
| 08.290.7000.240 | 312 250 13 15 | 38 | 08.290.7000.330 | 0267 158 | 63 |
| 08.290.7000.240 | 3151 095 043 | 38 | 08.290.7000.330 | 0348 842 | 63 |
| 08.290.7000.240 | 340 250 02 15 | 38 | 08.290.7000.330 | 1527 695 | 63 |
| 08.290.7000.240 | 352 250 01 15 | 38 | 08.290.7000.330 | 3151 105 041 | 63 |
| 08.290.7000.240 | 352 250 05 15 | 38 | 08.290.7000.330 | 3151 105 141 | 63 |
| 08.290.7000.250 | 3151 067 002 | 24;51 | 08.290.7000.330 | 8112 138 | 63 |
| 08.290.7000.250 | 3151 067 032 | 24;51 | 08.290.7000.330 | 8112 139 | 63 |
| 08.290.7000.250 | 5000 807 806 | 24;51 | 08.290.7000.340 | 1 321 255 | 56 |
| 08.290.7000.250 | 81.30550.0056 | 24;51 | 08.290.7000.340 | 1 322 781 | 56 |
| 08.290.7000.260 | 1655 288 | 63 | 08.290.7000.340 | 1 393 161 | 56 |

Vergleichsliste | Crosslist

aufsteigend nach ST-Nr. | ascending to ST-No.

| | | | | | |
|------------------------|---------------|---------|------------------------|---------------|---------|
| 08.290.7000.340 | 1 407 430 | 56 | 08.290.7000.420 | 1311 497 | 9;10;25 |
| 08.290.7000.340 | 1 545 062 | 56 | 08.290.7000.420 | 3151 263 031 | 9;10;25 |
| 08.290.7000.340 | 3100 008 001 | 56 | 08.290.7000.420 | 4202 2205 | 9;10;25 |
| 08.290.7000.340 | 3100 008 101 | 56 | 08.290.7000.420 | 5001 866 621 | 9;10;25 |
| 08.290.7000.340 | 3100 008 201 | 56 | 08.290.7000.420 | 5010 244 390 | 9;10;25 |
| 08.290.7000.350 | 1672 945 | 63 | 08.290.7000.420 | 81.30550.0080 | 9;10;25 |
| 08.290.7000.350 | 20 569 159 | 63 | 08.290.7000.420 | 81.30550.0089 | 9;10;25 |
| 08.290.7000.350 | 3151 000 154 | 63 | 08.290.7000.430 | 3151 274 101 | 52 |
| 08.290.7000.350 | 3151 167 101 | 63 | 08.290.7000.430 | 3151 274 131 | 52 |
| 08.290.7000.350 | 3151 167 232 | 63 | 08.290.7000.430 | 5010 245 457 | 52 |
| 08.290.7000.350 | 3151 167 432 | 63 | 08.290.7000.430 | 5010 245 921 | 52 |
| 08.290.7000.350 | 3151 276 931 | 63 | 08.290.7000.470 | 3151 068 101 | 26 |
| 08.290.7000.350 | 3192 219 | 63 | 08.290.7000.470 | 5196701 | 26 |
| 08.290.7000.350 | 7420 730 004 | 63 | 08.290.7000.490 | 1655 843 | 64 |
| 08.290.7000.360 | 1672 950 | 63 | 08.290.7000.490 | 1668 921 | 64 |
| 08.290.7000.360 | 3100 002 353 | 63 | 08.290.7000.490 | 1669 832 | 64 |
| 08.290.7000.360 | 3151 000 219 | 63 | 08.290.7000.490 | 1672 944 | 64 |
| 08.290.7000.360 | 3151 164 434 | 63 | 08.290.7000.490 | 20 569 157 | 64 |
| 08.290.7000.360 | 3151 164 534 | 63 | 08.290.7000.490 | 3100 002 114 | 64 |
| 08.290.7000.360 | 3151 278 131 | 63 | 08.290.7000.490 | 3100 002 247 | 64 |
| 08.290.7000.360 | 3192 226 | 63 | 08.290.7000.490 | 3100 026 432 | 64 |
| 08.290.7000.380 | 1 479 576 | 56 | 08.290.7000.490 | 3192 209 | 64 |
| 08.290.7000.380 | 1 499 770 | 56 | 08.290.7000.490 | 3192 222 | 64 |
| 08.290.7000.380 | 1 728 165 | 56 | 08.290.7000.490 | 3483 026 231 | 64 |
| 08.290.7000.380 | 1 749 125 | 56 | 08.290.7000.490 | 3483 026 331 | 64 |
| 08.290.7000.380 | 1 851 631 | 56 | 08.290.7000.500 | 002 250 41 15 | 40 |
| 08.290.7000.380 | 3151 000 151 | 56 | 08.290.7000.500 | 002 250 47 15 | 40 |
| 08.290.7000.390 | 3151 000 404 | 52 | 08.290.7000.500 | 002 250 67 15 | 40 |
| 08.290.7000.390 | 3151 250 302 | 52 | 08.290.7000.500 | 002 250 81 15 | 40 |
| 08.290.7000.390 | 3151 250 332 | 52 | 08.290.7000.500 | 3100 002 255 | 40 |
| 08.290.7000.390 | 5010 244 086 | 52 | 08.290.7000.510 | 002 250 37 15 | 40;41 |
| 08.290.7000.390 | 8010 244 204 | 52 | 08.290.7000.510 | 002 250 40 15 | 40;41 |
| 08.290.7000.400 | 3151 250 231 | 52 | 08.290.7000.510 | 002 250 68 15 | 40;41 |
| 08.290.7000.400 | 5006023703 | 52 | 08.290.7000.510 | 002 250 82 15 | 40;41 |
| 08.290.7000.400 | 5010 244 017 | 52 | 08.290.7000.510 | 3100 000 003 | 40;41 |
| 08.290.7000.400 | 5010 244 202 | 52 | 08.290.7000.510 | 3100 002 254 | 40;41 |
| 08.290.7000.410 | 3151 262 031 | 25 | 08.290.7000.510 | 3100 002 256 | 40;41 |
| 08.290.7000.410 | 5010 452 025 | 25 | 08.290.7000.520 | 20 569 153 | 64 |
| 08.290.7000.410 | 81.30000.7220 | 25 | 08.290.7000.520 | 3100 002 459 | 64 |
| 08.290.7000.410 | 81.30550.0085 | 25 | 08.290.7000.520 | 3100 026 434 | 64 |
| 08.290.7000.420 | 1303 707 | 9;10;25 | 08.290.7000.520 | 3192 216 | 64 |
| 08.290.7000.420 | 130-510-0031 | 9;10;25 | 08.290.7000.530 | 20 569 151 | 64 |

aufsteigend nach ST-Nr. | ascending to ST-No.

| | | | | | |
|------------------------|---------------|-------------------|------------------------|---------------|----------|
| 08.290.7000.530 | 3100 002 460 | 64 | 08.320.1000.200 | 1882 316 032 | 20;32;42 |
| 08.290.7000.530 | 3100 026 431 | 64 | 08.320.1000.200 | 1882 330 031 | 20;32;42 |
| 08.290.7000.530 | 3192 218 | 64 | 08.320.1000.200 | 1882 330 033 | 20;32;42 |
| 08.290.7000.530 | 7420 730 007 | 64 | 08.320.1000.200 | 20293 | 20;32;42 |
| 08.290.7000.540 | 20 569 155 | 64 | 08.320.1000.200 | 20297 | 20;32;42 |
| 08.290.7000.540 | 3100 002 464 | 64 | 08.320.1000.200 | 632 100 240 | 20;32;42 |
| 08.290.7000.540 | 3100 026 531 | 64 | 08.320.1000.200 | 632 100 340 | 20;32;42 |
| 08.290.7000.540 | 3192 220 | 64 | 08.320.1000.200 | 81.30305.0084 | 20;32;42 |
| 08.290.7000.550 | 1 393 187 | 25;41;51;52;56;64 | 08.320.1000.200 | 81.30305.9084 | 20;32;42 |
| 08.290.7000.550 | 1393 187 | 25;41;51;52;56;64 | 08.320.1000.200 | 81.30305.9111 | 20;32;42 |
| 08.290.7000.550 | 1673 220 | 25;41;51;52;56;64 | 08.320.1000.200 | 8.383.146.000 | 20;32;42 |
| 08.290.7000.550 | 20 571 945 | 25;41;51;52;56;64 | 08.320.1000.210 | ACU 9200 | 32 |
| 08.290.7000.550 | 3180 000 001 | 25;41;51;52;56;64 | 08.320.1000.210 | ACU 9205 | 32 |
| 08.290.7000.550 | 3180 000 009 | 25;41;51;52;56;64 | 08.320.1000.210 | 004 250 46 04 | 32 |
| 08.290.7000.550 | 3180 002 102 | 25;41;51;52;56;64 | 08.320.1000.210 | 004 250 56 04 | 32 |
| 08.290.7000.550 | 3180 002 103 | 25;41;51;52;56;64 | 08.320.1000.210 | 004 250 58 04 | 32 |
| 08.290.7000.550 | 388 060 | 25;41;51;52;56;64 | 08.320.1000.210 | 004 250 60 04 | 32 |
| 08.290.7000.550 | 5001 825 649 | 25;41;51;52;56;64 | 08.320.1000.210 | 004 250 61 04 | 32 |
| 08.290.7000.560 | 001 250 18 15 | 25;41;44 | 08.320.1000.210 | 004 250 87 04 | 32 |
| 08.290.7000.560 | 001 250 96 15 | 25;41;44 | 08.320.1000.210 | 004 250 88 04 | 32 |
| 08.290.7000.560 | 0421.510.00 | 25;41;44 | 08.320.1000.210 | 005 250 83 04 | 32 |
| 08.290.7000.560 | 0422 6857 | 25;41;44 | 08.320.1000.210 | 005 250 84 04 | 32 |
| 08.290.7000.560 | 10642776 | 25;41;44 | 08.320.1000.210 | 078 544 | 32 |
| 08.290.7000.560 | 1368 693 | 25;41;44 | 08.320.1000.210 | 11009979 | 32 |
| 08.290.7000.560 | 270566 | 25;41;44 | 08.320.1000.210 | 1140 539 | 32 |
| 08.290.7000.560 | 632 101 680 | 25;41;44 | 08.320.1000.210 | 3482 062 003 | 32 |
| 08.290.7000.560 | 8.383.337.000 | 25;41;44 | 08.320.1000.210 | 3482 081 032 | 32 |
| 08.290.7000.560 | 8.383.341.000 | 25;41;44 | 08.320.1000.210 | 3482 081 231 | 32 |
| 08.320.1000.200 | 000250201100 | 20;32;42 | 08.320.1000.210 | 3482 081 232 | 32 |
| 08.320.1000.200 | 002 250 32 04 | 20;32;42 | 08.320.1000.210 | 3482 086 031 | 32 |
| 08.320.1000.200 | 002 250 41 04 | 20;32;42 | 08.320.1000.210 | 774 106 | 32 |
| 08.320.1000.200 | 002 250 99 04 | 20;32;42 | 08.320.1000.210 | 774 691 | 32 |
| 08.320.1000.200 | 003 250 00 04 | 20;32;42 | 08.320.1000.210 | 8.383.254.000 | 32 |
| 08.320.1000.200 | 003 250 26 04 | 20;32;42 | 08.320.1000.210 | 8.383.268.000 | 32 |
| 08.320.1000.200 | 003 250 41 04 | 20;32;42 | 08.320.1000.210 | 8.383.319.000 | 32 |
| 08.320.1000.200 | 003 250 70 04 | 20;32;42 | 08.320.1000.210 | 8.383.343.000 | 32 |
| 08.320.1000.200 | 0401.101.00 | 20;32;42 | 08.320.1000.220 | 000 250 19 04 | 31 |
| 08.320.1000.200 | 0890-589 | 20;32;42 | 08.320.1000.220 | 000 250 40 04 | 31 |
| 08.320.1000.200 | 1861 998 131 | 20;32;42 | 08.320.1000.220 | 000 250 43 04 | 31 |
| 08.320.1000.200 | 1882 301 204 | 20;32;42 | 08.320.1000.220 | 000 250 71 04 | 31 |
| 08.320.1000.200 | 1882 301 239 | 20;32;42 | 08.320.1000.220 | 000 250 74 04 | 31 |
| 08.320.1000.200 | 1882 303 141 | 20;32;42 | 08.320.1000.220 | 001 250 07 04 | 31 |

Vergleichsliste | Crosslist

aufsteigend nach ST-Nr. | ascending to ST-No.

| | | | | | |
|------------------------|----------------|-------|------------------------|----------------|-------|
| 08.320.1000.220 | 001 250 08 04 | 31 | 08.320.1000.270 | 991.14.16.0037 | 26 |
| 08.320.1000.220 | 001 250 68 04 | 31 | 08.320.1000.270 | 991.14.16.0916 | 26 |
| 08.320.1000.220 | 003 250 20 04 | 31 | 08.320.1000.280 | 3482 000 461 | 20 |
| 08.320.1000.220 | 003 250 21 04 | 31 | 08.320.1000.280 | 3482 125 533 | 20 |
| 08.320.1000.220 | 003 250 22 04 | 31 | 08.320.1000.280 | 402-150031 | 20 |
| 08.320.1000.220 | 117 3274 | 31 | 08.320.1000.280 | 5651445 | 20 |
| 08.320.1000.220 | 1882 166 705 | 31 | 08.320.1000.280 | 81.30305.0206 | 20 |
| 08.320.1000.220 | 1882 166 734 | 31 | 08.320.1000.280 | 81.30305.0209 | 20 |
| 08.320.1000.220 | 1882 166 735 | 31 | 08.320.1000.280 | 81.30305.0224 | 20 |
| 08.320.1000.220 | 1882 166 737 | 31 | 08.320.1000.280 | 81.30305.0232 | 20 |
| 08.320.1000.220 | 211 00 337 | 31 | 08.320.1000.280 | 81.30305.9206 | 20 |
| 08.320.1000.220 | 5031-316 | 31 | 08.320.1000.280 | 81.30305.9232 | 20 |
| 08.320.1000.230 | 005 250 93 04 | 33 | 08.320.1000.290 | 006 250 30 04 | 33 |
| 08.320.1000.230 | 005 250 94 04 | 33 | 08.320.1000.290 | 006 250 67 04 | 33 |
| 08.320.1000.230 | 007 250 79 04 | 33 | 08.320.1000.290 | 019 250 64 01 | 33 |
| 08.320.1000.230 | 008 250 31 04 | 33 | 08.320.1000.290 | 3482 000 462 | 33 |
| 08.320.1000.230 | 022 250 20 01 | 33 | 08.320.1000.290 | 3482 126 331 | 33 |
| 08.320.1000.230 | 3483 030 031 | 33 | 08.320.1000.300 | 002 250 75 04 | 6;33 |
| 08.320.1000.240 | 005 250 64 04 | 32;33 | 08.320.1000.300 | 0660 306 | 6;33 |
| 08.320.1000.240 | 005 250 66 04 | 32;33 | 08.320.1000.300 | 3482 011 231 | 6;33 |
| 08.320.1000.240 | 007 250 61 04 | 32;33 | 08.320.1000.300 | 3482 011 331 | 6;33 |
| 08.320.1000.240 | 007 250 81 04 | 32;33 | 08.320.1000.310 | 1521 725 | 59 |
| 08.320.1000.240 | 008 250 30 04 | 32;33 | 08.320.1000.310 | 3459 018 004 | 59 |
| 08.320.1000.240 | 3483 030 032 | 32;33 | 08.320.1000.320 | 1669 134 | 59;60 |
| 08.320.1000.250 | 0421.019.00 | 16 | 08.320.1000.320 | 3459 016 031 | 59;60 |
| 08.320.1000.250 | 1 JX046 4780 | 16 | 08.320.1000.340 | ATRA245 | 6 |
| 08.320.1000.250 | 11009972 | 16 | 08.320.1000.340 | ATRB257 | 6 |
| 08.320.1000.250 | 193853 | 16 | 08.320.1000.340 | 1304 280 | 6 |
| 08.320.1000.250 | 3482 083 118 | 16 | 08.320.1000.340 | 1304 280R | 6 |
| 08.320.1000.250 | 5031-18308 | 16 | 08.320.1000.340 | 3482 000 419 | 6 |
| 08.320.1000.250 | 920 919 503 | 16 | 08.320.1000.340 | 3482 116 031 | 6 |
| 08.320.1000.260 | 3482 125 512 | 26 | 08.320.1000.350 | 3482 124 534 | 20;33 |
| 08.320.1000.260 | 431202003 | 26 | 08.320.1000.350 | 81.30305.6028 | 20;33 |
| 08.320.1000.270 | ACU 9332 | 26 | 08.320.1000.360 | 3482 120 031 | 20 |
| 08.320.1000.270 | 193853 | 26 | 08.320.1000.360 | 81.30305.0201 | 20 |
| 08.320.1000.270 | 3482 062 034 | 26 | 08.320.1000.360 | 81.30305.9201 | 20 |
| 08.320.1000.270 | 3482 083 013 | 26 | 08.320.1000.602 | AZ 36712 | 12;31 |
| 08.320.1000.270 | 3482 083 113 | 26 | 08.320.1000.602 | AZY 61355 | 12;31 |
| 08.320.1000.270 | 3482 083 145 | 26 | 08.320.1000.602 | 002 250 87 04 | 12;31 |
| 08.320.1000.270 | 5615592 | 26 | 08.320.1000.602 | 003 250 54 04 | 12;31 |
| 08.320.1000.270 | 8.383.339.000 | 26 | 08.320.1000.602 | 0190 3890 | 12;31 |
| 08.320.1000.270 | 991.14.16.0028 | 26 | 08.320.1000.602 | 0190 4705 | 12;31 |

aufsteigend nach ST-Nr. | ascending to ST-No.

| | | | | | |
|------------------------|----------------|----------|------------------------|----------------|----------|
| 08.320.1000.602 | 0190 4772 | 12;31 | 08.320.1000.622 | 950.2641.030 | 12;20;32 |
| 08.320.1000.602 | 0627 6681 | 12;31 | 08.320.1000.632 | 003 250 40 04 | 31 |
| 08.320.1000.602 | 3141 909 M1 | 12;31 | 08.320.1000.632 | 003 250 99 04 | 31 |
| 08.320.1000.602 | 324 4926 R91 | 12;31 | 08.320.1000.632 | 3482 012 233 | 31 |
| 08.320.1000.602 | 3482 012 201 | 12;31 | 08.320.1000.632 | 3482 012 240 | 31 |
| 08.320.1000.602 | 3482 012 211 | 12;31 | 08.320.1000.632 | 3482 012 310 | 31 |
| 08.320.1000.602 | 3482 012 231 | 12;31 | 08.320.1000.642 | 1527 517 | 59 |
| 08.320.1000.602 | 4201 6352 | 12;31 | 08.320.1000.642 | 1655 331 | 59 |
| 08.320.1000.602 | 4202 6352 | 12;31 | 08.320.1000.642 | 1655 822 | 59 |
| 08.320.1000.602 | 4202 6354 | 12;31 | 08.320.1000.642 | 1667 255 | 59 |
| 08.320.1000.602 | 4206 6352 | 12;31 | 08.320.1000.642 | 1668 615 | 59 |
| 08.320.1000.602 | 8.383.211.000 | 12;31 | 08.320.1000.642 | 1669 370 | 59 |
| 08.320.1000.612 | 004 250 89 04 | 32 | 08.320.1000.642 | 1669 828 | 59 |
| 08.320.1000.612 | 005 250 62 04 | 32 | 08.320.1000.642 | 1672 934 | 59 |
| 08.320.1000.612 | 3482 081 233 | 32 | 08.320.1000.642 | 3192 211 | 59 |
| 08.320.1000.612 | 8.383.344.000 | 32 | 08.320.1000.642 | 3483 016 131 | 59 |
| 08.320.1000.622 | 002 250 03 04 | 12;20;32 | 08.320.1000.642 | 3483 020 031 | 59 |
| 08.320.1000.622 | 002 250 04 04 | 12;20;32 | 08.320.1000.642 | 3483 020 032 | 59 |
| 08.320.1000.622 | 002 250 81 04 | 12;20;32 | 08.320.1000.642 | 3483 020 043 | 59 |
| 08.320.1000.622 | 003 250 88 04 | 12;20;32 | 08.320.1000.642 | 3483 020 052 | 59 |
| 08.320.1000.622 | 003 250 90 04 | 12;20;32 | 08.320.1000.642 | 3483 034 032 | 59 |
| 08.320.1000.622 | 004 250 00 04 | 12;20;32 | 08.320.1000.652 | ACU 9199 | 5;19 |
| 08.320.1000.622 | 005 250 19 04 | 12;20;32 | 08.320.1000.652 | ACU 9204 | 5;19 |
| 08.320.1000.622 | 0190 3853 | 12;20;32 | 08.320.1000.652 | 0286 877 | 5;19 |
| 08.320.1000.622 | 0190 3929 | 12;20;32 | 08.320.1000.652 | 3482 060 102 | 5;19 |
| 08.320.1000.622 | 0247 6483 | 12;20;32 | 08.320.1000.652 | 3482 060 131 | 5;19 |
| 08.320.1000.622 | 0401.170.10 | 12;20;32 | 08.320.1000.652 | 3482 060 132 | 5;19 |
| 08.320.1000.622 | 1882 298 001 | 12;20;32 | 08.320.1000.652 | 81.30.305.0162 | 5;19 |
| 08.320.1000.622 | 1882 301 240 | 12;20;32 | 08.320.1000.662 | 1 335 281 | 54 |
| 08.320.1000.622 | 1882 301 242 | 12;20;32 | 08.320.1000.662 | 1 356 981 | 54 |
| 08.320.1000.622 | 1882 303 037 | 12;20;32 | 08.320.1000.662 | 3482 112 031 | 54 |
| 08.320.1000.622 | 1882 303 101 | 12;20;32 | 08.320.1000.662 | 3482 112 032 | 54 |
| 08.320.1000.622 | 1882 303 132 | 12;20;32 | 08.320.1000.662 | 571 222 | 54 |
| 08.320.1000.622 | 1882 342 132 | 12;20;32 | 08.320.1000.672 | 3482 000 467 | 19 |
| 08.320.1000.622 | 211 00 434 | 12;20;32 | 08.320.1000.672 | 3482 115 032 | 19 |
| 08.320.1000.622 | 223971 | 12;20;32 | 08.320.1000.672 | 81.30305.0198 | 19 |
| 08.320.1000.622 | 3482 124 522 | 12;20;32 | 08.320.1000.672 | 81.30305.0225 | 19 |
| 08.320.1000.622 | 81.30305.0111 | 12;20;32 | 08.320.1000.672 | 81.30305.0233 | 19 |
| 08.320.1000.622 | 815.60.16.0003 | 12;20;32 | 08.320.1000.672 | 81.30305.9198 | 19 |
| 08.320.1000.622 | 815.60.16.0006 | 12;20;32 | 08.320.1000.672 | 81.30305.9233 | 19 |
| 08.320.1000.622 | 853.03.05.0001 | 12;20;32 | 08.320.1000.682 | 0078 866 | 6;54 |
| 08.320.1000.622 | 853.03.05.9001 | 12;20;32 | 08.320.1000.682 | 0421.009.00 | 6;54 |

Vergleichsliste | Crosslist

aufsteigend nach ST-Nr. | ascending to ST-No.

| | | | | | |
|------------------------|-----------------|------|------------------------|---------------|----|
| 08.320.1000.682 | 10664863 | 6;54 | 08.320.1000.712 | 382 499 | 54 |
| 08.320.1000.682 | 11009965 | 6;54 | 08.320.1000.712 | 382 576 | 54 |
| 08.320.1000.682 | 1230 549 | 6;54 | 08.320.1000.712 | 571 217 | 54 |
| 08.320.1000.682 | 1230 550 | 6;54 | 08.320.1000.712 | 571 218 | 54 |
| 08.320.1000.682 | 1310 896 | 6;54 | 08.320.1000.712 | 571 220 | 54 |
| 08.320.1000.682 | 212049 | 6;54 | 08.320.1000.712 | 571 221 | 54 |
| 08.320.1000.682 | 216169 | 6;54 | 08.320.1000.712 | 571 226 | 54 |
| 08.320.1000.682 | 291 228 | 6;54 | 08.320.1000.712 | 571 227 | 54 |
| 08.320.1000.682 | 3482 018 132 | 6;54 | 08.320.1000.722 | 006 250 47 04 | 32 |
| 08.320.1000.682 | 3482 018 202 | 6;54 | 08.320.1000.722 | 006 250 48 04 | 32 |
| 08.320.1000.682 | 3482 018 205 | 6;54 | 08.320.1000.722 | 006 250 49 04 | 32 |
| 08.320.1000.682 | 3482 098 031 | 6;54 | 08.320.1000.722 | 006 250 86 04 | 32 |
| 08.320.1000.682 | 3482 119 031 | 6;54 | 08.320.1000.722 | 006 250 87 04 | 32 |
| 08.320.1000.682 | 632 101 770 | 6;54 | 08.320.1000.722 | 006 250 88 04 | 32 |
| 08.320.1000.682 | 632 101 780 | 6;54 | 08.320.1000.722 | 007 250 05 04 | 32 |
| 08.320.1000.692 | 004 250 44 04 | 32 | 08.320.1000.722 | 007 250 06 04 | 32 |
| 08.320.1000.692 | 004 250 45 04 | 32 | 08.320.1000.722 | 007 250 07 04 | 32 |
| 08.320.1000.692 | 005 250 76 04 | 32 | 08.320.1000.722 | 007 250 28 04 | 32 |
| 08.320.1000.692 | 005 250 77 04 | 32 | 08.320.1000.722 | 007 250 29 04 | 32 |
| 08.320.1000.692 | 005 250 87 04 | 32 | 08.320.1000.722 | 007 250 30 04 | 32 |
| 08.320.1000.692 | 005 250 88 04 | 32 | 08.320.1000.722 | 007 250 32 04 | 32 |
| 08.320.1000.692 | 3488 017 032 | 32 | 08.320.1000.722 | 007 250 33 04 | 32 |
| 08.320.1000.692 | 3488 017 402 | 32 | 08.320.1000.722 | 007 250 34 04 | 32 |
| 08.320.1000.692 | 3488 017 432 | 32 | 08.320.1000.722 | 007 250 44 04 | 32 |
| 08.320.1000.692 | 3488 017 436 | 32 | 08.320.1000.722 | 007 250 46 04 | 32 |
| 08.320.1000.692 | 400250100003-00 | 32 | 08.320.1000.722 | 007 250 51 04 | 32 |
| 08.320.1000.692 | 8.383.280.000 | 32 | 08.320.1000.722 | 007 250 82 04 | 32 |
| 08.320.1000.702 | 1204 205 | 5;6 | 08.320.1000.722 | 008 250 35 04 | 32 |
| 08.320.1000.702 | 1329 459R | 5;6 | 08.320.1000.722 | 3400 121 501 | 32 |
| 08.320.1000.702 | 1329 549 | 5;6 | 08.320.1000.722 | 3488 017 446 | 32 |
| 08.320.1000.702 | 257128 | 5;6 | 08.320.1000.722 | 3488 017 448 | 32 |
| 08.320.1000.702 | 3482 083 041 | 5;6 | 08.320.1000.722 | 3488 023 031 | 32 |
| 08.320.1000.712 | 1 113 870 | 54 | 08.320.1000.722 | 3488 023 032 | 32 |
| 08.320.1000.712 | 1 321 254 | 54 | 08.320.1000.732 | 1521 721 | 59 |
| 08.320.1000.712 | 1 321 259 | 54 | 08.320.1000.732 | 1669 116 | 59 |
| 08.320.1000.712 | 1 361 679 | 54 | 08.320.1000.732 | 1669 827 | 59 |
| 08.320.1000.712 | 1 365 486 | 54 | 08.320.1000.732 | 1672 935 | 59 |
| 08.320.1000.712 | 1 370 793 | 54 | 08.320.1000.732 | 20 569 126 | 59 |
| 08.320.1000.712 | 1 370 794 | 54 | 08.320.1000.732 | 3192 200 | 59 |
| 08.320.1000.712 | 3482 058 203 | 54 | 08.320.1000.732 | 3192 210 | 59 |
| 08.320.1000.712 | 3482 083 009 | 54 | 08.320.1000.732 | 3483 020 037 | 59 |
| 08.320.1000.712 | 3482 083 039 | 54 | 08.320.1000.732 | 3483 034 033 | 59 |

aufsteigend nach ST-Nr. | ascending to ST-No.

| | | |
|------------------------|---------------|----------|
| 08.320.1000.732 | 8113 463 | 59 |
| 08.320.1000.732 | 8113 513 | 59 |
| 08.320.1000.732 | 8113 529 | 59 |
| 08.320.1000.742 | 004 250 24 04 | 31 |
| 08.320.1000.742 | 0401.112.00 | 31 |
| 08.320.1000.742 | 0421.003.00 | 31 |
| 08.320.1000.742 | 3482 051 031 | 31 |
| 08.320.1000.742 | 3482 051 131 | 31 |
| 08.320.1000.752 | 3482 094 031 | 11;47 |
| 08.320.1000.752 | 9840 0708 | 11;47 |
| 08.320.1000.752 | 9840 0713 | 11;47 |
| 08.320.1000.762 | 0401.109.00 | 54 |
| 08.320.1000.762 | 1 102 425 | 54 |
| 08.320.1000.762 | 234 682 | 54 |
| 08.320.1000.762 | 264 786 | 54 |
| 08.320.1000.762 | 294 884 | 54 |
| 08.320.1000.762 | 306 600 | 54 |
| 08.320.1000.762 | 327 557 | 54 |
| 08.320.1000.762 | 329 439 | 54 |
| 08.320.1000.762 | 3482 001 134 | 54 |
| 08.320.1000.762 | 3482 001 234 | 54 |
| 08.320.1000.762 | 3482 119 034 | 54 |
| 08.320.1000.762 | 394 884 | 54 |
| 08.320.1000.762 | 571 079 | 54 |
| 08.320.1000.762 | 571 208 | 54 |
| 08.320.1000.762 | 571 210 | 54 |
| 08.320.1000.762 | 571 214 | 54 |
| 08.320.1000.762 | 571 216 | 54 |
| 08.320.1000.762 | 571 219 | 54 |
| 08.320.1000.772 | 1 341 687 | 54 |
| 08.320.1000.772 | 1 382 331 | 54 |
| 08.320.1000.772 | 1 382 332 | 54 |
| 08.320.1000.772 | 3482 083 150 | 54 |
| 08.320.1000.772 | 571 289 | 54 |
| 08.320.1000.792 | 0190 4751 | 11;12;19 |
| 08.320.1000.792 | 0190 4752 | 11;12;19 |
| 08.320.1000.792 | 0190 4779 | 11;12;19 |
| 08.320.1000.792 | 0190 4780 | 11;12;19 |
| 08.320.1000.792 | 0421.018.00 | 11;12;19 |
| 08.320.1000.792 | 11009971 | 11;12;19 |
| 08.320.1000.792 | 11009985 | 11;12;19 |
| 08.320.1000.792 | 11009986 | 11;12;19 |

| | | |
|------------------------|----------------|----------|
| 08.320.1000.792 | 31210-0178A | 11;12;19 |
| 08.320.1000.792 | 31210-3200A | 11;12;19 |
| 08.320.1000.792 | 3482 083 032 | 11;12;19 |
| 08.320.1000.792 | 3482 083 038 | 11;12;19 |
| 08.320.1000.792 | 3482 083 119 | 11;12;19 |
| 08.320.1000.792 | 3482 083 219 | 11;12;19 |
| 08.320.1000.792 | 4210 2097 | 11;12;19 |
| 08.320.1000.792 | 4210 2099 | 11;12;19 |
| 08.320.1000.792 | 4210 2947 | 11;12;19 |
| 08.320.1000.792 | 500 697 757 | 11;12;19 |
| 08.320.1000.792 | 81.30.000.6587 | 11;12;19 |
| 08.320.1000.792 | 81.30.000.6600 | 11;12;19 |
| 08.320.1000.792 | 81.30.000.6601 | 11;12;19 |
| 08.320.1000.792 | 81.30.000.6602 | 11;12;19 |
| 08.320.1000.792 | 81.30.305.0138 | 11;12;19 |
| 08.320.1000.792 | 81.30.305.0139 | 11;12;19 |
| 08.320.1000.792 | 81.30.305.0158 | 11;12;19 |
| 08.320.1000.792 | 81.30.305.0165 | 11;12;19 |
| 08.320.1000.792 | 81.30.305.0166 | 11;12;19 |
| 08.320.1000.792 | 81.30.305.0179 | 11;12;19 |
| 08.320.1000.792 | 81.30.305.0182 | 11;12;19 |
| 08.320.1000.792 | 81.30.305.0191 | 11;12;19 |
| 08.320.1000.792 | 81.30.305.0193 | 11;12;19 |
| 08.320.1000.792 | 81.30.305.0194 | 11;12;19 |
| 08.320.1000.792 | 81.30.305.9166 | 11;12;19 |
| 08.320.1000.792 | 81.30.305.9191 | 11;12;19 |
| 08.320.1000.792 | 81.30.305.9193 | 11;12;19 |
| 08.320.1000.792 | 81.30.305.9194 | 11;12;19 |
| 08.320.1000.792 | 8.383.292.000 | 11;12;19 |
| 08.320.1000.802 | 000 250 00 04 | 31 |
| 08.320.1000.802 | 002 250 31 04 | 31 |
| 08.320.1000.802 | 002 250 39 04 | 31 |
| 08.320.1000.802 | 002 250 40 04 | 31 |
| 08.320.1000.802 | 003 250 25 04 | 31 |
| 08.320.1000.802 | 003 250 27 04 | 31 |
| 08.320.1000.802 | 003 250 28 04 | 31 |
| 08.320.1000.802 | 0401.103.00 | 31 |
| 08.320.1000.802 | 1882 302 131 | 31 |
| 08.320.1000.802 | 1882 302 134 | 31 |
| 08.320.1000.802 | 20292 | 31 |
| 08.320.1000.802 | 5030-105 | 31 |
| 08.320.1000.802 | 5031-336 | 31 |

Vergleichsliste | Crosslist

aufsteigend nach ST-Nr. | ascending to ST-No.

| | | | | | |
|------------------------|---------------|-------|------------------------|---------------|-------|
| 08.320.1000.802 | 651133 | 31 | 08.320.1000.872 | 1 322 780 | 54 |
| 08.320.1000.802 | 8.383.192.000 | 31 | 08.320.1000.872 | 1 393 183 | 54 |
| 08.320.1000.822 | 3482 000 096 | 19 | 08.320.1000.872 | 3483 020 036 | 54 |
| 08.320.1000.822 | 3482 000 196 | 19 | 08.320.1000.882 | 1668 665 | 59 |
| 08.320.1000.822 | 3482 000 361 | 19 | 08.320.1000.882 | 1669 287 | 59 |
| 08.320.1000.822 | 81.30305.0205 | 19 | 08.320.1000.882 | 1669 830 | 59 |
| 08.320.1000.822 | 81.30305.0218 | 19 | 08.320.1000.882 | 1672 930 | 59 |
| 08.320.1000.822 | 81.30305.0220 | 19 | 08.320.1000.882 | 3192 212 | 59 |
| 08.320.1000.822 | 81.30305.0230 | 19 | 08.320.1000.882 | 3483 022 031 | 59 |
| 08.320.1000.822 | 81.30305.9220 | 19 | 08.320.1000.892 | 1521 713 | 59 |
| 08.320.1000.832 | 1521 712 | 59 | 08.320.1000.892 | 20 569 130 | 59 |
| 08.320.1000.832 | 20 569 128 | 59 | 08.320.1000.892 | 3192 202 | 59 |
| 08.320.1000.832 | 3192 201 | 59 | 08.320.1000.892 | 3483 034 035 | 59 |
| 08.320.1000.832 | 3483 034 034 | 59 | 08.320.1000.892 | 8113 514 | 59 |
| 08.320.1000.832 | 8113 512 | 59 | 08.320.1000.892 | 85 000 525 | 59 |
| 08.320.1000.832 | 85 000 272 | 59 | 08.320.1000.902 | 3488 017 439 | 47 |
| 08.320.1000.832 | 85 000 521 | 59 | 08.320.1000.902 | 5010 244 093 | 47 |
| 08.320.1000.842 | 3482 000 195 | 19 | 08.320.1000.902 | 5010 244 094 | 47 |
| 08.320.1000.842 | 3482 000 246 | 19 | 08.320.1000.922 | 3482 083 252 | 47 |
| 08.320.1000.842 | 3482 123 534 | 19 | 08.320.1000.922 | 3482 123 247 | 47 |
| 08.320.1000.842 | 518 312 | 19 | 08.320.1000.922 | 5001 837 123 | 47 |
| 08.320.1000.842 | 81.30305.0204 | 19 | 08.320.1000.922 | 5010 244 097 | 47 |
| 08.320.1000.842 | 81.30305.0214 | 19 | 08.320.1000.922 | 5010 244 203 | 47 |
| 08.320.1000.842 | 81.30305.0219 | 19 | 08.320.1000.922 | 5010 244 265 | 47 |
| 08.320.1000.842 | 81.30305.0221 | 19 | 08.320.1000.922 | 5010 837 119 | 47 |
| 08.320.1000.842 | 81.30305.0229 | 19 | 08.320.1000.932 | 0422 6848 | 19;20 |
| 08.320.1000.842 | 81.30305.9221 | 19 | 08.320.1000.932 | 3488 017 447 | 19;20 |
| 08.320.1000.842 | 81.30305.9229 | 19 | 08.320.1000.932 | 81.30000.7220 | 19;20 |
| 08.320.1000.852 | 006 250 34 04 | 31;32 | 08.320.1000.932 | 81.30305.0200 | 19;20 |
| 08.320.1000.852 | 007 250 15 04 | 31;32 | 08.320.1000.932 | 81.30305.0228 | 19;20 |
| 08.320.1000.852 | 0421.346.00 | 31;32 | 08.320.1000.932 | 81.30305.0231 | 19;20 |
| 08.320.1000.852 | 3482 000 463 | 31;32 | 08.320.1000.942 | 1668 927 | 59 |
| 08.320.1000.852 | 3482 123 833 | 31;32 | 08.320.1000.942 | 1669 829 | 59 |
| 08.320.1000.852 | 5654557 | 31;32 | 08.320.1000.942 | 1672 931 | 59 |
| 08.320.1000.862 | 006 250 32 04 | 20;32 | 08.320.1000.942 | 3192 213 | 59 |
| 08.320.1000.862 | 006 250 84 04 | 20;32 | 08.320.1000.942 | 3483 022 032 | 59 |
| 08.320.1000.862 | 3482 000 197 | 20;32 | 08.320.1000.942 | 3483 022 133 | 59 |
| 08.320.1000.862 | 3482 000 464 | 20;32 | 08.320.1000.942 | 8113 601 | 59 |
| 08.320.1000.862 | 3482 123 832 | 20;32 | 08.320.1000.952 | 1521 714 | 59 |
| 08.320.1000.862 | 81.30305.0216 | 20;32 | 08.320.1000.952 | 20 571 923 | 59 |
| 08.320.1000.862 | 81.30305.0223 | 20;32 | 08.320.1000.952 | 3192 203 | 59 |
| 08.320.1000.862 | 81.30305.9223 | 20;32 | 08.320.1000.952 | 3488 022 233 | 59 |

aufsteigend nach ST-Nr. | ascending to ST-No.

| | | | | | |
|------------------------|---------------|----------|------------------------|---------------|-------|
| 08.320.1000.952 | 3488 022 253 | 59 | 08.340.1004.1 S | 020 250 47 01 | 30 |
| 08.320.1000.952 | 8113 515 | 59 | 08.340.1004.1 S | 3400 123 001 | 30 |
| 08.320.1000.952 | 8113 946 | 59 | 08.340.1005.1 S | 020 250 49 01 | 30 |
| 08.320.1000.952 | 8171 494 | 59 | 08.340.1005.1 S | 3400 124 001 | 30 |
| 08.320.1000.952 | 85 000 235 | 59 | 08.340.1006.1 S | 020 250 48 01 | 29;30 |
| 08.320.1000.962 | 1882 331 033 | 19;47;48 | 08.340.1006.1 S | 3400 124 101 | 29;30 |
| 08.320.1000.962 | 5000 841 312 | 19;47;48 | 08.340.1101.1 S | 3400 043 032 | 57 |
| 08.320.1000.962 | 5001 001 629 | 19;47;48 | 08.340.1101.1 S | 8112 191 | 57 |
| 08.320.1000.962 | 632 100 270 | 19;47;48 | 08.340.1101.1 S | 8113 549 | 57 |
| 08.320.1000.962 | 81.30305.0046 | 19;47;48 | 08.340.1101.1 S | 8113 551 | 57 |
| 08.320.1000.962 | 81.30305.0053 | 19;47;48 | 08.340.1101.1 S | 8113 812 | 57 |
| 08.320.1000.962 | 81.30305.0079 | 19;47;48 | 08.340.1101.1 S | 85 000 053 | 57 |
| 08.320.1000.962 | 81.30305.6011 | 19;47;48 | 08.340.1102.1 S | 0190 4754 | 11;45 |
| 08.320.1000.962 | 81.30305.9046 | 19;47;48 | 08.340.1102.1 S | 0190 8500 | 11;45 |
| 08.320.1000.962 | 81.30305.9053 | 19;47;48 | 08.340.1102.1 S | 0190 8503 | 11;45 |
| 08.320.1000.962 | 81.30305.9079 | 19;47;48 | 08.340.1102.1 S | 0190 8504 | 11;45 |
| 08.320.1000.972 | ATRA479 | 6;12;54 | 08.340.1102.1 S | 0190 8558 | 11;45 |
| 08.320.1000.972 | 1375 597 | 6;12;54 | 08.340.1102.1 S | 0299 4119 | 11;45 |
| 08.320.1000.972 | 3482 123 839 | 6;12;54 | 08.340.1102.1 S | 0299 5815 | 11;45 |
| 08.320.1000.972 | 5040 3994 | 6;12;54 | 08.340.1102.1 S | 3400 067 031 | 11;45 |
| 08.320.1000.982 | 1 31220 3220 | 20 | 08.340.1102.1 S | 3400 700 449 | 11;45 |
| 08.320.1000.982 | 3488 017 333 | 20 | 08.340.1102.1 S | 9848 6125 | 11;45 |
| 08.320.1000.982 | 632 101 610 | 20 | 08.340.1103.1 S | 0190 4779 | 11 |
| 08.320.1000.982 | 81.30305.0176 | 20 | 08.340.1103.1 S | 0190 5717 | 11 |
| 08.320.1000.982 | 81.30305.0192 | 20 | 08.340.1103.1 S | 0190 8532 | 11 |
| 08.320.1000.992 | 1521 718 | 60 | 08.340.1103.1 S | 3400 047 031 | 11 |
| 08.320.1000.992 | 1668 919 | 60 | 08.340.1103.1 S | 3400 117 802 | 11 |
| 08.320.1000.992 | 3482 083 042 | 60 | 08.340.1103.1 S | 3400 700 455 | 11 |
| 08.320.1000.992 | 3482 123 234 | 60 | 08.340.1103.1 S | 5003 92642 | 11 |
| 08.320.1000.992 | 8112 598 | 60 | 08.340.1103.1 S | 5003 92643 | 11 |
| 08.320.1000.992 | 85 000 125 | 60 | 08.340.1103.1 S | 5003 92654 | 11 |
| 08.340.1000.33S | 1669 135 | 57 | 08.340.1104.1 S | 1625 966 | 5 |
| 08.340.1000.33S | 1669 657 | 57 | 08.340.1104.1 S | 3400 121 001 | 5 |
| 08.340.1000.33S | 1669 821 | 57 | 08.340.1104.1 S | 3400 121 002 | 5 |
| 08.340.1000.33S | 1672 942 | 57 | 08.340.1105.1 S | 018 250 97 01 | 28 |
| 08.340.1000.33S | 3192 208 | 57 | 08.340.1105.1 S | 021 250 07 01 | 28 |
| 08.340.1000.33S | 3488 018 031 | 57 | 08.340.1105.1 S | 022 250 48 01 | 28 |
| 08.340.1000.33S | 85 000 311 | 57 | 08.340.1105.1 S | 3400 121 501 | 28 |
| 08.340.1001.1 S | 020 250 50 01 | 29 | 08.340.1106.1 S | 020 250 45 01 | 28 |
| 08.340.1001.1 S | 3400 122 501 | 29 | 08.340.1106.1 S | 3400 121 601 | 28 |
| 08.340.1001.1 S | 3400 122 601 | 29 | 08.340.1107.1 S | 3400 122 001 | 53;54 |
| 08.340.1002.1 S | 3400 122 701 | 28 | 08.340.1108.1 S | 1625 968 | 5 |

Vergleichsliste | Crosslist

aufsteigend nach ST-Nr. | ascending to ST-No.

| | | | | | |
|------------------------|---------------|-------|------------------------|---------------|-------|
| 08.340.1108.1 S | 1628 626 | 5 | 08.340.1119.1 S | 4210 3036 | 11 |
| 08.340.1108.1 S | 3400 122 101 | 5 | 08.340.1119.1 S | 5003 35105 | 11 |
| 08.340.1108.1 S | 3400 700 304 | 5 | 08.340.1119.1 S | 5003 35106 | 11 |
| 08.340.1109.1 S | 3400 122 301 | 17 | 08.340.1119.1 S | 5003 35107 | 11 |
| 08.340.1109.1 S | 81.30005.9016 | 17 | 08.340.1119.1 S | 5003 71281 | 11 |
| 08.340.1111.1 S | 3400 122 201 | 17 | 08.340.1119.1 S | 5003 71282 | 11 |
| 08.340.1111.1 S | 3400 125 401 | 17 | 08.340.1119.1 S | 5003 71283 | 11 |
| 08.340.1111.1 S | 3400 127 501 | 17 | 08.340.1119.1 S | 5003 76219 | 11 |
| 08.340.1111.1 S | 81.30005.9012 | 17 | 08.340.1119.1 S | 5040 04160 | 11 |
| 08.340.1111.1 S | 81.30005.9013 | 17 | 08.340.1119.1 S | 5040 64953 | 11 |
| 08.340.1111.1 S | 81.30005.9018 | 17 | 08.340.1119.1 S | 5040 68265 | 11 |
| 08.340.1111.1 S | 81.30005.9021 | 17 | 08.340.1121.1 S | 019 250 02 01 | 28;29 |
| 08.340.1112.1 S | 3400 127 401 | 18 | 08.340.1121.1 S | 020 250 87 01 | 28;29 |
| 08.340.1112.1 S | 81.30000.6582 | 18 | 08.340.1121.1 S | 020 250 91 01 | 28;29 |
| 08.340.1112.1 S | 81.30000.6630 | 18 | 08.340.1121.1 S | 020 250 93 01 | 28;29 |
| 08.340.1112.1 S | 81.30000.6653 | 18 | 08.340.1121.1 S | 021 250 96 01 | 28;29 |
| 08.340.1112.1 S | 81.30005.9022 | 18 | 08.340.1121.1 S | 022 250 14 01 | 28;29 |
| 08.340.1113.1 S | 3400 700 403 | 18 | 08.340.1121.1 S | 022 250 17 01 | 28;29 |
| 08.340.1113.1 S | 81.30000.6579 | 18 | 08.340.1121.1 S | 3400 700 415 | 28;29 |
| 08.340.1113.1 S | 81.30000.6606 | 18 | 08.340.1122.1 S | 018 250 94 01 | 27 |
| 08.340.1113.1 S | 81.30000.6628 | 18 | 08.340.1122.1 S | 3400 127 701 | 27 |
| 08.340.1113.1 S | 81.30000.6657 | 18 | 08.340.1123.1 S | 3400 710 004 | 53 |
| 08.340.1113.1 S | 82.30005.9005 | 18 | 08.340.1124.1 S | 3400 700 344 | 16 |
| 08.340.1114.1 S | 3400 127 101 | 58 | 08.340.1125.1 S | 3400 700 345 | 16 |
| 08.340.1114.1 S | 8113 811 | 58 | 08.340.1150.1 S | 3400 700 406 | 57 |
| 08.340.1115.1 S | 3400 700 314 | 18 | 08.340.1150.1 S | 85 000 313 | 57 |
| 08.340.1115.1 S | 81.30005.9023 | 18 | 08.340.1150.1 S | 85 003 001 | 57 |
| 08.340.1116.1 S | 018 250 96 01 | 28 | 08.340.1151.1 S | 1625 967 | 5 |
| 08.340.1116.1 S | 019 250 65 01 | 28 | 08.340.1151.1 S | 3400 121 101 | 5 |
| 08.340.1116.1 S | 3400 121 301 | 28 | 08.340.1152.1 S | 3400 700 343 | 58 |
| 08.340.1117.1 S | 018 250 95 01 | 27;28 | 08.340.1152.1 S | 85 000 268 | 58 |
| 08.340.1117.1 S | 3400 121 201 | 27;28 | 08.340.1153.1 S | 3400 123 701 | 53 |
| 08.340.1118.1 S | 020 250 51 01 | 30;31 | 08.340.1202.1 S | 3400 128 001 | 31 |
| 08.340.1118.1 S | 3400 122 901 | 30;31 | 08.340.1203.1 S | 020 250 52 01 | 30 |
| 08.340.1119.1 S | 0190 4780 | 11 | 08.340.1203.1 S | 3400 700 411 | 30 |
| 08.340.1119.1 S | 0190 5703 | 11 | 08.340.1204.1 S | 3400 700 425 | 53 |
| 08.340.1119.1 S | 0190 8533 | 11 | 08.340.1205.1 S | 1800 125 301 | 28 |
| 08.340.1119.1 S | 0190 8548 | 11 | 08.340.1206.1 S | 001 250 97 01 | 29 |
| 08.340.1119.1 S | 122422 | 11 | 08.340.1206.1 S | 018 250 91 01 | 29 |
| 08.340.1119.1 S | 122442 | 11 | 08.340.1206.1 S | 018 250 99 01 | 29 |
| 08.340.1119.1 S | 3400 048 031 | 11 | 08.340.1206.1 S | 019 250 00 01 | 29 |
| 08.340.1119.1 S | 3400 117 801 | 11 | 08.340.1206.1 S | 019 250 01 01 | 29 |

aufsteigend nach ST-Nr. | ascending to ST-No.

| | | |
|------------------------|---------------|-------|
| 08.340.1206.1 S | 019 250 05 01 | 29 |
| 08.340.1206.1 S | 020 250 56 01 | 29 |
| 08.340.1206.1 S | 020 250 85 01 | 29 |
| 08.340.1206.1 S | 020 250 86 01 | 29 |
| 08.340.1206.1 S | 020 250 89 01 | 29 |
| 08.340.1206.1 S | 021 250 06 01 | 29 |
| 08.340.1206.1 S | 021 250 08 01 | 29 |
| 08.340.1206.1 S | 021 250 42 01 | 29 |
| 08.340.1206.1 S | 021 250 43 01 | 29 |
| 08.340.1206.1 S | 021 250 62 01 | 29 |
| 08.340.1206.1 S | 021 250 63 01 | 29 |
| 08.340.1206.1 S | 021 250 86 01 | 29 |
| 08.340.1206.1 S | 021 250 94 01 | 29 |
| 08.340.1206.1 S | 021 250 95 01 | 29 |
| 08.340.1206.1 S | 021 250 97 01 | 29 |
| 08.340.1206.1 S | 022 250 09 01 | 29 |
| 08.340.1206.1 S | 022 250 11 01 | 29 |
| 08.340.1206.1 S | 022 250 15 01 | 29 |
| 08.340.1206.1 S | 022 250 56 01 | 29 |
| 08.340.1206.1 S | 022 250 57 01 | 29 |
| 08.340.1206.1 S | 3400 122 801 | 29 |
| 08.340.1206.1 S | 3400 700 413 | 29 |
| 08.340.1207.1 S | 020 250 53 01 | 27 |
| 08.340.1207.1 S | 3400 125 001 | 27 |
| 08.340.1208.1 S | 3400 125 901 | 53 |
| 08.340.1209.1 S | 3400 127 201 | 58 |
| 08.340.1209.1 S | 8113 824 | 58 |
| 08.340.1209.1 S | 8113 825 | 58 |
| 08.340.1220.1 S | 3400 040 032 | 57;58 |
| 08.340.1220.1 S | 8112 160 | 57;58 |
| 08.340.1220.1 S | 8113 547 | 57;58 |
| 08.340.1221.1 S | 3400 117 502 | 45 |
| 08.340.1221.1 S | 3400 117 532 | 45 |
| 08.340.1221.1 S | 5001 843 361 | 45 |
| 08.340.1222.1 S | 3400 121 401 | 27 |
| 08.340.1223.1 S | 3400 121 901 | 17 |
| 08.340.1224.1 S | 3400 123 401 | 45;46 |
| 08.340.1225.1 S | 3400 123 801 | 53 |
| 08.340.1226.1 S | 3400 125 601 | 57 |
| 08.340.1226.1 S | 85 000 185 | 57 |
| 08.340.1227.1 S | 3400 127 901 | 30 |
| 08.340.1228.1 S | 3400 700 301 | 57 |

| | | |
|------------------------|---------------|----------|
| 08.340.1228.1 S | 8113 803 | 57 |
| 08.340.1229.1 S | 3400 700 302 | 17 |
| 08.340.1240.1 S | 3400 700 303 | 17 |
| 08.340.1241.1 S | 3400 700 311 | 45 |
| 08.340.1242.1 S | 3400 700 330 | 45 |
| 08.340.1243.1 S | 3400 700 331 | 46;47 |
| 08.340.1244.1 S | 3400 700 332 | 47 |
| 08.340.1245.1 S | 3400 700 334 | 46 |
| 08.340.1246.1 S | 3400 700 340 | 45 |
| 08.340.1247.1 S | VA.30000.9876 | 18 |
| 08.340.1247.1 S | 3400 700 402 | 18 |
| 08.340.1247.1 S | 81.30000.6577 | 18 |
| 08.340.1247.1 S | 81.30000.6593 | 18 |
| 08.340.1247.1 S | 81.30000.6621 | 18 |
| 08.340.1247.1 S | 81.30005.9026 | 18 |
| 08.340.1247.1 S | 82.30005.9004 | 18 |
| 08.340.1248.1 S | 3400 700 404 | 18;19;42 |
| 08.340.1248.1 S | 81.30000.6572 | 18;19;42 |
| 08.340.1248.1 S | 81.30000.6592 | 18;19;42 |
| 08.340.1248.1 S | 82.30005.9006 | 18;19;42 |
| 08.340.1249.1 S | 3400 700 408 | 46 |
| 08.340.1249.1 S | 5001 486 489 | 46 |
| 08.340.1260.1 S | 3400 700 409 | 46 |
| 08.340.1260.1 S | 5001 859 387 | 46 |
| 08.340.1261.1 S | 3400 700 410 | 46 |
| 08.340.1262.1 S | 018 250 98 01 | 29 |
| 08.340.1262.1 S | 3400 700 414 | 29 |
| 08.340.1263.1 S | 020 250 54 01 | 27 |
| 08.340.1263.1 S | 3400 700 417 | 27 |
| 08.340.1265.1 S | 3400 700 401 | 47;58 |
| 08.340.1265.1 S | 8113 813 | 47;58 |
| 08.340.1265.1 S | 85 000 542 | 47;58 |
| 08.340.1266.1 S | 3400 125 101 | 27 |
| 08.340.1267.1 S | 0190 8517 | 11 |
| 08.340.1267.1 S | 3400 700 312 | 11 |
| 08.340.1267.1 S | 50033 5098 | 11 |
| 08.340.1267.1 S | 50033 5101 | 11 |
| 08.340.1268.1 S | 3400 700 428 | 5 |
| 08.340.1269.1 S | 3400 700 422 | 57 |
| 08.340.1270.1 S | 3400 121 801 | 17;18 |

Vergleichsliste | Crosslist

aufsteigend nach Vergleichsnummer | ascending to Comp.-No.

| ASTRA | | |
|--------------|------------------------|---------------|
| 100127 | 08.270.1000.540 | 7;12;34;42 |
| 100128 | 08.290.7000.060 | 9;14;24;51 |
| 101647 | 08.270.1000.590 | 36;43;49 |
| 12 3157 | 08.290.7000.020 | 9;15;25;40;51 |
| 122422 | 08.340.1119.1 S | 11 |
| 122442 | 08.340.1119.1 S | 11 |
| 123156 | 08.270.1000.603 | 14 |
| 123762 | 08.270.1000.761 | 8;14 |
| 151517 | 08.270.1000.761 | 8;14 |
| 55010 | 08.270.1000.681 | 13 |

| AUWÄRTER | | |
|-----------------|------------------------|-------------------|
| 0101.110.06 | 08.290.7000.150 | 39 |
| 0401.101.00 | 08.320.1000.200 | 20;32;42 |
| 0401.101.10 | 08.270.1000.590 | 36;43;49 |
| 0401.101.11 | 08.270.1000.590 | 36;43;49 |
| 0401.101.21 | 08.270.1000.590 | 36;43;49 |
| 0401.103.00 | 08.320.1000.802 | 31 |
| 0401.109.00 | 08.320.1000.762 | 54 |
| 0401.112.00 | 08.320.1000.742 | 31 |
| 0401.113.01 | 08.270.1000.540 | 7;12;34;42 |
| 0401.115.01 | 08.270.1000.951 | 21;35;48;60 |
| 0401.116.10 | 08.290.7000.180 | 39;40 |
| 0401.145.00 | 08.270.1000.650 | 36;43 |
| 0401.149.00 | 08.270.1000.530 | 13;21;22;35;48;49 |
| 0401.170.10 | 08.320.1000.622 | 12;20;32 |
| 0401.172.00 | 08.290.7000.160 | 9;14;15;24;51 |
| 0401.191.00 | 08.270.1000.653 | 22 |
| 0401.192.00 | 08.290.7000.060 | 9;14;24;51 |
| 0401.197.00 | 08.290.7000.050 | 39 |
| 0401.20264 | 08.270.1000.560 | 34;42 |
| 0421.003.00 | 08.320.1000.742 | 31 |
| 0421.009.00 | 08.320.1000.682 | 6;54 |
| 0421.018.00 | 08.320.1000.792 | 11;12;19 |
| 0421.306.00 | 08.270.1000.951 | 21;35;48;60 |
| 0421.307.00 | 08.270.1000.751 | 22;43;49 |
| 0421.308.00 | 08.270.1000.751 | 22;43;49 |
| 0421.310.00 | 08.270.1000.653 | 22 |
| 0421.316.00 | 08.270.1000.583 | 7;12;13;21 |
| 0421.323.00 | 08.270.1000.630 | 36;42;43 |
| 0421.324.00 | 08.270.1000.881 | 14;23;24;37;43;50 |

| AUWÄRTER | | |
|-----------------|------------------------|-------------------|
| 0421.327.10 | 08.270.1000.831 | 22;23;36;37 |
| 0421.330.00 | 08.270.1000.533 | 13;21 |
| 0421.333.00 | 08.270.1000.583 | 7;12;13;21 |
| 0421.341.10 | 08.270.1000.620 | 35;55 |
| 0421.342.00 | 08.270.1000.661 | 36;42 |
| 0421.346.00 | 08.320.1000.852 | 31;32 |
| 0421.354.00 | 08.270.1000.791 | 23;37 |
| 0421.506.00 | 08.290.7000.130 | 40 |
| 0421.509.00 | 08.290.7000.290 | 24;51 |
| 11000033 | 08.290.7000.080 | 39;44 |
| 11009713 | 08.270.1000.590 | 36;43;49 |
| 11009734 | 08.290.7000.160 | 9;14;15;24;51 |
| 11009965 | 08.320.1000.682 | 6;54 |
| 11009971 | 08.320.1000.792 | 11;12;19 |
| 11009979 | 08.320.1000.210 | 32 |
| 11009985 | 08.320.1000.792 | 11;12;19 |
| 11009986 | 08.320.1000.792 | 11;12;19 |
| 11009992 | 08.270.1000.500 | 8;23;37 |
| 11009996 | 08.270.1000.630 | 36;42;43 |
| 11009997 | 08.270.1000.881 | 14;23;24;37;43;50 |
| 1101 0000 | 08.270.1000.881 | 14;23;24;37;43;50 |
| 11010004 | 08.270.1000.771 | 22 |
| 11010005 | 08.270.1000.831 | 22;23;36;37 |
| 11010032 | 08.270.1000.791 | 23;37 |
| 11010039 | 08.290.7000.130 | 40 |
| 11060226 | 08.270.1000.881 | 14;23;24;37;43;50 |
| 11079830 | 08.270.1000.881 | 14;23;24;37;43;50 |
| 11079872 | 08.270.1000.791 | 23;37 |
| 20275 | 08.270.1000.540 | 7;12;34;42 |
| 20276 | 08.270.1000.520 | 7;35;48 |
| 20281 | 08.270.1000.590 | 36;43;49 |
| 20292 | 08.320.1000.802 | 31 |
| 20293 | 08.320.1000.200 | 20;32;42 |
| 20297 | 08.320.1000.200 | 20;32;42 |
| 42134710 | 08.270.1000.791 | 23;37 |

| AVIA | | |
|-------------|------------------------|----|
| 402-150031 | 08.320.1000.280 | 20 |
| 431202003 | 08.320.1000.260 | 26 |

| BOVA | | |
|-------------|------------------------|---------|
| 193852 | 08.270.1000.500 | 8;23;37 |

aufsteigend nach Vergleichsnummer | ascending to Comp.-No.

| BOVA | | |
|-------------|------------------------|------------|
| 193853 | 08.320.1000.250 | 16 |
| 193853 | 08.320.1000.270 | 26 |
| 212049 | 08.320.1000.682 | 6;54 |
| 212053 | 08.290.7000.040 | 9 |
| 216169 | 08.320.1000.682 | 6;54 |
| 223810 | 08.290.7000.040 | 9 |
| 223811 | 08.270.1000.803 | 8 |
| 223971 | 08.320.1000.622 | 12;20;32 |
| 234502 | 08.270.1000.721 | 7 |
| 257128 | 08.320.1000.702 | 5;6 |
| 267748 | 08.270.1000.633 | 8;23;37;43 |
| 270054 | 08.270.1000.803 | 8 |
| 270074 | 08.270.1000.721 | 7 |
| 270566 | 08.290.7000.560 | 25;41;44 |
| 270574 | 08.270.1000.500 | 8;23;37 |
| 276261 | 08.270.1000.500 | 8;23;37 |

| CASE IH | | |
|----------------|------------------------|-------|
| 324 4926 R91 | 08.320.1000.602 | 12;31 |
| 3544 33A1 | 08.270.1000.570 | 34 |

| CATERPILLAR | | |
|--------------------|------------------------|------------|
| 106-8888 | 08.270.1000.540 | 7;12;34;42 |

| CLAAS | | |
|--------------|------------------------|------------|
| 609 421.0 | 08.290.7000.060 | 9;14;24;51 |

| DAEWOO | | |
|---------------|------------------------|---------------|
| M408541 | 08.290.7000.090 | 9;14;24;51;63 |

| DAF | | |
|------------|------------------------|-----------|
| ATRA245 | 08.320.1000.340 | 6 |
| ATRB257 | 08.320.1000.340 | 6 |
| 0078 866 | 08.320.1000.682 | 6;54 |
| 0165 495 | 08.270.1000.553 | 7;8;49;55 |
| 0286 877 | 08.320.1000.652 | 5;19 |
| 0660 306 | 08.320.1000.300 | 6;33 |
| 070 763 | 08.290.7000.300 | 9;40 |
| 0755 079 | 08.270.1000.803 | 8 |
| 078 544 | 08.320.1000.210 | 32 |
| 078 867 | 08.270.1000.721 | 7 |

| DAF | | |
|------------|------------------------|---------------|
| 096 001 | 08.270.1000.540 | 7;12;34;42 |
| 096 006 | 08.270.1000.553 | 7;8;49;55 |
| 113 365 | 08.290.7000.160 | 9;14;15;24;51 |
| 1140 537 | 08.270.1000.633 | 8;23;37;43 |
| 1140 539 | 08.320.1000.210 | 32 |
| 1204 205 | 08.320.1000.702 | 5;6 |
| 1230 549 | 08.320.1000.682 | 6;54 |
| 1230 550 | 08.320.1000.682 | 6;54 |
| 1239 659 | 08.270.1000.721 | 7 |
| 1250 710 | 08.290.7000.000 | 9;24;25 |
| 1267 988 | 08.290.7000.090 | 9;14;24;51;63 |
| 1272 115 | 08.270.1000.721 | 7 |
| 1287 597 | 08.270.1000.721 | 7 |
| 1287 806 | 08.290.7000.040 | 9 |
| 1287 899 | 08.270.1000.803 | 8 |
| 1303 560 | 08.270.1000.721 | 7 |
| 1303 702 | 08.270.1000.761 | 8;14 |
| 1303 707 | 08.290.7000.420 | 9;10;25 |
| 1303 975 | 08.290.7000.000 | 9;24;25 |
| 1304 280 | 08.320.1000.340 | 6 |
| 1304 280R | 08.320.1000.340 | 6 |
| 1307 569 | 08.270.1000.711 | 7;21 |
| 1310 137 | 08.290.7000.090 | 9;14;24;51;63 |
| 1310 896 | 08.320.1000.682 | 6;54 |
| 1311 497 | 08.290.7000.420 | 9;10;25 |
| 1329 459R | 08.320.1000.702 | 5;6 |
| 1329 549 | 08.320.1000.702 | 5;6 |
| 1331 326 | 08.270.1000.520 | 7;35;48 |
| 1334 350 | 08.290.7000.040 | 9 |
| 1342 345 | 08.270.1000.721 | 7 |
| 1347 696 | 08.270.1000.520 | 7;35;48 |
| 1348 131 | 08.270.1000.711 | 7;21 |
| 1348 133 | 08.270.1000.583 | 7;12;13;21 |
| 1348 142 | 08.270.1000.803 | 8 |
| 1348 142R | 08.270.1000.803 | 8 |
| 1348 146R | 08.270.1000.540 | 7;12;34;42 |
| 1362 752 | 08.290.7000.000 | 9;24;25 |
| 1362 759 | 08.270.1000.721 | 7 |
| 1368 693 | 08.290.7000.560 | 25;41;44 |
| 1375 593 | 08.270.1000.673 | 7;13 |
| 1375 593R | 08.270.1000.673 | 7;13 |

Vergleichsliste | Crosslist

aufsteigend nach Vergleichsnummer | ascending to Comp.-No.

| DAF | | |
|-----------|------------------------|---------------|
| 1375 597 | 08.320.1000.972 | 6;12;54 |
| 1385 520 | 08.270.1000.711 | 7;21 |
| 1385 522 | 08.270.1000.721 | 7 |
| 1395 695 | 08.270.1000.803 | 8 |
| 1395 695R | 08.270.1000.803 | 8 |
| 1395 696 | 08.270.1000.761 | 8;14 |
| 1395 699 | 08.270.1000.520 | 7;35;48 |
| 1400 510 | 08.270.1000.693 | 7;21 |
| 1409 478 | 08.270.1000.693 | 7;21 |
| 1440 715 | 08.270.1000.500 | 8;23;37 |
| 1447 243 | 08.270.1000.683 | 7 |
| 1614 294 | 08.270.1000.500 | 8;23;37 |
| 1615 927 | 08.290.7000.020 | 9;15;25;40;51 |
| 1625 966 | 08.340.1104.1 S | 5 |
| 1625 967 | 08.340.1151.1 S | 5 |
| 1625 968 | 08.340.1108.1 S | 5 |
| 1628 626 | 08.340.1108.1 S | 5 |
| 1634 627 | 08.290.7000.020 | 9;15;25;40;51 |
| 165 495 | 08.270.1000.553 | 7;8;49;55 |
| 165 497 | 08.270.1000.520 | 7;35;48 |
| 1664 346 | 08.290.7000.000 | 9;24;25 |
| 1689 108 | 08.270.1000.721 | 7 |
| 1689 145 | 08.270.1000.500 | 8;23;37 |
| 252 683 | 08.270.1000.540 | 7;12;34;42 |
| 279 810 | 08.290.7000.090 | 9;14;24;51;63 |
| 291 228 | 08.320.1000.682 | 6;54 |
| 373 895 | 08.270.1000.540 | 7;12;34;42 |
| 376 490 | 08.270.1000.520 | 7;35;48 |
| 378 012 | 08.270.1000.583 | 7;12;13;21 |
| 387 012 | 08.270.1000.583 | 7;12;13;21 |
| 514 454 | 08.290.7000.090 | 9;14;24;51;63 |
| 558 111 | 08.270.1000.520 | 7;35;48 |
| 623 212 | 08.270.1000.540 | 7;12;34;42 |
| 658 418 | 08.290.7000.060 | 9;14;24;51 |
| 658 428 | 08.290.7000.060 | 9;14;24;51 |
| 659 320 | 08.290.7000.090 | 9;14;24;51;63 |
| 661 066 | 08.270.1000.520 | 7;35;48 |
| 669 372 | 08.270.1000.583 | 7;12;13;21 |
| 740 789 | 08.270.1000.520 | 7;35;48 |
| 740 790 | 08.270.1000.520 | 7;35;48 |
| 740 791 | 08.270.1000.583 | 7;12;13;21 |

| DAF | | |
|---------|------------------------|------------|
| 740 792 | 08.270.1000.583 | 7;12;13;21 |
| 740 794 | 08.270.1000.540 | 7;12;34;42 |
| 751 952 | 08.270.1000.520 | 7;35;48 |
| 755 079 | 08.270.1000.803 | 8 |

| DENNIS | | |
|----------|------------------------|---------------|
| 651133 | 08.320.1000.802 | 31 |
| 651332 | 08.290.7000.060 | 9;14;24;51 |
| 651390 | 08.290.7000.160 | 9;14;15;24;51 |
| 657310-2 | 08.290.7000.020 | 9;15;25;40;51 |

| DEUTZ | | |
|-----------|------------------------|----------|
| 0422 6857 | 08.290.7000.560 | 25;41;44 |

| DEUTZ-FAHR | | |
|-------------------|------------------------|---------------|
| K 18035 | 08.270.1000.811 | 12;34 |
| 0117 2721 | 08.290.7000.160 | 9;14;15;24;51 |
| 01174189 | 08.270.1000.941 | 21;35;48 |
| 0126 1558 | 08.290.7000.060 | 9;14;24;51 |
| 02246046 | 08.270.1000.811 | 12;34 |
| 0292 2101 | 08.290.7000.060 | 9;14;24;51 |
| 0422 6846 | 08.270.1000.643 | 22 |
| 0422 6848 | 08.320.1000.932 | 19;20 |
| 0627 6678 | 08.290.7000.090 | 9;14;24;51;63 |
| 0627 6681 | 08.320.1000.602 | 12;31 |
| 117 3274 | 08.320.1000.220 | 31 |
| 1-2123-300-620.00 | 08.290.7000.090 | 9;14;24;51;63 |
| 1-2123-300-620.01 | 08.290.7000.090 | 9;14;24;51;63 |

| DRÖGMÖLLER | | |
|-----------------|------------------------|-------------|
| 000250201001-00 | 08.270.1000.951 | 21;35;48;60 |
| 000250201100 | 08.320.1000.200 | 20;32;42 |
| 000250202000-00 | 08.270.1000.590 | 36;43;49 |
| 400250100002-00 | 08.290.7000.130 | 40 |
| 400250100003-00 | 08.320.1000.692 | 32 |
| 400250100004-00 | 08.270.1000.630 | 36;42;43 |

| EICHER | | |
|-------------|------------------------|------------|
| 148 291 | 08.290.7000.060 | 9;14;24;51 |
| 3141 909 M1 | 08.320.1000.602 | 12;31 |

| ENASA | | |
|---------|------------------------|----|
| 774 106 | 08.320.1000.210 | 32 |

aufsteigend nach Vergleichsnummer | ascending to Comp.-No.

| ENASA | | |
|--------------|------------------------|----|
| 774 691 | 08.320.1000.210 | 32 |

| EVOBUS | | |
|-----------------|------------------------|---------------|
| 8.323.291.000 | 08.270.1000.603 | 14 |
| 8.383.145.000 | 08.270.1000.650 | 36;43 |
| 8.383.146.000 | 08.320.1000.200 | 20;32;42 |
| 8.383.154.000 | 08.290.7000.060 | 9;14;24;51 |
| 8.383.156.000 | 08.270.1000.801 | 34 |
| 8.383.189.000 | 08.290.7000.160 | 9;14;15;24;51 |
| 8.383.192.000 | 08.320.1000.802 | 31 |
| 8.383.195.000 | 08.270.1000.583 | 7;12;13;21 |
| 8.383.203.000 | 08.270.1000.583 | 7;12;13;21 |
| 8.383.211.000 | 08.320.1000.602 | 12;31 |
| 8.383.225.000 | 08.270.1000.951 | 21;35;48;60 |
| 8.383.226.185 | 08.290.7000.180 | 39;40 |
| 8.383.243.000 | 08.270.1000.653 | 22 |
| 8.383.248.000 | 08.290.7000.180 | 39;40 |
| 8.383.254.000 | 08.320.1000.210 | 32 |
| 8.383.260.000 | 08.270.1000.751 | 22;43;49 |
| 8.383.262.000 | 08.270.1000.951 | 21;35;48;60 |
| 8.383.263.000 | 08.270.1000.653 | 22 |
| 8.383.265.000 | 08.270.1000.583 | 7;12;13;21 |
| 8.383.267.000 | 08.270.1000.671 | 37 |
| 8.383.268.000 | 08.320.1000.210 | 32 |
| 8.383.276.000 | 08.270.1000.540 | 7;12;34;42 |
| 8.383.281.000 | 08.270.1000.630 | 36;42;43 |
| 8.383.282.000 | 08.290.7000.130 | 40 |
| 8.383.286.000 | 08.270.1000.500 | 8;23;37 |
| 8.383.292.000 | 08.320.1000.792 | 11;12;19 |
| 8.383.312.000 | 08.270.1000.751 | 22;43;49 |
| 8.383.319.000 | 08.320.1000.210 | 32 |
| 8.383.321.000 | 08.270.1000.791 | 23;37 |
| 8.383.335.000 | 08.270.1000.630 | 36;42;43 |
| 8.383.335.000.0 | 08.270.1000.630 | 36;42;43 |
| 8.383.339.000 | 08.320.1000.270 | 26 |
| 8.383.343.000 | 08.320.1000.210 | 32 |
| 8.383.344.000 | 08.320.1000.612 | 32 |
| 8.389.335.000 | 08.270.1000.630 | 36;42;43 |

| FAUN | | |
|-------------|------------------------|---------|
| ATRA479 | 08.320.1000.972 | 6;12;54 |

| FAUN | | |
|---------------|------------------------|-------------------|
| 0890 238 | 08.290.7000.060 | 9;14;24;51 |
| 0890-261 | 08.270.1000.811 | 12;34 |
| 0890-340 | 08.290.7000.060 | 9;14;24;51 |
| 0890-359 | 08.270.1000.580 | 34 |
| 0890-374 | 08.270.1000.530 | 13;21;22;35;48;49 |
| 0890-589 | 08.320.1000.200 | 20;32;42 |
| 0890-591 | 08.290.7000.080 | 39;44 |
| 0890-633 | 08.270.1000.951 | 21;35;48;60 |
| 3630-0898-151 | 08.290.7000.060 | 9;14;24;51 |
| 8406-404 | 08.270.1000.951 | 21;35;48;60 |
| 8407-439 | 08.270.1000.951 | 21;35;48;60 |
| 8433035 | 08.270.1000.941 | 21;35;48 |
| 99707010805 | 08.290.7000.020 | 9;15;25;40;51 |
| 99707793317 | 08.270.1000.881 | 14;23;24;37;43;50 |

| FENDT | | |
|------------------|------------------------|------------|
| F281.100.100.010 | 08.290.7000.060 | 9;14;24;51 |
| H199.104.100.010 | 08.290.7000.060 | 9;14;24;51 |
| 345.100.100.020 | 08.290.7000.060 | 9;14;24;51 |

| GOTTWALD | | |
|-----------------|------------------------|---------------|
| 352 193 | 08.290.7000.090 | 9;14;24;51;63 |

| HANOMAG | | |
|-------------------|------------------------|---------------|
| X 86.0546.9087-09 | 08.290.7000.090 | 9;14;24;51;63 |
| 000 250 18 15 | 08.290.7000.080 | 39;44 |

| HARNISCHFEGER | | |
|----------------------|------------------------|---------------|
| 122 222 | 08.270.1000.533 | 13;21 |
| 122 222 | 08.290.7000.160 | 9;14;15;24;51 |
| 123 614 | 08.290.7000.160 | 9;14;15;24;51 |

| HINO | | |
|-------------|------------------------|----------|
| 31210-0178A | 08.320.1000.792 | 11;12;19 |
| 31210-3200A | 08.320.1000.792 | 11;12;19 |
| 31230-1150A | 08.290.7000.000 | 9;24;25 |
| 31250-6480A | 08.270.1000.500 | 8;23;37 |

| IRISBUS | | |
|----------------|------------------------|------------|
| 112590 | 08.270.1000.540 | 7;12;34;42 |
| 123165 | 08.270.1000.503 | 13 |

Vergleichsliste | Crosslist

aufsteigend nach Vergleichsnummer | ascending to Comp.-No.

| IRISBUS | | |
|--------------|------------------------|---------------|
| 30196 | 08.290.7000.160 | 9;14;15;24;51 |
| 500397755 | 08.290.7000.020 | 9;15;25;40;51 |
| 500397756 | 08.270.1000.500 | 8;23;37 |
| 5010 556 021 | 08.270.1000.503 | 13 |
| 5010 556 174 | 08.270.1000.503 | 13 |
| 504091142 | 08.290.7000.020 | 9;15;25;40;51 |

| ISUZU | | |
|---------------|------------------------|---------------|
| 1 Jx046 4770 | 08.270.1000.791 | 23;37 |
| 1 JX046 4780 | 08.320.1000.250 | 16 |
| 1 31220 3220 | 08.320.1000.982 | 20 |
| 1-31240-905-0 | 08.270.1000.912 | 49 |
| 1-31310-011-0 | 08.290.7000.020 | 9;15;25;40;51 |

| IVECO | | |
|-----------|------------------------|-------------------|
| 0010 0128 | 08.290.7000.060 | 9;14;24;51 |
| 0126 0096 | 08.270.1000.811 | 12;34 |
| 0126 1558 | 08.290.7000.060 | 9;14;24;51 |
| 0126 1902 | 08.270.1000.533 | 13;21 |
| 0127 1999 | 08.270.1000.530 | 13;21;22;35;48;49 |
| 0127 8624 | 08.270.1000.530 | 13;21;22;35;48;49 |
| 0139 8598 | 08.290.7000.060 | 9;14;24;51 |
| 0180 5282 | 08.290.7000.020 | 9;15;25;40;51 |
| 0190 3816 | 08.270.1000.533 | 13;21 |
| 0190 3836 | 08.270.1000.681 | 13 |
| 0190 3845 | 08.270.1000.681 | 13 |
| 0190 3850 | 08.270.1000.811 | 12;34 |
| 0190 3853 | 08.320.1000.622 | 12;20;32 |
| 0190 3854 | 08.270.1000.540 | 7;12;34;42 |
| 0190 3855 | 08.270.1000.811 | 12;34 |
| 0190 3860 | 08.270.1000.540 | 7;12;34;42 |
| 0190 3862 | 08.270.1000.681 | 13 |
| 0190 3865 | 08.270.1000.681 | 13 |
| 0190 3871 | 08.270.1000.583 | 7;12;13;21 |
| 0190 3872 | 08.270.1000.533 | 13;21 |
| 0190 3873 | 08.270.1000.530 | 13;21;22;35;48;49 |
| 0190 3874 | 08.270.1000.533 | 13;21 |
| 0190 3876 | 08.270.1000.583 | 7;12;13;21 |
| 0190 3877 | 08.270.1000.533 | 13;21 |
| 0190 3879 | 08.270.1000.681 | 13 |
| 0190 3881 | 08.270.1000.681 | 13 |

| IVECO | | |
|-----------|------------------------|-------------------|
| 0190 3884 | 08.270.1000.553 | 7;8;49;55 |
| 0190 3886 | 08.270.1000.681 | 13 |
| 0190 3887 | 08.270.1000.553 | 7;8;49;55 |
| 0190 3890 | 08.320.1000.602 | 12;31 |
| 0190 3899 | 08.290.7000.160 | 9;14;15;24;51 |
| 0190 3899 | 08.270.1000.681 | 13 |
| 0190 3900 | 08.270.1000.533 | 13;21 |
| 0190 3911 | 08.270.1000.681 | 13 |
| 0190 3924 | 08.270.1000.681 | 13 |
| 0190 3925 | 08.270.1000.533 | 13;21 |
| 0190 3929 | 08.320.1000.622 | 12;20;32 |
| 0190 3936 | 08.290.7000.160 | 9;14;15;24;51 |
| 0190 3936 | 08.270.1000.553 | 7;8;49;55 |
| 0190 3937 | 08.270.1000.553 | 7;8;49;55 |
| 0190 3938 | 08.270.1000.553 | 7;8;49;55 |
| 0190 3939 | 08.270.1000.553 | 7;8;49;55 |
| 0190 3940 | 08.270.1000.553 | 7;8;49;55 |
| 0190 3941 | 08.270.1000.553 | 7;8;49;55 |
| 0190 3946 | 08.270.1000.583 | 7;12;13;21 |
| 0190 3947 | 08.270.1000.583 | 7;12;13;21 |
| 0190 3948 | 08.270.1000.811 | 12;34 |
| 0190 3949 | 08.270.1000.811 | 12;34 |
| 0190 3953 | 08.270.1000.540 | 7;12;34;42 |
| 0190 3954 | 08.270.1000.540 | 7;12;34;42 |
| 0190 3956 | 08.270.1000.530 | 13;21;22;35;48;49 |
| 0190 4705 | 08.320.1000.602 | 12;31 |
| 0190 4711 | 08.270.1000.761 | 8;14 |
| 0190 4713 | 08.270.1000.533 | 13;21 |
| 0190 4714 | 08.270.1000.533 | 13;21 |
| 0190 4715 | 08.270.1000.533 | 13;21 |
| 0190 4716 | 08.270.1000.533 | 13;21 |
| 0190 4717 | 08.270.1000.533 | 13;21 |
| 0190 4729 | 08.270.1000.603 | 14 |
| 0190 4730 | 08.270.1000.761 | 8;14 |
| 0190 4751 | 08.270.1000.603 | 14 |
| 0190 4751 | 08.320.1000.792 | 11;12;19 |
| 0190 4752 | 08.320.1000.792 | 11;12;19 |
| 0190 4752 | 08.270.1000.761 | 8;14 |
| 0190 4754 | 08.340.1102.1 S | 11;45 |
| 0190 4756 | 08.290.7000.020 | 9;15;25;40;51 |
| 0190 4761 | 08.270.1000.681 | 13 |

aufsteigend nach Vergleichsnummer | ascending to Comp.-No.

| IVECO | | |
|-----------|------------------------|-------------------|
| 0190 4762 | 08.270.1000.681 | 13 |
| 0190 4763 | 08.270.1000.681 | 13 |
| 0190 4772 | 08.320.1000.602 | 12;31 |
| 0190 4779 | 08.270.1000.761 | 8;14 |
| 0190 4779 | 08.290.7000.020 | 9;15;25;40;51 |
| 0190 4779 | 08.340.1103.1 S | 11 |
| 0190 4779 | 08.320.1000.792 | 11;12;19 |
| 0190 4780 | 08.320.1000.792 | 11;12;19 |
| 0190 4780 | 08.340.1119.1 S | 11 |
| 0190 4785 | 08.270.1000.901 | 13;14 |
| 0190 4785 | 08.290.7000.020 | 9;15;25;40;51 |
| 0190 4790 | 08.270.1000.761 | 8;14 |
| 0190 4796 | 08.290.7000.020 | 9;15;25;40;51 |
| 0190 4796 | 08.270.1000.503 | 13 |
| 0190 5274 | 08.290.7000.140 | 14;51 |
| 0190 5282 | 08.290.7000.020 | 9;15;25;40;51 |
| 0190 5703 | 08.340.1119.1 S | 11 |
| 0190 5717 | 08.340.1103.1 S | 11 |
| 0190 5840 | 08.270.1000.761 | 8;14 |
| 0190 8500 | 08.340.1102.1 S | 11;45 |
| 0190 8503 | 08.340.1102.1 S | 11;45 |
| 0190 8504 | 08.340.1102.1 S | 11;45 |
| 0190 8508 | 08.290.7000.020 | 9;15;25;40;51 |
| 0190 8508 | 08.270.1000.603 | 14 |
| 0190 8517 | 08.340.1267.1 S | 11 |
| 0190 8518 | 08.270.1000.761 | 8;14 |
| 0190 8518 | 08.290.7000.020 | 9;15;25;40;51 |
| 0190 8524 | 08.290.7000.020 | 9;15;25;40;51 |
| 0190 8524 | 08.270.1000.603 | 14 |
| 0190 8532 | 08.340.1103.1 S | 11 |
| 0190 8533 | 08.340.1119.1 S | 11 |
| 0190 8548 | 08.340.1119.1 S | 11 |
| 0190 8558 | 08.340.1102.1 S | 11;45 |
| 0244 0924 | 08.290.7000.060 | 9;14;24;51 |
| 0244 2557 | 08.270.1000.530 | 13;21;22;35;48;49 |
| 0244 2558 | 08.270.1000.530 | 13;21;22;35;48;49 |
| 0244 3133 | 08.290.7000.160 | 9;14;15;24;51 |
| 0247 5546 | 08.290.7000.090 | 9;14;24;51;63 |
| 0247 5547 | 08.290.7000.090 | 9;14;24;51;63 |
| 0247 5629 | 08.290.7000.160 | 9;14;15;24;51 |
| 0247 6075 | 08.270.1000.811 | 12;34 |

| IVECO | | |
|-----------|------------------------|-------------------|
| 0247 6483 | 08.320.1000.622 | 12;20;32 |
| 0247 7136 | 08.270.1000.533 | 13;21 |
| 0247 7897 | 08.270.1000.681 | 13 |
| 0247 7926 | 08.270.1000.533 | 13;21 |
| 0247 7929 | 08.270.1000.533 | 13;21 |
| 0247 7930 | 08.270.1000.530 | 13;21;22;35;48;49 |
| 0247 7936 | 08.270.1000.811 | 12;34 |
| 0247 8592 | 08.270.1000.583 | 7;12;13;21 |
| 0247 9048 | 08.290.7000.160 | 9;14;15;24;51 |
| 0256 5803 | 08.290.7000.090 | 9;14;24;51;63 |
| 0299 1587 | 08.270.1000.681 | 13 |
| 0299 2486 | 08.290.7000.020 | 9;15;25;40;51 |
| 0299 4119 | 08.340.1102.1 S | 11;45 |
| 0299 5815 | 08.340.1102.1 S | 11;45 |
| 0342 8017 | 08.290.7000.060 | 9;14;24;51 |
| 0445 7823 | 08.270.1000.681 | 13 |
| 0445 9823 | 08.270.1000.681 | 13 |
| 0469 1736 | 08.270.1000.681 | 13 |
| 0469 5661 | 08.270.1000.533 | 13;21 |
| 0469 9161 | 08.270.1000.553 | 7;8;49;55 |
| 0473 8961 | 08.270.1000.553 | 7;8;49;55 |
| 0473 9151 | 08.270.1000.553 | 7;8;49;55 |
| 0474 1461 | 08.270.1000.681 | 13 |
| 0474 1464 | 08.270.1000.553 | 7;8;49;55 |
| 0476 6075 | 08.270.1000.533 | 13;21 |
| 0476 9116 | 08.270.1000.533 | 13;21 |
| 0477 4151 | 08.290.7000.060 | 9;14;24;51 |
| 0478 7273 | 08.290.7000.060 | 9;14;24;51 |
| 0483 7884 | 08.270.1000.553 | 7;8;49;55 |
| 0483 9133 | 08.270.1000.533 | 13;21 |
| 0485 7270 | 08.270.1000.533 | 13;21 |
| 0813 2554 | 08.270.1000.761 | 8;14 |
| 4200 3396 | 08.290.7000.090 | 9;14;24;51;63 |
| 4200 3397 | 08.290.7000.090 | 9;14;24;51;63 |
| 4200 3473 | 08.290.7000.160 | 9;14;15;24;51 |
| 4200 3474 | 08.290.7000.160 | 9;14;15;24;51 |
| 4200 3545 | 08.270.1000.583 | 7;12;13;21 |
| 4200 3658 | 08.290.7000.160 | 9;14;15;24;51 |
| 4200 3823 | 08.290.7000.060 | 9;14;24;51 |
| 4200 3834 | 08.290.7000.060 | 9;14;24;51 |
| 4201 4718 | 08.270.1000.533 | 13;21 |

Vergleichsliste | Crosslist



aufsteigend nach Vergleichsnummer | ascending to Comp.-No.

| IVECO | | |
|---------------|------------------------|-------------------|
| 4201 6352 | 08.320.1000.602 | 12;31 |
| 4202 2205 | 08.290.7000.420 | 9;10;25 |
| 4202 2207 E64 | 08.270.1000.881 | 14;23;24;37;43;50 |
| 4202 6352 | 08.320.1000.602 | 12;31 |
| 4202 6354 | 08.320.1000.602 | 12;31 |
| 4202 6470 | 08.270.1000.583 | 7;12;13;21 |
| 4202 6898 | 08.290.7000.160 | 9;14;15;24;51 |
| 4202 6899 | 08.290.7000.160 | 9;14;15;24;51 |
| 4203 7449 | 08.270.1000.583 | 7;12;13;21 |
| 4203 7450 | 08.270.1000.583 | 7;12;13;21 |
| 4206 1921 | 08.290.7000.090 | 9;14;24;51;63 |
| 4206 2098 | 08.270.1000.761 | 8;14 |
| 4206 2103 | 08.270.1000.761 | 8;14 |
| 4206 2185 | 08.270.1000.603 | 14 |
| 4206 2613 | 08.270.1000.553 | 7;8;49;55 |
| 4206 2916 | 08.270.1000.761 | 8;14 |
| 4206 3099 | 08.270.1000.603 | 14 |
| 4206 3184 | 08.290.7000.160 | 9;14;15;24;51 |
| 4206 4318 | 08.270.1000.761 | 8;14 |
| 4206 6352 | 08.320.1000.602 | 12;31 |
| 4210 0356 | 08.270.1000.761 | 8;14 |
| 4210 0535 | 08.270.1000.603 | 14 |
| 4210 0536 | 08.270.1000.761 | 8;14 |
| 4210 0537 | 08.270.1000.603 | 14 |
| 4210 0567 | 08.270.1000.681 | 13 |
| 4210 0571 | 08.270.1000.681 | 13 |
| 4210 0576 | 08.270.1000.681 | 13 |
| 4210 2091 | 08.270.1000.603 | 14 |
| 4210 2093 | 08.270.1000.761 | 8;14 |
| 4210 2095 | 08.270.1000.761 | 8;14 |
| 4210 2097 | 08.320.1000.792 | 11;12;19 |
| 4210 2099 | 08.320.1000.792 | 11;12;19 |
| 4210 2103 | 08.290.7000.020 | 9;15;25;40;51 |
| 4210 2104 | 08.270.1000.761 | 8;14 |
| 4210 2154 | 08.270.1000.811 | 12;34 |
| 4210 2155 | 08.270.1000.540 | 7;12;34;42 |
| 4210 2160 | 08.270.1000.583 | 7;12;13;21 |
| 4210 2163 | 08.270.1000.530 | 13;21;22;35;48;49 |
| 4210 2168 | 08.270.1000.901 | 13;14 |
| 4210 2177 | 08.270.1000.603 | 14 |
| 4210 2413 | 08.270.1000.553 | 7;8;49;55 |

| IVECO | | |
|-------------|------------------------|---------------|
| 4210 2947 | 08.320.1000.792 | 11;12;19 |
| 4210 2970 | 08.270.1000.911 | 13 |
| 4210 3036 | 08.340.1119.1 S | 11 |
| 4210 3321 | 08.270.1000.901 | 13;14 |
| 4210 4476 | 08.290.7000.020 | 9;15;25;40;51 |
| 4210 4649 | 08.270.1000.911 | 13 |
| 4210 4793 | 08.270.1000.603 | 14 |
| 4210 4983 | 08.270.1000.603 | 14 |
| 4210 4991 | 08.270.1000.901 | 13;14 |
| 4211 2970 | 08.270.1000.911 | 13 |
| 4211 4181 | 08.270.1000.553 | 7;8;49;55 |
| 4211 4182 | 08.270.1000.681 | 13 |
| 4211 4448 | 08.270.1000.503 | 13 |
| 4211 4680 | 08.270.1000.603 | 14 |
| 4211 4856 | 08.290.7000.020 | 9;15;25;40;51 |
| 4254 3362 | 08.290.7000.020 | 9;15;25;40;51 |
| 4255 6650 | 08.290.7000.020 | 9;15;25;40;51 |
| 500 292 646 | 08.270.1000.761 | 8;14 |
| 500 305 439 | 08.290.7000.020 | 9;15;25;40;51 |
| 500 317 617 | 08.290.7000.020 | 9;15;25;40;51 |
| 500 317 671 | 08.290.7000.020 | 9;15;25;40;51 |
| 500 335 068 | 08.290.7000.020 | 9;15;25;40;51 |
| 500 358 237 | 08.270.1000.781 | 12;48 |
| 500 392 645 | 08.270.1000.761 | 8;14 |
| 500 397 755 | 08.290.7000.020 | 9;15;25;40;51 |
| 500 697 757 | 08.320.1000.792 | 11;12;19 |
| 5003 01 459 | 08.270.1000.603 | 14 |
| 5003 17871 | 08.270.1000.503 | 13 |
| 5003 35105 | 08.340.1119.1 S | 11 |
| 5003 35106 | 08.340.1119.1 S | 11 |
| 5003 35107 | 08.340.1119.1 S | 11 |
| 5003 71281 | 08.340.1119.1 S | 11 |
| 5003 71282 | 08.340.1119.1 S | 11 |
| 5003 71283 | 08.340.1119.1 S | 11 |
| 5003 72 079 | 08.270.1000.603 | 14 |
| 5003 72 081 | 08.270.1000.603 | 14 |
| 5003 72 083 | 08.270.1000.603 | 14 |
| 5003 75 057 | 08.270.1000.603 | 14 |
| 5003 76219 | 08.340.1119.1 S | 11 |
| 5003 92642 | 08.340.1103.1 S | 11 |
| 5003 92643 | 08.340.1103.1 S | 11 |

aufsteigend nach Vergleichsnummer | ascending to Comp.-No.

| IVECO | | |
|---------------|------------------------|---------------|
| 5003 92654 | 08.340.1103.1 S | 11 |
| 5003 92868 | 08.270.1000.503 | 13 |
| 5003 92872 | 08.270.1000.503 | 13 |
| 50033 5098 | 08.340.1267.1 S | 11 |
| 50033 5101 | 08.340.1267.1 S | 11 |
| 5031 7871 | 08.270.1000.503 | 13 |
| 504 120 865 | 08.290.7000.020 | 9;15;25;40;51 |
| 5040 04160 | 08.340.1119.1 S | 11 |
| 5040 18 317 | 08.270.1000.603 | 14 |
| 5040 3994 | 08.320.1000.972 | 6;12;54 |
| 5040 4993 | 08.270.1000.673 | 7;13 |
| 5040 64953 | 08.340.1119.1 S | 11 |
| 5040 68265 | 08.340.1119.1 S | 11 |
| 5160-52-16.10 | 08.290.7000.060 | 9;14;24;51 |
| 8751-52-51.35 | 08.270.1000.811 | 12;34 |
| 8751-52-51.55 | 08.270.1000.811 | 12;34 |
| 9445 9823 | 08.270.1000.681 | 13 |
| 9606 2916 | 08.270.1000.761 | 8;14 |
| 9840 0175 | 08.290.7000.140 | 14;51 |
| 9840 0707 | 08.270.1000.781 | 12;48 |
| 9840 0708 | 08.320.1000.752 | 11;47 |
| 9840 0713 | 08.320.1000.752 | 11;47 |
| 9840 0715 | 08.290.7000.140 | 14;51 |
| 9840 0717 | 08.270.1000.781 | 12;48 |
| 9840 0721 | 08.290.7000.140 | 14;51 |
| 9840 2393 | 08.290.7000.140 | 14;51 |
| 9841 7693 | 08.270.1000.781 | 12;48 |
| 9843 4871 | 08.290.7000.140 | 14;51 |
| 9843 5802 | 08.270.1000.761 | 8;14 |
| 9843 5804 | 08.270.1000.603 | 14 |
| 9843 5975 | 08.270.1000.761 | 8;14 |
| 9843 5977 | 08.270.1000.603 | 14 |
| 9843 6139 | 08.270.1000.503 | 13 |
| 9843 6141 | 08.270.1000.503 | 13 |
| 9843 6159 | 08.270.1000.911 | 13 |
| 9843 6188 | 08.290.7000.020 | 9;15;25;40;51 |
| 9846 9384 | 08.270.1000.781 | 12;48 |
| 9846 9386 | 08.270.1000.781 | 12;48 |
| 9848 4664 | 08.270.1000.603 | 14 |
| 9848 6125 | 08.340.1102.1 S | 11;45 |
| 9849 5997 | 08.270.1000.901 | 13;14 |

| IVECO | | |
|-----------|------------------------|-------|
| 9849 5998 | 08.270.1000.911 | 13 |
| 9849 6005 | 08.270.1000.761 | 8;14 |
| 9849 6006 | 08.270.1000.603 | 14 |
| 9849 6861 | 08.270.1000.781 | 12;48 |
| 9849 9254 | 08.270.1000.911 | 13 |
| 9849 9256 | 08.270.1000.503 | 13 |
| 9943 0262 | 08.270.1000.901 | 13;14 |
| 9943 0263 | 08.270.1000.911 | 13 |
| 9943 0265 | 08.270.1000.503 | 13 |
| 9944 5713 | 08.270.1000.603 | 14 |
| 9944 5716 | 08.270.1000.761 | 8;14 |
| 9945 3752 | 08.270.1000.603 | 14 |
| 9945 3753 | 08.270.1000.761 | 8;14 |
| 9946 3434 | 08.270.1000.761 | 8;14 |
| 9946 3435 | 08.270.1000.603 | 14 |

| JOHN DEERE | | |
|------------|------------------------|------------|
| AL 16333 | 08.290.7000.060 | 9;14;24;51 |
| AZ 36712 | 08.320.1000.602 | 12;31 |
| AZY 61355 | 08.320.1000.602 | 12;31 |

| KAEUBLE | | |
|------------|------------------------|-------------------|
| 211 00 337 | 08.320.1000.220 | 31 |
| 211 00 338 | 08.270.1000.530 | 13;21;22;35;48;49 |
| 211 00 434 | 08.320.1000.622 | 12;20;32 |
| 211 00 436 | 08.290.7000.160 | 9;14;15;24;51 |
| 211 80 355 | 08.290.7000.060 | 9;14;24;51 |
| 400 00 884 | 08.290.7000.170 | 39 |
| 400 00 885 | 08.290.7000.170 | 39 |
| 600 80 256 | 08.290.7000.090 | 9;14;24;51;63 |

| KAROSA | | |
|------------|------------------------|-------|
| 5006000573 | 08.270.1000.503 | 13 |
| 5006005244 | 08.270.1000.791 | 23;37 |
| 5006017501 | 08.270.1000.503 | 13 |
| 5006023703 | 08.290.7000.400 | 52 |

| KÄSSBOHRER | | |
|-----------------|------------------------|----------|
| 8.383.185.000 | 08.270.1000.751 | 22;43;49 |
| 8.383.275.000.0 | 08.270.1000.801 | 34 |
| 8.383.280.000 | 08.320.1000.692 | 32 |

Vergleichsliste | Crosslist

aufsteigend nach Vergleichsnummer | ascending to Comp.-No.

| KÄSSBOHRER | | |
|-------------------|------------------------|------------|
| 8.383.335.000.2 | 08.270.1000.630 | 36;42;43 |
| 8.383.336.000 | 08.270.1000.633 | 8;23;37;43 |
| 8.383.337.000 | 08.290.7000.560 | 25;41;44 |
| 8.383.341.000 | 08.290.7000.560 | 25;41;44 |
| 8.383.350.000 | 08.270.1000.633 | 8;23;37;43 |

| KRUPP | | |
|--------------|------------------------|---------------|
| 1.068.414 | 08.270.1000.533 | 13;21 |
| 1.068.415 | 08.290.7000.160 | 9;14;15;24;51 |

| LEYLAND | | |
|----------------|------------------------|---------------|
| ACHL257 | 08.290.7000.090 | 9;14;24;51;63 |
| ACU 9199 | 08.320.1000.652 | 5;19 |
| ACU 9200 | 08.320.1000.210 | 32 |
| ACU 9204 | 08.320.1000.652 | 5;19 |
| ACU 9205 | 08.320.1000.210 | 32 |
| ACU 9332 | 08.320.1000.270 | 26 |
| ACU 9333 | 08.270.1000.803 | 8 |
| ATRA242 | 08.270.1000.693 | 7;21 |
| ATRA243 | 08.270.1000.673 | 7;13 |
| ATRB 074 | 08.270.1000.693 | 7;21 |
| EXATRA081 | 08.290.7000.060 | 9;14;24;51 |
| X4155253 | 08.290.7000.060 | 9;14;24;51 |

| LIEBHERR | | |
|-----------------|------------------------|-------------------|
| 1028 8617 | 08.270.1000.881 | 14;23;24;37;43;50 |
| 5030-105 | 08.270.1000.520 | 7;35;48 |
| 5030-105 | 08.320.1000.802 | 31 |
| 5030-108 | 08.290.7000.060 | 9;14;24;51 |
| 5030-166 | 08.290.7000.160 | 9;14;15;24;51 |
| 5031-18308 | 08.320.1000.250 | 16 |
| 503118408 | 08.290.7000.000 | 9;24;25 |
| 5031-316 | 08.320.1000.220 | 31 |
| 5031-317 | 08.270.1000.530 | 13;21;22;35;48;49 |
| 5031-319 | 08.270.1000.941 | 21;35;48 |
| 5031-325 | 08.290.7000.060 | 9;14;24;51 |
| 503132508 | 08.290.7000.060 | 9;14;24;51 |
| 5031-335 | 08.270.1000.520 | 7;35;48 |
| 503133508 | 08.270.1000.520 | 7;35;48 |
| 5031-336 | 08.320.1000.802 | 31 |
| 503134208 | 08.270.1000.540 | 7;12;34;42 |

| LIEBHERR | | |
|-----------------|------------------------|----|
| 503135208 | 08.270.1000.961 | 61 |

| MAN | | |
|----------------|------------------------|---------------|
| VA.30000.9876 | 08.340.1247.1 S | 18 |
| 36.30550.0001 | 08.290.7000.020 | 9;15;25;40;51 |
| 51.02301.0307 | 08.150.1001.060 | 68 |
| 51.02301.3220 | 08.150.1001.090 | 69 |
| 51.02301.5034 | 08.150.1001.080 | 68;69 |
| 51.02301.5068 | 08.150.1001.080 | 68;69 |
| 51.02301.5154 | 08.150.0912.060 | 68 |
| 51.02301.5155 | 08.150.0912.060 | 68 |
| 51.02301.5191 | 08.150.0912.060 | 68 |
| 51.02301.6032 | 08.150.0912.060 | 68 |
| 51.02301.6033 | 08.150.0912.060 | 68 |
| 51.02301.7290 | 08.150.1001.050 | 68 |
| 51.02301.7293 | 08.150.1001.060 | 68 |
| 51.02301.7295 | 08.150.1001.050 | 68 |
| 51.02301.7300 | 08.150.1001.060 | 68 |
| 51.02301.7307 | 08.150.1001.060 | 68 |
| 51.02301.7325 | 08.150.1001.050 | 68 |
| 51.02301.7326 | 08.150.1001.060 | 68 |
| 51.02301.7333 | 08.150.1001.060 | 68 |
| 51.02301.7335 | 08.150.1001.060 | 68 |
| 51.02301.7387 | 08.150.1001.080 | 68;69 |
| 51.02301.7410 | 08.150.0912.020 | 67;68 |
| 51.02301.7411 | 08.150.1001.080 | 68;69 |
| 51.02301.7414 | 08.150.1001.080 | 68;69 |
| 51.02301.7439 | 08.150.0912.070 | 68 |
| 51.02310.0071 | 08.160.1001.040 | 73 |
| 51.02310.0073 | 08.160.1001.040 | 73 |
| 51.02310.0096 | 08.160.1001.040 | 73 |
| 51.02310.0097 | 08.160.1001.040 | 73 |
| 81.30000.6336 | 08.270.1000.563 | 21;34;48 |
| 81.30000.6336 | 08.290.7000.290 | 24;51 |
| 81.30000.6572 | 08.340.1248.1 S | 18;19;42 |
| 81.30000.6577 | 08.340.1247.1 S | 18 |
| 81.30000.6579 | 08.340.1113.1 S | 18 |
| 81.30000.6582 | 08.340.1112.1 S | 18 |
| 81.30.000.6587 | 08.320.1000.792 | 11;12;19 |
| 81.30000.6587 | 08.290.7000.000 | 9;24;25 |
| 81.30000.6587 | 08.270.1000.831 | 22;23;36;37 |

aufsteigend nach Vergleichsnummer | ascending to Comp.-No.

| MAN | | |
|----------------|------------------------|-------------------|
| 81.30000.6592 | 08.340.1248.1 S | 18;19;42 |
| 81.30000.6593 | 08.340.1247.1 S | 18 |
| 81.30.000.6600 | 08.320.1000.792 | 11;12;19 |
| 81.30000.6600 | 08.270.1000.831 | 22;23;36;37 |
| 81.30000.6600 | 08.290.7000.000 | 9;24;25 |
| 81.30.000.6601 | 08.320.1000.792 | 11;12;19 |
| 81.30000.6601 | 08.270.1000.791 | 23;37 |
| 81.30.000.6602 | 08.320.1000.792 | 11;12;19 |
| 81.30000.6602 | 08.270.1000.633 | 8;23;37;43 |
| 81.30000.6606 | 08.340.1113.1 S | 18 |
| 81.30000.6621 | 08.340.1247.1 S | 18 |
| 81.30000.6628 | 08.340.1113.1 S | 18 |
| 81.30000.6630 | 08.340.1112.1 S | 18 |
| 81.30000.6653 | 08.340.1112.1 S | 18 |
| 81.30000.6657 | 08.340.1113.1 S | 18 |
| 81.30000.7220 | 08.270.1000.643 | 22 |
| 81.30000.7220 | 08.290.7000.410 | 25 |
| 81.30000.7220 | 08.320.1000.932 | 19;20 |
| 81.30005.9012 | 08.340.1111.1 S | 17 |
| 81.30005.9013 | 08.340.1111.1 S | 17 |
| 81.30005.9016 | 08.340.1109.1 S | 17 |
| 81.30005.9018 | 08.340.1111.1 S | 17 |
| 81.30005.9021 | 08.340.1111.1 S | 17 |
| 81.30005.9022 | 08.340.1112.1 S | 18 |
| 81.30005.9023 | 08.340.1115.1 S | 18 |
| 81.30005.9026 | 08.340.1247.1 S | 18 |
| 81.30301.0001 | 08.270.1000.711 | 7;21 |
| 81.30301.0088 | 08.270.1000.530 | 13;21;22;35;48;49 |
| 81.30301.0111 | 08.270.1000.563 | 21;34;48 |
| 81.30301.0112 | 08.270.1000.751 | 22;43;49 |
| 81.30301.0121 | 08.270.1000.941 | 21;35;48 |
| 81.30301.0128 | 08.270.1000.563 | 21;34;48 |
| 81.30301.0134 | 08.270.1000.520 | 7;35;48 |
| 81.30301.0148 | 08.270.1000.751 | 22;43;49 |
| 81.30301.0150 | 08.270.1000.941 | 21;35;48 |
| 81.30301.0152 | 08.270.1000.563 | 21;34;48 |
| 81.30301.0155 | 08.270.1000.530 | 13;21;22;35;48;49 |
| 81.30301.0162 | 08.270.1000.751 | 22;43;49 |
| 81.30301.0169 | 08.270.1000.941 | 21;35;48 |
| 81.30301.0191 | 08.270.1000.653 | 22 |
| 81.30301.0192 | 08.270.1000.653 | 22 |

| MAN | | |
|---------------|------------------------|-------------------|
| 81.30301.0201 | 08.270.1000.653 | 22 |
| 81.30301.0208 | 08.270.1000.653 | 22 |
| 81.30301.0217 | 08.270.1000.881 | 14;23;24;37;43;50 |
| 81.30301.0218 | 08.270.1000.881 | 14;23;24;37;43;50 |
| 81.30301.0219 | 08.270.1000.881 | 14;23;24;37;43;50 |
| 81.30301.0220 | 08.270.1000.881 | 14;23;24;37;43;50 |
| 81.30301.0222 | 08.270.1000.881 | 14;23;24;37;43;50 |
| 81.30301.0223 | 08.270.1000.881 | 14;23;24;37;43;50 |
| 81.30301.0224 | 08.270.1000.881 | 14;23;24;37;43;50 |
| 81.30301.0225 | 08.270.1000.881 | 14;23;24;37;43;50 |
| 81.30301.0232 | 08.270.1000.653 | 22 |
| 81.30301.0235 | 08.270.1000.951 | 21;35;48;60 |
| 81.30301.0238 | 08.270.1000.903 | 22 |
| 81.30301.0239 | 08.270.1000.903 | 22 |
| 81.30301.0240 | 08.270.1000.903 | 22 |
| 81.30301.0241 | 08.270.1000.903 | 22 |
| 81.30301.0242 | 08.270.1000.931 | 22 |
| 81.30301.0243 | 08.270.1000.931 | 22 |
| 81.30301.0244 | 08.270.1000.931 | 22 |
| 81.30301.0245 | 08.270.1000.931 | 22 |
| 81.30301.0246 | 08.270.1000.653 | 22 |
| 81.30301.0247 | 08.270.1000.563 | 21;34;48 |
| 81.30301.0249 | 08.270.1000.751 | 22;43;49 |
| 81.30301.0250 | 08.270.1000.653 | 22 |
| 81.30301.0256 | 08.270.1000.881 | 14;23;24;37;43;50 |
| 81.30301.0257 | 08.270.1000.881 | 14;23;24;37;43;50 |
| 81.30301.0258 | 08.270.1000.881 | 14;23;24;37;43;50 |
| 81.30301.0263 | 08.270.1000.941 | 21;35;48 |
| 81.30301.0283 | 08.270.1000.533 | 13;21 |
| 81.30301.0284 | 08.270.1000.533 | 13;21 |
| 81.30301.0285 | 08.270.1000.533 | 13;21 |
| 81.30301.0289 | 08.270.1000.881 | 14;23;24;37;43;50 |
| 81.30301.0293 | 08.270.1000.563 | 21;34;48 |
| 81.30301.0295 | 08.270.1000.903 | 22 |
| 81.30301.0299 | 08.270.1000.912 | 49 |
| 81.30301.0308 | 08.270.1000.941 | 21;35;48 |
| 81.30301.0314 | 08.270.1000.951 | 21;35;48;60 |
| 81.30301.0318 | 08.270.1000.903 | 22 |
| 81.30301.0319 | 08.270.1000.903 | 22 |
| 81.30301.0320 | 08.270.1000.903 | 22 |
| 81.30301.0322 | 08.270.1000.881 | 14;23;24;37;43;50 |

Vergleichsliste | Crosslist

aufsteigend nach Vergleichsnummer | ascending to Comp.-No.

| MAN | | |
|---------------|------------------------|-------------------|
| 81.30301.0323 | 08.270.1000.881 | 14;23;24;37;43;50 |
| 81.30301.0325 | 08.270.1000.881 | 14;23;24;37;43;50 |
| 81.30301.0325 | 08.270.1000.500 | 8;23;37 |
| 81.30301.0326 | 08.270.1000.881 | 14;23;24;37;43;50 |
| 81.30301.0327 | 08.270.1000.881 | 14;23;24;37;43;50 |
| 81.30301.0328 | 08.270.1000.931 | 22 |
| 81.30301.0329 | 08.270.1000.931 | 22 |
| 81.30301.0337 | 08.270.1000.941 | 21;35;48 |
| 81.30301.0346 | 08.270.1000.931 | 22 |
| 81.30301.0347 | 08.270.1000.903 | 22 |
| 81.30301.0351 | 08.270.1000.903 | 22 |
| 81.30301.0353 | 08.270.1000.831 | 22;23;36;37 |
| 81.30301.0355 | 08.270.1000.851 | 23 |
| 81.30301.0360 | 08.270.1000.881 | 14;23;24;37;43;50 |
| 81.30301.0364 | 08.270.1000.851 | 23 |
| 81.30301.0366 | 08.270.1000.881 | 14;23;24;37;43;50 |
| 81.30301.0369 | 08.270.1000.881 | 14;23;24;37;43;50 |
| 81.30301.0371 | 08.270.1000.903 | 22 |
| 81.30301.0375 | 08.270.1000.573 | 21;48 |
| 81.30301.0376 | 08.270.1000.851 | 23 |
| 81.30301.0377 | 08.270.1000.831 | 22;23;36;37 |
| 81.30301.0378 | 08.270.1000.771 | 22 |
| 81.30301.0381 | 08.270.1000.851 | 23 |
| 81.30301.0382 | 08.270.1000.851 | 23 |
| 81.30301.0383 | 08.270.1000.881 | 14;23;24;37;43;50 |
| 81.30301.0385 | 08.270.1000.851 | 23 |
| 81.30301.0386 | 08.270.1000.851 | 23 |
| 81.30301.0388 | 08.270.1000.851 | 23 |
| 81.30301.0390 | 08.270.1000.881 | 14;23;24;37;43;50 |
| 81.30301.0391 | 08.270.1000.881 | 14;23;24;37;43;50 |
| 81.30301.0392 | 08.270.1000.643 | 22 |
| 81.30301.0393 | 08.270.1000.711 | 7;21 |
| 81.30301.0395 | 08.270.1000.711 | 7;21 |
| 81.30301.0402 | 08.270.1000.881 | 14;23;24;37;43;50 |
| 81.30301.0407 | 08.270.1000.881 | 14;23;24;37;43;50 |
| 81.30301.0408 | 08.270.1000.881 | 14;23;24;37;43;50 |
| 81.30301.0411 | 08.270.1000.693 | 7;21 |
| 81.30301.0413 | 08.270.1000.791 | 23;37 |
| 81.30301.0419 | 08.270.1000.881 | 14;23;24;37;43;50 |
| 81.30301.0421 | 08.270.1000.791 | 23;37 |
| 81.30301.0434 | 08.270.1000.813 | 23;43 |

| MAN | | |
|---------------|------------------------|-------------------|
| 81.30301.0438 | 08.270.1000.831 | 22;23;36;37 |
| 81.30301.0439 | 08.270.1000.791 | 23;37 |
| 81.30301.0440 | 08.270.1000.633 | 8;23;37;43 |
| 81.30301.0441 | 08.270.1000.881 | 14;23;24;37;43;50 |
| 81.30301.0445 | 08.270.1000.813 | 23;43 |
| 81.30301.0446 | 08.270.1000.813 | 23;43 |
| 81.30301.0450 | 08.270.1000.693 | 7;21 |
| 81.30301.0455 | 08.270.1000.903 | 22 |
| 81.30301.0456 | 08.270.1000.831 | 22;23;36;37 |
| 81.30301.0457 | 08.270.1000.831 | 22;23;36;37 |
| 81.30301.0458 | 08.270.1000.791 | 23;37 |
| 81.30301.0459 | 08.270.1000.633 | 8;23;37;43 |
| 81.30301.0460 | 08.270.1000.500 | 8;23;37 |
| 81.30301.0461 | 08.270.1000.573 | 21;48 |
| 81.30301.0463 | 08.270.1000.831 | 22;23;36;37 |
| 81.30301.0464 | 08.270.1000.881 | 14;23;24;37;43;50 |
| 81.30301.0466 | 08.270.1000.813 | 23;43 |
| 81.30301.0468 | 08.270.1000.693 | 7;21 |
| 81.30301.0469 | 08.270.1000.693 | 7;21 |
| 81.30301.0470 | 08.270.1000.693 | 7;21 |
| 81.30301.0473 | 08.270.1000.813 | 23;43 |
| 81.30301.0475 | 08.270.1000.711 | 7;21 |
| 81.30301.0488 | 08.270.1000.813 | 23;43 |
| 81.30301.0490 | 08.270.1000.693 | 7;21 |
| 81.30301.0491 | 08.270.1000.693 | 7;21 |
| 81.30301.0492 | 08.270.1000.693 | 7;21 |
| 81.30301.0497 | 08.270.1000.831 | 22;23;36;37 |
| 81.30301.0498 | 08.270.1000.831 | 22;23;36;37 |
| 81.30301.0499 | 08.270.1000.791 | 23;37 |
| 81.30301.0500 | 08.270.1000.633 | 8;23;37;43 |
| 81.30301.0501 | 08.270.1000.881 | 14;23;24;37;43;50 |
| 81.30301.0502 | 08.270.1000.881 | 14;23;24;37;43;50 |
| 81.30301.0503 | 08.270.1000.500 | 8;23;37 |
| 81.30301.0504 | 08.270.1000.881 | 14;23;24;37;43;50 |
| 81.30301.0505 | 08.270.1000.881 | 14;23;24;37;43;50 |
| 81.30301.0506 | 08.270.1000.500 | 8;23;37 |
| 81.30301.0507 | 08.270.1000.500 | 8;23;37 |
| 81.30301.0508 | 08.270.1000.813 | 23;43 |
| 81.30301.0509 | 08.270.1000.633 | 8;23;37;43 |
| 81.30301.0511 | 08.270.1000.500 | 8;23;37 |
| 81.30301.0520 | 08.270.1000.693 | 7;21 |

aufsteigend nach Vergleichsnummer | ascending to Comp.-No.

| MAN | | |
|---------------|------------------------|-------------------|
| 81.30301.0521 | 08.270.1000.881 | 14;23;24;37;43;50 |
| 81.30301.0524 | 08.270.1000.771 | 22 |
| 81.30301.0525 | 08.270.1000.813 | 23;43 |
| 81.30301.0526 | 08.270.1000.813 | 23;43 |
| 81.30301.0527 | 08.270.1000.813 | 23;43 |
| 81.30301.0529 | 08.270.1000.693 | 7;21 |
| 81.30301.0539 | 08.270.1000.643 | 22 |
| 81.30301.0545 | 08.270.1000.500 | 8;23;37 |
| 81.30301.0546 | 08.270.1000.500 | 8;23;37 |
| 81.30301.0547 | 08.270.1000.500 | 8;23;37 |
| 81.30301.0549 | 08.270.1000.500 | 8;23;37 |
| 81.30301.0556 | 08.270.1000.693 | 7;21 |
| 81.30301.0557 | 08.270.1000.771 | 22 |
| 81.30301.0558 | 08.270.1000.771 | 22 |
| 81.30301.0559 | 08.270.1000.500 | 8;23;37 |
| 81.30301.0566 | 08.270.1000.643 | 22 |
| 81.30301.0569 | 08.270.1000.881 | 14;23;24;37;43;50 |
| 81.30301.1008 | 08.270.1000.941 | 21;35;48 |
| 81.30301.4485 | 08.270.1000.791 | 23;37 |
| 81.30301.9111 | 08.270.1000.563 | 21;34;48 |
| 81.30301.9112 | 08.270.1000.751 | 22;43;49 |
| 81.30301.9121 | 08.270.1000.941 | 21;35;48 |
| 81.30301.9148 | 08.270.1000.751 | 22;43;49 |
| 81.30301.9150 | 08.270.1000.941 | 21;35;48 |
| 81.30301.9152 | 08.270.1000.563 | 21;34;48 |
| 81.30301.9162 | 08.270.1000.751 | 22;43;49 |
| 81.30301.9191 | 08.270.1000.653 | 22 |
| 81.30301.9201 | 08.270.1000.653 | 22 |
| 81.30301.9232 | 08.270.1000.653 | 22 |
| 81.30301.9246 | 08.270.1000.653 | 22 |
| 81.30301.9247 | 08.270.1000.563 | 21;34;48 |
| 81.30301.9249 | 08.270.1000.751 | 22;43;49 |
| 81.30301.9250 | 08.270.1000.653 | 22 |
| 81.30301.9263 | 08.270.1000.941 | 21;35;48 |
| 81.30301.9284 | 08.270.1000.533 | 13;21 |
| 81.30301.9314 | 08.270.1000.951 | 21;35;48;60 |
| 81.30301.9322 | 08.270.1000.881 | 14;23;24;37;43;50 |
| 81.30301.9325 | 08.270.1000.881 | 14;23;24;37;43;50 |
| 81.30301.9327 | 08.270.1000.881 | 14;23;24;37;43;50 |
| 81.30301.9329 | 08.270.1000.931 | 22 |
| 81.30301.9337 | 08.270.1000.941 | 21;35;48 |

| MAN | | |
|----------------|------------------------|-------------------|
| 81.30301.9346 | 08.270.1000.931 | 22 |
| 81.30301.9351 | 08.270.1000.903 | 22 |
| 81.30301.9360 | 08.270.1000.881 | 14;23;24;37;43;50 |
| 81.30301.9377 | 08.270.1000.831 | 22;23;36;37 |
| 81.30301.9378 | 08.270.1000.771 | 22 |
| 81.30301.9381 | 08.270.1000.851 | 23 |
| 81.30301.9386 | 08.270.1000.851 | 23 |
| 81.30301.9393 | 08.270.1000.711 | 7;21 |
| 81.30301.9402 | 08.270.1000.881 | 14;23;24;37;43;50 |
| 81.30301.9438 | 08.270.1000.831 | 22;23;36;37 |
| 81.30301.9457 | 08.270.1000.831 | 22;23;36;37 |
| 81.30301.9492 | 08.270.1000.693 | 7;21 |
| 81.30301.9506 | 08.270.1000.500 | 8;23;37 |
| 81.30301.9525 | 08.270.1000.813 | 23;43 |
| 81.30301.9547 | 08.270.1000.500 | 8;23;37 |
| 81.30301.9549 | 08.270.1000.500 | 8;23;37 |
| 81.30301.9557 | 08.270.1000.771 | 22 |
| 81.30301.9566 | 08.270.1000.643 | 22 |
| 81.30301.9569 | 08.270.1000.881 | 14;23;24;37;43;50 |
| 81.30305.0046 | 08.320.1000.962 | 19;47;48 |
| 81.30305.0053 | 08.320.1000.962 | 19;47;48 |
| 81.30305.0079 | 08.320.1000.962 | 19;47;48 |
| 81.30305.0084 | 08.320.1000.200 | 20;32;42 |
| 81.30305.0111 | 08.320.1000.622 | 12;20;32 |
| 81.30.305.0138 | 08.320.1000.792 | 11;12;19 |
| 81.30.305.0139 | 08.320.1000.792 | 11;12;19 |
| 81.30.305.0158 | 08.320.1000.792 | 11;12;19 |
| 81.30.305.0162 | 08.320.1000.652 | 5;19 |
| 81.30.305.0165 | 08.320.1000.792 | 11;12;19 |
| 81.30.305.0166 | 08.320.1000.792 | 11;12;19 |
| 81.30305.0176 | 08.320.1000.982 | 20 |
| 81.30.305.0179 | 08.320.1000.792 | 11;12;19 |
| 81.30.305.0182 | 08.320.1000.792 | 11;12;19 |
| 81.30.305.0191 | 08.320.1000.792 | 11;12;19 |
| 81.30305.0192 | 08.320.1000.982 | 20 |
| 81.30.305.0193 | 08.320.1000.792 | 11;12;19 |
| 81.30.305.0194 | 08.320.1000.792 | 11;12;19 |
| 81.30305.0198 | 08.320.1000.672 | 19 |
| 81.30305.0200 | 08.320.1000.932 | 19;20 |
| 81.30305.0201 | 08.320.1000.360 | 20 |
| 81.30305.0204 | 08.320.1000.842 | 19 |

Vergleichsliste | Crosslist

aufsteigend nach Vergleichsnummer | ascending to Comp.-No.

| MAN | | | MAN | | |
|----------------|------------------------|---------------|----------------|------------------------|---------------|
| 81.30305.0205 | 08.320.1000.822 | 19 | 81.30550.0043 | 08.290.7000.290 | 24;51 |
| 81.30305.0206 | 08.320.1000.280 | 20 | 81.30.550.0044 | 08.290.7000.090 | 9;14;24;51;63 |
| 81.30305.0209 | 08.320.1000.280 | 20 | 81.30.550.0049 | 08.290.7000.160 | 9;14;15;24;51 |
| 81.30305.0214 | 08.320.1000.842 | 19 | 81.30.550.0050 | 08.290.7000.060 | 9;14;24;51 |
| 81.30305.0216 | 08.320.1000.862 | 20;32 | 81.30550.0052 | 08.290.7000.280 | 24 |
| 81.30305.0218 | 08.320.1000.822 | 19 | 81.30550.0054 | 08.290.7000.290 | 24;51 |
| 81.30305.0219 | 08.320.1000.842 | 19 | 81.30550.0056 | 08.290.7000.250 | 24;51 |
| 81.30305.0220 | 08.320.1000.822 | 19 | 81.30.550.0060 | 08.290.7000.090 | 9;14;24;51;63 |
| 81.30305.0221 | 08.320.1000.842 | 19 | 81.30550.0063 | 08.290.7000.000 | 9;24;25 |
| 81.30305.0223 | 08.320.1000.862 | 20;32 | 81.30550.0067 | 08.290.7000.000 | 9;24;25 |
| 81.30305.0224 | 08.320.1000.280 | 20 | 81.30550.0071 | 08.290.7000.000 | 9;24;25 |
| 81.30305.0225 | 08.320.1000.672 | 19 | 81.30.550.0072 | 08.290.7000.060 | 9;14;24;51 |
| 81.30305.0228 | 08.320.1000.932 | 19;20 | 81.30550.0073 | 08.290.7000.000 | 9;24;25 |
| 81.30305.0229 | 08.320.1000.842 | 19 | 81.30550.0077 | 08.290.7000.000 | 9;24;25 |
| 81.30305.0230 | 08.320.1000.822 | 19 | 81.30550.0080 | 08.290.7000.420 | 9;10;25 |
| 81.30305.0231 | 08.320.1000.932 | 19;20 | 81.30550.0085 | 08.290.7000.410 | 25 |
| 81.30305.0232 | 08.320.1000.280 | 20 | 81.30550.0087 | 08.290.7000.000 | 9;24;25 |
| 81.30305.0233 | 08.320.1000.672 | 19 | 81.30550.0088 | 08.290.7000.000 | 9;24;25 |
| 81.30305.6011 | 08.320.1000.962 | 19;47;48 | 81.30550.0089 | 08.290.7000.420 | 9;10;25 |
| 81.30305.6028 | 08.320.1000.350 | 20;33 | 81.30550.0094 | 08.290.7000.000 | 9;24;25 |
| 81.30305.9046 | 08.320.1000.962 | 19;47;48 | 81.30550.0096 | 08.290.7000.020 | 9;15;25;40;51 |
| 81.30305.9053 | 08.320.1000.962 | 19;47;48 | 81.30550.0101 | 08.290.7000.020 | 9;15;25;40;51 |
| 81.30305.9079 | 08.320.1000.962 | 19;47;48 | 81.30550.0102 | 08.290.7000.020 | 9;15;25;40;51 |
| 81.30305.9084 | 08.320.1000.200 | 20;32;42 | 81.30550.0104 | 08.290.7000.020 | 9;15;25;40;51 |
| 81.30305.9111 | 08.320.1000.200 | 20;32;42 | 81.30550.0106 | 08.290.7000.000 | 9;24;25 |
| 81.30.305.9166 | 08.320.1000.792 | 11;12;19 | 81.30550.0107 | 08.290.7000.000 | 9;24;25 |
| 81.30.305.9191 | 08.320.1000.792 | 11;12;19 | 81.30550.0109 | 08.290.7000.000 | 9;24;25 |
| 81.30.305.9193 | 08.320.1000.792 | 11;12;19 | 81.30550.0110 | 08.290.7000.000 | 9;24;25 |
| 81.30.305.9194 | 08.320.1000.792 | 11;12;19 | 81.30550.0116 | 08.290.7000.000 | 9;24;25 |
| 81.30305.9198 | 08.320.1000.672 | 19 | 81.30.550.6019 | 08.290.7000.060 | 9;14;24;51 |
| 81.30305.9201 | 08.320.1000.360 | 20 | 81.30560.0057 | 08.290.0909.300 | 65 |
| 81.30305.9206 | 08.320.1000.280 | 20 | 81.30560.0063 | 08.290.0909.300 | 65 |
| 81.30305.9220 | 08.320.1000.822 | 19 | 81.30560.6019 | 08.290.0909.20S | 66 |
| 81.30305.9221 | 08.320.1000.842 | 19 | 81.30560.6019 | 08.290.0909.2 S | 66 |
| 81.30305.9223 | 08.320.1000.862 | 20;32 | 81.30560.6022 | 08.290.0909.2 S | 66 |
| 81.30305.9229 | 08.320.1000.842 | 19 | 81.30560.6022 | 08.290.0909.20S | 66 |
| 81.30305.9232 | 08.320.1000.280 | 20 | 81.32411.0006 | 08.290.0909.310 | 65 |
| 81.30305.9233 | 08.320.1000.672 | 19 | 81.32411.0007 | 08.290.0909.310 | 65 |
| 81.30.550.0026 | 08.290.7000.060 | 9;14;24;51 | 82.30005.9004 | 08.340.1247.1 S | 18 |
| 81.30.550.0035 | 08.290.7000.160 | 9;14;15;24;51 | 82.30005.9005 | 08.340.1113.1 S | 18 |
| 81.30.550.0041 | 08.290.7000.060 | 9;14;24;51 | 82.30005.9006 | 08.340.1248.1 S | 18;19;42 |

aufsteigend nach Vergleichsnummer | ascending to Comp.-No.

| MERCEDES-BENZ | | |
|---------------|------------------------|-------------------|
| 000 250 00 04 | 08.320.1000.802 | 31 |
| 000 250 05 03 | 08.270.1000.570 | 34 |
| 000 250 17 15 | 08.290.7000.200 | 38 |
| 000 250 19 04 | 08.320.1000.220 | 31 |
| 000 250 19 15 | 08.290.7000.080 | 39;44 |
| 000 250 25 15 | 08.290.7000.080 | 39;44 |
| 000 250 31 15 | 08.290.7000.200 | 38 |
| 000 250 32 03 | 08.270.1000.811 | 12;34 |
| 000 250 33 03 | 08.270.1000.570 | 34 |
| 000 250 35 03 | 08.270.1000.570 | 34 |
| 000 250 37 15 | 08.290.7000.200 | 38 |
| 000 250 40 04 | 08.320.1000.220 | 31 |
| 000 250 40 15 | 08.290.7000.200 | 38 |
| 000 250 42 15 | 08.290.7000.030 | 38;44 |
| 000 250 43 04 | 08.320.1000.220 | 31 |
| 000 250 46 15 | 08.290.7000.030 | 38;44 |
| 000 250 63 03 | 08.270.1000.580 | 34 |
| 000 250 64 15 | 08.290.7000.110 | 38;39 |
| 000 250 70 15 | 08.290.7000.050 | 39 |
| 000 250 71 04 | 08.320.1000.220 | 31 |
| 000 250 73 15 | 08.290.7000.150 | 39 |
| 000 250 74 04 | 08.320.1000.220 | 31 |
| 000 250 74 15 | 08.290.7000.080 | 39;44 |
| 000 250 75 15 | 08.290.7000.180 | 39;40 |
| 000 250 76 15 | 08.290.7000.220 | 39 |
| 000 250 77 15 | 08.290.7000.080 | 39;44 |
| 000 250 91 03 | 08.270.1000.811 | 12;34 |
| 000 250 92 03 | 08.270.1000.530 | 13;21;22;35;48;49 |
| 000 250 92 15 | 08.290.7000.270 | 40 |
| 000 250 95 15 | 08.290.7000.120 | 38 |
| 000 254 30 08 | 08.290.7000.020 | 9;15;25;40;51 |
| 001 250 01 15 | 08.290.7000.100 | 38 |
| 001 250 02 03 | 08.270.1000.811 | 12;34 |
| 001 250 02 15 | 08.290.7000.100 | 38 |
| 001 250 04 15 | 08.290.7000.300 | 9;40 |
| 001 250 05 03 | 08.270.1000.570 | 34 |
| 001 250 05 15 | 08.290.7000.070 | 40 |
| 001 250 06 03 | 08.270.1000.580 | 34 |
| 001 250 06 15 | 08.290.7000.130 | 40 |
| 001 250 07 04 | 08.320.1000.220 | 31 |
| 001 250 08 04 | 08.320.1000.220 | 31 |

| MERCEDES-BENZ | | |
|---------------|------------------------|-------------------|
| 001 250 08 15 | 08.290.7000.120 | 38 |
| 001 250 09 15 | 08.290.7000.190 | 39 |
| 001 250 18 15 | 08.290.7000.560 | 25;41;44 |
| 001 250 22 15 | 08.290.7000.050 | 39 |
| 001 250 25 15 | 08.290.7000.100 | 38 |
| 001 250 27 03 | 08.270.1000.811 | 12;34 |
| 001 250 36 03 | 08.270.1000.570 | 34 |
| 001 250 40 03 | 08.270.1000.570 | 34 |
| 001 250 45 15 | 08.290.7000.300 | 9;40 |
| 001 250 47 15 | 08.290.7000.190 | 39 |
| 001 250 48 15 | 08.290.7000.070 | 40 |
| 001 250 49 15 | 08.290.7000.130 | 40 |
| 001 250 55 03 | 08.270.1000.530 | 13;21;22;35;48;49 |
| 001 250 57 03 | 08.270.1000.811 | 12;34 |
| 001 250 58 03 | 08.270.1000.530 | 13;21;22;35;48;49 |
| 001 250 59 03 | 08.270.1000.560 | 34;42 |
| 001 250 60 03 | 08.270.1000.801 | 34 |
| 001 250 62 15 | 08.290.7000.190 | 39 |
| 001 250 63 15 | 08.290.7000.190 | 39 |
| 001 250 64 15 | 08.290.7000.070 | 40 |
| 001 250 65 15 | 08.290.7000.070 | 40 |
| 001 250 66 15 | 08.290.7000.130 | 40 |
| 001 250 67 03 | 08.270.1000.530 | 13;21;22;35;48;49 |
| 001 250 67 15 | 08.290.7000.130 | 40 |
| 001 250 68 04 | 08.320.1000.220 | 31 |
| 001 250 72 15 | 08.290.7000.100 | 38 |
| 001 250 79 15 | 08.290.7000.070 | 40 |
| 001 250 80 15 | 08.290.7000.130 | 40 |
| 001 250 81 15 | 08.290.7000.190 | 39 |
| 001 250 83 03 | 08.270.1000.530 | 13;21;22;35;48;49 |
| 001 250 84 15 | 08.290.7000.190 | 39 |
| 001 250 86 15 | 08.290.7000.070 | 40 |
| 001 250 88 15 | 08.290.7000.130 | 40 |
| 001 250 91 15 | 08.290.7000.030 | 38;44 |
| 001 250 93 15 | 08.290.7000.030 | 38;44 |
| 001 250 96 15 | 08.290.7000.560 | 25;41;44 |
| 001 250 97 01 | 08.340.1206.1 S | 29 |
| 001 250 97 03 | 08.270.1000.811 | 12;34 |
| 001 250 97 15 | 08.290.7000.190 | 39 |
| 001 250 98 15 | 08.290.7000.070 | 40 |
| 002 250 03 04 | 08.320.1000.622 | 12;20;32 |

Vergleichsliste | Crosslist

aufsteigend nach Vergleichsnummer | ascending to Comp.-No.

| MERCEDES-BENZ | | |
|---------------|------------------------|-------------------|
| 002 250 04 03 | 08.270.1000.560 | 34;42 |
| 002 250 04 04 | 08.320.1000.622 | 12;20;32 |
| 002 250 05 03 | 08.270.1000.530 | 13;21;22;35;48;49 |
| 002 250 05 15 | 08.290.7000.100 | 38 |
| 002 250 08 15 | 08.290.7000.130 | 40 |
| 002 250 13 03 | 08.270.1000.811 | 12;34 |
| 002 250 14 03 | 08.270.1000.811 | 12;34 |
| 002 250 31 04 | 08.320.1000.802 | 31 |
| 002 250 32 04 | 08.320.1000.200 | 20;32;42 |
| 002 250 33 03 | 08.270.1000.650 | 36;43 |
| 002 250 34 03 | 08.270.1000.560 | 34;42 |
| 002 250 35 03 | 08.270.1000.580 | 34 |
| 002 250 37 15 | 08.290.7000.510 | 40;41 |
| 002 250 39 03 | 08.270.1000.801 | 34 |
| 002 250 39 04 | 08.320.1000.802 | 31 |
| 002 250 40 04 | 08.320.1000.802 | 31 |
| 002 250 40 15 | 08.290.7000.510 | 40;41 |
| 002 250 41 04 | 08.320.1000.200 | 20;32;42 |
| 002 250 41 15 | 08.290.7000.500 | 40 |
| 002 250 47 15 | 08.290.7000.500 | 40 |
| 002 250 67 15 | 08.290.7000.500 | 40 |
| 002 250 68 15 | 08.290.7000.510 | 40;41 |
| 002 250 74 03 | 08.270.1000.580 | 34 |
| 002 250 75 04 | 08.320.1000.300 | 6;33 |
| 002 250 81 04 | 08.320.1000.622 | 12;20;32 |
| 002 250 81 15 | 08.290.7000.500 | 40 |
| 002 250 82 15 | 08.290.7000.510 | 40;41 |
| 002 250 87 04 | 08.320.1000.602 | 12;31 |
| 002 250 88 03 | 08.270.1000.801 | 34 |
| 002 250 97 03 | 08.270.1000.520 | 7;35;48 |
| 002 250 98 03 | 08.270.1000.520 | 7;35;48 |
| 002 250 99 03 | 08.270.1000.590 | 36;43;49 |
| 002 250 99 04 | 08.320.1000.200 | 20;32;42 |
| 003 250 00 03 | 08.270.1000.590 | 36;43;49 |
| 003 250 00 04 | 08.320.1000.200 | 20;32;42 |
| 003 250 06 03 | 08.270.1000.520 | 7;35;48 |
| 003 250 09 03 | 08.270.1000.520 | 7;35;48 |
| 003 250 20 04 | 08.320.1000.220 | 31 |
| 003 250 21 04 | 08.320.1000.220 | 31 |
| 003 250 22 04 | 08.320.1000.220 | 31 |
| 003 250 25 04 | 08.320.1000.802 | 31 |

| MERCEDES-BENZ | | |
|---------------|------------------------|-------------------|
| 003 250 26 04 | 08.320.1000.200 | 20;32;42 |
| 003 250 27 04 | 08.320.1000.802 | 31 |
| 003 250 28 04 | 08.320.1000.802 | 31 |
| 003 250 40 04 | 08.320.1000.632 | 31 |
| 003 250 41 04 | 08.320.1000.200 | 20;32;42 |
| 003 250 51 03 | 08.270.1000.530 | 13;21;22;35;48;49 |
| 003 250 54 04 | 08.320.1000.602 | 12;31 |
| 003 250 56 03 | 08.270.1000.540 | 7;12;34;42 |
| 003 250 62 03 | 08.270.1000.540 | 7;12;34;42 |
| 003 250 70 04 | 08.320.1000.200 | 20;32;42 |
| 003 250 74 03 | 08.270.1000.520 | 7;35;48 |
| 003 250 82 03 | 08.270.1000.801 | 34 |
| 003 250 83 03 | 08.270.1000.801 | 34 |
| 003 250 84 03 | 08.270.1000.550 | 34;42 |
| 003 250 86 03 | 08.270.1000.560 | 34;42 |
| 003 250 88 04 | 08.320.1000.622 | 12;20;32 |
| 003 250 90 04 | 08.320.1000.622 | 12;20;32 |
| 003 250 95 03 | 08.270.1000.941 | 21;35;48 |
| 003 250 99 04 | 08.320.1000.632 | 31 |
| 004 250 00 04 | 08.320.1000.622 | 12;20;32 |
| 004 250 24 04 | 08.320.1000.742 | 31 |
| 004 250 44 04 | 08.320.1000.692 | 32 |
| 004 250 45 04 | 08.320.1000.692 | 32 |
| 004 250 46 04 | 08.320.1000.210 | 32 |
| 004 250 49 03 | 08.270.1000.801 | 34 |
| 004 250 52 03 | 08.270.1000.941 | 21;35;48 |
| 004 250 56 04 | 08.320.1000.210 | 32 |
| 004 250 58 04 | 08.320.1000.210 | 32 |
| 004 250 60 04 | 08.320.1000.210 | 32 |
| 004 250 61 04 | 08.320.1000.210 | 32 |
| 004 250 66 03 | 08.270.1000.570 | 34 |
| 004 250 73 03 | 08.270.1000.540 | 7;12;34;42 |
| 004 250 87 04 | 08.320.1000.210 | 32 |
| 004 250 88 04 | 08.320.1000.210 | 32 |
| 004 250 89 04 | 08.320.1000.612 | 32 |
| 004 250 90 03 | 08.270.1000.811 | 12;34 |
| 004 250 96 03 | 08.270.1000.951 | 21;35;48;60 |
| 005 250 01 03 | 08.270.1000.590 | 36;43;49 |
| 005 250 02 03 | 08.270.1000.590 | 36;43;49 |
| 005 250 06 03 | 08.270.1000.560 | 34;42 |
| 005 250 07 03 | 08.270.1000.801 | 34 |

aufsteigend nach Vergleichsnummer | ascending to Comp.-No.

| MERCEDES-BENZ | | |
|---------------|------------------------|-------------|
| 005 250 19 03 | 08.270.1000.563 | 21;34;48 |
| 005 250 19 04 | 08.320.1000.622 | 12;20;32 |
| 005 250 24 03 | 08.270.1000.563 | 21;34;48 |
| 005 250 39 03 | 08.270.1000.540 | 7;12;34;42 |
| 005 250 40 03 | 08.270.1000.540 | 7;12;34;42 |
| 005 250 43 03 | 08.270.1000.520 | 7;35;48 |
| 005 250 53 03 | 08.270.1000.550 | 34;42 |
| 005 250 55 03 | 08.270.1000.550 | 34;42 |
| 005 250 57 03 | 08.270.1000.520 | 7;35;48 |
| 005 250 62 04 | 08.320.1000.612 | 32 |
| 005 250 64 03 | 08.270.1000.520 | 7;35;48 |
| 005 250 64 04 | 08.320.1000.240 | 32;33 |
| 005 250 66 04 | 08.320.1000.240 | 32;33 |
| 005 250 76 04 | 08.320.1000.692 | 32 |
| 005 250 77 04 | 08.320.1000.692 | 32 |
| 005 250 83 04 | 08.320.1000.210 | 32 |
| 005 250 84 04 | 08.320.1000.210 | 32 |
| 005 250 87 04 | 08.320.1000.692 | 32 |
| 005 250 88 04 | 08.320.1000.692 | 32 |
| 005 250 93 03 | 08.270.1000.951 | 21;35;48;60 |
| 005 250 93 04 | 08.320.1000.230 | 33 |
| 005 250 94 03 | 08.270.1000.570 | 34 |
| 005 250 94 04 | 08.320.1000.230 | 33 |
| 005 250 95 03 | 08.270.1000.570 | 34 |
| 006 250 30 04 | 08.320.1000.290 | 33 |
| 006 250 32 04 | 08.320.1000.862 | 20;32 |
| 006 250 34 04 | 08.320.1000.852 | 31;32 |
| 006 250 45 03 | 08.270.1000.520 | 7;35;48 |
| 006 250 46 03 | 08.270.1000.520 | 7;35;48 |
| 006 250 47 03 | 08.270.1000.583 | 7;12;13;21 |
| 006 250 47 04 | 08.320.1000.722 | 32 |
| 006 250 48 04 | 08.320.1000.722 | 32 |
| 006 250 49 04 | 08.320.1000.722 | 32 |
| 006 250 67 04 | 08.320.1000.290 | 33 |
| 006 250 83 03 | 08.270.1000.563 | 21;34;48 |
| 006 250 84 03 | 08.270.1000.563 | 21;34;48 |
| 006 250 84 04 | 08.320.1000.862 | 20;32 |
| 006 250 86 04 | 08.320.1000.722 | 32 |
| 006 250 87 04 | 08.320.1000.722 | 32 |
| 006 250 88 04 | 08.320.1000.722 | 32 |
| 006 250 90 03 | 08.270.1000.520 | 7;35;48 |

| MERCEDES-BENZ | | |
|---------------|------------------------|-------------------|
| 007 250 05 04 | 08.320.1000.722 | 32 |
| 007 250 06 04 | 08.320.1000.722 | 32 |
| 007 250 07 04 | 08.320.1000.722 | 32 |
| 007 250 08 03 | 08.270.1000.520 | 7;35;48 |
| 007 250 09 03 | 08.270.1000.520 | 7;35;48 |
| 007 250 10 03 | 08.270.1000.520 | 7;35;48 |
| 007 250 15 04 | 08.320.1000.852 | 31;32 |
| 007 250 18 03 | 08.270.1000.570 | 34 |
| 007 250 21 03 | 08.270.1000.580 | 34 |
| 007 250 28 03 | 08.270.1000.550 | 34;42 |
| 007 250 28 04 | 08.320.1000.722 | 32 |
| 007 250 29 03 | 08.270.1000.550 | 34;42 |
| 007 250 29 04 | 08.320.1000.722 | 32 |
| 007 250 30 03 | 08.270.1000.540 | 7;12;34;42 |
| 007 250 30 04 | 08.320.1000.722 | 32 |
| 007 250 32 04 | 08.320.1000.722 | 32 |
| 007 250 33 04 | 08.320.1000.722 | 32 |
| 007 250 34 04 | 08.320.1000.722 | 32 |
| 007 250 38 03 | 08.270.1000.530 | 13;21;22;35;48;49 |
| 007 250 42 03 | 08.270.1000.590 | 36;43;49 |
| 007 250 43 03 | 08.270.1000.590 | 36;43;49 |
| 007 250 44 04 | 08.320.1000.722 | 32 |
| 007 250 46 03 | 08.270.1000.600 | 35 |
| 007 250 46 04 | 08.320.1000.722 | 32 |
| 007 250 47 03 | 08.270.1000.600 | 35 |
| 007 250 49 03 | 08.270.1000.610 | 35 |
| 007 250 50 03 | 08.270.1000.610 | 35 |
| 007 250 51 04 | 08.320.1000.722 | 32 |
| 007 250 58 03 | 08.270.1000.500 | 8;23;37 |
| 007 250 59 03 | 08.270.1000.500 | 8;23;37 |
| 007 250 60 03 | 08.270.1000.630 | 36;42;43 |
| 007 250 61 03 | 08.270.1000.630 | 36;42;43 |
| 007 250 61 04 | 08.320.1000.240 | 32;33 |
| 007 250 72 03 | 08.270.1000.550 | 34;42 |
| 007 250 74 03 | 08.270.1000.540 | 7;12;34;42 |
| 007 250 79 04 | 08.320.1000.230 | 33 |
| 007 250 81 04 | 08.320.1000.240 | 32;33 |
| 007 250 82 04 | 08.320.1000.722 | 32 |
| 008 250 08 03 | 08.270.1000.563 | 21;34;48 |
| 008 250 13 03 | 08.270.1000.661 | 36;42 |
| 008 250 14 03 | 08.270.1000.661 | 36;42 |

Vergleichsliste | Crosslist

aufsteigend nach Vergleichsnummer | ascending to Comp.-No.

| MERCEDES-BENZ | | | MERCEDES-BENZ | | |
|---------------|------------------------|-------------|---------------|------------------------|-------------|
| 008 250 16 03 | 08.270.1000.600 | 35 | 010 250 89 03 | 08.270.1000.630 | 36;42;43 |
| 008 250 17 03 | 08.270.1000.610 | 35 | 010 250 91 03 | 08.270.1000.661 | 36;42 |
| 008 250 19 03 | 08.270.1000.671 | 37 | 010 250 92 03 | 08.270.1000.661 | 36;42 |
| 008 250 20 03 | 08.270.1000.671 | 37 | 011 250 00 03 | 08.270.1000.520 | 7;35;48 |
| 008 250 22 03 | 08.270.1000.570 | 34 | 011 250 01 03 | 08.270.1000.520 | 7;35;48 |
| 008 250 23 03 | 08.270.1000.570 | 34 | 011 250 02 03 | 08.270.1000.520 | 7;35;48 |
| 008 250 30 04 | 08.320.1000.240 | 32;33 | 011 250 04 03 | 08.270.1000.671 | 37 |
| 008 250 31 04 | 08.320.1000.230 | 33 | 011 250 06 03 | 08.270.1000.500 | 8;23;37 |
| 008 250 35 04 | 08.320.1000.722 | 32 | 011 250 08 03 | 08.270.1000.620 | 35;55 |
| 008 250 36 03 | 08.270.1000.671 | 37 | 011 250 30 03 | 08.270.1000.831 | 22;23;36;37 |
| 008 250 37 03 | 08.270.1000.671 | 37 | 011 250 74 03 | 08.270.1000.550 | 34;42 |
| 008 250 46 03 | 08.270.1000.563 | 21;34;48 | 011 250 81 03 | 08.270.1000.563 | 21;34;48 |
| 008 250 51 03 | 08.270.1000.671 | 37 | 011 250 90 03 | 08.270.1000.791 | 23;37 |
| 008 250 72 03 | 08.270.1000.801 | 34 | 012 250 02 03 | 08.270.1000.583 | 7;12;13;21 |
| 008 250 79 03 | 08.270.1000.951 | 21;35;48;60 | 012 250 03 03 | 08.270.1000.583 | 7;12;13;21 |
| 008 250 80 03 | 08.270.1000.951 | 21;35;48;60 | 012 250 04 03 | 08.270.1000.583 | 7;12;13;21 |
| 008 250 81 03 | 08.270.1000.951 | 21;35;48;60 | 012 250 14 03 | 08.270.1000.500 | 8;23;37 |
| 008 250 82 03 | 08.270.1000.600 | 35 | 012 250 15 03 | 08.270.1000.500 | 8;23;37 |
| 008 250 83 03 | 08.270.1000.610 | 35 | 012 250 17 03 | 08.270.1000.791 | 23;37 |
| 009 250 12 03 | 08.270.1000.560 | 34;42 | 012 250 18 03 | 08.270.1000.791 | 23;37 |
| 009 250 13 03 | 08.270.1000.560 | 34;42 | 012 250 53 03 | 08.270.1000.791 | 23;37 |
| 009 250 19 03 | 08.270.1000.831 | 22;23;36;37 | 012 250 58 03 | 08.270.1000.831 | 22;23;36;37 |
| 009 250 20 03 | 08.270.1000.791 | 23;37 | 012 250 69 03 | 08.270.1000.520 | 7;35;48 |
| 009 250 21 03 | 08.270.1000.500 | 8;23;37 | 012 250 84 03 | 08.270.1000.791 | 23;37 |
| 009 250 31 03 | 08.270.1000.500 | 8;23;37 | 012 250 85 03 | 08.270.1000.791 | 23;37 |
| 009 250 40 03 | 08.270.1000.811 | 12;34 | 012 250 86 03 | 08.270.1000.620 | 35;55 |
| 009 250 43 03 | 08.270.1000.620 | 35;55 | 012 250 88 03 | 08.270.1000.620 | 35;55 |
| 009 250 44 03 | 08.270.1000.620 | 35;55 | 012 250 90 03 | 08.270.1000.620 | 35;55 |
| 010 250 00 03 | 08.270.1000.520 | 7;35;48 | 012 250 91 03 | 08.270.1000.620 | 35;55 |
| 010 250 02 03 | 08.270.1000.650 | 36;43 | 013 250 08 03 | 08.270.1000.791 | 23;37 |
| 010 250 14 03 | 08.270.1000.941 | 21;35;48 | 013 250 13 03 | 08.270.1000.831 | 22;23;36;37 |
| 010 250 22 03 | 08.270.1000.941 | 21;35;48 | 013 250 14 03 | 08.270.1000.831 | 22;23;36;37 |
| 010 250 55 03 | 08.270.1000.620 | 35;55 | 013 250 16 03 | 08.270.1000.791 | 23;37 |
| 010 250 57 03 | 08.270.1000.981 | 37 | 013 250 17 03 | 08.270.1000.791 | 23;37 |
| 010 250 58 03 | 08.270.1000.981 | 37 | 013 250 18 03 | 08.270.1000.831 | 22;23;36;37 |
| 010 250 74 03 | 08.270.1000.951 | 21;35;48;60 | 013 250 20 03 | 08.270.1000.500 | 8;23;37 |
| 010 250 77 03 | 08.270.1000.600 | 35 | 013 250 21 03 | 08.270.1000.500 | 8;23;37 |
| 010 250 78 03 | 08.270.1000.610 | 35 | 013 250 25 03 | 08.270.1000.831 | 22;23;36;37 |
| 010 250 85 03 | 08.270.1000.570 | 34 | 013 250 26 03 | 08.270.1000.671 | 37 |
| 010 250 86 03 | 08.270.1000.801 | 34 | 013 250 27 03 | 08.270.1000.831 | 22;23;36;37 |
| 010 250 88 03 | 08.270.1000.630 | 36;42;43 | 013 250 28 03 | 08.270.1000.791 | 23;37 |

aufsteigend nach Vergleichsnummer | ascending to Comp.-No.

| MERCEDES-BENZ | | |
|---------------|------------------------|-------------|
| 013 250 30 03 | 08.270.1000.500 | 8;23;37 |
| 013 250 33 03 | 08.270.1000.791 | 23;37 |
| 013 250 35 03 | 08.270.1000.791 | 23;37 |
| 013 250 38 03 | 08.270.1000.620 | 35;55 |
| 013 250 39 03 | 08.270.1000.500 | 8;23;37 |
| 013 250 41 03 | 08.270.1000.671 | 37 |
| 013 250 42 03 | 08.270.1000.831 | 22;23;36;37 |
| 013 250 54 03 | 08.270.1000.570 | 34 |
| 013 250 71 03 | 08.270.1000.791 | 23;37 |
| 013 250 74 03 | 08.270.1000.981 | 37 |
| 013 250 79 03 | 08.270.1000.981 | 37 |
| 013 250 82 03 | 08.270.1000.801 | 34 |
| 013 250 87 03 | 08.270.1000.981 | 37 |
| 013 250 88 03 | 08.270.1000.981 | 37 |
| 013 250 89 03 | 08.270.1000.570 | 34 |
| 013 250 92 03 | 08.270.1000.801 | 34 |
| 014 250 68 03 | 08.270.1000.620 | 35;55 |
| 014 250 76 03 | 08.270.1000.981 | 37 |
| 014 250 77 03 | 08.270.1000.981 | 37 |
| 014 250 78 03 | 08.270.1000.981 | 37 |
| 014 250 94 03 | 08.270.1000.580 | 34 |
| 014 250 99 03 | 08.270.1000.791 | 23;37 |
| 015 250 00 03 | 08.270.1000.791 | 23;37 |
| 015 250 02 03 | 08.270.1000.500 | 8;23;37 |
| 015 250 22 03 | 08.270.1000.671 | 37 |
| 015 250 23 03 | 08.270.1000.500 | 8;23;37 |
| 015 250 24 03 | 08.270.1000.981 | 37 |
| 015 250 27 03 | 08.270.1000.620 | 35;55 |
| 015 250 28 03 | 08.270.1000.791 | 23;37 |
| 015 250 30 03 | 08.270.1000.791 | 23;37 |
| 015 250 32 03 | 08.270.1000.620 | 35;55 |
| 015 250 39 03 | 08.270.1000.831 | 22;23;36;37 |
| 015 250 40 03 | 08.270.1000.831 | 22;23;36;37 |
| 015 250 46 03 | 08.270.1000.991 | 35;36 |
| 015 250 63 03 | 08.270.1000.991 | 35;36 |
| 015 250 71 03 | 08.270.1000.640 | 37;38 |
| 015 250 72 03 | 08.270.1000.640 | 37;38 |
| 015 250 73 03 | 08.270.1000.640 | 37;38 |
| 015 250 75 03 | 08.270.1000.640 | 37;38 |
| 015 250 76 03 | 08.270.1000.640 | 37;38 |
| 015 250 77 03 | 08.270.1000.640 | 37;38 |

| MERCEDES-BENZ | | |
|---------------|------------------------|-------------|
| 015 250 79 03 | 08.270.1000.731 | 36 |
| 015 250 80 03 | 08.270.1000.731 | 36 |
| 015 250 81 03 | 08.270.1000.731 | 36 |
| 015 250 83 03 | 08.270.1000.821 | 22;36 |
| 015 250 84 03 | 08.270.1000.821 | 22;36 |
| 015 250 85 03 | 08.270.1000.821 | 22;36 |
| 015 250 95 03 | 08.270.1000.620 | 35;55 |
| 015 250 98 03 | 08.270.1000.971 | 38 |
| 015 250 99 03 | 08.270.1000.971 | 38 |
| 016 250 00 03 | 08.270.1000.971 | 38 |
| 016 250 01 03 | 08.270.1000.971 | 38 |
| 016 250 03 03 | 08.270.1000.971 | 38 |
| 016 250 04 03 | 08.270.1000.971 | 38 |
| 016 250 05 03 | 08.270.1000.971 | 38 |
| 016 250 07 03 | 08.270.1000.831 | 22;23;36;37 |
| 016 250 08 03 | 08.270.1000.831 | 22;23;36;37 |
| 016 250 09 03 | 08.270.1000.671 | 37 |
| 016 250 10 03 | 08.270.1000.671 | 37 |
| 016 250 12 03 | 08.270.1000.831 | 22;23;36;37 |
| 016 250 13 03 | 08.270.1000.831 | 22;23;36;37 |
| 016 250 14 03 | 08.270.1000.791 | 23;37 |
| 016 250 15 03 | 08.270.1000.791 | 23;37 |
| 016 250 16 03 | 08.270.1000.791 | 23;37 |
| 016 250 17 03 | 08.270.1000.500 | 8;23;37 |
| 016 250 18 03 | 08.270.1000.500 | 8;23;37 |
| 016 250 19 03 | 08.270.1000.630 | 36;42;43 |
| 016 250 25 03 | 08.270.1000.831 | 22;23;36;37 |
| 016 250 26 03 | 08.270.1000.831 | 22;23;36;37 |
| 016 250 27 03 | 08.270.1000.671 | 37 |
| 016 250 28 03 | 08.270.1000.671 | 37 |
| 016 250 29 03 | 08.270.1000.831 | 22;23;36;37 |
| 016 250 30 03 | 08.270.1000.791 | 23;37 |
| 016 250 31 03 | 08.270.1000.791 | 23;37 |
| 016 250 32 03 | 08.270.1000.791 | 23;37 |
| 016 250 33 03 | 08.270.1000.791 | 23;37 |
| 016 250 34 03 | 08.270.1000.791 | 23;37 |
| 016 250 35 03 | 08.270.1000.633 | 8;23;37;43 |
| 016 250 36 03 | 08.270.1000.633 | 8;23;37;43 |
| 016 250 37 03 | 08.270.1000.633 | 8;23;37;43 |
| 016 250 38 03 | 08.270.1000.620 | 35;55 |
| 016 250 39 03 | 08.270.1000.620 | 35;55 |

Vergleichsliste | Crosslist

aufsteigend nach Vergleichsnummer | ascending to Comp.-No.

| MERCEDES-BENZ | | |
|---------------|------------------------|-------------------|
| 016 250 40 03 | 08.270.1000.981 | 37 |
| 016 250 41 03 | 08.270.1000.981 | 37 |
| 016 250 42 03 | 08.270.1000.981 | 37 |
| 016 250 43 03 | 08.270.1000.500 | 8;23;37 |
| 016 250 44 03 | 08.270.1000.500 | 8;23;37 |
| 016 250 45 03 | 08.270.1000.791 | 23;37 |
| 016 250 46 03 | 08.270.1000.633 | 8;23;37;43 |
| 016 250 47 03 | 08.270.1000.831 | 22;23;36;37 |
| 016 250 49 03 | 08.270.1000.620 | 35;55 |
| 016 250 50 03 | 08.270.1000.981 | 37 |
| 016 250 99 03 | 08.270.1000.821 | 22;36 |
| 017 250 00 03 | 08.270.1000.821 | 22;36 |
| 017 250 03 03 | 08.270.1000.731 | 36 |
| 017 250 04 03 | 08.270.1000.821 | 22;36 |
| 017 250 05 03 | 08.270.1000.691 | 34;35 |
| 017 250 06 03 | 08.270.1000.691 | 34;35 |
| 017 250 09 03 | 08.270.1000.731 | 36 |
| 017 250 11 03 | 08.270.1000.731 | 36 |
| 017 250 13 03 | 08.270.1000.821 | 22;36 |
| 017 250 47 03 | 08.270.1000.620 | 35;55 |
| 017 250 48 03 | 08.270.1000.620 | 35;55 |
| 017 250 49 03 | 08.270.1000.620 | 35;55 |
| 017 250 67 03 | 08.270.1000.971 | 38 |
| 017 250 68 03 | 08.270.1000.971 | 38 |
| 017 250 69 03 | 08.270.1000.971 | 38 |
| 017 250 84 03 | 08.270.1000.791 | 23;37 |
| 017 250 85 03 | 08.270.1000.831 | 22;23;36;37 |
| 017 250 87 03 | 08.270.1000.633 | 8;23;37;43 |
| 017 250 90 03 | 08.270.1000.831 | 22;23;36;37 |
| 018 250 11 03 | 08.270.1000.731 | 36 |
| 018 250 13 03 | 08.270.1000.731 | 36 |
| 018 250 20 03 | 08.270.1000.633 | 8;23;37;43 |
| 018 250 22 03 | 08.270.1000.640 | 37;38 |
| 018 250 23 03 | 08.270.1000.640 | 37;38 |
| 018 250 24 03 | 08.270.1000.640 | 37;38 |
| 018 250 25 03 | 08.270.1000.640 | 37;38 |
| 018 250 36 03 | 08.270.1000.620 | 35;55 |
| 018 250 37 03 | 08.270.1000.540 | 7;12;34;42 |
| 018 250 60 03 | 08.270.1000.731 | 36 |
| 018 250 71 03 | 08.270.1000.640 | 37;38 |
| 018 250 80 03 | 08.270.1000.881 | 14;23;24;37;43;50 |

| MERCEDES-BENZ | | |
|---------------|------------------------|-------------|
| 018 250 85 03 | 08.270.1000.821 | 22;36 |
| 018 250 91 01 | 08.340.1206.1 S | 29 |
| 018 250 92 03 | 08.270.1000.691 | 34;35 |
| 018 250 93 03 | 08.270.1000.500 | 8;23;37 |
| 018 250 94 01 | 08.340.1122.1 S | 27 |
| 018 250 94 03 | 08.270.1000.633 | 8;23;37;43 |
| 018 250 95 01 | 08.340.1117.1 S | 27;28 |
| 018 250 95 03 | 08.270.1000.791 | 23;37 |
| 018 250 96 01 | 08.340.1116.1 S | 28 |
| 018 250 96 03 | 08.270.1000.791 | 23;37 |
| 018 250 97 01 | 08.340.1105.1 S | 28 |
| 018 250 98 01 | 08.340.1262.1 S | 29 |
| 018 250 99 01 | 08.340.1206.1 S | 29 |
| 018 250 99 03 | 08.270.1000.791 | 23;37 |
| 019 250 00 01 | 08.340.1206.1 S | 29 |
| 019 250 01 01 | 08.340.1206.1 S | 29 |
| 019 250 02 01 | 08.340.1121.1 S | 28;29 |
| 019 250 04 03 | 08.270.1000.831 | 22;23;36;37 |
| 019 250 05 01 | 08.340.1206.1 S | 29 |
| 019 250 08 03 | 08.270.1000.500 | 8;23;37 |
| 019 250 30 03 | 08.270.1000.640 | 37;38 |
| 019 250 32 03 | 08.270.1000.791 | 23;37 |
| 019 250 42 03 | 08.270.1000.691 | 34;35 |
| 019 250 49 03 | 08.270.1000.640 | 37;38 |
| 019 250 52 03 | 08.270.1000.731 | 36 |
| 019 250 53 03 | 08.270.1000.821 | 22;36 |
| 019 250 54 03 | 08.270.1000.640 | 37;38 |
| 019 250 55 03 | 08.270.1000.971 | 38 |
| 019 250 57 03 | 08.270.1000.640 | 37;38 |
| 019 250 58 03 | 08.270.1000.971 | 38 |
| 019 250 59 03 | 08.270.1000.821 | 22;36 |
| 019 250 60 03 | 08.270.1000.640 | 37;38 |
| 019 250 61 03 | 08.270.1000.731 | 36 |
| 019 250 64 01 | 08.320.1000.290 | 33 |
| 019 250 65 01 | 08.340.1116.1 S | 28 |
| 019 250 66 03 | 08.270.1000.633 | 8;23;37;43 |
| 019 250 68 03 | 08.270.1000.500 | 8;23;37 |
| 019 250 88 03 | 08.270.1000.640 | 37;38 |
| 019 250 91 03 | 08.270.1000.691 | 34;35 |
| 020 250 00 03 | 08.270.1000.991 | 35;36 |
| 020 250 15 03 | 08.270.1000.640 | 37;38 |

aufsteigend nach Vergleichsnummer | ascending to Comp.-No.

| MERCEDES-BENZ | | |
|---------------|------------------------|-------------|
| 020 250 19 03 | 08.270.1000.971 | 38 |
| 020 250 40 03 | 08.270.1000.640 | 37;38 |
| 020 250 44 03 | 08.270.1000.971 | 38 |
| 020 250 45 01 | 08.340.1106.1 S | 28 |
| 020 250 45 03 | 08.270.1000.640 | 37;38 |
| 020 250 46 03 | 08.270.1000.971 | 38 |
| 020 250 47 01 | 08.340.1004.1 S | 30 |
| 020 250 48 01 | 08.340.1006.1 S | 29;30 |
| 020 250 49 01 | 08.340.1005.1 S | 30 |
| 020 250 50 01 | 08.340.1001.1 S | 29 |
| 020 250 51 01 | 08.340.1118.1 S | 30;31 |
| 020 250 52 01 | 08.340.1203.1 S | 30 |
| 020 250 53 01 | 08.340.1207.1 S | 27 |
| 020 250 54 01 | 08.340.1263.1 S | 27 |
| 020 250 56 01 | 08.340.1206.1 S | 29 |
| 020 250 58 03 | 08.270.1000.633 | 8;23;37;43 |
| 020 250 59 03 | 08.270.1000.791 | 23;37 |
| 020 250 85 01 | 08.340.1206.1 S | 29 |
| 020 250 86 01 | 08.340.1206.1 S | 29 |
| 020 250 87 01 | 08.340.1121.1 S | 28;29 |
| 020 250 89 01 | 08.340.1206.1 S | 29 |
| 020 250 89 03 | 08.270.1000.971 | 38 |
| 020 250 91 01 | 08.340.1121.1 S | 28;29 |
| 020 250 91 03 | 08.270.1000.640 | 37;38 |
| 020 250 92 03 | 08.270.1000.640 | 37;38 |
| 020 250 93 01 | 08.340.1121.1 S | 28;29 |
| 020 250 93 03 | 08.270.1000.821 | 22;36 |
| 020 250 94 03 | 08.270.1000.731 | 36 |
| 020 250 97 03 | 08.270.1000.831 | 22;23;36;37 |
| 020 250 98 01 | 08.270.1000.731 | 36 |
| 021 250 06 01 | 08.340.1206.1 S | 29 |
| 021 250 07 01 | 08.340.1105.1 S | 28 |
| 021 250 08 01 | 08.340.1206.1 S | 29 |
| 021 250 42 01 | 08.340.1206.1 S | 29 |
| 021 250 43 01 | 08.340.1206.1 S | 29 |
| 021 250 62 01 | 08.340.1206.1 S | 29 |
| 021 250 63 01 | 08.340.1206.1 S | 29 |
| 021 250 66 03 | 08.270.1000.991 | 35;36 |
| 021 250 86 01 | 08.340.1206.1 S | 29 |
| 021 250 94 01 | 08.340.1206.1 S | 29 |
| 021 250 95 01 | 08.340.1206.1 S | 29 |

| MERCEDES-BENZ | | |
|---------------|------------------------|-------------------|
| 021 250 96 01 | 08.340.1121.1 S | 28;29 |
| 021 250 97 01 | 08.340.1206.1 S | 29 |
| 022 250 09 01 | 08.340.1206.1 S | 29 |
| 022 250 11 01 | 08.340.1206.1 S | 29 |
| 022 250 14 01 | 08.340.1121.1 S | 28;29 |
| 022 250 15 01 | 08.340.1206.1 S | 29 |
| 022 250 17 01 | 08.340.1121.1 S | 28;29 |
| 022 250 20 01 | 08.320.1000.230 | 33 |
| 022 250 23 01 | 08.270.1000.640 | 37;38 |
| 022 250 48 01 | 08.340.1105.1 S | 28 |
| 022 250 56 01 | 08.340.1206.1 S | 29 |
| 022 250 57 01 | 08.340.1206.1 S | 29 |
| 312 032 01 05 | 08.160.1001.010 | 72 |
| 312 250 13 15 | 08.290.7000.240 | 38 |
| 314 032 05 05 | 08.160.1001.010 | 72 |
| 315 032 01 05 | 08.160.1001.020 | 72;73 |
| 317 250 04 03 | 08.270.1000.530 | 13;21;22;35;48;49 |
| 320 250 00 15 | 08.290.7000.170 | 39 |
| 327 030 02 11 | 08.150.1001.150 | 70 |
| 340 250 02 15 | 08.290.7000.240 | 38 |
| 343 254 00 10 | 08.290.7000.170 | 39 |
| 344 250 72 03 | 08.270.1000.530 | 13;21;22;35;48;49 |
| 345 030 02 05 | 08.150.1001.180 | 70 |
| 345 250 74 03 | 08.270.1000.560 | 34;42 |
| 345 250 75 03 | 08.270.1000.801 | 34 |
| 352 030 39 05 | 08.150.1001.130 | 69;70 |
| 352 030 73 05 | 08.150.1001.120 | 69 |
| 352 032 01 05 | 08.160.1001.030 | 73 |
| 352 032 06 05 | 08.160.1001.030 | 73 |
| 352 032 11 05 | 08.160.1001.000 | 72 |
| 352 032 13 05 | 08.160.S9960000 | 72 |
| 352 250 01 15 | 08.290.7000.240 | 38 |
| 352 250 05 15 | 08.290.7000.240 | 38 |
| 355 030 09 05 | 08.150.1001.170 | 70 |
| 355 030 13 05 | 08.150.1001.170 | 70 |
| 355 030 14 05 | 08.150.1001.170 | 70 |
| 360 030 08 11 | 08.150.1001.150 | 70 |
| 363 250 01 14 | 08.290.1933.1 S | 66 |
| 364 030 01 05 | 08.150.1001.140 | 70 |
| 366 030 09 05 | 08.150.1001.160 | 70 |
| 381 250 04 15 | 08.290.7000.030 | 38;44 |

Vergleichsliste | Crosslist

aufsteigend nach Vergleichsnummer | ascending to Comp.-No.

| MERCEDES-BENZ | | |
|----------------------|------------------------|-------|
| 385 250 00 14 | 08.290.1928.1 S | 66 |
| 385 268 14 74 | 08.280.1922.000 | 66 |
| 403 030 08 05 | 08.150.1001.060 | 68 |
| 403 030 13 05 | 08.150.1001.050 | 68 |
| 403 030 14 05 | 08.150.1001.060 | 68 |
| 403 030 16 05 | 08.150.1001.050 | 68 |
| 403 032 00 05 | 08.160.1001.040 | 73 |
| 403 032 02 05 | 08.160.1001.040 | 73 |
| 403 032 03 05 | 08.160.1001.040 | 73 |
| 403 032 04 05 | 08.160.1001.040 | 73 |
| 403 032 05 05 | 08.160.1001.040 | 73 |
| 422 030 05 05 | 08.150.1001.090 | 69 |
| 422 032 00 01 | 08.150.1001.090 | 69 |
| 441 030 04 05 | 08.150.1001.070 | 68 |
| 442 030 02 05 | 08.150.1001.080 | 68;69 |
| 442 030 05 05 | 08.150.1001.110 | 69 |
| 442 030 10 05 | 08.150.1001.110 | 69 |
| 442 030 19 05 | 08.150.1001.110 | 69 |
| 447 030 18 05 | 08.150.1001.060 | 68 |
| 457 030 06 05 | 08.150.1001.190 | 70;71 |
| 541 030 01 05 | 08.150.1001.100 | 69 |
| 620 250 02 14 | 08.290.1941.1 S | 66;67 |
| 650 250 00 13 | 08.290.1002.010 | 65 |
| 650 250 31 13 | 08.290.1002.010 | 65 |
| 650 250 38 13 | 08.290.1002.010 | 65 |
| 650 254 00 06 | 08.290.1002.000 | 65 |
| 650 254 00 06 S | 08.290.1942.1 S | 67 |
| 655 250 15 13 | 08.290.1002.030 | 65 |
| 655 254 02 06 | 08.290.1002.060 | 65;66 |
| 655 254 02 06 S | 08.290.1941.30S | 67 |
| 655 254 02 06 S | 08.290.1941.3 S | 67 |
| 906 030 32 05 | 08.150.1001.200 | 71 |
| 906 030 38 05 | 08.150.1001.200 | 71 |
| 912009 037200 | 08.290.1941.060 | 72 |

| NEOPLAN | | |
|----------------|------------------------|------------|
| 0421.019.00 | 08.320.1000.250 | 16 |
| 0421.510.00 | 08.290.7000.560 | 25;41;44 |
| 11009972 | 08.320.1000.250 | 16 |
| 11010031 | 08.270.1000.633 | 8;23;37;43 |
| 11079828 | 08.270.1000.500 | 8;23;37 |

| NEOPLAN | | |
|----------------|------------------------|------------|
| 421035300 | 08.270.1000.633 | 8;23;37;43 |

| NK | | |
|-----------|------------------------|-------|
| 123310 | 08.290.7000.200 | 38 |
| 123311 | 08.290.7000.030 | 38;44 |
| 123312 | 08.290.7000.240 | 38 |
| 123314 | 08.290.7000.100 | 38 |

| RENAULT | | |
|----------------|------------------------|-------------------|
| 0000141306 | 08.160.4250.450 | 73;74 |
| 0001 141 034 | 08.270.1000.553 | 7;8;49;55 |
| 0001 141 035 | 08.290.7000.160 | 9;14;15;24;51 |
| 0001 144 060 | 08.270.1000.613 | 23;49;50 |
| 0001 151 423 | 08.270.1000.613 | 23;49;50 |
| 0001 152 310 | 08.270.1000.593 | 49 |
| 0001 154 566 | 08.270.1000.593 | 49 |
| 0023 618 037 | 08.270.1000.530 | 13;21;22;35;48;49 |
| 0023 818 037 | 08.270.1000.530 | 13;21;22;35;48;49 |
| 5000 058 221 | 08.290.7000.090 | 9;14;24;51;63 |
| 5000 059 526 | 08.270.1000.623 | 49 |
| 5000 240 864 | 08.290.7000.090 | 9;14;24;51;63 |
| 5000 251 362 | 08.290.7000.060 | 9;14;24;51 |
| 5000 289 010 | 08.270.1000.941 | 21;35;48 |
| 5000 295 069 | 08.270.1000.563 | 21;34;48 |
| 5000 456 367 | 08.290.7000.060 | 9;14;24;51 |
| 5000 559 741 | 08.270.1000.520 | 7;35;48 |
| 5000 587 571 | 08.270.1000.590 | 36;43;49 |
| 5000 589 571 | 08.270.1000.590 | 36;43;49 |
| 5000 613 650 | 08.290.7000.090 | 9;14;24;51;63 |
| 5000 663 606 | 08.150.4250.420 | 71 |
| 5000 666 395 | 08.150.4250.440 | 72 |
| 5000 667 054 | 08.270.1000.593 | 49 |
| 5000 677 007 | 08.270.1000.593 | 49 |
| 5000 677 053 | 08.270.1000.613 | 23;49;50 |
| 5000 677 055 | 08.270.1000.613 | 23;49;50 |
| 5000 677 075 | 08.290.7000.090 | 9;14;24;51;63 |
| 5000 677 134 | 08.270.1000.593 | 49 |
| 5000 677 154 | 08.270.1000.593 | 49 |
| 5000 677 165 | 08.270.1000.841 | 49 |
| 5000 677 180 | 08.290.7000.140 | 14;51 |
| 5000 677 197 | 08.290.7000.140 | 14;51 |

aufsteigend nach Vergleichsnummer | ascending to Comp.-No.

| RENAULT | | |
|--------------|------------------------|-------------------|
| 5000 677 243 | 08.270.1000.593 | 49 |
| 5000 677 244 | 08.270.1000.593 | 49 |
| 5000 677 249 | 08.270.1000.623 | 49 |
| 5000 677 254 | 08.270.1000.613 | 23;49;50 |
| 5000 677 285 | 08.270.1000.613 | 23;49;50 |
| 5000 677 295 | 08.270.1000.841 | 49 |
| 5000 677 308 | 08.270.1000.781 | 12;48 |
| 5000 677 328 | 08.270.1000.593 | 49 |
| 5000 677 343 | 08.270.1000.593 | 49 |
| 5000 686 610 | 08.150.4250.430 | 71;72 |
| 5000 788 292 | 08.270.1000.593 | 49 |
| 5000 789 351 | 08.270.1000.530 | 13;21;22;35;48;49 |
| 5000 807 806 | 08.290.7000.250 | 24;51 |
| 5000 809 155 | 08.290.7000.090 | 9;14;24;51;63 |
| 5000 821 820 | 08.270.1000.530 | 13;21;22;35;48;49 |
| 5000 822 147 | 08.270.1000.590 | 36;43;49 |
| 5000 822 629 | 08.270.1000.751 | 22;43;49 |
| 5000 841 312 | 08.320.1000.962 | 19;47;48 |
| 5001 001 621 | 08.270.1000.563 | 21;34;48 |
| 5001 001 622 | 08.290.7000.290 | 24;51 |
| 5001 001 623 | 08.290.7000.060 | 9;14;24;51 |
| 5001 001 629 | 08.320.1000.962 | 19;47;48 |
| 5001 486 489 | 08.340.1249.1 S | 46 |
| 5001 824 450 | 08.270.1000.613 | 23;49;50 |
| 5001 825 649 | 08.290.7000.550 | 25;41;51;52;56;64 |
| 5001 837 123 | 08.320.1000.922 | 47 |
| 5001 843 361 | 08.340.1221.1 S | 45 |
| 5001 858 682 | 08.290.7000.020 | 9;15;25;40;51 |
| 5001 859 387 | 08.340.1260.1 S | 46 |
| 5001 864 270 | 08.290.7000.020 | 9;15;25;40;51 |
| 5001 866 621 | 08.270.1000.881 | 14;23;24;37;43;50 |
| 5001 866 621 | 08.290.7000.420 | 9;10;25 |
| 5001 866 623 | 08.290.7000.090 | 9;14;24;51;63 |
| 5001 866 625 | 08.290.7000.090 | 9;14;24;51;63 |
| 5001 873 287 | 08.290.7000.020 | 9;15;25;40;51 |
| 5010 244 017 | 08.290.7000.400 | 52 |
| 5010 244 077 | 08.270.1000.573 | 21;48 |
| 5010 244 086 | 08.290.7000.390 | 52 |
| 5010 244 091 | 08.270.1000.623 | 49 |
| 5010 244 093 | 08.320.1000.902 | 47 |
| 5010 244 094 | 08.320.1000.902 | 47 |

| RENAULT | | |
|--------------|------------------------|-------------------|
| 5010 244 097 | 08.320.1000.922 | 47 |
| 5010 244 144 | 08.270.1000.781 | 12;48 |
| 5010 244 184 | 08.270.1000.593 | 49 |
| 5010 244 202 | 08.290.7000.400 | 52 |
| 5010 244 203 | 08.320.1000.922 | 47 |
| 5010 244 242 | 08.270.1000.573 | 21;48 |
| 5010 244 256 | 08.270.1000.593 | 49 |
| 5010 244 265 | 08.320.1000.922 | 47 |
| 5010 244 303 | 08.270.1000.881 | 14;23;24;37;43;50 |
| 5010 244 324 | 08.270.1000.623 | 49 |
| 5010 244 325 | 08.270.1000.881 | 14;23;24;37;43;50 |
| 5010 244 379 | 08.270.1000.593 | 49 |
| 5010 244 390 | 08.290.7000.420 | 9;10;25 |
| 5010 244 412 | 08.270.1000.593 | 49 |
| 5010 245 447 | 08.270.1000.623 | 49 |
| 5010 245 448 | 08.270.1000.593 | 49 |
| 5010 245 455 | 08.270.1000.881 | 14;23;24;37;43;50 |
| 5010 245 457 | 08.290.7000.430 | 52 |
| 5010 245 921 | 08.290.7000.430 | 52 |
| 5010 452 025 | 08.290.7000.410 | 25 |
| 5010 452 026 | 08.270.1000.912 | 49 |
| 5010 452 507 | 08.270.1000.623 | 49 |
| 5010 452 572 | 08.270.1000.573 | 21;48 |
| 5010 545 038 | 08.270.1000.881 | 14;23;24;37;43;50 |
| 5010 545 829 | 08.270.1000.881 | 14;23;24;37;43;50 |
| 5010 613 657 | 08.270.1000.881 | 14;23;24;37;43;50 |
| 5010 837 119 | 08.320.1000.922 | 47 |
| 5430 013 403 | 08.270.1000.593 | 49 |
| 5430 120 506 | 08.270.1000.593 | 49 |
| 5516 021 267 | 08.290.7000.090 | 9;14;24;51;63 |
| 5800 207 033 | 08.290.7000.290 | 24;51 |
| 5800 207 047 | 08.270.1000.563 | 21;34;48 |
| 7420 707 024 | 08.270.1000.523 | 50;62 |
| 7420 707 025 | 08.270.1000.783 | 50;62 |
| 7420 725 523 | 08.270.1000.823 | 50 |
| 7420 730 004 | 08.290.7000.350 | 63 |
| 7420 730 007 | 08.290.7000.530 | 64 |
| 8000 243 160 | 08.270.1000.530 | 13;21;22;35;48;49 |
| 8010 244 204 | 08.290.7000.390 | 52 |

| RENAULT TRUCKS | | |
|----------------|------------------------|----|
| 5000663606 | 08.150.4250.420 | 71 |

Vergleichsliste | Crosslist

aufsteigend nach Vergleichsnummer | ascending to Comp.-No.

| RENAULT TRUCKS | | | SACHS | | |
|----------------|------------------------|-------------------|--------------|------------------------|-------------------|
| 5000666395 | 08.150.4250.440 | 72 | 1861 291 006 | 08.270.1000.580 | 34 |
| 5000686610 | 08.150.4250.430 | 71;72 | 1861 291 033 | 08.270.1000.580 | 34 |
| SAAB | | | 1861 291 036 | 08.270.1000.580 | 34 |
| 1 101 588 | 08.270.3003.610 | 55 | 1861 291 136 | 08.270.1000.580 | 34 |
| 1 321 255 | 08.290.7000.340 | 56 | 1861 291 251 | 08.270.1000.580 | 34 |
| 1 322 781 | 08.290.7000.340 | 56 | 1861 303 209 | 08.270.1000.560 | 34;42 |
| 1 382 332 | 08.320.1000.772 | 54 | 1861 303 213 | 08.270.1000.801 | 34 |
| 165499 | 08.270.1000.553 | 7;8;49;55 | 1861 303 216 | 08.270.1000.560 | 34;42 |
| SACHS | | | 1861 303 232 | 08.270.1000.560 | 34;42 |
| 1681 511 201 | 08.270.1000.590 | 36;43;49 | 1861 303 237 | 08.270.1000.801 | 34 |
| 1800 125 301 | 08.340.1205.1 S | 28 | 1861 303 243 | 08.270.1000.801 | 34 |
| 1851 117 201 | 08.290.7000.060 | 9;14;24;51 | 1861 303 246 | 08.270.1000.560 | 34;42 |
| 1851 151 001 | 08.290.7000.090 | 9;14;24;51;63 | 1861 303 248 | 08.270.1000.801 | 34 |
| 1861 174 033 | 08.270.1000.570 | 34 | 1861 303 252 | 08.270.1000.801 | 34 |
| 1861 174 034 | 08.270.1000.570 | 34 | 1861 321 135 | 08.270.1000.530 | 13;21;22;35;48;49 |
| 1861 174 134 | 08.270.1000.570 | 34 | 1861 321 139 | 08.270.1000.530 | 13;21;22;35;48;49 |
| 1861 206 112 | 08.270.1000.553 | 7;8;49;55 | 1861 325 106 | 08.270.1000.540 | 7;12;34;42 |
| 1861 206 212 | 08.270.1000.553 | 7;8;49;55 | 1861 325 141 | 08.270.1000.540 | 7;12;34;42 |
| 1861 206 213 | 08.270.1000.553 | 7;8;49;55 | 1861 351 338 | 08.270.1000.583 | 7;12;13;21 |
| 1861 206 242 | 08.270.1000.553 | 7;8;49;55 | 1861 351 340 | 08.270.1000.583 | 7;12;13;21 |
| 1861 219 108 | 08.270.1000.530 | 13;21;22;35;48;49 | 1861 351 341 | 08.270.1000.583 | 7;12;13;21 |
| 1861 219 139 | 08.270.1000.530 | 13;21;22;35;48;49 | 1861 380 137 | 08.270.1000.543 | 60 |
| 1861 219 142 | 08.270.1000.530 | 13;21;22;35;48;49 | 1861 380 339 | 08.270.1000.543 | 60 |
| 1861 219 150 | 08.270.1000.530 | 13;21;22;35;48;49 | 1861 410 021 | 08.270.1000.590 | 36;43;49 |
| 1861 219 157 | 08.270.1000.530 | 13;21;22;35;48;49 | 1861 410 032 | 08.270.1000.650 | 36;43 |
| 1861 234 001 | 08.270.1000.811 | 12;34 | 1861 410 035 | 08.270.1000.590 | 36;43;49 |
| 1861 234 004 | 08.270.1000.811 | 12;34 | 1861 410 040 | 08.270.1000.590 | 36;43;49 |
| 1861 234 010 | 08.270.1000.811 | 12;34 | 1861 410 041 | 08.270.1000.590 | 36;43;49 |
| 1861 254 007 | 08.270.1000.570 | 34 | 1861 410 045 | 08.270.1000.590 | 36;43;49 |
| 1861 254 034 | 08.270.1000.570 | 34 | 1861 410 046 | 08.270.1000.590 | 36;43;49 |
| 1861 254 037 | 08.270.1000.570 | 34 | 1861 410 047 | 08.270.1000.650 | 36;43 |
| 1861 258 031 | 08.270.1000.811 | 12;34 | 1861 410 068 | 08.270.1000.590 | 36;43;49 |
| 1861 274 233 | 08.270.1000.811 | 12;34 | 1861 437 034 | 08.270.1000.753 | 60 |
| 1861 274 235 | 08.270.1000.540 | 7;12;34;42 | 1861 437 337 | 08.270.1000.753 | 60 |
| 1861 274 237 | 08.270.1000.811 | 12;34 | 1861 460 104 | 08.270.1000.520 | 7;35;48 |
| 1861 274 238 | 08.270.1000.540 | 7;12;34;42 | 1861 460 136 | 08.270.1000.520 | 7;35;48 |
| 1861 288 135 | 08.270.1000.811 | 12;34 | 1861 460 137 | 08.270.1000.520 | 7;35;48 |
| 1861 288 136 | 08.270.1000.811 | 12;34 | 1861 460 138 | 08.270.1000.520 | 7;35;48 |
| 1861 288 147 | 08.270.1000.811 | 12;34 | 1861 486 202 | 08.270.1000.583 | 7;12;13;21 |
| | | | 1861 486 231 | 08.270.1000.583 | 7;12;13;21 |
| | | | 1861 486 232 | 08.270.1000.583 | 7;12;13;21 |

aufsteigend nach Vergleichsnummer | ascending to Comp.-No.

| SACHS | | |
|--------------|------------------------|-------------|
| 1861 486 233 | 08.270.1000.583 | 7;12;13;21 |
| 1861 486 234 | 08.270.1000.583 | 7;12;13;21 |
| 1861 488 108 | 08.270.1000.941 | 21;35;48 |
| 1861 488 133 | 08.270.1000.941 | 21;35;48 |
| 1861 488 140 | 08.270.1000.941 | 21;35;48 |
| 1861 488 233 | 08.270.1000.941 | 21;35;48 |
| 1861 494 133 | 08.270.1000.520 | 7;35;48 |
| 1861 494 140 | 08.270.1000.520 | 7;35;48 |
| 1861 494 145 | 08.270.1000.520 | 7;35;48 |
| 1861 494 146 | 08.270.1000.520 | 7;35;48 |
| 1861 494 149 | 08.270.1000.520 | 7;35;48 |
| 1861 498 231 | 08.270.1000.563 | 21;34;48 |
| 1861 498 234 | 08.270.1000.563 | 21;34;48 |
| 1861 498 235 | 08.270.1000.563 | 21;34;48 |
| 1861 511 202 | 08.270.1000.590 | 36;43;49 |
| 1861 511 232 | 08.270.1000.590 | 36;43;49 |
| 1861 531 032 | 08.270.1000.540 | 7;12;34;42 |
| 1861 560 232 | 08.270.1000.681 | 13 |
| 1861 560 234 | 08.270.1000.681 | 13 |
| 1861 571 131 | 08.270.1000.550 | 34;42 |
| 1861 571 136 | 08.270.1000.550 | 34;42 |
| 1861 571 236 | 08.270.1000.550 | 34;42 |
| 1861 584 036 | 08.270.1000.951 | 21;35;48;60 |
| 1861 584 110 | 08.270.1000.951 | 21;35;48;60 |
| 1861 584 137 | 08.270.1000.951 | 21;35;48;60 |
| 1861 585 005 | 08.270.1000.941 | 21;35;48 |
| 1861 591 035 | 08.270.1000.941 | 21;35;48 |
| 1861 591 036 | 08.270.1000.941 | 21;35;48 |
| 1861 591 037 | 08.270.1000.941 | 21;35;48 |
| 1861 591 038 | 08.270.1000.941 | 21;35;48 |
| 1861 592 332 | 08.270.1000.553 | 7;8;49;55 |
| 1861 592 333 | 08.270.1000.553 | 7;8;49;55 |
| 1861 599 132 | 08.270.1000.520 | 7;35;48 |
| 1861 599 232 | 08.270.1000.520 | 7;35;48 |
| 1861 639 001 | 08.270.1000.751 | 22;43;49 |
| 1861 639 004 | 08.270.1000.751 | 22;43;49 |
| 1861 639 006 | 08.270.1000.751 | 22;43;49 |
| 1861 639 031 | 08.270.1000.751 | 22;43;49 |
| 1861 639 032 | 08.270.1000.751 | 22;43;49 |
| 1861 639 035 | 08.270.1000.751 | 22;43;49 |
| 1861 639 107 | 08.270.1000.751 | 22;43;49 |

| SACHS | | |
|--------------|------------------------|-------------|
| 1861 639 148 | 08.270.1000.751 | 22;43;49 |
| 1861 640 031 | 08.270.1000.543 | 60 |
| 1861 640 135 | 08.270.1000.543 | 60 |
| 1861 641 031 | 08.270.1000.753 | 60 |
| 1861 641 135 | 08.270.1000.753 | 60 |
| 1861 641 236 | 08.270.1000.753 | 60 |
| 1861 669 001 | 08.270.1000.583 | 7;12;13;21 |
| 1861 669 002 | 08.270.1000.583 | 7;12;13;21 |
| 1861 669 003 | 08.270.1000.583 | 7;12;13;21 |
| 1861 699 104 | 08.270.1000.951 | 21;35;48;60 |
| 1861 699 131 | 08.270.1000.951 | 21;35;48;60 |
| 1861 699 135 | 08.270.1000.951 | 21;35;48;60 |
| 1861 699 136 | 08.270.1000.951 | 21;35;48;60 |
| 1861 699 137 | 08.270.1000.951 | 21;35;48;60 |
| 1861 699 138 | 08.270.1000.951 | 21;35;48;60 |
| 1861 714 131 | 08.270.1000.563 | 21;34;48 |
| 1861 714 132 | 08.270.1000.563 | 21;34;48 |
| 1861 714 133 | 08.270.1000.563 | 21;34;48 |
| 1861 787 031 | 08.270.1000.540 | 7;12;34;42 |
| 1861 787 034 | 08.270.1000.540 | 7;12;34;42 |
| 1861 861 032 | 08.270.1000.533 | 13;21 |
| 1861 862 233 | 08.270.1000.941 | 21;35;48 |
| 1861 863 201 | 08.270.1000.951 | 21;35;48;60 |
| 1861 863 232 | 08.270.1000.951 | 21;35;48;60 |
| 1861 911 203 | 08.270.1000.653 | 22 |
| 1861 911 231 | 08.270.1000.653 | 22 |
| 1861 911 232 | 08.270.1000.653 | 22 |
| 1861 911 303 | 08.270.1000.653 | 22 |
| 1861 912 032 | 08.270.1000.520 | 7;35;48 |
| 1861 912 034 | 08.270.1000.520 | 7;35;48 |
| 1861 912 035 | 08.270.1000.520 | 7;35;48 |
| 1861 919 034 | 08.270.1000.570 | 34 |
| 1861 919 035 | 08.270.1000.570 | 34 |
| 1861 919 134 | 08.270.1000.570 | 34 |
| 1861 919 139 | 08.270.1000.570 | 34 |
| 1861 923 003 | 08.270.1000.583 | 7;12;13;21 |
| 1861 923 103 | 08.270.1000.583 | 7;12;13;21 |
| 1861 933 031 | 08.270.1000.603 | 14 |
| 1861 933 032 | 08.270.1000.603 | 14 |
| 1861 942 033 | 08.270.1000.583 | 7;12;13;21 |
| 1861 961 131 | 08.270.1000.603 | 14 |

Vergleichsliste | Crosslist

aufsteigend nach Vergleichsnummer | ascending to Comp.-No.

| SACHS | | |
|--------------|------------------------|-------------------|
| 1861 961 133 | 08.270.1000.603 | 14 |
| 1861 961 135 | 08.270.1000.603 | 14 |
| 1861 962 031 | 08.270.1000.563 | 21;34;48 |
| 1861 962 033 | 08.270.1000.563 | 21;34;48 |
| 1861 986 139 | 08.270.1000.803 | 8 |
| 1861 986 140 | 08.270.1000.803 | 8 |
| 1861 988 032 | 08.270.1000.891 | 61 |
| 1861 988 033 | 08.270.1000.891 | 61 |
| 1861 988 037 | 08.270.1000.891 | 61 |
| 1861 988 040 | 08.270.1000.891 | 61 |
| 1861 998 131 | 08.270.1000.761 | 8;14 |
| 1861 998 131 | 08.320.1000.200 | 20;32;42 |
| 1861 998 133 | 08.270.1000.761 | 8;14 |
| 1861 998 135 | 08.270.1000.761 | 8;14 |
| 1862 108 031 | 08.270.1000.881 | 14;23;24;37;43;50 |
| 1862 108 034 | 08.270.1000.881 | 14;23;24;37;43;50 |
| 1862 109 034 | 08.270.1000.881 | 14;23;24;37;43;50 |
| 1862 135 031 | 08.270.1000.600 | 35 |
| 1862 135 033 | 08.270.1000.600 | 35 |
| 1862 135 035 | 08.270.1000.600 | 35 |
| 1862 138 031 | 08.270.1000.610 | 35 |
| 1862 138 032 | 08.270.1000.610 | 35 |
| 1862 138 033 | 08.270.1000.610 | 35 |
| 1862 147 032 | 08.270.1000.583 | 7;12;13;21 |
| 1862 152 031 | 08.270.1000.853 | 61 |
| 1862 153 031 | 08.270.1000.853 | 61 |
| 1862 157 034 | 08.270.1000.931 | 22 |
| 1862 157 037 | 08.270.1000.931 | 22 |
| 1862 176 033 | 08.270.3003.610 | 55 |
| 1862 176 034 | 08.270.3003.610 | 55 |
| 1862 177 001 | 08.270.3003.610 | 55 |
| 1862 188 032 | 08.270.1000.500 | 8;23;37 |
| 1862 189 031 | 08.270.1000.671 | 37 |
| 1862 189 032 | 08.270.1000.671 | 37 |
| 1862 190 105 | 08.270.1000.630 | 36;42;43 |
| 1862 190 106 | 08.270.1000.661 | 36;42 |
| 1862 190 131 | 08.270.1000.630 | 36;42;43 |
| 1862 190 132 | 08.270.1000.630 | 36;42;43 |
| 1862 190 133 | 08.270.1000.630 | 36;42;43 |
| 1862 190 136 | 08.270.1000.630 | 36;42;43 |
| 1862 190 139 | 08.270.1000.731 | 36 |

| SACHS | | |
|--------------|------------------------|-------------------|
| 1862 193 105 | 08.270.1000.661 | 36;42 |
| 1862 193 132 | 08.270.1000.661 | 36;42 |
| 1862 193 139 | 08.270.1000.821 | 22;36 |
| 1862 215 032 | 08.270.1000.500 | 8;23;37 |
| 1862 216 031 | 08.270.1000.671 | 37 |
| 1862 216 032 | 08.270.1000.671 | 37 |
| 1862 217 032 | 08.270.1000.881 | 14;23;24;37;43;50 |
| 1862 217 033 | 08.270.1000.881 | 14;23;24;37;43;50 |
| 1862 217 235 | 08.270.1000.881 | 14;23;24;37;43;50 |
| 1862 217 335 | 08.270.1000.881 | 14;23;24;37;43;50 |
| 1862 217 337 | 08.270.1000.881 | 14;23;24;37;43;50 |
| 1862 226 131 | 08.270.1000.831 | 22;23;36;37 |
| 1862 226 132 | 08.270.1000.791 | 23;37 |
| 1862 226 134 | 08.270.1000.791 | 23;37 |
| 1862 226 136 | 08.270.1000.791 | 23;37 |
| 1862 226 237 | 08.270.1000.791 | 23;37 |
| 1862 226 346 | 08.270.1000.831 | 22;23;36;37 |
| 1862 226 511 | 08.270.1000.831 | 22;23;36;37 |
| 1862 235 031 | 08.270.1000.533 | 13;21 |
| 1862 248 033 | 08.270.1000.843 | 60 |
| 1862 251 032 | 08.270.1000.903 | 22 |
| 1862 262 101 | 08.270.1000.761 | 8;14 |
| 1862 262 131 | 08.270.1000.761 | 8;14 |
| 1862 283 031 | 08.270.1000.620 | 35;55 |
| 1862 283 032 | 08.270.1000.620 | 35;55 |
| 1862 283 133 | 08.270.1000.620 | 35;55 |
| 1862 296 031 | 08.270.1000.520 | 7;35;48 |
| 1862 298 031 | 08.270.1000.793 | 50;62 |
| 1862 298 234 | 08.270.1000.793 | 50;62 |
| 1862 303 031 | 08.270.1000.912 | 49 |
| 1862 309 032 | 08.270.1000.781 | 12;48 |
| 1862 309 132 | 08.270.1000.781 | 12;48 |
| 1862 317 031 | 08.270.1000.901 | 13;14 |
| 1862 317 032 | 08.270.1000.911 | 13 |
| 1862 326 032 | 08.270.3003.600 | 55 |
| 1862 335 032 | 08.270.1000.741 | 61;62 |
| 1862 349 031 | 08.270.1000.921 | 61 |
| 1862 356 031 | 08.270.1000.583 | 7;12;13;21 |
| 1862 364 031 | 08.270.1000.931 | 22 |
| 1862 364 032 | 08.270.1000.903 | 22 |
| 1862 364 133 | 08.270.1000.903 | 22 |

aufsteigend nach Vergleichsnummer | ascending to Comp.-No.

| SACHS | | |
|--------------|------------------------|-------------|
| 1862 369 031 | 08.270.1000.791 | 23;37 |
| 1862 379 031 | 08.270.1000.841 | 49 |
| 1862 379 032 | 08.270.1000.912 | 49 |
| 1862 382 031 | 08.270.1000.513 | 61 |
| 1862 387 031 | 08.270.1000.903 | 22 |
| 1862 390 031 | 08.270.1000.503 | 13 |
| 1862 398 031 | 08.270.1000.781 | 12;48 |
| 1862 413 031 | 08.270.1000.763 | 61 |
| 1862 414 031 | 08.270.1000.773 | 61 |
| 1862 415 031 | 08.270.1000.833 | 60 |
| 1862 418 031 | 08.270.1000.831 | 22;23;36;37 |
| 1862 441 031 | 08.270.1000.851 | 23 |
| 1862 441 131 | 08.270.1000.851 | 23 |
| 1862 450 031 | 08.270.1000.861 | 55 |
| 1862 453 031 | 08.270.1000.981 | 37 |
| 1862 454 031 | 08.270.1000.663 | 55 |
| 1862 458 031 | 08.270.1000.603 | 14 |
| 1862 461 031 | 08.270.3003.600 | 55 |
| 1862 461 132 | 08.270.3003.600 | 55 |
| 1862 491 031 | 08.270.1000.573 | 21;48 |
| 1862 494 031 | 08.270.1000.831 | 22;23;36;37 |
| 1862 504 041 | 08.270.1000.791 | 23;37 |
| 1862 505 331 | 08.270.1000.593 | 49 |
| 1862 506 131 | 08.270.1000.771 | 22 |
| 1862 519 034 | 08.270.1000.640 | 37;38 |
| 1862 519 137 | 08.270.1000.620 | 35;55 |
| 1862 519 139 | 08.270.1000.640 | 37;38 |
| 1862 519 240 | 08.270.1000.640 | 37;38 |
| 1862 519 243 | 08.270.1000.500 | 8;23;37 |
| 1862 519 259 | 08.270.1000.500 | 8;23;37 |
| 1862 521 131 | 08.270.1000.761 | 8;14 |
| 1862 527 131 | 08.270.1000.793 | 50;62 |
| 1862 528 032 | 08.270.1000.711 | 7;21 |
| 1862 529 032 | 08.270.1000.971 | 38 |
| 1862 530 231 | 08.270.1000.741 | 61;62 |
| 1862 539 031 | 08.270.1000.643 | 22 |
| 1862 540 031 | 08.270.1000.821 | 22;36 |
| 1862 541 031 | 08.270.1000.711 | 7;21 |
| 1862 541 032 | 08.270.1000.711 | 7;21 |
| 1878 000 036 | 08.270.1000.673 | 7;13 |
| 1878 000 055 | 08.270.1000.831 | 22;23;36;37 |

| SACHS | | |
|--------------|------------------------|-------------------|
| 1878 000 104 | 08.270.1000.530 | 13;21;22;35;48;49 |
| 1878 000 105 | 08.270.1000.520 | 7;35;48 |
| 1878 000 116 | 08.270.1000.981 | 37 |
| 1878 000 117 | 08.270.1000.971 | 38 |
| 1878 000 296 | 08.270.1000.683 | 7 |
| 1878 000 299 | 08.270.1000.640 | 37;38 |
| 1878 000 611 | 08.270.1000.781 | 12;48 |
| 1878 000 623 | 08.270.1000.763 | 61 |
| 1878 000 625 | 08.270.1000.773 | 61 |
| 1878 000 634 | 08.270.1000.523 | 50;62 |
| 1878 000 650 | 08.270.1000.903 | 22 |
| 1878 000 948 | 08.270.1000.783 | 50;62 |
| 1878 000 957 | 08.270.1000.533 | 13;21 |
| 1878 000 964 | 08.270.1000.941 | 21;35;48 |
| 1878 000 968 | 08.270.1000.951 | 21;35;48;60 |
| 1878 001 030 | 08.270.1000.881 | 14;23;24;37;43;50 |
| 1878 001 070 | 08.270.1000.540 | 7;12;34;42 |
| 1878 001 074 | 08.270.1000.811 | 12;34 |
| 1878 001 080 | 08.270.1000.543 | 60 |
| 1878 001 082 | 08.270.1000.753 | 60 |
| 1878 001 138 | 08.270.1000.553 | 7;8;49;55 |
| 1878 001 144 | 08.270.1000.563 | 21;34;48 |
| 1878 001 145 | 08.270.1000.573 | 21;48 |
| 1878 001 152 | 08.270.1000.583 | 7;12;13;21 |
| 1878 002 023 | 08.270.1000.821 | 22;36 |
| 1878 002 024 | 08.270.1000.731 | 36 |
| 1878 002 263 | 08.270.1000.643 | 22 |
| 1878 002 437 | 08.270.1000.961 | 61 |
| 1878 002 442 | 08.270.1000.713 | 60;61 |
| 1878 002 458 | 08.270.1000.763 | 61 |
| 1878 002 460 | 08.270.1000.773 | 61 |
| 1878 002 643 | 08.270.1000.643 | 22 |
| 1878 002 729 | 08.270.1000.620 | 35;55 |
| 1878 002 730 | 08.270.1000.640 | 37;38 |
| 1878 002 730 | 08.270.1000.640 | 37;38 |
| 1878 002 732 | 08.270.1000.971 | 38 |
| 1878 002 733 | 08.270.1000.701 | 62 |
| 1878 002 735 | 08.270.1000.981 | 37 |
| 1878 002 791 | 08.270.1000.500 | 8;23;37 |
| 1878 003 031 | 08.270.1000.821 | 22;36 |
| 1878 003 065 | 08.270.1000.703 | 55 |

Vergleichsliste | Crosslist

aufsteigend nach Vergleichsnummer | ascending to Comp.-No.

| SACHS | | | SACHS | | |
|--------------|------------------------|-------------------|--------------|------------------------|-------------------|
| 1878 003 066 | 08.270.3003.600 | 55 | 1878 048 741 | 08.270.1000.691 | 34;35 |
| 1878 003 779 | 08.270.1000.513 | 61 | 1878 052 842 | 08.270.1000.691 | 34;35 |
| 1878 003 868 | 08.270.1000.823 | 50 | 1878 054 031 | 08.270.1000.701 | 62 |
| 1878 005 031 | 08.270.1000.731 | 36 | 1878 054 841 | 08.270.1000.811 | 12;34 |
| 1878 013 031 | 08.270.1000.663 | 55 | 1878 054 933 | 08.270.1000.721 | 7 |
| 1878 013 132 | 08.270.1000.663 | 55 | 1878 054 951 | 08.270.1000.761 | 8;14 |
| 1878 020 241 | 08.270.1000.593 | 49 | 1878 056 331 | 08.270.1000.731 | 36 |
| 1878 022 841 | 08.270.1000.613 | 23;49;50 | 1878 056 431 | 08.270.1000.821 | 22;36 |
| 1878 023 731 | 08.270.1000.881 | 14;23;24;37;43;50 | 1878 056 432 | 08.270.1000.821 | 22;36 |
| 1878 023 831 | 08.270.1000.991 | 35;36 | 1878 056 732 | 08.270.1000.703 | 55 |
| 1878 026 241 | 08.270.1000.623 | 49 | 1878 061 842 | 08.270.1000.593 | 49 |
| 1878 031 002 | 08.270.1000.831 | 22;23;36;37 | 1878 062 944 | 08.270.3003.610 | 55 |
| 1878 031 031 | 08.270.1000.791 | 23;37 | 1878 063 231 | 08.270.3003.600 | 55 |
| 1878 031 032 | 08.270.1000.831 | 22;23;36;37 | 1878 063 531 | 08.270.1000.693 | 7;21 |
| 1878 031 033 | 08.270.1000.791 | 23;37 | 1878 065 531 | 08.270.1000.500 | 8;23;37 |
| 1878 031 048 | 08.270.1000.831 | 22;23;36;37 | 1878 065 632 | 08.270.1000.791 | 23;37 |
| 1878 032 032 | 08.270.1000.503 | 13 | 1878 077 041 | 08.270.1000.781 | 12;48 |
| 1878 032 131 | 08.270.1000.961 | 61 | 1878 079 331 | 08.270.1000.693 | 7;21 |
| 1878 032 133 | 08.270.1000.961 | 61 | 1878 080 031 | 08.270.1000.831 | 22;23;36;37 |
| 1878 032 231 | 08.270.1000.713 | 60;61 | 1878 080 033 | 08.270.1000.791 | 23;37 |
| 1878 032 233 | 08.270.1000.713 | 60;61 | 1878 080 034 | 08.270.1000.633 | 8;23;37;43 |
| 1878 032 331 | 08.270.1000.793 | 50;62 | 1878 080 035 | 08.270.1000.881 | 14;23;24;37;43;50 |
| 1878 037 631 | 08.270.3003.600 | 55 | 1878 080 037 | 08.270.1000.500 | 8;23;37 |
| 1878 037 831 | 08.270.1000.831 | 22;23;36;37 | 1878 085 741 | 08.270.1000.603 | 14 |
| 1878 037 834 | 08.270.1000.881 | 14;23;24;37;43;50 | 1878 087 241 | 08.270.1000.853 | 61 |
| 1878 037 838 | 08.270.1000.881 | 14;23;24;37;43;50 | 1882 166 705 | 08.320.1000.220 | 31 |
| 1878 037 840 | 08.270.1000.791 | 23;37 | 1882 166 734 | 08.320.1000.220 | 31 |
| 1878 037 844 | 08.270.1000.633 | 8;23;37;43 | 1882 166 735 | 08.320.1000.220 | 31 |
| 1878 037 849 | 08.270.1000.791 | 23;37 | 1882 166 737 | 08.320.1000.220 | 31 |
| 1878 037 854 | 08.270.1000.831 | 22;23;36;37 | 1882 298 001 | 08.320.1000.622 | 12;20;32 |
| 1878 037 856 | 08.270.1000.791 | 23;37 | 1882 301 204 | 08.320.1000.200 | 20;32;42 |
| 1878 037 857 | 08.270.1000.633 | 8;23;37;43 | 1882 301 239 | 08.320.1000.200 | 20;32;42 |
| 1878 037 858 | 08.270.1000.500 | 8;23;37 | 1882 301 240 | 08.320.1000.622 | 12;20;32 |
| 1878 038 041 | 08.270.1000.813 | 23;43 | 1882 301 242 | 08.320.1000.622 | 12;20;32 |
| 1878 039 831 | 08.270.1000.633 | 8;23;37;43 | 1882 302 131 | 08.320.1000.802 | 31 |
| 1878 040 631 | 08.270.1000.721 | 7 | 1882 302 134 | 08.320.1000.802 | 31 |
| 1878 042 201 | 08.270.1000.630 | 36;42;43 | 1882 303 037 | 08.320.1000.622 | 12;20;32 |
| 1878 042 331 | 08.270.1000.821 | 22;36 | 1882 303 101 | 08.320.1000.622 | 12;20;32 |
| 1878 043 231 | 08.270.1000.663 | 55 | 1882 303 132 | 08.320.1000.622 | 12;20;32 |
| 1878 044 631 | 08.270.1000.711 | 7;21 | 1882 303 141 | 08.320.1000.200 | 20;32;42 |
| 1878 047 333 | 08.270.1000.693 | 7;21 | 1882 316 032 | 08.320.1000.200 | 20;32;42 |

aufsteigend nach Vergleichsnummer | ascending to Comp.-No.

| SACHS | | |
|--------------|------------------------|----------|
| 1882 330 031 | 08.320.1000.200 | 20;32;42 |
| 1882 330 033 | 08.320.1000.200 | 20;32;42 |
| 1882 331 033 | 08.320.1000.962 | 19;47;48 |
| 1882 342 132 | 08.320.1000.622 | 12;20;32 |
| 1897 917 615 | 08.290.7000.140 | 14;51 |
| 1898 180 391 | 08.270.1000.593 | 49 |
| 1898 180 395 | 08.270.1000.613 | 23;49;50 |
| 1898 917 135 | 08.270.1000.593 | 49 |
| 1898 917 153 | 08.270.1000.613 | 23;49;50 |
| 1898 917 207 | 08.270.1000.781 | 12;48 |
| 1898 917 329 | 08.270.1000.573 | 21;48 |
| 1961 848 032 | 08.270.1000.941 | 21;35;48 |
| 3100 000 003 | 08.290.7000.510 | 40;41 |
| 3100 002 112 | 08.290.7000.010 | 63;64 |
| 3100 002 114 | 08.290.7000.490 | 64 |
| 3100 002 118 | 08.290.7000.010 | 63;64 |
| 3100 002 119 | 08.290.7000.310 | 63 |
| 3100 002 218 | 08.290.7000.010 | 63;64 |
| 3100 002 219 | 08.290.7000.310 | 63 |
| 3100 002 220 | 08.290.7000.010 | 63;64 |
| 3100 002 247 | 08.290.7000.490 | 64 |
| 3100 002 254 | 08.290.7000.510 | 40;41 |
| 3100 002 255 | 08.290.7000.500 | 40 |
| 3100 002 256 | 08.290.7000.510 | 40;41 |
| 3100 002 353 | 08.290.7000.360 | 63 |
| 3100 002 449 | 08.290.7000.310 | 63 |
| 3100 002 459 | 08.290.7000.520 | 64 |
| 3100 002 460 | 08.290.7000.530 | 64 |
| 3100 002 464 | 08.290.7000.540 | 64 |
| 3100 002 549 | 08.290.7000.310 | 63 |
| 3100 003 001 | 08.290.7000.230 | 56 |
| 3100 007 001 | 08.290.7000.230 | 56 |
| 3100 007 103 | 08.290.7000.230 | 56 |
| 3100 007 203 | 08.290.7000.230 | 56 |
| 3100 008 001 | 08.290.7000.340 | 56 |
| 3100 008 101 | 08.290.7000.340 | 56 |
| 3100 008 201 | 08.290.7000.340 | 56 |
| 3100 026 431 | 08.290.7000.530 | 64 |
| 3100 026 432 | 08.290.7000.490 | 64 |
| 3100 026 433 | 08.290.7000.010 | 63;64 |
| 3100 026 434 | 08.290.7000.520 | 64 |

| SACHS | | |
|--------------|------------------------|---------------|
| 3100 026 531 | 08.290.7000.540 | 64 |
| 3151 000 034 | 08.290.7000.000 | 9;24;25 |
| 3151 000 144 | 08.290.7000.020 | 9;15;25;40;51 |
| 3151 000 151 | 08.290.7000.380 | 56 |
| 3151 000 154 | 08.290.7000.350 | 63 |
| 3151 000 219 | 08.290.7000.360 | 63 |
| 3151 000 375 | 08.290.7000.080 | 39;44 |
| 3151 000 392 | 08.290.7000.110 | 38;39 |
| 3151 000 404 | 08.290.7000.390 | 52 |
| 3151 007 303 | 08.290.7000.160 | 9;14;15;24;51 |
| 3151 015 101 | 08.290.7000.090 | 9;14;24;51;63 |
| 3151 015 301 | 08.290.7000.090 | 9;14;24;51;63 |
| 3151 015 332 | 08.290.7000.090 | 9;14;24;51;63 |
| 3151 023 101 | 08.290.7000.060 | 9;14;24;51 |
| 3151 027 131 | 08.290.7000.080 | 39;44 |
| 3151 028 001 | 08.290.7000.290 | 24;51 |
| 3151 033 031 | 08.290.7000.200 | 38 |
| 3151 043 032 | 08.290.7000.110 | 38;39 |
| 3151 044 031 | 08.290.7000.030 | 38;44 |
| 3151 057 001 | 08.290.7000.060 | 9;14;24;51 |
| 3151 057 002 | 08.290.7000.060 | 9;14;24;51 |
| 3151 058 001 | 08.290.7000.280 | 24 |
| 3151 066 002 | 08.290.7000.060 | 9;14;24;51 |
| 3151 066 032 | 08.290.7000.060 | 9;14;24;51 |
| 3151 067 001 | 08.290.7000.290 | 24;51 |
| 3151 067 002 | 08.290.7000.250 | 24;51 |
| 3151 067 031 | 08.290.7000.290 | 24;51 |
| 3151 067 032 | 08.290.7000.250 | 24;51 |
| 3151 068 101 | 08.290.7000.470 | 26 |
| 3151 087 041 | 08.290.7000.170 | 39 |
| 3151 095 043 | 08.290.7000.240 | 38 |
| 3151 101 031 | 08.290.7000.160 | 9;14;15;24;51 |
| 3151 105 041 | 08.290.7000.330 | 63 |
| 3151 105 141 | 08.290.7000.330 | 63 |
| 3151 108 031 | 08.290.7000.180 | 39;40 |
| 3151 110 031 | 08.290.7000.150 | 39 |
| 3151 112 031 | 08.290.7000.050 | 39 |
| 3151 118 031 | 08.290.7000.300 | 9;40 |
| 3151 126 031 | 08.290.7000.220 | 39 |
| 3151 153 001 | 08.290.7000.090 | 9;14;24;51;63 |
| 3151 153 002 | 08.290.7000.090 | 9;14;24;51;63 |

Vergleichsliste | Crosslist

aufsteigend nach Vergleichsnummer | ascending to Comp.-No.

| SACHS | | | SACHS | | |
|--------------|------------------------|---------------|--------------|------------------------|-------------------|
| 3151 157 001 | 08.290.7000.060 | 9;14;24;51 | 3151 263 031 | 08.290.7000.420 | 9;10;25 |
| 3151 157 002 | 08.290.7000.060 | 9;14;24;51 | 3151 272 631 | 08.290.7000.050 | 39 |
| 3151 157 102 | 08.290.7000.060 | 9;14;24;51 | 3151 273 431 | 08.290.7000.000 | 9;24;25 |
| 3151 164 434 | 08.290.7000.360 | 63 | 3151 274 101 | 08.290.7000.430 | 52 |
| 3151 164 534 | 08.290.7000.360 | 63 | 3151 274 131 | 08.290.7000.430 | 52 |
| 3151 166 031 | 08.290.7000.270 | 40 | 3151 274 831 | 08.290.7000.060 | 9;14;24;51 |
| 3151 167 101 | 08.290.7000.350 | 63 | 3151 276 931 | 08.290.7000.350 | 63 |
| 3151 167 232 | 08.290.7000.350 | 63 | 3151 278 131 | 08.290.7000.360 | 63 |
| 3151 167 432 | 08.290.7000.350 | 63 | 3151 602 001 | 08.290.7000.170 | 39 |
| 3151 169 031 | 08.290.7000.000 | 9;24;25 | 3151 602 002 | 08.290.7000.080 | 39;44 |
| 3151 169 131 | 08.290.7000.000 | 9;24;25 | 3151 602 003 | 08.290.7000.030 | 38;44 |
| 3151 169 232 | 08.290.7000.000 | 9;24;25 | 3151 602 004 | 08.290.7000.070 | 40 |
| 3151 169 332 | 08.290.7000.000 | 9;24;25 | 3151 602 005 | 08.290.7000.120 | 38 |
| 3151 170 131 | 08.290.7000.120 | 38 | 3151 824 002 | 08.290.7000.260 | 63 |
| 3151 177 031 | 08.290.7000.100 | 38 | 3151 824 003 | 08.290.7000.320 | 63 |
| 3151 182 031 | 08.290.7000.300 | 9;40 | 3180 000 001 | 08.290.7000.550 | 25;41;51;52;56;64 |
| 3151 182 102 | 08.290.7000.040 | 9 | 3180 000 009 | 08.290.7000.550 | 25;41;51;52;56;64 |
| 3151 182 103 | 08.290.7000.040 | 9 | 3180 002 102 | 08.290.7000.550 | 25;41;51;52;56;64 |
| 3151 182 203 | 08.290.7000.040 | 9 | 3180 002 103 | 08.290.7000.550 | 25;41;51;52;56;64 |
| 3151 182 233 | 08.290.7000.040 | 9 | 3400 040 032 | 08.340.1220.1 S | 57;58 |
| 3151 184 031 | 08.290.7000.130 | 40 | 3400 043 032 | 08.340.1101.1 S | 57 |
| 3151 184 032 | 08.290.7000.190 | 39 | 3400 047 031 | 08.340.1103.1 S | 11 |
| 3151 185 031 | 08.290.7000.070 | 40 | 3400 048 031 | 08.340.1119.1 S | 11 |
| 3151 199 001 | 08.290.7000.090 | 9;14;24;51;63 | 3400 067 031 | 08.340.1102.1 S | 11;45 |
| 3151 199 002 | 08.290.7000.090 | 9;14;24;51;63 | 3400 117 502 | 08.340.1221.1 S | 45 |
| 3151 203 031 | 08.290.7000.020 | 9;15;25;40;51 | 3400 117 532 | 08.340.1221.1 S | 45 |
| 3151 211 031 | 08.290.7000.050 | 39 | 3400 117 801 | 08.340.1119.1 S | 11 |
| 3151 220 031 | 08.290.7000.140 | 14;51 | 3400 117 802 | 08.340.1103.1 S | 11 |
| 3151 225 001 | 08.290.7000.020 | 9;15;25;40;51 | 3400 121 001 | 08.340.1104.1 S | 5 |
| 3151 225 031 | 08.290.7000.020 | 9;15;25;40;51 | 3400 121 002 | 08.340.1104.1 S | 5 |
| 3151 241 031 | 08.290.7000.130 | 40 | 3400 121 101 | 08.340.1151.1 S | 5 |
| 3151 241 032 | 08.290.7000.190 | 39 | 3400 121 201 | 08.340.1117.1 S | 27;28 |
| 3151 242 031 | 08.290.7000.070 | 40 | 3400 121 301 | 08.340.1116.1 S | 28 |
| 3151 245 031 | 08.290.7000.130 | 40 | 3400 121 401 | 08.340.1222.1 S | 27 |
| 3151 245 032 | 08.290.7000.190 | 39 | 3400 121 501 | 08.320.1000.722 | 32 |
| 3151 246 031 | 08.290.7000.070 | 40 | 3400 121 501 | 08.340.1105.1 S | 28 |
| 3151 248 031 | 08.290.7000.100 | 38 | 3400 121 601 | 08.340.1106.1 S | 28 |
| 3151 250 231 | 08.290.7000.400 | 52 | 3400 121 801 | 08.340.1270.1 S | 17;18 |
| 3151 250 302 | 08.290.7000.390 | 52 | 3400 121 901 | 08.340.1223.1 S | 17 |
| 3151 250 332 | 08.290.7000.390 | 52 | 3400 122 001 | 08.340.1107.1 S | 53;54 |
| 3151 262 031 | 08.290.7000.410 | 25 | 3400 122 101 | 08.340.1108.1 S | 5 |

aufsteigend nach Vergleichsnummer | ascending to Comp.-No.

| SACHS | | |
|--------------|------------------------|-------|
| 3400 122 201 | 08.340.1111.1 S | 17 |
| 3400 122 301 | 08.340.1109.1 S | 17 |
| 3400 122 501 | 08.340.1001.1 S | 29 |
| 3400 122 601 | 08.340.1001.1 S | 29 |
| 3400 122 701 | 08.340.1002.1 S | 28 |
| 3400 122 801 | 08.340.1206.1 S | 29 |
| 3400 122 901 | 08.340.1118.1 S | 30;31 |
| 3400 123 001 | 08.340.1004.1 S | 30 |
| 3400 123 401 | 08.340.1224.1 S | 45;46 |
| 3400 123 701 | 08.340.1153.1 S | 53 |
| 3400 123 801 | 08.340.1225.1 S | 53 |
| 3400 124 001 | 08.340.1005.1 S | 30 |
| 3400 124 101 | 08.340.1006.1 S | 29;30 |
| 3400 125 001 | 08.340.1207.1 S | 27 |
| 3400 125 101 | 08.340.1266.1 S | 27 |
| 3400 125 401 | 08.340.1111.1 S | 17 |
| 3400 125 601 | 08.340.1226.1 S | 57 |
| 3400 125 901 | 08.340.1208.1 S | 53 |
| 3400 127 101 | 08.340.1114.1 S | 58 |
| 3400 127 201 | 08.340.1209.1 S | 58 |
| 3400 127 401 | 08.340.1112.1 S | 18 |
| 3400 127 501 | 08.340.1111.1 S | 17 |
| 3400 127 701 | 08.340.1122.1 S | 27 |
| 3400 127 901 | 08.340.1227.1 S | 30 |
| 3400 128 001 | 08.340.1202.1 S | 31 |
| 3400 700 301 | 08.340.1228.1 S | 57 |
| 3400 700 302 | 08.340.1229.1 S | 17 |
| 3400 700 303 | 08.340.1240.1 S | 17 |
| 3400 700 304 | 08.340.1108.1 S | 5 |
| 3400 700 311 | 08.340.1241.1 S | 45 |
| 3400 700 312 | 08.340.1267.1 S | 11 |
| 3400 700 314 | 08.340.1115.1 S | 18 |
| 3400 700 330 | 08.340.1242.1 S | 45 |
| 3400 700 331 | 08.340.1243.1 S | 46;47 |
| 3400 700 332 | 08.340.1244.1 S | 47 |
| 3400 700 334 | 08.340.1245.1 S | 46 |
| 3400 700 340 | 08.340.1246.1 S | 45 |
| 3400 700 343 | 08.340.1152.1 S | 58 |
| 3400 700 344 | 08.340.1124.1 S | 16 |
| 3400 700 345 | 08.340.1125.1 S | 16 |
| 3400 700 401 | 08.340.1265.1 S | 47;58 |

| SACHS | | |
|--------------|------------------------|----------|
| 3400 700 402 | 08.340.1247.1 S | 18 |
| 3400 700 403 | 08.340.1113.1 S | 18 |
| 3400 700 404 | 08.340.1248.1 S | 18;19;42 |
| 3400 700 406 | 08.340.1150.1 S | 57 |
| 3400 700 408 | 08.340.1249.1 S | 46 |
| 3400 700 409 | 08.340.1260.1 S | 46 |
| 3400 700 410 | 08.340.1261.1 S | 46 |
| 3400 700 411 | 08.340.1203.1 S | 30 |
| 3400 700 413 | 08.340.1206.1 S | 29 |
| 3400 700 414 | 08.340.1262.1 S | 29 |
| 3400 700 415 | 08.340.1121.1 S | 28;29 |
| 3400 700 417 | 08.340.1263.1 S | 27 |
| 3400 700 422 | 08.340.1269.1 S | 57 |
| 3400 700 425 | 08.340.1204.1 S | 53 |
| 3400 700 428 | 08.340.1268.1 S | 5 |
| 3400 700 449 | 08.340.1102.1 S | 11;45 |
| 3400 700 455 | 08.340.1103.1 S | 11 |
| 3400 710 004 | 08.340.1123.1 S | 53 |
| 3421 601 001 | 08.150.1001.170 | 70 |
| 3421 601 002 | 08.150.1001.120 | 69 |
| 3421 601 003 | 08.150.1001.130 | 69;70 |
| 3421 601 004 | 08.150.1001.140 | 70 |
| 3421 601 006 | 08.150.1001.150 | 70 |
| 3421 601 007 | 08.150.1001.160 | 70 |
| 3421 601 008 | 08.150.1001.180 | 70 |
| 3421 601 009 | 08.150.1001.050 | 68 |
| 3421 601 010 | 08.150.1001.060 | 68 |
| 3421 601 011 | 08.150.1001.080 | 68;69 |
| 3421 601 012 | 08.150.1001.110 | 69 |
| 3421 601 013 | 08.150.0912.020 | 67;68 |
| 3421 601 013 | 08.150.1001.070 | 68 |
| 3421 601 014 | 08.150.0912.070 | 68 |
| 3421 601 016 | 08.150.1001.100 | 69 |
| 3421 601 017 | 08.150.1001.090 | 69 |
| 3421 601 018 | 08.150.3001.420 | 71 |
| 3421 601 019 | 08.150.3001.400 | 71 |
| 3421 601 020 | 08.150.3001.410 | 71 |
| 3421 601 022 | 08.150.0812.010 | 67 |
| 3421 601 023 | 08.150.4250.440 | 72 |
| 3421 601 024 | 08.150.3001.430 | 71 |
| 3421 601 047 | 08.150.0912.060 | 68 |

Vergleichsliste | Crosslist

aufsteigend nach Vergleichsnummer | ascending to Comp.-No.

| SACHS | | | SACHS | | |
|--------------|------------------------|-------|--------------|------------------------|----------|
| 3459 016 031 | 08.320.1000.320 | 59;60 | 3482 083 013 | 08.320.1000.270 | 26 |
| 3459 018 004 | 08.320.1000.310 | 59 | 3482 083 032 | 08.320.1000.792 | 11;12;19 |
| 3482 000 096 | 08.320.1000.822 | 19 | 3482 083 038 | 08.320.1000.792 | 11;12;19 |
| 3482 000 195 | 08.320.1000.842 | 19 | 3482 083 039 | 08.320.1000.712 | 54 |
| 3482 000 196 | 08.320.1000.822 | 19 | 3482 083 041 | 08.320.1000.702 | 5;6 |
| 3482 000 197 | 08.320.1000.862 | 20;32 | 3482 083 042 | 08.320.1000.992 | 60 |
| 3482 000 246 | 08.320.1000.842 | 19 | 3482 083 113 | 08.320.1000.270 | 26 |
| 3482 000 361 | 08.320.1000.822 | 19 | 3482 083 118 | 08.320.1000.250 | 16 |
| 3482 000 419 | 08.320.1000.340 | 6 | 3482 083 119 | 08.320.1000.792 | 11;12;19 |
| 3482 000 461 | 08.320.1000.280 | 20 | 3482 083 145 | 08.320.1000.270 | 26 |
| 3482 000 462 | 08.320.1000.290 | 33 | 3482 083 150 | 08.320.1000.772 | 54 |
| 3482 000 463 | 08.320.1000.852 | 31;32 | 3482 083 219 | 08.320.1000.792 | 11;12;19 |
| 3482 000 464 | 08.320.1000.862 | 20;32 | 3482 083 252 | 08.320.1000.922 | 47 |
| 3482 000 467 | 08.320.1000.672 | 19 | 3482 086 031 | 08.320.1000.210 | 32 |
| 3482 001 134 | 08.320.1000.762 | 54 | 3482 094 031 | 08.320.1000.752 | 11;47 |
| 3482 001 234 | 08.320.1000.762 | 54 | 3482 098 031 | 08.320.1000.682 | 6;54 |
| 3482 011 231 | 08.320.1000.300 | 6;33 | 3482 112 031 | 08.320.1000.662 | 54 |
| 3482 011 331 | 08.320.1000.300 | 6;33 | 3482 112 032 | 08.320.1000.662 | 54 |
| 3482 012 201 | 08.320.1000.602 | 12;31 | 3482 115 032 | 08.320.1000.672 | 19 |
| 3482 012 211 | 08.320.1000.602 | 12;31 | 3482 116 031 | 08.320.1000.340 | 6 |
| 3482 012 231 | 08.320.1000.602 | 12;31 | 3482 119 031 | 08.320.1000.682 | 6;54 |
| 3482 012 233 | 08.320.1000.632 | 31 | 3482 119 034 | 08.320.1000.762 | 54 |
| 3482 012 240 | 08.320.1000.632 | 31 | 3482 120 031 | 08.320.1000.360 | 20 |
| 3482 012 310 | 08.320.1000.632 | 31 | 3482 123 234 | 08.320.1000.992 | 60 |
| 3482 018 132 | 08.320.1000.682 | 6;54 | 3482 123 247 | 08.320.1000.922 | 47 |
| 3482 018 202 | 08.320.1000.682 | 6;54 | 3482 123 534 | 08.320.1000.842 | 19 |
| 3482 018 205 | 08.320.1000.682 | 6;54 | 3482 123 832 | 08.320.1000.862 | 20;32 |
| 3482 051 031 | 08.320.1000.742 | 31 | 3482 123 833 | 08.320.1000.852 | 31;32 |
| 3482 051 131 | 08.320.1000.742 | 31 | 3482 123 839 | 08.320.1000.972 | 6;12;54 |
| 3482 058 203 | 08.320.1000.712 | 54 | 3482 124 522 | 08.320.1000.622 | 12;20;32 |
| 3482 058 203 | 08.270.1000.721 | 7 | 3482 124 534 | 08.320.1000.350 | 20;33 |
| 3482 060 102 | 08.320.1000.652 | 5;19 | 3482 125 512 | 08.320.1000.260 | 26 |
| 3482 060 131 | 08.320.1000.652 | 5;19 | 3482 125 533 | 08.320.1000.280 | 20 |
| 3482 060 132 | 08.320.1000.652 | 5;19 | 3482 126 331 | 08.320.1000.290 | 33 |
| 3482 062 003 | 08.320.1000.210 | 32 | 3483 016 131 | 08.320.1000.642 | 59 |
| 3482 062 034 | 08.320.1000.270 | 26 | 3483 020 031 | 08.320.1000.642 | 59 |
| 3482 081 032 | 08.320.1000.210 | 32 | 3483 020 032 | 08.320.1000.642 | 59 |
| 3482 081 231 | 08.320.1000.210 | 32 | 3483 020 036 | 08.320.1000.872 | 54 |
| 3482 081 232 | 08.320.1000.210 | 32 | 3483 020 037 | 08.320.1000.732 | 59 |
| 3482 081 233 | 08.320.1000.612 | 32 | 3483 020 043 | 08.320.1000.642 | 59 |
| 3482 083 009 | 08.320.1000.712 | 54 | 3483 020 052 | 08.320.1000.642 | 59 |

aufsteigend nach Vergleichsnummer | ascending to Comp.-No.

| SACHS | | |
|--------------|------------------------|-------|
| 3483 022 031 | 08.320.1000.882 | 59 |
| 3483 022 032 | 08.320.1000.942 | 59 |
| 3483 022 133 | 08.320.1000.942 | 59 |
| 3483 026 231 | 08.290.7000.490 | 64 |
| 3483 026 331 | 08.290.7000.490 | 64 |
| 3483 030 031 | 08.320.1000.230 | 33 |
| 3483 030 032 | 08.320.1000.240 | 32;33 |
| 3483 034 032 | 08.320.1000.642 | 59 |
| 3483 034 033 | 08.320.1000.732 | 59 |
| 3483 034 034 | 08.320.1000.832 | 59 |
| 3483 034 035 | 08.320.1000.892 | 59 |
| 3488 017 032 | 08.320.1000.692 | 32 |
| 3488 017 333 | 08.320.1000.982 | 20 |
| 3488 017 402 | 08.320.1000.692 | 32 |
| 3488 017 432 | 08.320.1000.692 | 32 |
| 3488 017 436 | 08.320.1000.692 | 32 |
| 3488 017 439 | 08.320.1000.902 | 47 |
| 3488 017 446 | 08.320.1000.722 | 32 |
| 3488 017 447 | 08.320.1000.932 | 19;20 |
| 3488 017 448 | 08.320.1000.722 | 32 |
| 3488 018 031 | 08.340.1000.33S | 57 |
| 3488 022 233 | 08.320.1000.952 | 59 |
| 3488 022 253 | 08.320.1000.952 | 59 |
| 3488 023 031 | 08.320.1000.722 | 32 |
| 3488 023 032 | 08.320.1000.722 | 32 |

| SAURER | | |
|---------------|------------------------|---------------|
| 950.2641.030 | 08.320.1000.622 | 12;20;32 |
| 953.2614.001 | 08.290.7000.160 | 9;14;15;24;51 |
| 953.2628.030 | 08.270.1000.590 | 36;43;49 |

| SCANIA | | |
|---------------|------------------------|----|
| 1 102 425 | 08.320.1000.762 | 54 |
| 1 111 148 | 08.270.3003.600 | 55 |
| 1 113 870 | 08.320.1000.712 | 54 |
| 1 210 032 | 08.270.3003.600 | 55 |
| 1 304 781 | 08.270.3003.610 | 55 |
| 1 318 603 | 08.270.3003.610 | 55 |
| 1 321 253 | 08.270.3003.600 | 55 |
| 1 321 254 | 08.320.1000.712 | 54 |
| 1 321 258 | 08.270.3003.600 | 55 |

| SCANIA | | |
|---------------|------------------------|-------------------|
| 1 321 259 | 08.320.1000.712 | 54 |
| 1 321 260 | 08.290.7000.230 | 56 |
| 1 322 780 | 08.320.1000.872 | 54 |
| 1 324 883 | 08.270.3003.600 | 55 |
| 1 335 281 | 08.320.1000.662 | 54 |
| 1 335 282 | 08.270.1000.861 | 55 |
| 1 340 192 | 08.270.3003.600 | 55 |
| 1 341 687 | 08.320.1000.772 | 54 |
| 1 349 349 | 08.270.1000.663 | 55 |
| 1 355 282 | 08.270.1000.861 | 55 |
| 1 356 981 | 08.320.1000.662 | 54 |
| 1 361 679 | 08.320.1000.712 | 54 |
| 1 365 486 | 08.320.1000.712 | 54 |
| 1 367 172 | 08.270.3003.610 | 55 |
| 1 368 697 | 08.270.3003.600 | 55 |
| 1 370 793 | 08.320.1000.712 | 54 |
| 1 370 794 | 08.320.1000.712 | 54 |
| 1 382 331 | 08.320.1000.772 | 54 |
| 1 386 931 | 08.270.3003.600 | 55 |
| 1 387 021 | 08.270.3003.610 | 55 |
| 1 388 326 | 08.150.3001.400 | 71 |
| 1 390 374 | 08.270.1000.663 | 55 |
| 1 393 161 | 08.290.7000.340 | 56 |
| 1 393 163 | 08.290.7000.230 | 56 |
| 1 393 183 | 08.320.1000.872 | 54 |
| 1 393 187 | 08.290.7000.550 | 25;41;51;52;56;64 |
| 1 407 430 | 08.290.7000.340 | 56 |
| 1 409 769 | 08.270.3003.600 | 55 |
| 1 412 319 | 08.270.3003.600 | 55 |
| 1 413 177 | 08.270.1000.663 | 55 |
| 1 436 695 | 08.270.1000.703 | 55 |
| 1 444 110 | 08.270.3003.600 | 55 |
| 1 453 281 | 08.150.3001.400 | 71 |
| 1 465 410 | 08.160.3001.480 | 73 |
| 1 465 411 | 08.150.3001.400 | 71 |
| 1 479 576 | 08.290.7000.380 | 56 |
| 1 487 557 | 08.150.3001.400 | 71 |
| 1 487 567 | 08.160.3001.480 | 73 |
| 1 499 770 | 08.290.7000.380 | 56 |
| 1 510 032 | 08.270.3003.600 | 55 |
| 1 545 062 | 08.290.7000.340 | 56 |

Vergleichsliste | Crosslist

aufsteigend nach Vergleichsnummer | ascending to Comp.-No.

| SCANIA | | |
|-----------|------------------------|-------------------|
| 1 728 165 | 08.290.7000.380 | 56 |
| 1 749 123 | 08.270.3003.600 | 55 |
| 1 749 124 | 08.270.1000.703 | 55 |
| 1 749 125 | 08.290.7000.380 | 56 |
| 1 851 631 | 08.290.7000.380 | 56 |
| 170 069 | 08.160.3001.480 | 73 |
| 190 326 | 08.270.1000.553 | 7;8;49;55 |
| 234 682 | 08.320.1000.762 | 54 |
| 264 786 | 08.320.1000.762 | 54 |
| 294 884 | 08.320.1000.762 | 54 |
| 306 600 | 08.320.1000.762 | 54 |
| 306 993 | 08.150.3001.430 | 71 |
| 324 640 | 08.150.3001.410 | 71 |
| 324 642 | 08.150.3001.420 | 71 |
| 327 557 | 08.320.1000.762 | 54 |
| 329 439 | 08.320.1000.762 | 54 |
| 364 378 | 08.270.3003.610 | 55 |
| 369 849 | 08.270.3003.610 | 55 |
| 382 413 | 08.290.7000.230 | 56 |
| 382 499 | 08.320.1000.712 | 54 |
| 382 576 | 08.320.1000.712 | 54 |
| 388 060 | 08.290.7000.550 | 25;41;51;52;56;64 |
| 393 151 | 08.150.3001.430 | 71 |
| 394 884 | 08.320.1000.762 | 54 |
| 571 079 | 08.320.1000.762 | 54 |
| 571 208 | 08.320.1000.762 | 54 |
| 571 210 | 08.320.1000.762 | 54 |
| 571 214 | 08.320.1000.762 | 54 |
| 571 216 | 08.320.1000.762 | 54 |
| 571 217 | 08.320.1000.712 | 54 |
| 571 218 | 08.320.1000.712 | 54 |
| 571 219 | 08.320.1000.762 | 54 |
| 571 220 | 08.320.1000.712 | 54 |
| 571 221 | 08.320.1000.712 | 54 |
| 571 222 | 08.320.1000.662 | 54 |
| 571 223 | 08.270.1000.861 | 55 |
| 571 224 | 08.270.1000.663 | 55 |
| 571 226 | 08.320.1000.712 | 54 |
| 571 227 | 08.320.1000.712 | 54 |
| 571 254 | 08.270.3003.610 | 55 |
| 571 256 | 08.270.3003.600 | 55 |

| SCANIA | | |
|-----------|------------------------|-----------|
| 571 268 | 08.270.3003.600 | 55 |
| 571 270 | 08.270.1000.703 | 55 |
| 571 271 | 08.270.3003.600 | 55 |
| 571 282 | 08.270.3003.610 | 55 |
| 571 283 | 08.270.3003.600 | 55 |
| 571 284 | 08.270.3003.600 | 55 |
| 571 285 | 08.270.3003.610 | 55 |
| 571 288 | 08.270.3003.610 | 55 |
| 571 289 | 08.320.1000.772 | 54 |
| 571 290 | 08.270.3003.610 | 55 |
| 571 291 | 08.270.1000.663 | 55 |
| 571 292 | 08.270.3003.600 | 55 |
| 571 295 | 08.270.3003.600 | 55 |
| 571 296 | 08.270.1000.663 | 55 |
| 571 300 | 08.270.3003.600 | 55 |
| 571 305 | 08.270.3003.600 | 55 |
| 571 310 | 08.270.1000.703 | 55 |
| 6 490 375 | 08.270.1000.553 | 7;8;49;55 |

| SICCA | | |
|---------|------------------------|---------------|
| 5290558 | 08.290.7000.160 | 9;14;15;24;51 |
| 5290559 | 08.270.1000.681 | 13 |
| 5291168 | 08.290.7000.060 | 9;14;24;51 |
| 5292189 | 08.270.1000.681 | 13 |

| SISU | | |
|--------------|------------------------|-------------------|
| 130-210-4341 | 08.270.1000.721 | 7 |
| 130-210-4361 | 08.270.1000.881 | 14;23;24;37;43;50 |
| 130-210-4381 | 08.270.1000.881 | 14;23;24;37;43;50 |
| 130-510-0021 | 08.290.7000.000 | 9;24;25 |
| 130-510-0031 | 08.290.7000.420 | 9;10;25 |

| STEYR | | |
|----------------|------------------------|------------|
| 4S2614A | 08.290.7000.060 | 9;14;24;51 |
| 525426014A00 | 08.290.7000.060 | 9;14;24;51 |
| 61500160002 | 08.270.1000.583 | 7;12;13;21 |
| 815.60.16.0003 | 08.320.1000.622 | 12;20;32 |
| 815.60.16.0006 | 08.320.1000.622 | 12;20;32 |
| 853.03.05.0001 | 08.320.1000.622 | 12;20;32 |
| 853.03.05.9001 | 08.320.1000.622 | 12;20;32 |
| 892.00.16.0004 | 08.270.1000.583 | 7;12;13;21 |

aufsteigend nach Vergleichsnummer | ascending to Comp.-No.

| STEYR | | |
|----------------|------------------------|---------------|
| 892.00.16.0007 | 08.270.1000.583 | 7;12;13;21 |
| 990.00.21.0032 | 08.290.7000.060 | 9;14;24;51 |
| 990.00.21.0050 | 08.290.7000.060 | 9;14;24;51 |
| 990.12.21.0078 | 08.290.7000.280 | 24 |
| 991.14.16.0007 | 08.270.1000.951 | 21;35;48;60 |
| 991.14.16.0028 | 08.320.1000.270 | 26 |
| 991.14.16.0032 | 08.270.1000.951 | 21;35;48;60 |
| 991.14.16.0033 | 08.290.7000.020 | 9;15;25;40;51 |
| 991.14.16.0037 | 08.320.1000.270 | 26 |
| 991.14.16.0916 | 08.320.1000.270 | 26 |

| TAM | | |
|---------|------------------------|---------------|
| 2616014 | 08.290.7000.080 | 39;44 |
| 2617049 | 08.290.7000.220 | 39 |
| 2618559 | 08.290.7000.160 | 9;14;15;24;51 |
| 5052220 | 08.270.1000.811 | 12;34 |
| 5179629 | 08.270.1000.540 | 7;12;34;42 |
| 5196701 | 08.290.7000.470 | 26 |
| 5253497 | 08.270.1000.583 | 7;12;13;21 |
| 5304148 | 08.290.7000.160 | 9;14;15;24;51 |
| 5336236 | 08.270.1000.751 | 22;43;49 |
| 5483190 | 08.270.1000.751 | 22;43;49 |
| 5516382 | 08.270.1000.583 | 7;12;13;21 |
| 5597401 | 08.290.7000.060 | 9;14;24;51 |
| 5599230 | 08.290.7000.160 | 9;14;15;24;51 |
| 5601009 | 08.290.7000.090 | 9;14;24;51;63 |
| 5609004 | 08.270.1000.751 | 22;43;49 |
| 5615592 | 08.320.1000.270 | 26 |
| 5618023 | 08.290.7000.000 | 9;24;25 |
| 5637071 | 08.270.1000.751 | 22;43;49 |
| 5651445 | 08.320.1000.280 | 20 |
| 5654556 | 08.270.1000.771 | 22 |
| 5654557 | 08.320.1000.852 | 31;32 |

| TRUCKTEC AUTOMOTIVE | | |
|---------------------|------------------------|------------|
| 01.23.100 | 08.270.1000.560 | 34;42 |
| 01.23.104 | 08.270.1000.540 | 7;12;34;42 |
| 01.23.108 | 08.270.1000.610 | 35 |
| 01.23.114 | 08.270.1000.580 | 34 |
| 01.23.116 | 08.270.1000.801 | 34 |
| 01.23.118 | 08.270.1000.550 | 34;42 |

| TRUCKTEC AUTOMOTIVE | | |
|---------------------|------------------------|-------------|
| 01.23.119 | 08.270.1000.811 | 12;34 |
| 01.23.122 | 08.270.1000.520 | 7;35;48 |
| 01.23.124 | 08.270.1000.951 | 21;35;48;60 |
| 01.23.127 | 08.270.1000.590 | 36;43;49 |
| 01.23.130 | 08.270.1000.671 | 37 |
| 01.23.134 | 08.270.1000.583 | 7;12;13;21 |
| 01.23.138 | 08.270.1000.570 | 34 |

| VAN HOOL | | |
|-------------|------------------------|---------------|
| 10628942 | 08.290.7000.000 | 9;24;25 |
| 10642776 | 08.290.7000.560 | 25;41;44 |
| 10657411 | 08.270.1000.620 | 35;55 |
| 10664863 | 08.320.1000.682 | 6;54 |
| 10696404 | 08.270.1000.821 | 22;36 |
| 107 206 99 | 08.270.1000.643 | 22 |
| 10725736 | 08.270.1000.791 | 23;37 |
| 10737529 | 08.270.1000.831 | 22;23;36;37 |
| 10739529 | 08.270.1000.831 | 22;23;36;37 |
| 10876696 | 08.270.1000.813 | 23;43 |
| 109 458 03 | 08.290.7000.000 | 9;24;25 |
| 109 960 15 | 08.290.7000.000 | 9;24;25 |
| 469 5661 | 08.270.1000.533 | 13;21 |
| 518 312 | 08.320.1000.842 | 19 |
| 632 100 090 | 08.270.1000.681 | 13 |
| 632 100 110 | 08.270.1000.553 | 7;8;49;55 |
| 632 100 150 | 08.290.7000.160 | 9;14;15;24;51 |
| 632 100 210 | 08.270.1000.590 | 36;43;49 |
| 632 100 240 | 08.320.1000.200 | 20;32;42 |
| 632 100 260 | 08.290.7000.060 | 9;14;24;51 |
| 632 100 270 | 08.320.1000.962 | 19;47;48 |
| 632 100 340 | 08.320.1000.200 | 20;32;42 |
| 632 100 380 | 08.270.1000.951 | 21;35;48;60 |
| 632 100 390 | 08.290.7000.180 | 39;40 |
| 632 100 410 | 08.270.1000.681 | 13 |
| 632 100 450 | 08.290.7000.080 | 39;44 |
| 632 100 470 | 08.270.1000.653 | 22 |
| 632 100 480 | 08.290.7000.060 | 9;14;24;51 |
| 632 100 560 | 08.290.7000.060 | 9;14;24;51 |
| 632 100 570 | 08.290.7000.280 | 24 |
| 632 100 700 | 08.290.7000.090 | 9;14;24;51;63 |
| 632 101 110 | 08.270.1000.653 | 22 |

Vergleichsliste | Crosslist

aufsteigend nach Vergleichsnummer | ascending to Comp.-No.

| VAN HOOL | | |
|-------------|------------------------|---------------|
| 632 101 210 | 08.270.1000.653 | 22 |
| 632 101 220 | 08.270.1000.951 | 21;35;48;60 |
| 632 101 480 | 08.270.1000.583 | 7;12;13;21 |
| 632 101 600 | 08.270.1000.912 | 49 |
| 632 101 610 | 08.320.1000.982 | 20 |
| 632 101 620 | 08.290.7000.000 | 9;24;25 |
| 632 101 630 | 08.290.7000.060 | 9;14;24;51 |
| 632 101 660 | 08.270.1000.500 | 8;23;37 |
| 632 101 680 | 08.290.7000.560 | 25;41;44 |
| 632 101 770 | 08.320.1000.682 | 6;54 |
| 632 101 780 | 08.320.1000.682 | 6;54 |
| 700 113 365 | 08.290.7000.160 | 9;14;15;24;51 |
| 920 919 503 | 08.320.1000.250 | 16 |

| VOLVO | | |
|-----------|------------------------|-------------------|
| 0267 158 | 08.290.7000.330 | 63 |
| 0267 446 | 08.270.1000.951 | 21;35;48;60 |
| 0348 842 | 08.290.7000.330 | 63 |
| 0420 794 | 08.160.4004.510 | 73 |
| 0469 9030 | 08.150.0812.010 | 67 |
| 0479 2154 | 08.150.0812.010 | 67 |
| 1393 187 | 08.290.7000.550 | 25;41;51;52;56;64 |
| 1521 246 | 08.270.1000.921 | 61 |
| 1521 712 | 08.320.1000.832 | 59 |
| 1521 713 | 08.320.1000.892 | 59 |
| 1521 714 | 08.320.1000.952 | 59 |
| 1521 716 | 08.270.1000.793 | 50;62 |
| 1521 717 | 08.270.1000.961 | 61 |
| 1521 718 | 08.320.1000.992 | 60 |
| 1521 721 | 08.320.1000.732 | 59 |
| 1521 725 | 08.320.1000.310 | 59 |
| 1521 726 | 08.270.1000.713 | 60;61 |
| 1524 768 | 08.270.1000.741 | 61;62 |
| 1524 771 | 08.270.1000.701 | 62 |
| 1526 046 | 08.270.1000.753 | 60 |
| 1526 047 | 08.270.1000.543 | 60 |
| 1527 517 | 08.320.1000.642 | 59 |
| 1527 519 | 08.270.1000.891 | 61 |
| 1527 521 | 08.270.1000.891 | 61 |
| 1527 523 | 08.270.1000.753 | 60 |
| 1527 524 | 08.270.1000.543 | 60 |

| VOLVO | | |
|----------|------------------------|-------------|
| 1527 695 | 08.290.7000.330 | 63 |
| 1655 287 | 08.290.7000.320 | 63 |
| 1655 288 | 08.290.7000.260 | 63 |
| 1655 331 | 08.320.1000.642 | 59 |
| 1655 648 | 08.270.1000.753 | 60 |
| 1655 649 | 08.270.1000.543 | 60 |
| 1655 677 | 08.270.1000.891 | 61 |
| 1655 678 | 08.270.1000.891 | 61 |
| 1655 732 | 08.290.7000.010 | 63;64 |
| 1655 822 | 08.320.1000.642 | 59 |
| 1655 825 | 08.290.7000.010 | 63;64 |
| 1655 843 | 08.290.7000.490 | 64 |
| 1655 878 | 08.270.1000.853 | 61 |
| 1655 879 | 08.270.1000.853 | 61 |
| 1667 255 | 08.320.1000.642 | 59 |
| 1667 256 | 08.270.1000.891 | 61 |
| 1667 258 | 08.290.7000.010 | 63;64 |
| 1667 929 | 08.270.1000.951 | 21;35;48;60 |
| 1667 930 | 08.270.1000.753 | 60 |
| 1668 372 | 08.270.1000.753 | 60 |
| 1668 373 | 08.270.1000.543 | 60 |
| 1668 375 | 08.270.1000.843 | 60 |
| 1668 537 | 08.270.1000.701 | 62 |
| 1668 615 | 08.320.1000.642 | 59 |
| 1668 665 | 08.320.1000.882 | 59 |
| 1668 667 | 08.270.1000.921 | 61 |
| 1668 671 | 08.270.1000.741 | 61;62 |
| 1668 672 | 08.270.1000.701 | 62 |
| 1668 675 | 08.270.1000.843 | 60 |
| 1668 677 | 08.270.1000.853 | 61 |
| 1668 678 | 08.270.1000.853 | 61 |
| 1668 919 | 08.320.1000.992 | 60 |
| 1668 921 | 08.290.7000.490 | 64 |
| 1668 923 | 08.290.7000.010 | 63;64 |
| 1668 927 | 08.320.1000.942 | 59 |
| 1668 929 | 08.270.1000.513 | 61 |
| 1668 930 | 08.290.7000.310 | 63 |
| 1668 938 | 08.290.7000.310 | 63 |
| 1668 981 | 08.270.1000.853 | 61 |
| 1668 982 | 08.270.1000.853 | 61 |
| 1668 983 | 08.270.1000.701 | 62 |

aufsteigend nach Vergleichsnummer | ascending to Comp.-No.

| VOLVO | | |
|------------|------------------------|-------------------|
| 1669 116 | 08.320.1000.732 | 59 |
| 1669 134 | 08.320.1000.320 | 59;60 |
| 1669 135 | 08.340.1000.33S | 57 |
| 1669 138 | 08.270.1000.763 | 61 |
| 1669 139 | 08.270.1000.773 | 61 |
| 1669 141 | 08.270.1000.833 | 60 |
| 1669 142 | 08.270.1000.843 | 60 |
| 1669 287 | 08.320.1000.882 | 59 |
| 1669 370 | 08.320.1000.642 | 59 |
| 1669 657 | 08.340.1000.33S | 57 |
| 1669 821 | 08.340.1000.33S | 57 |
| 1669 827 | 08.320.1000.732 | 59 |
| 1669 828 | 08.320.1000.642 | 59 |
| 1669 829 | 08.320.1000.942 | 59 |
| 1669 830 | 08.320.1000.882 | 59 |
| 1669 832 | 08.290.7000.490 | 64 |
| 1669 833 | 08.290.7000.010 | 63;64 |
| 1669 834 | 08.290.7000.310 | 63 |
| 1672 930 | 08.320.1000.882 | 59 |
| 1672 931 | 08.320.1000.942 | 59 |
| 1672 934 | 08.320.1000.642 | 59 |
| 1672 935 | 08.320.1000.732 | 59 |
| 1672 942 | 08.340.1000.33S | 57 |
| 1672 944 | 08.290.7000.490 | 64 |
| 1672 945 | 08.290.7000.350 | 63 |
| 1672 946 | 08.290.7000.010 | 63;64 |
| 1672 948 | 08.290.7000.310 | 63 |
| 1672 950 | 08.290.7000.360 | 63 |
| 1673 220 | 08.290.7000.550 | 25;41;51;52;56;64 |
| 1673 859 | 08.270.1000.741 | 61;62 |
| 20 484 468 | 08.270.1000.823 | 50 |
| 20 504 343 | 08.270.1000.813 | 23;43 |
| 20 525 015 | 08.270.1000.783 | 50;62 |
| 20 566 389 | 08.270.1000.823 | 50 |
| 20 569 126 | 08.320.1000.732 | 59 |
| 20 569 128 | 08.320.1000.832 | 59 |
| 20 569 130 | 08.320.1000.892 | 59 |
| 20 569 151 | 08.290.7000.530 | 64 |
| 20 569 153 | 08.290.7000.520 | 64 |
| 20 569 155 | 08.290.7000.540 | 64 |
| 20 569 157 | 08.290.7000.490 | 64 |

| VOLVO | | |
|------------|------------------------|-------------------|
| 20 569 159 | 08.290.7000.350 | 63 |
| 20 571 923 | 08.320.1000.952 | 59 |
| 20 571 928 | 08.290.7000.010 | 63;64 |
| 20 571 945 | 08.290.7000.550 | 25;41;51;52;56;64 |
| 267 236 | 08.270.1000.753 | 60 |
| 267 237 | 08.270.1000.543 | 60 |
| 3191 766 | 08.270.1000.523 | 50;62 |
| 3191 767 | 08.270.1000.783 | 50;62 |
| 3191 991 | 08.270.1000.701 | 62 |
| 3192 200 | 08.320.1000.732 | 59 |
| 3192 201 | 08.320.1000.832 | 59 |
| 3192 202 | 08.320.1000.892 | 59 |
| 3192 203 | 08.320.1000.952 | 59 |
| 3192 208 | 08.340.1000.33S | 57 |
| 3192 209 | 08.290.7000.490 | 64 |
| 3192 210 | 08.320.1000.732 | 59 |
| 3192 211 | 08.320.1000.642 | 59 |
| 3192 212 | 08.320.1000.882 | 59 |
| 3192 213 | 08.320.1000.942 | 59 |
| 3192 216 | 08.290.7000.520 | 64 |
| 3192 218 | 08.290.7000.530 | 64 |
| 3192 219 | 08.290.7000.350 | 63 |
| 3192 220 | 08.290.7000.540 | 64 |
| 3192 222 | 08.290.7000.490 | 64 |
| 3192 223 | 08.290.7000.010 | 63;64 |
| 3192 224 | 08.290.7000.310 | 63 |
| 3192 226 | 08.290.7000.360 | 63 |
| 3192 845 | 08.270.1000.513 | 61 |
| 5002 241 | 08.270.1000.753 | 60 |
| 5002 242 | 08.270.1000.753 | 60 |
| 5002 243 | 08.270.1000.543 | 60 |
| 5100 006 | 08.270.1000.753 | 60 |
| 5100 007 | 08.270.1000.543 | 60 |
| 685611 | 08.290.7000.090 | 9;14;24;51;63 |
| 8112 106 | 08.270.1000.891 | 61 |
| 8112 107 | 08.270.1000.891 | 61 |
| 8112 108 | 08.270.1000.753 | 60 |
| 8112 109 | 08.270.1000.543 | 60 |
| 8112 124 | 08.270.1000.951 | 21;35;48;60 |
| 8112 125 | 08.270.1000.753 | 60 |
| 8112 127 | 08.270.1000.853 | 61 |

Vergleichsliste | Crosslist

aufsteigend nach Vergleichsnummer | ascending to Comp.-No.

| VOLVO | | |
|----------|------------------------|-------|
| 8112 128 | 08.270.1000.853 | 61 |
| 8112 138 | 08.290.7000.330 | 63 |
| 8112 139 | 08.290.7000.330 | 63 |
| 8112 149 | 08.270.1000.891 | 61 |
| 8112 159 | 08.270.1000.891 | 61 |
| 8112 159 | 08.290.7000.010 | 63;64 |
| 8112 160 | 08.340.1220.1 S | 57;58 |
| 8112 191 | 08.340.1101.1 S | 57 |
| 8112 194 | 08.270.1000.701 | 62 |
| 8112 222 | 08.270.1000.741 | 61;62 |
| 8112 340 | 08.270.1000.921 | 61 |
| 8112 598 | 08.320.1000.992 | 60 |
| 8112 600 | 08.270.1000.833 | 60 |
| 8112 601 | 08.270.1000.843 | 60 |
| 8112 604 | 08.270.1000.763 | 61 |
| 8112 605 | 08.270.1000.773 | 61 |
| 8112 662 | 08.270.1000.513 | 61 |
| 8112 924 | 08.270.1000.741 | 61;62 |
| 8113 054 | 08.270.1000.701 | 62 |
| 8113 225 | 08.270.1000.701 | 62 |
| 8113 257 | 08.270.1000.741 | 61;62 |
| 8113 463 | 08.320.1000.732 | 59 |
| 8113 467 | 08.270.1000.793 | 50;62 |
| 8113 468 | 08.270.1000.961 | 61 |
| 8113 512 | 08.320.1000.832 | 59 |
| 8113 513 | 08.320.1000.732 | 59 |
| 8113 514 | 08.320.1000.892 | 59 |
| 8113 515 | 08.320.1000.952 | 59 |
| 8113 525 | 08.270.1000.701 | 62 |
| 8113 529 | 08.320.1000.732 | 59 |
| 8113 547 | 08.340.1220.1 S | 57;58 |
| 8113 549 | 08.340.1101.1 S | 57 |
| 8113 551 | 08.340.1101.1 S | 57 |
| 8113 601 | 08.320.1000.942 | 59 |
| 8113 658 | 08.270.1000.713 | 60;61 |
| 8113 803 | 08.340.1228.1 S | 57 |
| 8113 811 | 08.340.1114.1 S | 58 |
| 8113 812 | 08.340.1101.1 S | 57 |
| 8113 813 | 08.340.1265.1 S | 47;58 |
| 8113 824 | 08.340.1209.1 S | 58 |
| 8113 825 | 08.340.1209.1 S | 58 |

| VOLVO | | |
|------------|------------------------|-------|
| 8113 946 | 08.320.1000.952 | 59 |
| 8113 947 | 08.270.1000.961 | 61 |
| 8113 993 | 08.270.1000.713 | 60;61 |
| 8171 426 | 08.270.1000.523 | 50;62 |
| 8171 494 | 08.320.1000.952 | 59 |
| 8171 496 | 08.270.1000.961 | 61 |
| 8171 497 | 08.270.1000.713 | 60;61 |
| 8172 354 | 08.270.1000.793 | 50;62 |
| 8172 402 | 08.270.1000.793 | 50;62 |
| 8172 403 | 08.270.1000.793 | 50;62 |
| 8172 801 | 08.270.1000.793 | 50;62 |
| 8172 802 | 08.270.1000.523 | 50;62 |
| 8172 803 | 08.270.1000.783 | 50;62 |
| 8193 939 | 08.160.4004.520 | 73 |
| 85 000 053 | 08.340.1101.1 S | 57 |
| 85 000 125 | 08.320.1000.992 | 60 |
| 85 000 185 | 08.340.1226.1 S | 57 |
| 85 000 235 | 08.320.1000.952 | 59 |
| 85 000 238 | 08.270.1000.783 | 50;62 |
| 85 000 239 | 08.270.1000.523 | 50;62 |
| 85 000 240 | 08.270.1000.783 | 50;62 |
| 85 000 241 | 08.270.1000.523 | 50;62 |
| 85 000 268 | 08.340.1152.1 S | 58 |
| 85 000 272 | 08.320.1000.832 | 59 |
| 85 000 277 | 08.270.1000.523 | 50;62 |
| 85 000 279 | 08.270.1000.783 | 50;62 |
| 85 000 311 | 08.340.1000.33S | 57 |
| 85 000 311 | 08.270.1000.763 | 61 |
| 85 000 313 | 08.340.1150.1 S | 57 |
| 85 000 521 | 08.320.1000.832 | 59 |
| 85 000 525 | 08.320.1000.892 | 59 |
| 85 000 542 | 08.340.1265.1 S | 47;58 |
| 85 001 033 | 08.270.1000.513 | 61 |
| 85 003 001 | 08.340.1150.1 S | 57 |

| VW | | |
|-------------|------------------------|----|
| 000 141 165 | 08.290.7000.100 | 38 |



Qualität fährt mit.
Quality in motion



www.st-templin.com

Qualität fährt mit.

Ersatzteile für: NKW, Anhänger, Omnibusse

Reparatursätze für: Achsbolzen, Achsstreben, Antriebswellen, Bremsbackenbolzen, Federbolzen, Servolenkung, Stabilisatoren etc.

Achsfangseile, Arbeitszylinder, Bremsbacken, Druckluftbehälter, Elektrowendel, Gestängesteller, Hemmschuhe, Kugelgelenke, Kühlerverschlüsse, Kupplungsköpfe, Luftfederbälge, Luftwendel, Schnellsteckverbinder, Spurstangen, Stecker und Steckdosen, Stoßdämpfer, Tankdeckel, Wellendichtringe

ST-Produkte durchlaufen ein erprobtes QS-System mit dem wir uns den entscheidenden Wettbewerbsvorteil auf der Basis eines Engineering für den after market sichern. Mehr als 3600 kundenbezogene Sonderteile nach Muster oder Zeichnung sprechen für unsere Kompetenz im Bereich CNC-Präzisionsdreh- und Frästeile. Alle Produkte aus eigener Fertigung werden auf modernsten CNC-Drehmaschinen gefertigt. Auch das Induktionshärten sowie unterschiedlichste Oberflächenbehandlungen gehören zum Leistungsumfang und garantieren den bekannt hohen ST-Qualitätsstandard.

Kurze Lieferzeit: Durch ein gut sortiertes Lager kann Siegfried Templin jeden Auftrag kurzfristig ausliefern. Täglicher Versand per Nachtexpress, DPD oder Spedition.



ST-Templin GmbH
Domänenweg 1
D-31863 Coppenbrügge
Germany
Fon: +49 5156 9610 - 0
Fax: +49 5156 9611-96
E-Mail: info@st-templin.com
Internet: www.st-templin.com

Templin CZ s.r.o
Korejska 14
Cz - 702 00 Ostrava - Privoz
Postfach 1180
Telefon: 59 - 6 13 45 27
Telefax: 59 - 6 13 40 06
E-Mail: templincz@mcnet.cz

Quality in motion

Spare parts for: utility vehicles, trailers, buses

Repair kits for: king pins, torque rods, axle shaft, brake shoe pins, spring pins, power steering, stabilisers a.s.o.

axle safety cables, air cylinders, brake shoes, air-reservoirs, electrical coils, slack adjusters, wheel chocks, ball joints, radiator caps, palm couplings, air springs, air coils, push-in connectors, tie rods, plugs and sockets, shock absorbers, filler caps, radial oil seals

ST-products pass through an approved QS-system that ensures our essential advantage in competition on the basis of engineering for the after market.

In the area CNC precision turned parts and milling parts we designed up to now more than 3600 special parts according to patterns or drawings submitted by our customers. The engineered products are manufactured using the most modern CNC lathes; induction hardening as well as various surface treatments are not a problem and guarantee the established ST-quality standard.

Short delivery time: Our well arranged stock makes it possible to deliver any request in short time. Daily shipping over night, with DHL or express company.

ST Templin UK Ltd.
Pike Low
Stubbins Lane
Chinley
High Peak
SK23 6EB
Fon: + 44 (1663) 75 12 79
Fax: + 44 (1663) 75 12 79
mobile: + 44 (7725) 08 47 04
E-Mail: david.mottershaw@st-templin.com
Internet: www.st-templin.com

20.040.KA60.000 (92009)