



Steering and suspension parts
Trucks

Edition 2006



Sidem NV · Kachtemsestraat 295 · B-8800 Roeselare · Belgium
tel (32) 51 - 22 73 31 · fax (32) 51 - 22 94 51
e-mail info@sidem.be - <http://www.sidem.be>

SIDEM



© Sidem nv 2006



Manufacturer of the parts : Sidem nv
Fabricant des pièces : Sidem sa
Hersteller der Teilen : Sidem nv
Producent van de onderdelen : Sidem nv

© Copyright by Sidem NV

Any reproduction of this catalogue is prohibited without previous written permission from Sidem. The preparation of this catalogue has had our best attention. However, we cannot accept any responsibility for errors which inadvertently may have been made.

Il est interdit de copier ce catalogue partiellement ou complètement sans l'autorisation préalable par écrit de Sidem. La préparation de ce catalogue a reçu notre meilleure attention. Toutefois, nous ne sommes pas responsable pour d'éventuelles fautes.

Es ist verboten jede Reproduktion dieses Kataloges ganz oder teilweise zu kopieren ohne vorhergehende schriftliche Zustimmung von Sidem. Alle Daten wurden sorgfältig erarbeitet. Eine Gewähr für die Richtigkeit kann jedoch nicht übernommen werden. Ersatzansprüche aufgrund von Angaben in diesem Katalog können nicht anerkannt werden.

Het is verboden elke reproductie van deze catalogus gedeeltelijk of volledig te kopiëren zonder voorafgaandelijke schriftelijke toestemming van Sidem. De voorbereiding heeft onze beste aandacht genoten. Wij zijn echter niet verantwoordelijk voor eventuele fouten.

The brand names of the cars and / or trucks, mentioned in this catalogue, do not indicate the origin of the parts, but are used only to indicate the destination of the parts. The numbers are for SIDEM's purposes only.

Les marques de véhicules et de / ou de poids lourds, mentionnées dans ce catalogue, n'indiquent pas l'origine des pièces détachées mais servent uniquement à indiquer leur destination. Les numéros sont de simples numéros de référence internes de SIDEM.

Die Marken der Pkw und / oder Lkw, erwähnt in diesen Katalog, weisen nicht hin auf die Ursprung der Teilen, aber dienen ausschließlich um die Bestimmung der Teilen anzudeuten. Die erwähnte Nummern sind nur interne Referenzen von SIDEM.

De in de catalogus vermelde auto- en / of vrachtwagenmerken wijzen niet op de oorsprong van de onderdelen doch dienen uitsluitend om hun bestemming aan te duiden. De vermelde nummers zijn louter interne referentienummers van SIDEM.

Edition - May 2006





KING PIN SETS - JEUX D'AXES DE FUSÉE - ACHSBOLZENZÄTZE

- | | | | | |
|---|--|--|---|--|
| <p>1. KING PIN
AXE DE FUSÉE
ACHSBOLZ</p> <p>2. BUSHING LOWER
BUSELURE INFÉRIEUR
BÜCHS UNTEN</p> <p>3. SEALING RING
JOINT
DICHRING</p> <p>4. SEALING RING
JOINT
DICHRING</p> <p>5. SLEEVE
BUSELURE SUPÉRIEUR
BÜCHS OBEN</p> <p>6. SHIM
ÉPAISSEUR
DISTRANZSCHEIBE</p> <p>7. BEARING
ROULEMENT
LAGER</p> | | | <p>9</p> <p>10</p> <p>8</p> <p>7</p> <p>6</p> <p>5</p> <p>4</p> <p>14</p> | <p>8. WASHER
RONDELLE
SCHEIBE</p> <p>9. PIN
GOUILLE
SPLINT</p> <p>10. NUT
ÉCROU
MUTTER</p> <p>11. SEALING CUP
PASTILLE
DICHTKAPPE</p> <p>12. CIRCLIPS
CIRCLIPS
SPRENGRING</p> <p>13. SEALING RING
JOINT
DICHRING</p> <p>14. LUBRICATOR
GRAISSEUR
SMIERNIPPEL</p> |
|---|--|--|---|--|

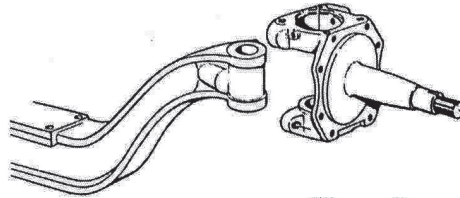

TRACK & LINK ROD - BARRE D'ACCOUPEMENT ET DE DIRECTION SPURSTANGENGELLENKE FÜR SPURSTANGE UND LENKSTANGE

- | | | |
|---|--|---|
| <p>1. TRACK ROD
BARRE D'ACCOUPEMENT
SPURSTANGE</p> <p>2. TIE ROD END FOR TRACK ROD
ROTULE DE BARRE D'ACCOUPEMENT
SPURSTANGENGELLENKE FÜR SPURSTANGE</p> | | <p>3. LINK ROD
BARRE DE DIRECTION
LENKSTANGE</p> <p>4. TIE ROD END FOR LINK ROD
ROTULE DE BARRE DE DIRECTION
SPURSTANGENGELLENKE FÜR LENKSTANGE</p> |
|---|--|---|



FRONT & REAR SPRING - RESSORT AVANT & ARRIÈRE - VORDER- & HINTERFEDER

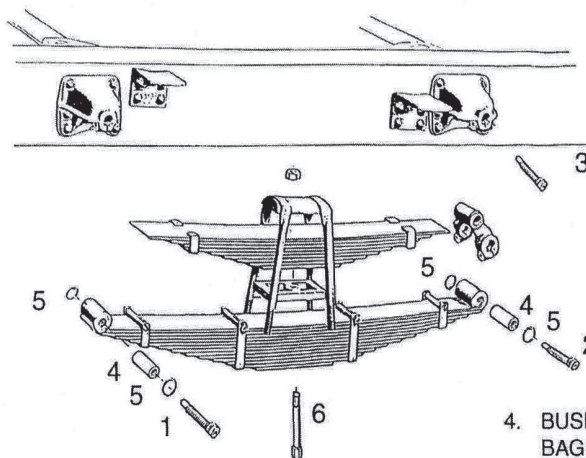

1. SPRING PIN FRONT
AXE DE RESSORT AVANT
FEDERACHSE VORDER
2. SPRING PIN REAR LOWER
AXE DE RESSORT ARRIÈRE INFÉRIEURE
FEDERACHSE HINTEN UNTEN
3. SPRING PIN REAR UPPER
AXE DE RESSORT ARRIÈRE SUPÉRIEURE
FEDERACHSE HINTEN OBEN
4. BUSH FOR DITO PINS
BAGUE POUR DITO AXES DE RESSORT
BÜCHSE FÜR DITO FEDERBOLZE
5. 'O'-RING FOR DITO PINS
O'-RING POUR DITO AXES DE RESSORT
O'-RING FÜR DITO FEDERBOLZE
6. SPRING CENTER BOLT
BOULON DE CENTRE
FEDERMITTELBOLZ

WHEEL PARTS - PIÈCES DE ROUE ARRIÈRE - RADTEILE

1. WHEEL BOLT
GOUJON DE ROUE
RADBOLZ
2. WHEEL NUT OUTER
ÉCROU DE ROUE EXTÉRIEUR
RADMUTTER
3. WHEEL NUT INNER
ÉCROU DE ROUE INTÉRIEUR
GEGENMUTTER
4. WASHER
RONDELLE
SCHEIBE
5. STUD DRIVE SHAFT
GOUJON D'ARBRE
STIFTSCHRAUBE
6. GUIDE FITTING
CONE
ZENTRIERRING
7. NUT
ÉCROU
MUTTER

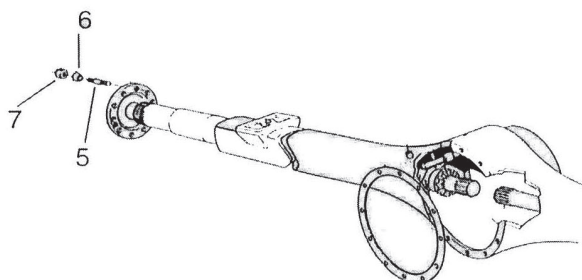
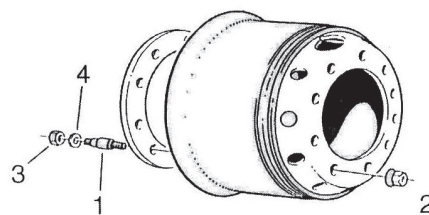



INDEX

DAF

IVECO

MAN

MERCEDES

RVI

SCANIA

VOLVO





	Symbols Remarks Abbreviations	Symboles Remarques Abbreviations	Symbole Aufmerkungen Abkürzungen
FA	Front axle pressure in tons	Poids sous essieu en tonnes	Vorderachsendruck in tonnen
VB	Vehicle width	Largeur de véhicule	Fahrzeugbreite
OE	Original equipment number	Numéro original	Vergleichsnummer
RHT	Right hand thread	Filet à droite	rechtsgewinde
LHT	Left hand thread	Filet à gauche	Linksgewinde
RHD	Right hand drive	Conduite à droite	Rechtslenkung
LHD	Left hand drive	Conduite à gauche	Linkslenkung
Exc.	Except	Exepté	ausgenommen
Inc.	Including	Inclus	Einschliesslich
-> CH xxx	Up to chassis nr xxx	Jusqu'au n° de chassis xxx	Bis fahrgestellnummer xxx
CH xxx ->	From chassis nr xxx	A partir du n° de chassis xxx	Ab fahrgestellnummer xxx
CH xxx - CH xxx	From / to chassis nr	A partir du / jusqu'au n° de chassis	Ab / Bis fahrgestellnummer xxx
English	Français	Deutsch	
Air suspension	Amortissement pneumatique	Luftfederung	
Application	Application	Anwendung	
Axle	Axe	Achse	
Bearing	Roulement	Kugellager	
Bogie pressure	Poids d'essieu en tandem	Doppelachslast	
Bolt	Boulon	Bolz	
Bushing	Buselure	Büchse	
Cone	Cône	Konus	
Double	Double	Doppel	
Fire crash tender	Véhicule de secours des pompiers	Katastropheneinsatzwagen	
Front	Avant	Vorn	
Grease nipple	Graisser	Schmiernippel	
Inner	Intérieur	Innen	
King pin	Axe de fusée	Achsbolz	
Leaf springs	Ressort à lames	Blattfederung	
Lower	Inférieur	Unten	
Nut	Écrou	Mutter	
O-ring	O-ring	O-ring	
Outer	Extérieur	Aussen	
Rear	Arrière	Hinten	
Retaining ring	Anneau de sûreté	Sicherungsring	
Screw	Boulon	Schraubenbolzen	
Sealing ring	Joint	Dichtring	
Shackle	Émerillon	Schäkel	
Shim	Epaisseur	Distanzscheibe	
Single	Simple	Einzel	
Soft	Souple	Weich	
Split pin	Goupille	Splint	
Spoked wheels	Roues à rayons	Speichenräder	
Spring bush	Bague de ressort	Federbüchse	
Spring pin	Axe de ressort	Federachse	
Steering gear	Mécanisme de direction	Lenkgetriebe	
Stiff	Rigide	Steif	
Thread	Filet	Gewinde	
Tie rod end	Rotule de direction	Kugelgelenk	
Ton (t)	Tonne	Tonne	
Type	Type	Typ	
Upper	Supérieur	Oben	
Vehicles	Véhicules	Fahrzeuge	
With	Avec	Mit	
Without	Sans	ohne	





INDEX

Page



Page

Seite

2-4	KING PIN SETS JEUX D'AXES DE FUSEE ACHSBOLZENZÄTZE
5-6	TRACK RODS BARRES DE DIRECTION SPURSTANGEN
7-12	LINK RODS BARRES D'ACCOUPLMENT LENKSCHUBSTANGEN
13-14	TIE ROD ENDS ROTULES DE DIRECTION KUGELGELENK
15-17	REPAIR KITS TORQUE ROD JEUX DE REPARATION DE BARRE DE REACTION REP.-SÄTZE FÜR REAKTIONSSTAG
18-20	SPRING PARTS PIECES DE RESSORT FEDERTEIL
21-23	STABILISER BEARINGS DOUILLES DE STABILISATEUR STABILISATORLAGER
24-25	WHEEL PARTS PIECES DE ROUE RADTEIL
26-27	CROSS REFERENCE GUIDE LISTE D'EQUIVALENCE VERGLEICHNUMMERNLISTE





SIDEM NR	DESCRIPTION			REMARKS
14288 KIT 14288 KIT SR	repair kit with bearing repair kit without bearing			Ø50/31.5 L = 274
	OE	PERIOD	AXLE	APPLICATION
	0118086	1974-> 1974-> 1974-> 1974-> 1974-> 1975-> 1975-> 1975-> 1975-> 1975->	N140 and N142 N140 and N142 N142 N140 and N142 N140 and N142 N142 N142 - 116126 N142 - 116126 N140 - 616739 N142	FA2800 - FAS2800 - FAT2800 - FT2800 FTT2800 - FAR2800 - FTS2800 N2800 FA2805 - FAS2805 - FAT2805 - FT2805 FTT2805 - FAR2805 - FAS2805 F-FAS-FAT-FM2000 - F-FAS-FAT-FM2005 F2100 - F2105 - F2200 - F2205 F2300 - F2305 MB200 F3300 - F3305
RELATED PART NUMBERS	OE	DESCRIPTION	DIMENSIONS	
14288 BM 14288 R	7.10.103.482 7.10.105.587	bush bi-metal bearing	large Ø= 53 mm small Ø= 50 mm H= 55 mm large Ø= 78 mm small Ø= 50 mm H= 22 mm	
SIDEM NR	DESCRIPTION			REMARKS
14289 KIT 14289 KIT SR	repair kit with bearing repair kit without bearing			Ø50/31.5 L = 269
	OE	PERIOD	AXLE	APPLICATION
	0681621	1980-> 1980-> 1980-> 1980-> 1981-> 1981-> 1981-> 1981-> 1981-> 1986->	N142 - 657044 N142 N142 N142 - 657043 N142 - 657047 N140 - 657047 N142 N142 - 657043 N140 - 657048	F1600 - F2100 - F2105 - F2300 - F2305 F2500 - F2505 - N2800 - F3300 - F3305 SB2300 - SB2305 - SB3000 F2800 - F2805 MBG MB200 MB230 MB200 SB201 - SB210 TB2100 - F3600 - N3300
RELATED PART NUMBERS	OE	DESCRIPTION	DIMENSIONS	
14289 R	0657061	needle bearing		
SIDEM NR	DESCRIPTION			REMARKS
14381 KIT 14381 KIT SR	repair kit with bearing repair kit without bearing			
	OE	PERIOD	AXLE	APPLICATION
	0683499	02.1998-12.2000 01.2001-> 02.1998-12.2000 01.2001-> 01.2001-> 01.2001-> 09.2002-> 02.1998-12.2000 01.1997-09.2002	N152 N152 N152	65 CF 65 CF II 75 CF CF 65 CF 75 CF 85 XF 95 85 CF 95 XF





KING PIN SETS

DAF

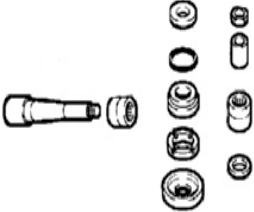
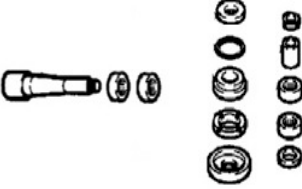
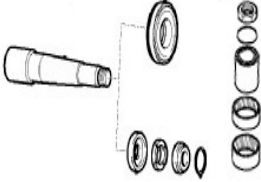
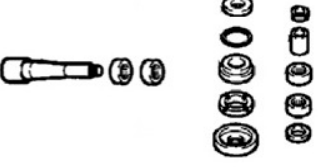
SIDEM NR	DESCRIPTION	REMARKS		
14382 KIT 14382 KIT SR	repair kit with bearing repair kit without bearing			
	OE	PERIOD	AXLE	APPLICATION
	0683392	02.1998-12.2000 02.1998-12.2000		75 CF 85 CF
SIDEM NR	DESCRIPTION	REMARKS		
14383 KIT 14383 KIT SR	repair kit with bearing repair kit without bearing			
	OE	PERIOD	AXLE	APPLICATION
	0683405	02.1998-12.2000 02.1998-12.2000		75 CF 85 CF
SIDEM NR	DESCRIPTION	REMARKS		
14384 KIT 14384 KIT SR	repair kit with bearing repair kit without bearing			
	OE	PERIOD	AXLE	APPLICATION
	0683470	01.2001-> 01.2001-> 09.2002->		CF 75 CF 85 XF 95
SIDEM NR	DESCRIPTION	REMARKS		
14385 KIT 14385 KIT SR	repair kit with bearing repair kit without bearing			
	OE	PERIOD	AXLE	APPLICATION
	0681702	02.1998-12.2000 02.1998-12.2000 01.1997-09.2002 01.1997-09.2002 09.1987-01.1998		75 CF 85 CF 95 XF 95 XF 530 F 95

© Sidem nv 2006

SIDEM





SIDEM NR	DESCRIPTION			REMARKS
14388 KIT 14388 KIT SR	repair kit with bearing repair kit without bearing			Ø50/31.5 L = 270 Ø50
	OE	PERIOD	AXLE	APPLICATION
	0681706	02.1998-12.2000		65 CF
		02.1998-12.2000		75 CF
		02.1998-12.2000		85 CF
		01.1997-09.2002		95 XF
		01.1997-09.2002		95 XF 530
		09.2002->		XF 95
RELATED PART NUMBERS	OE	DESCRIPTION	DIMENSIONS	
14389 R	0283687	needle bearing	large Ø= 58 mm small Ø= 50 mm H= 25 mm	

SIDEM NR	DESCRIPTION			REMARKS
14389 KIT 14389 KIT SR	repair kit with bearing repair kit without bearing			Ø45/31.5 L = 265
	OE	PERIOD	AXLE	APPLICATION
	0681511	02.1998-12.2000		85 CF
		09.1987-01.1998		F 95
RELATED PART NUMBERS	OE	DESCRIPTION	DIMENSIONS	
14389 R	0283687	needle bearing	large Ø= 58 mm small Ø= 50 mm H= 25 mm	





TRACK RODS

DAF

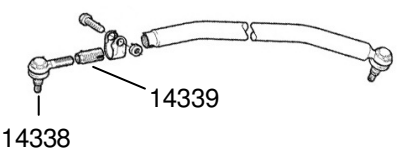
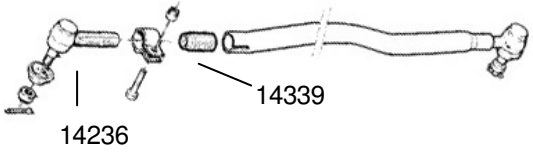
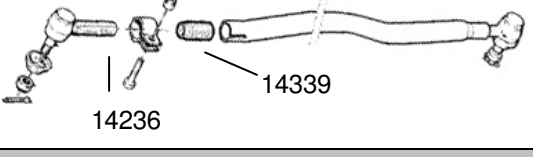
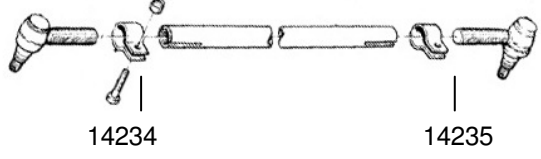
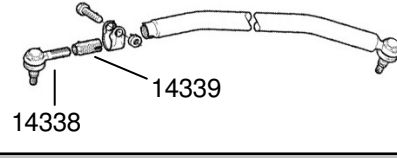
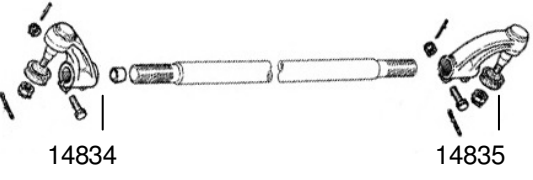
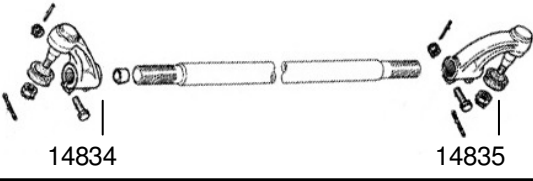
TYPES	Oe nr.	Dimensions	Drawing
SIDEM NR: 14330			
65CF/F65 <i>Bush: Sidem ref. 14339</i>	1353402 1290252	L= 1292 Ø= 52	
SIDEM NR: 14331			
75CF/85CF/95XF/95XF 530 F75/F85/F95 <i>Bush: Sidem ref. 14339</i>	1286341 0275961	L= 1655 Ø= 52	
SIDEM NR: 14332			
75CF/85CF/95XF/95XF 530 F75/F85/F95 <i>Bush: Sidem ref. 14339</i>	1286342 0275962	L= 1686 Ø= 52	
SIDEM NR: 14333			
65CF/75CF/85CF/95XF/95XF 530 F65/F75/F85/F95	1353391 1270853	L= 1698 Ø= 40	
SIDEM NR: 14334			
75CF/85CF/95XF/F75/F85/F95 <i>Bush: Sidem ref. 14339</i>	1353396 1286343	L= 1698 Ø= 52	
SIDEM NR: 14335			
65CF/75CF/85CF/95XF/95XF530/CF65/ CF75/CF85/XF95 F65/F75/F85/F95/FT95 500/LF55	0288280	L= 1700 Ø=	
SIDEM NR: 14336			
65CF/75CF/85CF/95XF/95XF530/CF65/ CF75/CF85/XF95 F65/F75/F85/F95/FT95 500/LF55	0288281	L= 1700 Ø=	







TYPES	Oe nr.	Dimensions	Drawing
SIDEM NR: 14337			
65CF/75CF/85CF/95XF/95XF530/F65/F75/F85/F95	1337644 1270854	L= 1734 Ø= 40	



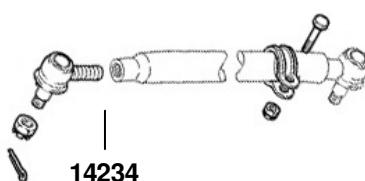
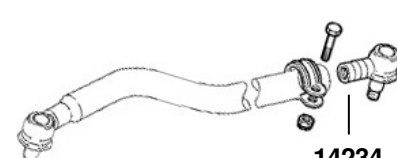

LINK RODS

DAF

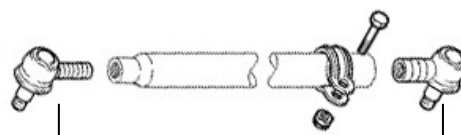
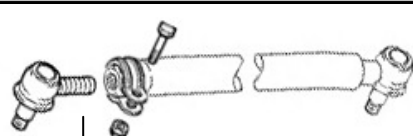
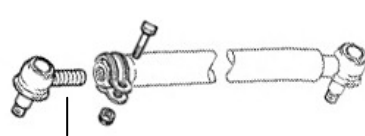
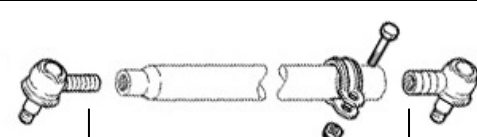
TYPES	Oe nr.	Dimensions	Drawing
SIDEM NR: 14135 85CF	1351741 1385487 1306333	L= 588 Ø= 38	 14234
SIDEM NR: 14434 75CF/85CF	1351730 1385488 1351745 0593883	L= 622 Ø= 42	 14234
SIDEM NR: 14638 75CF/85CF	1351729 1274356	L= 714 Ø= 36	
SIDEM NR: 14535 F2100/2300/2500 F95	0094016 0171215	L= 744 Ø= 40	 14537
SIDEM NR: 14438 75CF/85CF	1351732 1385490 1257992	L= 831 Ø= 36	 14234 14235
SIDEM NR: 14430 65CF/75CF/85CF	1351715 1385492 1283212 1247957	L= 848 Ø= 52	 14234
SIDEM NR: 14433 65CF/75CF/85CF/CF65/CF75	1602820 1448062 1363858	L= 855 Ø= 52	 14234
SIDEM NR: 14032 95XF	1351743 1321170 1385494	L= 860 Ø= 36	 14234 14235

SIDEM



© Sidem nv 2006

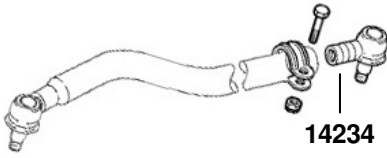
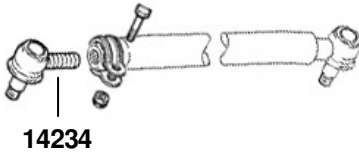
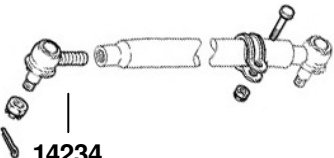
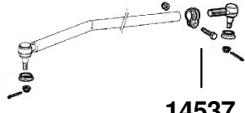
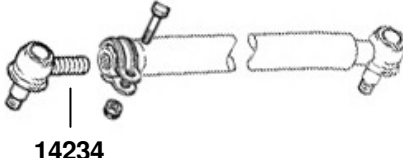
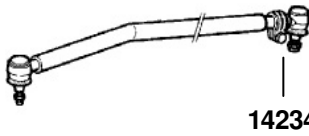
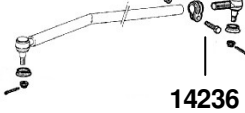
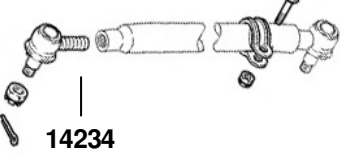

TYPES	Oe nr.	Dimensions	Drawing
SIDEM NR: 14436 75CF/85CF	1351718 1257991	L= 860 Ø= 36	
SIDEM NR: 14435 75CF/85CF	1351716 1385496 1277567	L= 865 Ø= 52	
SIDEM NR: 14639 75CF/85CF	1351717 1385495 1277568	L= 865 Ø= 52	
SIDEM NR: 14836 F2800/3300/3600	0094029 0117343	L= 872 Ø= 40	
SIDEM NR: 14431 65CF/75CF/85CF	1351714 1385497 1283211 1247956	L= 876 Ø= 52	
SIDEM NR: 14137 95XF	1283203	L= 985 Ø= 52	
SIDEM NR: 14738 F95/95XF	0094038 0525433	L= 995 Ø= 52	
SIDEM NR: 14138 95XF	1351735 1291048 1385500	L= 996 Ø= 62	





LINK RODS

DAF

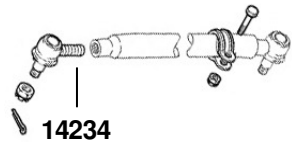
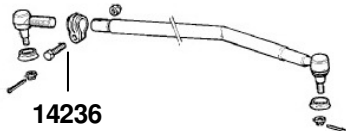
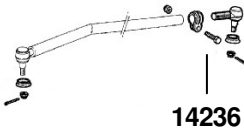
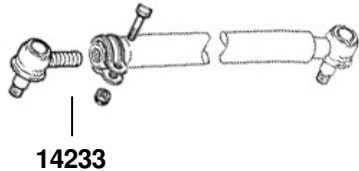
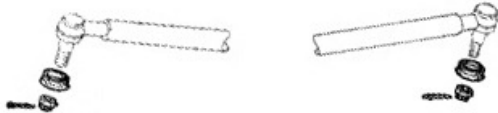
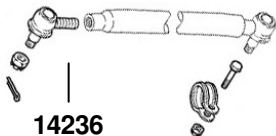
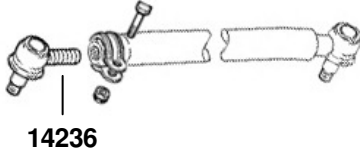
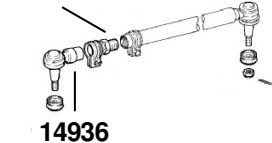



TYPES	Oe nr.	Dimensions	Drawing
SIDEM NR: 14136 95XF 530/95XF	1351737 1311048 1385498	L= 998 Ø= 36	
SIDEM NR: 14432 75CF/85CF/95XF/95XF-530/XF95	1351734 1291060 1385499	L= 1005 Ø= 52	
SIDEM NR: 14737 F95/95XF	0094613	L= 1008 Ø= 52	
SIDEM NR: 14134 85CF <i>bush: Sidem ref. 14837</i>	1385502 1351740 1306332	L= 1018 Ø= 40	
SIDEM NR: 14635 75CF/85CF	1351726 1274353	L= 1120 Ø= 36	
SIDEM NR: 14133 85CF	0224039	L= 1123 Ø= 42	
SIDEM NR: 14739	0094044	L= 1130 Ø= 40	
SIDEM NR: 14632 75CF/85CF/95XF <i>bush: Sidem ref. 14837</i>	1351723 1269973 1263037	L= 1328 Ø= 36	

SIDEM

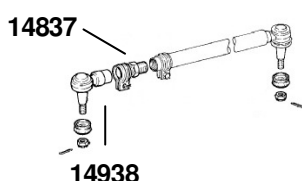
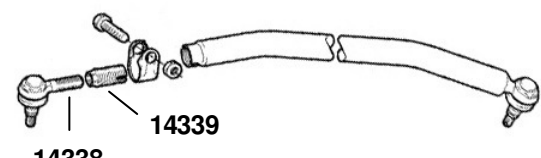
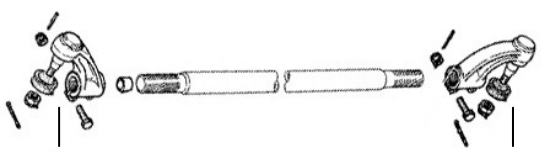
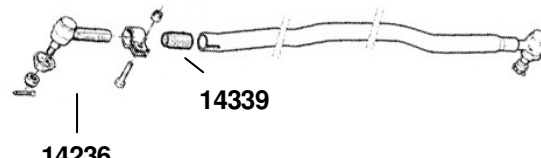

© Sidem nv 2006

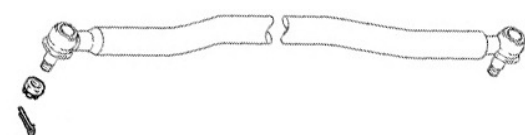



TYPES	Oe nr.	Dimensions	Drawing
SIDEM NR: 14633 75CF/85CF/95XF <i>bush: Sidem ref. 14837</i>	1385505 1351723 1274352	L= 1328 Ø= 36	
SIDEM NR: 14036 95XF/CF75 <i>bush: Sidem ref. 14339</i>	1361155 1297572	L= 1522 Ø= 52	
SIDEM NR: 14037 95XF	0275961	L= 1655 Ø= 52	
SIDEM NR: 14039 95XF <i>bush: Sidem ref. 14339</i>	1286341	L= 1655 Ø= 52	
SIDEM NR: 14437 75CF/85CF	1351731 1385506 1315530 1283071 1283070	L= 1658 Ø= 52	
SIDEM NR: 14636 75CF/85CF	1351727 1274354	L= 1670 Ø= 36	
SIDEM NR: 14130	1351722 1385509 1287409 1257994	L= 1673 Ø= 42	
SIDEM NR: 14439 75CF/85CF	1351721 1257993 1283072 1385508	L= 1673 Ø= 42	



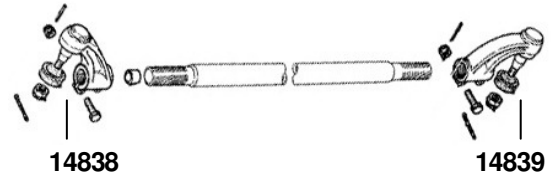
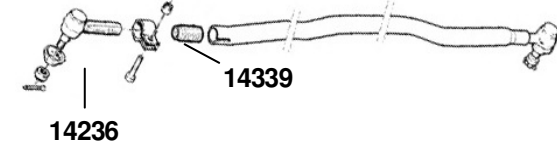
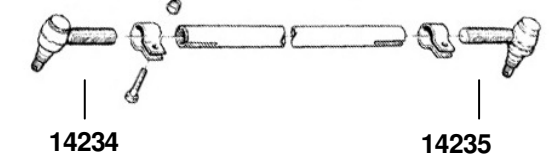
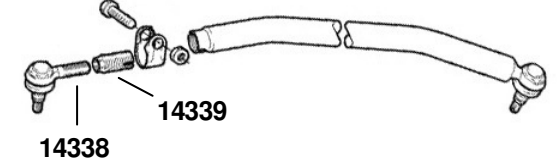

LINK RODS

DAF

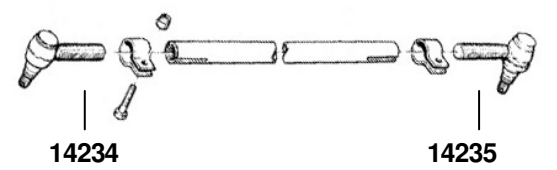
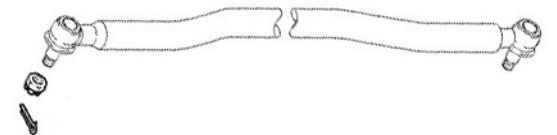
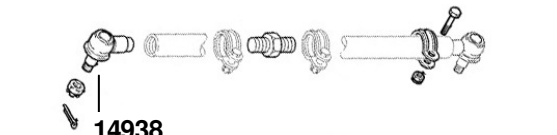
TYPES	Oe nr.	Dimensions	Drawing
SIDEM NR: 14038			
95XF	0275962 1286342	L= 1686 Ø= 52	
SIDEM NR: 14732			
95XF <i>bush: Sidem ref. 14339</i>	1286342	L= 1686 Ø= 52	
SIDEM NR: 14034			
65CF/CF75/95XF	1353391 1270853	L= 1698 Ø= 40	
SIDEM NR: 14033			
CF75 / 95XF <i>bush: Sidem ref. 14339</i>	1353396 1286343	L= 1698 Ø= 52	
SIDEM NR: 14637			
75CF/85CF	1351728 1274355	L= 1708 Ø= 36	
SIDEM NR: 14035			
CF75/CF65/CF65 II/95XF	1337644 1270854	L= 1734 Ø= 40	
SIDEM NR: 14031			
95XF	1385511 1311449 1351742	L= 1766 Ø= 52	
SIDEM NR: 14131			
75CF/85CF <i>bush: Sidem ref. 14837</i>	1351725 1385514	L= 1836 Ø= 36	

© Sidem nv 2006

SIDEM





TYPES	Oe nr.	Dimensions	Drawing
SIDEM NR: 14634			
75CF <i>bush: Sidem ref. 14837</i>	1357125 1263044	L= 1836 Ø= 36	
SIDEM NR: 14030			
95XF	1351739 1306336 1385516	L= 1955 Ø= 42	
SIDEM NR: 14139			
95XF	1351738 1306331 1385515	L= 1955 Ø= 42	





TIE ROD ENDS



DAF

type	Sidem	OE nr.	A	B	C
F1700/F1900/F2100/f2300/F2500/F2700 F95/TT2100	14237	1228115	120	65	M30x1,5 lht M
75CF/85CF/95XF	14233	1344684	115	50	M24x1,5 rht F
65CF/75CF/85CF/CF65/CF75 95XF/95XF-530/XF95 F65/F75/F85/F95	14234	1331925	115	55	M30x1,5 rht M
65CF/75CF/85CF/CF65/CF75 95XF/95XF-530/XF95 F65/F75/F85/F95	14235	1603419	115	55	M30x1,5 lht M
65CF/75CF/85CF/CF65/CF75 F95/95XF-530/XF95 F75/F85/F95	14236	1257890	120	65	M30x1,5 rht M
75CF/85CF/95XF/F75/F85/F95 65CF/F65/CF75	14338	1320855	141		M30x1,5 rht M
F2100/2300/2500 F2800/3300/3600	14537	1228110	135	70	M30x1,5 rht M
75CF/85CF/95XF	14938	1454167			
type	Sidem	OE nr.	A	B	C

F1700/F1900/F2100/f2300/F2500/F2700 TT2100	14830	0608122	130	7	M46x15 rht F
F1700/F1900/F2100/f2300/F2500/F2700 TT2100	14831	0608123	130	7	M46x15 lht F
F1700/F1900/F2100/f2300/F2500/F2700 F95/TT2100	14832	0606923	130	27	M46x15 rht F
F1700/F1900/F2100/f2300/F2500/F2700 F95/TT2100	14833	0606922	130	27	M46x15 lht F
65CF/75CF/85CF/95XF/95XF530/ CF65/CF75/CF85/XF95 F65/F75/F85/F95/FT95 500/LF55	14834	0067389	133	7	M48x1,5 rht F
65CF/75CF/85CF/95XF/95XF530/ CF65/CF75/CF85/XF95 F65/F75/F85/F95/FT95 500/LF55	14835	0067303	133	7	M48x1,5 lht F
95XF	14838	1235514	133		M52x1,5 rht F
95XF	14839	1235515	133		M52x1,5 lht F





type	Sidem	OE nr.	Length	Height	dimensions
	14930	1249129			M12x1,75 rht M
	14931	1249088			M12x1,75 lht M
	14939	0386930			M14x1,5 rht M





TORQUE ROD REPAIR KITS

DAF

TYPES	Oe nr.	Dimensions	Drawing
Repair kits for Torque rods			
SIDEM NR: 50246 Type: 75CF, 95XF, CF85, XF95	0693778		
SIDEM NR: 14243 Type: 75CF, 95XF, CF85, XF95	1271124	Ø72 x 130 x Ø19	
SIDEM NR: 14241 Type: 75CF, 85CF, CF75, CF85, 95XF, XF95	0689748	Ø75 x 115 x Ø17	
SIDEM NR: 14440	0067354	Ø75 x 130 x Ø19	
SIDEM NR: 14246	0689749	Ø85 x 130 x Ø19	

SIDEM



© Sidem nv 2006





TYPES	Oe nr.	Dimensions	Drawing
SIDEM NR: 14247			
Type: F95, 65CF, 75CF, 85CF, 95XF, 95XF 530, CF65, CF75, CF85, XF95	0691709	Ø85 x 130 x Ø21	
SIDEM NR: 14244			
Type: F2100, F2300, F2500, F2700, F2800, F2900, F3200, F3300, F3600	0691703	Ø85 x 152 x Ø21	
SIDEM NR: 14441			
Type: XF95	0696321	Ø95 x 152 x Ø23	
Repair kits for Torque rod balls			
SIDEM NR: 14443			
Type: 75CF, 85CF, 95XF, CF75, CF85, XF95 <i>Grease included</i>	0696320		
SIDEM NR: 14442			
Type: 65CF, 75CF, 85CF, 95XF, 95XF 530, CF85, F95 <i>Grease included</i>	1376730		





TORQUE ROD REPAIR KITS

DAF

TYPES	Oe nr.	Dimensions	Drawing
SIDEM NR: 14242 Type: F1900, F2100, F2300, F2500, F2800, F3300, N2800, 75CF, 85CF, 95XF	0691704	Ø37 x Ø72	
SIDEM NR: 14240 Type: F1700, F1900, F2100, F2300, F2700, F65, F75, F85, F95, 65CF, 75CF, 85CF, CF85, 95XF, 95XF 530	0069600	Ø60 x Ø70	





Type	OE nr	Dimensions	Drawing
Spring pins			
SIDEM NR: 14762			
F1200/1400/1600/2000/2005/2105/ 2200/2205/2300/2500/2505/2800 F95	0645231	Ø25 x 136mm	
SIDEM NR: 14760			
F1600/2100/2300/2500/2800	0645232 0501531	Ø25 x 136mm	
SIDEM NR: 14767			
F2500 F65/75/85/95 65CF/75CF/85CF/95XF 530/XF95	0389071	Ø26 x 136mm	
SIDEM NR: 14864			
F1700/1900/2100/2300/2500	0089781	Ø30 x 140mm	
SIDEM NR: 14865			
F1700/1900/2100/2300/2500	0763009	Ø30 x 152mm	
SIDEM NR: 14769			
F1700/1900/2100/2300/2500 F65/75/85/95 65CF/75CF/85CF/95XF 530/XF95	0299039	Ø32 x 158mm	
SIDEM NR: 14766			
F2100/2300/2500/2700/2800/2900	0643499	Ø35 x 160mm	
SIDEM NR: 14765			
F2800/3300/3600	0645233	Ø35 x 160mm	
SIDEM NR: 14761			
F2100/2300/2500/2800/3300/3600	0645234 0501576	Ø35 x 160mm	





SPRINGS

DAF



Type	OE nr	Dimensions	Drawing
Spring bushings			
SIDEM NR: 14371			
F1600/2100/2300/2500/2800 TB2100/2105 F95 - BUS	0645245 0637023	Ø25 x Ø32 x 80mm	
SIDEM NR: 14771			
F1700/1900/2100/2300/2500 F65/75/85/95 65CF/75CF/85CF/95XF/95XF 530/XF95	0679253	Ø26 x Ø31 x 53mm	
SIDEM NR: 14774			
F1700/1900/2100/2300/2500 F65/75/85/95 65CF/75CF/85CF/95XF/95XF 530/XF95	0679254	Ø31 x Ø39 x 76mm	
SIDEM NR: 14777			
65CF/75CF/85CF/95XF/CF75/CF85/XF95/ F95	0266412	Ø32 x 37 x 72,5	
SIDEM NR: 14772			
F1700/1900/2100/2300/2500 F95	0654870	Ø35 x Ø42 x 78mm	
SIDEM NR: 14374			
F2100/2300/2500/2800/3300/3600	0659666	Ø35 x Ø42 x 98mm	
SIDEM NR: 14778			
65CF/75CF/85CF/95XF/CF75/CF85/XF95/ F95	0266411	Ø37/45 x 49 x 95,7	
SIDEM NR: 14770			
F1700/1900/2100/2300/2500/2800/ 3300/3600	0649531	Ø42 x Ø52 x 98mm	

SIDEM



© Sidem nv 2006









Type	OE nr	Dimensions	Drawing
SIDEM NR: 14773			
F1700/1900/2100/2300/2500 F95 - BUS	0661283	Ø47 x Ø52 x 98mm	
Spring silent blocks			
SIDEM NR: 14367			
F1700/1900/2000/2005/2100/2105/ 2200/2205/2300/2305/2500/2505/2800/ 3300 F75/85/95 75CF/85CF/95XF/95XF 530 BUS 65CF/CF75/CF85/XF95	0654792	Ø34 x Ø50 x 144mm	





STABILISER BEARINGS

DAF







Type	OE nr	Dimensions	Drawing
SIDEM NR: 14162			
65CF/75CF/85CF/95XF 95XF 530 CF65/CF75/CF85/XF95 F95	1273279	16 x 51,5 x 50	
SIDEM NR: 14076			
65CF 95XF 530 F65/F75/F85/F95	0295726	20 x 55 x 50/55	
SIDEM NR: 14077			
65CF/75CF/85CF/95XF 95XF 530 CF65/CF65 II/CF75/CF85 XF95/F95	1283618	20 x 60 x 59,5	
SIDEM NR: 14069			
65CF F2100/F2300/F2500/F2700/F2800/ F2900/F3200/F3300/F3600 F75/F85/F95	0268043	25 x 35 / 44.5 x 23	
SIDEM NR: 14070			
F1600/F2100/F2105/F2300/F2305/ F2500/F2505/F2800/F3300/F3305/ F3600	0299108 0259526	25 x 45 / 56 x 49	
SIDEM NR: 14071			
F1100/F2300/F2500/F2700/F2800/ F2900/F3200/F3300/F3600	0371465	25 x 46 / 56 x 25	
SIDEM NR: 14072			
F2300/F2500/F2700/F2800/F2900/ F3200/F3300/F3600	0377171	30 x 55 / 66 x 27.5	
SIDEM NR: 14073			
65CF/75CF/85CF/95XF CF75/CF85/F95/XF95 F1600/F2100/F2105/F2300/F2305/ F2500/F2505/F2800/F3300/F3305/ F3600	0299106 0920825	30 x 55 / 69 x 60	

SIDEM



© Sidem nv 2006











Type	OE nr	Dimensions	Drawing
SIDEM NR: 14079			
65CF/75CF/85CF/95XF CF65/CF75/CF85/XF95 F95	1288000	39 x 69 x 60	
SIDEM NR: 14074			
65CF F1100/F1300/F1700/F1900/F2100/ F2300/F2500/F2700/F75/F85/F95	0274650	40 x 50 / 60 x 24	
SIDEM NR: 14062			
65CF F65/F95/F1200/F1400/F1600/F1700/ F1800/F1900/F2000/F2100/F2200/ F2300/F2500/F2700/F2800/F2900/ F3200/ F3300/ F3600 MB200-230/MBG N2800/N3300 SB23-27-30/SB201-10-20/SBR3000 TB210/DB250/TT2100 YAZ2300 Remark: A.V.M. 6-8-11 ltr eng.	0010761	40 x 59 / 69 x 79	
SIDEM NR: 14060			
<i>front</i> F1600/F2100/F2105/ F2300/F2305/F2800	0299109 0259525	40 x 60 / 70 x 82	
SIDEM NR: 14063			
F2100/F2300/F2500/F2700/F2800/ F2900/F3200/F3300/F3600	0293417	40 x 70 / 83 x 37	
SIDEM NR: 14064			
65CF F1700/F1900/F2100/F2300/F2500/ F2700 F65/F75/F85/F95 F95-500 HP	538329	40 x 75 / 85 x 60	
SIDEM NR: 14078			
75CF/85CF/95XF 95XF 530 CF75/CF85/XF95	1291233	43 x 60 / 60 x 69	

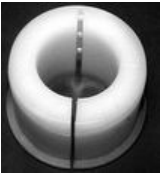

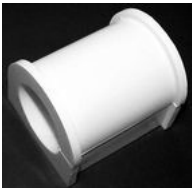

STABILISER BEARINGS

DAF

Type	OE nr	Dimensions	Drawing
SIDEM NR: 14065			
75CF/85CF/95XF 95XF 530 F2100/F2300/F2500/F2700/F75/F85/F95 F95-500 HP	0096109	45 x 75 / 85 x 60	
SIDEM NR: 14075			
95XF 530 F2100/F2300/F2500/F2700 F75/F85/F95	0274651	50 x 60 / 70 x 23.5	
SIDEM NR: 14061			
<i>rear</i> F1600/F2100/F2105/F2300/F2305/ F2500/F2505/F2800/F3300/F3305/ F3600	0299110 0259523	50 x 70 / 80 x 90	
SIDEM NR: 14067			
65CF/75CF/85CF/95XF CF75/CF85/F95/XF95 F1900/F2100/F2300/F2500/F2800/ F3300/F3600	0268045	50 x 71 / 84 x 75	
SIDEM NR: 14066			
75CF/85CF/95XF CF75/CF85/XF95 F75/F85/F95/F1700/F1900	0763523	50 x 75 / 86 x 60	
SIDEM NR: 14068			
85CF/95XF/XF95 F65/F75/F85/F95/F1700/F1900	0268044	55 x 71 / 84 x 75	
SIDEM NR: 14161			
65CF/CF65/XF95 F95	0558864	57 x 85 x 60,5	
SIDEM NR: 14160			
CF65 II XF95 95XF 530	0366351	65 x 84 x 60/50	

SIDEM



© Sidem nv 2006

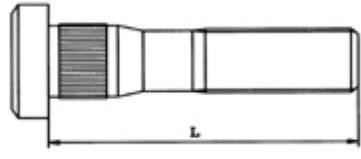
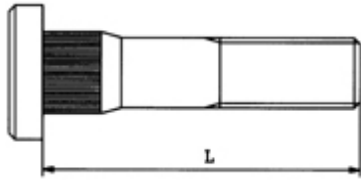
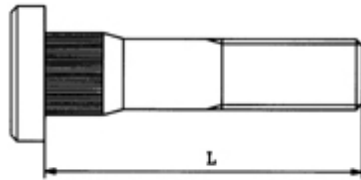

Type	OE nr	Dimensions	Drawing
Bolts			
SIDEM NR: 14410 (FRONT)			
65CF/75CF/85CF/95X/95XF 530 CF65/CF65 II/CF75/CF85 XF95/F95 F1600/1800/1900/2100/2200/2300/ 2500/2800/3300/3600 N2800/N3300 MGB/MB200/MB230 SB201/220/2000/2300/3000 TB2200	0099730 0620646 1309191	M22 x 1,5 L = 85	
SIDEM NR: 14413			
65CF / 75CF / 85CF CF75 / CF85 / F95	1356736 1309190 0890763	M22 x 1,5 L = 94	
SIDEM NR: 14411 (REAR)			
65CF/75CF/85CF/95 XF 95XF 530 CF65/CF65 II/CF75/CF85 XF95/F95 F1600/1800/1900/2100/2200/2300/ 2500/2800/3300/3600 N2800/N3300 MGB/MB200/MB230 SB201/220/2000/2300/3000 TB2200	1373007 1308038 0620649 0099717	M22 x 1,5 L = 104	
SIDEM NR: 14210 (FRONT)			
F1600 F1800 F2000/2005 F2100/2105/2200/2205 F2300/2305 F2800/MB200 SB2000	Year 1968-> 1980-> 1968-> 1975-> 1980-> 1975-> 1978->	0190203	M22 x 2 L = 76
SIDEM NR: 14313			
MB200 Remark: With hub 191.174 SB201 Remark: With hub 107.020 SB2000 Remark: With hub 199.174	Year 1975-> 1978-> 1978->	0260259	M22 x 2 L = 94
SIDEM NR: 14213 (FRONT)			
FM2000/2005 FAS2000/2005 F2200/2205 F2800/MB200	Year 1968-> 1968-> 1968-> 1975->	0217979	M22 x 2 L = 102,5
SIDEM NR: 14311			
F2200/2205 F2600/2605		0217266	M22 x 2 L = 118





WHEEL PARTS

DAF

Type		OE nr	Dimensions	Drawing
SIDEM NR: 14310				
Year				
F1600	1968->	0191175	M22 x 2 L = 120	
FAS2000/2005/2200/2205	1968->			
FAT2000/2005/2200/2205	1968->			
FAT&FAS 2800	1975->			
MB200	1975->			
FAS2300/2305	1980->			
FAT2300/2305	1980->			
FAV1800	1980->			
SIDEM NR: 14312				
F2200/2205		0259931	M22 x 2 L = 122	
F2300/2305				
F2800				
Nuts				
SIDEM NR: 14420	SIDEM ref.			
Fits to:	14410 14411	0652575	M22 x 1,5 H32 - sw32	
SIDEM NR: 14323	SIDEM ref.			
Fits to:	14213 14311	0325313	M22 x 2 H18 - sw32	
SIDEM NR: 14321	SIDEM ref.			
Fits to:	14310 14312	0191649	M22 x 2 H18 - sw38	
SIDEM NR: 14320	SIDEM ref.			
Fits to:	14210 14213 14310 14311 14312 14313	0144922	M22 x 2 H25 - sw32	
SIDEM NR: 14329	SIDEM ref.			
Conical ring	14210	0325235	Ø34 x Ø22,5 x 8mm	
Fits to:	14213			
	14310			
	14311			
	14312			
	14313			





OE nr	SIDEM nr	Page	OE nr	SIDEM nr	Page	OE nr	SIDEM nr	Page
#	14288 SAM	2	288254	14389 G	4	657063	14289 E	2
#	14289 SAM	2	0288256	14389 F	4	0659 666	14374	19
#	14388 A	4	0288280	14335	5	0661283	14773	20
#	14388 KIT	4	0288281	14336	5	0678962	14389 I	4
#	14388 KIT SR	4	0293417	14063	22	0678963	14389 J	4
#	14388 SAM	4	0295726	14076	21	0678964	14389 K	4
#	14388 SET SR	4	0299039	14769	18	0679253	14771	19
#	14389 KIT	4	0299106	14073	21	0679254	14774	19
#	14389 KIT SR	4	0299108	14070	21	0680374	14289 KIT	2
#	14389 SAM	4	0299109	14060	22	0680374	14289 KIT SR	2
#	14389 SET SR	4	0299110	14061	23	0680374	14289 SET	2
0010761	14062	22	0325235	14329	25	0680374	14289 SET SR	2
0067303	14835	13	0325313	14323	25	0681511	14389 SET	4
0067354	14440	15	0366351	14160	23	0681702	14385 KIT	3
0067389	14834	13	0371465	14071	21	0681706	14388 SET	4
0069 600	14240	17	0376039	14289 M	2	0683392	14382 KIT	3
0089781	14864	18	0377171	14072	21	0683405	14383 KIT	3
0094016	14535	7	0386930	14939	14	0683470	14384 KIT	3
0094029	14836	8	0389071	14767	18	0683499	14381 KIT	2
0094038	14738	8	0394508	14289 N	2	0689 749	14246	15
0094044	14739	9	0394807	14289 A	2	0689748	14241	15
0094613	14737	9	0394808	14289 P	2	0691 703	14244	16
0096109	14065	23	0394809	14289 O	2	0691 704	14242	17
0099717	14411	24	0501531	14760	18	0691 709	14247	16
0099730	14410	24	0525433	14738	8	0693778	50246	15
0117343	14836	8	0538329	14064	22	0696320	14443	16
0144922	14320	25	0556110	14388 F	4	0696321	14441	16
0171215	14535	7	0558864	14161	23	0763009	14865	18
0190203	14210	24	0593883	14434	7	0763523	14066	23
0191175	14310	25	0606922	14833	13	0890763	14413	24
0191649	14321	25	0606923	14832	13	0920825	14073	21
0217266	14311	24	0608122	14830	13	103 820	14288 A	2
0217979	14213	24	0608123	14831	13	118.086	14288 KIT	2
0224039	14133	9	0620 649	14411	24	118.086	14288 KIT SR	2
0259523	14061	23	0620646	14410	24	118.086	14288 SET SR	2
0259525	14060	22	0628938	14289 J	2	118.086	14288 SET	2
0259526	14070	21	0637023	14371	19	1228 115	14237	13
0259931	14312	25	0643499	14766	18	1228110	14537	13
0260259	14313	24	0645 231	14761	18	1235514	14838	13
0266411	14778	19	0645231	14762	18	1235515	14839	13
0266412	14777	19	0645232	14760	18	1247956	14431	8
0268043	14069	21	0645233	14765	18	1247957	14430	7
0268044	14068	23	0645245	14371	19	1249 088	14931	14
0268045	14067	23	0649531	14770	19	1249129	14930	14
0274650	14074	22	0652 575	14420	25	1257 890	14236	13
0274651	14075	23	0654792	14367	20	1257991	14436	8
0275961	14331	5	0654870	14772	19	1257992	14438	7
0275961	14037	10	0657051	14289 BS	2	1257993	14439	10
0275962	14332	5	0657052	14289 F	2	1257994	14130	10
0275962	14038	11	0657053	14289 H	2	1263037	14632	9
0283687	14389 R	4	0657054	14289 G	2	1263044	14634	12
0285667	14389 D	4	0657056	14289 I	2	1269973	14632	9
0286578	14389 A	4	0657057	14289 K	2	1270853	14333	5
0286579	14389 BS	4	0657061	14289 R	2	1270853	14034	11
0286580	14389 E	4	0657062	14289 D	2	1270854	14337	6





CROSS REFERENCE GUIDE

DAF

OE nr	SIDEM nr	Page	OE nr	SIDEM nr	Page	OE nr	SIDEM nr	Page
1270854	14035	11	1351725	14131	11	7.10.105.699	14288 F	2
1271 124	14243	15	1351726	14635	9			
1273279	14162	21	1351727	14636	10			
1274352	14633	10	1351728	14637	11			
1274353	14635	9	1351729	14638	7			
1274354	14636	10	1351730	14434	7			
1274355	14637	11	1351731	14437	10			
1274356	14638	7	1351732	14438	7			
1277567	14435	8	1351734	14432	9			
1283070	14437	10	1351735	14138	8			
1283071	14437	10	1351737	14136	9			
1283072	14439	10	1351739	14030	12			
1283203	14137	8	1351740	14134	9			
1283211	14431	8	1351741	14135	7			
1283212	14430	7	1351742	14031	11			
1283618	14077	21	1351743	14032	7			
1286341	14039	10	1351745	14434	7			
1286341	14331	5	1353391	14333	5			
1286342	14332	5	1353391	14034	11			
1286342	14038	11	1353396	14334	5			
1286342	14732	11	1353396	14033	11			
1286343	14334	5	1353402	14330	5			
1286343	14033	11	1356736	14413	24			
1287409	14130	10	1357125	14634	12			
1288000	14079	22	1361155	14036	10			
1290252	14330	5	1363858	14433	7			
1291048	14138	8	1373007	14411	24			
1291060	14432	9	1376730	14442	16			
1291233	14078	22	1385487	14135	7			
1297572	14036	10	1385488	14434	7			
1306332	14134	9	1385490	14438	7			
1306333	14135	7	1385492	14430	7			
1306336	14030	12	1385494	14032	7			
1308 038	14411	24	1385496	14435	8			
1309 191	14410	24	1385497	14431	8			
1309190	14413	24	1385498	14136	9			
1311048	14136	9	1385499	14432	9			
1311449	14031	11	1385500	14138	8			
1315530	14437	10	1385502	14134	9			
1320855	14338	13	1385505	14439	10			
1321170	14032	7	1385505	14633	10			
1331925	14234	13	1385506	14437	10			
1337644	14337	6	1385509	14130	10			
1337644	14035	11	1385511	14031	11			
1344684	14233	13	1385514	14131	11			
1344685	14837	9,10,11 ,12	1385516	14030	12			
			1394801	14339	5,10,11			
1351714	14431	8	1448062	14433	7			
1351715	14430	7	1454167	14938	13			
1351716	14435	8	1602820	14433	7			
1351718	14436	8	1603419	14235	13			
1351721	14439	10	501.576	14761	18			
1351722	14130	10	7.10.103.482	14288 BM	2			
1351723	14632	9	7.10.105.587	14288 R	2			
1351723	14633	10	7.10.105.698	14288 E	2			

SIDEM



© Sidem nv 2006

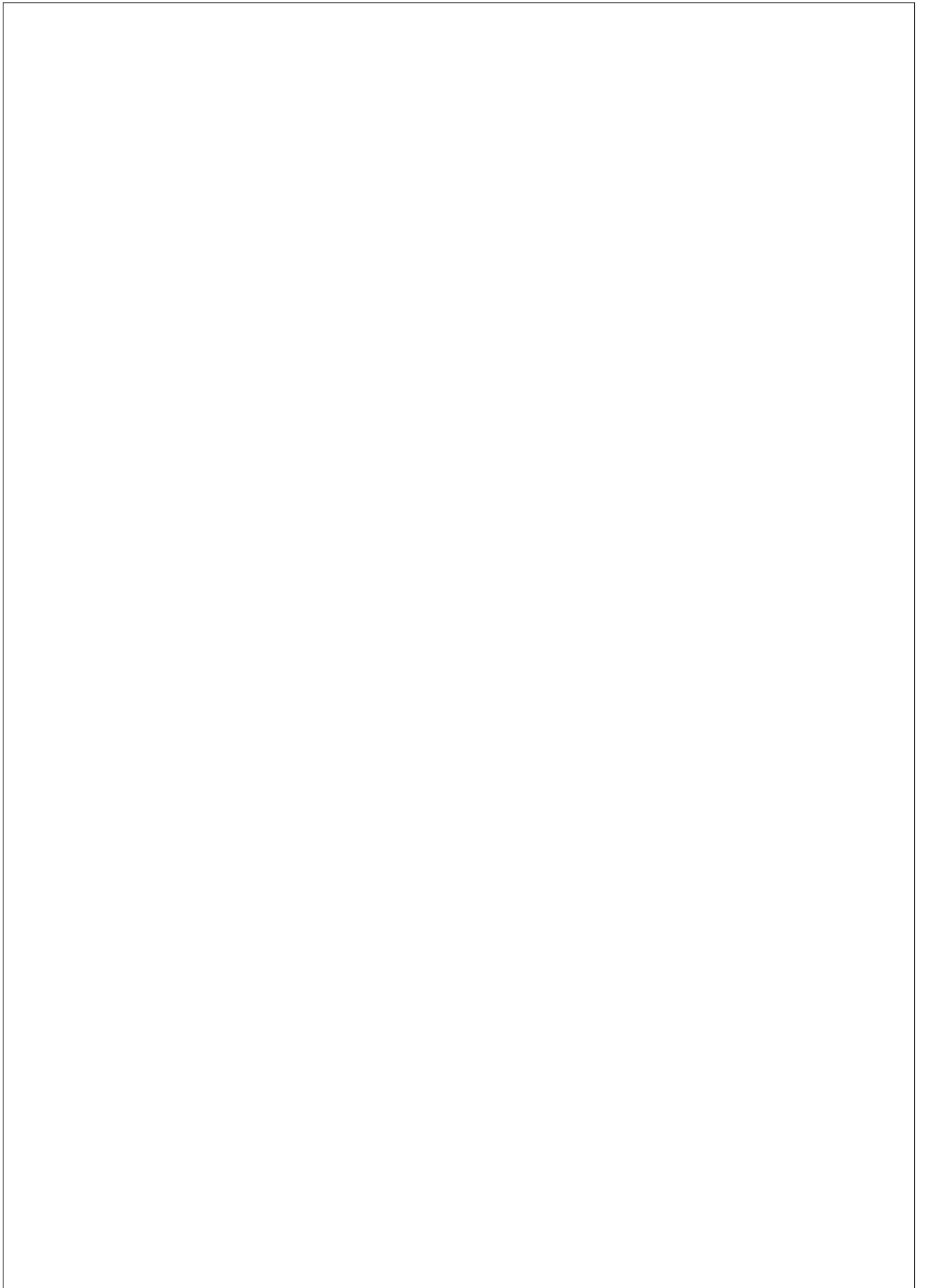



INDEX

Page
Page
Seite

2	KING PIN SETS JEUX D'AXES DE FUSEE ACHSBOLZENZÄTZE
3-5	LINK RODS BARRES D'ACCOUPLLEMENT LENKSCHUBSTANGEN
6-7	TIE ROD ENDS ROTULES DE DIRECTION KUGELGELENK
8-11	REPAIR KITS TORQUE ROD JEUX DE REPARATION DE BARRE DE REACTION REP.-SÄTZE FÜR REAKTIONSSTAG
12	WHEEL PARTS PIECES DE ROUE RADTEIL
13	CROSS REFERENCE GUIDE LISTE D'EQUIVALENCE VERGLEICHNUMMERNLISTE





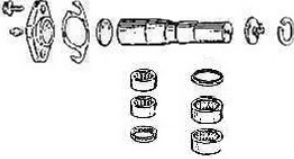
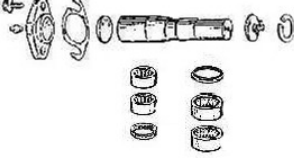
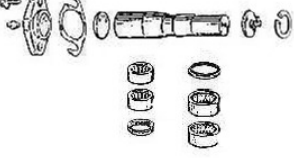





SIDEM NR	DESCRIPTION	REMARKS		
20180 KIT 20180 KIT SR	repair kit with bearing repair kit without bearing	Ø28/35 L=178		
	OE	PERIOD	AXLE	APPLICATION
	#			Eurocargo: 60/65E10/E12/E14 75E12/E14/E15 95E18 80/100E15/E18/E21 180E21
SIDEM NR	DESCRIPTION	REMARKS		
20181 KIT 20181 KIT SR	repair kit with bearing repair kit without bearing	Ø43/53 L=227		
	OE	PERIOD	AXLE	APPLICATION
	#			Eurocargo: 150E15H/E18H 170E15/E18/E23/E27 260E23KE/E27KE Eurotech Eurostar Eurotrækker
SIDEM NR	DESCRIPTION	REMARKS		
20182 KIT 20182 KIT SR	repair kit with bearing repair kit without bearing	Ø35/43 L=199		
	OE	PERIOD	AXLE	APPLICATION
	#			Eurocargo: 120/130E15/E18/E23 150E15/E18/E23/E27 260E23/280E23/320E27



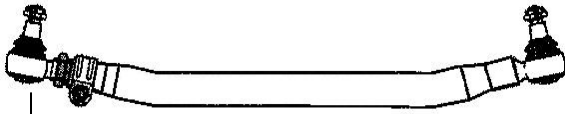

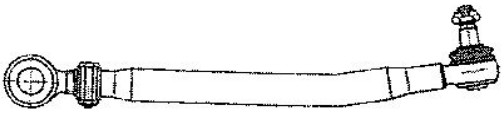
LINK RODS

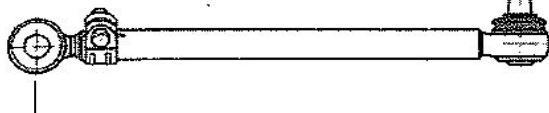
IVECO

TYPES	Oe nr.	Dimensions	Drawing
SIDEM NR: 20533			
Eurostar Subtype: 190 E39/43 - 260 E39/43 latest generation	500397738		 20831
Eurotech Subtype: 190 E31/35/39/43 - 260 E31/ 35/39/43 latest generation			
Stralis AS Subtype: 260 S40/43/48 - 440 S40/43/ 44/48/54 Latest generation			
SIDEM NR: 20739			
Eurotrakker Subtype: 410 E42	41016964 8136061 41005456 41005466	L= 698 Ø=52	 20836
SIDEM NR: 20732			
Eurocargo Subtype: 60 E10/12/14 - 65 E10/12/ 12H/14 - 75 E12/13/14/15/17/18 - 80 E15/18/20/21 - 85 E15H/18H - 100 E15/17/18/21 - 180 E21	98467459 98402544	L= 822 Ø= 38	 20935
SIDEM NR: 20736			
Eurostar Subtype: 400	41016961 41005469	L= 824 Ø= 52	 20836
Eurotech Subtype: 400 E34/38/42	41011476 41016960		
Stralis AS Subtype: 440 S40/43	8135492		
SIDEM NR: 20737			
Eurostar Subtype: 400 E38/42/47	41016958 41005472	L= 832 Ø= 52	 20836
Eurotech Subtype: 400 E34/38	8135446		
Stralis AS Subtype: 440 S40/43/44			
SIDEM NR: 20734			
Eurocargo Subtype: 170 E15/18/23/27 - 180 E21/ 24/28 - 260 E23KE/27KE/28KE	98469650 98449025	L= 878 Ø= 42	 20836

SIDEM



© Sidem nv 2006







TYPES	Oe nr.	Dimensions	Drawing
SIDEM NR: 20733			
Eurocargo Subtype: 120 E15/18/23 - 130 E15/18/23 - 140 E15/18/23 - 150 E18/23/27R - 260 E23T - 280 E23T - 320 E27T	4854874	L= 897 Ø= 42	<p>20836</p>
SIDEM NR: 20535			
Eurocargo Subtype: 120 E15/15H/17/18/18H/21/23 - 120 EL15/18/21 - 130 E15/18/23 - 150 E15/18/23/27 - 260 E23 - 280 E23 - 320 E27	500324282 4854874	L= 897 Ø= 48	<p>20935</p>
SIDEM NR: 20738			
Eurotech Subtype: 180 E24/27/30/34 - 190 E24/27/30 - 325 E27 - 400 E30/34	98446354	L= 901 Ø= 52	<p>20836</p>
SIDEM NR: 20534			
Eurotrakker Subtype: 180 E25 - 190 E30/31/34/37/42 - 260 E34/37/42 - 330 E34/37 - 380 E37/42 - 410 E42/44 - 400 E37/42 - 720 E37/42 For models with front drive	41005475 41006093	L= 952 Ø= 52	<p>20836</p>



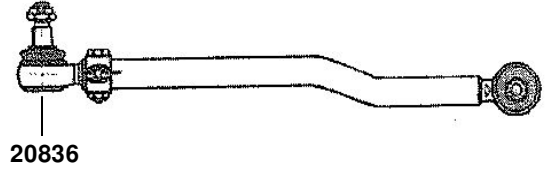

LINK RODS

IVECO

TYPES	Oe nr.	Dimensions	Drawing
SIDEM NR: 20735			
Eurostar Subtype: 180 E38/42 - 190 E38/39/42/ 43/47/52 - 240 E38/42/47/52 - 260 E39/42/43/47/48/52 - 400 E38/42/47/ 52 - 440 E38/39/42/43/46/47/48/52	41005463 8131582 8132397	L= 953 Ø= 52	
Eurotech Subtype: 180 E34/38/42 - 190 E24/26/ 31/34/35/38/39/42/43 - 240 E24/25/26/ 30/31/34/35/38/39/42/43 - 260 E38/42 - 400 E34/35/42 - 440 E38/39/42/43/46/ 47/48/52			
Eurotrakker Subtype: 190 E24/27/30/31/34/35/37/ 38/42/44 - 260 E30/31/34/35/37/38/42/ 44/47/48 - 330 E34/37 - 340 E34/35/ 37/38/42/44 - 380 E31/34/35/37/38/42/ 44/47/48 - 400 E31/34/35/37/38/42/44 - 410 E35/37/38/42/44/48 - 440 E34/ 37/38/42/44 - 720 E31/37/42/44/47/48			
Stralis AS Subtype: 190 S40/43/48 - 260 S40/43/ 44/48/54 - 440 S40/43/44/48/54			
SIDEM NR: 20731			
M115-17 M135-17 M159-17	4834037 4773359	L= 979 Ø= 36	
SIDEM NR: 20730			
Turbostar Subtype: 190-33/36/42/48 Turbotech Subtype: 190-26/32/36 - 240-36P	42087842 4747960 4747961	L= 982 Ø= 42	
SIDEM NR: 20531			
Eurotrakker Subtype: 190 E31	42118694 42115532	L= 1485 Ø= 60	





type & subtype	sidem	OE nr	A	B	C
75.9 - 80.9	20838	42480024 42491937	95	-	M24x1.50 rht
75.9 - 80.9	20839	42480023 8193649	95	-	M24x1.50 lht
OM 65 80 50.xx - 60.xx -79.xx 80.xx - 90.xx 109.xx - 160.xx - 190.xx	20832	4833825 8193645 8558533 8582322	105	-	M28x1.50 rht
OM 65 80 50.xx - 60.xx -79.xx 80.xx - 90.xx 109.xx - 160.xx - 190.xx	20833	4833826 8123394 8193646 8558536	105	-	M28x1.50 lht
Iveco 60-10/11 - 65-9/10/12 79-10/12/13/14 - 90-13 100-13 - 109-14/ 115-14/17 135-14/17/ 145-17 - 150-14/17	20932	468 8942 858 2333	115	-	M28x1.5 lht
Iveco 60-10/11 - 65-9/10/12 79-10/12/13/14 - 90-13 100-13 - 109-14/ 115-14/17 135-14/17/ 145-17 - 150-14/17	20933	4688941 8582332	115	-	M28x1,50 rht
50.xx - 60.xx - 65.xx - 70.xx - 75.xx 79.xx - 90.xx - 110.13A - 130.13-16A/AN/ANW/ 160.17A/AN/ANW	20834	42493781 8122754 2980323 42483520	114	-	M30x1.50 rht
50.xx - 60.xx - 65.xx - 70.xx - 75.xx 79.xx - 90.xx - 110.13A - 130.13-16A/AN/ANW/ 160.17A/AN/ANW	20835	42493782 8122755	114	-	M30x1.50 lht
	20830	2980875	120	-	M30x1.50 rht
EuroStar 190E39/43 - 260E39/43 EuroTech 190E31/35/39/43 - 260E31/35/39/43	20831	500309296	120	-	M30x1,50 rht
Stralis AS 260S40/43/48 440S40/43/44/48/54					
EuroCargo EuroStar EuroTech EuroTrakker Stralis AS TurboStar TurboTech	20836	4802443 4833822 4833829 8122752	120	-	M30x1,50 rht





TIE ROD ENDS

IVECO

type & subtype	sidem	OE nr	A	B	C
EuroCargo EuroStar EuroTech EuroTrakker Stralis AS TurboStar TurboTech	20837	4802444 4833830 2968584 8190255	120	-	M30x1.50 lht
EuroCargo 60E10/12/14 - 65E10/12/12H/14 75E12/13/14/15/17/18 80E15/18/20/21 - 85E15H/18H 100E15/17/18/21 -180E21 120E15/15H/17/18/18H/21/23 120EL15/18/21 - 130E15/18/23 150E15/18/23/27 -260E23 - 280E23 320E27	20934	4833828 4833821 2984511	115		M30x1.5 lht
EuroCargo 60E10/12/14 - 65E10/12/12H/14 75E12/13/14/15/17/18 80E15/18/20/21 - 85E15H/18H 100E15/17/18/21 -180E21 120E15/15H/17/18/18H/21/23 120EL15/18/21 - 130E15/18/23 150E15/18/23/27 -260E23 - 280E23 320E27	20935	4833827	115	-	M30x1,50 rht
170NC - 190NC -160.xx -165.xx 175.xx - 180.xx - 190 .xx - 240.xx 260.xx - TurboTech/Star - Bus 370	20931	468 8948	120	-	M38x1.5 rht
170NC - 190NC -160.xx -165.xx 175.xx - 180.xx - 190 .xx - 240.xx 260.xx - TurboTech/Star - Bus 370	20930	468 8949	120	-	M38x1.5 lht
type & subtype	sidem	OE nr	Length	Height	Dimensions
	20936	42485638			M12x1.00 lht
	20937	1278679			M14x1.50 rht





TYPES	Oe nr.	Dimensions	Drawing
Repair kits for Torque rods			
SIDEM NR: 20444			
Euro Cargo: 120 E15/E18/E23 130 E15/E18/E23 150 E15/E18/E23/E27 170 E18/E23/E27 260 E23 280 E23 320 E27	093163617	Ø67 x 130 x Ø19	
SIDEM NR: 14440			
Euro Cargo: 120 E15/E18/E23 130 E15/E18/E23 150 E15/E18/E23/E27 170 E18/E23/E27 260 E23 280 E23 320 E27	093192361	Ø75 x 130 x Ø19	
SIDEM NR: 20440			
Euro Tech: 180 E34/E38/E42, 190 E34/E42 240 E34/E38/E42 260 E38/E42 400 E38/E42 440 E34/E38/E42 Euro Star: 180 E38/E42 190 E34/E38/E42/E47/E52 240 E38/E47 260 E38/E42/E52 Euro Trakker: 400 E38/E42/E47/E52 440 E38/E42/E47/E52	093161960	Ø75 x 130 x Ø21	
SIDEM NR: 20246			
Euro Rider: .29/ .29A/ .35	042488722	Ø85 x 130 x Ø19	





TORQUE ROD REPAIR KITS

IVECO

TYPES	Oe nr.	Dimensions	Drawing
SIDEM NR: 14247			
	042535204	Ø85 x 130 x Ø21	
SIDEM NR: 20244			
Euro Trakker: 260 E30/E34/E37/E42/E47 340 E34/E37/E42 440 E34/E37/E42 Euro Tech: 240 E34/E38/E42 260 E42 440 E38/E42 Euro Star: 260 E52 440 E42/E52	093192618	Ø85 x 152 x Ø21	
SIDEM NR: 20241			
Euro Trakker: 330 E37 340 E42 380 E31/E34/E37/E42 410 E37/E42 720 E31/E37/E42/E47	042493431 093192619	Ø95 x 152 x Ø21	
SIDEM NR: 20445			
	093194458	Ø95 x 152 x Ø21	
SIDEM NR: 20240			
Turbo Tech: 330.26, 330.30, 330.35	002983125	Ø95 x 152 x Ø21	







TYPES	Oe nr.	Dimensions	Drawing
Repair kits for Torque rod balls			
SIDEM NR: 20242			
190-32, 190-32 GV, 190-36, 190-36 GV, 190-42, 190-48, 220-32, 220-36, 240-32 GV, 240-36, 240-36 GV	002968454		
SIDEM NR: 20247			
Euro Tech: 180 E34/E38/E42, 190 E34/E42 240 E34/E38/E42 260 E38/E42 400 E34/E38/E42 440 E34/E38/E42 Euro Star: 180 E38/E42 190 E34/E38/E42/E47/E52 240 E38/E47 260 E38/E42/E52 Euro Trakker: 400 E38/E42/E47/E52 440 E38/E42/E47/E52	093161631		
SIDEM NR: 20443			
Turbo Star <i>Grease included</i>	093161371	Ø65 x 168/Ø19 x 130	
SIDEM NR: 20243			
	002980884	Ø72 x 168/Ø19 x 130	





TORQUE ROD REPAIR KITS

IVECO

TYPES	Oe nr.	Dimensions	Drawing
SIDEM NR: 20441			
Euro Tech: 180 E34/E38/E42 190 E34/E42 240 E34/E38/E42 260 E38/E42 400 E34/E38/E42 440 E34/E38/E42 Euro Star: 180 E38/E42 190 E34/E38/E42/E47/E52 240 E38/E47 260 E38/E42/E52 Euro Trakker: 400 E38/E42/E47/E52 440 E38/E42/E47/E52 Grease included	093161958	Ø72 x M20/46	
SIDEM NR: 20442			
Grease included		Ø72 x 48	





Type	OE nr	Dimensions	Drawing
Bolts			
SIDEM NR: 20010			
	7168257	M18 x 1,5 x 66	
SIDEM NR: 20011			
	142117433	M20 x 1,5 x 70,5	
SIDEM NR: 20012			
	*	M20 x 1,5 x 76,5	
SIDEM NR: 20014			
	03427565	M22 x 1,5 x 92	
SIDEM NR: 20013			
	42117455	M22 x 1,5 x 110	
SIDEM NR: 20015			
	03424731	M22 x 1,5 x 114	
Nuts			
SIDEM NR: 20021	SIDEM ref.		
Fits to:	20011 20012	*	H20 - sw27
SIDEM NR: 20020	SIDEM ref.		
Fits to:	20010	*	H22 - sw27
SIDEM NR: 50122	SIDEM ref.		
Fits to:	20013 20014 20015	074361022205	H23 - sw30





CROSS REFERENCE GUIDE

IVECO

OE nr	SIDEM nr	Page	OE nr	SIDEM nr	Page	OE nr	SIDEM nr	Page
#	20442	11	468 8948	20931	7			
#	20012	12	468 8949	20930	7			
#	20020	12	4773359	20731	5			
#	20021	12	4802443	20836	6			
#	20181 KIT	2	4802444	20837	7			
#	20181 KIT SR	2	483 3827	20935	7			
002968454	20242	10	483 3828	20934	7			
002980884	20243	10	4833821	20934	7			
002983125	20240	9	4833822	20836	6			
03424731	20015	12	4833825	20832	6			
03427565	20014	12	4833826	20833	6			
04248 8722	20246	8	4833829	20836	6			
042493431	20241	9	4833830	20837	7			
042535204	14247	9	4834037	20731	5			
074361022205	50122	12	4854874	20535	4			
093161371	20443	10	4854874	20733	4			
093161631	20247	10	500309296	20831	6			
093161958	20441	11	500324282	20535	4			
093161960	20440	8	500397738	20533	3			
093163617	20444	8	7168257	20010	12			
093192361	14440	8	812 3394	20833	6			
093192618	20244	9	8122752	20836	6			
093192619	20241	9	8122754	20834	6			
093194458	20445	9	8122755	20835	6			
1278679	20937	7	8131582	20735	5			
142117433	20011	12	8132397	20735	5			
1904696	20180 KIT	2	8135492	20736	3			
1904696	20180 KIT SR	2	8136061	20739	3			
1904697	20182 KIT	2	819 3646	20833	6			
1904697	20182 KIT SR	2	8190255	20837	7			
2968584	20837	7	8193645	20832	6			
2980323	20834	6	8193649	20839	6			
2980875	20830	6	855 8536	20833	6			
2984511	20934	7	8558533	20832	6			
41005456	20739	3	858 2333	20932	6			
41005463	20735	5	8582322	20832	6			
41005466	20739	3	8582332	20933	6			
41005469	20736	3	98402544	20732	3			
41005475	20534	4	98446354	20738	4			
41006093	20534	4	98449025	20734	3			
41011476	20736	3	98467459	20732	3			
41016958	20737	3	98469650	20734	3			
41016960	20736	3						
41016961	20736	3						
41016964	20739	3						
42117455	20013	12						
42480023	20839	6						
42480024	20838	6						
42483520	20834	6						
42485638	20936	7						
4249 3781	20834	6						
42491937	20838	6						
42493782	20835	6						
468 8941	20933	6						
468 8942	20932	6						

SIDEM



© Sidem nv 2006

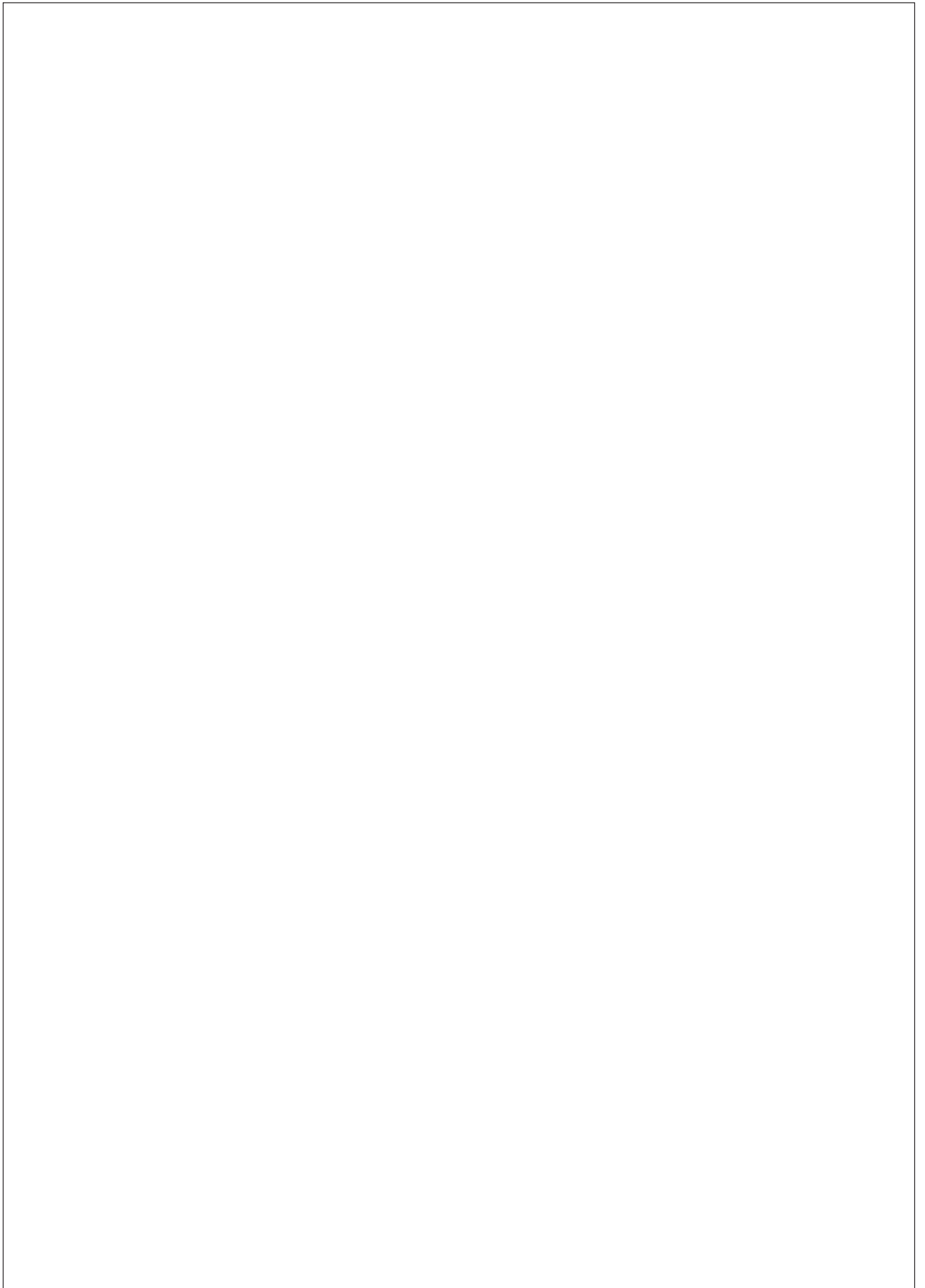





INDEX

Page
Page
Seite

2-3	KING PIN SETS JEUX D'AXES DE FUSEE ACHSBOLZENZÄTZE
4	TRACK RODS BARRES DE DIRECTION SPURSTANGEN
5	LINK RODS BARRES D'ACCOUPEMENT LENKSCHUBSTANGEN
6-7	TIE ROD ENDS ROTULES DE DIRECTION KUGELGELENK
8	TORQUE RODS BARRES DE REACTION REAKTIONSSTANG
9-12	REPAIR KITS TORQUE ROD JEUX DE REPARATION DE BARRE DE REACTION REP.-SÄTZE FÜR REAKTIONSSTANG
13-15	STABILISER BEARINGS DOUILLES DE STABILISATEUR STABILISATORLAGER
16-17	WHEEL PARTS PIECES DE ROUE RADTEIL
18-19	CROSS REFERENCE GUIDE LISTE D'EQUIVALENCE VERGLEICHNUMMERNLISTE





SIDEM NR	DESCRIPTION			REMARKS
44180 KIT 44180 KIT SR	repair kit with bearing repair kit without bearing			Ø44,5/45 L = 213
	OE	PERIOD	AXLE	APPLICATION
	81442056009 81442040008	1988 - 1995		M90
SIDEM NR	DESCRIPTION			REMARKS
44181 KIT 44181 KIT SR	repair kit with bearing repair kit without bearing			Ø49,5/50 L = 223
	OE	PERIOD	AXLE	APPLICATION
	81442056013	1993 -->		F 2000 F90 - F 90 unterflur M 2000 M90
SIDEM NR	DESCRIPTION			REMARKS
50788 KIT 50788 KIT SR	repair kit with bearing repair kit without bearing			Ø50 L = 109
	OE	PERIOD	AXLE	APPLICATION
	81363050015	1988 - 1996		F 2000 (top) F 90 (top)





KING PIN SETS

MAN

SIDEM NR	DESCRIPTION			REMARKS
50881 KIT 50881 KIT SR	repair kit with bearing repair kit without bearing			Ø50/64 L = 119
	OE	PERIOD	AXLE	APPLICATION
	81363050014 81363050016 81363056001	1988 - 1996		F 2000 (bottom) F 90 (bottom)
SIDEM NR	DESCRIPTION			REMARKS
44182 KIT 44182 KIT SR	repair kit with bearing repair kit without bearing			Ø49,5/50 L =223
	OE	PERIOD	AXLE	APPLICATION
	81442056010	1975 - 1994		R SG SL SR





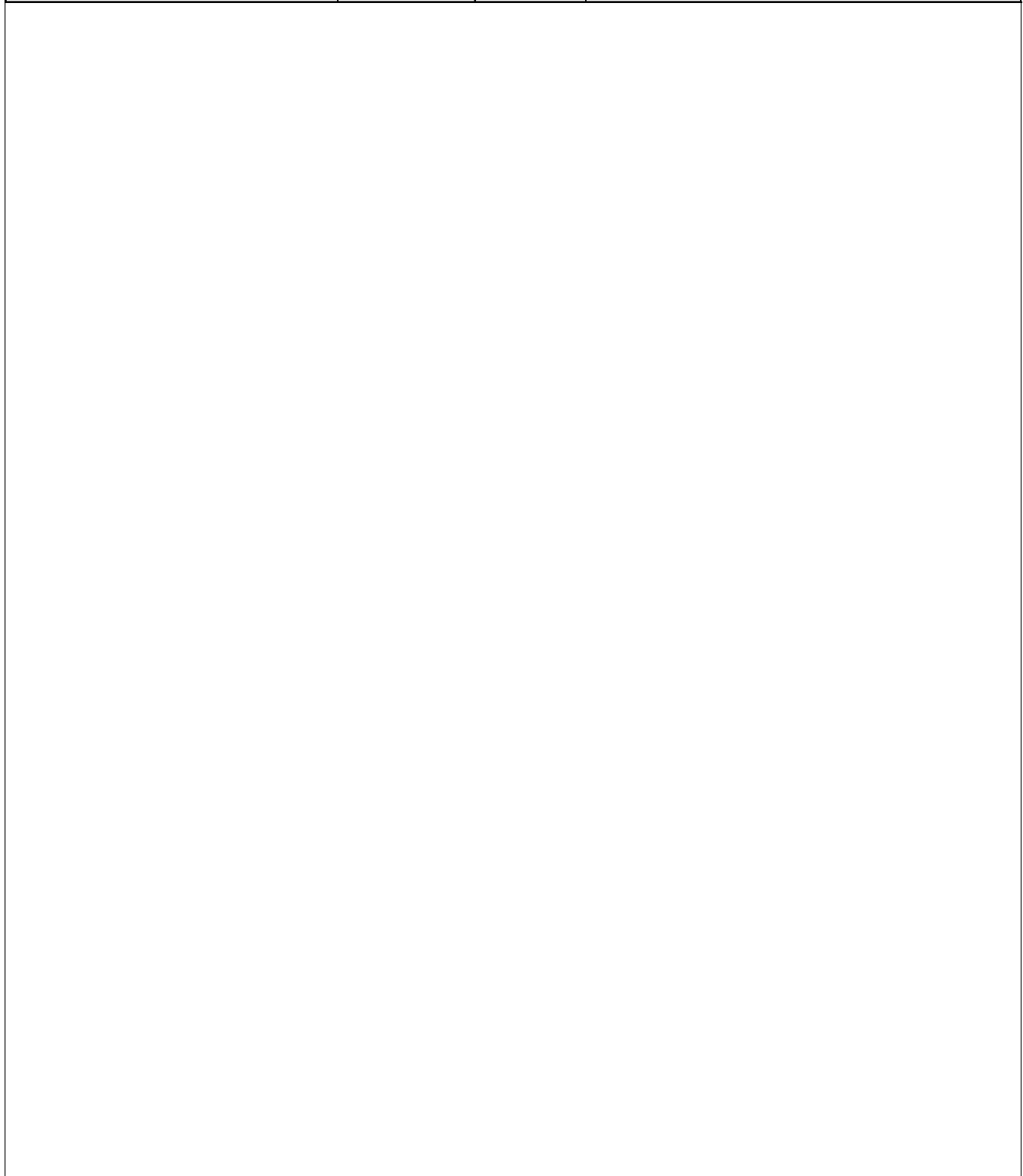

TYPES	Oe nr.	Dimensions	Drawing
SIDEM NR: 44130			
F2000 F90 M2000 M90 TGA (1999->) 18 Ton, 26 Ton, 33 Ton, 35 Ton, 41 Ton	81467106112 81467106163 81467106165 81467106198 81467106353 81467106354 81467106361 81467116725	L= 1672 Ø= 50	<p>50630</p> <p>50631</p>



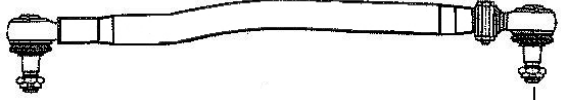

LINK RODS

MAN

TYPES	Oe nr.	Dimensions	Drawing
SIDEM NR: 44132			
TGA (1999->) 18 Ton, 26 Ton, 33 Ton, 35 Ton, 41 Ton	81466116087 81466116096 81466116097 81466116132 81466116133	L= 963	 44033
SIDEM NR: 44131			
F2000 F90 F90 unterflur	81466106333 81466106334 81466106354 81466106355 81466106360 81466106361 81466106721 81466106722	L= 1040 Ø= 48	 44031





Type & Subtype	Sidem	OE nr	A	B	C
L.xx Series (6 - 9 ton)	50834	81953010077 81953016134 81953016142 81953016303	95		M24x1.5 rht
L.xx Series (6 - 9 ton)	50835	81953010078 81953016141 81953016304	95		M24x1.5 lht
L.xx Series (6 - 9 ton) M.xx Series (10 - 12 ton)	50832	81953016060 81953016135 81953016140 81953016249	105		M28x1.5 rht
L.xx Series (6 - 9 ton) M.xx Series (10 - 12 ton)	50833	81953010079 81953016139 81953016222	105		M28x1.5 lht
Old Gen CH 503 - 930 M.xx Series	50830	81953010014 81953010064 81953016067 81953016162 81953016239 90804153111	115		M30x1.5 rht
Old Gen CH 503 - 930 M.xx Series	50831	81953010013 81953010074 81953016068 81953016163 90804153107 90804153113	115		M30x1.5 lht
F2000 F90 M 2000 M 90 TGA 1999-> 18 Ton 26 Ton 33 Ton 35 Ton 41 Ton	50630	81953010016 81953010084 81953016048 81953016049 81953016053 81953016090 81953016108 81953016112 81953016126 81953016143 81953016149 81953016154 81953016156 81953016178 81953016194 81953016224 81953016234 81953016274 81953016278	120		M30x1,5 rht





TIE ROD ENDS

MAN

Type & Subtype	Sidem	OE nr	A	B	C
F2000 F90 M 2000 M 90 TGA 1999-> 18 Ton 26 Ton 33 Ton 35 Ton 41 Ton	50631	81953010015 81953010083 81953016030 81953016043 81953016050 81953016054 81953016087 81953016091 81953016107 81953016120 81953016125 81953016152 81953016155 81953016157 81953016168 81953016179 81953016223 81953016237 81953016279	120		M30x1,5 lht
	50633	81953010025	120		M30x1.5 rht
A.xx - E.xx - F.xx - H.xx - (TGA) series L.xx - M.xx T.xx - X.xx	50634	81953016274	120		M30x1.5 rht
	44032	81953010022	135		M30x1.5 rht
F2000 F90 F90 unterflur	44031	81953016263	155		M30x1,5 rht
TGA 1999-> 18 Ton 26 Ton 33 Ton 35 Ton 41 Ton	44033	81953016312			M30x1,5 rht
F90 - 35.302 & 322	50635	81953016184	120		M38x1.5 rht
Type & Subtype	Sidem	OE nr	Length	Height	Dimensions
	50930	81953016064 81953016130 81953016170 81953016173	55	-	M12x1.0 rht
	50931	81953016063 81953016131 81953016171 81953016174	55	-	M12x1.0 lht

© Sidem nv 2006

SIDEM



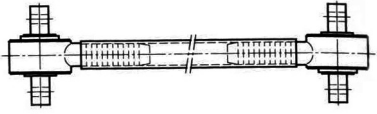
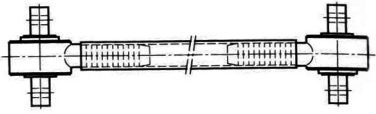
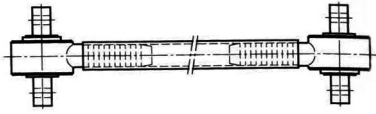

TYPES	OE nr	Dimensions	Drawing
SIDEM NR: 44041			
16168 ->26361 lower	81432306037 81432309037	500 mm	
SIDEM NR: 44042			
26240 -> 33365	81432306052 81432206052 81432206010 81432206012 81432206013 81432206020 81432206040 81432206041 81432206052 81432206056 81432306018 81432306028	565 mm	
SIDEM NR: 44044			
16292 -> 26502 upper & lower	81432206129 81432206096 81432206097 81432206098 81432209129 81432306014 81432306030	571 mm	





TORQUE ROD REPAIR KITS

MAN

TYPES	Oe nr.	Dimensions	Drawing
Repair kits for Torque rods			
SIDEM NR: 14440 EL, NG, NL, NM	81432306061		
SIDEM NR: 44247 16280FL, 16281FL/FVL 16321FL/FVL, 19281FL/FVL 19321FL/FVL, 20320FL/FVL 20281FL/FVL, 20321FL/FVL 22281FL/FVL, 22321FL/FVL 22240FNL, 22241UNL 22280FNL, 22281FNL 22320FNL, 22321FNL 22321UNL	81432306043	Ø19/130	
SIDEM NR: 44249	81432206202	Ø67 X 100 X Ø17	
SIDEM NR: 44046 18.192 19.242 24.192 24.242 25.372 26.372 33.272 S2000 F2000	81432306051 81432306068	Ø75 X 17/115	
SIDEM NR: 44246 26/30/32/33.320 DF 26.240 DFA 30.240 VFR 26/30.240 DH/DHR 26/32.280 DH	81432206012 81432206055 81432206073	Ø85 X 19/130	

SIDEM



© Sidem nv 2006







TYPES	Oe nr.	Dimensions	Drawing
SIDEM NR: 44440			
	81953020077	Ø85 x Ø20 x 130	
SIDEM NR: 44047			
S2000	81432206203	Ø85 X 21/130	
SIDEM NR: 44441			
	81432706105	Ø85 x 25/130	
SIDEM NR: 44442			
	81432206204	Ø95/74 M24x2	
SIDEM NR: 50241			
	81432706040 81432706045	Ø95 x 21/152	





TORQUE ROD REPAIR KITS

MAN



TYPES	Oe nr.	Dimensions	Drawing
SIDEM NR: 44443			
	81432706110	Ø100 x 25/152	
Repair kits for Torque rod balls			
SIDEM NR: 50240			
<i>Grease included</i>	81432706047		
SIDEM NR: 6247			
<i>Grease included</i>	81432206104 81432206107	Ø19 x 65 x 80/130	
SIDEM NR: 44243			
19.242/262/272/292/302, 19.322/332/362/372/422 (462->1990) 26.272/302/322/372/422 19.462/502 <i>Grease included</i>	81432206108	Ø19 x 65 x 80/130	
SIDEM NR: 44340			
16280FL, 16281FL/FVL 16321FL/FVL, 19281FL/FVL 19321FL/FVL, 20320FL/FVL 20281FL/FVL, 20321FL/FVL 22281FL/FVL, 22321FL/FVL 22240FNL, 22241UNL 22280FNL, 22281FNL 22320FNL, 22321FNL 22321UNL	81953016133	Ø23 x 80 x 90/152	

© Sidem nv 2006

SIDEM













TYPES	Oe nr.	Dimensions	Drawing
SIDEM NR: 68543			
<i>Grease included</i>	81432506009	Ø67 x 100 x Ø17	
SIDEM NR: 20242			
	81432706065	Ø72 x 65/46 M20x1,5	
SIDEM NR: 44248			
F2000 F90 TG-A 16280FL , 16281FL/FVL 16321FL/FVL , 19281FL/FVL 19321FL/FVL , 20320FL/FVL 20281FL/FVL , 20321FL/FVL 22281FL/FVL , 22321FL/FVL 22240FNL , 22241UNL 22280FNL , 22281FNL 22320FNL , 22321FNL 22321UNL	81953016132	Ø90 x 80/60 M24x1,5	





STABILISER BEARINGS

MAN









Type	OE nr	Dimensions	Drawing
SIDEM NR: 44268			
	81 43271 0029 81 43271 0008	Ø16 x 45/42	
SIDEM NR: 44269			
	81 43271 0022	Ø18 x 55/55	
SIDEM NR: 44265			
	81 43722 0021	Ø22 x 65/62	
SIDEM NR: 44160			
	81 43722 0039	Ø22 x 68/62	
SIDEM NR: 44161			
	81 43722 0063	Ø22 x 68/62	
SIDEM NR: 44266			
	81 43722 0019 81 43722 6051	Ø22 x 75/62	
SIDEM NR: 44162			
	81 43277 0047	Ø24 x 64/44	
SIDEM NR: 44164			
	81 43704 0052	Ø31,5 x 56,5 x 65/51,5	

SIDEM



© Sidem nv 2006



Type	OE nr	Dimensions	Drawing
SIDEM NR: 44163			
	81 43704 0053	Ø35,5 x 56,5 x 65/51,5	
SIDEM NR: 44166			
	81 43704 0026	Ø38 x 58 x 65/74	
SIDEM NR: 44167			
	81 43704 0029	Ø45 x 58 x 70/80	
SIDEM NR: 44165			
	81 43704 0025	Ø55 x 65 x 80,5/80,5	
SIDEM NR: 44267			
	81 96210 0448	Ø94 - 75 M22	
SIDEM NR: 44361			
	81 96210 0450	16 x 47,5 x 47	
SIDEM NR: 44169			
	81 43704 0057	44 x 67 x 60	
SIDEM NR: 44260			
	81 43704 0060	55 x 78 x 61	





STABILISER BEARINGS

MAN

Type	OE nr	Dimensions	Drawing
SIDEM NR: 44263			
	81 43704 0044	55 x 82 x 80	
SIDEM NR: 44360			
	81 43722 0040	55 x 83 x 70	
SIDEM NR: 44264			
	81 43704 0045 81 43704 0028	55 x 88 x 80	
SIDEM NR: 44262			
	81 43704 0061	78,5 x 60,5 x 60,5	
SIDEM NR: 44168			
	81 43704 0032	85 x 60 / 70 x 81	
SIDEM NR: 44261			
	81 43271 0081	94 x 54 x 81	





Type	OE nr	Dimensions	Drawing
Bolts			
SIDEM NR: 44010			
	81455010076	M22 x 1,5 x 77 A = 38	
SIDEM NR: 44013			
	81455010085	M22 x 1,5 x 83 A = 41	
SIDEM NR: 44011			
	81455010080	M22 x 1,5 x 100 A = 39	
SIDEM NR: 44012			
	*	M22 x 1,5 x 100 A = 40	
SIDEM NR: 44014			
	81455010082	M22 x 1,5 x 110 A = 42	
SIDEM NR: 44014			
	*	M22 x 1,5 x 110 A = 43	
SIDEM NR: 44016			
	81455010099	M22 x 1,5 x 128 A = 44	





WHEEL PARTS

MAN

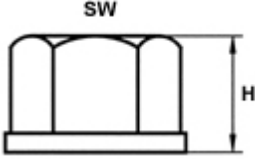
Type	OE nr	Dimensions	Drawing
Nuts			
SIDEM NR: 50122	SIDEM ref.		
Fits to:	44010 44013 44011 44014 44016 44012 44015	061112220218	H23 - sw30
			





OE nr	SIDEM nr	Page	OE nr	SIDEM nr	Page	OE nr	SIDEM nr	Page
#	44012	16	81 43704 0028	44264	15	81 95301 0079	50833	6
#	44014	16	81 43704 0029	44167	14	81 95301 0083	50631	7
061112220218	50122	17	81 43704 0032	44168	15	81 95301 0084	50630	6
81 36305 0014	50881 KIT	3	81 43704 0044	44263	15	81 95301 6030	50631	7
81 36305 0015	50788 KIT	2	81 43704 0045	44264	15	81 95301 6043	50631	7
81 36305 0016	50881 KIT	3	81 43704 0052	44164	13	81 95301 6048	50630	6
81 36305 6001	50881 KIT	3	81 43704 0053	44163	14	81 95301 6049	50630	6
81 43220 6010	44042	8	81 43704 0057	44169	14	81 95301 6050	50631	7
81 43220 6012	44042	8	81 43704 0060	44260	14	81 95301 6053	50630	6
81 43220 6012	44246	9	81 43704 0061	44262	15	81 95301 6054	50631	7
81 43220 6013	44042	8	81 43722 0019	44266	13	81 95301 6060	50832	6
81 43220 6020	44042	8	81 43722 0021	44265	13	81 95301 6063	50931	7
81 43220 6040	44042	8	81 43722 0039	44160	13	81 95301 6064	50930	7
81 43220 6041	44042	8	81 43722 0040	44360	15	81 95301 6067	50830	6
81 43220 6052	44042	8	81 43722 0063	44161	13	81 95301 6068	50831	6
81 43220 6052	44042	8	81 43722 6051	44266	13	81 95301 6087	50631	7
81 43220 6055	44246	9	81 44204 0008	44180 KIT	2	81 95301 6090	50630	6
81 43220 6056	44042	8	81 44205 6009	44180 KIT	2	81 95301 6091	50631	7
81 43220 6073	44246	9	81 44205 6010	44182 KIT	3	81 95301 6107	50631	7
81 43220 6096	44044	8	81 44501 0082	44014	16	81 95301 6108	50630	6
81 43220 6097	44044	8	81 45501 0076	44010	16	81 95301 6112	50630	6
81 43220 6098	44044	8	81 45501 0080	44011	16	81 95301 6120	50631	7
81 43220 6104	6247	11	81 45501 0085	44013	16	81 95301 6125	50631	7
81 43220 6107	6247	11	81 45501 0099	44016	16	81 95301 6126	50630	6
81 43220 6108	44243	11	81 46610 6333	44131	5	81 95301 6130	50930	7
81 43220 6129	44044	8	81 46610 6334	44131	5	81 95301 6132	44248	12
81 43220 6202	44249	9	81 46610 6354	44131	5	81 95301 6133	44340	11
81 43220 6203	44047	10	81 46610 6355	44131	5	81 95301 6134	50834	6
81 43220 6204	44442	10	81 46610 6360	44131	5	81 95301 6135	50832	6
81 43220 9129	44044	8	81 46610 6361	44131	5	81 95301 6139	50833	6
81 43230 6014	44044	8	81 46610 6721	44131	5	81 95301 6140	50832	6
81 43230 6018	44042	8	81 46610 6722	44131	5	81 95301 6141	50835	6
81 43230 6028	44042	8	81 46611 6087	44132	5	81 95301 6142	50834	6
81 43230 6030	44044	8	81 46611 6096	44132	5	81 95301 6143	50630	6
81 43230 6037	44041	8	81 46611 6097	44132	5	81 95301 6149	50630	6
81 43230 6043	44247	9	81 46611 6132	44132	5	81 95301 6152	50631	7
81 43230 6051	44046	9	81 46611 6133	44132	5	81 95301 6154	50630	6
81 43230 6052	44042	8	81 46710 6112	44130	4	81 95301 6155	50631	7
81 43230 6061	14440	9	81 46710 6163	44130	4	81 95301 6156	50630	6
81 43230 6068	44046	9	81 46710 6165	44130	4	81 95301 6157	50631	7
81 43230 9037	44041	8	81 46710 6198	44130	4	81 95301 6162	50830	6
81 43250 6009	68543	12	81 46710 6353	44130	4	81 95301 6163	50831	6
81 43270 6040	50241	10	81 46710 6354	44130	4	81 95301 6163	50931	7
81 43270 6045	50241	10	81 46710 6361	44130	4	81 95301 6168	50631	7
81 43270 6047	50240	11	81 46711 6725	44130	4	81 95301 6170	50930	7
81 43270 6065	20242	12	81 95301 0013	50831	6	81 95301 6171	50931	7
81 43270 6105	44441	10	81 95301 0014	50830	6	81 95301 6173	50930	7
81 43270 6110	44443	11	81 95301 0015	50631	7	81 95301 6174	50931	7
81 43271 0008	44268	13	81 95301 0016	50630	6	81 95301 6178	50630	6
81 43271 0022	44269	13	81 95301 0022	44032	7	81 95301 6179	50631	7
81 43271 0029	44268	13	81 95301 0025	50633	7	81 95301 6184	50635	7
81 43271 0081	44261	15	81 95301 0064	50830	6	81 95301 6194	50630	6
81 43277 0047	44162	13	81 95301 0074	50831	6	81 95301 6222	50833	6
81 43704 0025	44165	14	81 95301 0077	50834	6	81 95301 6223	50631	7
81 43704 0026	44166	14	81 95301 0078	50835	6	81 95301 6224	50630	6





CROSS REFERENCE GUIDE

MAN

OE nr	SIDEM nr	Page	OE nr	SIDEM nr	Page	OE nr	SIDEM nr	Page
81 95301 6234	50630	6						
81 95301 6237	50631	7						
81 95301 6239	50830	6						
81 95301 6249	50832	6						
81 95301 6263	44031	7						
81 95301 6274	50630	6						
81 95301 6274	50634	7						
81 95301 6278	50630	6						
81 95301 6279	50631	7						
81 95301 6303	50834	6						
81 95301 6304	50835	6						
81 95301 6312	44033	7						
81 95302 0077	44440	10						
81 96210 0448	44267	14						
81 96210 0450	44361	14						
81.44205.6013	44181 KIT	2						
90 80415 3107	50831	6						
90 80415 3111	50830	6						
90 80415 3113	50831	6						

SIDEM



© Sidem nv 2006

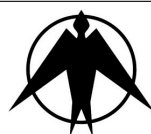
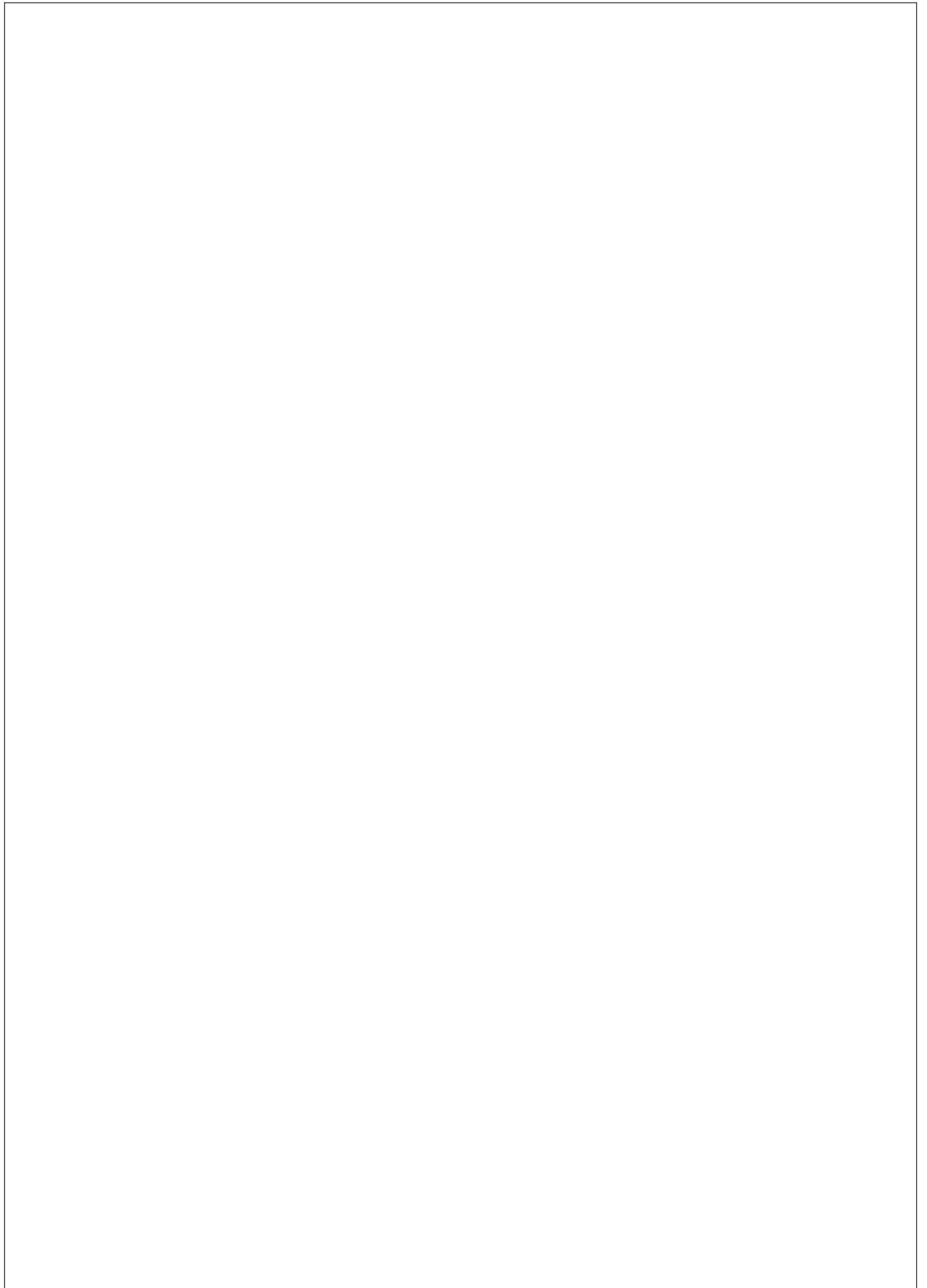



INDEX

Page

Page



Seite

2-8	KING PIN SETS JEUX D'AXES DE FUSEE ACHSBOLZENZÄTZE
9-12	TRACK RODS BARRES DE DIRECTION SPURSTANGEN
13-18	LINK RODS BARRES D'ACCOUPLLEMENT LENKSCHUBSTANGEN
19-20	TIE ROD ENDS ROTULES DE DIRECTION KUGELGELENK
21-23	TORQUE RODS BARRES DE REACTION REAKTIONSSTANG
24-29	REPAIR KITS TORQUE ROD JEUX DE REPARATION DE BARRE DE REACTION REP.-SÄTZE FÜR REAKTIONSSTANG
30	STABILISER BEARINGS DOUILLES DE STABILISATEUR STABILISATORLAGER
31-32	WHEEL PARTS PIECES DE ROUE RADTEIL
33-34	CROSS REFERENCE GUIDE LISTE D'EQUIVALENCE VERGLEICHNUMMERNLISTE



MERCEDES KING PIN SETS





SIDEM NR	DESCRIPTION	REMARKS
50882 KIT 50882 KIT SR	repair kit with bearing repair kit without bearing	Ø35 L = 203
	OE	APPLICATION
	327330019 3275860033	323 L/LF/LK/LS 328 L/LF/LK/LKO/LS 710 L/LF/LK/LS 911 L/LK/LKO/LS 1013 LP/LPF/LPK/LPKO/LPS 1113B L/LF/LK/LKO/LS/LP/LPF/LPK/LPKO/LPS 1213 LP/LPK/LPS/LPKO 1216 LP/LPK/LPS/LPKO 1313 L/LF/LK/LS/LKO/LP/LPK/LPS/LPKO 1317 LP/LPK/LPS/LPKO 1319 LP/LPK/LPS/LPKO 1418 L/LK/LS/LP/LPS 1813 L 1817 L 1819 L
SIDEM NR	DESCRIPTION	REMARKS
50980 KIT 50980 KIT SR	repair kit with bearing repair kit without bearing	Ø36,65 L = 211
	OE	APPLICATION
	3603300719 3605860233	Axle : BM 730.001/02/04/30/31/36/39 810 LP/LPF/LPK/LPKO 911B L/LK/LS/LP/LPF/LPK/LPKO 1424 LP/LPS CH 016350-> 10/20 CH 796991-> 50/60 CH 790759-> 1013B LP/LPK/LPKO 1113B L/LF/LK/LKO/LS/LP/LPKO/OF 1213 LP/LPK/LPS 1216 LP/LPK/LPS 1313 L/LF/LK/LS/LP/LPK/LPS 1317 LP/LPK/LPS/OF 1319 LP/LPK/LPS 1513 L/LK/LKO/LS/LP/LPK/LPKO/LPS 1517 L/LK/LKO/LS/LP/LPK/LPKO/LPS 1519 L/LK/LKO/LS/LP/LPK/LPKO/LPS







KING PIN SETS MERCEDES

SIDEM NR	DESCRIPTION	REMARKS
50680 KIT 50680 KIT SR	repair kit with bearing repair kit without bearing	Ø45 L = 218
	OE	APPLICATION
	3553300619 3555860333	Axle : BM 730.200/230/231 ->CH 1868886 1213 LP/LPS 1216 LP/LPS 1313 LP/OF 1317 LP/LPS 1319 LP/LPS 1413 OF 1417 OF 1513 L/LK/KLO/LS 2219 6x4 LP/LPK
SIDEM NR	DESCRIPTION	REMARKS
50686 KIT 50686 KIT SR	repair kit with bearing repair kit without bearing	Ø45 L = 216,5
	OE	APPLICATION
	3553302119 3555861833	Axle : BM 730.200/230/231 CH 1868887-> 1213 LP/LPS 1216 LP/LPS 1313 LP/OF 1317 LP/LPS 1319 LP/LPS 1413 OF 1417 OF 1513 L/LK/KLO/LS 2219 6x4 LP/LPK
SIDEM NR	DESCRIPTION	REMARKS
50886 KIT 50886 KIT SR	repair kit with bearing repair kit without bearing	Ø36,65 L = 203
	OE	APPLICATION
	3023300619 3025860033	1313 OF 10/20 -> 796990 OF 50/60 -> 790758 1317 LPKO -> 791565 OF 10/20 -> 796990 OF 50/60 -> 790758 1319 LPKO -> 79156 1418 LPS/LS 338.007/058 LP/LPS 353 Front axle -> K65791 1513 LP/LKO/LPKO 10/20 ->796990 LP/LKO/LPKO 50/60 ->790758 1517 LP/LPK/LPKO/LPS 10/20 ->796990 LP/LPK/LPKO/LPS 50/60 ->790758 1519 LP/LPK/LPKO/LPS 10/20 ->796990 LP/LPK/LPKO/LPS 50/60 ->790758



MERCEDES KING PIN SETS





SIDEM NR	DESCRIPTION	REMARKS
50688 KIT	repair kit with bearing	Ø45
50688 KIT SR	repair kit without bearing	L = 219
OE		APPLICATION
	3553300319	1219 K 1413 /K/KO 1414 /K 1417 /K/KO/C/CK 1419 /F/K/L/S/C/CL 1420 /L/LS 1422 /F/L/LS/S 1424 /F/K/S 1425 /LS/S 1428 F 1613 /K/KO/L 1614 /K 1617 /K/KO/L/S/C/CK/CL/CS 1618 /K/KO/L/S/C 1620 /L 1622 /K/L/S 1624 /K/L/LS/S 1625 /K/L/LS/S 1628 L 1814 2219 6x2 / L 6x2 6x4 /K/KO 2222 L 2224 6x2/6x4 /B 6x4 /S 2225 - 2422 - 2425
	3555860033	
SIDEM NR	DESCRIPTION	REMARKS
50787 KIT	repair kit with bearing	Ø45/46
50787 KIT SR	repair kit without bearing	L = 225
OE		APPLICATION
	3433300219	Front Axle BM 739.001/003 1617 LP/OF 1619 LP/LPKO 1621 L/LK/LS 1624 LK/LS/LP/LPK/LPS 1626 LP/LPK/LPS 1632 LP/LPK/LPS 1921 L/LK/LS 1924 L/LK/LS/LP/LPS 1926 LPL/LPS 10/20 -> 886512 LPL/LPS 50/60 -> 890245 1928 L/LK/LS 1932 LP/LPS 10/20 -> 886512 LP/LPS 50/60 -> 890245 2024 6x2 LPS 2032 6x2 LPS 2223 6x2 LP 2224 6x2 LP 6x4 LP/LPB/LPK/LPS 2226 6x2 LP 6x4 LP/LPB/LPK/LPS 2232 6x2 LP/LPL 6x4 LP/LPK/LPS
	3435860233	



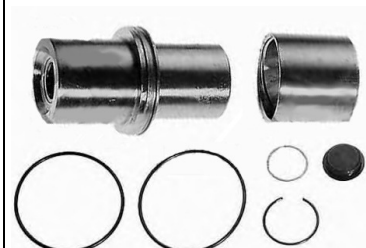

KING PIN SETS MERCEDES

SIDEM NR	DESCRIPTION	REMARKS
50785 KIT 50785 KIT SR	repair kit with bearing repair kit without bearing	Ø45 L = 224
	OE	APPLICATION
	3263300219 3265860033	Front Axle BM 739.001/003 1617 LP/OF 1619 LP/LPKO 1621 L/LK/LS 1624 LK/LS/LP/LPK/LPS 1626 LP/LPK/LPS 1632 LP/LPK/LPS 1921 L/LK/LS 1924 L/LK/LS/LP/LPS 1926 LPL/LPS 10/20 -> 886512 LPL/LPS 50/60 -> 890245 1928 L/LK/LS 1932 LP/LPS 10/20 -> 886512 LP/LPS 50/60 -> 890245 2024 6x2 LPS 2032 6x2 LPS 2223 6x2 LP 2224 6x2 LP 6x4 LP/LPB/LPK/LPS 2226 6x2 LP 6x4 LP/LPB/LPK/LPS 2232 6x2 LP/LPL 6x4 LP/LPK/LPS
SIDEM NR	DESCRIPTION	REMARKS
50883 KIT 50883 KIT SR	repair kit with bearing repair kit without bearing	Ø55 L = 109
	OE	APPLICATION
	6253300119	1922 - 4050 (upper) also for ACTROS Front Axle BM 731.900/924 1922 AK - 1929 A - 1935 A 2529 - 2629 - 2635 - 2635 A 2636 A - 2828 A 6x6 - 3236 A 3250 A - 3535 /AK - 3850 A 4050 A
SIDEM NR	DESCRIPTION	REMARKS
50884 KIT 50884 KIT SR	repair kit with bearing repair kit without bearing	Ø55/60/76 L = 126
	OE	APPLICATION
	6253300219	1922 - 4050 (lower) also for ACTROS Front Axle BM 731.900/924 1922 AK - 1929 A - 1935 A 2529 - 2629 - 2635 - 2635 A 2636 A - 2828 A 6x6 - 3236 A 3250 A - 3535 /AK - 3850 A 4050 A



MERCEDES KING PIN SETS



SIDEM NR	DESCRIPTION	REMARKS
50786 KIT	repair kit with bearing	Ø50/51 L = 222,5
50786 KIT SR	repair kit without bearing	
	OE	APPLICATION
	3913300019	Front Axle 2032 S 6x2/4
	3915860033	BM 739.034/044/046/050 2033 S LS 6x2/4
	3895860033	BM 739.100/102/104/106/109 2035 S LS 6x2/4 /S 6x2/4
		BM 739.121/130/131/133/134/136 2036 LS 6x2/4
		BM 739.180/182/184/187/189 2219 C 6x2 /C 6x2/4 /CL 6x2 6x2/4
		BM 739.190/197/201/203/204 2220 /L 6x2 /L 6x2/4
		BM 739.181 E -> 061067 2222 L /L 6x2 2222B 6x4 /K 6x4
		1417 OH - 1422 L 2225 2225B /L
		1614 /K1617 C/CK/CL/CS OF 2226 LP 6x2 6x4 LP/LPB/LPK/LPS
		1619 C1620 /L 6x2 /L 6x2 6x4 /LS 6x4 /S 6x4
		1621 OF L/LK/LS 2228 /L/6x2/6x4 /S 6x4
		1622 /K/L/S OH 1624 LS 2232 LP 6x2 LP/LPK/LPS 6x4
		1625 OH /K/L/LS/S 6x2 /L 6x2 6x4 /LS 6x4 /S 6x4
		1626 /K/L/LS/S 2233 S /L 6x2 /S 6x4
		1628 OH /L/LS/S 2235 /L/LS/6x2 /K 6x4
		1632 /K/L/LS/S 2236 /L/S 6x4 2238 /L/S 6x4
		1633 /L/LS/S 2244 LS 6x2 /L 6x2 /S 6x4
		1635 /K/L/LS/S 2422 24252428 /L
		1635 /L/LS 2429 S 6x2/4 /LS 6x2/4 /K/L/S
		1638 /LS/L 2433-2434 2435 LS 6x2/4 /L
		1644 /LS/S 2438 - 24448 /L
		1719 /K/S 2622 2624 L/LB/LK/LS 6x4
		1722 /L/LS 2626 6x4 /B 6x4 K 6x4 /S 6x4
		1728 1729 /K/L/LS/S 2628 L/LK/LS 6x4 /B 6x4 /K 6x4 /S 6x4
		1735 /K/L/LS/S F 2629 /B/K/S
		1748 /L/LS/S 2632 /6x4 /K 6x4 /S 6x4
		1919 /K/S 2633 /S 6x4
		1921 L/LK/LS 2635 /S/K2636 /K/S
		1922 /K/S 2638 /S2644 S 6x42648 S
		1924 L/LK/LS 2822 - 2825 - 2828 - 2833
	1926 LP/LPS /K/S 3025 /B/K	
	1928 L/LK/LS /K/L/LS/S 3028 /B/K	
	1929 /K/L/S 3033 - 3036 - 3038 /L3228 /S 6x4	
	1932 LP/LPS /K/S 325 /B/K/L	
	1933 /LS/S 3236 S 6x4	
	1935 /L/LS/S 3248 - 3328 /B/K	
	1936 /K/LS/S 3328 - 3332 - 3333 - 3335 /K	
	1938 /LS/S 3336 /K/S/ 8x4	
	1944 /LS/S 3338 - 3528 - 3535 /B/K	
	1948 2025 S 6x4 3536 /S - 3544 S	
	2026 S 6x2/4 3636 3828 K 6x43833	
	2028 S/K LS 6x2/4 4435 K - 4436 / 8x4/4	







KING PIN SETS MERCEDES

SIDEM NR	DESCRIPTION	REMARKS		
50788 KIT 50788 KIT SR	repair kit with bearing repair kit without bearing	Ø50 L = 109		
	OE	APPLICATION		
	3463300019 3465860033	ACTROS (1996) (upper) Front Axle BM 739.000/002/004/012/031 BM 739.039/041/050/205/230/231 1626 AK/AS - 1632 AK/AS 1719 AK/AS 1919 AK - 1922 AK - 1926 A/AK/AS 1928 A/AK/AS - 1929 A/AK/AS 1932 A/AK/AS - 1935 AK/AS 1936 AK/AS - 2228 A 2428 A -2528 A/AK 2529 A - 2536 AK 2626 A/ 6x6 A/AB/AK/AS 2628 A/ 6x6 A/AK/AS 2629 A/AK/AS - 2632 A/AK/AS 6x6 2635 A/AK/AS - 2636 A/AK/AS 6x6 3036 AK 3236 A 6x6 3250 AF 6x6 - 3328 A - 3335 A 3336 A - 3535 A/AK -3850 A 6x6 4050 A 8x8/4 - 4436 AK		
SIDEM NR	DESCRIPTION	REMARKS		
50881 KIT 50881 KIT SR	repair kit with bearing repair kit without bearing	Ø50/64 L = 119		
	OE	PERIOD	AXLE	APPLICATION
	3463300119 3465860133	ACTROS (1996) (lower) Front Axle BM 739.000/002/004/012/031 BM 739.039/041/050/205/230/231 1626 AK/AS - 1632 AK/AS 1719 AK/AS 1919 AK - 1922 AK - 1926 A/AK/AS 1928 A/AK/AS - 1929 A/AK/AS 1932 A/AK/AS - 1935 AK/AS 1936 AK/AS - 2228 A 2428 A -2528 A/AK 2529 A - 2536 AK 2626 A/ 6x6 A/AB/AK/AS 2628 A/ 6x6 A/AK/AS 2629 A/AK/AS - 2632 A/AK/AS 6x6 2635 A/AK/AS - 2636 A/AK/AS 6x6 3036 AK 3236 A 6x6 3250 AF 6x6 - 3328 A - 3335 A 3336 A - 3535 A/AK -3850 A 6x6 4050 A 8x8/4 - 4436 AK		



MERCEDES KING PIN SETS



SIDEM NR	DESCRIPTION	REMARKS
50782 KIT 50782 KIT SR	repair kit with bearing repair kit without bearing	50/51,5 L = 223
OE		APPLICATION
	6553300019 ACTROS	
SIDEM NR	DESCRIPTION	REMARKS
50783 KIT 50783 KIT SR	repair kit with bearing repair kit without bearing	50/51,5 L = 223
OE		APPLICATION
	6553300119 ACTROS	
SIDEM NR	DESCRIPTION	REMARKS
50784 KIT 50784 KIT SR	repair kit with bearing repair kit without bearing	50/51,5 L = 223
OE		APPLICATION
	6553300619 ACTROS	





TRACK RODS MERCEDES

TYPES	Oe nr.	Dimensions	Drawing
SIDEM NR: 50130			
ACTROS 1996 1831 AK, K, L, LS, S - 1835 AK, K, L, LS, S - 1840 AK, K, L, LS, S - 1843 AK, K, L, LS, S - 1848 AK, K, L, LS, S - 1853 L, LS, S - 1857 L, LS - 2031 AK, K, S - 2040 AK, S - 2053 S - 2531 L, LS - 2535 L, LS - 2540 L, LS - 2543 L, LS - 2548 L, LS - 2553 L, LS - 2557 L - 2631 B, K, L - 2635 B, K, L - 2640 B, K, L, LK, LS, S - 2643 B, K, L, LK, LS, S - 2648 K, L, LK, LS, S - 2653 K, L, LK, LS, S - 2657 K, L, LK, S - 3231 K - 3235 K - 3240 K - 3243 K - 3331 AK, B, K, S - 3335 B, K, S - 3340 AK, B, K, S - 3343 AK, K, S - 3348 AK, K, S - 3353 S - 3357 S - 4140 AK, B, K, K - 4143 AK, K, K - 4148 AK, K, K - 521831 ACTROS 2003 1832 L, LL - 1836 L, LL - 1841 L, LL - 1844 L, LL - 1846 L, LL - 2632 LS - 2636 LS - 2641 S, LS - 2644 S, LS - 2650 S, LS - 2654 S, LS ATEGO II 1823 L - 1828 L - 2523 L - 2528 L ECONIC 2628 - 1823 LL - 1828 LL - 2628 LL	945 330 0203 945 330 0303 945 330 0503	L= 1465 Ø=40	
SIDEM NR: 50034			
ACTROS 1996 1831 AK, K, LS, S - 1835 AK, K, L, LS, S - 1840 AK, K, L, LS, S - 1843 AK, K, L, LS, S - 1848 AK, K, L, LS, S - 1853 L, LS, S - 1857 L, LS - 2031 AK, K, S - 2040 AK, S - 2053 S - 2531 L, LS - 2535 L, LS - 2540 L, LS - 2543 L, LS - 2548 L, LS - 2553 L, LS - 2557 L - 2631 B, K, L - 2635 B, K, L - 2640 B, K, L, LK, LS - 2643 B, K, L, LK, LS, S - 2648 K, L, LK, LS, S - 2653 K, L, LK, LS, S - 2657 K, L, LK, S - 3231 K - 3235 K, S - 3240 K - 3243 K - 3331 AK, B, K, S - 3335 B, K, S - 3340 AK, B, K, S - 3343 AK, K, S SK 2648 S - 2650 S - 3229 B, K - 3233 B, K - 3234 B, K - 3550 S	942 330 0503 942 330 0603 942 330 0903	L= 1565 Ø=50	
SIDEM NR: 50337			
ATEGO 1017 A, K, K, KO - 1023 - 1215 - 1217 - 1223 - 1228 - 1712 - 1714 - 715 - 1717 - 1812 - 1815 F - 815 K, K - 817 K, K - 823 K - 917 K - 923 K - 1017 L - 1023 L - 1215 L - 1217 L - 1223 L - 1228 L - 715 L - 815 L, L - 817 L, L - 823 L - 917 L - 923 L	970 330 0003 970 330 0103 970 330 0203 970 330 0303	L= 1640 Ø=40	

MERCEDES TRACK RODS



TYPES	Oe nr.	Dimensions	Drawing
SIDEM NR: 50338			
ACTROS 1996	942 330 0803	L= 1735	
1831 K, L, LS, S - 1835 K, L, LS, S -	949 330 0203	Ø=50	
1840 K, L, LS, S - 1843 K, L, LS, S -	949 330 0903		
1848 K, L, LS, S - 1853 L, LS, S - 1857			
L, LS - 2031 K, S - 2040 S - 2053 S -			
2531 L - 2535 L, LS - 2540 L - 2543 L -			
2548 L - 2553 L - 2557 L - 2631 B, K, L -			
2635 B, K, L - 2640 B, K, L, LK, LS, S -			
2643 B, K, L, LK, LS, S - 2648 K, L, LK,			
LS, S - 2653 K, L, LK, LS, S - 2657 K, L,			
LK, S - 3231 B, K - 3235 B, K - 3240 B,			
K - 3243 B, K - 3331 B, K, S - 3335 B, K,			
S - 3340 B, K, S - 3343 K, S - 3348 K, S -			
3353 S - 3357 S - 4140 B, K, K - 4143 K,			
K - 4148 K, K - 521831			
ACTROS 2003			
1832 - 1832 LS - 1832 L, LL - 1836 LS -			
1836 L, LL - 1841 L, LL - 1844 LS -			
1844 L, LL - 1846 LS - 1846 L, LL -			
1850 LS - 1850 L, LL - 1854 L - 1858 L -			
2032 A - 2632 K - 2632 LS - 2636 L -			
2641 K - 2641 S, LS - 2641 L - 2644 K -			
2644 S, LS - 2644 L - 2646 K - 2646 S,			
LS - 2646 L - 2650 K - 2650 S, LS -			
2650 L - 2654 K - 2654 S, LS - 2654 L -			
2658 K - 2658 L - 2658 LS			
ATEGO II			
1823 - 1828 - 2628 - 1823 K - 1823 L -			
1823 LS - 1828 K - 1828 L - 1828 LS -			
2528 L - 2628 B - 2628 K			
MK			
1420 LS - 1422 F - 1422 L - 1424 L -			
1424 LS - 1424 S - 1717 L - 1720 L -			
1722 L - 1726 L - 1726 L - 1733 L -			
1820 L - 1824 L - 1827 L - 1831 L -			
1834 L - 2433 L - 2527 L - 2531 L -			
2534 L			
NG			
2636 - 3235 - 3336 - 1622 L - 2222 L -			
2628 A - 3535 AK			
SK			
1729 K, L, S - 1735 K, L, S - 1748 L, S -			
1831 K, L, S - 1834 L, S - 1838 AK, K, L,			
S - 1840 LS - 1844 L, S - 1850 L, S -			
1853 AK, L, S - 1922 K, S - 1929 A, AS,			
K, L, S - 1935 K, S - 1948 - 2024 K -			
2031 K, S - 2038 S - 2044 S - 2050 S -			
2429 K, L, LS, S - 2435 K, L, LS, S -			
2448 L, LS, S - 2538 K, LK - 2544 -			
2550 - 2553 - 2629 - 2631 B, S - 2635 -			
2638 L - 2644 L, S - 2648 S - 2650 L, S -			
3235 K - 3238 L - 3253 L			

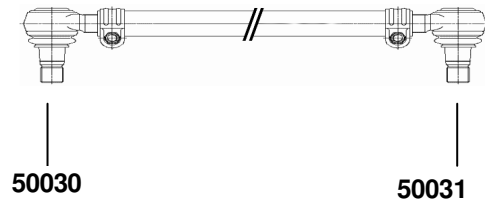



TRACK RODS MERCEDES

TYPES	Oe nr.	Dimensions	Drawing
SIDEM NR: 50131			
ACTROS 1996 1831 AK, K, S - 1835 AK, K, S - 1840 AK, K, S - 1843 AK, K, S - 1848 AK, K, S - 1853 S - 1857 L, LS - 2031 AK, K, S - 2040 AK, S - 2053 S - 2531 L, LS - 2535 L, LS, LS - 2540 L, LS - 2543 L, LS - 2548 L, LS - 2553 L, LS - 2557 L - 2631 B, K, L - 2635 B, K, L - 2640 B, K, L, LK, LS, S - 2643 B, K, L, LK, LS, S - 2648 K, L, LK, LS, S - 2653 K, L, LK, LS, S - 2657 K, L, LK, S - 3231 K - 3235 K - 3240 K - 3243 K - 3331 AK, B, K, S - 3335 B, K, S - 3340 AK, B, K, S - 3343 AK, K, S	941 330 0003 941 330 0103 941 330 0203	L= 1735 Ø=50	<p>50030</p> <p>50031</p>
ACTROS 2003 1850 L, LL, LS - 1854 L, L, LL - 1858 L - 2032 A - 2632 K, LS - 2636 K, L, LS - 2641 K, L, S - 2644 K, L, S - 2646 K, L, S - 2650 K, L, S - 2654 K, L, S - 2658 K, L, LS			
ATEGO II 1823 LS, K, L, LS - 1828 LS, K, L, LS - 2528 L, L - 2628 K, B, K			
AXOR 1835 LS - 1840 LS - 1843 LS - 2523 K - 2528 - 2535 LS - 2540 LS - 2543 LS - 2623 L - 2628 B, K, L - 3228			
ECONIC 2628			





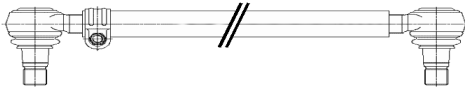

MERCEDES TRACK RODS



TYPES	Oe nr.	Dimensions	Drawing
SIDEM NR: 50334			
ACTROS 1996 1831 AK, K, S - 1831 LS - 1835 AK, K, S - 1835 LS, L - 1840 AK, K, S - 1840 LS, L - 1843 AK, K, S - 1843 LS, L - 1848 AK, K, S - 1848 LS, L - 1853 S - 1853 LS, L - 1857 L, LS - 2031 AK, K, S - 2040 AK, S - 2053 S - 2531 LS - 2531 L - 2535 L, LS, LS - 2540 LS - 2540 L - 2543 LS - 2543 L - 2548 LS - 2548 L - 2553 LS - 2553 L - 2557 L - 2631 B, K - 2631 L - 2635 B, K - 2635 L - 2640 B, K, S - 2640 LK, LS, L - 2643 B, K, S - 2643 LK, LS, L - 2648 K, S - 2648 LK, LS, L - 2653 K, S - 2653 LK, LS, L - 2657 K, L, S - 2657 LK - 3231 K - 3235 K - 3240 K - 3243 K - 3331 AK, B, K, S - 3335 B, K, S - 3340 AK, B, K, S - 3343 AK, K, S ACTROS 2003 1850 LS, L, LL - 1854 L, L, LL - 1858 L - 2032 A - 2632 K, LS - 2636 K, LS, L - 2641 K, S, LS, L - 2644 K, S, LS, L - 2646 K, S, LS, L - 2650 K, S, LS, L - 2654 K, S, LS, L - 2658 K, L, LS ATEGO II 1828 - 2628 - 1823 K, L, LS - 1828 K, L, LS - 2523 L - 2528 L - 2628 B, K AXOR 1823 - 2523 - 2528 - 3228 - 1835 LS - 1840 LS - 1843 LS - 2535 LS - 2540 LS - 2543 LS - 2623 L - 2628 L ECONIC 2628	942 330 0003 942 330 0103 942 330 0203 942 330 0703	L= 1735 Ø=52	 <p style="text-align: right;">50030</p>
SIDEM NR: 50339			
ACTROS 1996 1831 S - 1835 - 1840 - 1843 - 2531 - 2540 - 2543 - 1831 - 1831 L, LS - 1835 - 1835 - 1835 L, LS, S - 1840 - 1840 - 1840 L, LS, S - 1843 - 1843 - 1843 L, LS, S - 2531 - 2531 L, LS - 2535 - 2535 L, LS - 2540 LS - 2543 LS - 2548 LS - 2553 LS ACTROS 2003 1832 LS, LLS, L, LL - 1836 LS, LLS, L, LL - 1841 LS, LLS, L, LL - 1844 LS, LLS, L, LL - 1846 LS, L - 2632 LS - 2636 LS - 2641 S, LS - 2644 S, LS - 2650 S, LS - 2654 S, LS ATEGO II 2523 L - 2528 L - 1823 L - 1828 L ECONIC 1823 LL - 1828 LL - 2628 LL	945 330 0003 945 330 0103 945 330 0403 945 330 0603	L= 1745 Ø=62	 <p style="text-align: left;">50634</p>

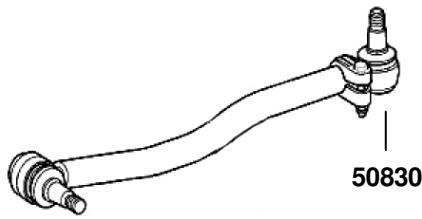

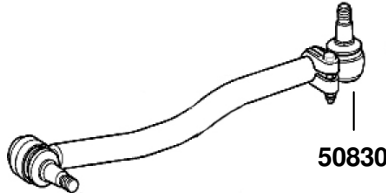

TYPES	Oe nr.	Dimensions	Drawing
SIDEM NR: 50533			
ATEGO 823 - 923 - 1017 - 1023 - 1215 - 1217 - 1223 - 1228 - 1317 - 1323 - 1328 - 1517 - 1523 - 1528 - 1712 - 1715 - 1812 - 1815 - 1817 - 1917 - 1017 A, K, K, KO, L - 1023 L - 1215 L - 1217 L - 1223 L - 1228 L - 1317 A, L - 1323 L - 1328 L - 1517 A, L - 1523 L - 1528 L - 1815 K - 1817 K - 1917 K - 715 L - 815 L, L - 817 L, L - 823 K, L - 917 L - 923 K, L - 1523 A	972 460 1405 972 460 1605	L= 837 Ø=40	
SIDEM NR: 50534			
ATEGO 917 - 923 - 1017 - 1023 - 1215 - 1217 - 1223 - 1228 - 1317 - 1323 - 1328 - 1017 K, K, KO - 1215 K - 1217 K, KO - 1317 K, KO - 1323 KO, LS - 1325 F - 1328 F, LS - 917 K, L - 923 K, L - 1225 F	972 460 1805 972 460 2005	L= 837 Ø=40	
SIDEM NR: 50432			
ATEGO 715 - 815 - 823 - 923 - 1017 - 1023 - 1215 - 1217 - 1223 - 1228 - 1317 - 1323 - 1328 - 1517 - 1523 - 1528 - 1712 - 1714 - 1717 - 1812 - 1017 A - 1317 A - 1517 A - 1815 F - 715 L - 817 - 815 K, K, L, L - 817 K, K, L, L - 823 K, L - 917 L - 923 L - 1523 A	970 460 0705 970 460 0905	L= 846 Ø=42	
SIDEM NR: 50730			
MK 1222, 1417/22/24/26, 1717/22, 1820 NG 1626/28/32/33/35/36/38/44, 1719, 1919/22/26/28/32/35/36/44, 2026/28/32/35/36, 2226/28/32/33/35/36/38/44, 2433/38, 2626/28/32/33/35/36/38/44, 3028/33/36/38, 3235/50, 3333/35/44/50 SK 1729/35/48, 1831/1834/38/40/44/50/53, 1922/29/35/48, 2024/31/38/44/50, 2429/35/48 2538/44/50/53, 2629/31/35/38	647 460 0105 647 460 0005	L=865 Ø=40	



TYPES	Oe nr.	Dimensions	Drawing
SIDEM NR: 50638			
ACTROS 1996 1831 AK, K, L, LS, S - 1835 AK, K, L, LS, S - 1840 AK, K, L, LS, S - 1843 AK, K, L, LS, S - 1848 AK, K, L, LS, S - 1853 L, LS, S - 1857 L, LS - 2031 A, AK, AS, K, S - 2035 A - 2040 AK, AS, S - 2053 S - 2531 L, LS - 2535 L, LS - 2540 L, LS - 2543 L, LS - 2548 L, LS - 2553 L, LS - 2557 L - 2631 K, L - 2635 K, L - 2640 K, L, LK, LS, S - 2643 K, L, LK, LS, S - 2648 K, L, LK, LS, S - 2653 K, L, LK, LS, S - 2657 K, L, LK, S - 3231 K - 3235 K - 3240 K - 3243 K - 3331 A, AK, AS, K, S - 3335 K, S - 3340 A, AK, AS, K, S - 3343 AK, AS, K, S - 3348 AK, AS, K, S - 3353 AS, S - 3357 S - 4140 AK, B, K, K - 4143 AK, K, K - 4148 AK, K, K	001 460 9805 001 460 9905	L= 866 Ø=38	
SIDEM NR: 50637			
ACTROS 1996 1835 - 1840 - 1843 - 1848 - 1853 - 2031 - 2040 - 2531 - 2540 - 2543 - 2548 - 2553 - 2631 - 2635 - 2640 - 2643 - 521831 - 1831 K, L, LS, S - 1835 K, L, LS, S - 1840 K, L, LS, S - 1843 K, L, LS, S - 1848 K, L, LS, S - 1853 L, LS, S - 1857 L, LS - 2031 A, AS, K, S - 2035 A - 2040 AS, S - 2053 S - 2531 L, LS - 2535 L, LS, LS - 2540 L, LS - 2543 L, LS - 2548 L, LS - 2553 L, LS - 2557 L - 2631 B, K, L - 2635 B, K, L - 2640 B, K, L, LK, LS, S - 2643 B, K, L, LK, LS, S - 3353 S - 3357 S ACTROS 2003 1832 L, LL, LS - 1836 L, LL, LS - 1841 L, LL - 1844 L, LL, LS - 1846 L, LL, LS - 1850 L, LL, LS - 1854 L, LL - 1858 L - 2032 A - 2632 K, LS - 2636 K, L, LS - 2641 K, L, S, LS - 2644 K, L, S, LS - 2646 K, L, S, LS - 2650 K, L, S, LS - 2654 K, L, S, LS - 2658 K, L, LS ATEGO II 1823 K, L, LS - 1828 K, L, LS - 2523 L - 2528 L - 2628 B, K AXOR 1823 - 2523 - 2528 - 3228 - 1835 LS - 1840 LS - 1843 LS - 2535 LS - 2540 LS - 2543 LS - 2623 L - 2628 L ECONIC 2628	000 460 9305 001 460 6905	L= 873 Ø=40	



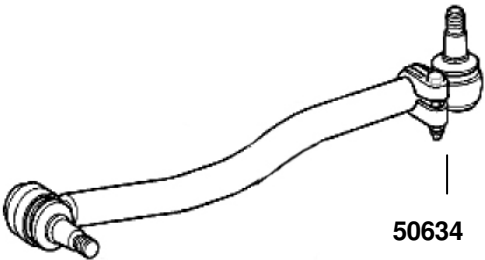

TYPES	Oe nr.	Dimensions	Drawing
SIDEM NR: 50736			
ACTROS 1996 1835 - 1840 - 1843 - 1848 - 1853 - 2031 - 2040 - 2531 - 2540 - 2543 - 2548 - 2553 - 2631 - 2635 - 2640 - 3353 - 521831 - 1831 K, L, LS, S - 1835 K, L, LS, S - 1840 K, L, LS, S - 1843 K, L, LS, S - 1848 K, L, LS, S - 1853 L, LS, S - 1857 L, LS - 2031 A, AS, K, S - 2035 A - 2040 AS, S - 2053 S - 2531 L, LS - 2535 L, LS - 2540 L, LS - 2543 L, LS - 2548 L, LS - 2553 L, LS - 2557 L - 2631 B, K, L - 2635 B, K, L - 2640 B, K, L, LK, LS, S - 2643 B, K, LK - 3353 AS, S - 3357 S	002 460 4705 002 460 4805	L= 876 Ø=40	
ACTROS 2003 1832 LS, L, LL - 1836 LS, L, LL - 1841 L, LL - 1844 LS, L, LL - 1846 LS, L, LL - 1850 LS, L, LL - 1854 L, LL - 1858 L - 2032 A - 2632 K, LS - 2636 K, LS, L - 2641 K, S, LS, L - 2644 K, S, LS, L - 2646 K, S, LS, L - 2650 K, S, LS, L - 2654 K, S, LS, L - 2658 K, L, LS			
ATEGO II 1823 K, LS - 18231823 L - 1828 K, LS - 18281828 L - 2528 L - 2628 B, K			
AXOR 1823 - 2523 - 2528 - 3228 - 1835 LS - 1840 LS - 1843 LS - 2535 LS - 2540 LS - 2543 LS - 2623 L - 2628 L			
ECONIC 2628			





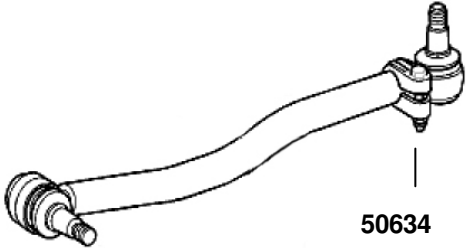

TYPES	Oe nr.	Dimensions	Drawing
SIDEM NR: 50735			
ACTROS 1996 1831 AK, K, L, LS, S - 1835 AK, K, L, LS, S - 1840 AK, K, L, LS, S - 1843 AK, K, L, LS, S - 1848 AK, K, L, LS, S - 1853 L, LS, S - 1857 L, LS - 2031 A, AK, AS, K, S - 2035 A - 2040 AK, AS, S - 2053 S - 2531 L, LS - 2535 L, LS - 2540 L, LS - 2543 L, LS - 2548 L, LS - 2553 L, LS - 2557 L - 2631 B, K, L - 2635 B, K, L - 2640 B, K, L, LK, LS, S - 2643 B, K, L, LK, LS, S - 2648 K, L, LK, LS, S - 2653 K, L, LK, LS, S - 2657 K, L, LK - 3331 A, AK, AS, B, K, S - 3335 B, K, S - 3340 A, AK, AS, B, K, S - 3343 AK, AS, K, S - 3348 AK, AS, K, S - 3353 AS, S - 3357 S - 4140 AK, B, K - 4143 AK, K - 4148 AK, K - 521831 ACTROS 2003 1832 LS, L, LL - 1836 LS, L, LL - 1841 L, LL - 1844 LS, L, LL - 1846 LS, L, LL - 1850 LS, L, LL - 1854 L, L, LL - 1858 L - 2032 A - 2632 K, LS - 2636 K, LS, L - 2641 K, S, LS, L - 2644 K, S, LS, L - 2646 K, S, LS, L - 2650 K, S, LS, L - 2654 K, S, LS, L - 2658 K, L, LS ATEGO II 1823 L - 1828 L	002 460 4305 002 460 4405	L= 879 Ø=36	 <p>50634</p>



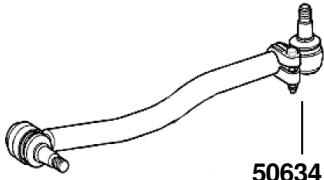

TYPES	Oe nr.	Dimensions	Drawing
SIDEM NR: 50636			
ACTROS 1996 1835 - 1840 - 1843 - 1848 - 1853 - 2031 - 2040 - 2531 - 2540 - 2543 - 2548 - 2553 - 2631 - 2635 - 2640 - 2643 - 2648 - 2653 - 3335 - 3340 - 3343 - 3348 - 3353 - 3357 - 521831 - 1831 AK, K, L, LS, S - 1835 AK, K, L, LS, S - 1840 AK, K, L, LS, S - 1843 AK, K, L, LS, S - 1848 AK, K, L, LS, S - 1853 L, LS, S - 1857 L, LS - 2031 A, AK, AS, K, S - 2035 A - 2040 AK, AS, S - 2053 S - 2531 L, LS - 2535 L, LS, LS - 2540 L, LS - 2543 L, LS - 2548 L, LS - 2553 L, LS - 2557 L - 2631 B, K, L - 2635 B, K, L - 2640 B, K, L, LK, LS, S - 2643 B, K, L, LK, LS, S - 2648 K, L, LK, LS, S - 2653 K, L, LK, LS, S - 2657 K, L, LK - 3331 A, AK, AS, B, K, S - 3335 B, K, S - 3340 A, AK, AS, B, K, S - 3343 AK, AS, K, S - 3348 AK, AS, K, S - 3353 AS, S - 3357 S - 4140 AK, B, K, K - 4143 AK, K, K - 4148 AK, K, K ACTROS 2003 1832 - 1832 LS, L, LL - 1836 LS, L, LL - 1841 L, LL - 1844 LS, L, LL - 1846 LS, L, LL - 1850 LS, L, LL - 1854 L, LL - 1858 L - 2032 A - 2632 K, LS - 2636 K, LS, L - 2641 K, S, L - 2644 K, S, L - 2646 K, S, L - 2650 K, S, L - 2654 K, S, L - 2658 K, L, LS ATEGO II 1823 - 1828 - 2628 - 1823 K, L, LS - 1828 K, L, LS - 2523 L - 2528 L - 2628 B, K AXOR 1835 LS - 1840 LS - 1843 LS - 2535 LS - 2540 LS - 2543 LS ECONIC 1823 LL, 1828 LL, 2628 LL	000 460 7105 001 460 6705	L= 879 Ø=42	
SIDEM NR: 50731			
NG 1626/28/32/33/35/36/38/44 1719, 1922/26/28/32/33/35/36/38/44 2028/33/35/36/38/44 2238/44, 2433/38, 2626/28/32/33/35/36/38/44 3028/33/36/38, 3235/50, 3333/35/44/50 SK 1729/35/48, 1831/1834/38/40/44/50/53, 1922/29/35/48, 2024/31/38/44/50, 2429/35/48 2538/44/50/53, 2629/31/35/38/44/48/50, 3238/50/53	620 460 3705 620 460 2805	L=885 Ø=40	

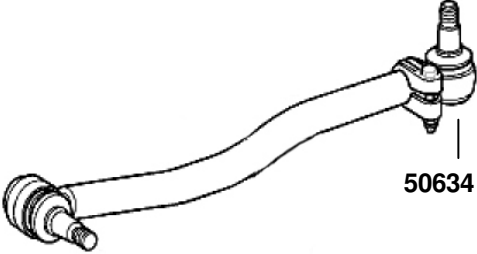

TYPES	Oe nr.	Dimensions	Drawing
SIDEM NR: 50639			
ACTROS 1996 1831 K, L, LS, S - 1835 AK, K, L, LS, S - 1840 AK, K, L, LS, S - 1843 AK, K, L, LS, S - 1848 AK, K, L, LS, S - 1853 L, LS, S - 1857 L, LS - 2031 A, AK, AS, K, S - 2035 A - 2040 AK, AS, S - 2053 S - 2531 L, LS - 2535 L, LS - 2540 L, LS - 2543 L, LS - 2548 L, LS - 2553 L, LS - 2557 L - 2631 B, K, L - 2635 B, K, L - 2640 B, K, L, LK, LS, S - 2643 B, K, L, LK, LS, S - 2648 K, L, LK, LS, S - 2653 K, L, LK, LS, S - 2657 K, L, LK - 3331 A, AK, AS, B, K, S - 3335 B, K, S - 3340 A, AK, AS, B, K, S - 3343 AK, AS, K, S - 3348 AK, AS, K, S - 3353 AS, S - 3357 S - 4140 AK, B, K, K - 4143 AK, K, K - 4148 AK, K, K - 521831	001 460 0705 001 460 0805	L= 888 Ø=38	 <p style="text-align: right;">50634</p>
SIDEM NR: 50733			
NG 1013/17/19, 1213/17/19/ 1413/17/19/24 1613/17/19/24 2219/24	383 460 4405 383 460 2305	L=890 Ø=40	 <p style="text-align: right;">50830</p>
SIDEM NR: 50535			
ATEGO 715 L - 815 L - 817 L - 823 L - 1225 F - 1228 L - 1317 K, KO, L - 1323 KO, L, LS - 1325 F - 1328 F, L, LS - 1517 K, L - 1523 K, KO, L - 1528 F, L	974 460 1005 974 460 1205	L= 894 Ø=50	 <p style="text-align: right;">50634</p>





TIE ROD ENDS MERCEDES

type	Sidem	OE nr	A	B	C
Actros 1996, SK part of 50034 Actros , Atego II, Econic part of 50130 Actros , Atego II, Axor, Econic part of 50131 Actros , Atego II, Axor, Econic part of 50334 Actros , Atego II, MK, MG, SK part of 50338	50030	0004606848	120	-	M30x1,5 rht M
Actros 1996, SK part of 50034 Actros , Atego II, Econic part of 50130 Actros , Atego II, Axor, Econic part of 50131 Actros , Atego II, MK, MG, SK part of 50338	50031	0004606948	120	-	M30x1,5 lht M
Different types	50538	0003300335 0003300635 0003302410 0003308535 0003308735 0004633229	95	-	M24x1,5 rht M
Different types	50539	0003300235 0003300735 0003308635 0003308835	95	-	M24x1,5 lht M
Actros, Atego II, Econic part of 50339 Atego part of 50534 Atego part of 50535 Actros, Atego II, Axor, Econic part of 50636 Actros, Atego II, Axor, Econic part of 50637 Actros 1996 part of 50638	50634	0014602948	145	-	M30x1,5 rht M
Different types	50832	0003301435 0003301535 0003307135 0003309335 0003309535 0003382129 0003383629	105	-	M28x1,5 rht M
Different types	50833	0003303335 0003307235 0003309435 0003309635	105	-	M28x1,5 lht M
Different types	50830	0003300248 0003303235 0003305835 0003307335 0003383410 0004633429 0004633529 0013300135 0013300235 0014603448	115	-	M30x1,5 rht M



MERCEDES TIE ROD ENDS



type	Sidem	OE nr	A	B	C
Different types	50831	0003300148 3023300035 3023300135 3023300235 3023300335	115	-	M30x1,5 lht M
Different types	50630	0004600348 0004601048 0004602848 0004602948 0014600848 0014601248 0014602248 0014608948	120	-	M30x1,5 rht M
Different types	50631	0004600648 0004601248 0004603448 0004603548 0014601448 0014602348 0014603748	120	-	M30x1,5 rht M
Different types	50633	0004600148 0004602648 0004602748	120	-	M30x1,5 lht M
Different types	50635	0013301835	120	-	M38x1,5 rht M
type	Sidem	OE nr	Length	Height	Dimensions
Gear box control lever					
	50930	0002684689 0002686289	55	-	M12x1,75 rht
	50931	0002684789 0002686189	55	-	M12x1,75 lht





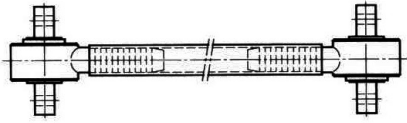
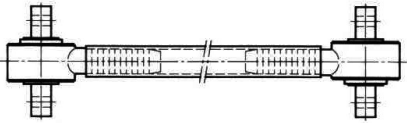
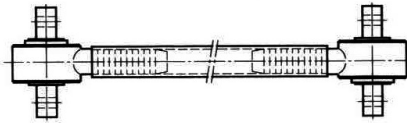
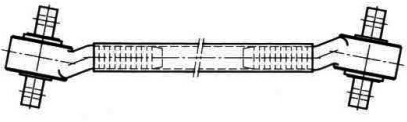
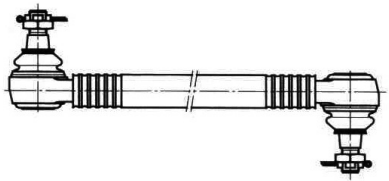

TORQUE RODS MERCEDES

Types	OE nr	Dimensions	Drawing
SIDEM NR: 50046			
2626	3953200132	568 mm	
SIDEM NR: 50041			
2628	3953500006 6593501106	575 mm	
SIDEM NR: 50144			
1626 1628 1632	3933200132 6553500006 6563500006 6583500006 6583500206	585 mm	
SIDEM NR: 50040			
2628 <i>Remark for rod: Head incl. 5°</i>	2953500706 6593500406	585 mm	
SIDEM NR: 50142			
	3933200132	585 mm	



MERCEDES TORQUE RODS

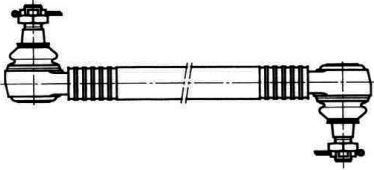

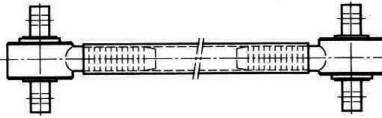
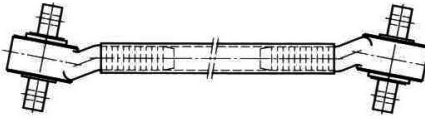
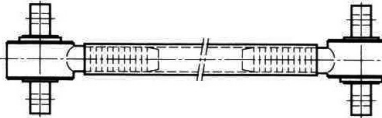
Types	OE nr	Dimensions	Drawing
SIDEM NR: 50044			
1813 1817 1819 2219 2220 2620 2622 2623 2624	3433201732	595 mm	
SIDEM NR: 50045			
2220 2620 2622 2623 2624	3433201632	595 mm	
SIDEM NR: 50047			
2626	3813500206	595 mm	
SIDEM NR: 50048			
Air suspension 1935	6203500006 6203500106	595 mm	
SIDEM NR: 50141			
	3953200332	610 mm	



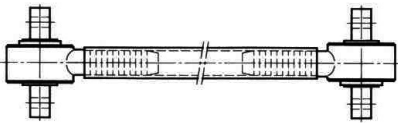
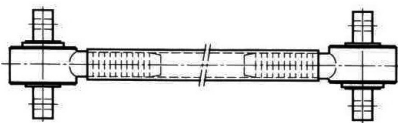
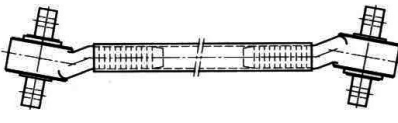
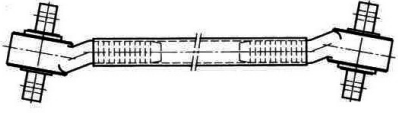
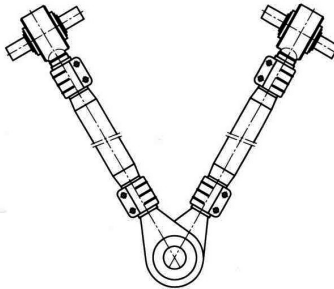

TORQUE RODS MERCEDES

Types	OE nr	Dimensions	Drawing
SIDEM NR: 50140			
	3893200832	614 mm	
SIDEM NR: 50146			
	3933200232	627 mm	
SIDEM NR: 50043			
2226 2232 2626 2632 3332	3953201532	630 mm	
SIDEM NR: 50042			
2626 2628 2632	3953201432	638 mm	
TRIANGLE RODS			
SIDEM NR: 50049			
1626 1628 1632 1011 3250 L/LS 1935 1944 Remark for rod: V-stay	3933505405 3933505505 6553500305 6583500005	625 mm	





Types	OE nr	Dimensions	Drawing
Repair kits for Torque rods			
SIDEM NR: 50341			
	000 338 38 10		
SIDEM NR: 50543			
NG	000 350 02 13		
SIDEM NR: 50444			
SK 1729/35/48, SK 1831/34/38/40/44/50/53, SK 2429/35/48, SK 2538/44, SK 2550/53, 2650, 3253	000 350 17 05		
SIDEM NR: 44249			
	000 330 14 11	Ø67 x 100 x Ø17	
SIDEM NR: 50545			
O 404, O 405	000 350 10 05	Ø67 x 115 x Ø15	





TORQUE ROD REPAIR KITS

MERCEDES

Types	OE nr	Dimensions	Drawing
SIDEM NR: 50447			
O 404, O 405	000 350 13 05	Ø75 x 130 x Ø17	
SIDEM NR: 14440			
O 405	000 330 02 07	Ø75 x 130 x Ø19	
SIDEM NR: 50448			
Actros Atego II Axor Econic	000 350 22 05	Ø75 x 130 x Ø25	
SIDEM NR: 50544			
Actros, Atego II, Axor, Econic MK 1827, 2433, 2524, 2527 MK 2531/34, NG 1922, 2228, NG 2233/35/36/38/44, NG 2433/38, NG 2628/33/35/36/38/44, NG 3028/33/36/38, NG 3235,3335,3544, O 405, SK 1929, 2435, 2538, SK 2638/44/48/50, SK 3538/53	000 350 21 05	Ø75 x 152 x Ø25	
SIDEM NR: 50446			
O 305, O 307, O 405, O 407, O 408	000 330 00 75	Ø85 x 130 x Ø16	





Types	OE nr	Dimensions	Drawing
SIDEM NR: 14246			
	000 330 07 07	Ø85 x 130 x Ø19	
SIDEM NR: 50244			
LP, MK, NG, SK 1617/19/24/16/28/32/33/35/36,1638/44, 1722/26/29/33/35/48, 1926/28/29/32/33/35/36/38/44, 2028/2033/2035/2036, 2219, 2220/22/25/26/28/32/33/35,2236/38/44, 2429/35/48, 3025/28, 3228, 3235	000 350 06 13 000 586 11 35	Ø85 x 152 x Ø21	
SIDEM NR: 50449			
Actros Atego II Econic	000 350 06 13 000 586 11 35	Ø85 x 152 x Ø25	
SIDEM NR: 50542			
	942 326 00 50	Ø88 x 130 x Ø20,5	
SIDEM NR: 50541			
O 404, O 405	000 350 09 05	Ø95	





TORQUE ROD REPAIR KITS

MERCEDES

Types	OE nr	Dimensions	Drawing
SIDEM NR: 50241			
NG, SK 1017,1217,1418/20/22/24/25, 1613/17/19/20/22/24/25/26, 1628/32/33/35/36/38/44, 1722/26/29/33/35/48, 1926/28/29/32/33/35/36/38, 1944, 2028/33/36, 2219/20/22, 2225/26/28/32/33/35/36/38, 2244, 2425/28/29/35/48/ 2538/50, 3038	000 350 04 13 000 586 12 35	Ø95 x 152 x Ø21	
SIDEM NR: 50445			
	000 150 01 13	Ø108 x 152 x Ø21	
Repair kits for Torque rod ball			
SIDEM NR: 50441			
MK, NG 1017/1419/1424/1613/1617/1619/ 1624/1717/1720/1722/1726/1727/ 1729/1732/1733/1734/1820/1824/ 1827/1831/1834/2420/2422/2426/ 2427/2433/2434/2522/2524/2527/ 2531/2534/3231/3234 Grease included	000 350 02 05		
SIDEM NR: 50442			
NG 1017/1217/1419/1420/1422/1424/1425/ 1613/1617/1622/1624/1625/1628/1733/ 2219/2220/2222/2225/2228/2425/2428/ 2432/2433 Grease included	000 586 10 35		
SIDEM NR: 50443			
Grease included	000 350 15 05		



MERCEDES TORQUE ROD REPAIR KITS





Types	OE nr	Dimensions	Drawing
SIDEM NR: 50242			
<i>Grease included</i>	000 350 14 05		
SIDEM NR: 50440			
MK, NG, SK 1017,1217,1418/20/22/24/25, 1613/17/19/20/22/24/25/26, 1628/32/33/35/36/38/44, 1722/26/29/33/35/48, 1926/28/29/32/33/35/36/38, 1944, 2028/33/36, 2219/20/22, 2225/26/28/32/33/35/36/38, 2244, 2425/28/29/35/48/ 2538/50, 3038	000 350 04 05 000 586 19 33 000 586 18 33 000 586 01 35		
<i>Grease included</i>			
SIDEM NR: 50248			
<i>Grease included</i>	343 586 00 32 000 586 16 33		
SIDEM NR: 50343			
1017, 1217, 1419/20/22/24/25, 1613/17/19/20/22/24/25/26/28, 1632/33/35/36/38/44, 1722/26/29/33/35/48, 1926/28/29/32/33/35/36/38/44 2028/33/36, 2219/20/22/25 2226/28/32/33/35/36/38/44/ 2425/28/29/35/36/38/44	000 586 06 32		
<i>Grease included</i>			
SIDEM NR: 50247			
LK, NG, SK 1617/19/24/16/28/32/33/35/36 1638/44, 1722/26/29/33/35/48, 1926/28/29/32/33/35/36/38/44, 2028/2033/2035/2036, 2219, 2220/22/25/26/28/32/33/35, 2236/38/44, 2429/35/48, 3025/28, 3228, 3235	000 586 15 33		
<i>Grease included</i>			









TORQUE ROD REPAIR KITS

MERCEDES

Types	OE nr	Dimensions	Drawing
SIDEM NR: 50249 <i>Grease included</i>	000 586 01 32		
SIDEM NR: 50540 <i>Grease included</i>	000 586 07 32		
SIDEM NR: 50246 LP, MK, NG, SK <i>Grease included</i>	000 350 02 13 000 586 14 33	Ø80	





Type	OE nr	Dimensions	Drawing
SIDEM NR: 50066			
ACTROS	000 323 62 85	28 x 52 x 56	
SIDEM NR: 50061			
ACTROS	000 326 24 81	38 x 62 x 56	
SIDEM NR: 50064			
ACTROS	000 326 26 81	47,5 x 75 x 56,5	
SIDEM NR: 50065			
ACTROS	000 326 44 81	57,5 x 88 x 56	





WHEEL PARTS MERCEDES

Type	OE nr	Dimensions	Drawing
Bolts			
SIDEM NR: 50716			
	3274020371	M20 x 1,5 x 90	
SIDEM NR: 50711			
	3814010171	M22 x 1,5 x 77	
SIDEM NR: 50514			
	3894010071	M22 x 1,5 x 80	
SIDEM NR: 50013			
	3814010371	M22 x 1,5 x 89	
SIDEM NR: 50712			
	3814010471	M22 x 1,5 x 92	
SIDEM NR: 50517			
	3814011171	M22 x 1,5 x 95	
SIDEM NR: 50710			
	3814010571	M22 x 1,5 x 98	
SIDEM NR: 50019			
	3814010671	M22 x 1,5 x 105	
SIDEM NR: 50511			
	3814010771	M22 x 1,5 x 110	
SIDEM NR: 50512			
	3814010871	M22 x 1,5 x 115	



MERCEDES WHEEL PARTS



Type	OE nr	Dimensions	Drawing
SIDEM NR: 50713			
	3814011471	M22 x 1,5 x 130	
SIDEM NR: 50714			
	*	M22 x 2 x 87	
SIDEM NR: 50715			
	*	M22 x 2 x 130	
Nuts			
SIDEM NR: 50124	SIDEM ref.		
Fits to:	50716	*	H22 - sw27
SIDEM NR: 50122	SIDEM ref.		
Fits to:	50514 50517 50013 50710 50711 50712 50019 50511 50512 50713	074361022205	H23 - sw30
SIDEM NR: 50123	SIDEM ref.		
Fits to:	50714 50715	*	H32 - sw32





CROSS REFERENCE MERCEDES GUIDE

OE nr	SIDEM nr	Page	OE nr	SIDEM nr	Page	OE nr	SIDEM nr	Page
#	50123	32	000 350 21 05	50544	25	074361022205	50122	32
#	50124	32	000 350 22 05	50448	25	295 350 07 06	50040	21
#	50714	32	000 350 22 05	14440	25	302 330 00 35	50831	20
#	50715	32	000 460 01 48	50633	20	302 330 01 35	50831	20
000 150 01 13	50445	27	000 460 03 48	50630	20	302 330 02 35	50831	20
000 268 46 89	50930	20	000 460 06 48	50631	20	302 330 03 35	50831	20
000 268 47 89	50931	20	000 460 10 48	50630	20	302.330.06.19	50886 KIT	3
000 268 61 89	50931	20	000 460 12 48	50631	20	302.330.06.19	50886 SET	3
000 268 62 89	50930	20	000 460 26 48	50633	20	302.586.00.33	50886 KIT	3
000 323 62 85	50066	30	000 460 27 48	50633	20	302.586.00.33	50886 SET	3
000 326 24 81	50061	30	000 460 28 48	50630	20	326 586 00 33	50785 KIT	5
000 326 26 81	50064	30	000 460 29 48	50630	20	326 586 00 33	50785 SET	5
000 326 44 81	50065	30	000 460 29 48	50634	19	326.330.02.19	50785 KIT	5
000 330 00 75	50446	25	000 460 34 48	50631	20	326.330.02.19	50785 SET	5
000 330 01 48	50831	20	000 460 35 48	50631	20	327 402 03 71	50716	31
000 330 02 35	50539	19	000 460 68 48	50030	19	327.330.00.19	50882 KIT	2
000 330 02 48	50830	19	000 460 69 48	50031	19	327.330.00.19	50882 SET	2
000 330 03 35	50538	19	000 460 7105	50636	17	327.586.00.33	50882 KIT	2
000 330 06 35	50538	19	000 460 9305	50637	14	327.586.00.33	50882 SET	2
000 330 07 07	14246	26	000 463 32 29	50538	19	343 320 16 32	50045	22
000 330 07 35	50539	19	000 463 34 29	50830	19	343 320 17 32	50044	22
000 330 14 11	44249	24	000 463 35 29	50830	19	343 586 00 32	50248	28
000 330 14 35	50832	19	000 586 01 32	50249	29	343.330.02.19	50787 KIT	4
000 330 15 35	50832	19	000 586 01 35	50440	28	343.330.02.19	50787 SET	4
000 330 24 10	50538	19	000 586 06 32	50343	28	343.586.02.33	50787 KIT	4
000 330 32 35	50830	19	000 586 07 32	50540	29	343.586.02.33	50787 SET	4
000 330 33 35	50833	19	000 586 10 35	50442	27	346.330.00.19	50788 KIT	7
000 330 58 35	50830	19	000 586 11 35	50244	26	346.330.00.19	50788 SET	7
000 330 71 35	50832	19	000 586 12 35	50241	27	346.330.01.19	50881 KIT	7
000 330 72 35	50833	19	000 586 14 33	50246	29	346.330.01.19	50881 SET	7
000 330 73 35	50830	19	000 586 15 33	50247	28	346.586.00.33	50788 KIT	7
000 330 85 35	50538	19	000 586 16 33	50248	28	346.586.00.33	50788 SET	7
000 330 86 35	50539	19	000 586 18 33	50440	28	346.586.01.33	50881 KIT	7
000 330 87 35	50538	19	000 586 19 33	50440	28	346.586.01.33	50881 SET	7
000 330 88 35	50539	19	001 330 01 35	50830	19	355 330 03 19	50688 KIT	4
000 330 93 35	50832	19	001 330 02 35	50830	19	355 330 03 19	50688 KIT SR	4
000 330 94 35	50833	19	001 330 18 35	50635	20	355 330 21 19	50686 KIT	3
000 330 95 35	50832	19	001 460 0705	50639	18	355 330 21 19	50686 KIT SR	3
000 330 96 35	50833	19	001 460 08 48	50630	20	355 586 00 33	50688 KIT	4
000 338 21 29	50832	19	001 460 0805	50639	18	355 586 00 33	50688 KIT SR	4
000 338 34 10	50830	19	001 460 12 48	50630	20	355 586 18 33	50686 KIT	3
000 338 36 29	50832	19	001 460 14 48	50631	20	355 586 18 33	50686 KIT SR	3
000 338 38 10	50341	24	001 460 22 48	50630	20	355.330.06.19	50680 KIT	3
000 350 02 05	50441	27	001 460 23 48	50631	20	355.330.06.19	50680 SET	3
000 350 02 13	50246	29	001 460 34 48	50830	19	355.586.03.33	50680 KIT	3
000 350 02 13	50543	24	001 460 37 48	50631	20	355.586.03.33	50680 SET	3
000 350 04 05	50440	28	001 460 6705	50636	17	360.330.07.19	50980 KIT	2
000 350 04 13	50241	27	001 460 6905	50637	14	360.330.07.19	50980 SET	2
000 350 06 13	50244	26	001 460 89 48	50630	20	360.586.02.33	50980 KIT	2
000 350 09 05	50541	26	001 460 9805	50638	14	360.586.02.33	50980 SET	2
000 350 10 05	50545	24	001 460 9905	50638	14	381 350 02 06	50047	22
000 350 13 05	50447	25	002 460 4305	50735	16	381 401 01 71	50711	31
000 350 14 05	50242	28	002 460 4405	50735	16	381 401 03 71	50013	31
000 350 15 05	50443	27	002 460 4705	50736	15	381 401 04 71	50712	31
000 350 17 05	50444	24	002 460 4805	50736	15	381 401 05 71	50710	31



MERCEDES CROSS REFERENCE GUIDE



OE nr	SIDEM nr	Page	OE nr	SIDEM nr	Page	OE nr	SIDEM nr	Page
381 401 06 71	50019	31	942 330 0903	50034	9			
381 401 07 71	50511	31	945 330 0003	50339	12			
381 401 08 71	50512	31	945 330 0103	50339	12			
381 401 11 71	50517	31	945 330 0203	50130	9			
381 401 14 71	50713	32	945 330 0303	50130	9			
383 460 2305	50733	18	945 330 0403	50339	12			
383 460 4405	50733	18	945 330 0503	50130	9			
389 320 08 32	50140	23	945 330 0603	50339	12			
389 401 00 71	50514	31	949 330 0103	50338	10			
389.586.00.33	50786 KIT	6	949 330 0203	50338	10			
389.586.00.33	50786 SET	6	970 330 0003	50337	9			
391.330.00.19	50786 KIT	6	970 330 0103	50337	9			
391.330.00.19	50786 SET	6	970 330 0203	50337	9			
391.586.00.33	50786 KIT	6	970 330 0303	50337	9			
391.586.00.33	50786 SET	6	970 460 0705	50432	13			
393 320 01 32	50142	21	970 460 0905	50432	13			
393 320 01 32	50144	21	972 460 1405	50533	13			
393 320 02 32	50146	23	972 460 1605	50533	13			
393 350 54 05	50049	23	972 460 1805	50534	13			
393 350 55 05	50049	23	972 460 2005	50534	13			
395 320 01 32	50046	21	974 460 1005	50535	18			
395 320 03 32	50141	22	974 460 1205	50535	18			
395 320 14 32	50042	23						
395 320 15 32	50043	23						
395 350 00 06	50041	21						
620 460 2805	50731	17						
620 460 3705	50731	17						
625.330.01.19	50883 KIT	5						
625.330.01.19	50883 KIT SR	5						
625.330.02.19	50884 KIT	5						
625.330.02.19	50884 KIT SR	5						
647 460 0005	50730	13						
647 460 0105	50730	13						
655 330 00 19	50782 KIT	8						
655 330 01 19	50783 KIT	8						
655 330 06 19	50784 KIT	8						
655 350 00 06	50144	21						
655 350 03 05	50049	23						
656 350 00 06	50144	21						
658 350 00 05	50049	23						
658 350 00 06	50144	21						
658 350 02 06	50144	21						
659 350 04 06	50040	21						
659 350 11 06	50041	21						
941 330 0003	50131	11						
941 330 0103	50131	11						
941 330 0203	50131	11						
942 326 00 50	50542	26						
942 330 0003	50334	12						
942 330 0103	50334	12						
942 330 0203	50334	12						
942 330 0503	50034	9						
942 330 0603	50034	9						
942 330 0703	50334	12						
942 330 0803	50338	10						





INDEX

Page

Page

Seite

2-4	KING PIN SETS JEUX D'AXES DE FUSEE ACHSBOLZENZÄTZE
5	TRACK RODS BARRES DE DIRECTION SPURSTANGEN
6-8	LINK RODS BARRES D'ACCOUPLMENT LENKSCHUBSTANGEN
9-11	TIE ROD ENDS ROTULES DE DIRECTION KUGELGELENK
12	TORQUE RODS BARRES DE REACTION REAKTIONSSTANGE
13-16	REPAIR KITS TORQUE ROD JEUX DE REPARATION DE BARRE DE REACTION REP.-SÄTZE FÜR REAKTIONSSTANG
17	WHEEL PARTS PIECES DE ROUE RADTEIL
18	CROSS REFERENCE GUIDE LISTE D'EQUIVALENCE VERGLEICHNUMMERNLISTE





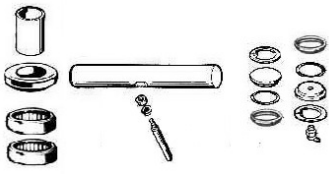
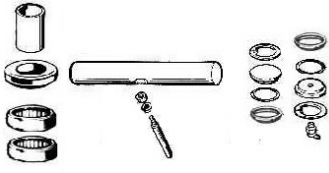
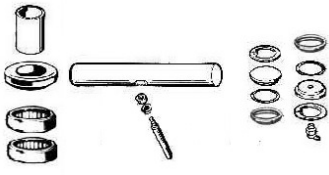

SIDEM NR	DESCRIPTION	REMARKS		
6880 KIT 6880 KIT SR	repair kit with bearing repair kit without bearing	Ø 35 L = 177		
	OE	PERIOD	AXLE	APPLICATION
	5000336305			JE 13 / 15 JP 11 / 13 JR / JX 19 / 21 M / S 4X4 ME / SE / CE 160 / 180 / 210 PS 150 / 160 S 130 / 150 TI 170 (VF 6JP) S 170 (FAB=SH)
SIDEM NR	DESCRIPTION	REMARKS		
6881 KIT 6881 KIT SR	repair kit with bearing repair kit without bearing	Ø 40 L = 240		
	OE	PERIOD	AXLE	APPLICATION
	5000793828			C 230 / 280 / 300 / 340TI / CCH300 G 170 G 210 / 230 G 200 / 210 / 230 TI G 220 / 270 BOM G 230 / 270 SP G 260 / 290 G 320 G 340 TI TR 18 T PR 100-2 PR 180-2 M 140 / 160 / 200 / 230 G.B.
SIDEM NR	DESCRIPTION	REMARKS		
6882 KIT 6882 KIT SR	repair kit with bearing repair kit without bearing	Ø 35 L = 177		
	OE	PERIOD	AXLE	APPLICATION
	5000794185			M 140 / 160 / 200 / 230 ME / SE / CE 160 / 180 / 210 M / S 150 / 180 / 210 / 220 / 230 TI / 250 MIDLINER G.B. PA 200 / 210



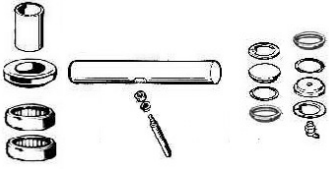

KING PIN SETS

RVI



SIDEM NR	DESCRIPTION	REMARKS		
6883 KIT 6883 KIT SR	repair kit with bearing repair kit without bearing	Ø 40 L = 235		
	OE	PERIOD	AXLE	APPLICATION
	5000794319			GLR 190 / 230 / GLC 190 Axle E 5 A 421 12/1979 -> G 260 / 290 Axle E 5 A 4 C with brake cyl 16 Inch. E 5 A 4 C 2/1985 - 2/1986 E 5 AC -> 3/1987 E 5 A 821 2/1985 - 2/1986 E 5 A 4 D -> 3/1986 E 5 A 921 9/1984 - 3/1987 PR 100.2 / E 100.2 Axle Train R 16 A MAXTER
SIDEM NR	DESCRIPTION	REMARKS		
6884 KIT 6884 KIT SR	repair kit with bearing repair kit without bearing	Ø 46 L = 280		
	OE	PERIOD	AXLE	APPLICATION
	5000794320			C 260 / C 290 Axle E 6 AC -> 2/1987 E 6 A 77 2/1986 - 2/1987 C 210 / 210.19 / CLR 220 Axle E 6 A 4 C -> 2/1985 E 6 A 711 1/1986 -> CBH 280 / 340 / 350 / 380 Axle E 6 A 511 -> 2/1987 CLR 190/230 - GLC 190 Axle E 6 A 411 2/1982 - 2/1985 GR 191 / 231 Axle E 6 A 411 -> 2/1982 R 370 / 390 / 420 Axle E 6 A 2/211 -> 2/1985 E 6 A 3/311 -> 2/1985 E 6 A 33 2/1985 - 3/1985 E 6 A 33 2/1985 - 3/1985 E 6 A 3/311 3/1985 - 2/1987

© Sidem nv 2006

SIDEM







SIDEM NR	DESCRIPTION	REMARKS		
6885 KIT 6885 KIT SR	repair kit with bearing repair kit without bearing	Ø 50 L = 227		
	OE	PERIOD	AXLE	APPLICATION
	#			G 260 / 290 -> R 370 / 390 / 420 -> 1989 AE 380 / 385TI / 500 / 520 BUS TRACER PR 112 / 118 PREMIUM (6x2) (6x2/4) ->1999 PREMIUM (FAB 22E/H/J/Q/R) 2000 -> MAXTER (4x2) (4x4) (6x4) (8x4) KERAX PREMIUM (FAB 22E/H/J/Q/R) 2000
SIDEM NR	DESCRIPTION	REMARKS		
6886 KIT 6886 KIT SR	repair kit with bearing repair kit without bearing			
	OE	PERIOD	AXLE	APPLICATION
	5000793641			JK 55/60/65/75 MS 150/180/210/220/230 TI/250 MIDLINER G.B. S 100/120/135 S 110/130 (VF6JK) S 135/150 (mot. 040266) S 140/160
SIDEM NR	DESCRIPTION	REMARKS		
6081 KIT 6081 KIT SR	repair kit with bearing repair kit without bearing			
	OE	PERIOD	AXLE	APPLICATION
	5001865610			MASCOTT



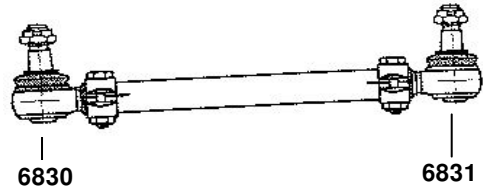

TRACK RODS

RVI

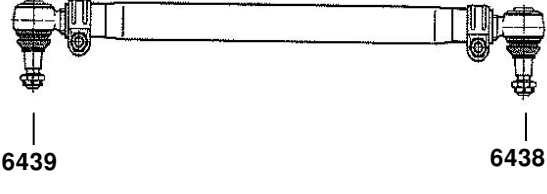
TYPES	Oe nr.	Dimensions	Drawing
SIDEM NR: 6730 Mascott DXI	5010566048		
SIDEM NR: 6737 Mascott	5010308985		
SIDEM NR: 6736 MIDLINER Subtype: C-G-M-R-M200-M300	5010145077 23123224	L= 1700 Ø= 48	







TYPES	Oe nr.	Dimensions	Drawing
SIDEM NR: 6738			
Mascott DXI	5010488464		<p>6834 6835</p>
SIDEM NR: 6632			
Mascott (01/99-->)	5010383410	L= 570 Ø= 30	<p>6538 6531</p>
SIDEM NR: 6633			
Maxter Subtype: 600 mm between axes	5430122944	L= 603 Ø= 36	<p>6437 6436</p>
SIDEM NR: 6631			
Magnum AE (10/92-->) Subtype: 385-390-420-430-470-520-560	5010130344	L= 737 Ø= 52	<p>6437 6436</p>
SIDEM NR: 6732			
Premium distribution (04/96-->) Subtype: Mechanic suspension front Premium route (04/96-->) Subtype: Mechanic suspension front	5010294287	L= 809 Ø= 50	<p>6436</p>
SIDEM NR: 6733			
Premium distribution (04/96-->) Subtype: Mechanic suspension front Premium route (04/96-->) Subtype: Mechanic suspension front	5010294288	L= 825 Ø= 52	<p>6436</p>
SIDEM NR: 6735			
Premium distribution (04/96-->) Premium route (04/96-->)	5010294502	L= 847 Ø= 52	<p>6436</p>





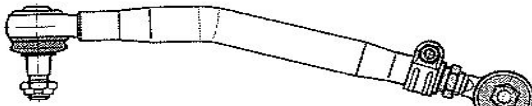

LINK RODS

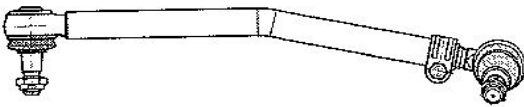
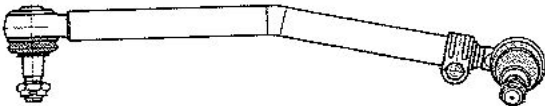
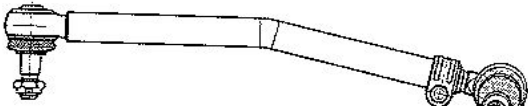
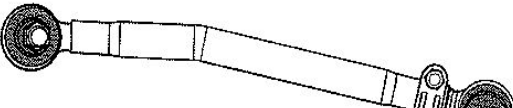
RVI

TYPES	Oe nr.	Dimensions	Drawing
SIDEM NR: 6734 Premium distribution (04/96-->) Subtype: Pneumatic suspension front Premium route (04/96-->) Subtype: Pneumatic suspension front	5010294289	L= 864 Ø= 62	 6436
SIDEM NR: 6636 Midliner M&S Subtype: 150-250	5010130393	L= 872 Ø= 40	 6430
SIDEM NR: 6639 Midlum Subtype: 10-12 ton	5010488165	L= 883 Ø=42	 6536
SIDEM NR: 6637 Midliner M&S	5010130456	L= 885 Ø= 40	 6432
SIDEM NR: 6638 Midlum Subtype: 7 ton	5010488164	L= 886 Ø= 42	 6536
SIDEM NR: 6634 Maxter Kerax (10/92-->2000)	5010488052 5010229242	L= 934 Ø= 52	 6436



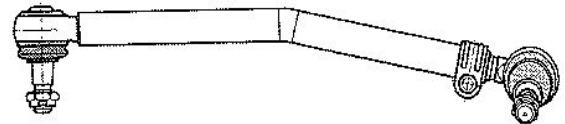

TYPES	Oe nr.	Dimensions	Drawing
SIDEM NR: 6731			
Midlum Subtype: 14-15-16 ton	5010488167	L= 946 Ø=42	 <p style="text-align: right;">6536</p>
SIDEM NR: 6635			
Maxter Manager (10/92-->06/97) Subtype: G 260-G 270-G 280-G 300-G 330-G 340	5010144552	L= 975 Ø= 52	 <p style="text-align: right;">6436</p>





TIE ROD ENDS

RVI

Type	sidem	OE nr	A	B	C
B 110	6530	5000814097	95		M24x1,5 rht
B 110	6435	5000807553 5000814096	95		M24x1,5 lht
Mascott	6531	5001847436	-	-	M24x1,5 rht
Mascott	6538	5001847437	-	-	M24x1,5 lht
Mascott	6832	5001860124	-	-	-
Mascott	6833	5001860123	-	-	-
Mascott DXI	6830	5001858756	-	-	-
Mascott DXI	6831	5001858757	-	-	-
Mascott DXI	6834	5001860770	-	-	-
Mascott DXI	6835	5001860769	-	-	-
Midliner M & S	6432	0003406242 5000559335 5000823987	105 mm	-	M28x1,5 rht
Midliner M & S	6433	5000559336 5000823947 5000823997	105 mm	-	M28x1,5 lht
Midlum 7 ton 10-12 ton	6536	5001851800		-	M28x1,5 rht
Midlum 14/15/16 ton	6537	5001852264		-	M30x1,5 rht
S170-MS200/250-JE 13/15-R212-CBM 220- JP 11/13-JR-5170-J & S 4x4-11 P-130- S130 -150 Ti-170-M140/160/200/230 Midliner M & S 150-250	6430	0003406253 5000242159 5000295214 5000812483 7701016946	115 mm	-	M30x1,5 rht
S170-MS200/250-JE 13/15-R212-CBM 220- JP 11/13-JR-5170-J & S 4x4-11 P-130- S130 -150 Ti-170-M140/160/200/230 Midliner M & S 150-250	6431	5000295215	115 mm	-	M30x1,5 lht





Type	sidem	OE nr	A	B	C
S170-GLR280-R310-R360-GB-TB191/230- GTB17 – TBM280-ER100-PJK-PJN-PJP-PR100 Mi – PR10/12/14S/SL/SR-PR180-PER180-TR- GR205/350 – PGC191/231-GC191/231-GR191/231- R360-GR-G260 – G 290-G170-C260/290-TR-ER100- GLMTLM280- PR180-C210/CLR220-PER180-GBH-TBH GBH 260-280-290-320-TBH280-GR191- 231 – GRH235-235R-C260-290-340-CCH30026- C30026 – GRH-TRH 305/350-PX30V-VT-28-28T-GR TR305/350 – R310D-R310T-R310-RI357-R360T-R370T- GR-TR280 – GAMME R-G210-230-260-290-CBH280- 350-380 – CLM280-340 MD07-MKD7-ND02 Magnum AE 385-390-420-430-470 520-560 Maxter G :260-280-300-340 Manager G: 270-280-300-330-340 Kerax Premium distribution Premium route mechanic front suspension	6436	0003401169 0003406236 0003406251 0003406254 0003406260 0003406261 5000288360 5000590236 5000804824 7701011412 5010832582	120 mm	-	M30x1,5 rht
Midliner C-G-M-R-M200-300 G200/210/230TI-G260/290/320- GBH260/280- GLC-GLR190/230- GR191/205/231/280/350- GRH235/305/350-'R' 1990 à 1992- R310/360- M140/160/200/230-TR205/280/350- TBH280- TRH305/350	6439	0003401207 5001832580	120 mm	-	M38x1,5 rht





TIE ROD ENDS

RVI

Type	sidem	OE nr	A	B	C
S170-GLR280-R310-R360-GB-TB191/230-GTB17 – TBM280-ER100-PJK-PJN-PJP-PR100 Mi – PR10/12/14S/SL/SR-PR180-PER180-TR-GR205/350 – PGC191/231-GC191/231-GR191/231-R360-GR-G260 – G 290-G170-C260/290-TR-ER100-GLM/TLM280- PR180-C210/CLR220-PER180-GBH-TBH GBH 260-280-290-320-TBH280-GR191-231 – GRH235-235R-C260-290-340-CCH30026-C30026 – GRH-TRH 305/350-PX30V-VT-28-28T-GR TR305/350 – R310D-R310T-R310-RI357-R360T-R370T-GR-TR280 – GAMME R-G210-230-260-290-CBH280-350-380 – CLM280-340 MD07-MKD7-ND02 Magnum AE 385-390-420-430-470 520-560 Maxter G :260-280-300-340 Manager G: 270-280-300-330-340 Kerax Premium distribution Premium route mechanic front suspension	6437	0003401170 5000288361	120 mm	-	M30x1,5 rht
Midliner C-G-M-R-M200-300 G200/210/230Ti-G260/290/320-GBH260/280- GLC-GLR190/230- GR191/205/231/280/350- GRH235/305/350-'R' 1990 à 1992- R310/360- M140/160/200/230-TR205/280/350- TBH280- TRH305/350	6438	0003401206 5001832579	120 mm	-	M38x1,5 lht





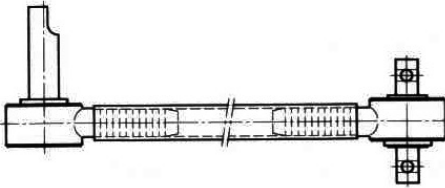
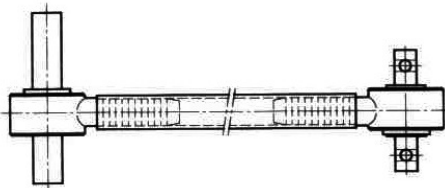
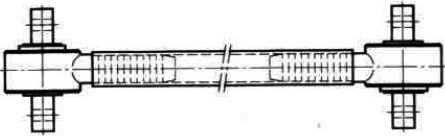
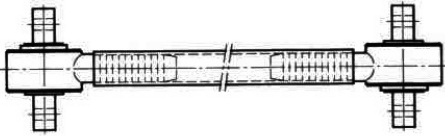



Type	OE nr	Dimensions	Drawing
SIDEM NR: 6143			
GBH 260/280 TBH 260/280 ME/ML/MD/MK 10 MD/MK 05	0023123252 5000788392	467 mm	
SIDEM NR: 6142			
GBH 260/280 TBH 260/280 ME/ML/MD/MK 10 MD/MK 05	0023123251	485 mm	
SIDEM NR: 6140			
C 260/290/300 PM 26 CBH 280/320/340/385 CLM 280/340 GBH 260/280/290/320 GRH 235/250/350 TBH 280/350 TS RANGE R (300 -420) G 260/290/300	0023123253 5010064641 5010094838 5010094941	575 mm	
SIDEM NR: 6141			
KERAX 340/26	5010094840	575 mm	





TORQUE ROD REPAIR KITS

RVI

Type	OE nr	Dimensions	Drawing
Repair kits for Torque rods			
SIDEM NR: 14440			
	5001 836 091	Ø75 x 130 x Ø19	
SIDEM NR: 6246			
	5001 842 823	Ø85 x 130 x Ø19	
SIDEM NR: 6446			
	5000 802 123 5001 831 526	Ø85 x 145 x Ø19	
Repair kits for Torque rod balls			
SIDEM NR: 6441			
<i>Grease included</i>	0063 241 000		
SIDEM NR: 6442			
<i>Grease included</i>	5001 851 533		

© Sidem nv 2006

SIDEM





Type	OE nr	Dimensions	Drawing
SIDEM NR: 50246			
<i>Grease included</i>	0003 404 168		
SIDEM NR: 6443			
<i>Grease included</i>	5000 819 414		
SIDEM NR: 6444			
	0003 404 167		
SIDEM NR: 6445			
<i>Grease included</i>			
SIDEM NR: 6447			
<i>Grease included</i>	5001 832 613 0948 822 002 4090 435 642		





TORQUE ROD REPAIR KITS

RVI

Type	OE nr	Dimensions	Drawing
SIDEM NR: 6240			
	5000 808 789		
SIDEM NR: 6242			
SIDEM NR: 6243			
	5000 788 392*		<p>Belongs to Sidem nr. 6143</p>
SIDEM NR: 6241			
	5000 819 413	Ø65	
SIDEM NR: 6440			
	5001 014 345	Ø65 x 145 x Ø19	





Type	OE nr	Dimensions	Drawing
SIDEM NR: 6247			
	7701 011 267	Ø80 x 130 x Ø19	





WHEEL PARTS

RVI

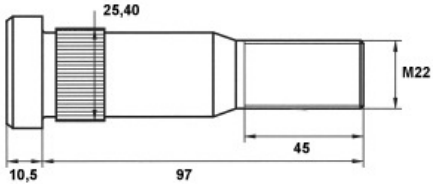
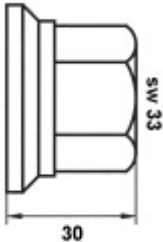
Type	OE nr	Dimensions	Drawing
Bolts			
SIDEM NR: 6010			
	190513	M22 x 1,5 x 97	
Nuts			
SIDEM NR: 6020			
	5000471861	M22 x 1,5	





Oe nr	SIDEM nr	Page	Oe nr	SIDEM nr	Page	Oe nr	SIDEM nr	Page
#	6242	15	5000819413	6241	15			
#	6445	14	5000819414	6443	14			
#	6885 KIT	4	5000823947	6433	9			
#	6885 KIT SR	4	5000823987	6432	9			
0003401169	6436	10	5000823997	6433	9			
0003401170	6437	11	5001014345	6440	15			
0003401206	6438	11	5001831526	6446	13			
0003401207	6439	10	5001832579	6438	11			
0003404167	6444	14	5001832580	6439	10			
0003404168	50246	14	5001832613	6447	14			
0003406236	6436	10	5001836091	14440	13			
0003406242	6432	9	5001842823	6246	13			
0003406251	6436	10	5001847436	6531	9			
0003406253	6430	9	5001847437	6538	9			
0003406254	6436	10	5001851533	6442	13			
0003406260	6436	10	5001851800	6536	9			
0003406261	6436	10	5001852264	6537	9			
0023123251	6142	12	5001858756	6830	9			
0023123252	6143	12	5001858757	6831	9			
0023123253	6140	12	5001860123	6833	9			
0063241000	6441	13	5001860124	6832	9			
0948822002	6447	14	5001860769	6835	9			
190513	6010	17	5001860770	6834	9			
23123224	6736	5	5001865610	6081 KIT	4			
4090435642	6447	14	5001865610	6081 KIT	4			
5000242159	6430	9	5010064641	6140	12			
5000288360	6436	10	5010094838	6140	12			
5000288361	6437	11	5010094840	6141	12			
5000295214	6430	9	5010094941	6140	12			
5000295215	6431	9	5010130344	6631	6			
5000336305	6880 KIT	2	5010130393	6636	7			
5000336305	6880 KIT SR	2	5010130456	6637	7			
5000471861	6020	17	5010144552	6635	8			
5000559335	6432	9	5010145077	6736	5			
5000559336	6433	9	5010229242	6634	7			
5000590236	6436	10	5010294287	6732	6			
5000788392	6143	12	5010294288	6733	6			
5000788392*	6243	15	5010294289	6734	7			
5000793641	6886 KIT	4	5010294502	6735	6			
5000793641	6886 KIT SR	4	5010308985	6737	5			
5000793828	6881 KIT	2	5010383410	6632	6			
5000793828	6881 KIT SR	2	5010488052	6634	7			
5000794185	6882 KIT	2	5010488164	6638	7			
5000794185	6882 KIT SR	2	5010488165	6639	7			
5000794319	6883 KIT	3	5010488167	6731	8			
5000794319	6883 KIT SR	3	5010488464	6738	6			
5000794320	6884 KIT	3	5010566048	6730	5			
5000794320	6884 KIT SR	3	5010832582	6436	10			
5000802123	6446	13	5430122944	6633	6			
5000804824	6436	10	7701011267	6247	16			
5000807553	6435	9	7701011412	6436	10			
5000808789	6240	15	7701016946	6430	9			
5000812483	6430	9						
5000814096	6435	9						
5000814097	6530	9						





INDEX

Page



Page

Seite

2-5	KING PIN SETS JEUX D'AXES DE FUSEE ACHSBOLZENZÄTZE
6-9	TRACK RODS BARRES DE DIRECTION SPURSTANGEN
10-27	LINK RODS BARRES D'ACCOUPEMENT LENKSCHUBSTANGEN
28-29	TIE ROD ENDS ROTULES DE DIRECTION KUGELGELENK
30	REPAIR KITS TORQUE ROD JEUX DE REPARATION DE BARRE DE REACTION REP.-SÄTZE FÜR REAKTIONSSTAG
31-41	SPRING PARTS PIECES DE RESSORT FEDERTEIL
42	STABILISER BEARINGS DOUILLES DE STABILISATEUR STABILISATORLAGER
43-44	WHEEL PARTS PIECES DE ROUE RADTEIL
45-46	CROSS REFERENCE GUIDE LISTE D'EQUIVALENCE VERGLEICHNUMMERNLISTE





SIDEM NR	DESCRIPTION		REMARKS
62180 KIT 62180 KIT SR	repair kit with bearing repair kit without bearing		Ø 36/44,5 L = 215 mm
	OE	AXLE	APPLICATION
	550723	AM 55 AM 55 AM 55 AM 55 AM 55 AM 55 AM 55 AM 55 AM 55 AM 55 AM 55 With leaf spring	G112 / P112 / R112 / T112 L110 / LS110 / LT110 L111 / LS111 / LT111 L80 / LS80 / LB80 L81 / LB81 L85 / LS85 L86 LS86 / LB86 / LBS86 R142 T82 / G82 / P82 BR116
RELATED PART NUMBERS	OE	DESCRIPTION	DIMENSIONS
62183 BB 62180 BB	1301106 1318321	bush teflon bush teflon	44.5 x 49.25 x 57 40.9 x 36.2 x 56
SIDEM NR	DESCRIPTION		REMARKS
62182 KIT 62182 KIT SR	repair kit with bearing repair kit without bearing		Ø 44,4/53,5 L = 228 mm
	OE	AXLE	APPLICATION
	550732	Air suspension AM 60 AM 60 AM 60 AM 60 AM 60 AM 60 AM 60 AM 60 AM 60 AM 60 AM 60 AM 60 AM 60 AM 60 AM 60 AM 60 AM 60	BR116 112 H 82 H / M G112 / P112 / R112 / T112 G82 / P82 / T82 L111 / LS111 / LT111 L140 / LS140 / LB140 / LBS140 L141 / LS141 / LT146 L81 / LB81 L86 / LS86 / LB86 / LBS86 LB110 / LBS110 / LBT110 LB111 / LBS111 / LBT111 LB141 / LBS141 / LBT141 LB85 / LBS85 LBT140 / LBT140super R142 / T142
RELATED PART NUMBERS	OE	DESCRIPTION	DIMENSIONS
62183 B 62183 BB	323273-3 1301106	bush teflon bush teflon	53.5 x 58.5 x 60 44.5 x 49.25 x 57





KING PIN SETS

SCANIA

SIDEM NR	DESCRIPTION		REMARKS
62184 KIT 62184 KIT SR	repair kit with bearing repair kit without bearing		Ø 36/44,5 L = 215 mm
	OE	AXLE	APPLICATION
	550722	AM 70 AM 70 AM 70 AM 70 AM 70 AM 70 AM 70 AM 70 AM 70	112H / M 113 E / H / M ->CH4292923 SN; ->CH1161721 SS 143 E / H / M ->CH4292923 SN; ->CH1161721 SS 93 H / M ->CH4292923 SN; 1161721 SS P112 / R142 T113 E / H ->CH4292923 SN; ->CH1161721 SS T142 T143 E / H ->CH4292923 SN; ->CH1161721 SS T93 H ->CH4292923 SN; ->CH1161721 SS
RELATED PART NUMBERS	OE	DESCRIPTION	DIMENSIONS
62184 R	322747-7	bearing	H = 36.25

SIDEM NR	DESCRIPTION		REMARKS
62185 KIT 62185 KIT SR	repair kit with bearing repair kit without bearing		Ø 54,2/44,4 L = 215 mm
	OE	AXLE	APPLICATION
	550730	AM 56/61 AM(A) 56/61 AM(A) 56/61 AM(A) 56/61 AM(A) 56/6x AM(A) 56/6x AM(A) 56/6x AM(A) 56/6x AM(A) 56/6x AM(A) 56/6x	T113 / T 143 / T 93 G93 / P93 / R93 P113 / R113 R143 113E / H / M 143E / H / M 93H / M T113E / H T143E / H T93H
RELATED PART NUMBERS	OE	DESCRIPTION	DIMENSIONS
62183 BB 62184 R	1301106 322747-7	bush teflon bearing	44.5 x 49.25 x 57 H = 36.25



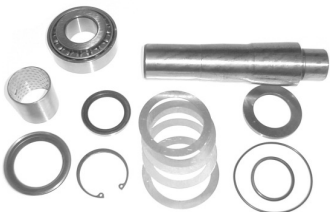

SIDEM NR	DESCRIPTION		REMARKS
62186 KIT 62186 KIT SR	repair kit with bearing repair kit without bearing		Ø 57/45 L = 244 mm
	OE	AXLE	APPLICATION
	550731	AM 70 AM 70 AM 70 AM 70 AM 70 AM 70	113 E / H / M 4292924->SN; 1161722->SS 143 E / H / M CH 4292924->SN; 1161722->SS 93 H / M CH 4292924->SN; 1161722->SS T113 E / H 4292924->SN; 1161722->SS T143 E / H 4292924->SN; 1161722->SS T93 H 4292924->SN; 1161722->SS
RELATED PART NUMBERS	OE	DESCRIPTION	DIMENSIONS
62184 R	322747-7	bearing	H = 36.25
SIDEM NR	DESCRIPTION		REMARKS
62187 KIT 62187 KIT SR	repair kit with bearing repair kit without bearing		Ø 40/50 L = 223 mm
	OE	AXLE	APPLICATION
	550257	AM 620/920 AM 620/920 AM 740,AMA 860 AM 740/860 AM 800/820 AM(A) 740/860 AM(A) 740/860 AMA 780 D/860 D AM(A)(D) 860 D/740 AM(A)(D) 860 D/740	114G CH->9014419 SAN; CH->1219062 SSS 144G CH->9014419 SAN, ->CH1144359879 SNL 144L CH->9014419 SAN, ->CH1144359879 SNL 124C CH->9014419 SAN, ->CH1144359879 SNL 113 E / H / M 124G CH->9014419 SAN, ->CH1144359879 SNL 124L CH->9014419 SAN, ->CH1144359879 SNL 124 C CH->9014419 SAN, ->CH1144359879 SNL 124 G / L CH->9014419 SAN, ->CH1144359879 SNL
RELATED PART NUMBERS	OE	DESCRIPTION	DIMENSIONS
62187 BB 62184 R	322747-7	bush teflon bearing	H = 36.25





KING PIN SETS

SCANIA

SIDEM NR	DESCRIPTION		REMARKS
62188 KIT 62188 KIT SR	repair kit with bearing repair kit without bearing		Ø 40/50 L = 223 mm
	OE	AXLE	APPLICATION
	550284	AM620/900/920	94/D/L/C/G
		ARA 760/820/900	94/D/L/C/G
		ARA 760/820/900 D	94/D/L/C/G
		AM(A) 620/900/920	114/D/L/C/G CH 9014420-> SAN; CH 1219063-> SSS
		AM620/900/920	114/D/L/C/G
		ARA 760/820/900	114/D/L/C/G
		ARA 760/820/900 D	114/D/L/C/G
		AM(A) 620/900/920	124/D/L/C/G CH 9014420-> SAN, CH1 144359880-> SNL
		AM620/900/920	124/D/L/C/G CH 9014420-> SAN, CH1 144359880-> SNL
		ARA 760/820/900	124/D/L/C/G CH 9014420-> SAN, CH1 144359880-> SNL
		AM(A) 620/900/920	144/D/L/C/G
		AM(A) 620/900/920	144/D/L/C/G CH 9014420-> SAN, CH1 144359880-> SNL
		AM620/900/920	144/D/L/C/G CH 9014420-> SAN, CH1 144359880-> SNL
		ARA 760/820/900	144/D/L/C/G
ARA 760/820/900 D	144/D/L/C/G		
RELATED PART NUMBERS	OE	DESCRIPTION	DIMENSIONS
62187 BB 62184 R	322747-7	bush teflon bearing	H = 36.25





TYPES	Oe nr.	Dimensions	Drawing
SIDEM NR: 62538			
3 Series (Truck) Front Axle: AM61 Type: 4x2, 6x2, 6x4 ,8x4 Chassis: width 2300	395347	L= 1595 Ø= 40	
SIDEM NR: 62837			
3 Series (Truck) Front Axle: AM56 Type: 8x4 Remark: drop centre +82mm Chassis: CH -1202024 SSS CH -4336860 SNL Front Axle: AM61 Type: 8x2, 8x4 Chassis: CH -1202024 SSS CH -4336860 SNL Remark: drop centre +82mm Type: EK/HK8x4 Front Axle: ARA56, ARA61 Type: EK/HK8x4 Chassis: CH 1200603- SSS CH 4334336- SNL	1378436	L= 1677 Ø= 42	
3 Series (Bus) Front Axle: AMA56, AMA61 Chassis: CH -1824043 SBK	395348		
SIDEM NR: 62133			
4 Series (Truck) Front Axle: AM740, AM740 D Front Axle: AMA740, AMA740 D Type: 8x2, 8x2*6, 8x4 P & R Series Front Axle: AM740, AM740D Front Axle: AMA740, AMA740 D	1409918	L= 1690	
SIDEM NR: 62339			
2 Series(Truck) LB/LBS/LBT 111 LB/LBS/LBT 141	283766	L= 1731 Ø= 40	
SIDEM NR: 62530			
2 Series(Truck) Front Axle: AM70 Type: R142	352643	L= 1731 Ø= 40	





TRACK RODS

SCANIA

TYPES	Oe nr.	Dimensions	Drawing
SIDEM NR: 62431 2 Series (Truck) Type: T82, T112, T142 Front Axle: AM55 Type: G82(M), P82(M), G112M, P112M, R112M, R142 Chassis: CH --> 1045882 CH --> 4222000 Front Axle: AM60 Type: G82, P82, G112, P112, R112, R142 Remark: Exc. For chassis width 2300	395350	L= 1736 Ø= 40	
SIDEM NR: 62735 3 Series (Truck) Front Axle: AM56 Type: 8x4 Remark: drop centre +82mm Chassis: CH 1209474- SSS CH 4347053- SNL CH 9006467- SAN Front Axle: AM61 Type: 8x2, 8x4 Chassis: CH 1202025- SNL CH 4336861- SNL Type: 8x4 Remark: drop centre +82mm Chassis: CH 1209474- SSS CH 4347053- SNL CH 9006467- SAN Type: EK/HK8x4 Front Axle: ARA56, ARA61 Chassis: CH -1160556 SSS 3 Series (Bus) Front Axle: AMA56, AMA61 Chassis: CH 1824044- SBK	1378436	L= 1736 Ø= 40	







TYPES	Oe nr.	Dimensions	Drawing
SIDEM NR: 62730			
3 Series (Truck) Front Axle: AM56 Type: CP, CR 4x2, 6x2, 6x4 Type: 8x4 Remark: drop centre +82mm Remark: drop centre -28mm Front Axle: AM61 Type: 8x4 Remark: drop centre +82mm Remark: drop centre -28mm Type: 8x2 Type: EK/HK8x4 Front Axle: ARA56, ARA61 Chassis: CH 1160557- SSS CH -1200602 SSS 4 Series (Truck) Front Axle: AM620 Type: 8x2, 8x2*6, 8x6 Front Axle: AM620, AM621 SLA Front Axle: AM920 Type: 8x2, 8x2*6, 8x4 3 Series (Bus) Front Axle: AM56, AM61 P & R Series Front Axle: AM620, AM620D	1397866	L= 1736 Ø= 40	
SIDEM NR: 62435			
2 Series(Truck) Front Axle: AM55 Type: G82M, P82M, G112M, P112M, R112M Chassis: CH --> 1045882 CH --> 4222000 Type: G82, P82, R142 Front Axle: AM60 Type: G82, P82, G112, P112, R112, R142	311847	L= 1740 Ø= 40	
SIDEM NR: 62732			
3 Series (Truck) Front Axle: AM56 Type: G93ML4x2 CG13 Front Axle: AM56, AM61 Type: R113MV4x2A Type: P93MV4x2A, R93MV4x2A Type: R143MV4x2A Front Axle: AMA56, AMA61 Type: 4x2, 6x2, 6x4	310977	L= 1740 Ø= 60	





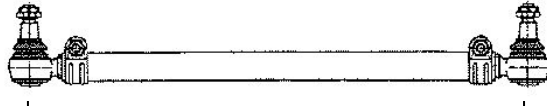

TRACK RODS

SCANIA

TYPES	Oe nr.	Dimensions	Drawing
SIDEM NR: 62137			
4 Series (Truck) Front Axle: AMA860, AMA 860 D Type: 8x2, 8x2*6, 8x4 Front Axle: ARA460D Type: 6x2/4, 8x2/4 Front Axle: ARA760, ARA900 Front Axle: ARA900 D Type: 6x2*4, 8x2*6 4 Series (Bus) Front Axle: AM860 Front Axle: AMA780, AMA780 D Front Axle: AMA860, AMA860 D Front Axle: ARA860 D P & R Series Front Axle: AM860, AM860 D Front Axle: AMA860, AMA860 D Front Axle: ARA760, ARA900	1395614	L= 1743 Ø= 50	 62531 <i>Bush: Sidem ref 62140</i>
SIDEM NR: 62737			
3 Series (Bus) Front Axle: AM56, AM61 Front Axle: AMA56, AMA61 4 Series (Bus) Front Axle: AMA60, AMA60 SLA	319359	L= 1773 Ø= 62	 62433 62432
SIDEM NR: 62132			
3 Series (Truck) Front Axle: AM800 Type: EK6x4, EK8x4 Remark: drop centre -3mm Front Axle: AM820 Type: 4x2, 6x2, 6x4, 8x2, 8x4 Remark: drop centre +82mm 4 Series (Truck) Front Axle: AM820 D Front Axle: AM900 Type: 8x4 Front Axle: ARA820 Front Axle: ARA820 D Type: 6x2, 6x4, 8x2, 8x4 4 Series (Bus) Front Axle: AM920 P & R Series Front Axle: AM900, AM920, AM920 D Front Axle: ARA820	1378435	L= 1773 Ø= 62	 62331 62330



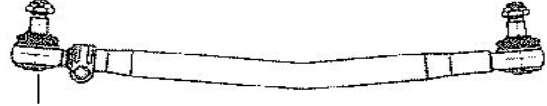

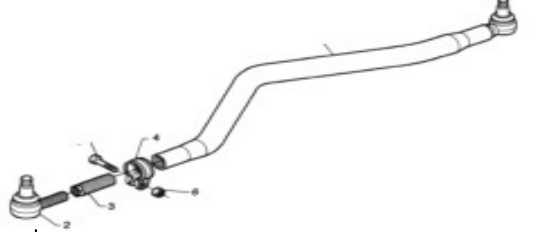

TYPES	Oe nr.	Dimensions	Drawing
SIDEM NR: 625039			
3 Series(Bus) Remark: Air suspension, Bracket connection Chassis: CH 1823420- SBK	466880		 62330
SIDEM NR: 625230			
3 Series(Bus) Remark: Air suspension, Bracket connection Chassis: CH 1823420- SBK	466881		 62330
SIDEM NR: 625232			
4 Series(Bus) Steering: LHD Type: K94 IB 4x2 or 6x2 Type: K114 IB, K124 IB, 4x2 or 6x2 Type: K114, K124, 6x2*4 Remark: Front overhang 2075, 2340, 2500 mm, Chassis Z0-348 Only for Chassis: CH-1836673 SBK CH-3514295 SLA Type: L94 IA 6x2 Type: L94 IB 6x2*4 Remark: Front overhang 2075 mm, Chassis Z0-348	1479120 492181		 62330 <i>bush: Sidem ref. 62140</i>
SIDEM NR: 625233			
4 Series(Bus) Steering: LHD Type: CL/CN 94 UA6x2/2LB Type: CL/CN 94 UB4x2 Type: CN 94 UB4x2 Remark: Front overhang 2463 mm Type: L94 UB (6x2*4LB) Type: L94 UB 4x2 Remark: Front overhang 2075, 2700 mm Type: L94 UB 6x2 Remark: Front overhang 2700 Type: N94, UA6x2 or UB4x2 Only for Chassis: CH-1841619 SBK CH-3533279 SLA	1497223 478621		 62330 <i>bush: Sidem ref. 62140</i>





LINK RODS

SCANIA

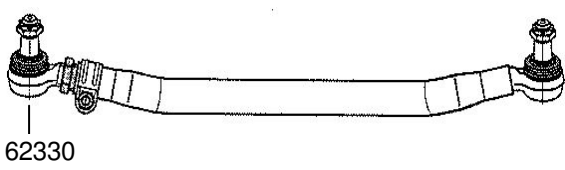
TYPES	Oe nr.	Dimensions	Drawing
SIDEM NR: 62139			
4 Series(Truck) Steering: LHD Type: P GB8x2/4, N/ANB, R DB8x2/4 N/ANB Type: P LA6x2/4, R LA6x2/4, P LB6x2/4 N/ANB, R LB6x2/4 N/ANB, P DB6x2/4 N/ANB Remark: Also available for RHD Steering: RHD Type: P DB6x2/4 N FRONTLINE P & R Series Type: P L/LA/LB, R L/LA/LB Subtype: 6x2, 6x4	1343283	L= 435 Ø= 38	
SIDEM NR: 62233			
4 Series(Truck) Steering: RHD Type: P LA6x2/4(N/ANB), R LA6x2/45 (N/ANB) Chassis: CH 1233805-1239401 SSS CH -4392231 SNL Type: P CB8x4, R CB8x4, P GB8x2 or 8x4, R GB8x2 or 8x4 Remark: Front axle distance 1940 Chassis: CH 1233805-1239401 SSS CH -4392231 SNL Type: P GB8x2*6, R GB8x2*6 Chassis: CH 1254424- SSS CH 4420708- SNL CH 9046543- SAN CH 3513574- SLA P & R series Steering: RHD Type: P L/D/LA/DA/LB/DB, R L/D/LA/DA/LB/DB Subtype: 6x2, 6x4	1394884	L= 439	
SIDEM NR: 62234			
4 Series(Truck) Steering: LHD Type: R LA6x2/4 Steering: RHD Type: P CB8x4 N FRONTLINE, P DB4x2 or 6x2/4 N FRONTLINE, CB6x4 N FRONTLINE, P DB6x2/4 N/ANB, P LA6x2/4, R LA6x2/4, P LB6x2/4 N/ANB, P LB6x2/4 N/ANB Type: P CB8x4, R CB8x4, P GB8x2 or 8x4, R GB8x2 or 8x4 or 8x2*6 Remark: Front axle distance 1940	1407186	L= 439	







TYPES	Oe nr.	Dimensions	Drawing
SIDEM NR: 62231			
4 Series(Truck) Steering: LHD Type: P CB8x8, P CB8x4, R CB8x4, P GB8x2*6, R GB8x2*6, P GB8x2 or 8x4, R GB8x2 or 8x4 Remark: Front axle distance 1940 Type: P CB8x4, R CB8x4, P GB8x4, R GB8x4 Remark: Front axle distance 1975 Steering: RHD Type: P CB8x4 N FRONTLINE	1343266	L= 495 Ø= 40	
SIDEM NR: 625131			
3 Series(Truck) Steering: LHD Front Axle: AM70 Type: T113, T143 Chassis: CH -1165790 SSS CH -4297218 SNL Type: T93, T113, T143 Chassis: CH 1165791- SSS CH 4297219- SNL Type: T113, T143	382780	L= 554 Ø= 40	
SIDEM NR: 62337			
2 Series(Truck) Type: T82, T112, T142	1369917 300308	L= 578 Ø= 40	
SIDEM NR: 62338			
2 Series(Truck) Type: T82, T112, T142 Remark: 24" wheels and/or 8 leaves, springs and anti-roll bar	1369917 306913	L= 578 Ø= 40	
SIDEM NR: 62736			
3 Series(Truck) Type: P93, P113, R113, R143 Subtype: 6x2, 6x4	388943	L= 611 Ø= 40	
SIDEM NR: 625036			
3 Series(Bus) Remark: Drag link	450870	L= 629 Ø= 40	
SIDEM NR: 625034			
3 Series(Bus) Remark: Air suspension, Bracket connection, Rear overhang 3020 mm Chassis: CH -1823419 SBK	434493	L= 672 Ø= 40	





LINK RODS

SCANIA

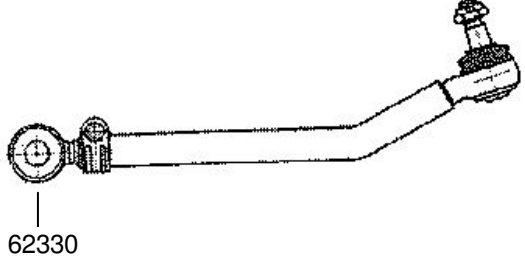
TYPES	Oe nr.	Dimensions	Drawing
SIDEM NR: 62436			
2 Series(Truck) Type:LB111, LBS111, LBT111, LB141, LBS141, LBT141 Chassis: CH 1026611 --> CH 4210643 SSN -->	291396	L= 728 Ø= 40	
SIDEM NR: 62838			
3 Series(Truck) Steering: LHD Front Axle: AM61 Type: P113 EK8x4L, R113 EK 8x4L Chassis: CH 1167918- SSS CH 4298541- SNL Front Axle: AM70 Type: P93 4x2 or 6x2/4 or 8x2/4, P113, R113 8x2, P113 EK6x4L, R143 8x2/4 Chassis: CH 1165791- SSS CH 4297219- SNL Type: P113 8x2/4, R113 8x2/4, R143 8x4, R143 EK8x4L Type: P113 EK8x4L, R113 EK 8x4L Chassis: CH 1167918- SSS CH 4298541- SNL	1300284	L= 765 Ø= 50	
SIDEM NR: 625236			
3 Series(Truck) Steering: LHD Type: P93 6x2/4, 8x2, 8x4 P113 8x2, 8x4 R113, R143 6x2/4 P143, R143 8x2 Chassis: CH -1165790 SSS CH -4297218 SNL Steering: RHD Type: P93 MK8x4R, P113 8x4, R113 8x4, R143 8x4, P143 8x4 Chassis: CH 1166002- SSS CH 4297219- SNL Type: P93 6x2/4 or 8x4, P113 6x2/4 or 8x4, R113 6x2/4, R143 6x2/4 Front Axle: AM56 Type: P113 MK8x4R Front Axle: AM61 Type: P113 MK8x4R, EK8x4R	389867	L= 784 Ø= 42	





TYPES	Oe nr.	Dimensions	Drawing
SIDEM NR: 62839			
3 Series(Truck) Type: P93, P113, R113, R143 Subtype: 6x2, 6x4 Chassis: CH 1185688- SSS CH 4318985- SNL	1334139 1304569	L= 786	
SIDEM NR: 625135			
3 Series(Truck) Steering: LHD Front Axle: AMA61 Type: P93, P113 Chassis: CH 1165791- 1185674 SSS CH 4297219- 4318946 SNL	1316872	L= 800	





LINK RODS

SCANIA

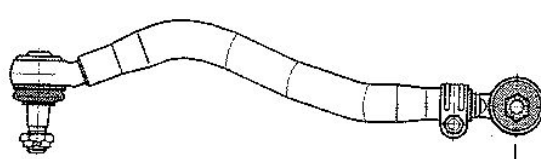
TYPES	Oe nr.	Dimensions	Drawing
SIDEM NR: 625136			
3 Series(Truck) Steering: LHD Type: P93 6x2/4 or 8x2/4, R143 6x2/4 Chassis: CH 1165791- SSS CH 4297219- SNL Type: P93, R143 Subtype: 6x2, 6x4 Chassis: CH 1165791-1185687 SSS CH 4297219-4318984 SNL Type: P93, R143 Subtype: 6x2, 6x4 Chassis: CH 1185688- SSS CH 4318985- SNL Type: P113 6x2/4, R113 6x2/4 Front Axle: AM56/61 Type: R143 Subtype: 8x2 Chassis: CH 1165791- SSS CH 4297219- SNL Type: P113, R113 Subtype: MK8x4L Chassis: CH 1167918- SSS CH 4298541- SNL Type: P113 8x2 or 8x4, R113 8x2 or 8x4, R143 8x4 or EK8x4L Front Axle: AM61 Only Type: P93, P93 MK6x4L, P113 4x2 or HK6x4L or EK6x4L Chassis: CH 1165791- SSS CH 4297219- SNL Type: P93 HK6x4L or MK6x4L, P113 HK8x4L or EK8x4L, P113 HK8x4L or EK8x4L Chassis: CH 1167918- SSS CH 4298541- SNL Front Axle: AMA61 Type: P93, P93 4x2 or 6x2, P113, R113 4x2 or 6x2 Front Axle: AM800/820 Type: P113 8x2 or 8x4, R113 8x2 or 8x4, R143 8x4 or EK8x4L Type: P93, P113, P113 4x2 or 6x2/4, R113 4x2 or 6x2/4, R143 8x2 Chassis: CH 1165791- SSS CH 4297219- SNL	1324483 1305012	L= 800 Ø= 52	 62330





TYPES	Oe nr.	Dimensions	Drawing
SIDEM NR: 625133			
3 Series(Truck) Steering: LHD Front Axle: AMA56/61 Type: R93, R113, R143 Chassis: CH 1165791- SSS CH 4297219- SNL	1112511	L= 843 Ø= 50	<p>62330</p>
SIDEM NR: 62833			
3 Series(Truck) Steering: LHD Front Axle: AM56/AM61 Type: R93, R113, R143 Chassis: CH 1165791- SSS CH 4297219- SNL Type: R143 Chassis: CH -1165790 SSS CH -4297218 SNL Type: R113 Front Axle: AM61 only Type: R93 HK6x4L, R113 HK6x4L, R113 EK6x4L, R143 HK6x4L, R143 EK6x4L Chassis: CH 1165791- SSS CH 4297219- SNL Type: R143 HK6x4L, R143 EK6x4L Front Axle: AMA56/AMA61 Type: R113 Type: R143 Chassis: CH 1165791- SSS CH 4297219- SNL Front Axle: AM800/AM820 Type: R93, R113, R143, R93 HK6x4L, R113 HK6x4L, R143 HK6x4L Chassis: CH 1165791- SSS CH 4297219- SNL Type: R113 Front Axle: AM800 only Type: R143 Chassis: CH 4340772- SNL Front Axle: AM820 Only Type: R143 Chassis: CH 1208341- SSS CH 9005946- SAN	390784	L= 855 Ø= 42	<p>62330</p>
SIDEM NR: 625035			
3 Series(Bus) Remark: Drag link, Tracket connection Chassis: CH 1823247- SBK	458429	L= 869 Ø= 30	<p>62330</p>





LINK RODS

SCANIA

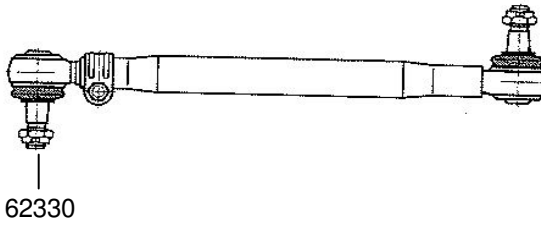
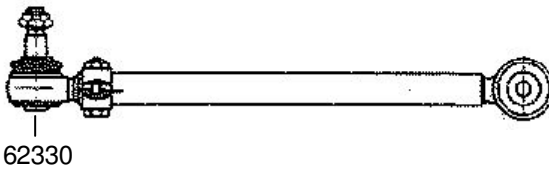
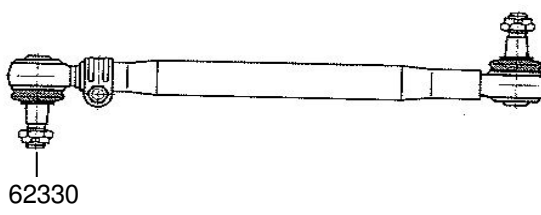
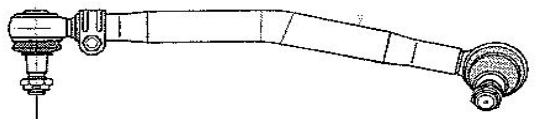
TYPES	Oe nr.	Dimensions	Drawing
SIDEM NR: 625234			
4 Series(Bus) Steering: LHB Type: K94 EB 6x2LI/NI, K94 EB 4x2LI Remark: Front overhang 2500 mm Type: K94 EB 6x2 LI Remark: Front overhang 2075 mm Type: K114/124 EB 4x2 or 6x2 LI Remark: With or without front overhang 2075, 2500 mm Only for Chassis: CH-1836490 SBK CH-3513710 SLA Type: K94 EB, K124 EB Chassis: CH -3513710 SLA CH -1836490 SBK CH -1843282 SSS	475463	L= 870 Ø= 48	 62330 <i>bush: Sidem ref. 62141</i>
SIDEM NR: 625137			
3 Series(Truck) Steering: LHD Front Axle: AM56/AM61 Type: T93, T113, T143	1369917 382774	L= 873 Ø= 40	 62330
SIDEM NR: 625235			
4 Series(Bus) Steering: LHB Type: K94 EB 6x2LI/NI Remark: Front overhang 2075 mm Type: K94 EB 6x2 NI, K94 EB 4x2 or 6x2 LI Remark: Front overhang 2500 mm Type: K114/124 EB 4x2 or 6x2 or 6x2*4 LI/NI Remark: Front overhang 2075, 2500 mm Only for Chassis: CH-1836490 SBK CH-3513710 SLA Type: K94 EB, K114 EB, K124 EB Chassis: CH -3513710 SLA CH -1836490 SBK CH -1843282 SSS	1432723	L= 882	 62330 <i>bush: Sidem ref. 62141</i>
SIDEM NR: 625032			
3 Series(Bus) Remark: Drag link, Tracket connection Chassis: CH 1823246- SBK	412406	L= 898 Ø= 50	 62330









TYPES	Oe nr.	Dimensions	Drawing
SIDEM NR: 625236			
3 Series(Truck) Steering: LHD Front Axle: AM70 Type: P93 4x2 or 6x2/4, P113, R113, R143 Chassis: CH -1165790 SSS CH -4297218 SNL	345124	L= 927	
SIDEM NR: 62334			
2 Series(Truck) Steering: LHD Front Axle: AM55 Type: G82(M), P82(M), G112(M), P112(M), R112(M), R142 Front Axle: AM60 Type: G82, P82, G112, P112, R112, R142 Front Axle: AM70 Type: R142 3 Series(Truck) Type: P113 HK6x4L Steering: LHD Front Axle: AM56 Type: G93, P93, R93, P113, R113, R143 Front Axle: AM61 Type: G93, P93, R93, P113, R113, R143 Only for Chassis: CH -1165790 SSS CH -4297218 SNL	278665	L= 947 Ø= 48	
SIDEM NR: 62335			
2 Series(Truck) Steering: LHD Front Axle: AM55 Type: G82(M), P82(M), G112(M), P112(M), R112(M), R142 Front Axle: AM60 Type: G82, P82, G112, P112, R112, R142 Front Axle: AM70 Type: R142 Only for types with 24" wheels and/or 8 leaves springs and anti-roll bar 3 Series(Truck) Type: P113 HK6x4L Steering: LHD Front Axle: AM56 Type: G93, P93, R93, P113, R113, R143 Front Axle: AM61 Type: G93, P93, R93, P113, R113, R143 Only for Chassis: CH -1165790 SSS CH -4297218 SNL	306981	L= 947 Ø= 48	





LINK RODS

SCANIA

TYPES	Oe nr.	Dimensions	Drawing
SIDEM NR: 62336			
2 Series(Truck) Steering: RHD Front Axle: AM55 Type: G82(M), P82(M), G112(M), P112(M), R112(M), R142 Front Axle: AM60 Type: G82, P82, G112, P112, R112, R142 Front Axle: AM70 Type: R142 3 Series(Truck) Steering: RHD Type: P93 Front Axle: AM56 Type: P113, R113, R143 Front Axle: AM61 Type: P113, R113, R143 <i>Only for chassis:</i> CH -1166001 SSS CH -4297218 SNL	352635	L= 947 Ø= 48	
SIDEM NR: 62733			
3 Series(Truck) Steering: RHD Type: P93 Front Axle: AM56 Type: P113, R113 Front Axle: AM56 Type: P113, R113 <i>Only for types with 6 and 7 spring-leaves and 40mm distance plate on right side, with 6 and 7 spring-leaves and swaying stabilizer and 20mm distance plate on right side, With 8 springleaves and 20mm distance plate on right side or with 8 springleaves and swaying stabilizer.</i> <i>Only for Chassis:</i> CH -1166001 SSS CH -4297218 SNL	352637	L= 947 Ø= 48	
SIDEM NR: 625037			
3 Series(Bus) Steering: LHD Remark: Drag link	466335	L= 992 Ø= 48	
SIDEM NR: 625038			
3 Series(Bus) Steering: RHD	466336	L= 992 Ø= 48	
SIDEM NR: 62536			
2 Series(Bus) Type: K112 Remark: Rear - air suspension	415400	L= 1015 Ø= 40	







TYPES	Oe nr.	Dimensions	Drawing
SIDEM NR: 625033			
3 Series(Bus) Remark: Air suspension, Bracket connection Chassis: CH -1823419 SBK	417676	L= 1015 Ø= 52	<p>62330</p>
SIDEM NR: 62138			
4 Series(Truck) Steering: LHD Type: P D4x2, P DB6x2/4, P DB6x2/4 NA/NB, P GB8x2/4 NA/NB, R GB8x2/4 NA/NB, P DA4x2, P DB4x2, P G6x2*4 Type: P CB8x4, R CB8x4, P GB8x2*6, R GB8x2*6, P GB8x2 or 8x4 or 8x4*4, R GB8x2 or 8x4 or 8x4*4, P L/C/G4x2 or 6x2/4, R L/C/G4x2 or 6x2/4 Remark: Front axle distance 1940 Type: P GB8x4, R GB8x4 Remark: Front axle distance 1795 Type: P DB6x2*4, P L/GB6x2*4, R L/GB6x2*4 Chassis: CH 1222927- SSS Type: P LA6x2/4 (NA/NB), R LA6x2/4 (NA/NB) Chassis: CH 1233805-1239401 SSS CH -4392231 SNL P & R Series Steering: LHD Type: P L/D/C, R L/D/C Subtype: 4x2, 6x2, 6x4, 6x2*4 Type: P LA/DA, R LA/DA Subtype: 6x2, 6x4 Type: P LB/DB, R LB/DB Subtype: 6x2, 6x4, 6x2*4	1384025 1379072	L= 1059 Ø= 52	<p>62330</p>







TYPES	Oe nr.	Dimensions	Drawing
SIDEM NR: 625330			
3 Series(Truck) Steering: LHD Type: R143 Subtype: 6x2, 6x4 Chassis: CH 1135211-1165790 SSS Type: R113, R143 Subtype: 6x2, 6x4 Chassis: CH -1165790 SSS CH -4297218 SNL Type: P93, R113, P113, R143 Subtype: 6x2, 6x4 Chassis: CH 1165791-1185687 SSS CH 4297219-4318984 SNL Steering: RHD Type: P93, R113, P113, R143 Subtype: 6x2, 6x4 Chassis: CH -1166001 SSS CH -4297218 SNL Type: P93, R113, P113, R143 Subtype: 6x2, 6x4 Chassis: CH 1166002-1185687 SSS Type: P93, R113, P113, R143 Subtype: 6x2, 6x4 Chassis: CH 1185688- SSS CH 4318985- SNL	388942	L= 1150 Ø= 32	
SIDEM NR: 625335			
4 Series(Truck) Steering: LHD Type: P GB8x2/4 NA/NB, R GB8x2/4 NA/NB, R LB6x2/4 NA/NB Steering: RHD Type: P DB6x2/4 N FRONTLINE P & R Series Type: P LB/DB, R LB/DB Subtype: 6x2, 6x4	1385763	L= 1206 Ø= 38	
SIDEM NR: 625231			
4 Series(Bus) Steering: LHD Type: K94 IB 4x2 or 6x2 Type: K114 IB, K124 IB, 4x2 or 6x2 Remark: Front overhang 2075, 2340, 2500, 2700 mm Only for Chassis: CH-1836673 SBK CH-3514295 SLA	481217 478621	L= 1256 Ø= 62	 <p>62330</p> <p><i>bush: Sidem ref. 62140</i></p>



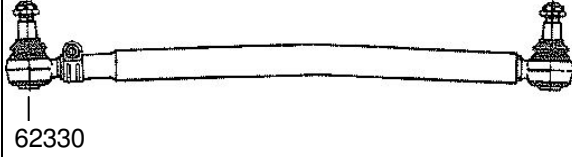

LINK RODS

SCANIA

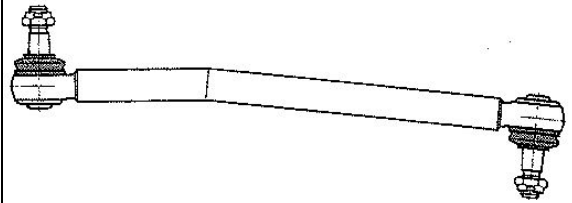
TYPES	Oe nr.	Dimensions	Drawing
SIDEM NR: 625030			
3 Series(Bus) Steering: LHD Remark: Drag link Chassis: CH 1823782- SBK	470271	L= 1385 Ø= 52	
SIDEM NR: 625031			
3 Series(Bus) Steering: RHD Remark: Drag link Chassis: CH 1823782- SBK	470272	L= 1385 Ø= 52	
SIDEM NR: 625331			
3 Series(truck) Steering: LHD Type: R143 6x2/4 Chassis: CH 1135211-1165790 SSS Type: P93 6x2/4 Chassis: CH -1165790 SSS CH -4297218 SNL Type: P93, R113, P113, R143 Subtype: 6x2, 6x4 Chassis: CH 1165791-1185687 SSS CH 4297219-4318984 SNL Type: P93, R113, P113, R143 Subtype: 6x2, 6x4 Chassis: CH 1185688- SSS CH 4318985- SNL	389879	L= 1470 Ø= 32	
SIDEM NR: 625337			
3 Series(Truck) Steering: RHD Type:P93 8x4 or MK8x4, R113 8x4, R143 8x4 Chassis: CH -1166001 SSS CH -4297218 SNL	1308644	L= 1590 Ø= 40	





TYPES	Oe nr.	Dimensions	Drawing
SIDEM NR: 625336			
3 Series(Truck) Steering: LHD Type: R143 8x4 or EK8x4L Type: P93 8x2/4, P113 8x2/4, P143 8x2 Chassis: CH -1165790 SSS CH -4297218 SNL Type: P93 8x2/4, R143 8x2 Chassis: CH 1165791- SSS CH 4297219- SNL Front Axle: AM56/AM61/AM70/AM800/ AM820 Type: P113, R113 Subtype: 8x2, 8x4 Front Axle: AM56/AM61 Type: P113 MK8x4L, R113 MK8x4L Chassis: CH 1167918- SSS CH 4298541- SNL Front Axle: AM61 Type: P113 HK8x4L, R113 HK8x4L Chassis: CH 1167918- SSS CH 4298541- SNL Front Axle: AM61/AM70 Type: P113 EK8x4L, R113 EK8x4L Chassis: CH 1167918- SSS CH 4298541- SNL Type: R143 EK8x4L Chassis: CH 4329779- SNL	1308643	L= 1590 Ø= 40	





LINK RODS

SCANIA





TYPES	Oe nr.	Dimensions	Drawing
SIDEM NR: 625239			
3 Series(Truck) Steering: LHD Type: P93, R113, R143 Subtype: 6x2, 6x4 Chassis: CH -1165790 SSS CH -4297218 SNL Type: P93, R113, P113, R143 Subtype: 6x2, 6x4 Chassis: CH 1165791-1185687 SSS CH 4297219-4318984 SNL Steering: RHD Type: P93, R113, P113, R143 Subtype: 6x2, 6x4 Chassis: CH -1166001 SSS CH -4297218 SNL Type: P93, R113, P113, R143 Subtype: 6x2, 6x4 Chassis: CH 1166002-1185687 SSS Type: R113 6x2/4 Chassis: CH 1185688- SSS CH 4318985- SNL	388941	L= 1601 Ø= 32	
SIDEM NR: 625338			
3 Series(Truck) Type: P93, P113, R113, R143 Subtype: 6x2, 6x4 Chassis: CH 1185688- SSS CH 4318985- SNL Steering: RHD Type: R113 6x2/4 Chassis: CH -1166001 SSS CH -4297218 SNL	1367641	L= 1601 Ø= 40	
SIDEM NR: 625430			
4 Series(Truck) Steering: LHD Type: P GB8x2/4 NA/NB, R GB6x2/4 NA/NB Chassis: CH 1228711- SSS CH 1239402- SSS CH 4391863- SNL CH 9031836- SAN CH 3500760- SLA Steering: RHD Type: P DB6x2/4 NA/NB/N FRONTLINE, P LB6x2/4 NA/NB, R LB6x2/4 NA/NB P&R Series Type: P LB/DB, R LB/DB Subtype: 6x2, 6x4	1385764	L= 1606 Ø= 38	

© Sidem nv 2006

SIDEM







TYPES	Oe nr.	Dimensions	Drawing
SIDEM NR: 625431			
4 Series(Truck) Steering: RHD Type: P DB6x2/4 N/ANB/N FRONTLINE, P LB6x2/4 N/ANB, R LB6x2/4 N/ANB P & R Series Type: P LB/DB, R LB/DB Subtype: 6x2, 6x4	1385765	L= 1806 Ø= 38	
SIDEM NR: 625333			
3 Series(Truck) Steering: LHD Type: P93, R113, P113, R143 Subtype: 6x2, 6x4 Chassis: CH 1185688- SSS CH 4318985- SNL	1336704	L= 1820 Ø= 32	
SIDEM NR: 625332			
3 Series(truck) Steering: LHD Type: R143 6x2/4 Chassis: CH 1135211-1165790 SSS Type: P93 6x2/4 Chassis: CH -1165790 SSS CH -4297218 SNL Type: P93, R113, P113, R143 Subtype: 6x2, 6x4 Chassis: CH 1165791-1185687 SSS CH 4297219-4318984 SNL	389880	L= 1870 Ø= 32	
SIDEM NR: 625334			
4 Series(Truck) Steering: LHD Type: P LA6x2/4, R LA6x2/4, R CB8x4, R GB8x2 or 8x4 Remark: Front axle distance 1940 P & R Series Steering: LHD Type: P LA/DA, R LA/DA Subtype: 6x2, 6x4	1491612 1343278	L= 1921 Ø= 62	
SIDEM NR: 625432			
4 Series(Truck) Steering: LHD Type: P LB6x2/4 N/ANB, R LB6x2/4 N/ANB Steering: RHD Type: P DB6x2/4 N/ANB/N FRONTLINE P & R Series Steering: LHD Type: P LB/DB, R LB/DB Subtype: 6x2, 6x4	1385766	L= 2006 Ø= 38	





LINK RODS

SCANIA

TYPES	Oe nr.	Dimensions	Drawing
SIDEM NR: 625433			
4 Series(Truck) Steering: LHD Type: P LB6x2/4 N/ANB, R LB6x2/4 N/ANB Type: P GB8x4, R GB8x4 Remark: Front axle distance 1795 Type: P GB8x2/4 N/ANB, R GB8x2/4 N/ANB Chassis: CH 1228711- SSS CH 4391863- SNL CH 9031836- SAN CH 3500760- SLA Steering: RHD Type: P DB6x2/4 N FRONTLINE P & R Series Type: P LB/DB, R LB/DB Subtype: 6x2, 6x4 Steering: RHD Type: P LA/DA, R LA/DA Subtype: 6x2, 6x4	1386618 1413981	L= 2179 Ø= 62	
SIDEM NR: 625237			
3 Series(Truck) Steering: LHD Type: P93, P113, R113, R143 Subtype: 6x2, 6x4 Chassis: CH 1185688- SSS CH 4318985- SNL	1481981 1336705	L= 2220 Ø= 32	









Type	Sidem	OE nr	A	B	C
Different types	62330	1358793 395010 283784	120	-	M30x1,5 rht
Different types	62331	1358792 395009 283783	120	-	M30x1,5 lht
Type	Sidem	OE nr	A	B	C
4 Series (Truck) 4 Series (Truck & bus)	62531	1357674	150	-	M30x1,5 rht
Type	Sidem	OE nr	A	B	C
3 Series (Truck) 3 Series (Bus) Front Axle: AM56, AM61 Front Axle: AMA56, AMA61	62432	310980	168	-	M52x1,5 rht
4 Series (Bus) Front Axle: AMA60, AMA60 SLA					
3 Series (Truck) 3 Series (Bus) Front Axle: AM56, AM61 Front Axle: AMA56, AMA61	62433	310979	168	-	M52x1,5 lht
4 Series (Bus) Front Axle: AMA60, AMA60 SLA					





TIE ROD ENDS

SCANIA

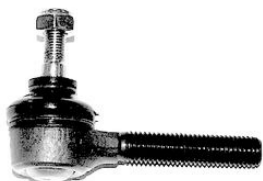
Type	Sidem	OE nr	Length	Heigth	Dimensions
Gear box control lever					
	62930	371452	55	-	M12x1,75 rht
	62931	371451	55	-	M12x1,75 lht
	62932	371453		-	
	62933	371448		-	
	62939	350270 243664	85	-	M14x2 rht



SCANIA TORQUE ROD REPAIR KITS





Type	OE nr	Dimensions	Drawing
Repair kits for Torque rods			
SIDEM NR: 62142			
3 Series(Truck) 4 Series(Truck & Bus) P&R Series(Truck)	0550800	Ø67 x 115 x Ø17	
SIDEM NR: 62141			
4 Series(Truck) P&R Series(Truck)	1498131	Ø67 x 115 x Ø19	
SIDEM NR: 14241			
3 Series(Truck & Bus) 4 Series(Truck & Bus)	1112506 0550806	Ø75 x 115 x Ø17	
SIDEM NR: 14246			
K112/113	0628862 0639287	Ø85 x 130 x Ø19	





SPRINGS

SCANIA

Type	OE nr	Dimensions	Drawing	
Spring pins				
SIDEM NR: 62161				
T92 Remark: 4x2 G/P/R 93 Remark: 4x2, MA4x2, ML4x2, MA6x2/4, ML6x2/4 T 93 Remark: 4x2 G/P/R 112 Remark: 4x2, MA4x2 P/R 113 exc EK/HK/MK 4x2, MA4x2 T 113 exc HK 4x2 K 113 CLB R 142 Remark: 4x2, MA4x2 T 142 Remark: 4x2 R 143 4x2, MA4x2, MA6x2/4 T 143 Remark: 4x2 C/G/L 124 Remark: 4x2, 4x4 G 144 Remark: 4x2	1364140	Ø32 x 168,5 M36 x 4		
SIDEM NR: 62162				
L66-L/LS/DL 75-DL/LS 76 L/LB80 L/LB81 - G/P/T82 L/LS/LB/LBS 85 L/LS/LB/LBS 86 L/LS/LB/LBS/LBT 110 L/LS/LT/LB/LBS/LBT 111 G/P/R/T/K 112 LBT/LBS 140 L/LS/LB/LBS/LBT 141 R/T/L142 G/R/P/T93 P/R/T113 R/T143	1960-1971 1969-1975 1979-> 1969-1975 1976-> 1968-> 1974-> 1979-> 1971-> 1979-> 1979-> 1979-> 1986-> 1986-> 1986->	355145 128681	Ø36,9 x 166 M28 x 4	
PARABOLIC				
C/D/L/G94 C/L/G 114 C/L/G 124 C/L/G 144 Remark for all: AM620 & AM740 2x30 front AM740, AM900 & AM920 2x32 front AM740, AM900 & AM920 3x29 front AM620 front & rear 8x2, 8x4, 8x2*6 2x30 AM920 front & rear 8x2, 8x4, 8x2*6 2x32 AM920 front & rear 8x2, 8x4, 8x2*6 3x29 AM900 front & rear 8x4Z 2x32 AM900 front & rear 8x4Z 3x29				
MULTI-LEAF				
C/D/L/G94 C/L/G 114 C/L/G 124 C/L/G 144 Remark for all: AM620 7x15 front AM920 9x15 front AM620 front & rear 8x4Z 7x15 AM920 front & rear 8x4Z 9x15 AM 7x15 front AM 9x15 front				





Type	OE nr	Dimensions	Drawing
SIDEM NR: 62163	period		
L66 - L/LS/DL 75 - DL/LS 76	1960-1971	355147	Ø46,9 x 168
L/LB 80 Remark: 3,5	1969-1975	135035	M36 x 4
L/LB 81	1979->		
G/P/T 82 Remark: 4x2	1979->		
L/LS/LB 85 Remark: 3,5	1969-1975		
L/LS 86	1976->		
LB/LBS 110 - L/LB/LBT 111	1974->		
Remark: 3,5			
G/P/R 112 Remark: 4x2-6x2	1979->		
LBT/LBS 140 Remark: 3,5	1971->		
L/LB/LBT 141-K112	1979->		
R142-T142-T112	1979->		
Remark: 4x2			
R/P/T 113	1986->		
Remark:4x2-6x2/4-ML6x4FB			
G/P/R/T93	1986->		
Remark: 4x2-6x2/4-6x4-8x4FB			
R/T 143 Remark: 4x2	1986->		
G/P/R93-P/R113	1986->		
Remark: Air suspension - Twin Stear Axle MA6x2/4A			
R143	1986->		
Remark: Air suspension - Twin Stear Axle MA 6 x 2/4 A Front rear axle 6 x 2/4			
PARABOLIC			
C/D/L/G94			
C/L/G 114			
C/L/G 124	1962->		
C/L/G 144			
Remark for all: AD1500 P4x2 3x26 + 2x26 AD1300 4x2 3x26 + 2x26			
MULTI-LEAF			
C/D/L/G94			
C/L/G 114			
C/L/G 124	1962->		
C/L/G 144			
Remark for all: AD1300 4x2 9x15 + 6x14 AD1300 4x2 7x15 + 6x14 AD1500 P4x2 7x15 + 6x14			





SPRINGS

SCANIA

Type	OE nr	Dimensions	Drawing
SIDEM NR: 62165	period		
L80 Remark: 4	1969 -1975	355148	Ø47 x 180
G82-P82-T82 Remark: 6x2	1979 ->	202333	M36 x 4
L/LS 85 Remark: 4	1969 -1975		
LBS85-L86-LB86	1976 ->		
LBS/LBT/LT 110 Remark: 4	1974 ->		
LS/LBS 111 Remark: 4	1974 ->		
G/P/R/T 112 Remark: 6x2	1979 ->		
LBT140-LBS140 Remark: 4	1971 ->		
LS/LBS 141	1979 ->		
R142-T142 Remark: 6x2	1979 ->		
R113-P113-T113	1986 ->		
Remark: 6x2, 8x2			
G93-P93-R93-T93	1986 ->		
Remark: 6x2			
R143-T143	1986 ->		
Remark: 6x2, 8x2			
PARABOLIC			
C/D/L/G94			
C/L/G114			
C/L/G124			
C/L/G144			
Remark for all: AD 6x2, 8x2, 5x22			
MULTI-LEAF			
C/D/L/G94			
C/L/G114			
C/L/G124			
C/L/G144			
Remark for all: AD 6x2, 8x2 1x15 + 10x13			
SIDEM NR: 62166	period		
Four spring bogie	1980->	355149	sq71 x 172 M36 x 4





Type	OE nr	Dimensions	Drawing
Spring bushings			
SIDEM NR: 62172	period		
L66-L/LS/DL 75-DL/LS 76	1960-1971	128680	
L/LB80	1969-1975		
L/LB81 - G/P/T82	1979->		
L/LS/LB/LBS 85	1969-1975		
L/LS/LB/LBS 86	1976->		
L/LS/LB/LBS/LBT 110	1968->		
L/LS/LT/LB/LBS/LBT 111	1974->		
G/P/R/T/K 112	1979->		
LBT/LBS 140	1971->		
L/LS/LB/LBS/LBT 141	1979->		
R/T/L142	1979->		
G/R/P/T93	1986->		
P/R/T113	1986->		
R/T143	1986->		
PARABOLIC			
C/D/L/G 94			
C/L/G 114			
C/L/G 124			
C/L/G 144			
Remark for all:			
AM620 & AM740 2x30 front			
AM740, AM900 & AM920 2x32 front			
AM740, AM900 & AM920 3x29 front			
AM620 front & rear 8x2, 8x4, 8x2*6 2x30			
AM920 front & rear 8x2, 8x4, 8x2*6 2x32			
AM920 front & rear 8x2, 8x4, 8x2*6 3x29			
AM900 front & rear 8x4Z 2x32			
AM900 front & rear 8x4Z 3x29			
MULTI-LEAF			
C/D/L/G 94			
C/L/G 114			
C/L/G 124			
C/L/G 144			
Remark for all:			
AM620 7x15 front			
AM920 9x15 front			
AM620 front & rear 8x4Z 7x15			
AM920 front & rear 8x4Z 9x15			
AM 7x15 front			
AM 9x15 front			





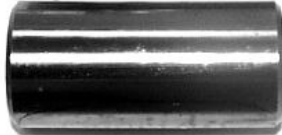

SPRINGS

SCANIA

Type	OE nr	Dimensions	Drawing
SIDEM NR: 62173	period		
L66 - L/LS/DL 75 - DL/LS 76	1960-1971	Ø46 x 89 M36 x 4	
L/LB 80 Remark: 3,5	1969-1975		
L/LB 81	1979->		
G/P/T 82 Remark: 4x2	1979->		
L/LS/LB 85 Remark: 3,5	1969-1975		
L/LS 86	1976->		
LB/LBS 110 - L/LB/LBT 111	1974->		
Remark: 3,5			
G/P/R 112 Remark: 4x2-6x2	1979->		
LBT/LBS 140 Remark: 3,5	1971->		
L/LB/LBT 141-K112	1979->		
R142-T142-T112	1979->		
Remark: 4x2			
R/P/T 113	1986->		
Remark:4x2-6x2/4-ML6x4FB			
G/P/R/T93	1986->		
Remark: 4x2-6x2/4-6x4-8x4FB			
R/T 143 Remark: 4x2	1986->		
G/P/R93-P/R113	1986->		
Remark: Air suspension - Twin Stear Axle MA6x2/4A			
R143	1986->		
Remark: Air suspension - Twin Stear Axle MA 6 x 2/4 A Front rear axle 6 x 2/4			
Four spring bogie	1980->		
PARABOLIC			
C/D/L/G94	1962->		
C/L/G114			
C/L/G124			
C/L/G144			
Remark for all: AD1500 P4x2 3x26 + 2x26 AD1300 4x2 3x26 + 2x26			
MULTI-LEAF			
C/D/L/G94	1962->		
C/L/G114			
C/L/G124			
C/L/G144			
Remark for all: AD1300 4x2 9x15 + 6x14 AD1300 4x2 7x15 + 6x14 AD1500 P4x2 7x15 + 6x14			



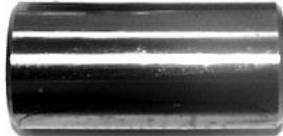





Type	OE nr	Dimensions	Drawing	
SIDEM NR: 62174				
period				
L80 Remark: 4 G82-P82-T82 Remark: 6x2 L/LS 85 Remark: 4 LBS85-L86-LB86 LBS/LBT/LT 110 Remark: 4 LS/LBS 111 Remark: 4 G/P/R/T 112 Remark: 6x2 LBT140-LBS140 Remark: 4 LS/LBS 141 R142-T142 Remark: 6x2 R113-P113-T113 Remark: 6x2, 8x2 G93-P93-R93-T93 Remark: 6x2 R143-T143 Remark: 6x2, 8x2	1969 -1975 1979 -> 1969 -1975 1976 -> 1974 -> 1974 -> 1979 -> 1971 -> 1979 -> 1979 -> 1986 -> 1986 -> 1986 ->	135698	Ø46 x 102 M36 x 4	
PARABOLIC C/D/L/G 94 C/L/G 114 C/L/G 124 C/L/G 144 Remark for all: AD 6x2, 8x2, 5x22				
MULTI-LEAF C/D/L/G 94 C/L/G 114 C/L/G 124 C/L/G 144 Remark for all: AD 6x2, 8x2 1x15 + 10x13				
SIDEM NR: 62272				
T92-T142 T93-T113 G112-P112-R112-R142 Remark for all: CH9012601-SAN-> CH4356550-SNL-> CH1217336-SSS->	1362710 0255669	Ø65 x Ø30 x 122		
SIDEM NR: 62270				
G82 - P82 M112 - P112 - R113 R142 G93 - P93 - R93 P113 - R113 R143 Remark for all: ML4x2A/B-6x2/4-ML6x2A/B CH1159365 SSS->, CH4290504 SN-> MV6x2B 6x2/4 - rear rear axle	255669	Ø65,15xØ30,4x122		







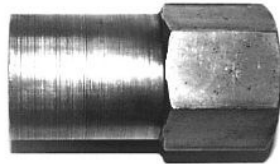

SPRINGS

SCANIA

Type		OE nr	Dimensions	Drawing
SIDEM NR: 62271	period			
G93 - P93 - R93 P113 - R113 - R143 Remark for all: ML6x2 A ->CH1159364 SSS ->CH4290503 SN	1986->	362385	Ø65,15xØ30,4x122	
Spring bolts				
SIDEM NR: 62260				
G82 - P82 M112 - P112 - R113 R142		255315	M30 x 3,5 x 245	
G93 - P93 - R93 P113 - R113 R143 Remark for all: ML4x2A/B-6x2/4-ML6x2A/B CH1159365 SSS->, CH4290504 SN-> MV6x2B 6x2/4 - rear rear axle				
T92 - T142 T93 - T113 G112 - P112 - R112 - R142 Remark for all: CH9012601-SAN-> CH4356550-SNL-> CH1217336-SSS->				
Spring nuts				
SIDEM NR: 62143				
LS55-LS56-LS76 L80/LB80 L/LB/LBS/LS85 L/LB/LS110 L/LB/LS111 LB140-LBS140	1960-1971 1969-1975 1968-1975 1968-1975 1968-1975 1971-1975	137831 0265768	M22 x 2,5	
SIDEM NR: 62262				
		811911	M30 x 3,5 SW46	
Spring washers				
SIDEM NR: 62261				
		272449	Ø105 x Ø30,5 x 6	





Type	OE nr	Dimensions	Drawing
SIDEM NR: 62263			
	367494	Ø105 x Ø30,5 x 26	
SIDEM NR: 62264			
	117830	Ø107 x Ø75 x Ø30,3 x 16	
SIDEM NR: 62265			
	1367370	Ø107 x Ø30,5 x 16	
Spring O-rings			
SIDEM NR: 62073			
	182929 128823	Ø36 x Ø24 x 6	
SIDEM NR: 62074			
	182931 135037	Ø44 x Ø32 x 6	





SPRINGS

SCANIA

Type	OE nr	Dimensions	Drawing
Spring pin kits			
SIDEM NR: 62162 KIT	Period	Contains (SIDEM NR)	
L66-L/LS/DL 75-DL/LS 76	1960-1971	Spring pin (62162)	
L/LB80	1969-1975	Spring bush (62172)	
L/LB81 - G/P/T82	1979->	O-ring (62073)	
L/LS/LB/LBS 85	1969-1975		
L/LS/LB/LBS 86	1976->		
L/LS/LB/LBS/LBT 110	1968->		
L/LS/LT/LB/LBS/LBT 111	1974->		
G/P/R/T/K 112	1979->		
LBT/LBS 140	1971->		
L/LS/LB/LBS/LBT 141	1979->		
R/T/L142	1979->		
G/R/P/T93	1986->		
P/R/T113	1986->		
R/T143	1986->		
PARABOLIC			
C/D/L/G94			
C/L/G114			
C/L/G124			
C/L/G144			
Remark for all: AM620 & AM740 2x30 front AM740, AM900 & AM920 2x32 front AM740, AM900 & AM920 3x29 front AM620 front & rear 8x2, 8x4, 8x2*6 2x30 AM920 front & rear 8x2, 8x4, 8x2*6 2x32 AM920 front & rear 8x2, 8x4, 8x2*6 3x29 AM900 front & rear 8x4Z 2x32 AM900 front & rear 8x4Z 3x29			
MULTI-LEAF			
C/D/L/G94			
C/L/G114			
C/L/G124			
C/L/G144			
Remark for all: AM620 7x15 front AM920 9x15 front AM620 front & rear 8x4Z 7x15 AM920 front & rear 8x4Z 9x15 AM 7x15 front AM 9x15 front			





Type	OE nr	Dimensions	Drawing
SIDEM NR: 62163 KIT	Period	Contains (SIDEM NR)	
L66 - L/LS/DL 75 - DL/LS 76	1960-1971	Spring pin (62163)	
L/LB 80 Remark: 3,5	1969-1975	Spring bush (62173)	
L/LB 81	1979->	O-ring (62074)	
G/P/T 82 Remark: 4x2	1979->		
L/LS/LB 85 Remark: 3,5	1969-1975		
L/LS 86	1976->		
LB/LBS 110 - L/LB/LBT 111	1974->		
Remark: 3,5			
G/P/R 112 Remark: 4x2-6x2	1979->		
LBT/LBS 140 Remark: 3,5	1971->		
L/LB/LBT 141-K112	1979->		
R142-T142-T112	1979->		
Remark: 4x2			
R/P/T 113	1986->		
Remark:4x2-6x2/4-ML6x4FB			
G/P/R/T93	1986->		
Remark: 4x2-6x2/4-6x4-8x4FB			
R/T 143 Remark: 4x2	1986->		
G/P/R93-P/R113	1986->		
Remark: Air suspension - Twin Stear Axle MA6x2/4A			
R143	1986->		
Remark: Air suspension - Twin Stear Axle MA 6 x 2/4 A Front rear axle 6 x 2/4			
SIDEM NR: 62165 KIT	Period	Contains (SIDEM NR)	
L80 Remark: 4	1969 -1975	Spring pin (62165)	
G82-P82-T82 Remark: 6x2	1979 ->	Spring bush (62174)	
L/LS 85 Remark: 4	1969 -1975	O-ring (62074)	
LBS85-L86-LB86	1976 ->		
LBS/LBT/LT 110 Remark: 4	1974 ->		
LS/LBS 111 Remark: 4	1974 ->		
G/P/R/T 112 Remark: 6x2	1979 ->		
LBT140-LBS140 Remark: 4	1971 ->		
LS/LBS 141	1979 ->		
R142-T142 Remark: 6x2	1979 ->		
R113-P113-T113	1986 ->		
Remark: 6x2, 8x2			
G93-P93-R93-T93	1986 ->		
Remark: 6x2			
R143-T143	1986 ->		
Remark: 6x2, 8x2			
SIDEM NR: 62166 KIT	Period	Contains (SIDEM NR)	
Four spring bogie	1980->	Spring pin (62166) Spring bush (62173) O-ring (62074)	









SPRINGS

SCANIA

Type	OE nr	Dimensions	Drawing
SIDEM NR: 62260 KIT			
G82 - P82 M112 - P112 - R113 R142		Spring bolt (62260) Spring bush (62270) Washer (62261)	
G93 - P93 - R93 P113 - R113 R143 Remark for all: ML4x2A/B-6x2/4-ML6x2A/B CH1159365 SSS->, CH4290504 SN-> MV6x2B 6x2/4 - rear rear axle		Nut (62262)	
SIDEM NR: 62263 KIT			
G93 - P93 - R93 P113 - R113 R143 Remark for all: ML4x2A/B-6x2/4-ML6x2A/B CH1159365 SSS->, CH4290504 SN-> MV6x2B 6x2/4 - rear rear axle		Spring bolt (62260) Spring bush (62270) Washer (62264) Nut (62262)	
SIDEM NR: 62264 KIT			
T92-T142 T93-T113 G112-P112-R112-R142 Remark for all: CH9012601-SAN-> CH4356550-SNL-> CH1217336-SSS->		Spring bolt (62260) Spring bush (62272) Washer (62261) Nut (62262)	
SIDEM NR: 62265 KIT			
T92-T142 T93-T113 G112-P112-R112-R142 Remark for all: CH9012601-SAN-> CH4356550-SNL-> CH1217336-SSS->		Spring bolt (62260) Spring bush (62272) Washer (62265) Nut (62262)	











Type	OE nr	Dimensions	Drawing
SIDEM NR: 62360			
T 92-G/P/R 112 R/T 142 G/P/R/T 93-P/R/T 113 K 113CBL-R/T 143 114 G-124 C/G/L-144 G/L	1429110 310808	20,5 x 58 x 30,5	
SIDEM NR: 62361			
T 92-G/P/R 112 R/T 142 G/P/R/T 93-P/R/T 113 K 113CBL-R/T 143	213604	40 x 57,5 x 120	
SIDEM NR: 62364			
T 92-R/T 142 G/P/R/T 93-P/R/K/T 113 R/T 143 <i>Series 3(Truck & Bus)</i> <i>Series 4(Truck)</i>	295751	49,5 x 107 x 100	
SIDEM NR: 62362			
G/P/R/T 93-P/R 113 R/T 143 114 G-124 C/G/L 144 G/L	228483	50 x 70 x 100	
SIDEM NR: 62363			
P 93-K 113-R 143 P 94-T 114-R 124	1344190	65 x 103 x 103,5	



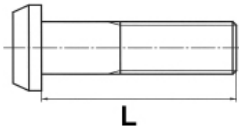

WHEEL PARTS

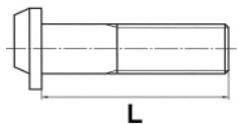
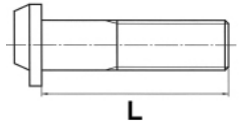
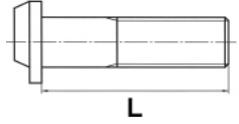
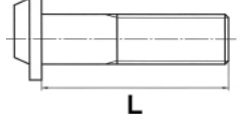
SCANIA

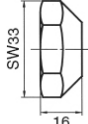

Type	OE nr	Dimensions	Drawing
Bolts (all front)			
SIDEM NR: 62116			
3 & 4 Series(Bus) 3 & 4 Series(Truck) P&R Series(Truck)	1368690 397266 290062	7/8" x 11BSF x L=67 RHT	
SIDEM NR: 62119			
3 & 4 Series(Truck) P&R Series(Truck)	1368694 272853	7/8" x 11BSF x L=70 LHT	
SIDEM NR: 62117			
3 & 4 Series(Truck) P&R Series(Truck)	1368691 332912	7/8" x 11BSF x L=74 RHT	
SIDEM NR: 62118			
3 & 4 Series(Bus) 3 & 4 Series(Truck) P&R Series(Truck)	1368693 295953	7/8" x 11BSF x L=86 LHT	
SIDEM NR: 62014			
old application all types	123250	7/8" x 11BSF x L=74 RHT	
SIDEM NR: 62015			
old application all types	123249	7/8" x 11BSF x L=74 LHT	
SIDEM NR: 62018			
old application all types	132602 123295 121302	7/8" x 11BSF x L=90 RHT	
SIDEM NR: 62019			
old application all types	132601 123293 121301	7/8" x 11BSF x L=90 LHT	
Nuts			
SIDEM NR: 62026			
Spherical inner nut	121306	7/8" x 11BSF RHT	
SIDEM NR: 62027			
Spherical inner nut	121305	7/8" x 11BSF LHT	

SIDEM



© Sidem nv 2006

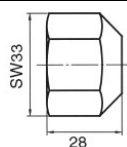
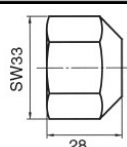
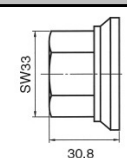
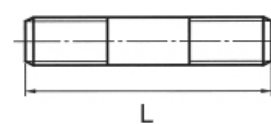

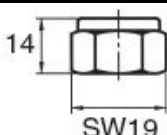
Type	OE nr	Dimensions	Drawing
SIDEM NR: 62024			
<i>Spherical outer nut</i>	120913	7/8" x 11BSF RHT	
SIDEM NR: 62025			
<i>Spherical outer nut</i>	120912	7/8" x 11BSF LHT	
SIDEM NR: 62120			
<i>Flat collar nut</i>	318690 243956	7/8" x 11BSF RHT	
Studs			
SIDEM NR: 62057			
<i>Stud</i>	1340934 176815	M12 x 1,75 - L=60	
SIDEM NR: 62155			
<i>guide fitting</i>	41181	Ø20 x Ø12 x 10	
SIDEM NR: 62256			
<i>nut</i>	1340933 815148	M12 x 1,75	





CROSS REFERENCE GUIDE

SCANIA

OE nr	SIDEM nr	Page	OE nr	SIDEM nr	Page	OE nr	SIDEM nr	Page
#	62162 KIT	39	1340934	62057	44	243956	62120	44
#	62163 KIT	40	1343266	62231	12	255315	62260	37
#	62165 KIT	40	1343278	625334	26	255669	62270	36
#	62166 KIT	40	1343283	62139	11	272449	62261	37
#	62180 SAM	2	1344190	62363	42	272853	62119	43
#	62182 SAM	2	1348025	62138	20	278665	62334	18
#	62184 KIT SR	3	135035	62163	32	283766	62339	6
#	62184 SET SR	3	135036	62173	35	283783	62331	28
#	62185 KIT SR	3	135037	62074	38	283784	62330	28
#	62185 SAM	3	135698	62174	36	290062	62116	43
#	62185 SET SR	3	1357674	62531	28	291396	62436	13
#	62186 KIT SR	4	1358792	62331	28	295751	62364	42
#	62186 SET SR	4	1358793	62330	28	295953	62118	43
#	62187 BB	4	1362710	62272	36	300308	62337	12
#	62260 KIT	41	1364140	62161	31	306913	62338	12
#	62263 KIT	41	1367370	62265	38	306981	62335	18
#	62264 KIT	41	1367641	625338	25	310808	62360	42
#	62265 KIT	41	1368690	62116	43	310977	62732	8
0255669	62272	36	1368691	62117	43	310979	62433	28
0265768	62143	37	1368693	62118	43	310980	62432	28
0550800	62142	30	1368694	62119	43	311847	62435	8
0550806	14241	30	1369917	62337	12	318690	62120	44
0628862	14246	30	1369917	62338	12	319359	62737	9
0639287	14246	30	1369917	625137	17	322747-7	62184 R	3,4,5
1112506	14241	30	137831	62143	37	323273-3	62183 B	2
1112511	625133	16	1378435	62132	9	332912	62117	43
117830	62264	38	1378436	62735	7	345124	625238	18
120912	62025	44	1378436	62837	6	350270	62939	29
120913	62024	44	1379072	62138	20	352635	62336	19
121301	62019	43	1384027	62232	21	352637	62733	19
121302	62018	43	1385763	625335	22	352643	62530	6
121305	62027	43	1385764	625430	25	355145	62162	31
121306	62026	43	1385765	625431	26	355147	62163	32
123249	62015	43	1385766	625432	26	355148	62165	33
123250	62014	43	1386618	625433	27	355149	62166	33
123293	62019	43	1394884	62233	11	362385	62271	37
123295	62018	43	1395614	62137	9	367494	62263	38
128680	62172	34	1397866	62730	8	371448	62933	29
128681	62162	31	1407186	62234	11	371451	62931	29
128823	62073	38	1409918	62133	6	371452	62930	29
1300284	62838	13	1413981	625433	27	371453	62932	29
1301106	62183 BB	2,3	1429110	62360	42	382774	625137	17
1304569	62839	14	1432723	625235	17	382780	625131	12
1305012	625136	15	1479120	625232	10	388941	625239	25
1308643	625336	24	1481981	625237	27	388942	625330	22
1308644	625337	23	1491612	625334	26	388943	62736	12
1316872	625135	14	1497223	625233	10	389867	625236	13
1318321	62180 BB	2	1498131	62141	30	389879	625331	23
1324483	625136	15	176815	62057	44	389880	625332	26
132601	62019	43	182929	62073	38	390784	62833	16
132602	62018	43	182931	62074	38	395009	62331	28
1334139	62839	14	202333	62165	33	395010	62330	28
1336704	625333	26	213604	62361	42	395347	62538	6
1336705	625237	27	226483	62362	42	395348	62837	6
1340933	62256	44	243664	62939	29	395350	62431	7





OE nr	SIDEM nr	Page	OE nr	SIDEM nr	Page	OE nr	SIDEM nr	Page
397266	62116	43						
41181	62155	44						
412406	625032	17						
415400	62536	19						
417676	625033	20						
421573	62535	21						
434493	625034	12						
450870	625036	12						
458429	625035	16						
466335	625037	19						
466336	625038	19						
466880	625039	10						
466881	625230	10						
470271	625030	23						
470272	625031	23						
475463	625234	17						
478621	625231	22						
478621	625233	10						
481217	625231	22						
492181	625232	10						
550257	62187 KIT	4						
550257	62187 KIT SR	4						
550257	62187 SET	4						
550257	62187 SET SR	4						
550284	62188 KIT	5						
550284	62188 KIT SR	5						
550284	62188 SET	5						
550284	62188 SET SR	5						
550722	62184 KIT	3						
550722	62184 SET	3						
550723	62180 KIT	2						
550723	62180 SET	2						
550730	62185 KIT	3						
550730	62185 SET	3						
550731	62186 KIT	4						
550731	62186 SET	4						
550732	62182 KIT	2						
550732	62182 SET	2						
811911	62262	37						
815148	62256	44						





INDEX

Page
Page
Seite

2-7	KING PIN SETS JEUX D'AXES DE FUSEE ACHSBOLZENZÄTZE
8-10	TRACK RODS BARRES DE DIRECTION SPURSTANGEN
11-26	LINK RODS BARRES D'ACCOUPEMENT LENKSCHUBSTANGEN
27-28	TIE ROD ENDS ROTULES DE DIRECTION KUGELGELENK
29	TORQUE RODS BARRES DE REACTION REAKTIONSSTANG
30-33	REPAIR KITS TORQUE ROD JEUX DE REPARATION DE BARRE DE REACTION REP.-SÄTZE FÜR REAKTIONSSTAG
34-45	SPRING PARTS PIECES DE RESSORT FEDERTEIL
46-50	STABILISER BEARINGS DOUILLES DE STABILISATEUR STABILISATORLAGER
51-53	WHEEL PARTS PIECES DE ROUE RADTEIL
54-55	CROSS REFERENCE GUIDE LISTE D'EQUIVALENCE VERGLEICHNUMMERNLISTE





SIDEM NR	DESCRIPTION			REMARKS
68086 KIT 68086 KIT SR	repair kit with bearing repair kit without bearing			Ø40/30 L=217
	OE	TYPE	PERIOD	APPLICATION
	276026 276011-4	B615 / B616 /	1955-70	LHD -> CH 1279 - RHD -> CH 1283
		B617	1955-70	LHD -> CH 1279 - RHD -> CH 1283
		B635	1955-70	LHD -> CH 526 - RHD -> CH 538
		F86 / FB86	1973-75	FA 5,0
		L395 / L397	1955-69	
		L398 / L399	1955-69	
		L485 / L4852	1961-70	
		L495 / L4952	1961-70	
		N86	1967-73	
		N88	1967-74	
		NB88	1967-74	
		N10	1974->	FA 5,0 (RHD) VB 2500
		N12	1974->	FA 5,0 (RHD) VB 2500
		N7	1974->	FA 5,0 (RHD) VB 2500
SIDEM NR	DESCRIPTION			REMARKS
68182 KIT 68182 KIT SR	repair kit with bearing repair kit without bearing			Ø45 L= 235
	OE	TYPE	PERIOD	APPLICATION
	276029 276014-8	B57 / B58	1965->	For steering knuckle 361.791
		B58	1965->	
		B715 / B755	1964-72	FA 6,0 FA253209-1, FA253210-9, FA253242-2, FA253249-7
		F86 / FB86	1975-78	
		F88 / FB88 / G 88	1967-78	
		F89 / G89	1971-78	FA253160-6, FA253210-9, FA253242-2, FA253209-1, FA 253249-7
		L4951 / L4956	1964-72	
		N10	1974-78	FA 6,5 - FA 7,0 VB2330 -> CH 14425 VB2500 LHD -> CH 12277 - RHD -> CH 14884 Peru -> CH 12795 FA 6,5 - FA 7,0 VB2330 -> CH 2253 VB2500 LHD -> CH 2083 - RHD -> CH 2283 Peru -> CH 2113 FA 6,5 - FA 7,0 VB2300 -> CH 4592 VB2500 LHD -> CH 4115 - incl. LHD CH 4652-> CH 4702 - RHD -> CH 4651
		N12	1974-78	
		N7	1974-78	
RELATED PART NUMBERS	OE	DESCRIPTION	DIMENSIONS	
68182 BM 68182 RO	191995 19451 183295	bush bi-metal bearing	L= 50	





KING PIN SETS

VOLVO

SIDEM NR	DESCRIPTION			REMARKS
68280 KIT	repair kit with bearing			Ø48 L= 235
68280 KIT SR	repair kit without bearing			
	OE	TYPE	PERIOD	APPLICATION
	276030	B10M	1978->	-> CH 2542
	276015-5	B10R	1978->	-> CH 2542
		B57	1976->	
		B58	1976->	For steering knuckle 1.571.509
		B9M	1978->	-> CH 2542
		F10	1979-94	FA 6,5 VB2500 -> CH 17252 - CH 18887 -> CH 18891
		F12	1979-94	FA 6,5 - FA 7,0 LHD -> CH 17531 RHD -> CH 34000
		F7	1978-85	8x2 8x4 -> CH 11346, Twinsteer
		F7	1979-85	4x2 6x2 6x4 FA 6,5 LHD VB2300 -> CH 15071 RHD Australia -> CH 570740
		F88 / FB88 / G88	1977-78	FA253265-3, FA253266-1, FA253279-4, FA253280-2
	F89 / G89	1977-78	FA253265-3, FA1580479-2, FA253280-2	
	N10	1979->	FA 6,5 - FA 7,0 VB2330 CH 14426 -> VB2500 LHD CH 12289 -> - RHD CH 14885 -> CH 36798 - excl. CH 36736 Peru CH 12796 ->	
	N12	1979->	FA 6,5 - FA 7,0 VB2330 CH 2254 -> VB2500 LHD CH 2084 -> CH 27670 - RHD CH 2284 -> Peru CH 2114 ->	
	N7	1979->	FA 6,5 - FA 7,0 VB2300 CH 4593 -> VB2500 LHD CH 4116 -> CH 10686 - excl. LHD CH 4652 -> CH 4702 - RHD CH 4652 ->	
RELATED PART NUMBERS	OE	DESCRIPTION	DIMENSIONS	
68182 RO	19451	bearing		
	183295			
68280 BM	1508438	bush bi-metal		





SIDEM NR	DESCRIPTION			REMARKS
68282 KIT	repair kit with bearing			Ø50 L= 250
68282 KIT SR	repair kit without bearing			
	OE	TYPE	PERIOD	APPLICATION
	3090266-2	B10B / LE		EXC (AUS) & (AUS) INCL SPCL S-4903
		B10M	1979->	CH 20001 ->
		B12	1994->	CH 1-4999
		B12	1994->	CH 5000-99999
		B12 (BR)	1994->	CH-350500, EXC CH 350075, CH 350079, CH 350149-350151, CH 350221-350223
		B12B	1994->	FWS-IL CH 100-13674
		B9M	1979->	CH 20001 ->
		F10	1990-94	FA 7,5 LHD FA 6,5 LHD with air spring CH 314000 -> FA 8,0 CH 314000 ->
		F12	1979-94	FA 7,5
		F12	1979-94	8x2 8x4 CH 34001 -> CH 313999 CH 314000 -> FA 13,0 - FA 15,0
		F12	1990-94	4x2 6x2 6x4 FA 6,5 LHD with air spring CH 314000 -> FA 8,0 CH 314000 ->
		F16	1987-94	4x2 6x2 6x4 FA 7,5 - FA 8,0
		F7	1979-85	4x2 6x2 6x4 FA 7,5 LHD
		FH16	1993->	CH A291152-A299999 TA-SELFS FRAX-BAS
		FH16	1993->	CH A263637,-B171252,-C755708-
		FH16	1993->	CH-A263636,-B171252,-D110119
		FH16	1993->	FH16J
		FL7	1989-98	4x2 6x2 6x4 FA 6,5 LHD with leaf springs FA 7,5 - exc. RHD Australia and LHD BGT 16 rear steer FA 8,0
		FL7	1989-98	8x2 8x4 LHD
		FL10	1989-98	4x2 6x2 6x4 FA 6,5 LHD with leaf springs FA 7,5 - exc. RHD Australia and LHD BGT 16 rear steer FA 8,0
		FL10	1989-98	8x2 8x4 LHD
		FL12	1995-98	4x2,6x2,6x4
		FM7	1998->	CH 1200635- TA-SELFS FRAX-BAS
		FM10	1998->	CH 0800000-0830610
		FM10	1998->	TA-SELFS FRAX-BAS BR CH E670784-
FM12	1998->	CH 1200634- TA-SELFS FRAX-BAS		
FM12	1998->	BR CH E670784-E686826		
FS7	1991-96	FAT 5.5, 6.7, 7.1, 7.5		
N10	1979->	FA 7,5 - FA 8,0		
N12	1979->	FA 7,5 - FA 8,0		
N7	1979->	FA 7,5		
NH12	1997->	CH D120066- BR 1999- CH E668761-E686826 BR 1999- CH E686834-E689494 CH T681238-T688830		
RELATED PART NUMBERS	OE	DESCRIPTION	DIMENSIONS	
68282 B 68282 R	1580413-1 1588222-8	bush bearing	L= 49	





KING PIN SETS

VOLVO



SIDEM NR	DESCRIPTION			REMARKS
68388 KIT	repair kit with bearing			Ø48 L= 235
68388 KIT SR	repair kit without bearing			
	OE	TYPE	PERIOD	APPLICATION
	3090267	B10M/ R	1983->	CH 2543 -> CH 20000 CH 350501-351315, INCL CH 350075, CH 350079, CH 350149-350151, CH 350221-350223.
		B12 (BR)	1994->	
		B12 (BR)	1994->	CH 351317-, INCL CH 318861, CH 318944, CH 318945
		B6	1983->	CH 2543 -> CH 20000
		B9M	1983->	
		F10	1983-94	FA 6,5 exc. LHD with air spring CH 314000 -> exc. CH 18887 -> CH 18891
		F12	1983-94	FA 7,0 LHD CH 17531 ->
		F12	1990-94	4x2 6x2 6x4 FA 6,5 exc. LHD with air spring CH 314000 ->
		F12	1990-94	CH 314000 -> 8x2 8x4 FA 12,0 Australia
		F16	1990-94	4x2 6x2 6x4 FA 6,5; 6x4 FA 12,0 Australia
		F6S	1982->	FA 6770772-9 / FA 6777132-9
		F7	1982-85	4x2 6x2 6x4 FA 6,5 LHD - FA 5,5 LHD VB2500 FA 6,5 RHD VB2500 - FA 6,5 LHD VB2300 CH 15072 -> FA 6,5 RHD Australia CH 570741
		F7	1982-85	8x2 8x4 CH 11347 ->
		FL616 / 617	1989-98	4x2 6x2 6x4 FA 6,5 exc. LHD with leaf springs FA 7,5 LHD BGT16 rear steer FA 7,5 RHD Australia
		FL7	1989-98	
		FL7	1989-98	8x2 8x4 RHD and Australia
		FL10	1989-98	4x2 6x2 6x4 FA 6,5 exc. LHD with leaf springs FA 7,5 LHD BGT16 rear steer FA 7,5 RHD Australia
		FL10	1989-98	8x2 8x4 RHD and Australia
		FL12	1995-98	4x2,6x2,6x4
		FS7	1991-96	Fat 6.0
N10	1979->	FA 6,5 - FA 7,0 VB2500 CH 36799 -> incl. CH 36736 FA 6,5 CH 49001 ->		
N10	1989->	VB2500 Peru CH 306000 ->		
N12	1979->	FA 6,5 - FA 7,0 VB2500 LHD CH 7671 > FA 6,5 CH 306000 -> VB2300 CH 306000 ->		
N12	1989->	VB2500 Peru CH 306000 ->		
N7	1979->	FA 6,5 - FA 7,0 VB2500 LHD CH 10687 -> FA 6,5 CH 12001 ->		
NL10	1991->	FAT 6.5 FAT 6.7		
NL12	1991->	FAT 6.5 FAT 6.7		
RELATED PART NUMBERS	OE	DESCRIPTION	DIMENSIONS	
68388 B 68182 RO	1588324 19451 183295	bush bearing	L= 49	

© Sidem nv 2006

SIDEM





SIDEM NR	DESCRIPTION			REMARKS
68480 KIT 68480 KIT SR	repair kit with bearing repair kit without bearing			Ø45.15 L= 192
	OE	TYPE	PERIOD	APPLICATION
	270920	FL608 FL611 FLC	1985-98 1985-98 1996-00	
RELATED PART NUMBERS	OE	DESCRIPTION	DIMENSIONS	
68480 B 68480 R	6774852-5 6782630-5	bush bearing	L= 30 H = 22.8	
SIDEM NR	DESCRIPTION			REMARKS
68482 KIT 68482 KIT SR	repair kit with bearing repair kit without bearing			Ø45.15 L= 220
	OE	TYPE	PERIOD	APPLICATION
	276193	FL612 FL614	1985-98 1985-98	
RELATED PART NUMBERS	OE	DESCRIPTION	DIMENSIONS	
68482 B 68482 R	6774853-3 6782631-3	bush bearing	L= 45 L= 25.5	
SIDEM NR	DESCRIPTION			REMARKS
68484 KIT 68484 KIT SR	repair kit with bearing repair kit without bearing			Ø60/Ø40 L=231,5
	OE	TYPE	PERIOD	APPLICATION
	3093731	B12B FH12 FH12 - FH16 FH12 - FH16 FM7 FM9 FM10 FM12 FM12 NH12	1994-> 1993 -> 1993-> 1993-> 1998-> 2001-> 1998-> 1998-> 1998-> 1997->	FWS-R - CH 100-13674 FAA10, FAA20 FRAX-UNI, BRAKE-DV FRAX-UNI, BRAKE-ZV (stuuras) FRAX-UNI, BRAKE-DV FAA10 FRAX-UNI, BRAKE-DV (FOR FAA10 FAA20 FRAX-UNI, BRAKE-DV FRAX-UNI, BRAKE-ZV FRAX-UNI, BRAKE-ZV TB-75537222-1 FAA10/FAA20, BRAKE-ZV,





KING PIN SETS

VOLVO

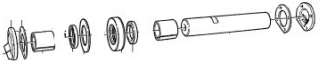
SIDEM NR	DESCRIPTION	REMARKS	
68486 KIT 68486 KIT SR	repair kit with bearing repair kit without bearing		
OE	TYPE	PERIOD	APPLICATION
	1699357	FL12	1995-98
		FM10	1998->
		FM12	1998->
			6x4,8x4 FA-STRAI FA-STRAI

SIDEM NR	DESCRIPTION	REMARKS		
68488 KIT 68488 KIT SR	repair kit with bearing repair kit without bearing			
OE	TYPE	PERIOD	APPLICATION	
	3092467	FH16	1993->	FRAX-UNI, BRAKE-ZV (stuuras
		FM7	1998->	FRAX-UNI, BRAKE-DV
		FM10	1998->	FRAX-UNI, BRAKE-DV (FOR
		FM10	1998->	BR CH E670784-
		FM12	1998->	FRAX-UNI, BRAKE-ZV
		FM12	1998->	BR CH E670784-E686826
		NH12	1997->	BR 1999- CH E668761-E686826 BR 1999- CH E686834-E689494 CH T681238-T688830





TYPES	Oe nr.	Dimensions	Drawing
SIDEM NR: 685539			
B10R Chassis: CH3000 -->	1135533		
SIDEM NR: 686435			
B10-B10BLE B10M Chassis: 46148-> FM7 Subtype: FAA20, VERS-AUS/BAS, TURN-TIG FM10 Subtype: FAA20, VERS-AUS/BAS, TURN-TIG Chassis: CH 0800000-X831642 FM12 Subtype: FAA20, VERS-AUS/BAS, TURN-TIG	8156123		
SIDEM NR: 686430			
FL6 FL608-611 Period: 5/1989-> FLC Period: 9/1996-9/2000	6771120	L= 1556 Ø= 32	
SIDEM NR: 686431			
FL614 Period: 5/1989->	6771112	L= 1582 Ø= 38	





TRACK RODS

VOLVO

TYPES	Oe nr.	Dimensions	Drawing
SIDEM NR: 685730			
F7 Subtype: 4x2, 6x2, 8x2, 8x4	1626494 1606274	L= 1592 Ø= 42	
F10 Subtype: FA6.5, FA7.5 with LHD Subtype: FA6.5, FA7.5, FA8.0 with LHD for 4x2, 6x2, 6x4 Chassis: CH 314000 ->			
F12 Subtype: 4x2, 6x2, 6x4, 6x6 Chassis: ->CH 313999 Subtype: FA6.5, FA 6.7, FA7.5, FA 8.0 with LHD for 4x2, 6x2, 6x4 Remark: Exc. low chassis, 6x6 & 4x4 Chassis: CH314000 -> Subtype: FA13.0, FA15.0 with 1st & 2nd axle for 8x2, 8x4			
F16 Subtype: FA6.5, FA7.5, FA8.0 with LHD for 4x2, 6x2, 6x4			
FL7 Subtype: 4x2, 6x2, 6x4 Subtype: 8x2, 8x4 with LHD, 1st & 2nd axle Subtype: Rear Steer			
FL10 Subtype: 4x2, 6x2, 6x4 for vehicles with leaf springs Subtype: 8x4 with LHD, 1st & 2nd axle Subtype: Rear steer			
FL12 Subtype: FAT6.5, FAT7.5 LHD or RHD - BLF for 4x2, 8x6, 6x4 Subtype: 8x4 LHD or RHD			
N10 Chassis: CH306000			
N12 Subtype: FA6.5, FA7, FA7.5 for 4x2, 6x2, 6x4 Remark: Exc. Switwerland and Norway, exc. Vehicles with spoked wheels, exc. Track 1740mm Chassis: CH306000			









TYPES	Oe nr.	Dimensions	Drawing
SIDEM NR: 686130			
F10 Remark: Vehicles with air spring front F12 Remark: Vehicles with air spring front FH12 FH16 FL10 Remark: with air suspension FL12 Subtype: FAT6.5, FAT7.5 LHD - LUF for 4x2, 8x6, 6x4 FM7 Subtype: FAA10, VERS-BAS, FRAX-BAS, STWPOS-L/R, FA-LOW FM10 Subtype: FAA10, STWPOS-L/R, FA-LOW, FRAX-BAS, VERS-BAS Chassis: CH 0800000-X831642 FM12 Subtype: FAA10,STWPOS-L, FRAX-BAS,FA-LOW	20393097 1612254	L= 1640 Ø= 50	
SIDEM NR: 686636			
FH12 Subtype: LHD/RHD/Australia FM7 Subtype: FAA20, VERS-BAS/AUS, TURN-BAS/TIG, STWPOS-L/R, FA-HIGH Subtype: RADT-LA, TA-SELFS/HYDRS Subtype: RAPD-A6, PA-STEER Remark: Rear suspension FM9 Subtype: FAA10, STWPOS-L/R, FSS-LEAF, FA-STRAI, FRAX-UNI, FAA20,FA-HIGH, FA2 FM10 Subtype: FAA10/20, STWPOS-R/L, FA-HIGH, VERS-BAS/AUS, TURN-BAS/TIG Chassis: CH 0800000-X831642 Subtype: FRAX-BAS, FRAX-UNI Chassis: BR CH E670784-> Subtype: Bogie TA-SELFS/TA-HYDRS/RAPD-A6/PA-STEER FM12 Subtype: FAA10/20, STWPOS-L/R, FFS-AIR/LEAF, VERS-AUS/BAS, TURN-BAS/TIG, FA-HIGH, FA-STRAI Subtype: TA-SELFS, TA-HYDRS NH12 Subtype: FRAX-UNI Subtype: FA-HIGH, FA-STRAI Remark: With powersteering	3986450 1628637	L= 1645 Ø= 42	





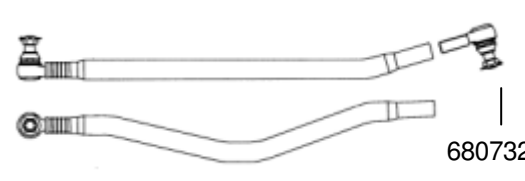

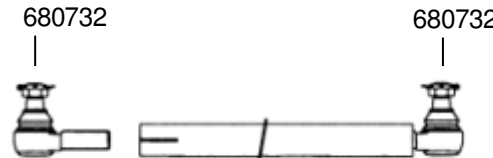
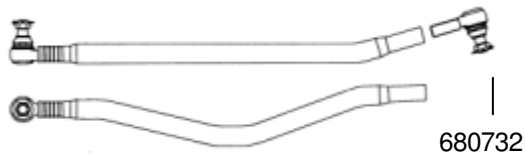
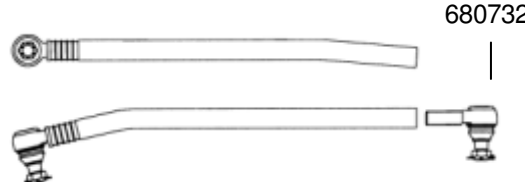
LINK RODS

VOLVO

TYPES	Oe nr.	Dimensions	Drawing
SIDEM NR: 685130			
B57-B58 Chassis: CH 8203 ->	1130571		
SIDEM NR: 685634			
F611 Chassis: CH 286 -> F612 Chassis: CH 286 -> F613 Chassis: CH 286 -> F614 Chassis: CH 286 ->	6850389		
SIDEM NR: 685738			
N12 Subtype: FA6,5 - FA7 RHD	1567575		
SIDEM NR: 685939			
B9M - B10M Subtype: LHD - vehicles with leaf springs Chassis: ->CH 20000	1137784		
SIDEM NR: 686134			
F12 Subtype: FA6,5 - FA 6,7 RHD Chassis: CH 458606 -> CH 347126 ->	1083745		
SIDEM NR: 686531			
B10B Subtype: LHD Chassis: CH 2985-> B10M Subtype: LHD Chassis: CH 46148-> CH 60354-> B12 Subtype: stwpos-L / stwpos-c B12B Subtype: stwpos-L / stwpos-c	20490123		



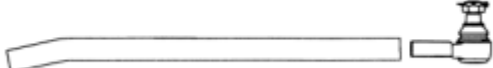
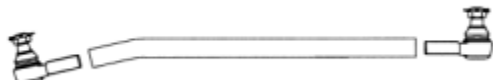

TYPES	Oe nr.	Dimensions	Drawing
SIDEM NR: 686635			
NH12 Subtype: FRAX-BAS FAA10	20393057		 680330
SIDEM NR: 686634			
FM10 Subtype: FAA20,STWPOS-L,FA-HIGH FM10 Subtype: FAA20,STWPOS-R,FA-HIGH FM12 Subtype: FAA20,,FA-HIGH FM7 Subtype: FAA20, STWPOS-L/R FA- HIGH NH12 Subtype: 8X4 AXLE 1 FA-HIGH	20393083	L= 572 Ø= 38	 680330
SIDEM NR: 685734			
F10 Subtype: 1st axle Chassis: CH 314000 -> F10 Subtype: 8x4 Chassis: CH 314000 -> F12 Subtype: 1st axle Chassis: -> CH 593143 F12 Subtype: 8x4 Chassis: -> CH 593143 F12 Subtype: FA12,0 RHD(Australia) Chassis: -> CH 593143 F7 Subtype: 1st axle	6866174	L= 610	 680735
SIDEM NR: 685736			
F7 Subtype: 2nd axle	6866175	L= 644	 680732





LINK RODS

VOLVO

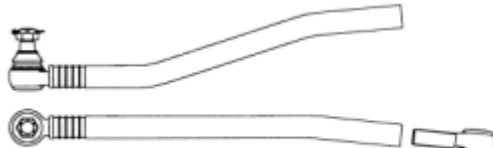
TYPES	Oe nr.	Dimensions	Drawing
SIDEM NR: 685834			
FM12 Subtype: FA7,5 N10 Subtype: LHD FA6,5 with ZF steering gear 25,5 FA7,5 with ZF steering gear 22,7 FA8,0 with ZF steering gear 25,7 Chassis: CH306000 N12 Subtype: FA7,5 N12 Subtype: LHD FA6,5 with ZF steering gear 25,5 FA7,5 with ZF steering gear 22,7 FA8,0 with ZF steering gear 25,7 N7 Subtype: FA7,5 NL12 Subtype: FAT 6.7 & FAT 7.5, 8.0, 9.0 For vehicles with straight front axle FAT 9.0 applies STYRV-ZF 22.7,25.5	1626493	L= 710 Ø= 42	 680732
SIDEM NR: 685639			
FM12 Subtype: FA6,5 - FA7 RHD N10 Subtype: FA6,5 - FA7 RHD N10 Subtype: RHD FA6,5 with ZF steering gear 25,5 Chassis: CH306000 N12 Subtype: RHD FA6,5 with ZF steering gear 25,5 N7 Subtype: FA6,5 - FA7 RHD NL10 Subtype: Aus CH271817-544256	1588018	L= 730 Ø= 42	 680732





TYPES	Oe nr.	Dimensions	Drawing
SIDEM NR: 685638			
FM12 Subtype: FA6,5 - FA7 LHD N10 Subtype: FA6,5 - FA7 LHD N10 Subtype: FA6,5 exc. ZF steering gear 25,5 Chassis: CH306000 N12 Subtype: FA6,5 - FA7 LHD (exc. 6x4 : 26 ton Bogie) N12 Subtype: FA6,5 exc. ZF steering gear 25,5 N7 Subtype: FA6,5 - FA7 LHD NL12 Subtype: FAT 6.7 & FAT 7.5, 8.0, 9.0 For vehicles with straight front axle FAT 9.0 applies STYRV-ZF 23.6	1588017	L= 738 Ø= 42	
SIDEM NR: 686438			
B10 B10BLE Chassis: CH->2696	20497799	L= 743 Ø= 40	
SIDEM NR: 686238			
FL12 Subtype: DFA LHD Chassis: CH A244033-> CH C751869-> FL12 Subtype: DFA LHD Chassis: CH->A244032 CH->C751868 FL12 Subtype: DFA LHD Chassis: CH->A244032 CH->C751868 FL12 Subtype: DFA LHD , PSS-SING Chassis: CH A244033-> CH C751869->	1575690	L= 750 Ø= 38	





LINK RODS

VOLVO

TYPES	Oe nr.	Dimensions	Drawing
SIDEM NR: 686330			
N10 Subtype: FA6,5 - FA7,5 - FA8,0 with spoked wheels 24 Chassis: CH306000	1626492	L= 750 Ø= 42	
N12 Subtype: FA6,5 - FA7,5 - FA8,0 with spoked wheels 24			
NL12 Subtype: FAT 6.7 & FAT 7.5, 8.0, 9.0 For vehicles with straight front axle FAT 9.0 applies			
SIDEM NR: 686439			
B10 B10BLE Chassis: CH->2696	20497800	L= 763 Ø= 38	
SIDEM NR: 686138			
F12 Subtype: 2nd axle Chassis: CH 314000 ->	1080788	L= 787	
SIDEM NR: 686137			
F12 Subtype: 1ste axle Chassis: CH 314000 ->	1080787	L= 820	
SIDEM NR: 686236			
FL7 Subtype: 2nd axle	1626672	L= 822 Ø= 42	





TYPES	Oe nr.	Dimensions	Drawing
SIDEM NR: 686231			
FL10 Subtype: at steering gear FL10 Subtype: FA6,5 - FA7,5 - FA8,0 LHD with leaf springs FL12 Subtype: EFA LHD BLF FR Chassis: CH A244033-> CH C751869-> FL12 Subtype: EFA LHD BLF FR Chassis: CH->A244032 CH->C751868 FL7 Subtype: at steering gear FL7 Subtype: FA6,5 - FA7,5 - FA8,0 LHD with leaf springs	1592939	L= 823 Ø= 50	
SIDEM NR: 686232			
FL10 Subtype: FA6,5 - FA7,5 RHD with leaf springs FL12 Subtype: EFA RHD Chassis: CH A244033-> CH C751869-> FL12 Subtype: EFA RHD Chassis: CH->A244032 CH->C751868 FL7 Subtype: FA6,5 - FA7,5 RHD with leaf springs	1592940	L= 823 Ø= 50	
SIDEM NR: 686132			
F12 Subtype: 4x2 - 6x2 - 6x4 Chassis: CH314000 -> F12 Subtype: FA6,5 - FA 6,7 LHD Chassis: CH 458606 -> CH 347126 ->	1083744	L= 840 Ø= 40	





LINK RODS

VOLVO

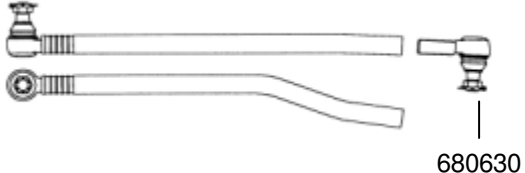
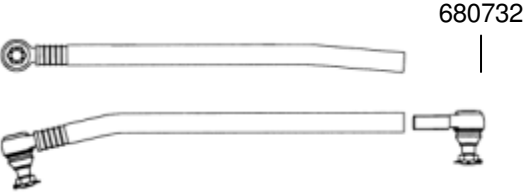
TYPES	Oe nr.	Dimensions	Drawing
SIDEM NR: 686234			
FL10 Subtype: 1st axle	1626670	L= 848 Ø= 42	
FL12 Subtype: DFA Chassis: CH A244033-> CH C751869->			
FL12 Subtype: DFA Chassis: CH->A244032 CH->C751868			
FL12 Subtype: DFA Chassis: CH->A244032 CH->C751868			
FL12 Subtype: DFA PSS-DUAL			
FL12 Subtype: DFA, PSS-SING Chassis: CH A244033-> CH C751869->			
FL7 Subtype: RHD - 1st axle			
SIDEM NR: 685635			
F611 F612 - F613 F614 Chassis: CH 1451 - CH 2315 CH 2295 - CH 5835 -> CH 642	6853013	L= 850 Ø= 40	
SIDEM NR: 686133			
F10 Subtype: FA6,5 - FA7,5 RHD Chassis: CH 314000 ->	1626750	L= 850 Ø= 42	
F12 Subtype: 1st & 2nd axle Chassis: CH 593144 ->			
F12 Subtype: FA6,5 - FA 6,7 RHD Chassis: -> CH 458605 -> CH 347125			
F16 Subtype: 1ste and 2nd axle			
F16 Subtype: FA6,5 - FA7,5 RHD			





TYPES	Oe nr.	Dimensions	Drawing
SIDEM NR: 686233			
FL10 Subtype: vehicles with air suspension FL12 Subtype: EFA LHD LUF FR Chassis: CH A244033-> CH C751869-> FL12 Subtype: EFA LHD LUF FR Chassis: CH->A244032 CH->C751868 FL7 Subtype: vehicles with air suspension	1080786	L= 856 Ø= 42	
SIDEM NR: 686533			
FH12 Subtype: vehicles with air spring front chassis height standard chassis height 900 Chassis: CH A230972 -> CH B125526 -> FH16 Subtype: vehicles with air spring front Chassis: -> CH A230971 -> CH B125525 FM10 Subtype: FAA10,STWPOS-L, FSS-AIR FA-LOW, CHH-STD/900 FM12 Subtype: FAA10,STWPOS-L FSS-AIR FA-STRAI FM12 Subtype: FAA10,STWPOS-L FSS-AIR FRAX-BAS FM7 Subtype: FAA10, STWPOS-L, FSS-AIR FRAX-BAS	1075153	L= 861 Ø= 52	





LINK RODS

VOLVO

TYPES	Oe nr.	Dimensions	Drawing
SIDEM NR: 686535			
FH12 Subtype: vehicles with leaf springs Chassis: CH A238754 -> CH B136426 ->	1075663	L= 861 Ø= 52	 681130
FH16 Subtype: vehicles with leaf springs Chassis: CH A238754 -> CH B136426 ->			
FM10 Subtype: FAA10,STWPOS-L FSS-LEAF,FA-HIGH/LOW FRAX-BAS Chassis: BR CH E670784 ->			
FM10 Subtype: FAA10,STWPOS-L FSS-LEAF,FA-HIGH/LOW FRAX-BAS EXCL PA-HYDRS/TA-HYDRS			
FM10 Subtype: FAA10,STWPOS-L PA-STEER/TA-STEER			
FM12 Subtype: FAA10,STWPOS-L FSS-LEAF PA-HYDRS/TA-HYDRS,			
FM7 Subtype: FAA10, STWPOS-L, FSS-LEAF EXCL PA-HYDRS/TA-HYDRS,			
SIDEM NR: 686539			
FH12 Subtype: vehicles with leaf springs Chassis: CH A238754 -> CH B136426 ->	1075664	L= 861 Ø= 52	 681130
FH16 Subtype: vehicles with air spring front Chassis: CH A230972 -> CH B125526 ->			







TYPES	Oe nr.	Dimensions	Drawing
SIDEM NR: 686632			
FM10 Subtype: FAA10,STWPOS-R, FSS-LEAF FA-HIGH/LOW, FRAX-BAS EXCL PA-HYDRS/TA-HYDRS FM12 Subtype: FAA10,STWPOS-R FSS-LEAF EXCL PA-HYDRS/TA-HYDRS,FA-LOW FM12 Subtype: FAA10,STWPOS-R FSS-LEAF EXCL PA-HYDRS/TA-HYDRS FA-LOW/HIGH, FRAX-BAS FM12 Subtype: FAA10,STWPOS-R FSS-LEAF PA-HYDRS/TA-HYDRS, FM7 Subtype: FAA10, STWPOS-R EXCL PA-HYDRS/TA-HYDRS, FSS-LEAF,FA-LOW/FA-HIGH	20393063	L= 861 Ø= 52	
SIDEM NR: 686538			
FH12 Subtype: vehicles with leaf springs Chassis: -> CH A238753 -> CH B136425 FH16 Subtype: vehicles with leaf springs Chassis: -> CH A238753 -> CH B136425	1075006	L= 863	
SIDEM NR: 686534			
FH12 Subtype: vehicles with leaf springs Chassis: -> CH A238753 -> CH B136425 FH16 Subtype: vehicles with leaf springs Chassis: -> CH A238753 -> CH B136425	1075005	L= 863 Ø= 52	
SIDEM NR: 686336			
FL616 - 617 Subtype: LHD Chassis: 5/1989->	6790473	L= 867 Ø= 42	



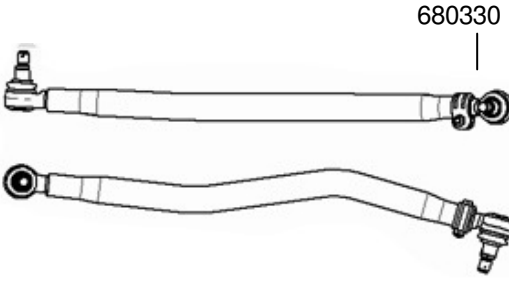
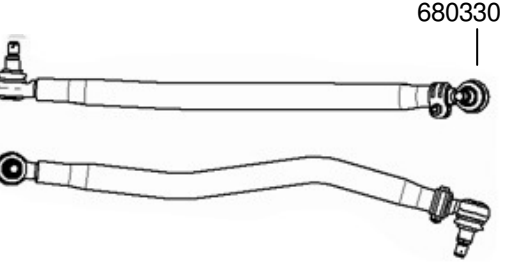
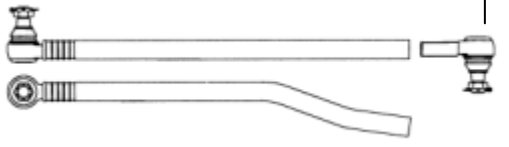

LINK RODS

VOLVO

TYPES	Oe nr.	Dimensions	Drawing
SIDEM NR: 686337			
FL616 - 617 Subtype: RHD Chassis: 5/1989->	6790474	L= 867 Ø= 42	 680339
SIDEM NR: 686239			
FM10 Subtype: FAA10, FAA20, STWPOS-L FSS-AIR ,FA-STRAI FSS-LEAF EXCL PA-HYDRS/TA-HYDRS FM12 Subtype: FAA10, FAA20 STWPOS-R FSS-LEAF EXCL PA-HYDRS/TA-HYDRS FA-STRAI, STWPOS-L FM7 Subtype: FAA10, STWPOS-L FSS-AIR,FA-STRAI Subtype: FSS-LEAF EXCL PA-HYDRS/TA-HYDRS FAA20, STWPOS-L,FA-STRAI FM9 Subtype: FAA10,FAA20 ,FA-STRAI	20393065	L= 868 Ø= 50	 680330
SIDEM NR: 686633			
FM10 Subtype: FAA20,STWPOS-R,FA-HIGH FM12 Subtype: FAA20,STWPOS-R,FA-HIGH FM7 Subtype: FAA20, STWPOS-R,FA-HIGH NH12 Subtype: 8X4 AXLE 2 FA-HIGH	20393079	L= 869 Ø= 50	 680330
SIDEM NR: 685636			
F611 F612 - F613 F614 Chassis: CH 2315 -> CH 5836 -> CH 642 ->	6876948	L= 870 Ø= 40	 680630
SIDEM NR: 685731			
F7 Subtype: 4x2 - 6x2	1606282	L= 870 Ø= 42	 680732







TYPES	Oe nr.	Dimensions	Drawing
SIDEM NR: 685739			
F10 Subtype: FA6,5 - FA7,5 LHD Chassis: -> CH 313999 F12 Subtype: FA6,5 - FA7,0 - FA7,5 LHD	1606283	L= 870 Ø= 42	680732
SIDEM NR: 685831			
F10 Subtype: FA6,5 RHD Chassis: -> CH 313999 F12 Subtype: FA6,5 RHD	1606284	L= 870 Ø= 42	680732
SIDEM NR: 686131			
F10 Subtype: FA6,5 - FA7,5 - FA8,0 LHD Chassis: CH 314000 -> F12 Subtype: 4x2 - 6x2 - 6x4 Chassis: CH314000 -> Subtype: 4x2 - 6x2 - 6x4 Chassis: CH314000 -> Subtype: FA6,5 - FA 6,7 LHD Chassis: ->CH 458605 ->CH 347125 Subtype: FA7,5 / FA8,0 LHD exc. fire crash tender, 6x6 and 4x4 Chassis: CH314000 -> F16 Subtype: FA6,5 - FA7,5 - FA8,0 LHD	1626751	L= 870 Ø= 42	680732
SIDEM NR: 686434			
FL614 Chassis: 5/1989->	6790572	L= 871 Ø= 42	681430



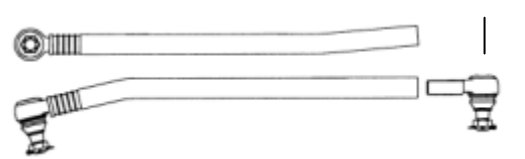
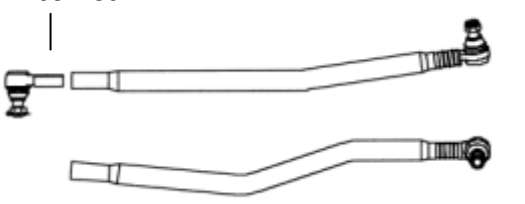

LINK RODS

VOLVO

TYPES	Oe nr.	Dimensions	Drawing
SIDEM NR: 686135			
F10 Subtype: Vehicles with air spring front Chassis: CH 314000 ->	1626749	L= 880 Ø= 42	
F12 Subtype: vehicles with air spring front LHD			
SIDEM NR: 686537			
FH16 Subtype: vehicles with air spring front Chassis: CH A230972 -> CH B125526 ->	8156657	L= 881	
FM10 Subtype: FAA10,STWPOS-R FSS-AIR,FA-STRAI Subtype: FAA10,STWPOS-R FSS-AIR,FRAX-BAS			
FM12 Subtype: FAA10,STWPOS-R FSS-AIR ,FA-STRAI Subtype: FAA10,STWPOS-R FSS-AIR ,FRAX-BAS			
FM7 Subtype: FAA10, STWPOS-R EXCL PA-HYDRS/TA-HYDRS, FSS-AIR,FA-LOW,CHH-STD,			
SIDEM NR: 686532			
FH12 Subtype: LHD vehicles with air spring front chassis height standard chassis height 900 Chassis: -> CH A230971 -> CH B125525	1628636	L= 881 Ø= 52	
FH16 Subtype: LHD vehicles with air spring front			









TYPES	Oe nr.	Dimensions	Drawing
SIDEM NR: 686339			
FH12 Subtype: vehicles with chassis height 810 - 850 RHD FM10 Subtype: FAA10,STWPOS-R, FSS-AIR ,CHH850 FM12 Subtype: FAA10,STWPOS-R FSS-AIR ,CHH850 FM7 Subtype: FAA10, STWPOS-R EXCL PA-HYDRS/TA-HYDRS, FSS-AIR,CHH850	8190147	L= 888 Ø= 52	681130
SIDEM NR: 685830			
F10 Subtype: FA6,5 LHD early production Chassis: -> CH 313999	1566021	L= 899	680732
SIDEM NR: 685431			
B6F Subtype: B6F - LHD: normal control B6FA Subtype: B6F - LHD: normal control F4 Subtype: Vehicles with soft single spring F607 Chassis: CH 578 -> F608 Chassis: CH 578 -> F609 Chassis: CH 578 -> F610 Chassis: CH 578 ->	6852197	L= 900 Ø= 34	680432
SIDEM NR: 686139			
FL12 Subtype: DFA CH A244033-> CH C751869-> Subtype: DFA CH->A244032 CH->C751868 FL12 Subtype: DFA, PSS-SING CH A244033-> CH C751869-> Subtype: EFA LHD 6x6 CH A244033-> CH C751869->	8154444	L= 934 Ø= 50	680732



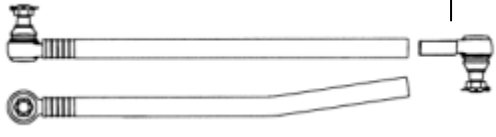

LINK RODS

VOLVO

TYPES	Oe nr.	Dimensions	Drawing
SIDEM NR: 686432			
FL608 - 611 Chassis: 5/1989->	3124480	L= 978 Ø= 30	 681430
SIDEM NR: 686630			
B10B Subtype: RHD Chassis: CH->2696 Subtype: RHD Chassis: CH->2984 B10BLE Subtype: RHD Chassis: CH->2696 B10M Subtype: RHD Chassis: CH->46147 CH->60353 B10M Chassis: CH 20000-39999	1197339	L= 1028 Ø= 56	 680732
SIDEM NR: 686437			
B10B Subtype: LHD Chassis: CH->2984 B10BLE Subtype: LHD Chassis: CH->2696 B10M Subtype: LHD Chassis: CH->46147 CH->60353 B10M Chassis: CH 20000-39999 B9M - B10M Chassis: CH 20001->	1197338	L= 1028 Ø= 60	 680732
SIDEM NR: 686631			
B10B Subtype: RHD Chassis: CH 2985-> B10M Subtype: RHD Chassis: CH 46148-> CH 60354-> B12 Subtype: stwpos-r B12B Subtype: stwpos-r	20490120	L= 1028 Ø= 60	 680731





TYPES	Oe nr.	Dimensions	Drawing
SIDEM NR: 685938			
B9M - B10M Subtype: RHD - vehicles with air suspension Chassis: ->CH 20000	1135630	L= 1106 Ø= 52	680732
SIDEM NR: 685937			
B9M - B10M Subtype: LHD - vehicles with air suspension Chassis: ->CH 20000	1134840	L= 1114 Ø= 52	680732





TIE ROD ENDS

VOLVO

Type	Sidem	OE nr	A	B	C
F4 : vehicle with soft single spring	680530	1518142	100	-	M24x1,50 rht
F4 : vehicle with soft single spring	680531	1517448	100	-	M24x1,50 lht
Different types	680432	1698191	105	-	M28x1,50 rht
Different types	680435	1698190	105	-	M28x1,50 lht
Different types	681430	1696920	108	-	M24x1,50 rht
Different types	681431	1696919	108	-	M24x1,50 lht
Different types	680030	366758	120	-	M30x1,50 rht
Different types	680031	366757	120	-	M30x1,50 lht
Different types	680330	1698846	120	-	M30x1,50 rht
Different types	680331	1698847	120	-	M30x1,50 lht
Different types	680339	1697246	120	-	M30x1,50 rht
Different types	680439	1507828	120	-	M30x1,50 rht
Different types	680630	1697247	120	-	M30x1,50 rht
Different types	680631	1695689	120	-	M30x1,50 lht
Different types	680732	1695585	120	-	M30x1,50 rht
Different types	680735	1698840	120	-	M30x1,50 lht
Type	Sidem	OE nr	A	B	C
Different types	680731	85104188		-	
Different types	681130	3090727	120	-	M30x1,50 rht
FH 16 : LHD/RHD & Australia	681131	3092471	120	-	M30x1,50 lht
Type	Sidem	OE nr	A	B	C
N12	680437	1517838	100	-	M40x1,50 lht
N12	680438	1517839	100	-	M40x1,50 rht
Different types	680230	1696901	137	-	M52x1,50 rht
Different types	680231	1696900	137	-	M52x1,50 lht

© Sidem nv 2006

SIDEM





Type	Sidem	OE nr	Length	Heigth	Dimensions
Gear box control lever					
	68039	1527234	90	-	M28x1,50 rht
	681930	1696685	55	-	M12x1,75 rht
	681931	1696684	55	-	M12x1,75 lht
	68038	382613	55	-	M14x1.50 rht
	681932	1668179	90	-	M16x1,50 rht





TORQUE RODS

VOLVO

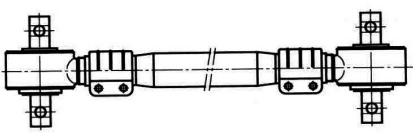
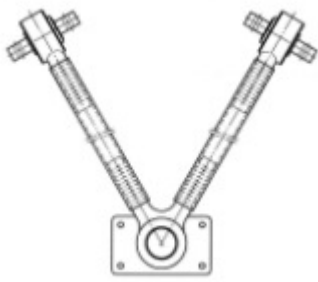
Type	OE nr	Dimensions	Drawing
SIDEM NR: 68040			
F7 - F10 - F12 FL7 - FL10 - FL12	1581527 1607079 8154017 8158206 8158207	660 mm	
Triangle rods			
SIDEM NR: 68147			
N10 - N12 F10 - F12 - F16 FL7 - FL10 - FL12 Remark: rear axle upper, front & rear	1080690 1576952 1606200	635 mm	









Type	OE nr	Dimensions	Drawing
Repair kits for torque rods			
SIDEM NR: 68344 FH12 - FH16	0244019		
SIDEM NR: 68249 FH12 - FH16	0275988	Ø67 x 100 x Ø17	
SIDEM NR: 68348 F10 - F12 - F16 FH12 - FH16 FL7 - FL10 - FL12 N10	0274019 0273373	Ø75 x 115 x Ø17	
SIDEM NR: 68342 F7 - F10 - F12 - F16 FH12 - FH16 N10 - N12	0274019 0273373	Ø85 x 130 x Ø21	
SIDEM NR: 68244 F10 - F12 - F16 FH12 - FH16	0274068	Ø85 x 152 x Ø21	

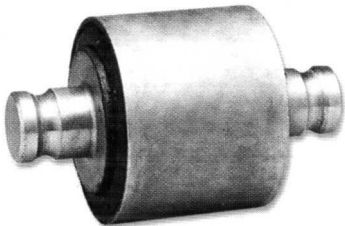



Type	OE nr	Dimensions	Drawing
SIDEM NR: 68542 B9M - B10M - B10B - B12	1136891	Ø91,5 x 150	
SIDEM NR: 14441 F10 - F12 - F16 FH12 - FH16 FL7 - FL10	0274056 0276192	Ø95 x 152 x Ø23	
Repair kits for torque rod balls			
SIDEM NR: 68347 FH12 - FH16	3091598		
SIDEM NR: 68242 F10 - F12 - F16 FL7 - FL10 - FL12 N10 <i>Grease included</i>	0271188 3091598		
SIDEM NR: 68541 <i>Grease included</i>	3090712		





Type	OE nr	Dimensions	Drawing
SIDEM NR: 68340			
F7 - F10 - F12 N10 - N12 NL10 - NL12 <i>Grease included</i>	0273375	Ø23 x 80 x 90/152	
SIDEM NR: 68343			
F10 N10 - N12	0273374	Ø43	
SIDEM NR: 68248			
F7 - F10 - F12 - F16 FL7 - FL10 N10 - N12 <i>Grease included</i>	0276191 0273706	Ø45	
SIDEM NR: 68543			
<i>Grease included</i>	3090015	Ø67 x 100 x Ø17	
SIDEM NR: 68540			
F12 - F16 FL7 - FL10 - FL12 <i>Grease included</i>	0274069	Ø85 x 152 x Ø21	





Type	OE nr	Dimensions	Drawing
Repair kits for Triangle rods			
SIDEM NR: 68247			
B9M - B10M - B10B - B12 F7 - F10 - F12 - F16 FH10 - FH12 FL7 - FL10 - FL12	1614355 1598588	Ø91,5 x 125 x 150	
SIDEM NR: 68346			
FH12 - FH16	1628107	Ø91,5 x 145 x 170	
Repair kits for Triangle rod balls			
SIDEM NR: 68246			
B9M - B10M - B10B - B12 F7 - F10 - F12 - F16 FH16 FL7 - FL10	3173759 1075255 1591689	138,5x96 M16x2	
Bushings			
SIDEM NR: 68442			
F10 - F12 - F16 FH12 - FH16 FL7 - FL10 FM series	1629701	Ø21 x 73,5 x Ø26	
SIDEM NR: 68441			
B9M - B10M - B10B - B12 F10 - F12 - F16 FH12 - FH16 FL7 - FL10 - FL12	1135080	Ø52 x 85 x Ø92	



Type	OE nr	Dimensions	Drawing
Spring pins			
SIDEM NR: 68065			
B7F/B7FA B57 BB57 Chassis: CH-7980 CH-B655/6/7/8, 715/755	310948	M20 x 2,5 x 194 M36 x 3	
SIDEM NR: 68665			
FL608/611/612/614 Remark: P2 B6 FA Remark: Fat 8,0	6776803	M36 x 3 x 140,5	
SIDEM NR: 68569			
FL 608/612/614/615/616/619 FS 7 GE 6,7	6777141	M36 x 3 x 151	
SIDEM NR: 68861			
F7/10/12 FL7/10 N7/10/12	1570465	M56 x 5,5 x 192	
SIDEM NR: 68676			
FL608/611/612/614 Remark: P2 B6 FA Remark: Fat 8,0	6776802	Ø20 x 92,5 M36 x 3	
SIDEM NR: 68770			
FL616/617	6782621	Ø20 x 112 M36 x 3	
SIDEM NR: 68075			
Bushing rear & front spring F7 Remark: 4x2 F10 Chassis: ch. 25000, ch. 40460 F12 Chassis: ch. 34000, ch. 65820	1587940	Ø25 x 112 M36 x 3	
SIDEM NR: 68570			
Truck with leaf suspension only FH1213 & FH1613 Remark: 1st & 2nd front spring bracket rear upper	1608019	Ø25 x 112 M45 x 3	
SIDEM NR: 68763			
FL616/617	6795567	Ø25 x 162 M36 x 3	





SPRINGS

VOLVO

Type	OE nr	Dimensions	Drawing
SIDEM NR: 68767			
FL618/619	6781881	Ø25 x 170 M36 x 3	
SIDEM NR: 68572			
FL7 Remark: 4x2 Parabolic spring (P2/P2 L) FL10 Remark: 4x2 semi trailers, parabolic spring (P2/P2 L) F10 Remark: semi trailers Parabolic spring Ch 25001-313999 4x2 semi trailers air spring Ch 25001-313999 4x2 semi trailers Parabolic spring Ch 314000 -> F12 Remark: 4x2semi trailers Parabolic& air spring Ch 34001-313999 4x2 semi trailers Parabolic spring Ch 314000 -> F16 Remark: 4x2 semi trailers Parabolic spring	1608018	Ø25 x Ø49,8 x 152 M45 x 3	
SIDEM NR: 68563			
FH12/FH16 FM12 NH12 AUS	1075723	Ø38 x 168 M34 x 4	
SIDEM NR: 68760			
F7/10/12/16 FL7/10/12 FH12/ FH16 N7/10/12 N10/12 (Brasil)	1614230 1589024	Ø38 x 168 M36 x 3	
SIDEM NR: 68066			
FL7/10/12 F7/10/12/16 FH12 - FH16 N7/10/12	1614229 0339465	Ø38 x 169 M36 x 3	
SIDEM NR: 68564			
FH12/FH16	1076334	Ø38 x 170 M34 x 4	





Type	OE nr	Dimensions	Drawing
SIDEM NR: 68761 (OLD NR: 68562)			
FL7/10/12 F7/10/12/16 FH12 - FH16 N7/10/12	1609960 363910	Ø44 x 210 M36 x 3	
Spring bushings			
SIDEM NR: 68678			
FL616/ FL617	6781880	Ø45 x 80 M36 x 3	
SIDEM NR: 68671			
F7/F10 Chassis: CH-25000 F10 Chassis: CH-25001-> F12 Chassis: CH-34000 F12 Chassis: CH-34001-> F86/FB86/FS7/F86 GB N7 Chassis: CH-12000 N10 Chassis: CH-49000 N12 Chassis: CH-12000 N84-B54	330135	Ø45 x 83 M36 x 3	
SIDEM NR: 68573			
<i>Bushing rear & front spring</i> FH12, FH16, FM12, NH12 AUS	1075726	Ø45 x 105 M34 x 4	
SIDEM NR: 68070			
FF86/FB86/F88/FB88/G88/F89/G89 F7/10/12/16-FL7/10-FH12/16 N7/N10/N12 N10BR MK2/NL10 AUS NL10BR/NL 10S N12BR MK2/NL12 AUS NL12BR/NL12S	1504550	Ø45 x 105 M36 x 3	
SIDEM NR: 68072			
<i>front & rear spring</i> F88/FB88/G88/F89/G89 B7F/B7FA/B57 BB57/B58/B58 BR N10/N12 <i>rear spring</i> F89/G89 excl. 4x2 B7F/B7FA/B57 BB57/B58/B58 BR <i>bogie spring</i> F89/G89 excl. 4x2 NB88 <i>bogie spring</i> F89/G89 NB88	310947	Ø45 x 110 M36 x 3	





SPRINGS

VOLVO

Type	OE nr	Dimensions	Drawing
SIDEM NR: 68675			
B6/F6 USA / FE6/ FE7 / FL4 FL608-614 / FL616-619/ FS7	6776801	Ø50 x 100 M36 x 3	
SIDEM NR: 68571			
FF86/FB86/F88/FB88/G88/F89/G89 F7/10/12/16-FL7/10-FH12/16 N7/N10/12 N10BR MK2/NL10 AUS NL 10BR/NL 10S N12BR MK2/NL 12 AUS NL 12BR/NL 12S	1598721	Ø55 x 104,5 M45 x 3	
SIDEM NR: 68672			
F7/10/12 FL7/10 N7/10/12	1570466	M56 x 5,5 x 126	
SIDEM NR: 68663			
FH12/FH16	363862	Ø40 x 100 x 120	
SIDEM NR: 68660			
B607/608/610 - B6F Remark: Rear spring, front spring CH 323-> B6FA Remark: Rear axle press. 6,3 tons RHD rear spring -> CH 200 F4 / F6S	6850874	Ø40,5 x 70 x 130	
SIDEM NR: 68765			
FL608/610/611/612/614 FL4 FE6/FE7	6771007	Ø45,5 x 80 x 150	
SIDEM NR: 68662			
FL616/617/F6S	6850876	Ø45,5 x 100 x 160	

SIDEM



© Sidem nv 2006









Type	OE nr	Dimensions	Drawing
SIDEM NR: 68766			
FL616/617 Remark: Double parabolic spring	6772290	Ø45,5 x 100 x 170	
SIDEM NR: 68661			
B6 FA Chassis: ->CH 404 F611/F614 Remark: k2 FL616/617	6850875	Ø45,5 x 100 x 171	
SIDEM NR: 68061			
F7 Remark: 4x2 F10 Remark: -> CH 313999 4x2 CH 314000 -> F12 Remark: -> CH 313999 4x2 CH 314000 -> F16 Remark: 4x2 FL7-FL10 Remark: 4x2, 6x2 N7-N10-N12 Remark: 4x2	343348	Ø51 x 81 x 168	
SIDEM NR: 68561			
F7 Remark: 4x2 F10 Remark: -> CH 313999 4x2 CH 314000 -> F12 Remark: -> CH 313999 4x2 CH 314000 -> F16 Remark: 4x2 FL7-FL10 Remark: 4x2, 6x2 N7-N10-N12 Remark: 4x2	1501677	Ø51 x 99 x 178,5	
Spring bolts			
SIDEM NR: 68668			
FL608/614 Remark: K2 FL612/614 Remark: K2/P2	963324	M16 x 2 x 140	
SIDEM NR: 68664			
B6FA Remark: Front spring: CH 405 -> Rear axle press. 6,3 tons - Rear spring LHD: -> CH 201 RHD: CH 201 -> CH 404	995377	M16 x 45 x 130	







SPRINGS

VOLVO

Type	OE nr	Dimensions	Drawing
SIDEM NR: 68666			
FL608/611/612/614 Remark: P2 B6 FA Remark: Fat 8,0	6776804	M20 x 2,5 x 143	
SIDEM NR: 68768			
<i>single spring</i> FL 616/617	6782622	M20 x 2,5 x 158	
SIDEM NR: 68764			
FL 616/617 Remark: fat 6,7 P2/K2	6795968	M20 x 2,5 x 168	
SIDEM NR: 68669			
<i>double spring</i> FL616/617	6781560	M20 x 2,5 x 168	
SIDEM NR: 68762			
FL616/617 Remark: fat 5,4-6,0 K2/P2	963348	M20 x 2,5 x 173	
SIDEM NR: 68565			
F7/10/12/16 FL7/10	1576943	M24 x 3 x 160 sw36	
SIDEM NR: 68566			
F7 Remark: CH 25001->: 4x2 - soft single parabolic springs, low variant of P2 F10 Remark: CH 25001->CH 313999: 4x2-soft single parabolic springs, low variant of P2 F10 Remark: CH 314000->: 4x2 semi-trailor tractor, soft single parabolic springs, low variant of P2 F12 Remark: CH 34001->313999 4x2 soft single parabolic springs, low variant of P2 F12 Remark: CH314000->: 4x2 rear axle press. 13 tons, semi-trailor tractor bogie press. 16 tons PA F16 Remark: 4x2 rear axle press. 14 tons, semi-trailor tractor FL7 - FL10 Remark: 4x2 - semi-trailor tractor	1598764	M24 x 3 x 175 sw36	



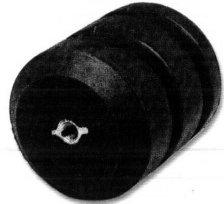

Type	OE nr	Dimensions	Drawing
SIDEM NR: 68567			
<p>Truck with leaf suspension only FH1213/FH1613 Remark: 1st & 2nd front spring bracket rear upper</p> <p>FL7 Remark: 4x2 Parabolic spring (P2/P2 L)</p> <p>FL10 Remark: 4x2 semi trailers, parabolic spring (P2/P2 L)</p> <p>F10 Remark: semi trailers Parabolic spring Ch25001-313999, 4x2 semi trailers air spring Ch 25001-313999, 4x2 semi trailers Parabolic spring Ch314000 -></p> <p>F12 Remark: 4x2 semi trailers Parabolic & air spring Ch34001-313999, 4x2 semi trailers Parabolic spring Ch314000-></p> <p>F16 Remark: 4x2 semi trailers Parabolic spring</p>	1598766	M24 x 3 x 182 sw36	
SIDEM NR: 68769			
FH12/16	1626577	M24 x 3 x 200	
SIDEM NR: 68568			
<p>FL7 Remark: 4x2 Parabolic spring (P2/P2 L)</p> <p>FL10 Remark: 4x2 semi trailers, parabolic spring (P2/P2 L)</p> <p>F10 Remark: semi trailers Parabolic spring Ch25001-313999, 4x2 semi trailers air spring Ch 25001-313999, 4x2 semi trailers Parabolic spring Ch314000 -></p> <p>F12 Remark: 4x2 semi trailers Parabolic & air spring Ch34001-313999, 4x2 semi trailers Parabolic spring Ch314000-></p> <p>F16 Remark: 4x2 semi trailers Parabolic spring</p>	1598765	M24 x 3 x 235 sw36	
Spring silent block bushings			
SIDEM NR: 68364			
<p>All differential types Remark: 4x2, 6x2</p>	1506399		









SPRINGS

VOLVO

Type	OE nr	Dimensions	Drawing
SIDEM NR: 68673			
F7/F10 Remark: CH-25000 F10 Remark: CH-25001-> F12 Remark: CH-34000 F12 Remark: CH-34001->	1696042	Ø24 x Ø59/107	
SIDEM NR: 68674			
B6FA Remark: Front spring: CH 405 -> Rear axle press. 6,3 tons - Rear spring LHD: -> CH 201 RHD: CH 201 -> CH 404 multileaf and parabolic spring rear FL4 Remark: leaf spring exc, 14-pl multi leaf FL608/614 Remark: spring rear, leaf spring front and rear FLC	6879332	Ø55 x Ø16,5 x 95	
SIDEM NR: 68772			
FH12/16	1624486	Ø55 x Ø26 x 112	
SIDEM NR: 68677			
FL616/617 Remark: fat 5,4-6,0 K2/P2 B10M	3027227	Ø61,5 x Ø20 x 120	
Spring lock nuts			
SIDEM NR: 68664 E			
	963110	M16 x 20	
SIDEM NR: 68667 E			
	948835	M20 x 2,5	
SIDEM NR: 68565 E			
	961997	M24 x 3	
SIDEM NR: 68769 R			
			



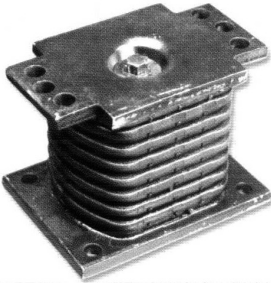

Type	OE nr	Dimensions	Drawing
SIDEM NR: 68565 R			
	941916	Ø25 x Ø39 x 5	
SIDEM NR: 68073			
	125021	Ø38 x 5	
Cushions			
SIDEM NR: 68361			
F7 Chassis: CH->31002 F10 Chassis: CH->30788 F12 Chassis: CH->42887 N10 Chassis: CH->53226 N12 Chassis: CH->16009	1589089 1587103 1508080	6x4 Ø125 mm Chain through middle	
SIDEM NR: 68362			
F7 Chassis: CH31003-> F10 Chassis: CH30789-> F12 Chassis: CH42888-> N10 Chassis: CH53227-> N12 Chassis: CH16010-> FL7-FL10-FH12-F16-FH16 NL10-NL12	1629553 2039836 3090371	6x4, 8x4 Ø132 mm Bolt through middle 152 x 202 x 150	
SIDEM NR: 68360			
F7 Chassis: CH31003-> F10 Chassis: CH30789-> F12 Chassis: CH42888-> N10 Chassis: CH53227-> N12 Chassis: CH16010-> FL7-FL10-FH12-F16-FH16 NL10-NL12	1609657 1577873 1089501	Ø145 mm Chain through middle	





SPRINGS

VOLVO

Type	OE nr	Dimensions	Drawing
Spring pin kits			
SIDEM NR: 68066 KIT	Contains (SIDEM NR)		
FL7/10 F7/10/12/16 FH12-FH16 N7/10/12	Spring pin (68066) Spring bush (68070)		
SIDEM NR: 68562 KIT	Contains (SIDEM NR)		
FL7/10 F7/10/12/16 FH12-FH16 N7/10/12	Spring pin (68761) Spring bush (68070)		
SIDEM NR: 68565 KIT	Contains (SIDEM NR)		
F7 Remark: 4x2 F10 Chassis: ch. 25000, ch. 40460 F12 Chassis: ch. 34000, ch. 65820	Spring Bolt (68565) Spring bush (68070) Bush outer Thread (68075) Ring (68565 R) Lock nut (68565 E)		
SIDEM NR: 68566 KIT	Contains (SIDEM NR)		
F7 Remark: CH 25001->: 4x2 - soft single parabolic springs, low variant of P2 F10 Remark: CH 25001->CH 313999: 4x2-soft single parabolic springs, low variant of P2 F10 Remark: CH 314000->: 4x2 semi-trailor tractor, soft single parabolic springs, low variant of P2 F12 Remark: CH 34001->313999 4x2 soft single parabolic springs, low variant of P2 F12 Remark: CH314000->: 4x2 rear axle press. 13 tons, semi-trailor tractor bogie press. 16 tons PA F16 Remark: 4x2 rear axle press. 14 tons, semi-trailor tractor FL7 - FL10 Remark: 4x2 - semi-trailor tractor	Spring bolt (68566) Bush inner thread (68571) Bush outer thread (68570) Ring (68565 R) Lock nut (68565 E)		





Type	OE nr	Dimensions	Drawing
SIDEM NR: 68567 KIT	Contains (SIDEM NR)		
<p>F7 Remark: CH 25001->: 4x2 - soft single parabolic springs, low variant of P2</p> <p>F10 Remark: CH 25001->CH 313999: 4x2-soft single parabolic springs, low variant of P2</p> <p>F10 Remark: CH 314000->: 4x2 semi-trailor tractor, soft single parabolic springs, low variant of P2</p> <p>F12 Remark: CH 34001->313999 4x2 soft single parabolic springs, low variant of P2</p> <p>F12 Remark: CH314000->: 4x2 rear axle press. 13 tons, semi-trailor tractor bogie press. 16 tons PA</p> <p>F16 Remark: 4x2 rear axle press. 14 tons, semi-trailor tractor</p> <p>FL7 - FL10 Remark: 4x2 - semi-trailor tractor</p>	<p>Spring bolt (68567) Bush inner thread (68571) Bush outer Thread (68570) Lock nut (68565 E)</p>		
SIDEM NR: 68568 KIT	Contains (SIDEM NR)		
<p>F7 Remark: CH 25001->: 4x2 - soft single parabolic springs, low variant of P2</p> <p>F10 Remark: CH 25001->CH 313999: 4x2-soft single parabolic springs, low variant of P2</p> <p>F10 Remark: CH 314000->: 4x2 semi-trailor tractor, soft single parabolic springs, low variant of P2</p> <p>F12 Remark: CH 34001->313999 4x2 soft single parabolic springs, low variant of P2</p> <p>F12 Remark: CH314000->: 4x2 rear axle press. 13 tons, semi-trailor tractor bogie press. 16 tons PA</p> <p>F16 Remark: 4x2 rear axle press. 14 tons, semi-trailor tractor</p> <p>FL7 - FL10 Remark: 4x2 - semi-trailor tractor</p>	<p>Spring bolt (68568) Bush inner thread (68571) Bush outer thread (68572) Lock nut (68565 E)</p>		











SPRINGS

VOLVO

Type	OE nr	Dimensions	Drawing
SIDEM NR: 68760 KIT	Contains (SIDEM NR)		
FL7/10 F7/10/12/16 FH12-FH16 N7/10/12	<i>Spring pin</i> (68760) <i>Spring bush</i> (68070)		











Type	OE nr	Dimensions	Drawing
SIDEM NR: 68363			
FH12 Remark: ->CH A255077, 1806432 B 158514, C 754115, D 100895 FH16 Remark: ->CH A255077, 1806432 B 158513, D 110198 <i>Remark for all: leaf spring</i>	1624611	Ø35 x 50 x 59	
SIDEM NR: 68261			
FH12 Remark: ->CH A255078, 1806433 B 158515, C 754116, D 100896 FH16 Remark: ->CH A255078, 1806433 B 158514, D 110199 <i>Remark for all: leaf spring</i>	1075179	Ø35 x 88 x 67	
SIDEM NR: 68365			
FL7 Remark: except air spring suspension, CH 16718-> FS7 FL10 Remark: except air spring suspension FL616-619 Remark: CH 457577-> FL12 Remark: except air spring suspension, CH 34001-> FL16 Remark: except air spring suspension N10 Remark: CH 39080-> N12 Remark: CH 8289->	1611551	Ø40 x 52 x 59	
SIDEM NR: 68263			
	1076890	Ø40 x 67 x 88	
SIDEM NR: 68368			
FL4 Remark: 2,9&3,2 t FL607-608-612-614-615-616-617 <i>Remark for all: Multi leaf spring</i>	6772312	Ø41 x 65 x 57	
FL4 Remark: 2,9&3,2 t FL608 FL611 FL614 FL616 <i>Remark for all: Parabolic spring</i>			
F610 Remark: CH 3872-> F611 Remark: CH 2377-> F612-613 Remark: CH 6457-> F614 Remark: CH 643->			
SIDEM NR: 68461			
FL6/7 FL612/614	6875470	Ø44 x 62 x 69	











STABILISER BEARINGS

VOLVO

Type	OE nr	Dimensions	Drawing
SIDEM NR: 68162			
FL6 FL7	6771515	Ø45 x 60 x 70	
SIDEM NR: 68264			
FH12 & FH16 <i>Remark for all: Leaf spring, reinforced stabilizer</i>	1075180	Ø45 x 66 x 88	
SIDEM NR: 68266			
F7 Remark: ->CH 16717 F10 Remark: ->CH 6417 F12 Remark: ->CH 4051 N7 Remark: ->CH 12000 N10 Remark: ->CH 39079 N12 Remark: ->CH 8288 B58 Remark: CH 14874 ->	0363864	Ø45 x 71 x 105	
SIDEM NR: 68161			
B9 B10	3028447	Ø45 x 90 x 96	
SIDEM NR: 68465			
	70301194	Ø45 x 92 x 95	
SIDEM NR: 68166			
FL7/10/12 F7 F10 Remark: ->CH 313999 F12 Remark: ->CH 313999 F16 Remark: ->CH 313999 <i>Remark for all: 4x2, single parabolic spring</i>	1580010	Ø49 x 90 x 86	
FL7/12 Remark: 4x2 FL10 Remark: 4x2, 4x4 F7 Remark: 4x2 F10 Remark: 4x2 F12 Remark: 4x2 F16 Remark: 4x2, CH ->313999 <i>Remark for all: Multi leaf spring</i>			
N7/12 Remark: 4x2 N10 Remark: 4x2, CH 24931-> NL10/12			





Type	OE nr	Dimensions	Drawing
SIDEM NR: 68372			
FL7 Remark: 6x2, 8x2 FL10 Remark: 6x2, 8x2 F10 Remark: 6x2 F12 Remark: 6x2 F16 Remark: 6x2 N10 Remark: 6x2 ->CH21720, 6x4 ->CH306000 N12 Remark: 6x2 ->CH3233, 6x4 ->CH306000 Remark for all: Dual axle suspension F10, F12 Remark: air suspension, ->CH 313999 FH12 Remark: 6x2, leaf spring N7 Remark: 6x2, ->CH 6568	1575339	Ø49 x 105 x 93,5	
SIDEM NR: 68366			
F7 Remark: 4x2 with single, weak parabolic spring F10&F12 Remark: 4x2 semi-trailers with parabolic spring, ->CH 313999 F10 Remark: CH 6657 ->19712 F12 Remark: CH 4410 ->31001	1573032	Ø50 x 71 x 105	
SIDEM NR: 68464			
B9/B10/B12/B58/FL608	9959304	Ø50 x 92 x 95	
SIDEM NR: 68163			
B9 B10 B12 B58 FL608	3028448	Ø50 x 96	
SIDEM NR: 68367			
F7 Remark: 4x2 FL10 Remark: 4x2 F10 Remark: 4x2, CH 314000 -> F12 Remark: 4x2, CH 314000 -> F16 Remark: 4x2 Remark for all: vehicles with single weak parabolic spring	1609768	Ø52 x 71 x 106	
SIDEM NR: 68160			
FH12 & FH16 Remark for all: Air suspension	1628318 1606437	Ø53 x 70 x 91	





STABILISER BEARINGS

VOLVO





Type	OE nr	Dimensions	Drawing
SIDEM NR: 68369			
FL7 Remark: 4x2, 6x2, 6x4 FL10 Remark: 4x2, 6x2 F10 Remark: 4x2, 6x2, CH 25001-> F12 Remark: 4x2, 6x2, CH 34001-> FH12 Remark: 4x2, 6x2 F16 Remark: 4x2, 6x2, 6x4 FH16 Remark: 4x2, 6x2 <i>Remark for all: Air suspension</i>	1605182	Ø55 x 90 x 95	
SIDEM NR: 68462			
FH12 & FH16 Remark: Chassis.... FM7	9516524	Ø55 x 92 x 95	
SIDEM NR: 68164			
B9 B10 B12	3028449	Ø55 x 96	
SIDEM NR: 68269			
FH12 & FH16 <i>Remark for all:</i> <i>Leaf spring, reinforced stabilizer</i>	1075188	Ø60 x 74 x 96	
SIDEM NR: 68267			
FH12 FH16 <i>Remark for all: 6x4, 8x4, leaf spring</i>	1629169	Ø60 x 81,5 x 94	
SIDEM NR: 68370			
FL7 Remark: 4x2, 6x2 FL10 Remark: 4x2, 6x2 F10 Remark: 4x2, 6x2, CH 25001-> F12 Remark: 4x2, 6x2, CH 34001-> FH12 Remark: 4x2, 6x2 F16 Remark: 4x2, 6x2, 6x4 FH16 Remark: 4x2, 6x2 B9, B10M Remark: CH 20001-> B12 <i>Remark for all: Air suspension</i>	1605047	Ø60 x 90 x 96	
B9, B10M, B12 Remark: Air spring			
SIDEM NR: 68460			
B9M B12 B12BR	9516579	Ø60 x 96 x 90	

SIDEM



© Sidem nv 2006









Type	OE nr	Dimensions	Drawing
SIDEM NR: 68463			
FH12, FH16, FM12 <i>Remark for all: 4x2, air spring, chassis A297653, chassis B227201, chassis 1201014</i>	9519245	Ø60 x 103 x 95	
SIDEM NR: 68371			
FL7 Remark: 4x2, 6x2 FL10 Remark: 4x2, 6x2 F10 Remark: 4x2, 6x2, CH 25001-> F12 Remark: 4x2, 6x2, CH 34001-> FH12 Remark: 4x2, 6x2 F16 Remark: 4x2, 6x2, 6x4 FH16 Remark: 4x2, 6x2 B9, B10M Remark: CH 20001-> B12 <i>Remark for all: Air suspension</i>	1607561	Ø65 x 90 x 96	
SIDEM NR: 68268			
	6799680	Ø70 x 89 x 112	
SIDEM NR: 68169			
FH12 & FH16 <i>Remark for all: Chassis 4x2 rigid, 6x2, 6x4, 8x2, 8x4, air spring</i>	1077594	Ø71 x 118 x 95	
SIDEM NR: 68165			
	1622838	Ø75 x 95	





WHEEL PARTS

VOLVO







Type	OE nr	Dimensions	Drawing
Bolts			
SIDEM NR: 68016 (FRONT)			
B54-B58 B57-BB57 Chassis: ->CH 7980 F84-F85-F86 F88-FB88-G88 Chassis: CH 30001-> N7 Chassis: ->CH 12000 N10 Chassis: ->CH 49000 N12 Chassis: ->CH 12000 N84-N88-NB88	192122	3/4" x 16UNF x 112	
SIDEM NR: 68018 (FRONT)			
B57-BB58 B58 Chassis: CH 5712-> F86-FB86 F88-FB88-G88 Chassis: CH 30001-> N7 Chassis: ->CH 12000 N10 Chassis: ->CH 49000	192121	3/4" x 16UNF x 126	
SIDEM NR: 68018 (REAR) B54-B58 B57-BB57 F84-F85 F86-FB86 F88-FB88-G88 Chassis: CH 30001-> N7 Chassis: ->CH 12000 N10 Chassis: ->CH 49000 N12 Chassis: ->CH 305999 N84-N88-NB88			
SIDEM NR: 68012 (REAR)			
B57-BB57 B58 FB86	941385	3/4" x 16UNF x 140	
SIDEM NR: 68514 (FRONT)			
B8M-B10M-B10R-B12 M F86-FB88-F87 F88-FB88-G88 Chassis: CH 30001-> F89-G89 FH12-FH16 FL7-FL10-FL12 FM7-FM9-FM10-FM12 N7-N10-N12	1573081	7/8" x 14UNF x 82	
SIDEM NR: 68516 (REAR)			
B12M F10-F12-F16-FL10 FM9-FM10-FM12 N10-N12 FH12-FH16	1589009	7/8" x 14UNF x 110	
SIDEM NR: 68515 (REAR)			
B8M-B10M-B10R-B12M F7-F10-F12-F16 F86-FB88-F87 F88-FB88-G88 Chassis: CH 30001-> F89-G89 FH12-FH16 FL7-FL10-FL12 FM7-FM9-FM10-FM12 N7-N10-N12	1573082	7/8" x 14UNF x 112	

© Sidem nv 2006

SIDEM













Type	OE nr	Dimensions	Drawing
SIDEM NR: 68511 (REAR)			
F88-FB88-G88 Chassis: CH 30001-> F89-G89 N7 Chassis: ->CH 12000 N10 Chassis: ->CH 17189 N12 Chassis: ->CH 305999	943405	7/8" x 14UNF x 130	
SIDEM NR: 68311 (REAR)			
B6F F4 F607-F610	6010503	M18 x 1,5 x 86	
SIDEM NR: 68312 (FRONT)			
F611-F614 FL608-FL614	6795625	M20 x 1,5 x 82	
SIDEM NR: 68312 (REAR) FL608-FL611			
SIDEM NR: 68313 (REAR)			
B6F Chassis: ->CH 404 F611-F614 FL612-FL614	6792928	M20 x 1,5 x 94	
SIDEM NR: 68315 (FRONT)			
B6 F6S FL616-FL617	6852475	M22 x 1,5 x 77	
SIDEM NR: 68316 (REAR)			
B6FA Chassis: CH 405-> F6S FL616-FL617 FL612-FL614 Remark: semi-trailor tractor	6852474	M22 x 1,5 x 100	
Nuts			
SIDEM NR: 68022		SIDEM ref.	
Fits to:	68012 68016 68018	192413	3/4" x 16UNF x 19 sw29
SIDEM NR: 68020		SIDEM ref.	
Fits to:	68012 68016 68018	21668	3/4" x 16UNF x 34 sw30
SIDEM NR: 68521		SIDEM ref.	
Fits to:	68511	943402	7/8" x 14UNF x 25 sw33
SIDEM NR: 68520		SIDEM ref.	
Fits to:	68511 68514 68515 68516	943491	7/8" x 14UNF x 25 sw33
SIDEM NR: 68320		SIDEM ref.	
Fits to:	68311	947970	M18 x 1,5 x 86 sw27



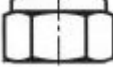

WHEEL PARTS

VOLVO

Type	OE nr	Dimensions	Drawing	
SIDEM NR: 68321	SIDEM ref.			
Fits to:	68312 68313	947971	M20 x 1,5 x 27 sw30	
SIDEM NR: 68322	SIDEM ref.			
Fits to:	68315 68316	947972	M22 x 1,5 x 27 sw32	
SIDEM NR: 68029	SIDEM ref.			
Fits to:	68012 68016 68018	192123	Ø34 x Ø20 x 3	
SIDEM NR: 68529	SIDEM ref.			
Fits to:	68511	943403	Ø40 x Ø23 x 3	
Studs				
SIDEM NR: 68555				
lock nut		950376	1/2" x 20UNF	
SIDEM NR: 68456				
guide fitting		1588852	Ø20 x Ø1/2" x 12,2	
SIDEM NR: 68457				
guide fitting		1591045	Ø22 x Ø14 x 12	
SIDEM NR: 68557				
lock nut		947342	M14x2 Din 980	
SIDEM NR: 68537				
stud		1591028	M14x2/M14x2 L=62	





OE nr	SIDEM nr	Page	OE nr	SIDEM nr	Page	OE nr	SIDEM nr	Page
#	68066 KIT	43	1135533	685539	8	1606200	68147	29
#	68086 R	2	1135630	685938	26	1606274	685730	9
#	68086 SAM	2	1136891	68542	31	1606282	685731	21
#	68280 SAM	3	1137784	685939	11	1606283	685739	22
#	68388 SAM	5	1197338	686437	25	1606284	685831	22
#	68480 SAM	6	1197339	686630	25	1606437	68160	48
#	68482 SAM	6	125021	68073	42	1607079	68040	29
#	68562 KIT	43	1501677	68561	38	1607561	68371	50
#	68565 KIT	43	1504550	68070	36	1608018	68572	35
#	68566 KIT	43	1506399	68364	40	1608019	68570	34
#	68567 KIT	44	1507828	680439	27	1609657	68360	42
#	68568 KIT	44	1508080	68361	42	1609768	68367	48
#	68760 KIT	45	1508438	68280 BM	3	1609960	68562	36
#	68769 R	41	1517448	680531	27	1609960	68761	36
0244019	68344	30	1517838	680437	27	1611551	68365	46
0271188	68242	31	1517839	680438	27	1612254	686130	10
0273373	68342	30	1518142	680530	27	1614229	68066	35
0273373	68348	30	1527234	68039	28	1614230	68760	35
0273374	68343	32	1566021	685830	24	1614355	68247	33
0273375	68340	32	1567575	685738	11	1622838	68165	50
0273706	68248	32	1570465	68861	34	1624486	68772	41
0274019	68342	30	1570466	68672	37	1624611	68363	46
0274056	14441	31	1573032	68366	48	1626492	686330	15
0274068	68244	30	1573081	68514	51	1626493	685834	13
0274069	68540	32	1573082	68515	51	1626494	685730	9
0274070	68348	30	1575339	68372	48	1626577	68769	40
0275988	68249	30	1575690	686238	14	1626670	686234	17
0276191	68248	32	1576943	68565	39	1626672	686236	15
0276192	14441	31	1576952	68147	29	1626749	686135	23
0339465	68066	35	1577873	68360	42	1626750	686133	17
0363864	68266	47	1580010	68166	47	1626751	686131	22
1075005	686534	20	1580413-1	68282 B	4	1628107	68346	33
1075006	686538	20	1581527	68040	29	1628318	68160	48
1075153	686533	18	1587103	68361	42	1628636	686532	23
1075179	68261	46	1587940	68075	34	1628637	686636	10
1075180	68264	47	1588017	685638	14	1629169	68267	49
1075188	68269	49	1588018	685639	13	1629553	68362	42
1075255	68246	33	1588222-8	68282 R	4	1629701	68442	33
1075663	686535	19	1588324	68388 B	5	1668179	681932	28
1075664	686539	19	1588852	68456	53	1695585	680732	27
1075723	68563	35	1589009	68516	51	1695689	680631	27
1075726	68573	36	1589024	68760	35	1696042	68673	41
1076334	68564	35	1589089	68361	42	1696684	681931	28
1076890	68263	46	1591028	68537	53	1696685	681930	28
1077594	68169	50	1591045	68457	53	1696900	680231	27
1080690	68147	29	1591689	68246	33	1696901	680230	27
1080786	686233	18	1592939	686231	16	1696919	681431	27
1080787	686137	15	1592940	686232	16	1696920	681430	27
1080788	686138	15	1598588	68247	33	1697246	680339	27
1083744	686132	16	1598721	68571	37	1697247	680630	27
1083745	686134	11	1598764	68566	39	1698190	680435	27
1089501	68360	42	1598765	68568	40	1698191	680432	27
1130571	685130	11	1598766	68567	40	1698840	680735	27
1134840	685937	26	1605047	68370	49	1698846	680330	27
1135080	68441	33	1605182	68369	49	1698847	680331	27





CROSS REFERENCE GUIDE

VOLVO

OE nr	SIDEM nr	Page	OE nr	SIDEM nr	Page	OE nr	SIDEM nr	Page
1699357	68486 KIT	7	3090267	68388 KIT SR	5	6850389	685634	11
1699357	68486 KIT SR	7	3090267	68388 SET	5	6850874-6	68660	37
191995	68182 BM	2	3090267	68388 SET SR	5	6850875	68661	38
192121	68018	51	3090371	68362	42	6850876	68662	37
192122	68016	51	3090712	68541	31	6852197	685431	24
192123	68029	53	3090727	681130	27	6852474	68316	52
192413	68022	52	3091598	68242	31	6852475	68315	52
19451 + 183295	68182 RO	2,3,5	3091598	68347	31	6853013	685635	17
20393057	686635	12	3092467	68488 KIT	7	6866174	685734	12
20393063	686632	20	3092467	68488 KIT SR	7	6866175	685736	12
20393065	686239	21	3092471	681131	27	6875470	68461	46
20393079	686633	21	3093731	68484 KIT	6	6876948	685636	21
20393083	686634	12	3093731	68484 KIT SR	6	6879332	68674	41
2039836	68362	42	310947	68072	36	70301194	68465	47
20490120	686631	25	310948	68065	34	8154017	68040	29
20490123	686531	11	3124480	686432	25	8154444	686139	24
20497799	686438	14	3173759	68246	33	8156123	686435	8
20497800	686439	15	330135	68671	36	8156657	686537	23
21668	68020	52	343348	68061	38	8158206	68040	29
270920	68480 KIT	6	363862	68663	37	8158207	68040	29
270920	68480 KIT SR	6	363910	68562	36	8190147	686339	24
270920	68480 SET	6	363910	68761	36	85104188	680731	27
270920	68480 SET SR	6	366757	680031	27	941385	68012	51
276011-4	68086 KIT	2	366758	680030	27	941916	68565 R	42
276011-4	68086 KIT SR	2	382613	68038	28	943402	68521	52
276011-4	68086 SET	2	3986450	686636	10	943403	68529	53
276011-4	68086 SET SR	2	6010503	68311	52	943405	68511	52
276014-8	68182 KIT	2	6771007	68765	37	943491	68520	52
276014-8	68182 KIT SR	2	6771112	686431	8	947342	68557	53
276015-5	68280 KIT	3	6771120	686430	8	947970	68320	52
276015-5	68280 KIT SR	3	6771515	68162	47	947971	68321	53
276015-5	68280 SET	3	6772290	68766	38	947972	68322	53
276015-5	68280 SET SR	3	6772312	68368	46	948835	68667 E	41
276026	68086 KIT	2	6774852-5	68480 B	6	950376	68555	53
276026	68086 KIT SR	2	6774853-3	68482 B	6	9516524	68462	49
276026	68086 SET	2	6776801	68675	37	9516579	68460	49
276026	68086 SET SR	2	6776802	68676	34	9519245	68463	50
276029	68182 KIT	2	6776803	68665	34	961997	68565 E	41
276029	68182 KIT SR	2	6776804	68666	39	963110	68664 E	41
276030	68280 KIT	3	6777141	68569	34	963324	68668	38
276030	68280 KIT SR	3	6781560	68669	39	963348	68762	39
276030	68280 SET	3	6781880	68678	36	995377	68664	38
276030	68280 SET SR	3	6781881	68767	35	9959304	68464	48
276193	68482 KIT	6	6782621	68770	34			
276193	68482 KIT SR	6	6782622	68768	39			
276193	68482 SET	6	6782630-5	68480 R	6			
276193	68482 SET SR	6	6782631-3	68482 R	6			
3027227	68677	41	6790473	686336	20			
3028447	68161	47	6790474	686337	21			
3028448	68163	48	6790572	686434	22			
3028449	68164	49	6792928	68313	52			
3090015	68543	32	6795567	68763	34			
3090266-2	68282 KIT	4	6795625	68312	52			
3090266-2	68282 KIT SR	4	6795968	68764	39			
3090267	68388 KIT	5	6799680	68268	50			

SIDEM



© Sidem nv 2006

