

Spare Parts for European Trucks & Trailers



7

R.V.I.

"technology, reliability & quality..."



www.sampalkw.com

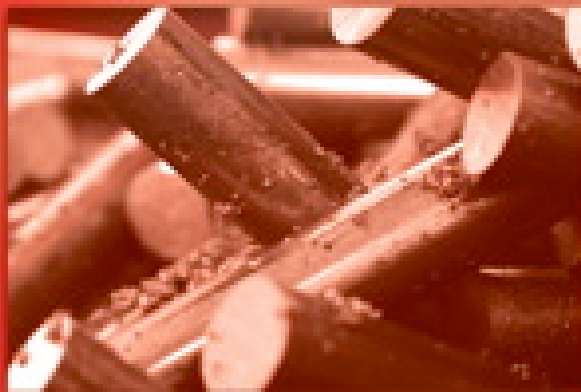

"technology, reliability & quality..."

www.sampalkw.com

Sampa Nr.

080.032

O.E.M. Nr.

5010 060 127



Dimension

ø20xø44.5x104

Description

Spring Bushing

G260/290
G210/230
G320
AE380/385TI/420TI/500/520
MAXTER 6X4 8X4
G230/270 SP
G220/270 BOM
G200/210/230TI
"G" MANAGER 4X2"
"G" MANAGER 6X2 & 6X4"
G340TI 6X6
G340TI 4X4
G340TI TR 18T
PREMIUM TR 4X2 ==>1999
PREMIUM 6X2&6X2/4 ==>1999
MAXTER 4X2-4X4
AE MAGNUM390/420TI/430/470/560
PREMIUM PR 4X2 ==> 1999
KERAX ==> 1999
PREMIUM 260 SP
PG230/280
MAGNUM E-TECH 400/440/480
PREMIUM TR 4X2 2000 ==>
PREMIUM(FAB22E/H/J/Q/R)2000==>
PREMIUM PR 4X2 (FAB22A)2000==>
KERAX FAB 33A==>S 2000==>2002
PREMIUM TRACTEUR 4X2(FAB 22CC)
PREMIUM(FAB22EE/HA/HB/JJ/QQ/RR)
PREMIUM PR 4X2 (FAB 22AA/AB)
KERAX (FAB 33AA/././SS)
KERAX (FAB33A/././R) 2003==>
PREMIUM 22C 071 ==> 1999
KERAX 33G ARMEE BANGLADESH
KERAX 33K ARMEE BANGLADESH

Sampa Nr.

080.573

O.E.M. Nr.

5010 060 127 S



Dimension

ø20xø44.5x104

Description

Rep. Kit Spring Bolt Assembly

G340TI TR 18T PREMIUM PR 4X2 (FAB22A)2000==>
PREMIUM TR 4X2 ==>1999
PREMIUM 6X2&6X2/4 ==>1999 PREMIUM TRACTEUR 4X2(FAB 22CC)
PREMIUM PR 4X2 ==> 1999 PREMIUM(FAB22EE/HA/HB/JJ/QQ/RR)
PREMIUM 260 SP
MAGNUM E-TECH 400/440/480 PREMIUM PR 4X2 (FAB 22AA/AB)
PREMIUM TR 4X2 2000 ==>
PREMIUM(FAB22E/H/J/Q/R)2000==> PREMIUM 22C 071 ==> 1999

Sampa Nr.

080.574

O.E.M. Nr.

5010 060 127 S1



Dimension

ø20xø44.5x104

Description

Rep. Kit Spring Bolt Assembly

G260/290
G210/230
G320
AE380/385TI/420TI/500/520
MAXTER 6X4 8X4
G230/270 SP
G220/270 BOM
G200/210/230TI
"G" MANAGER 4X2"
"G" MANAGER 6X2 & 6X4"
G340TI 6X6
G340TI 4X4
G340TI TR 18T
PREMIUM TR 4X2 ==>1999
PREMIUM 6X2&6X2/4 ==>1999
MAXTER 4X2-4X4
AE MAGNUM390/420TI/430/470/560
PREMIUM PR 4X2 ==> 1999
KERAX ==> 1999
PREMIUM 260 SP
PG230/280
MAGNUM E-TECH 400/440/480
PREMIUM TR 4X2 2000 ==>
PREMIUM(FAB22E/H/J/Q/R)2000==>
PREMIUM PR 4X2 (FAB22A)2000==>
KERAX FAB 33A==>S 2000==>2002
PREMIUM TRACTEUR 4X2(FAB 22CC)
PREMIUM(FAB22EE/HA/HB/JJ/QQ/RR)
PREMIUM PR 4X2 (FAB 22AA/AB)
KERAX (FAB 33AA/././SS)
KERAX (FAB33A/././R) 2003==>
PREMIUM 22C 071 ==> 1999
KERAX 33G ARMEE BANGLADESH
KERAX 33K ARMEE BANGLADESH

Sampa Nr.

080.576

O.E.M. Nr.

5010 060 127 S2



Dimension

ø20xø44.5x104

Description

Rep. Kit Spring Bolt Assembly

G340TI TR 18T PREMIUM(FAB22E/H/J/Q/R)2000==>
PREMIUM TR 4X2 ==>1999 PREMIUM PR 4X2 (FAB22A)2000==>
PREMIUM 6X2&6X2/4 ==>1999 MIDLUM 42B3/4-44TA/C.-45D/E.
PREMIUM PR 4X2 ==> 1999 PREMIUM TRACTEUR 4X2(FAB 22CC)
PREMIUM 260 SP PREMIUM(FAB22EE/HA/HB/JJ/QQ/RR)
MAGNUM E-TECH 400/440/480 PREMIUM PR 4X2 (FAB 22AA/AB)
PREMIUM TR 4X2 2000 ==> PREMIUM 22C 071 ==> 1999

Spring Suspension



Sampa Nr.

080.092

O.E.M. Nr.

5001 852 218

Dimension

ø30xø70x104

Description

Rubber Bushing for Spring

AE380/385TI/420TI/500/520
G340TI TR 18T
PREMIUM TR 4X2 ==>1999
PREMIUM 6X2&6X2/4 ==>1999
AE MAGNUM390/420TI/430/470/560
PREMIUM PR 4X2 ==> 1999

KERAX ==> 1999
MAGNUM E-TECH 400/440/480
PREMIUM TR 4X2 2000 ==>
PREMIUM(FAB22E/H/J/Q/R)2000==>
PREMIUM PR 4X2 (FAB22A)2000==>
KERAX FAB 33A==>S 2000==>2002

MIDLUM 42B3/4-44T/V/C.-45D./E.
PREMIUM TRACTEUR 4X2(FAB 22CC)
PREMIUM(FAB22EE/HA/HB/JJ/QQ/RR
PREMIUM PR 4X2 (FAB 22AA/AB)
KERAX (FAB 33AA.././SS)
PREMIUM 22C 071 ==> 1999



Sampa Nr.

080.559

O.E.M. Nr.

5001 852 218 S

Dimension

ø30xø70x104

Description

Rep. Kit Spring Bolt Assembly



Sampa Nr.

075.020

O.E.M. Nr.

5000 815 738

Dimension

ø30xø68x104

Description

Rubber Bushing for Spring

G260/290
R370/390/420 —>1989
R310/330/340/365 1984—>

AE380/385TI/420TI/500/520
"R" 1990—>1992"
"R" 1993—>"

"G" MANAGER 4X2"
"G" MANAGER 6X2 & 6X4"
AE MAGNUM390/420TI/430/470/560



Sampa Nr.

080.577

O.E.M. Nr.

5000 815 738 S

Dimension

ø30xø68x104

Description

Rep. Kit Spring Bolt Assembly



Sampa Nr.

011.072

O.E.M. Nr.

5010 557 698

Dimension

ø24xø62x96

Description

Rubber Bushing for Spring

MAGNUM DXI 12-VAR-12AV
PREMIUM DXI 11-FAB-27JC/TC
PREMIUM DXI 11-FAB-27RC/SC



Sampa Nr.

080.120

O.E.M. Nr.

5001 859 721

Dimension

ø24xø61.5x96.5

Description

Rubber Bushing for Spring

MAGNUM E-TECH 400/440/480
PREMIUM TR 4X2 2000 ==>
PREMIUM TRACTEUR 4X2(FAB 22CC)
PREMIUM(FAB22EE/HA/HB/JJ/QQ/RR
PREMIUM PR 4X2 (FAB 22AA/AB)
KERAX (FAB 33AA.././SS)

Sampa Nr.

080.181

O.E.M. Nr.

5010 066 115



Dimension

ø21xø56.5x85

Description

Rubber Bushing for Spring

AE380/385TI/420TI/500/520
AE MAGNUM390/420TI/430/470/560

Sampa Nr.

080.579

O.E.M. Nr.

5010 066 115 S



Dimension

ø21xø56.5x85

Description

Rep Kit Spring Bolt Assembly

AE380/385TI/420TI/500/520
AE MAGNUM390/420TI/430/470/560

Sampa Nr.

080.182

O.E.M. Nr.

5010 066 116



Dimension

ø25xø68.5x85

Description

Rubber Bushing for Spring

AE380/385TI/420TI/500/520
AE MAGNUM390/420TI/430/470/560

Sampa Nr.

080.580

O.E.M. Nr.

5010 066 116 S



Dimension

ø25xø68.5x85

Description

Rep Kit Spring Bolt Assembly

AE380/385TI/420TI/500/520
AE MAGNUM390/420TI/430/470/560

Sampa Nr.

080.183

O.E.M. Nr.

5010 557 875



Dimension

ø24xø61.5x95

Description

Rubber Bushing for Spring

MAGNUM DXI 12-VAR-120AV
PREMIUM DXI 11-FAB-27JC/TC
PREMIUM DXI 11-FAB-27RC/SC

Sampa Nr.

080.228

O.E.M. Nr.

5010 630 625



Dimension

ø20xø50x96

Description

Rubber Bushing for Spring

PREMIUM DXI 11-FAB-27JC/TC
PREMIUM DXI 11-FAB-27RC/SC
MAGNUM DXI 12-VAR-120AV

Spring Suspension



Sampa Nr.

080.157

O.E.M. Nr.

5010 130 652

Dimension

ø63.5xø111x146

Description

Rubber Bushing for Spring

MAXTER 6X4 8X4
KERAX ==> 1999
KERAX FAB 33A==>S 2000==>2002
KERAX (FAB 33AAV.././SS)



Sampa Nr.

080.158

O.E.M. Nr.

5010 130 653

Dimension

h:140

Description

Spring Cushion

MAXTER 6X4 8X4
KERAX ==> 1999
KERAX FAB 33A==>S 2000==>2002
KERAX (FAB 33AAV.././SS)



Sampa Nr.

080.582

O.E.M. Nr.

5010 130 652 S

Dimension

ø63.5xø111x146

Description

Rep Kit Spring Bolt Assembly

MAXTER 6X4 8X4
KERAX ==> 1999
KERAX FAB 33A==>S 2000==>2002
KERAX (FAB 33AAV.././SS)



Sampa Nr.

080.180

O.E.M. Nr.

5010 130 654

Dimension

ø64xø75.5x70

Description

Plastic Bushing for Spring

MAXTER 6X4 8X4
KERAX==>1999
KERAX FAB 33A==>S 2000==>2002



Sampa Nr.

080.583

O.E.M. Nr.

5010 130 652 S1

Dimension

ø52.5xø63x94

Description

Rep Kit Spring Bolt Assembly

MAXTER 6X4 8X4
KERAX ==> 1999
KERAX FAB 33A==>S 2000==>2002
KERAX (FAB 33AAV.././SS)



Sampa Nr.

030.078

O.E.M. Nr.

7420 390 836

Dimension

h:151

Description

Spring Cushion

PREMIUM 440-450
KERAX DXI

Sampa Nr.

080.024

O.E.M. Nr.

5010 052 742



Dimension

ø65.5xø104.5x132.5

Description

Rubber Bushing for Spring

"R310/330/340/365 1984—>
M140/160/200/230
AE380/385TI/420TI/500/520
MIDLINER GRANDE-BRETAGNE
"R" 1990—>1992
M/S 150/180/210/220/230TI/250
"R" 1993—>
G220/270 BOM
AE MAGNUM390/420TI/430/470/560"

Sampa Nr.

080.132

O.E.M. Nr.

5010 052 741



Dimension

ø30xø85x127

Description

Rubber Bushing for Spring

"R310/330/340/365 1984—>
M140/160/200/230
AE380/385TI/420TI/500/520
MIDLINER GRANDE-BRETAGNE
"R" 1990—>1992
M/S 150/180/210/220/230TI/250
"R" 1993—>
G220/270 BOM
AE MAGNUM390/420TI/430/470/560"

Sampa Nr.

080.108

O.E.M. Nr.

5010 052 740



Dimension

M24x3/ø65x61

Description

Bushing for Spring Pin

"R310/330/340/365 1984—>
M140/160/200/230 AE380/385TI/420TI/500/520
MIDLINER GRANDE-BRETAGNE
"R"1990—>1992
M/S 150/180/210/220/230TI/250
"R" 1993—>
G220/270 BOM
AE MAGNUM390/420TI/430/470/560"

Sampa Nr.

080.555

O.E.M. Nr.

5010 052 741 S



Dimension

ø30xø85x127

Description

Rep. Kit Spring Bolt Assembly

M140/160/200/230
AE380/385TI/420TI/500/520
MIDLINER GRANDE-BRETAGNE
M/S 150/180/210/220/230TI/250
"R" 1993—>
G220/270 BOM
AE MAGNUM390/420TI/430/470/560

Sampa Nr.

080.556

O.E.M. Nr.

5010 052 742 S



Dimension

ø65.5xø104.5x132.5

Description

Rep. Kit Spring Bolt Assembly

R310/330/340/365 1984—>
M140/160/200/230
AE380/385TI/420TI/500/520
MIDLINER GRANDE-BRETAGNE
"R" 1990—>1992
M/S 150/180/210/220/230TI/250
"R" 1993—>
G220/270 BOM
AE MAGNUM390/420TI/430/470/560

Sampa Nr.

080.093

O.E.M. Nr.

5010 137 848



Dimension

ø24xø61x90.5

Description

Rubber Bushing for Spring

M140/160/200/230
AE380/385TI/420TI/500/520
M/S 150/180/210/220/230TI/250
G220/270 BOM
AE MAGNUM390/420TI/430/470/560

Spring Suspension



Sampa Nr.

080.062

O.E.M. Nr.

5000 448 404

Dimension

ø16xø43.5x95

Description

Rubber Bushing for Spring

M140/160/200/230
MIDLINER GRANDE-BRETAGNE
M/S 150/180/210/220/230TI/250
PA200/210

MIDLUM(FAB42B1/2-43C1/2-43T/V)
MIDLUM EXPORT (FAB 43E1-43E2)
MIDLUM 42B3/4-44T/V/C.-45D./E.
MIDLUM 4X4 47XA/47XC



Sampa Nr.

080.553

O.E.M. Nr.

5000 448 404 S

Dimension

ø16xø43.5x95

Description

Rep. Kit Spring Bolt Assembly

MIDLUM CCF 4X4 (FAB 47XF)
MIDLUM(FAB 42US-44US-45US)



Sampa Nr.

080.095

O.E.M. Nr.

5000 448 405

Dimension

ø20xø54x95

Description

Rubber Bushing for Spring

M140/160/200/230
MIDLINER GRANDE-BRETAGNE
M/S 150/180/210/220/230TI/250
PS150/160

PA200/210
MIDLUM(FAB42B1/2-43C1/2-43T/V)
MIDLUM EXPORT (FAB 43E1-43E2)
MIDLUM 42B3/4-44T/V/C.-45D./E.



Sampa Nr.

080.551

O.E.M. Nr.

5000 448 405 S

Dimension

ø20xø54x95

Description

Rep. Kit Spring Bolt Assembly

MIDLUM 4X4 47XA/47XC
MIDLUM CCF 4X4 (FAB 47XF)
MIDLUM(FAB 42US-44US-45US)



Sampa Nr.

080.122

O.E.M. Nr.

5010 294 961

Dimension

ø16xø43x81

Description

Rubber Bushing for Spring

MIDLUM(FAB42B1/2-43C1/2-43TA/)
MIDLUM 42B3/4-44TA//C.-45D./E.
MIDLUM(FAB 42US-44US-45US)



Sampa Nr.

080.184

O.E.M. Nr.

5010 294 770

Dimension

ø20.5xø53.5x81

Description

Rubber Bushing for Spring

MIDLUM 42B3/4-44T/V/C.-45D./E
MIDLUM(FAB 42US-44USI-45US)

Sampa Nr.	011.140
O.E.M. Nr.	5000 288 447
Image	
Dimension	55x80.5x14
Description	Spring Buffer
Part Numbers	S110/130 (VF6JK) S135/150 (MOT 040226) S100 MASCOTT MIDLINER GRANDE-BRETAGNE MASCOTT DXI S140/160 B80/110/120 M/S 150/180/210/220/230TI/250 S120/135

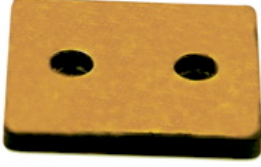
Sampa Nr.	030.087
O.E.M. Nr.	5001 832 708
Image	
Dimension	90x100x10.5
Description	Spring Buffer
Part Numbers	R 1990—>1992 R 1993—> G340TI TR 18T PREMIUM TR 4X2 ==>1999 PREMIUM TR 4X2 2000 ==> PREMIUM 22C 071==> 1999

Sampa Nr.	080.210
O.E.M. Nr.	5001 834 111
Image	
Dimension	80x100x11
Description	Spring Buffer
Part Numbers	AE380/385TI/420TI/500/520 G MANAGER 4X2 AE MAGNUM390/420TI/430/470/560 KERAX==>1999 MAGNUM E-TECH 400/440/480 PREMIUM TR 4X2 2000 ==> PREMIUM TRACTEUR 4X2(FAB 22CC) KERAX (FAB 33AAV.././SS)

Sampa Nr.	080.211
O.E.M. Nr.	5001 853 313
Image	
Dimension	60x60x18/46
Description	Spring Buffer
Part Numbers	MIDLUM(FAB42B1 /2-43C1 /2-43T/V) MIDLUM 42B3/4-44T/V/C.-45D./E. MIDLUM 4X4 47XA/47XC MIDLUM CCF 4X4 (FAB 47XF) MIDLUM(FAB 42US-44US-45US)

Sampa Nr.	080.212
O.E.M. Nr.	5001 014 359
Image	
Dimension	66x80x18/46
Description	Spring Buffer
Part Numbers	M140/160/200/230 PREMIUM PR 4X2 (FAB22A)2000==> MIDLINER GRANDE-BRETAGNE MIDLUM EXPORT (FAB 43E1-43E2) M/S 150/180/210/220/230TI/250 MIDLUM 42B3/4-44T/V/C.-45D./E. PREMIUM PR 4X2 ==> 1999 MIDLUM 4X4 47XA/47XC PA200/210 PREMIUM PR 4X2 (FAB 22AA/AB) PREMIUM 260 SP MIDLUM(FAB42B1 /2-43C1/2-43T/V) MIDLUM(FAB 42US-44US-45US)

Sampa Nr.	080.213
O.E.M. Nr.	5001 834 501
Image	
Dimension	80x86x22/52
Description	Spring Buffer
Part Numbers	PREMIUM PR 4X2 = ==> 1999 PREMIUM 260 SP

Spring Suspension



Sampa Nr.

080.111

O.E.M. Nr.

5010 383 949

Dimension

M10/ø63.5x51.5

Description

Spring Buffer

GB131/HR15	PREMIUM 6X2&6X2/4 ==>1999
GB/TB191/231	AE MAGNUM390/420TI/430/470/560
GR191/231	PREMIUM PR 4X2 ==> 1999
GRH235/HF26	KERAX ==> 1999
G260/290	PG230/280 MAGNUM E-TECH
C260/290	400/440/480
C210/CLR220	PREMIUM TR 4X2 2000 ==>
G170	PREMIUM(FAB22E/H/J/Q/R)2000==>
G210/230	PREMIUM PR 4X2 (FAB22A)2000==>
G320	KERAX FAB 33A==>S 2000==>2002
AE380/385TI/420TI/500/520	PREMIUM TRACTEUR 4X2(FAB 22CC)
MAXTER 6X4 8X4	PREMIUM(FAB22EE/HA/HB/JJ/QQ/RR
G230/270 SP	PREMIUM PR 4X2 (FAB 22AA/AB)
G220/270 BOM	KERAX (FAB 33AA/././SS)
G200/210/230TI	MAGNUM DXI 12 -VAR-120AV
"G" MANAGER 4X2"	PREMIUM DXI 11 -FAB-27RC/SC
"G" MANAGER 6X2 & 6X4"	PREMIUM 22C 071 ==> 1999
PREMIUM TR 4X2 ==>1999	



Sampa Nr.

080.152

O.E.M. Nr.

0000 777 903

Dimension

56x81x43.5

Description

Spring Buffer

GRH/TRH305
GRH/TRH350
GBH/TBH280 1981-->
GBH260/280 6X6
C260/290
R360 6X4 --> 10/1983
R310 6X4 JSQ 8/1984
R370 JSQ 1984
R370/390/420 -->1989
R310/330/340/365 1984-->
CBH/CLM280/340
"R" 1990-->1992"
C230/280/300/340TI/CCH300
MAXTER 6X4 8X4
CBH/CLM 320/385
"R" 1993-->"
G340TI 6X6
KERAX ==> 1999
KERAX FAB 33A==>S 2000==>2002
KERAX (FAB 33AA/././SS)
KERAX (FAB33A/././R) 2003==>
KERAX 33G ARMEE BANGLADESH
KERAX 33K ARMEE BANGLADESH



Sampa Nr.

080.243

O.E.M. Nr.

5000 745 055

Dimension

95x120/126x77

Description

Spring Buffer

GB131/HR15	PGC191/231	G320
GB/TB191/231	GLC/GLR190/230	G230/270 SP
GC191/231	G260/290	G200/210/230TI
TF231D	G170	G MANAGER 4X2
GF151D	G210/230	



Sampa Nr.

080.154

O.E.M. Nr.

0000 750 383

Dimension

M10/106/121x66

Description

Spring Buffer

GRH235/HF26
GRH/TRH305
GRH/TRH350
GBH/TBH280 1981-->
GBH260/280 6X6
GBH260/280 6X4 -->1980
R360 6X4 -->10/1983
R310 6X4 JSQ 8/1984
110-130 6X6
R370 JSQ 1984
R370/390/420 -->1989
R310/330/340/365 1984-->
CBH/CLM280/340
"R" 1990-->1992"
C230/280/300/340TI/CCH300
MAXTER 6X4 8X4
CBH/CLM 320/385
"R" 1993-->"
"G" MANAGER 6X2 & 6X4"
G340TI 6X6
KERAX ==> 1999
KERAX(FAB33A/././S) 2000 ==>
KERAX (FAB 33AA/././SS)



Sampa Nr.

080.244

O.E.M. Nr.

5000 745 612

Dimension

50x126x14

Description

Spring Buffer

GB131/HR15	PGC191/231	G320
GB/TB191/231	GLC/GLR190/230	G230/270 SP
GC191/231	G260/290	G200/210/230TI
TF231D	G170	G MANAGER 4X2
GF151D	G210/230	

Sampa Nr.

080.037

O.E.M. Nr.

5010 383 950



Dimension

M12/ø79.5x121

Description

Spring Buffer

GBH/TBH280 1981—>
 GBH260/280 6X6
 GBH260/280 6X4 —>1980
 GLM/TLM280
 R370 JSQ 1984
 R370/390/420 —>1989
 R310/330/340/365 1984—>
 CBH/CLM280/340
 "R" 1990—>1992"
 M/S 4X4 & INCENDIE
 MAXTER 6X4 8X4
 CBH/CLM 320/385
 "R" 1993—>"
 G340TI 6X6
 MAXTER 4X2-4X4
 KERAX ==> 1999
 KERAX FAB 33A==>S 2000==>2002
 KERAX (FAB 33AA././SS)
 KERAX (FAB33A././R) 2003==>
 KERAX 33G ARMEE BANGLADESH
 KERAX 33K ARMEE BANGLADESH

Sampa Nr.

080.186

O.E.M. Nr.

5010 294 739



Dimension

ø17xø61x75/83.5

Description

Rubber Bushing for Spring

M/S 150/180/210/220/230TI/250
 MIDLUM(FAB42B1 /2-43C1/2-43T/V)
 MIDLUM 42B3/4-44TMC.-45D./E.
 MACK MS200/250/300 1990—>
 MACK CS200/250/300 1990—>
 MIDLUM(FAB 42US-44US-45US)

Sampa Nr.

080.187

O.E.M. Nr.

5001 862 978



Dimension

ø35xø45x75

Description

Plastic Bushing for Spring

PREMIUM TR 4X2 ==>1999
 PREMIUM PR 4X2 ==> 1999
 MAGNUM E-TECH 400/440/480
 PREMIUM(FAB22E/H/J/Q/R)2000==>
 PREMIUM(FAB22EE/HA/HB/JJ/QQ/RR

Sampa Nr.

080.185

O.E.M. Nr.

7408 079 890



Dimension

ø21xø57.5x67

Description

Plastic Bushing for Spring

MIDLUM 42B3/4-44T/V/C.-45D./E

Sampa Nr.

080.249

O.E.M. Nr.

0000 715 368



Dimension

ø20xø79x61

Description

Spring Buffer

GR/TR280

Spring Suspension



Sampa Nr.

080.140

O.E.M. Nr.

5001 851 118

Dimension

ø28.2xø34.2x89.3

Description

Spring Bushing

GC191/231
GR191/231
GRH235/HF26
TF231D
GF151D
GBH/TBH280 1981—>
PGC191/231
GBH260/280 6X6
GBH260/280 6X4 —>1980
GLC/GLR190/230
GLM/TLM280
GLR230 4X4 SINPAR
G170/210/230/320/260/290
CBH/CLM280/340
MAXTER 6X4 8X4
CBH/CLM 320/385

G230/270 SP
G220/270 BOM
G200/210/230TI
"G" MANAGER 4X2"
"G" MANAGER 6X2 & 6X4"
G340TI 6X6 4X4
G340TI TR 18T
MAXTER 4X2-4X4
KERAX ==> 1999
PG230/280
KERAX FAB 33A==>S
2000==>2002
KERAX (FAB 33AA/././SS)
KERAX (FAB33A/././R) 2003==>
KERAX 33G ARMEE BANGLADESH
KERAX 33K ARMEE BANGLADESH



Sampa Nr.

080.142

O.E.M. Nr.

5010 064 632

Dimension

ø28x146.5

Description

Spring Pin

GBH/TBH280 1981—>
GLM/TLM280
CBH/CLM280/340
MAXTER 6X4 8X4
CBH/CLM 320/385
G340TI 6X6
MAXTER 4X2-4X4

KERAX ==> 1999
KERAX FAB 33A==>S
2000==>2002
KERAX (FAB 33AA/././SS)
KERAX (FAB33A/././R) 2003==>
KERAX 33G ARMEE BANGLADESH
KERAX 33K ARMEE BANGLADESH



Sampa Nr.

080.141

O.E.M. Nr.

5000 710 780

Dimension

ø36xø44.5x89

Description

Spring Bushing

G260/290
C260/290
C210/CLR220
G320
C230/280/300/340TI/CCH300
"G" MANAGER 4X2"

G340TI 4X4
MAXTER 4X2-4X4
KERAX ==> 1999
KERAX FAB 33A==>S 2000==>2002
KERAX (FAB 33AA/././SS)
KERAX (FAB33A/././R) 2003==>



Sampa Nr.

080.143

O.E.M. Nr.

0000 758 346

Dimension

ø32x166

Description

Spring Pin

TR/GR305
TR/GR350
GR191/231
GR/TR280
R310 4X2 ->8/84
R360 4X2
GLC/GLR190/230
GLM/TLM280
GLR230 4X4 SINPAR
G210/230/260/290/320
R370 JSQ 1984
R370/390/420 —>1989

R310/330/340/365 1984—>
CBH/CLM280/340
"R" 1990—>1992"
CBH/CLM 320/385
"R" 1993—>"
G220/270 BOM
G200/210/230TI
"G" MANAGER 4X2"
"G" MANAGER 6X2 & 6X4 "
KERAX FAB 33A==>S 2000==>2002
KERAX (FAB33A/././R) 2003==>



Sampa Nr.

080.188

O.E.M. Nr.

5000 542 198

Dimension

ø25xø32x70

Description

Spring Bushing

FJK/PJN/PJP
JN55/60/85
JK55/60/65/75
S130/150TI (VF6JN)
S110/130(VF6JK)
S100
MIDLINER GRANDE-BRETAGNE
S140/160

M/S 150/180/210/220/230TI/250
PS150/160
S120/135
S135/150 (MOT 040226)
MIDLUM/FAB42B1 /2-43C1/2-43T/M)
MIDLUM 42B3/4-44T/V/C.-45D/E.
MIDLUM/FAB 42US-44US-45US)



Sampa Nr.

020.113

O.E.M. Nr.

5000 286 235

Dimension

ø25x143

Description

Spring Pin

<p><i>Sampa Nr.</i></p> <p>080.189</p> <p><i>O.E.M. Nr.</i></p> <p>5810 110 749</p>	 <p><i>Dimension</i></p> <p>ø28x216</p> <p><i>Description</i></p> <p>Spring Pin</p>	<p><i>Sampa Nr.</i></p> <p>080.190</p> <p><i>O.E.M. Nr.</i></p> <p>5000 703 619</p>	 <p><i>Dimension</i></p> <p>ø28x142</p> <p><i>Description</i></p> <p>Spring Pin</p>
<p>G260/290 G MANAGER 6X2 & 6X4</p>	<p>GR191/231 TF231D GF151D GLC/GLR190/230 G260/290 G170 G210/230 G320</p>	<p>G230/270 SP G220/270 BOM G200/210/230TI G MANAGER 4X2 G MANAGER 6X2 & 6X4 G340TI 4X4 PG230/280</p>	
<p><i>Sampa Nr.</i></p> <p>080.191</p> <p><i>O.E.M. Nr.</i></p> <p>0005 000 598</p>	 <p><i>Dimension</i></p> <p>ø20x105.5</p> <p><i>Description</i></p> <p>Spring Pin</p>	<p><i>Sampa Nr.</i></p> <p>080.192</p> <p><i>O.E.M. Nr.</i></p> <p>0000 743 176</p>	 <p><i>Dimension</i></p> <p>ø32x153</p> <p><i>Description</i></p> <p>Spring Pin</p>
	<p>GB/TB191/231 GC191/231 GF151D PGC191/231 GLC/GLR190/230 G260/290 G170</p>	<p>G210/230 G230/270 SP G200/210/230TI G MANAGER 4X2</p>	
<p><i>Sampa Nr.</i></p> <p>080.193</p> <p><i>O.E.M. Nr.</i></p> <p>0000 723 727</p>	 <p><i>Dimension</i></p> <p>ø28x132</p> <p><i>Description</i></p> <p>Spring Pin</p>	<p><i>Sampa Nr.</i></p> <p>080.194</p> <p><i>O.E.M. Nr.</i></p> <p>0000 796 874</p>	 <p><i>Dimension</i></p> <p>ø36x163</p> <p><i>Description</i></p> <p>Spring Pin</p>
<p>770KB6 SP</p>	<p>TF231D G260/290 G320 G MANAGER 4X2 G340TI 4X4</p>		

Spring Suspension



Sampa Nr.

080.195

O.E.M. Nr.

0000 743 098

Dimension

ø24x142

Description

Spring Pin

GB131/HR15
GB/TB191/231



Sampa Nr.

080.196

O.E.M. Nr.

5000 435 084

Dimension

ø30x149

Description

Spring Pin



Sampa Nr.

080.197

O.E.M. Nr.

5000 546 979

Dimension

ø25x131.5

Description

Spring Pin

PJK/PJN/PJP	S140/160
JN55/60/85	M/S 150/180/210/220/230TV/250
JK55/60/65/75	PS150/160
J&S4X4→5/1991	S120/135
S130/150TI (VF6JN)	S135/150 (MOT 040226)
S110/130(VF6JK)	MIDLUM(FAB42B1 /2-43C1/2-43TV)
S100	MIDLUM 42B3/4-44TV/C.-45D./E.
MIDLINER GRANDE-BRETAGNE	MIDLUM(FAB 42US-44US-45US)



Sampa Nr.

080.199

O.E.M. Nr.

5000 740 956

Dimension

ø32x160

Description

Spring Pin

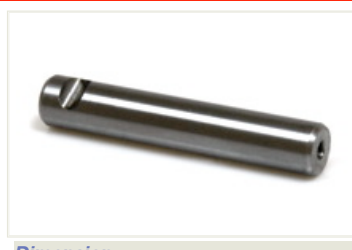

Sampa Nr.

080.200

O.E.M. Nr.

0000 743 064

Dimension

ø22x124.5

Description

Spring Pin

GB131/HR15	110-130 6X6
GB/TB191/231	770KB6 SP



Sampa Nr.

080.198

O.E.M. Nr.

0000 729 137

Dimension

ø32x160

Description

Spring Pin

TR/GR305	R310 6X4 JSQ 8/1984
TR/GR350	R370 JSQ1984
GR/TR280	R370/390/420->1989
GRH/TRH305	R310/330/340/365 1984→
GRH/TRH350	R 1990->1992
R310 4X2->8/84	R 1993->
R360 4X2	G MANAGER 6X2 & 6X4
G260/290	
R360 6X4->10/1983	



Sampa Nr.

080.201

O.E.M. Nr.

0000 716 814

Dimension

ø28x142

Description

Spring Pin

GC191/231	G170
GR191/231	G210/230
GRH235/HF26	G320
GBH/TBH280 1981→	G230/270 SP
PGC191/231	G220/270 BOM
GBH260/280 6X6	G200/210/230TI
GBH260/280 6X4->1980	G MANAGER 4X2
GLC/GLR190/230	G MANAGER 6X2 & 6X4
G260/290	G340TI 4X4
GLM/TLM280	G340TI TR18T
GLR230 4X4 SINPAR	PG230/280

Sampa Nr.

080.202

O.E.M. Nr.

5010 164 592



Dimension

ø30x136

Description

Spring Pin

PJK/PJN/PJP	M/S 4X4 & INCENDIE
JE13/15	ME/SE/CE/160/180/210
JP11/13	PS150/160
JR/JX19/21	M210 4X4
S170 (FAB=SH)	MS300 SUDAMERICA
J&S4X4—>5/1991	MIDLUM EXPORT (FAB 43E1-43E2)
S130/150TI (VF6JN)	MACK MS200/250/300 1990—>
S130/150TI/170 (VF6JP)	MACK CS200/250/300 1990—>
M140/160/200/230	

Sampa Nr.

080.203

O.E.M. Nr.

0000 790 396



Dimension

ø32x164

Description

Spring Pin

TR/GR305	R370/390/420—>1989
TR/GR350	R310/330/340/365 1984—>
GR/TR280	R 1990—>1992
GRH/TRH305	R 1993—>
GRH/TRH350	G MANAGER 6X2 & 6X4
R310 4X2—>8/84	
R360 4X2	
R360 6X4—>10/1983	
R310 6X4 JSQ 8/1984	
R370JSQ1984	

Sampa Nr.

080.204

O.E.M. Nr.

0005 011 686



Dimension

ø24x130.5

Description

Spring Pin

Sampa Nr.

080.205

O.E.M. Nr.

5430 022 286



Dimension

ø35x174.5

Description

Spring Pin

G260/290
G MANAGER 6X2 & 6X4

Sampa Nr.

080.206

O.E.M. Nr.

5000 285 345



Dimension

ø30x162.5

Description

Spring Pin

Sampa Nr.

080.207

O.E.M. Nr.

5000 745 493



Dimension

ø30x155

Description

Spring Pin

G260/290
G170
G210/230
G320
G200/210/230TI
G MANAGER 4X2

Sampa Nr.

080.208

O.E.M. Nr.

5810 111 800



Dimension

ø28x145

Description

Spring Pin

G MANAGER 6X2&6X4

Spring Suspension



Sampa Nr.

080.209

O.E.M. Nr.

5430 044 067

Dimension

ø35x175

Description

Spring Pin

AE380/385TI/420TI/500/520
 R 1993—>
 PREMIUM TR 4X2 ==>1999
 PREMIUM 6X2&6X2/4 ==>1999
 AE MAGNUM390/420TI/430/470/560
 PREMIUM PR 4X2 ==> 1999
 MAGNUM E-TECH 400/440/480
 PREMIUM(FAB22E/H/J/Q/R)2000==>
 PREMIUM(FAB22EE/HA/HB/JJ/QQ/RR)



Sampa Nr.

080.146

O.E.M. Nr.

0000 466 526

Dimension

M16x2/232

Description

Spring Pin

GRH/TRH305
 GRH/TRH350
 GBH/TBH280 1981—>
 GBH260/280 6X6
 GLC/GLR190/230
 C260/290
 R360 6X4 —> 10/1983
 R310 6X4 JSQ 8/1984
 GLR230 4X4 SINPAR
 R370 JSQ 1984
 R370/390/420 —>1989
 R310/330/340/365 1984—>
 CBH/CLM280/340
 "R" 1990—>1992"
 C230/280/300/340TI/CCH300
 CBH/CLM 320/385
 "R" 1993—>"
 MAXTER 4X2-4X4
 KERAX ==> 1999
 KERAX FAB 33A==>S 2000==>2002
 KERAX (FAB 33AA/././SS)
 KERAX (FAB33A/././R) 2003==>



Sampa Nr.

030.263

O.E.M. Nr.

7420 429 274

Dimension

Description

Cradle

PREMIUM 440-450



Sampa Nr.

030.264

O.E.M. Nr.

7420 442 252

Dimension

ø81/ø104xø154/ø173x71

Description

Bogie Suspension Bearing

PREMIUM 440-450
 KERAX DXI



Sampa Nr.

030.265

O.E.M. Nr.

7420 466 804

Dimension

ø25xø107x74

Description

Bogie Suspension Bearing

PREMIUM 440-450
 KERAX DXI

Sampa Nr.

030.137

O.E.M. Nr.

5010 239 669

Dimension

ø64xø68x21.5

Description

Cabin Bushing

PREMIUM PR 4X2 ==> 1999
 KERAX ==> 1999
 PREMIUM 260 SP
 PREMIUM 260 SP KERAX FAB
 33A==>S 2000==>2002
 KERAX (FAB 33AA/././SS)
 KERAX (FAB33A/./R) 2003==>

Sampa Nr.

030.138

O.E.M. Nr.

5010 228 947

Dimension

ø30xø68x49

Description

Cabin Mounting

PREMIUM PR 4X2 ==> 1999
 KERAX ==> 1999
 PREMIUM 260 SP
 PREMIUM 260 SP KERAX FAB 33A==>S 2000==>2002
 KERAX (FAB 33AA/././SS)
 KERAX (FAB33A/./R) 2003==>

Sampa Nr.

080.159

O.E.M. Nr.

5010 228 956

Dimension

ø30

Description

Cabin Bracket

PREMIUM PR 4x2 ==> 2000==>2002
 KERAX==>1999 KERAX (FAB 33AA/././SS)
 PREMIUM 260 SP KERAX(FAB33A/./R) 2003==>
 KERAX FAB 33A==>S KERAX 33G ARMEE BANGLADESH

Sampa Nr.

080.578

O.E.M. Nr.

5010 228 947 S

Dimension

ø30xø68x49

Description

Rep. Kit for Cabin

PREMIUM PR 4X2 ==> 1999
 KERAX ==> 1999
 PREMIUM 260 SP
 PREMIUM 260 SP KERAX FAB 33A==>S 2000==>2002
 KERAX (FAB 33AA/././SS)
 KERAX (FAB33A/./R) 2003==>
 KERAX 33G ARMEE BANGLADESH

Sampa Nr.

080.112

O.E.M. Nr.

5001 844 625

Dimension

ø14xø42.5x60

Description

Cabin Mounting

AE380/385TI/420TI/500/520
 AE MAGNUM390/420TI/430/470/560
 MAGNUM E-TECH 400/440/480

Sampa Nr.

080.114

O.E.M. Nr.

5010 418 819

Dimension

ø14xø27x45

Description

Cabin Mounting

AE380/385TI/420TI/500/520
 AE MAGNUM390/420TI/430/470/560
 MAGNUM E-TECH 400/440/480

Cabin



Sampa Nr.

080.175

O.E.M. Nr.

5010 552 347

Dimension

ø20xø48x42

Description

Cabin Mounting

PREMIUM DXI 11-FAB-27JC/TC
PREMIUM DXI 11-FAB-27RC/SC



Sampa Nr.

080.176

O.E.M. Nr.

5010 610 378

Dimension

ø20.5x170

Description

Bolt for Cabin

PREMIUM DXI 11-FAB-27JC/TC
PREMIUM DXI 11-FAB-27RC/SC



Sampa Nr.

080.226

O.E.M. Nr.

5010 552 346

Dimension

ø20xø65x55

Description

Cabin Mounting

PREMIUM DXI 11-FAB-27JC/TC
PREMIUM DXI 11-FAB-27RC/SC



Sampa Nr.

080.227

O.E.M. Nr.

5010 552 020

Dimension

ø20.5x210

Description

Bolt for Cabin

PREMIUM DXI 11-FAB-27JC/TC
PREMIUM DXI 11-FAB-27RC/SC

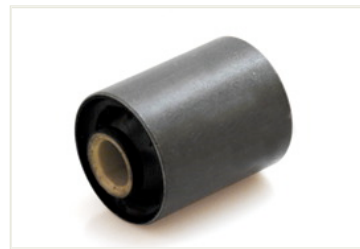

Sampa Nr.

080.016

O.E.M. Nr.

5000 419 186

Dimension

ø20xø58x81

Description

Cabin Mounting

JE13/15
G260/290
JN55/60/85
JP11/13
JK55/60/65/75
JR/JX19/21
S170 (FAB=SH)
G170
G210/230
S130/150TI (VF6JN)
S130/150TI/170 (VF6JP)
J35/48/55/60
S110/130 (VF6JK)
S100
G320
M140/160/200/230
MIDLINER GRANDE-BRETAGNE
S140/160

M/S 4X4 & INCENDIE
ME/SE/CE/ 160/180/210
MAXTER 6X4 8X4
M/S 150/180/210/220/230TI/250
G230/270 SP
S120/135
G220/270 BOM
G200/210/230TI
"G" MANAGER 4X2"
"G" MANAGER 6X2 & 6X4"
G340TI 6X6
G340TI 4X4
MAXTER 4X2-4X4
S135/150 (MOT 040226)
M210 4X4
MS300 SUDAMERICA
MACK MS200/250/300 1990—>



Sampa Nr.

080.119

O.E.M. Nr.

5010 130 430

Dimension

ø18xø48x68.5

Description

Cabin Mounting

"R" 1993—>"

<p><i>Sampa Nr.</i></p> <p>080.018</p> <p><i>O.E.M. Nr.</i></p> <p>5010 273 535</p> <p><i>Description</i></p> <p>Cabin Mounting</p>	 <p><i>Dimension</i></p> <p>ø16.5xø50x80</p>	<p><i>Sampa Nr.</i></p> <p>080.019</p> <p><i>O.E.M. Nr.</i></p> <p>5010 418 820</p> <p><i>Description</i></p> <p>Cabin Mounting</p>	 <p><i>Dimension</i></p> <p>ø16xø38x90</p>
<p><i>Sampa Nr.</i></p> <p>080.020</p> <p><i>O.E.M. Nr.</i></p> <p>5010 211 938</p> <p><i>Description</i></p> <p>Rubber Dust Cover for Cabin</p>	 <p><i>Dimension</i></p> <p>ø30xø46x28.5</p>	<p><i>Sampa Nr.</i></p> <p>080.021</p> <p><i>O.E.M. Nr.</i></p> <p>5010 211 939</p> <p><i>Description</i></p> <p>Cabin Mounting</p>	 <p><i>Dimension</i></p> <p>M18/38.5</p>
<p><i>Sampa Nr.</i></p> <p>080.022</p> <p><i>O.E.M. Nr.</i></p> <p>5001 852 865</p> <p><i>Description</i></p> <p>Cabin Mounting</p>	 <p><i>Dimension</i></p> <p>ø28xø38x40</p>	<p><i>Sampa Nr.</i></p> <p>080.023</p> <p><i>O.E.M. Nr.</i></p> <p>5010 060 298</p> <p><i>Description</i></p> <p>Cabin Bushing</p>	 <p><i>Dimension</i></p> <p>ø16xø28x80</p>
<p>AE380/385TI/420TI/500/520 AE MAGNUM390/420TI/430/470/560 MAGNUM E-TECH 400/440/480</p>		<p>AE380/385TI/420TI/500/520 AE MAGNUM390/420TI/430/470/560 MAGNUM E-TECH 400/440/480</p>	<p>AE380/385TI/420TI/500/520</p>

Cabin



Sampa Nr.

080.017

O.E.M. Nr.

5010 316 016

Dimension

ø25.5xø70.5x10

Description

Buffer for Cabin

PREMIUM TR 4X2 ==>1999
 PREMIUM 6X2&6X2/4 ==>1999
 PREMIUM PR 4X2 ==> 1999
 KERAX ==> 1999
 PREMIUM TR 4X2 2000 ==>
 PREMIUM(FAB22E/H/J/Q/R)2000==>
 PREMIUM PR 4X2 (FAB22A)2000==>
 KERAX FAB 33A==>S 2000==>2002
 PREMIUM TRACTEUR 4X2(FAB 22CC)

PREMIUM(FAB22EE/HA/HB/JJ/QQ/RR)
 PREMIUM PR 4X2 (FAB 22AA/AB)
 KERAX (FAB 33AA/././SS)
 KERAX (FAB33A/./R) 2003==>
 PREMIUM DXI 11 -FAB-27JC/TC
 PREMIUM DXI 11 -FAB-27RC/SC
 SISU
 PREMIUM 22C 071 ==> 1999
 KERAX 33K ARMEE BANGLADESH



Sampa Nr.

080.043

O.E.M. Nr.

5010 316 015

Dimension

ø16xø60.5x68

Description

Cabin Mounting

PREMIUM TR 4X2 ==>1999
 PREMIUM 6X2&6X2/4 ==>1999
 PREMIUM PR 4X2 ==> 1999
 KERAX ==> 1999
 PREMIUM TR 4X2 2000 ==>
 PREMIUM(FAB22E/H/J/Q/R)2000==>
 PREMIUM PR 4X2 (FAB22A)2000==>
 KERAX FAB 33A==>S 2000==>2002
 MIDLUM 42B3/4-44TA/C.-45D/E.

PREMIUM TRACTEUR 4X2(FAB 22CC)
 PREMIUM(FAB22EE/HA/HB/JJ/QQ/RR)
 PREMIUM PR 4X2 (FAB 22AA/AB)
 KERAX (FAB 33AA/././SS)
 PREMIUM DXI 11 -FAB-27JC/TC
 PREMIUM DXI 11 -FAB-27RC/SC
 SISU
 PREMIUM 22C 071 ==> 1999



Sampa Nr.

080.557

O.E.M. Nr.

5010 316 015 S

Dimension

ø16xø60.5x68

Description

Rep. Kit for Cabin

PREMIUM TR 4X2 ==>1999
 PREMIUM 6X2&6X2/4 ==>1999
 PREMIUM PR 4X2 ==> 1999
 KERAX ==> 1999
 PREMIUM TR 4X2 2000 ==>
 PREMIUM(FAB22E/H/J/Q/R)2000==>
 PREMIUM PR 4X2 (FAB22A)2000==>

KERAX FAB 33A==>S 2000==>2002
 PREMIUM TRACTEUR 4X2(FAB 22CC)
 PREMIUM(FAB22EE/HA/HB/JJ/QQ/RR)
 PREMIUM PR 4X2 (FAB 22AA/AB)
 KERAX (FAB 33AA/././SS)
 SISU
 PREMIUM 22C 071 ==> 1999



Sampa Nr.

080.053

O.E.M. Nr.

5010 269 380

Dimension

ø12xø40x41.5

Description

Cabin Mounting



Sampa Nr.

080.054

O.E.M. Nr.

5000 789 265

Dimension

ø12xø40x42

Description

Cabin Mounting



Sampa Nr.

080.554

O.E.M. Nr.

-

Dimension

ø12xø40x42

Description

Rep. Kit for Cabin

PREMIUM TR 4X2 ==>1999
 PREMIUM 6X2&6X2/4 ==>1999
 PREMIUM PR 4X2 ==> 1999
 KERAX ==> 1999
 PREMIUM 260 SP
 PREMIUM TR 4X2 2000 ==>
 PREMIUM(FAB22E/H/J/Q/R)2000==>
 PREMIUM PR 4X2 (FAB22A)2000==>
 KERAX FAB 33A==>S 2000==>2002
 PREMIUM TRACTEUR 4X2(FAB 22CC)
 PREMIUM(FAB22EE/HA/HB/JJ/QQ/RR)
 PREMIUM PR 4X2 (FAB 22AA/AB)
 KERAX (FAB 33AA/././SS)
 KERAX (FAB33A/./R) 2003==>
 SISU
 PREMIUM 22C 071 ==> 1999
 KERAX 33G ARMEE BANGLADESH
 KERAX 33K ARMEE BANGLADESH

*Sampa Nr.***080.109***O.E.M. Nr.***5010 228 902***Dimension*

ø28x111

Description

Cabin Bracket

PREMIUM TR 4X2 ==>1999
 PREMIUM 6X2&6X2/4 ==>1999
 PREMIUM PR 4X2 ==> 1999
 KERAX ==> 1999
 PREMIUM TR 4X2 2000 ==>
 PREMIUM(FAB22E/H/J/Q/R)2000==>
 PREMIUM PR 4X2 (FAB22A)2000==>
 KERAX FAB 33A==>S 2000==>2002
 PREMIUM TRACTEUR 4X2(FAB 22CC)
 PREMIUM(FAB22EE/HA/HB/JJ/QQ/RR)
 PREMIUM PR 4X2 (FAB 22AA/AB)
 KERAX (FAB 33AA.././SS)
 KERAX (FAB33A.././R) 2003==>
 SISU
 KERAX 33K ARMEE BANGLADESH

*Sampa Nr.***080.568***O.E.M. Nr.***5010 228 902 S***Dimension*

ø28

Description

Rep. Kit for Cabin

PREMIUM TR 4X2 ==>1999
 PREMIUM 6X2&6X2/4 ==>1999
 PREMIUM PR 4X2 ==> 1999
 PREMIUM TR 4X2 2000 ==>
 PREMIUM(FAB22E/H/J/Q/R)2000==>
 PREMIUM PR 4X2 (FAB22A)2000==>
 SISU

*Sampa Nr.***080.177***O.E.M. Nr.***5010 552 266***Dimension*

75x165x111

Description

Cabin Bracket

KERAX (FAB33A.././R) 2003==>
 PREMIUM DXI 11-FAB-27JC/TC
 PREMIUM DXI 11-FAB-27RC/SC

*Sampa Nr.***080.178***O.E.M. Nr.***5010 552 267***Dimension*

125x190x178

Description

Cabin Bracket

MAGNUM DXI 12-VAR-120AV

*Sampa Nr.***080.179***O.E.M. Nr.***5010 552 268***Dimension*

125x190x178

Description

Cabin Bracket

MAGNUM DXI 12-VAR-120AV

Cabin



Sampa Nr.

080.238

O.E.M. Nr.

5010 130 797
(5010 629 414)

Dimension

ø92x125

Description

Air Bellows for Cabin

PREMIUM TR 4X2==>1999
 PREMIUM 6X2&6X2/4 ==>1999
 PREMIUM PR 4X2==> 1999
 KERAX ==> 1999
 PREMIUM TR 4X2 2000 ==>
 PREMIUM(FAB22E/H/J/Q/R)2000—>
 PREMIUM PR 4X2 (FAB22A)2000==>
 KERAX FAB 33A==>S 2000==>2002
 PREMIUM TRACTEUR 4X2(FAB 22CC)
 PREMIUM(FAB22EE/HA/HB/JJ/QQ/RR
 PREMIUM PR 4X2 (FAB 22AA/AB)
 KERAX (FAB 33AA.././SS)
 KERAX (FAB33A.././R) 2003==>
 PREMIUM DX111 -FAB-27JC/TC
 PREMIUM DXI 11 -FAB-27RC/SC
 SISU
 PREMIUM 22C 071 ==> 1999



Sampa Nr.

080.239

O.E.M. Nr.

5010 092 916

Dimension

ø92x115

Description

Air Bellows for Cabin

G MANAGER 4X2
 G MANAGER 6X2 & 6X4
 G340TI TR 18T



Sampa Nr.

080.240

O.E.M. Nr.

5010 313 619
(5010 266 845)

Dimension

ø92x115

Description

Air Bellows for Cabin

G MANAGER 4X2
 G MANAGER 6X2 & 6X4
 G340TI TR 18T



Sampa Nr.

080.241

O.E.M. Nr.

5010 133 079

Dimension

ø92x93

Description

Air Bellows for Cabin

MAXTER 6X4 8X4
 G220/270 BOM
 G200/210/230TI
 G MANAGER 4X2
 G MANAGER 6X2 & 6X4
 G340TI 6X6
 G340TI 4X4
 MAXTER 4X2-4X4



Sampa Nr.

080.063

O.E.M. Nr.

5000 471 623

Dimension

M14/ø80x66

Description

Buffer for Cabin

GB131/HR15	JE13/15	"G" MANAGER 4X2"
GB/TB191/231	MIDLINER GRANDE-	G340TI 6X6
GC191/231	BRETAGNE	G340TI 4X4
GR191/231	MAXTER 6X4 8X4	MAXTER 4X2-4X4
GRH235/HF26	G230/270 SP	S135/150 (MOT 040226)
TF231D	G220/270 BOM	M210 4X4
GF151D	G200/210/230TI	

Sampa Nr.

080.245

O.E.M. Nr.

0000 707 526

Dimension

M10x46

Description

Buffer for Cabin

GR/TR280

Sampa Nr.

080.246

O.E.M. Nr.

0000 703 308

Dimension

ø16/ø25,5xø56x52

Description

Cabin Mounting

Sampa Nr.

080.247

O.E.M. Nr.

0000 707 650

Dimension

M8/70x80x16.5

Description

Buffer for Cabin

GR/TR280

Sampa Nr.

080.259

O.E.M. Nr.

-



Dimension

ø16x□90x54/70 ShA

Description

Cabin Mounting

Sampa Nr.

080.258

O.E.M. Nr.

5000 789 681

Dimension

ø16x□90x54/50 ShA

Description

Cabin Mounting

Stabilizer



Sampa Nr.

080.215

O.E.M. Nr.

5010 304 948

Dimension

ø42xø56x25

Description

Stabilizer Bushing

MAXTER 6X4 8X4
KERAX ==> 1999
KERAX FAB 33A==>S 2000==>2002
KERAX (FAB 33AA/././SS)
KERAX (FAB33A/././R) 2003==>
KERAX 33G ARMEE BANGLADESH
KERAX 33K ARMEE BANGLADESH



Sampa Nr.

080.581

O.E.M. Nr.

5010 304 948 S

Dimension

ø42xø56x25

Description

Stabilizer Bearing Kit

MAXTER 6X4 8X4
KERAX ==> 1999
KERAX FAB 33A==>S 2000==>2002
KERAX (FAB 33AA/././SS)
KERAX (FAB33A/././R) 2003==>
KERAX 33G ARMEE BANGLADESH
KERAX 33K ARMEE BANGLADESH



Sampa Nr.

010.039

O.E.M. Nr.

5010 304 950

Dimension

ø50.5xø86x63

Description

Stabilizer Plastic Bearing

MAXTER 6X4 8X4
KERAX ==> 1999
KERAX FAB 33A==>S 2000==>2002
KERAX (FAB 33AA/././SS)
KERAX (FAB33A/././R) 2003==>
KERAX 33G ARMEE BANGLADESH
KERAX 33K ARMEE BANGLADESH



Sampa Nr.

080.014

O.E.M. Nr.

5010 557 130
(5010 557 129)
(5000 434 716)

Dimension

ø20xø45x66

Description

Stabilizer Rubber Bushing

M140/160/200/230
MIDLINER GRANDE-BRETAGNE
ME/SE/CE/ 160/180/210
M/S 150/180/210/220/230TI/250
PS150/160
PA200/210
MIDLUM(FAB42B1/2-43C1/2-43T/V)

MIDLUM 42B3/4-44T/V/C.-45D/E.
MIDLUM 4X4 47XA/47XC
MIDLUM CCF 4X4 (FAB 47XF)
MACK MS200/250/300 1990—>
MACK CS200/250/300 1990—>
MIDLUM(FAB 42US-44US-45US)



Sampa Nr.

080.584

O.E.M. Nr.

5010 557 129 S

Dimension

ø20xø45x66

Description

Stabilizer Bearing Kit

M140/160/200/230
MIDLINER GRANDE-BRETAGNE
ME/SE/CE/160/180/210
M/S 150/180/210/220/230TI/250
PS150/160
PA200/210
MS300 SUDAMERICA
MIDLUM(FAB42B1 /2-43C1 /2-43T/V)
MIDLUM 42B3/4-44TMC.-45D/E.
MIDLUM 4X4 47XA/47XC
MIDLUM CCF 4X4 (FAB 47XF)

MACK MS200/250/300 1990—>
MACK CS200/250/300 1990—>
MIDLUM(FAB 42US-44US-45US)
JE13/15
S170 (FAB=SH)
J&S4X4->5/1991
S130/150TI/170 (VF6JP)
M/S 4X4 & INCENDIE
M210 4X4
MIDLUM(FAB42B1 /2-43C112-A31N)
MIDLUM EXPORT (FAB 43E1-43E2)



Sampa Nr.

080.585

O.E.M. Nr.

5010 557 130 S1
5010 557 129 S1
5000 434 716 S1

Dimension

ø20xø45x66

Description

Stabilizer Bearing Kit

M140/160/200/230
MIDLINER GRANDE-BRETAGNE
ME/SE/CE/160/180/210
M/S 150/180/210/220/230TI/250
PS150/160
PA200/210
MS300 SUDAMERICA
MIDLUM(FAB42B1 /2-43C1 /2-43T/V)
MIDLUM 42B3/4-44TMC.-45D/E.
MIDLUM 4X4 47XA/47XC
MIDLUM CCF 4X4 (FAB 47XF)

MACK MS200/250/300 1990—>
MACK CS200/250/300 1990—>
MIDLUM(FAB 42US-44US-45US)
JE13/15
S170 (FAB=SH)
J&S4X4->5/1991
S130/150TI/170 (VF6JP)
M/S 4X4 & INCENDIE
M210 4X4
MIDLUM(FAB42B1 /2-43C112-A31N)
MIDLUM EXPORT (FAB 43E1-43E2)

Sampa Nr.

080.003

O.E.M. Nr.

0000 790 899



Dimension

ø43xø61x32

Description

Stabilizer Bushing

Sampa Nr.

080.025

O.E.M. Nr.

0000 790 871



Dimension

ø20xø42x67

Description

Metal Bushing for Stabilizer

Sampa Nr.

080.532

O.E.M. Nr.

0000 790 899 S



Dimension

ø43xø61x32

Description

Stabilizer Bearing Kit

TR/GR305	C230/280/300/340TI/CCH300
TR/GR350	CBH/CLM 320/385
GR191/231	"R" 1993—>
GR/TR280	G220/270 BOM
R310 4X2 ->8/84	G200/210/230TI
R360 4X2	"G" MANAGER 4X2"
GLC/GLR190/230	"G" MANAGER 6X2 & 6X4"
G260/290	G340TI 4X4
C260/290	MAXTER 4X2-4X4
GLM/TLM280	KERAX ==> 1999
GLR230 4X4 SINPAR	KERAX FAB 33A==>S
C210/CLR220	2000==>2002
G210/230	KERAX (FAB 33AA/././SS)
R370 JSQ 1984	KERAX (FAB33A/././R) 2003==>
R370/390/420 —>1989	
R310/330/340/365 1984—>	
CBH/CLM280/340	
G320	
"R" 1990—>1992"	

Sampa Nr.

080.031

O.E.M. Nr.

5001 851 533 S



Dimension

ø14xø42x21

Description

Stabilizer Bushing

PREMIUM TR 4X2
PREMIUM 6X2&6X2/4
AE MAGNUM390/420TI/430/470/560
PREMIUM PR 4X2

Sampa Nr.

080.515

O.E.M. Nr.

5001 851 533



Dimension

ø14xø42x21

Description

Stabilizer Bearing Kit

PREMIUM TR 4X2
PREMIUM 6X2&6X2/4
AE MAGNUM390/420TI/430/470/560
PREMIUM PR 4X2

Sampa Nr.

080.214

O.E.M. Nr.

0000 487 790



Dimension

ø28x116

Description

Stabilizer Bolt

GB131/HR15	GLC/GLR190y230
GB/TB191/231	770KB6 SP
GC191/231	
TF231D	
GF151D	
PGC191/231	

Stabilizer



Sampa Nr.
080.001
O.E.M. Nr.
5000 279 225

Dimension
ø38xø58x74

Description
Stabilizer Plastic Bearing



Sampa Nr.
080.002
O.E.M. Nr.
5000 464 786

Dimension
ø49xø63.5x76

Description
Stabilizer Plastic Bearing



Sampa Nr.
080.530
O.E.M. Nr.
-

Dimension

Description
Stabilizer Bearing Kit



Sampa Nr.
080.531
O.E.M. Nr.
-

Dimension

Description
Stabilizer Bearing Kit

R310 4X2->8/84
R360 4X2
PJK/PJNPJP
JE13/15
G260/290
C260/290
JP11/13
JK55/60/65/75
JR/JX19/21
S170 (FAB-SH)
GLM/TLM280
J & S 4X4 ->5/1991
C210/CLR220
G210/230

S130/150TI (VF6JN)
S130/150TI/170 (VF6JP)
R370 JSQ 1984
R370/390/420 ->1989
R310/330/340/365 1984->
S110/130 (VF6JK)
S100
CBH/CLM280/340
G320
M140/160/200/230
MIDLINER GRANDE-BRETAGNE
"R" 1990->1992"
S140/160
C230/280/300/340TI/CCH300

MS 4X4 & INCENDIE
ME/SE/CE/160/180/210
CBH/CLM 320/385
MS 150/180/210/220/230TI/250
PS150/160
"R" 1993->"
S120/135
G220/270 BOM
G200/210/230TI
"G" MANAGER 4X2"
"G" MANAGER 6X2 & 6X4"
G340TI 4X4
MAXTER 4X2-4X4
MR.C

M210 4X4
KERAX => 1999
PA200/210
MS300 SUDAMERICA
MIDLUM(FAB42B1/2-43C1/2-43T/V)
KERAX(FAB33A//S) 2000 =>
MIDLUM 42B3/4-44T/V/C.-45D./E.
MIDLUM 4X4
KERAX (FAB 33AA//SS)
MACK MS200/250/300 1990->
MACK GS200/250/300 1990->
MIDLUM(FAB 42US-44US-45US)



Sampa Nr.
080.040
O.E.M. Nr.
5000 719 742

Dimension
ø29xø44.5x28.5

Description
Stabilizer Bushing

GB131/HR15
GB/TB191/231
GC191/231
PGC191/231
G260/290
G170
G210/230

G320
G230/270 SP
G200/210/230TI
"G" MANAGER 4X2"



Sampa Nr.
080.041
O.E.M. Nr.
5000 464 785

Dimension
ø54.5xø64x76

Description
Stabilizer Plastic Bearing

M140/160/200/230
M/S 150/180/210/220/230TI/250
PA200/210
MIDLUM(FAB42B1/2-43C1/2-43T/V)
MIDLUM 42B3/4-44T/V/C.-45D./E.
MIDLUM(FAB 42US-44US-45US)

Sampa Nr.

080.001

O.E.M. Nr.

5000 279 225



Dimension

ø38xø58x74

Description

Stabilizer Plastic Bearing

R310 4X2->8/84
R360 4X2
PJK/PJNPJP
JE13/15
G260/290
C260/290
JP11/13
JK55/60/65/75
JR/JX19/21
S170 (FAB=SH)
GLM/TLM280

J & S 4X4 ->5/1991
C210/CLR220
G210/230
S130/150TI (VF6JN)
S130/150TI/170 (VF6JP)
R370 JSQ 1984
R370/390/420 ->1989
R310/330/340/365 1984->
S110/130 (VF6JK)
S100
CBH/CLM280/340

Sampa Nr.

080.002

O.E.M. Nr.

5000 464 786



Dimension

ø49xø63.5x76

Description

Stabilizer Plastic Bearing

"R" 1993->
S120/135
G220/270 BOM
G200/210/230TI
"G" MANAGER 4X2"
"G" MANAGER 6X2 & 6X4"
G340TI 4X4
MAXTER 4X2-4X4
MRC
M210 4X4
KERAX => 1999

PA200/210
MS300 SUDAMERICA
MIDLUM (FAB42B1/2-43C1/2-43TA)
KERAX (FAB33A/././SS) 2000 =>
MIDLUM 42B3/4-44T/C.-45D/E.
MIDLUM 4X4
KERAX (FAB 33AA/././SS)
MACK MS200/250/300 1990->
MACK CS200/250/300 1990->
MIDLUM (FAB 42US-44US-45US)

Sampa Nr.

080.003

O.E.M. Nr.

0000 790 899



Dimension

ø43xø61x32

Description

Stabilizer Bushing

TR/GR305
TR/GR350
GR191/231
GR/VR280
R310 4X2 ->8/84
R360 4X2
GLC/GLR190/230

G260/290
C260/290
GLM/TLM280
GLR230 4X4 SINPAR
C210/CLR220
G210/230
R370 JSQ 1984

Sampa Nr.

080.025

O.E.M. Nr.

0000 790 871



Dimension

ø20xø42x67

Description

Metal Bushing for Stabilizer

"R" 1993->
G220/270 BOM
G200/210/230TI
"G" MANAGER 4X2"
"G" MANAGER 6X2 & 6X4"
G340TI 4X4
MAXTER 4X2-4X4

KERAX => 1999
KERAX FAB 33A=>S
2000=>2002
KERAX (FAB 33AA/././SS)
KERAX (FAB33A/././R) 2003=>

Sampa Nr.

080.528

O.E.M. Nr.

-



Dimension

Description

Stabilizer Bearing Kit

R310 4X2->8/84
R360 4X2
G260/290
C260/290
GLM/TLM280
C210/CLR220
G210/230

R370 JSQ 1984
R370/390/420 ->1989
R310/330/340/365 1984->
CBH/CLM280/340
G320
"R" 1990->1992"
C230/280/300/340TI/CCH300

Sampa Nr.

080.529

O.E.M. Nr.

-



Dimension

Description

Stabilizer Bearing Kit

CBH/CLM 320/385
"R" 1993->
G220/270 BOM
G200/210/230TI
"G" MANAGER 4X2"
"G" MANAGER 6X2 & 6X4"
G340TI 4X4

MAXTER 4X2-4X4
KERAX => 1999
KERAX (FAB33A/././S) 2000 =>
KERAX (FAB 33AA/././SS)
TYPES = R 310 - R 340 - R 357 - R 365 - R 385 - R 420

Stabilizer



Sampa Nr.

080.009

O.E.M. Nr.

0000 714 088

Dimension

ø25.5xø44.5x49.5

Description

Stabilizer Plastic Bearing

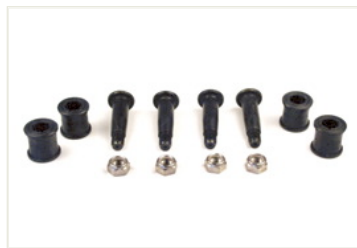

Sampa Nr.

080.534

O.E.M. Nr.

0000 714 088 S

Dimension

M20x1.5/101.5

Description

Stabilizer Bearing Kit

TR/GR305/350	R310/330/340/365 1984—>
GB131/HR15	CBH/CLM280/340
GB/TB191/231	AE380/385TI/420TI/500/520
GC191/231	""R"" 1990—>1992"
GR191/231	C230/280/300/340TI/CCH300
GRH235/HF26	MAXTER 6X4 8X4
GR/TR280	CBH/CLM 320/385
GRH/TRH305/350	""R"" 1993—>"
TF231D	G230/270 SP
GF151D	G220/270 BOM
R310/360 4X2 ->8/84	G200/210/230TI
PJK/PJN/PJP	""G"" MANAGER 4X2 & 6X2 & 6X4"
PGC191/231	G340TI 4X4
GLC/GLR190/230	MAXTER 4X2-4X4
R360 6X4 -> 10/1983	AE MAGNUM390/420TI/430/470/560
R310 6X4 JSQ 8/1984	KERAX ==> 1999
GLR230 4X4 SINPAR	PG230/280
C210/260/290 CLR220	KERAX FAB 33A==>S 2000==>2002
G170/210/230/260/290/320	KERAX (FAB 33AA/././SS)
S130/150TI (VF6JN)	KERAX (FAB33A/././R) 2003==>
R370 JSQ 1984	KERAX 33G/K ARMEE
R370/390/420 ->1989	

Sampa Nr.

080.535

O.E.M. Nr.

0000 714 088 S1

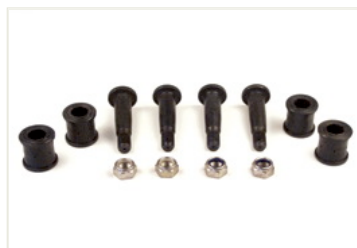

Dimension

M20x1.5/108.5

Description

Stabilizer Bearing Kit

TR/GR305	R310 4X2 ->8/84	R370/390/420 ->1989
TR/GR350	R360 4X2	R310/330/340/365 1984—>
GR/TR280	R360 6X4 -> 10/1983	"R" 1990—>1992"
GRH/TRH305	R310 6X4 JSQ 8/1984	"R" 1993—>"
GRH/TRH350	R370 JSQ 1984	



Sampa Nr.

080.156

O.E.M. Nr.

5010 130 023

Dimension

ø33.5xø67x60

Description

Stabilizer Bearing

C260/290	KERAX FAB 33A==>S
C210/CLR220	2000==>2002
CBH/CLM280/340	MIDLUM 42B3/4-44T/V/C.-45D./E.
C230/280/300/340TI/CCH300	KERAX (FAB 33AA/././SS)
MAXTER 6X4 8X4	KERAX (FAB33A/././R) 2003==>
CBH/CLM 320/385	MIDLUM(FAB 42US-44US-45US)
MAXTER 4X2-4X4	KERAX 33G ARMEE BANGLADESH
KERAX ==> 1999	KERAX 33K ARMEE BANGLADESH



Sampa Nr.

080.005

O.E.M. Nr.

5010 239 670

Dimension

ø42xø60.5x26

Description

Stabilizer Bushing

AE380/385TI/420TI/500/520	KERAX FAB 33A==>S 2000==>2002
PREMIUM TR 4X2 ==>1999	PREMIUM TRACTEUR 4X2(FAB 22CC)
PREMIUM 6X2&6X2/4 ==>1999	PREMIUM(FAB22EE/HA/HB/JJ/QQ/RR
AE MAGNUM390/420TI/430/470/560	PREMIUM PR 4X2 (FAB 22AA/AB)
PREMIUM PR 4X2 ==> 1999	KERAX (FAB 33AA/././SS)
KERAX ==> 1999	MAGNUM DXI 12 -VAR-120AV
MAGNUM E-TECH 400/440/480	PREMIUM DXI 11 -FAB-27JC/TC
PREMIUM TR 4X2 2000 ==>	PREMIUM DXI 11 -FAB-27RC/SC
PREMIUM(FAB22E/H/J/Q/R)2000==>	PREMIUM 22C 071 ==> 1999
PREMIUM PR 4X2 (FAB22A)2000==>	



Sampa Nr.

080.015

O.E.M. Nr.

5010 239 674

Dimension

ø20xø42x56.5

Description

Metal Bushing for Stabilizer

AE380/385TI/420TI/500/520	KERAX FAB 33A==>S 2000==>2002
PREMIUM TR 4X2 ==>1999	PREMIUM TRACTEUR 4X2(FAB 22CC)
PREMIUM 6X2&6X2/4 ==>1999	PREMIUM(FAB22EE/HA/HB/JJ/QQ/RR
AE MAGNUM390/420TI/430/470/560	PREMIUM PR 4X2 (FAB 22AA/AB)
PREMIUM PR 4X2 ==> 1999	KERAX (FAB 33AA/././SS)
KERAX ==> 1999	MAGNUM DXI 12 -VAR-120AV
MAGNUM E-TECH 400/440/480	PREMIUM DXI 11 -FAB-27JC/TC
PREMIUM TR 4X2 2000 ==>	PREMIUM DXI 11 -FAB-27RC/SC
PREMIUM(FAB22E/H/J/Q/R)2000==>	PREMIUM 22C 071 ==> 1999
PREMIUM PR 4X2 (FAB22A)2000==>	

Sampa Nr.

080.009

O.E.M. Nr.

0000 714 088



Dimension

ø25.5xø44.5x49.5

Description

Stabilizer Plastic Bearing

TR/GR305/350 GB131/HR15 GB/TB191/231 GC191/231 GR191/231 GRH235/HF26 GR/TR280 GRH/TRH305/350 TF231D GF151D R310/360 4X2 ->8/84 PJK/PJN/PJP PGC191/231 GLC/GLR190/230 R360 6X4 -> 10/1983 R310 6X4 JSQ 8/1984 GLR230 4X4 SINPAR C210/260/290 CLR220 G170/210/230/260/290/320 S130/150TI (VF6JN) R370 JSQ 1984 R370/390/420 ->1989 R310/330/340/365 1984-> CBH/CLM280/340	AE380/385TI/420TI/500/520 "R" 1990->1992" C230/280/300/340TI/CCH300 MAXTER 6X4 8X4 CBH/CLM 320/385 "R" 1993-> G230/270 SP G220/270 BOM G200/210/230TI "G" MANAGER 4X2 & 6X2 & 6X4" G340TI 4X4 MAXTER 4X2-4X4 AE MAGNUM390/420TI/430/470/560 KERAX ==> 1999 PG230/280 KERAX FAB 33A==>S 2000==>2002 KERAX (FAB 33AA/././SS) KERAX (FAB33A/././R) 2003==> KERAX 33G/K ARMEE
--	---

Sampa Nr.

080.026

O.E.M. Nr.

0000 716 243



Dimension

ø38x32

Description

Stabilizer Plastic Bearing

TR/GR305 TR/GR350 GR/TR280 GRH/TRH305 GRH/TRH350 R310 4X2 ->8/84 R360 4X2 R360 6X4 -> 10/1983 R310 6X4 JSQ 8/1984 R370 JSQ 1984 R370/390/420 ->1989 R310/330/340/365 1984-> "R" 1990->1992" "R" 1993->

Sampa Nr.

080.521

O.E.M. Nr.

-



Dimension

M20x1.5/101.5

Description

Stabilizer Bearing Kit

TR/GR305 TR/GR350 GR/TR280	GRH/TRH305 GRH/TRH350 R310 4X2 ->8/84	R360 4X2 R360 6X4 -> 10/1983 R310 6X4 JSQ 8/1984
----------------------------------	---	--

Sampa Nr.

080.522

O.E.M. Nr.

-



Dimension

M20x1.5/108.5

Description

Stabilizer Bearing Kit

R370 JSQ 1984 R370/390/420 ->1989 R310/330/340/365 1984->	"R" 1990->1992" "R" 1993->
---	-------------------------------

Sampa Nr.

080.525

O.E.M. Nr.

-

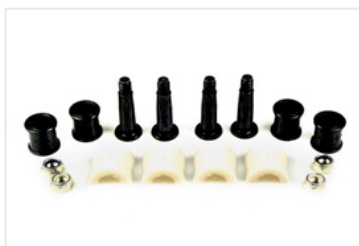

Dimension

M20x1.5/101.5

Description

Stabilizer Bearing Kit

TR/GR305 TR/GR350 GR/TR280	GRH/TRH305 GRH/TRH350 R310 4X2 ->8/84	R360 4X2 R360 6X4 -> 10/1983 R310 6X4 JSQ 8/1984
----------------------------------	---	--

Sampa Nr.

080.526

O.E.M. Nr.

-



Dimension

M20x1.5/108.5

Description

Stabilizer Bearing Kit

R370 JSQ 1984 R370/390/420 ->1989 R310/330/340/365 1984->	"R" 1990->1992" "R" 1993->
---	-------------------------------

Stabilizer



Sampa Nr.

080.009

O.E.M. Nr.

0000 714 088

Dimension

ø25.5xø44.5x49.5

Description

Stabilizer Plastic Bearing

TR/GR305/350
GB131/HR15
GB/TR191/231
GC191/231
GR191/231
GRH235/HF26
GR/TR280
GRH/TRH305/350
TF231D
GF151D
R310/360 4X2 ->8/84
PJK/PJN/PJP
PGC191/231
GLC/GLR190/230
R360 6X4 -> 10/1983
R310 6X4 JSQ 8/1984
GLR230 4X4 SINPAR
C210/260/290 CLR220
G170/210/230/260/290/320
S130/150TI (VF6JN)
R370 JSQ 1984
R370/390/420 ->1989

R310/330/340/365 1984->
CBH/CLM280/340
AE380/385TI/420TI/500/520
"R" 1990->1992"
C230/280/300/340TI/CCH300
MAXTER 6X4 8X4
CBH/CLM 320/385
"R" 1993->
G230/270 SP
G220/270 BOM
G200/210/230TI
"G" MANAGER 4X2 & 6X2 & 6X4"
G340TI 4X4
MAXTER 4X2-4X4
AE MAGNUM390/420TI/430/470/560
KERAX ==> 1999
PG230/280
KERAX FAB 33A==>S 2000==>2002
KERAX (FAB 33AA/././SS)
KERAX (FAB33A/././R) 2003==>
KERAX 33G/K ARMEE



Sampa Nr.

080.027

O.E.M. Nr.

0000 716 242

Dimension

ø41x32

Description

Stabilizer Plastic Bearing

TR/GR305
TR/GR350
GR/TR280
GRH/TRH305
GRH/TRH350
R310 4X2 ->8/84
R360 4X2
R360 6X4 -> 10/1983
R310 6X4 JSQ 8/1984
R370 JSQ 1984
R370/390/420 ->1989
R310/330/340/365 1984->
"R" 1990->1992"
"R" 1993->"



Sampa Nr.

080.519

O.E.M. Nr.

-

Dimension

M20x1.5x101.5

Description

Stabilizer Bearing Kit

TR/GR305
TR/GR350
GRH/TRH305

GRH/TRH350
R310 4X2 ->8/84
R360 4X2

R360 6X4 -> 10/1983
R310 6X4 JSQ 8/1984
R370 JSQ 1984

R370/390/420 ->1989
R310/330/340/365 1984->
"R" 1990->1992"

Sampa Nr.

080.520

O.E.M. Nr.

-

Dimension

M20x1.5/108.5

Description

Stabilizer Bearing Kit



Sampa Nr.

080.028

O.E.M. Nr.

0000 714 814

Dimension

ø34x37

Description

Stabilizer Plastic Bearing

GC191/231
GR191/231
GRH235/HF26
TF231D
GF151D

PGC191/231
GLC/GLR190/230
G260/290
C260/290
GLR230 4X4 SINPAR

C210/CLR220
G170
G210/230
G320
C230/280/300/340TI/CCH300

G230/270 SP
G220/270 BOM
G200/210/230TI
"G" MANAGER 4X2"
"G" MANAGER 6X2 & 6X4"

Sampa Nr.

080.524

O.E.M. Nr.

-

Dimension

M20x1.5/101.5

Description

Stabilizer Bearing Kit



Sampa Nr.

080.009

O.E.M. Nr.

0000 714 088



Dimension

ø25.5xø44.5x49.5

Description

Stabilizer Plastic Bearing

TR/GR305/350	R310/330/340/365 1984—>
GB131/HR15	CBH/CLM280/340
GB/TB191/231	AE380/385TI/420TI/500/520
GC191/231	"R" 1990—>1992"
GR191/231	C230/280/300/340TI/CCH300
GRH235/HF26	MAXTER 6X4 8X4
GR/TR280	CBH/CLM 320/385
GRH/TRH305/350	"R" 1993—>"
TF231D	G230/270 SP
GF151D	G220/270 BOM
R310/360 4X2 ->8/84	G200/210/230TI
PJK/PJN/PJP	"G" MANAGER 4X2 & 6X2 & 6X4"
PGC191/231	G340TI 4X4
GLC/GLR190/230	MAXTER 4X2-4X4
R360 6X4 —> 10/1983	AE MAGNUM390/420TI/430/470/560
R310 6X4 JSQ 8/1984	KERAX ==> 1999
GLR230 4X4 SINPAR	PG230/280
C210/260/290 CLR220	KERAX FAB 33A==>S 2000==>2002
G170/210/230/260/290/320	KERAX (FAB 33AA.././SS)
S130/150TI (VF6JN)	KERAX (FAB33A.././R) 2003==>
R370 JSQ 1984	KERAX 33G/K ARMEE
R370/390/420 —>1989	

Sampa Nr.

080.030

O.E.M. Nr.

0000 482 176



Dimension

M8/ø18x88

Description

Stabilizer Bracket

GB131/HR15	G210/230
GB/TB191/231	770KB6 SP
GC191/231	G320
GR191/231	C230/280/300/340TI/CCH300
GRH235/HF26	G230/270 SP
TF231D	G220/270 BOM
GF151D	G200/210/230TI
PGC191/231	"G" MANAGER 4X2"
GLC/GLR190/230	"G" MANAGER 6X2 & 6X4"
G260/290	G340TI 4X4
C260/290	PG230/280
GLR230 4X4 SINPAR	
C210/CLR220	
G170	

Sampa Nr.

080.028

O.E.M. Nr.

0000 714 814



Dimension

ø34x37

Description

Stabilizer Plastic Bearing

GC191/231	G210/230
GR191/231	G320
GRH235/HF26	C230/280/300/340TI/CCH300
TF231D	G230/270 SP
GF151D	G220/270 BOM
PGC191/231	G200/210/230TI
GLC/GLR190/230	"G" MANAGER 4X2"
G260/290	"G" MANAGER 6X2 & 6X4"
C260/290	G340TI 4X4
GLR230 4X4 SINPAR	PG230/280
C210/CLR220	GB131/HR15
G170	GB/TB191/231

Sampa Nr.

080.029

O.E.M. Nr.

5010 268 225



Dimension

M18/ø21x112.5

Description

Stabilizer Bracket

Sampa Nr.

080.523

O.E.M. Nr.

-



Dimension

M20x1.5/101.5

Description

Stabilizer Bearing Kit

GC191/231	G210/230
GR191/231	G320
GRH235/HF26	C230/280/300/340TI/CCH300
TF231D	G230/270 SP
GF151D	G220/270 BOM
PGC191/231	G200/210/230TI
GLC/GLR190/230	"G" MANAGER 4X2"
G260/290	"G" MANAGER 6X2 & 6X4"
C260/290	G340TI 4X4
C210/CLR220	PG230/280
G170	

Stabilizer



Sampa Nr.

080.008

O.E.M. Nr.

5010 060 356

Dimension

ø52xø90x74

Description

Stabilizer Bearing

AE380/385TI/420TI/500/520
G340TI TR 18T
PREMIUM TR 4X2 ==>1999
PREMIUM 6X2&6X2/4 ==>1999
AE MAGNUM390/420TI/430/470/560
PREMIUM PR 4X2 ==> 1999
KERAX ==> 1999
PREMIUM 260 SP
PG230/280
MAGNUM E-TECH 400/440/480
PREMIUM TR 4X2 2000 ==>
PREMIUM(FAB22E/H/J/Q/R)2000==>

PREMIUM PR 4X2 (FAB22A)2000==>
KERAX FAB 33A==>S 2000==>2002
PREMIUM TRACTEUR 4X2(FAB 22CC)
PREMIUM(FAB22EE/HA/HB/JJ/QQ/RR
PREMIUM PR 4X2 (FAB 22AA/AB)
KERAX (FAB 33AA../J/SS)
MAGNUM DXI 12 -VAR-120AV
PREMIUM DXI 11 -FAB-27JC/TC
PREMIUM DXI 11 -FAB-27RC/SC
PREMIUM 22C 071 ==> 1999



Sampa Nr.

080.012

O.E.M. Nr.

5010 066 936

Dimension

ø41x38

Description

Stabilizer Plastic Bearing

AE380/385TI/420TI/500/520
G340TI TR 18T
PREMIUM TR 4X2 ==>1999
AE MAGNUM390/420TI/430/470/560
PREMIUM PR 4X2 ==> 1999
PREMIUM 260 SP
PG230/280
PREMIUM TR 4X2 2000 ==>
PREMIUM PR 4X2 (FAB22A)2000==>
PREMIUM TRACTEUR 4X2(FAB 22CC)
PREMIUM PR 4X2 (FAB 22AA/AB)
PREMIUM 22C 071 ==> 1999



Sampa Nr.

080.013

O.E.M. Nr.

5010 066 937

Dimension

ø53xø76x76

Description

Stabilizer Plastic Bearing

AE380/385TI/420TI/500/520
G340TI TR 18T
PREMIUM TR 4X2 ==>1999
AE MAGNUM390/420TI/430/470/560
PREMIUM PR 4X2 ==> 1999

PREMIUM 260 SP
PG230/280
PREMIUM TR 4X2 2000 ==>
PREMIUM PR 4X2 (FAB22A)2000==>
PREMIUM TRACTEUR 4X2(FAB 22CC)



Sampa Nr.

080.527

O.E.M. Nr.

-

Dimension

Description

Stabilizer Bearing Kit

PREMIUM PR 4X2 (FAB 22AA/AB)
PREMIUM 22C 071 ==> 1999



Sampa Nr.

080.115

O.E.M. Nr.

5000 391 730

Dimension

ø30x65

Description

Stabilizer Bearing

B70
B90
B80/110/120



Sampa Nr.

080.121

O.E.M. Nr.

5000 396 856

Dimension

ø32xø47.5x80

Description

Stabilizer Bearing

B70
B90
B80/110/120
MASCOTT

Sampa Nr.

080.034

O.E.M. Nr.

5516 010 769



Dimension

ø18xø34x54

Description

Stabilizer Rubber Bushing

PJK/PJN/PJP	S140/160
JE13/15	B80/110/120
JN55/60/85	M/S 4X4 & INCENDIE
JP11/13	ME/SE/CE/ 160/180/210
JK55/60/65/75	M/S 150/180/210/220/230TI/250
JR/JX19/21	PS150/160
S170 (FAB=SH)	S120/135
S130/150TI (VF6JN)	S135/150 (MOT 040226)
S130/150TI/170 (VF6JP)	M210 4X4
S110/130 (VF6JK)	MIDLUM 4X4 47XA/47XC
B90	MIDLUM CCF 4X4 (FAB 47XF)
S100	MACK MS200/250/300 1990—>
M140/160/200/230	MASCOTT
MIDLINER GRANDE-BRETAGNE	

Sampa Nr.

080.036

O.E.M. Nr.

5000 352 492



Dimension

ø39.5xø53.5x80

Description

Stabilizer Plastic Bearing

PJK/PJN/PJP	M140/160/200/230
JE13/15	MIDLINER GRANDE-BRETAGNE
JN55/60/85	S140/160
JP11/13	M/S 4X4 & INCENDIE
JR/JX19/21	M/S 150/180/210/220/230TI/250
S170 (FAB=SH)	PS150/160
S130/150TI (VF6JN)	S120/135
S130/150TI/170 (VF6JP)	MACK MS200/250/300 1990—>
S100	

Sampa Nr.

080.047

O.E.M. Nr.

5516 031 135



Dimension

ø40x66

Description

Stabilizer Bearing

PJK/PJN/PJP	MIDLINER GRANDE-BRETAGNE
JN55/60/85	S140/160
JP11/13	M/S 150/180/210/220/230TI/250
JR/JX19/21	PS150/160
S130/150TI (VF6JN)	S120/135
S110/130 (VF6JK)	S135/150 (MOT 040226)
S100	

Sampa Nr.

080.044

O.E.M. Nr.

5010 557 313



Dimension

ø50xø64.5x76.5

Description

Stabilizer Plastic Bearing

R310/360 4X2 ->8/84	ME/SE/CE/ 160/180/210
PJK/PJN/PJP	CBH/CLM 320/385
JE13/15	M/S 150/180/210/220/230TI/250
G210/220/230/260/290/320/270 BOM	PS150/160
C260/290 / C210/CLR220	"R" 1993—>
JP11/13	G200/210/230TI
JK55/60/65/75	"G" MANAGER 4X2 & 6X2 & 6X4"
JR/JX19/21	G340TI 4X4
S170 (FAB=SH)	MAXTER 4X2-4X4
GLM/TLM280	M210 4X4
J & S 4X4 —>5/1991	KERAX —> 1999
S130/150TI (VF6JN)/170 (VF6JP)	PA200/210
R370 JSQ 1984	MIDLUM(FAB42B1/2-43C1/2-43T/V)
R370/390/420 —>1989	KERAX FAB 33A—>S 2000—>2002
R310/330/340/365 1984—>	MIDLUM 42B3/4-44T/V/C.-45D./E.
S110/130 (VF6JK)	MIDLUM 4X4 47XA/47XC
S100/120/135/140/160	KERAX (FAB 33AA/././SS)
CBH/CLM280/340	KERAX (FAB33A/././R) 2003—>
M140/160/200/230	MIDLUM CCF 4X4 (FAB 47XF)
MIDLINER GRANDE-BRETAGNE	MACK MS200/250/300 1990—>
"R" 1990—>1992"	MACK CS200/250/300 1990—>
C230/280/300/340TI/CCH300	MIDLUM(FAB 42US-44US-45US)

Sampa Nr.

080.035

O.E.M. Nr.

5516 031 136



Dimension

ø34x59

Description

Stabilizer Bearing

PJK/PJN/PJP	B90	B80/110/120
JK55/60/65/75	S100	S120/135
S110/130 (VF6JK)	S140/160	

Sampa Nr.

080.118

O.E.M. Nr.

5010 215 010



Dimension

ø35.5x66

Description

Stabilizer Bearing

S140/160	S135/150 (MOT 040226)
B80/110/120	MASCOTT
S120/135	

Stabilizer



Sampa Nr.

080.006

O.E.M. Nr.

5010 294 991

Dimension

ø30xø42x19

Description

Stabilizer Bushing

G340TI TR 18T AE MAGNUM390/420TI/430/470/560
 PREMIUM TR 4X2 ==>1999 PREMIUM PR 4X2 ==> 1999
 PREMIUM 6X2&6X2/4 ==>1999 PREMIUM 260 SP



Sampa Nr.

080.007

O.E.M. Nr.

5010 130 021

Dimension

ø38xø67x60

Description

Stabilizer Bearing

AE380/385TI/420TI/500/520
 "R" 1993—>"
 G340TI TR 18T
 PREMIUM TR 4X2 ==>1999
 PREMIUM 6X2&6X2/4 ==>1999
 AE MAGNUM390/420TI/430/470/560
 PREMIUM PR 4X2 ==> 1999
 PREMIUM 260 SP
 PREMIUM TR 4X2 2000 ==>
 PREMIUM(FAB22E/H/J/Q/R)2000==>
 PREMIUM PR 4X2 (FAB22A)2000==>
 PREMIUM TRACTEUR 4X2(FAB 22CC)
 PREMIUM(FAB22EE/HA/HB/JJ/QQ/RR
 PREMIUM PR 4X2 (FAB 22AA/AB)
 PREMIUM DXI 11 -FAB-27JC/TC
 PREMIUM 22C 071 ==> 1999



Sampa Nr.

080.010

O.E.M. Nr.

5010 130 022

Dimension

ø41xø67x60

Description

Stabilizer Bearing

AE380/385TI/420TI/500/520
 "R" 1993—>"
 PREMIUM TR 4X2 ==>1999
 PREMIUM 6X2&6X2/4 ==>1999
 AE MAGNUM390/420TI/430/470/560
 PREMIUM PR 4X2 ==> 1999
 MAGNUM E-TECH 400/440/480
 PREMIUM TR 4X2 2000 ==>
 PREMIUM(FAB22E/H/J/Q/R)2000==>
 PREMIUM PR 4X2 (FAB22A)2000==>
 MIDLUM 42B3/4-44TA/C.-45D./E.
 PREMIUM(FAB22EE/HA/HB/JJ/QQ/RR
 PREMIUM PR 4X2 (FAB 22AA/AB)
 MAGNUM DXI 12 -VAR-120AV
 MIDLUM(FAB 42US-44US-45US)
 PREMIUM DXI 11 -FAB-27JC/TC
 PREMIUM 22C 071 ==> 1999



Sampa Nr.

080.042

O.E.M. Nr.

5010 383 545

Dimension

ø20xø51.5x41

Description

Stabilizer Rubber Bushing

PREMIUM TR 4X2 ==>1999
 PREMIUM 6X2&6X2/4 ==>1999
 AE MAGNUM390/420TI/430/470/560
 PREMIUM PR 4X2 ==> 1999
 PREMIUM 260 SP
 MAGNUM E-TECH 400/440/480
 PREMIUM TR 4X2 2000 ==>
 PREMIUM(FAB22E/H/J/Q/R)2000==>
 PREMIUM PR 4X2 (FAB22A)2000==>
 MIDLUM 42B3/4-44TA/C.-45D./E.
 PREMIUM TRACTEUR 4X2(FAB 22CC)
 PREMIUM(FAB22EE/HA/HB/JJ/QQ/RR
 PREMIUM PR 4X2 (FAB 22AA/AB)
 MAGNUM DXI 12 -VAR-120AV
 MIDLUM(FAB 42US-44US-45US)
 PREMIUM DXI 11 -FAB-27JC/TC
 PREMIUM DXI 11 -FAB-27RC/SC
 PREMIUM 22C 071 ==> 1999



Sampa Nr.

080.011

O.E.M. Nr.

5010 239 135

Dimension

ø20xø30x41

Description

Metal Bushing for Stabilizer

G340TI TR 18T PREMIUM PR 4X2 ==> 1999
 PREMIUM TR 4X2 ==>1999 PA200/210
 PREMIUM 6X2&6X2/4 ==>1999 PREMIUM 260 SP
 AE MAGNUM390/420TI/430/470/560

Sampa Nr.	
080.045	
O.E.M. Nr.	
5010 557 314	
Dimension	$\varnothing 38 \times \varnothing 64.5 \times 76.5$
Description	Stabilizer Plastic Bearing
MIDLUM(FAB42B1/2-43C1/2-43T/V) MIDLUM EXPORT (FAB 43E1-43E2) MIDLUM 42B3/4-44T/V/C.-45D./E. MIDLUM(FAB 42US-44US-45US)	

Sampa Nr.	
080.096	
O.E.M. Nr.	
0000 707 791	
Dimension	$\varnothing 42.5 \times \varnothing 56 \times 69$
Description	Stabilizer Plastic Bearing
TR/GR305 C260/290 TR/GR350 GLR230 4X4 SINPAR GR191/231 C210/CLR220 GR/TR280 R310 4X2 -->8/84 R360 4X2 GLC/GLR190/230	

Sampa Nr.	
080.046	
O.E.M. Nr.	
5010 557 315	
Dimension	$\varnothing 38.5 \times \varnothing 58.5 \times 73$
Description	Stabilizer Plastic Bearing
R310 4X2 -->8/84 M/S 4X4 & INCENDIE R360 4X2 ME/SE/CE/ 160/180/210 PJK/PJN/PJP CBH/CLM 320/385 JE13/15 M/S 150/180/210/220/230TI/250 G260/290 PS150/160 C260/290 "R" 1993--> JP11/13 G230/270 SP JK55/60/65/75 S120/135 JR/JX19/21 G220/270 BOM S170 (FAB=SH) G200/210/230TI GLM/TLM280 "G" MANAGER 4X2" J & S 4X4 -->5/1991 "G" MANAGER 6X2 & 6X4" C210/CLR220 G340TI 4X4 G170 MAXTER 4X2-4X4 G210/230 M210 4X4 S130/150TI (VF6JN) KERAX ==> 1999 S130/150TI/170 (VF6JP) PA200/210 R370 JSQ 1984 MS300 SUDAMERICA R370/390/420 -->1989 MIDLUM(FAB42B1/2-43C1/2-43T/V) R310/330/340/365 1984--> MIDLUM EXPORT (FAB 43E1-43E2) S110/130 (VF6JK) KERAX FAB 33A==>S 2000==>2002 S100 MIDLUM 42B3/4-44TA/V/C.-45D./E. CBH/CLM280/340 MIDLUM 4X4 47XA/47XC G320 KERAX (FAB 33AA././SS) M140/160/200/230 KERAX (FAB33A././R) 2003==> MIDLINER GRANDE-BRETAGNE MIDLUM CCF 4X4 (FAB 47XF) "R" 1990-->1992" MACK MS200/250/300 1990--> S140/160 MACK CS200/250/300 1990--> C230/280/300/340TI/CCH300 MIDLUM(FAB 42US-44US-45US)	

Sampa Nr.	
080.097	
O.E.M. Nr.	
0000 707 792	
Dimension	$\varnothing 50 \times 42.5$
Description	Stabilizer Plastic Bearing
TR/GR305 C260/290 TR/GR350 GLR230 4X4 SINPAR GR191/231 C210/CLR220 GR/TR280 R310 4X2 -->8/84 R360 4X2 GLC/GLR190/230	

Sampa Nr.	
080.117	
O.E.M. Nr.	
5010 557 312	
Dimension	$\varnothing 55 \times \varnothing 64.5 \times 76.5$
Description	Stabilizer Plastic Bearing
M140/160/200/230 M/S 150/180/210/220/230TI/250 PA200/210 MIDLUM(FAB42B1/2-43C1/2-43T/V) MIDLUM 42B3/4-44T/V/C.-45D./E. MIDLUM(FAB 42US-44US-45US)	

Stabilizer



Sampa Nr.

080.048

O.E.M. Nr.

5010 373 300

Dimension

ø34xø65x100

Description

Stabilizer Mounting

M/S 150/180/210/220/230TI/250
S135/150 (MOT 040226)
MIDLUM(FAB42B1/2-43C1/2-43T/V)
MIDLUM 42B3/4-44T/V/C.-45D./E.
MIDLUM(FAB 42US-44US-45US)



Sampa Nr.

080.049

O.E.M. Nr.

5010 238 596

Dimension

ø32xø65x100

Description

Stabilizer Mounting

M/S 150/180/210/220/230TI/250
S135/150 (MOT 040226)
MIDLUM(FAB42B1/2-43C1/2-43T/V)



Sampa Nr.

080.110

O.E.M. Nr.

5000 452 655

Dimension

ø35xø68.5x109.5

Description

Stabilizer Mounting

M140/160/200/230
MIDLINER GRANDE-BRETAGNE
M/S 150/180/210/220/230TI/250
PA200/210
MIDLUM(FAB42B1/2-43C1/2-43T/V)



Sampa Nr.

080.113

O.E.M. Nr.

5430 041 078

Dimension

ø41xø68.5x109.5

Description

Stabilizer Mounting

MIDLINER GRANDE-BRETAGNE
M/S 150/180/210/220/230TI/250
MIDLUM(FAB42B1/2-43C1/2-43T/V)
MIDLUM EXPORT (FAB 43E1-43E2)
MIDLUM 42B3/4-44T/V/C.-45D./E.
MIDLUM(FAB 42US-44US-45US)



Sampa Nr.

080.242

O.E.M. Nr.

0000 754 160

Dimension

ø30xø45.5x31

Description

Stabilizer Bushing

TF231D
GLC/GLR190/230

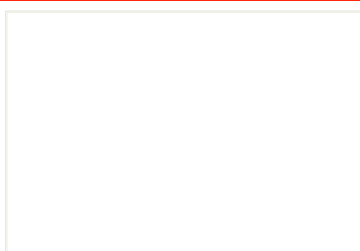

Sampa Nr.

O.E.M. Nr.

Dimension

Description

Sampa Nr.

080.101

O.E.M. Nr.

5000 716 656



Dimension

ø25xø50x24.5

Description

Brake Shoe Roller

Sampa Nr.

080.104

O.E.M. Nr.

5000 716 600



Dimension

ø25x63

Description

Brake Shoe Pin

Sampa Nr.

080.563

O.E.M. Nr.

-



Dimension

ø25

Description

Rep. Kit for Brake Shoe

G260/290/320	PREMIUM TR 4X2 ==>1999
C260/290	PREMIUM 6X2&6X2/4 ==>1999
C210/CLR220	MAXTER 4X2-4X4
G170	AE MAGNUM390/420TI/430/470/560
G210/230	PREMIUM PR 4X2 ==> 1999
R370/390/420 -->1989	M210 4X4
R310/330/340/365 1984-->	KERAX ==> 1999
CBH/CLM280/340	PREMIUM 260 SP
M140/160/200/230	PG230/280
AE380/385TI/420TI/500/520	MAGNUM E-TECH 400/440/480
MIDLINER GRANDE-BRETAGNE	PREMIUM TR 4X2 2000 ==>
"R" 1990 -->1992"	PREMIUM(FAB22E/H/J/Q/R)2000==>
C230/280/300/340TI/CCH300	PREMIUM PR 4X2 (FAB22A)2000==>
M/S 4X4 & INCENDIE	KERAX FAB 33A==>S 2000==>2002
ME/SE/CE/ 160/180/210	PREMIUM TRACTEUR 4X2(FAB 22CC)
MAXTER 6X4 8X4	PREMIUM(FAB22EE/HA/HB/JJ/QQ/RR
CBH/CLM 320/385	PREMIUM PR 4X2 (FAB 22AA/AB)
M/S 150/180/210/220/230TI/250	KERAX (FAB 33AA.././SS)
"R" 1993-->"	KERAX (FAB33A.././R) 2003==>
G230/270 SP	SISU
G220/270 BOM	PREMIUM 22C 071 ==> 1999
G200/210/230TI	KERAX 33G ARMEE BANGLADESH
"G" MANAGER 4X2" & 6X2 & 6X4"	KERAX 33K ARMEE BANGLADESH
G340TI 6X6 4X4	PUNCHER
G340TI TR 18T	

Sampa Nr.

080.102

O.E.M. Nr.

0000 189 976



Dimension

ø25xø60x20

Description

Brake Shoe Roller

Sampa Nr.

080.107

O.E.M. Nr.

0000 192 399



Dimension

ø25x75

Description

Brake Shoe Pin

Sampa Nr.

080.566

O.E.M. Nr.

5000 716 008



Dimension

ø25

Description

Rep. Kit for Brake Shoe

TR/GR305	GLR230 4X4 SINPAR
TR/GR350	C210/CLR220
GR191/231	G170
GRH235/HF26	G210/230
GR/TR280	R370 JSQ 1984
GRH/TRH305	CBH/CLM280/340
GRH/TRH350	G230/270 SP
TF231D	
R310 4X2 -->8/84	
R360 4X2	
GBH/TBH280 1981-->	
GBH260/280 6X6	
GBH260/280 6X4 -->1980	
GLC/GLR190/230	
G260/290	
C260/290	
R360 6X4 --> 10/1983	
R310 6X4 JSQ 8/1984	
GLM/TLM280	

Brake



Sampa Nr.

080.105

O.E.M. Nr.

5000 737 308

Dimension

ø30x110.5

Description

Brake Shoe Pin

G260/290
C260/290
C210/CLR220
G170

G210/230
R370/390/420 →1989
R310/330/340/365 1984→
G230/270 SP



Sampa Nr.

080.126

O.E.M. Nr.

5010 067 400

Dimension

ø19.5xø30x104

Description

Brake Shoe Pin



Sampa Nr.

080.127

O.E.M. Nr.

5010 216 613

Dimension

ø30xø33x45

Description

Brake Shoe Bushing



Sampa Nr.

080.137

O.E.M. Nr.

5000 786 674

Dimension

ø30xø33x20

Description

Brake Shoe Bushing

TR/GR305
TR/GR350
GR191/231
GRH235/HF26
GR/TR280
GRH/TRH305
GRH/TRH350
TF231D
R310 4X2 →8/84
R360 4X2
GBH/TBH280 1981→
GBH260/280 6X6
GBH260/280 6X4 →1980
GLC/GLR190/230

G260/290
C260/290
R360 6X4 → 10/1983
R310 6X4 JSQ 8/1984
GLM/TLM280
GLR230 4X4 SINPAR
C210/CLR220
G170
G210/230
R370 JSQ 1984
R370/390/420 →1989
R310/330/340/365 1984→
CBH/CLM280/340
G230/270 SP



Sampa Nr.

080.545

O.E.M. Nr.

Dimension

ø30

Description

Rep. Kit for Brake Shoe



Sampa Nr.

080.571

O.E.M. Nr.

Dimension

ø30

Description

Rep. Kit for Brake Shoe

G260/290
C260/290
C210/CLR220
G170

G210/230
R370/390/420 →1989
R310/330/340/365 1984→
G230/270 SP

G170/210/230/260/290/320
C260/290
C210/CLR220
R370/390/420 →1989
R310/330/340/365 1984→
CBH/CLM280/340
M140/160/200/230
AE380/385TI/420TI/500/520
MIDLINER GRANDE-BRETAGNE
"R" 1990→1992"
C230/280/300/340TI/CCH300
M/S 4X4 & INCENDIE
ME/SE/CE/ 160/180/210
MAXTER 6X4 8X4
CBH/CLM 320/385
M/S 150/180/210/220/230TI/250
"R" 1993→"
G230/270 SP
G220/270 BOM
G200/210/230TI
"G" MANAGER 4X2"
"G" MANAGER 6X2 & 6X4"
G340TI 6X6 4X4
G340TI TR 18T

PREMIUM TR 4X2 →1999
PREMIUM 6X2&6X2/4 →1999
MAXTER 4X2-4X4
AE MAGNUM390/420TI/430/470/560
PREMIUM PR 4X2 → 1999
M210 4X4
KERAX → 1999
PREMIUM 260 SP
PG230/280
MAGNUM E-TECH 400/440/480
PREMIUM TR 4X2 2000 →
PREMIUM(FAB22E/H/J/Q/R)2000→
PREMIUM PR 4X2 (FAB22A)2000→
KERAX FAB 33A→S 2000→2002
PREMIUM TRACTEUR 4X2(FAB 22CC)
PREMIUM(FAB22EE/HA/HB/JJ/QQ/RR
PREMIUM PR 4X2 (FAB 22AA/AB)
KERAX (FAB 33AA/././SS)
KERAX (FAB33A/././R) 2003→
SISU
PREMIUM 22C 071 → 1999
KERAX 33G ARMEE BANGLADESH
KERAX 33K ARMEE BANGLADESH
PUNCHER

Sampa Nr.
080.126

O.E.M. Nr.
5010 067 400



Dimension
ø19.5xø30x104

Description
Brake Shoe Pin

Sampa Nr.
080.127

O.E.M. Nr.
5010 216 613



Dimension
ø30xø33x45

Description
Brake Shoe Bushing

Sampa Nr.
080.128

O.E.M. Nr.
5000 785 979



Dimension
ø45xø48x29.5

Description
Brake Camshaft Bushing

Sampa Nr.
080.546

O.E.M. Nr.
-



Dimension
ø30

Description
Rep. Kit for Brake Shoe

TR/GR305/350
GR191/231
GRH235/HF26
GR/TR280
GRH/TRH305
GRH/TRH350
TF231D
R310/360 4X2 ->8/84
GBH/TBH280 1981->
GBH260/280 6X6
GBH260/280 6X4 ->1980
GLC/GLR190/230
G170/210/230/260/290/320

C260/290
R360 6X4 -> 10/1983
R310 6X4 JSQ 8/1984
GLM/TLM280
GLR230 4X4 SINPAR
C210/CLR220
R370 JSQ 1984
R370/390/420 ->1989
R310/330/340/365 1984->
CBH/CLM280/340
M140/160/200/230
AE380/385TV/420TV/500/520
MIDLINER GRANDE-BRETAGNE

"R" 1990->1992"
C230/280/300/340TV/CCH300
MAXTER 6X4 8X4
CBH/CLM 320/385
M/S 150/180/210/220/230TI/250
"R" 1993->"
G230/270 SP
G220/270 BOM
G200/210/230TI
"G" MANAGER 4X2" & 6X2 & 6X4"
G340TI 6X6 & 4X4
G340TI TR 18T
PREMIUM TR 4X2 =>1999

PREMIUM 6X2&6X2/4 =>1999
MAXTER 4X2-4X4
AE MAGNUM390/420TI/430/470/560
PREMIUM PR 4X2 => 1999
KERAX => 1999
PG230/280
MAGNUM E-TECH 400/440/480
PREMIUM TR 4X2 2000 =>
PREMIUM(FAB22E/H/J/Q/R)2000=>
KERAX FAB 33A=>S 2000=>2002
PREMIUM(FAB22EE/HA/HB/JJ/QQ/RR
KERAX (FAB 33AA/././SS)
KERAX (FAB33A/./R) 2003=>

Sampa Nr.
080.129

O.E.M. Nr.
5005 010 008



Dimension
ø45xø48x53

Description
Brake Camshaft Bushing

Sampa Nr.
080.548

O.E.M. Nr.
-



Dimension
ø30

Description
Rep. Kit for Brake Shoe

GRH235/HF26
R310 4X2 ->8/84
R360 4X2
GBH/TBH280 1981->
GBH260/280 6X6
GLC/GLR190/230
G260/290
C260/290
R360 6X4 -> 10/1983
R310 6X4 JSQ 8/1984
GLM/TLM280
GLR230 4X4 SINPAR
C210/CLR220
G170

G210/230
R370 JSQ 1984
R370/390/420 ->1989
R310/330/340/365 1984->
CBH/CLM280/340
G320
M140/160/200/230
AE380/385TV/420TV/500/520
MIDLINER GRANDE-BRETAGNE
"R" 1990->1992"
C230/280/300/340TV/CCH300
M/S 4X4 & INCENDIE
ME/SE/CE/ 160/180/210
MAXTER 6X4 8X4

CBH/CLM 320/385
M/S 150/180/210/220/230TI/250
"R"1993->"
G230/270 SP
G220/270 BOM
G200/210/230TI
"G" MANAGER 4X2"
"G" MANAGER 6X2 & 6X4"
G340TI 6X6
G340TI 4X4
G340TI TR 18T
PREMIUM 6X2&6X2/4 =>1999
MAXTER 4X2-4X4
AE MAGNUM390/420TI/430/470/560

M210 4X4
KERAX => 1999
PG230/280 MAGNUM E-TECH
400/440/480
PREMIUM(FAB22E/H/J/Q/R)2000=>
KERAX FAB 33A=>S 2000=>2002
PREMIUM(FAB22EE/HA/HB/JJ/QQ/RR
KERAX (FAB 33AA/././SS)
KERAX (FAB33A/./R) 2003=>
SISU
KERAX 33G ARMEE BANGLADESH
KERAX 33K ARMEE BANGLADESH

Brake



Sampa Nr.
080.126
O.E.M. Nr.
5010 067 400

Dimension
ø19.5xø30x104

Description
Brake Shoe Pin



Sampa Nr.
111.005
O.E.M. Nr.
5010 260 575

Dimension
ø42xø62x25

Description
Ball Bearing for Brake



Sampa Nr.
080.127
O.E.M. Nr.
5010 216 613

Dimension
ø30xø33x45

Description
Brake Shoe Bushing

G170/210/230/260/290/320
C260/290
C210/CLR220
R370/390/420 →1989
R310/330/340/365 1984→
CBH/CLM280/340
M140/160/200/230
AE380/385TI/420TI/500/520
MIDLINER GRANDE-BRETAGNE
"R" 1990→1992"
C230/280/300/340TI/CCH300
M/S 4X4 & INCENDIE
ME/SE/CE/ 160/180/210
MAXTER 6X4 8X4
CBH/CLM 320/385
M/S 150/180/210/220/230TI/250
"R" 1993→"
G230/270 SP
G220/270 BOM
G200/210/230TI
"G" MANAGER 4X2"
"G" MANAGER 6X2 & 6X4"
G340TI 6X6
G340TI 4X4
G340TI TR 18T
PREMIUM TR 4X2 ==>1999
PREMIUM 6X2&6X2/4 ==>1999
MAXTER 4X2-4X4
AE MAGNUM390/420TI/430/470/560
PREMIUM PR 4X2 ==> 1999
M210 4X4
KERAX ==> 1999
PREMIUM 260 SP
PG230/280
MAGNUM E-TECH 400/440/480
PREMIUM TR 4X2 2000 ==>
PREMIUM(FAB22E/H/J/Q/R)2000==>
PREMIUM PR 4X2 (FAB22A)2000==>
KERAX FAB 33A==>S 2000==>2002
PREMIUM TRACTEUR 4X2(FAB 22CC)
PREMIUM(FAB22EE/HA/HB/JJ/QQ/RR
PREMIUM PR 4X2 (FAB 22AA/AB)
KERAX (FAB 33AA/././SS)
KERAX (FAB33A/././R) 2003==>
SISU
PREMIUM 22C 071 ==> 1999
KERAX 33G ARMEE BANGLADESH
KERAX 33K ARMEE BANGLADESH



Sampa Nr.
080.547
O.E.M. Nr.
-

Dimension
ø30

Description
Rep. Kit for Brake Shoe

AE380/385TI/420TI/500/520
PREMIUM TR 4X2 ==>1999
PREMIUM 6X2&6X2/4 ==>1999
AE MAGNUM390/420TI/430/470/560
PREMIUM PR 4X2 ==> 1999
PREMIUM 260 SP
MAGNUM E-TECH 400/440/480
PREMIUM TR 4X2 2000 ==>
PREMIUM(FAB22E/H/J/Q/R)2000==>
PREMIUM PR 4X2 (FAB22A)2000==>
PREMIUM TRACTEUR 4X2(FAB 22CC)
PREMIUM(FAB22EE/HA/HB/JJ/QQ/RR
PREMIUM PR 4X2 (FAB 22AA/AB)
KERAX (FAB 33AA/././SS)
PREMIUM 22C 071 ==> 1999



Sampa Nr.
075.012
O.E.M. Nr.
5000 816 347

Dimension
ø38xø60x55

Description
Spherical Bearing

G260/290 "R" 1990→1992"
R370/390/420 →1989 "R" 1993→"
R310/330/340/365 1984→ "G" MANAGER 6X2 & 6X4"
AE380/385TI/420TI/500/520 AE MAGNUM390/420TI/430/470/560

Sampa Nr.

075.056

O.E.M. Nr.

5000 816 353 S



Dimension
ø31.7x73

Description

Brake Shoe Pin

G260/290
R370/390/420 →1989
R310/330/340/365 1984→
AE380/385TI/420TI/500/520
"R" 1990→1992"
"R" 1993→"
"G" MANAGER 6X2 & 6X4"
AE MAGNUM390/420TI/430/470/560
FREINS REMORQUE

Sampa Nr.

075.011

O.E.M. Nr.

5000 816 349



Dimension
ø38.2xø42x44.8

Description

Brake Camshaft Bushing

G260/290
R370/390/420 →1989
R310/330/340/365 1984→
AE380/385TI/420TI/500/520
"R" 1990→1992"
"R" 1993→"
"G" MANAGER 6X2 & 6X4"
AE MAGNUM390/420TI/430/470/560
FREINS REMORQUE

Sampa Nr.

075.535

O.E.M. Nr.

5000 816 353



Dimension
ø31.7x73

Description

Rep. Kit for Brake Shoe

G260/290
R370/390/420 →1989
R310/330/340/365 1984→
AE380/385TI/420TI/500/520
"R" 1990→1992"
"R" 1993→"
"G" MANAGER 6X2 & 6X4"
AE MAGNUM390/420TI/430/470/560
FREINS REMORQUE

Sampa Nr.

080.562

O.E.M. Nr.

-



Dimension
ø31.7x73

Description

Rep. Kit for Brake Shoe

G260/290
R370/390/420 →1989
R310/330/340/365 1984→
"R" 1990→1992"

Sampa Nr.

075.045

O.E.M. Nr.

5000 816 356



Dimension
ø19xø31.7x55.5

Description

Cam Roller

G260/290
R370/390/420 →1989
R310/330/340/365 1984→
AE380/385TI/420TI/500/520
"R" 1990→1992"
"R" 1993→"
"G" MANAGER 6X2 & 6X4"
AE MAGNUM390/420TI/430/470/560
FREINS REMORQUE

Sampa Nr.

080.549

O.E.M. Nr.

5000 816 356 S



Dimension
ø19xø31.7x55.5

Description

Rep. Kit for Brake Shoe

G260/290
R370/390/420 →1989
R310/330/340/365 1984→
AE380/385TI/420TI/500/520
"R" 1990→1992"
"R" 1993→"
"G" MANAGER 6X2 & 6X4"
AE MAGNUM390/420TI/430/470/560
FREINS REMORQUE

Brake



Sampa Nr.

075.045

O.E.M. Nr.

5000 816 356

Dimension

ø19xø31.7x55.5

Description

Cam Roller



Sampa Nr.

075.039

O.E.M. Nr.

5000 816 359

Dimension

ø25x227

Description

Brake Shoe Spring



Sampa Nr.

080.130

O.E.M. Nr.

5000 816 358

Dimension

ø12x64

Description

Brake Shoe Spring Pin



Sampa Nr.

080.550

O.E.M. Nr.

-

Dimension

ø19xø31.7x55.5

Description

Rep. Kit for Brake Shoe

G260/290
R370/390/420 →1989
R310/330/340/365 1984→
G320

AE380/385TI/420TI/500/520
"R" 1990→1992"
"R" 1993→"
"G" MANAGER 6X2 & 6X4"

AE MAGNUM390/420TI/430/470/560
FREINS REMORQUE

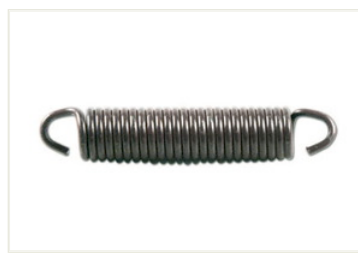

Sampa Nr.

080.099

O.E.M. Nr.

0023 532 373

Dimension

ø32x167

Description

Brake Shoe Spring



Sampa Nr.

080.144

O.E.M. Nr.

0000 174 268

Dimension

ø32x200

Description

Return Spring

TR/GR305
TR/GR350
GB131/HR15
GB/TB191/231
GC191/231
GR191/231
GRH235/HF26
GR/TR280
GRH/TRH305
GRH/TRH350
TF231D
GF151D
R310 4X2 →8/84
R360 4X2
GBH/TBH280 1981→
PJK/PJN/PJP
PGC191/231
GBH260/280 6X6
GBH260/280 6X4 →1980

GLC/GLR190/230
JE13/15
G260/290
C260/290
R360 6X4 → 10/1983
R310 6X4 JSQ 8/1984
S170 (FAB=SH)
GLM/TLM280
GLR230 4X4 SINPAR
C210/CLR220
G170
G210/230
R370 JSQ 1984
CBH/CLM280/340
M/S 4X4 & INCENDIE
ME/SE/CE/ 160/180/210
G230/270 SP
STANDARD FREINAGE

GRH235/HF26
GR/TR280
GRH/TRH305
GRH/TRH350
R310 4X2 →8/84
R360 4X2
GBH/TBH280 1981→
GBH260/280 6X6
GBH260/280 6X4 →1980
GLC/GLR190/230
G260/290
C260/290
R360 6X4 → 10/1983
R310 6X4 JSQ 8/1984
GLM/TLM280
GLR230 4X4 SINPAR
C210/CLR220
G170
G210/230
R370 JSQ 1984
R370/390/420 →1989

R310/330/340/365 1984→
CBH/CLM280/340
G320
AE380/385TI/420TI/500/520
"R" 1990→1992"
C230/280/300/340TI/CCH300
CBH/CLM 320/385
"R" 1993→"
G230/270 SP
G220/270 BOM
G200/210/230TI
"G" MANAGER 4X2"
"G" MANAGER 6X2 & 6X4"
G340TI 4X4
G340TI TR 18T
PREMIUM 6X2&6X2/4 →1999
AE MAGNUM390/420TI/430/470/560
MAGNUM E-TECH 400/440/480
PREMIUM(FAB22E/H/J/Q/R)2000==>
PREMIUM(FAB22EE/HA/HB/JJ/QQ/RR
STANDARD FREINAGE

Sampa Nr.

080.050

O.E.M. Nr.

5010 098 945

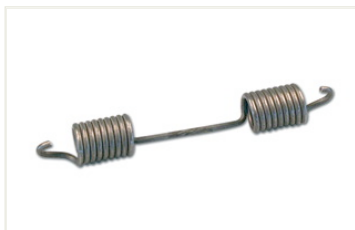

Dimension

ø35x240

Description

Brake Shoe Spring

Sampa Nr.

080.103

O.E.M. Nr.

5010 098 946



Dimension

ø15x76

Description

Brake Shoe Spring Pin

AE380/385TI/420TI/500/520
PREMIUM TR 4X2 ==>1999
PREMIUM 6X2&6X2/4 ==>1999
AE MAGNUM390/420TI/430/470/560
PREMIUM PR 4X2 ==> 1999
PREMIUM 260 SP
MAGNUM E-TECH 400/440/480
PREMIUM TR 4X2 2000 ==>
PREMIUM(FAB22E/H/J/Q/R)2000==>
PREMIUM PR 4X2 (FAB22A)2000==>
KERAX FAB 33A==>S 2000==>2002
PREMIUM TRACTEUR 4X2(FAB 22CC)
PREMIUM(FAB22EE/HA/HB/JJ/QQ/RR
PREMIUM PR 4X2 (FAB 22AA/AB)
KERAX (FAB 33AA/././SS)
KERAX (FAB33A/././R) 2003==>
PREMIUM 22C 071 ==> 1999
PUNCHER
STANDARD FREINAGE

Sampa Nr.

080.565

O.E.M. Nr.

-



Dimension

ø25

Description

Rep. Kit for Brake Shoe

AE380/385TI/420TI/500/520
PREMIUM TR 4X2 ==>1999
PREMIUM 6X2&6X2/4 ==>1999
AE MAGNUM390/420TI/430/470/560
PREMIUM PR 4X2 ==> 1999
MAGNUM E-TECH 400/440/480
PREMIUM TR 4X2 2000 ==>
PREMIUM(FAB22E/H/J/Q/R)2000==>
KERAX FAB 33A==>S 2000==>2002
PREMIUM(FAB22EE/HA/HB/JJ/QQ/RR
KERAX (FAB 33AA/././SS)
KERAX (FAB33A/././R) 2003==>

Sampa Nr.

080.101

O.E.M. Nr.

5000 716 656



Dimension

ø25xø50x24.5

Description

Brake Shoe Roller

Sampa Nr.

080.104

O.E.M. Nr.

5000 716 600



Dimension







ø25x63

Description

Brake Shoe Pin

G260/290
C260/290
C210/CLR220
G170
G210/230
R370/390/420 —>1989
R310/330/340/365 1984—>
CBH/CLM280/340
G320
M140/160/200/230
AE380/385TI/420TI/500/520
MIDLINER GRANDE-BRETAGNE
"R" 1990—>1992"
C230/280/300/340TI/CCH300
M/S 4X4 & INCENDIE
ME/SE/CE/ 160/180/210
MAXTER 6X4 8X4
CBH/CLM 320/385
M/S 150/180/210/220/230TI/250
"R" 1993—>"
G230/270 SP
G220/270 BOM
G200/210/230TI
"G" MANAGER 4X2"
"G" MANAGER 6X2 & 6X4"
G340TI 6X6
G340TI 4X4
G340TI TR 18T
PREMIUM TR 4X2 ==>1999
PREMIUM 6X2&6X2/4 ==>1999
MAXTER 4X2-4X4
AE MAGNUM390/420TI/430/470/560
PREMIUM PR 4X2 ==> 1999
M210 4X4
KERAX ==> 1999
PREMIUM 260 SP
PG230/280
MAGNUM E-TECH 400/440/480
PREMIUM TR 4X2 2000 ==>
PREMIUM(FAB22E/H/J/Q/R)2000==>
PREMIUM PR 4X2 (FAB22A)2000==>
KERAX FAB 33A==>S 2000==>2002
PREMIUM TRACTEUR 4X2(FAB 22CC)
PREMIUM(FAB22EE/HA/HB/JJ/QQ/RR
PREMIUM PR 4X2 (FAB 22AA/AB)
KERAX (FAB 33AA/././SS)
KERAX (FAB33A/././R) 2003==>
SISU
PREMIUM 22C 071 ==> 1999
KERAX 33G ARMEE BANGLADESH
KERAX 33K ARMEE BANGLADESH
PUNCHER

Brake

 <p><i>Dimension</i> ø30x233</p> <p><i>Description</i> Brake Shoe Spring</p>	<p><i>Sampa Nr.</i> 080.051</p> <p><i>O.E.M. Nr.</i> 5010 097 089</p>	 <p><i>Dimension</i> ø38x145</p> <p><i>Description</i> Brake Shoe Spring</p>	<p><i>Sampa Nr.</i> 080.052</p> <p><i>O.E.M. Nr.</i> 5010 097 340</p>
 <p><i>Dimension</i> ø25xø50x24.5</p> <p><i>Description</i> Brake Shoe Roller</p>	<p><i>Sampa Nr.</i> 080.101</p> <p><i>O.E.M. Nr.</i> 5000 716 656</p>	 <p><i>Dimension</i> ø25x63</p> <p><i>Description</i> Brake Shoe Pin</p>	<p><i>Sampa Nr.</i> 080.104</p> <p><i>O.E.M. Nr.</i> 5000 716 600</p>
 <p><i>Dimension</i> ø12x96</p> <p><i>Description</i> Brake Shoe Spring Pin</p>	<p><i>Sampa Nr.</i> 080.135</p> <p><i>O.E.M. Nr.</i> 5010 097 262</p>	 <p><i>Dimension</i> ø25</p> <p><i>Description</i> Rep. Kit for Brake Shoe</p>	<p><i>Sampa Nr.</i> 080.564</p> <p><i>O.E.M. Nr.</i> -</p>
<p>G260/290 C260/290 C210/CLR220 G170 G210/230 R370/390/420 —>1989 R310/330/340/365 1984—> CBH/CLM280/340 G320 M140/160/200/230 AE380/385TI/420TI/500/520 MIDLINER GRANDE-BRETAGNE "R" 1990—>1992" C230/280/300/340TI/CCH300 M/S 4X4 & INCENDIE ME/SE/CE/ 160/180/210 MAXTER 6X4 8X4</p>	<p>CBH/CLM 320/385 M/S 150/180/210/220/230TI/250 "R" 1993—>" G230/270 SP G220/270 BOM G200/210/230TI "G" MANAGER 4X2" "G" MANAGER 6X2 & 6X4" G340TI 6X6 G340TI 4X4 G340TI TR 18T PREMIUM TR 4X2 ==>1999 PREMIUM 6X2&6X2/4 ==>1999 MAXTER 4X2-4X4 AE MAGNUM390/420TI/430/470/560 PREMIUM PR 4X2 ==> 1999 M210 4X4</p>	<p>KERAX ==> 1999 PREMIUM 260 SP PG230/280 MAGNUM E-TECH 400/440/480 PREMIUM TR 4X2 2000 ==> PREMIUM(FAB22E/H/J/Q/R)2000==> PREMIUM PR 4X2 (FAB22A)2000==> KERAX FAB 33A==>S 2000==>2002 PREMIUM TRACTEUR 4X2(FAB 22CC) PREMIUM(FAB22EE/HA/HB/JJ/QQ/RR) PREMIUM PR 4X2 (FAB 22AA/AB) KERAX (FAB 33AA/././SS) KERAX (FAB33A/././R) 2003==> SISU PREMIUM 22C 071 ==> 1999 KERAX 33G ARMEE BANGLADESH KERAX 33K ARMEE BANGLADESH</p>	

Sampa Nr.

080.102

O.E.M. Nr.

0000 189 976



Dimension

ø25xø60x20

Description

Brake Shoe Roller

TR/GR305	R360 4X2	GLM/TLM280
TR/GR350	GBH/TBH280 1981→	GLR230 4X4 SINPAR
GR191/231	GBH260/280 6X6	C210/CLF220
GRH235/HF26	GBH260/280 6X4 →1980	G170
GR/TR280	GLC/GLR190/230	G210/230
GRH/TRH305	G260/290	R370 JSQ 1984
GRH/TRH350	C260/290	CBH/CLM280/340
TF231D	R360 6X4 → 10/1983	G230/270 SP
R310 4X2 →8/84	R310 6X4 JSQ 8/1984	

Sampa Nr.

080.107

O.E.M. Nr.

0000 192 399



Dimension

ø25x75

Description

Brake Shoe Pin

TR/GR305	R360 4X2	GLM/TLM280
TR/GR350	GBH/TBH280 1981→	GLR230 4X4 SINPAR
GR191/231	GBH260/280 6X6	C210/CLF220
GRH235/HF26	GBH260/280 6X4 →1980	G170
GR/TR280	GLC/GLR190/230	G210/230
GRH/TRH305	G260/290	R370 JSQ 1984
GRH/TRH350	C260/290	CBH/CLM280/340
TF231D	R360 6X4 → 10/1983	G230/270 SP
R310 4X2 →8/84	R310 6X4 JSQ 8/1984	

Sampa Nr.

080.137

O.E.M. Nr.

5000 786 674



Dimension

ø30xø33x20

Description

Brake Shoe Bushing

TR/GR305	GBH/TBH280 1981→	C210/CLF220
TR/GR350	GBH260/280 6X6	G170
GR191/231	GBH260/280 6X4 →1980	G210/230
GRH235/HF26	GLC/GLR190/230	R370 JSQ 1984
GR/TR280	G260/290	R370/390/420 →1989
GRH/TRH305	C260/290	R310/330/340/365 1984→
GRH/TRH350	R360 6X4 → 10/1983	CBH/CLM280/340
TF231D	R310 6X4 JSQ 8/1984	G230/270 SP
R310 4X2 →8/84	GLM/TLM280	
R360 4X2	GLR230 4X4 SINPAR	

Sampa Nr.

080.106

O.E.M. Nr.

5000 737 307



Dimension

ø30x93

Description

Brake Shoe Pin

TR/GR305	GBH/TBH280 1981→	C210/CLF220
TR/GR350	GBH260/280 6X6	G170
GR191/231	GBH260/280 6X4 →1980	G210/230
GRH235/HF26	GLC/GLR190/230	R370 JSQ 1984
GR/TR280	G260/290	R370/390/420 →1989
GRH/TRH305	C260/290	R310/330/340/365 1984→
GRH/TRH350	R360 6X4 → 10/1983	CBH/CLM280/340
TF231D	R310 6X4 JSQ 8/1984	G230/270 SP
R310 4X2 →8/84	GLM/TLM280	
R360 4X2	GLR230 4X4 SINPAR	

Sampa Nr.

080.136

O.E.M. Nr.

5005 016 005



Dimension

ø38x156

Description

Brake Shoe Spring

TR/GR305	R360 4X2	GLM/TLM280
TR/GR350	GBH/TBH280 1981→	GLR230 4X4 SINPAR
GR191/231	GBH260/280 6X6	C210/CLF220
GRH235/HF26	GBH260/280 6X4 →1980	G170
GR/TR280	GLC/GLR190/230	G210/230
GRH/TRH305	G260/290	R370 JSQ 1984
GRH/TRH350	C260/290	CBH/CLM280/340
TF231D	R360 6X4 → 10/1983	G230/270 SP
R310 4X2 →8/84	R310 6X4 JSQ 8/1984	

Sampa Nr.

080.567

O.E.M. Nr.

-



Dimension

Description

Rep. Kit for Brake Shoe

TR/GR305	R360 4X2	GLM/TLM280
TR/GR350	GBH/TBH280 1981→	GLR230 4X4 SINPAR
GR191/231	GBH260/280 6X6	C210/CLF220
GRH235/HF26	GBH260/280 6X4 →1980	G170
GR/TR280	GLC/GLR190/230	G210/230
GRH/TRH305	G260/290	R370 JSQ 1984
GRH/TRH350	C260/290	CBH/CLM280/340
TF231D	R360 6X4 → 10/1983	G230/270 SP
R310 4X2 →8/84	R310 6X4 JSQ 8/1984	

Brake



Sampa Nr.

080.052

O.E.M. Nr.

5010 097 340

Dimension

ø38x145

Description

Brake Shoe Spring



Sampa Nr.

080.104

O.E.M. Nr.

5000 716 600

Dimension

ø25x63

Description

Brake Shoe Pin

G260/290
C260/290
C210/CLR220
G170
G210/230
R370/390/420 →1989
R310/330/340/365 1984→
CBH/CLM280/340
G320
M140/160/200/230
AE380/385TI/420TI/500/520
MIDLINER GRANDE-BRETAGNE
"R" 1990→1992"
C230/280/300/340TI/CCH300
M/S 4X4 & INCENDIE
ME/SE/CE/ 160/180/210
MAXTER 6X4 8X4
CBH/CLM 320/385
M/S 150/180/210/220/230TI/250
"R" 1993→"
G230/270 SP
G220/270 BOM
G200/210/230TI
"G" MANAGER 4X2"
"G" MANAGER 6X2 & 6X4"
G340TI 6X6

G340TI 4X4
G340TI TR 18T
PREMIUM TR 4X2 ⇒1999
PREMIUM 6X2&6X2/4 ⇒1999
MAXTER 4X2-4X4
AE MAGNUM390/420TI/430/470/560
PREMIUM PR 4X2 ⇒ 1999
M210 4X4
KERAX ⇒ 1999
PREMIUM 260 SP
PG230/280
MAGNUM E-TECH 400/440/480
PREMIUM TR 4X2 2000 ⇒
PREMIUM(FAB22E/H/J/Q/R)2000⇒
PREMIUM PR 4X2 (FAB22A)2000⇒
KERAX FAB 33A⇒S 2000⇒2002
PREMIUM TRACTEUR 4X2(FAB 22CC)
PREMIUM(FAB22EE/HA/HB/JJ/QQ/RR
PREMIUM PR 4X2 (FAB 22AA/AB)
KERAX (FAB 33AA/././SS)
KERAX (FAB33A/./R) 2003⇒
SISU
PREMIUM 22C 071 ⇒ 1999
KERAX 33G ARMEE BANGLADESH
KERAX 33K ARMEE BANGLADESH
STANDARD FREINAGE



Sampa Nr.

080.572

O.E.M. Nr.

-

Dimension

Description

Rep. Kit for Brake Shoe

G260/290
C260/290
C210/CLR220
G170

G210/230
R370/390/420 →1989
R310/330/340/365 1984→
G230/270 SP



Sampa Nr.

080.101

O.E.M. Nr.

5000 716 656

Dimension

ø25xø50x24.5

Description

Brake Shoe Roller



Sampa Nr.

080.105

O.E.M. Nr.

5000 737 308

Dimension

ø30x110.5

Description

Brake Shoe Pin

G260/290
C260/290
C210/CLR220
G170
G210/230
R370/390/420 →1989

R310/330/340/365 1984→
G230/270 SP



Sampa Nr.

080.137

O.E.M. Nr.

5000 786 674

Dimension

ø30xø33x20

Description

Brake Shoe Bushing

TR/GR305	G260/290
TR/GR350	C260/290
GR191/231	R360 6X4 → 10/1983
GRH235/HF26	R310 6X4 JSQ 8/1984
GR/TR280	GLM/TLM280
GRH/TRH305	GLR230 4X4 SINPAR
GRH/TRH350	C210/CLR220
TF231D	G170
R310 4X2 ->8/84	G210/230
R360 4X2	R370 JSQ 1984
GBH/TBH280 1981→	R370/390/420 →1989
GBH260/280 6X6	R310/330/340/365 1984→
GBH260/280 6X4 →1980	CBH/CLM280/340
GLC/GLR190/230	G230/270 SP

Sampa Nr.

080.229

O.E.M. Nr.

0000 241 884

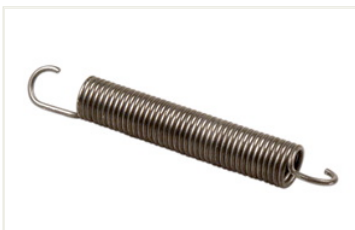

Dimension

ø24x172

Description

Return Spring

GLM/TLM280 C210/CLR220 CBH/CLM 320/385
GLR230 4X4 SINPAR R370 JSQ 1984 TR/GR350

Sampa Nr.

080.078

O.E.M. Nr.

5000 737 271



Dimension

ø245x478x38

Description

Dust Cover

G210/230/260/290/320 C260/290 C210/CLR220 R370/390/420 →1989 R310/330/340/365 1984→ CBH/CLM280/340 "R" 1990→>1992" C230/280/300/340TI/CCH300 CBH/CLM 320/385 "R" 1993→>" "G" MANAGER 6X2 & 6X4"

Sampa Nr.

080.080

O.E.M. Nr.

5000 716 313



Dimension

ø245xø466x41

Description

Dust Cover

TR/GR305/350 GR191/231/TF280 GRH235/HF26 GRH/TRH305/350 TF231D R310 4X2 →8/84 R360 4X2 GBH/TBH280 1981→ GBH260/280/6X6 GBH260/280/6X4 →1980 GLC/GLR190/230 G170/210/230/260/290/320 C260/290/210/CLR220 R360 6X4 → 10/1983 R310 6X4 JSQ 8/1984 GLM/TLM280 GLR230 4X4 SINPAR R370 JSQ 1984 R370/390/420 →1989 R310/330/340/365 1984→ CBH/CLM280/340 M140/160/200/230 AE380/385TI/420TI/500/520 MIDLINER GRANDE-BRETAGNE "R" 1990→>1992" C230/280/300/340TI/CCH300 MAXTER 6X4 8X4 CBH/CLM 320/385 M/S 150/180/210/220/230TI/250 "R" 1993→>" G230/270 SP/220/270 BCM/200/210/230TI "G" MANAGER 4X2" & 6X2 & 6X4" G340TI 6X6 4X4 G340TI TR 18T PREMIUM 6X2&6X2/4 →1999 MAXTER 4X2-4X4 AE MAGNUM390/420TI/430/470/560 KERAX → 1999 PG230/280 MAGNUM E-TECH 400/440/480 PREMIUM/FAB22E/H/J/Q/R)2000→> KERAX FAB 33A→>S 2000→>2002 PREMIUM/FAB22EE/H/HB/J/Q/R/R KERAX (FAB 33AA//./SS) KERAX (FAB33A//./R) 2000→> SISU

Sampa Nr.

080.231

O.E.M. Nr.

0000 492 878



Dimension

ø23x208

Description

Return Spring

GRH235/HF26 GRH/TRH305 GRH/TRH350 GBH/TBH280 1981→ GBH260/280 6X4->1980 G260/290 C260/290 R360 6X4->10/1983 R310 6X4 JSQ 8/1984 R370 JSQ 1984 R370/390/420->1989 R310/330/340/365 1984→> CBH/CLM280/340 AE380/385TI/420TI/500/520 R 1990→>1992 C230/280/300/340TI/CCH300 MAXTER 6X4 8X4 CBH/CLM 320/385 R 1993→> G MANAGER 6X2 & 6X4 G340TI 6X6 AE MAGNUM390/420TI/430/470/560 KERAX→>1999 KERAX FAB 33A→>S 2000→>2002 KERAX (FAB 33AA//./SS)

Sampa Nr.

080.079

O.E.M. Nr.

5000 716 310



Dimension

ø245xø466x41

Description

Dust Cover

G170/210/230/260/290 C260/290 R370/390/420 →1989 R310/330/340/365 1984→> M140/160/200/230 MIDLINER GRANDE-BRETAGNE M/S 4X4 & INCENDIE ME/SE/CE/ 160/180/210 M/S 150/180/210/220/230TI/250 G230/270 SP M210 4X4

Sampa Nr.

080.081

O.E.M. Nr.

5010 260 114



Dimension

ø250xø466x63

Description

Dust Cover

MAXTER 6X4 8X4 "R" 1993→>" PREMIUM 6X2&6X2/4 →1999 MAXTER 4X2-4X4 KERAX → 1999 PREMIUM TR 4X2 2000 →> PREMIUM(FAB22E/H/J/Q/R)2000→> KERAX FAB 33A→>S 2000→>2002 PREMIUM(FAB22EE/H/HB/J/Q/R/R KERAX (FAB 33AA//./SS) KERAX (FAB33A//./R) 2003→> KERAX 33G ARMEE BANGLADESH KERAX 33K ARMEE BANGLADESH

Brake



Sampa Nr.

080.082

O.E.M. Nr.

5010 260 113

Dimension

ø250xø466x63

Description

Dust Cover

MAXTER 6X4 8X4 "R" 1993—>	KERAX FAB 33A—>S 2000—>2002 PREMIUM(FAB22EE/HA/HB/JJ/QQ/RR)
PREMIUM 6X2&6X2/4 =>1999	KERAX (FAB 33AA././SS)
MAXTER 4X2-4X4	KERAX (FAB33A././R) 2003=>
KERAX => 1999	KERAX 33G ARMEE BANGLADESH
PREMIUM TR 4X2 2000 =>	KERAX 33K ARMEE BANGLADESH
PREMIUM(FAB22E/H/J/Q/R)2000=>	



Sampa Nr.

080.085

O.E.M. Nr.

5000 737 306

Dimension

ø245xø478x36

Description

Dust Cover

G170/260/290/320 G210/230 R370/390/420 —>1989 R310/330/340/365 1984—> "R" 1990—>1992"	C230/280/300/340TI/CCH300 "R" 1993—> G230/270 SP "G" MANAGER 4X2"
---	--



Sampa Nr.

080.083

O.E.M. Nr.

5010 136 144

Dimension

ø250xø466x63

Description

Dust Cover

AE380/385TI/420TI/500/520 "R" 1990—>1992"	PREMIUM TR 4X2 =>1999
CBH/CLM 320/385 "R" 1993—>	PREMIUM 6X2&6X2/4 =>1999
G220/270 BOM	AE MAGNUM390/420TI/430/470/560
G200/210/230TI	PREMIUM PR 4X2 => 1999
"G" MANAGER 4X2"	PG230/280
"G" MANAGER 6X2 & 6X4"	MAGNUM E-TECH 400/440/480
G340TI TR 18T	PREMIUM(FAB22E/H/J/Q/R)2000=>
	PREMIUM(FAB22EE/HA/HB/JJ/QQ/RR)



Sampa Nr.

080.086

O.E.M. Nr.

5000 737 576

Dimension

ø232x478x43

Description

Dust Cover

G260/290 G210/230 M140/160/200/230	MIDLINER GRANDE-BRETAGNE M/S 150/180/210/220/230TI/250 G220/270 BOM
--	---



Sampa Nr.

080.084

O.E.M. Nr.

0003 337 605

Dimension

ø240xø480x31

Description

Dust Cover

TR/GR305	TF231D	C260/290
TR/GR350	GF151D	R360 6X4 —> 10/1983
GB131/HR15	R310 4X2 ->8/84	R310 6X4 JSQ 8/1984
GB/TB191/231	R360 4X2	GLR230 4X4 SINPAR
GC191/231	GBH/TBH280 1981—>	C210/CLF220
GR191/231	PGC191/231	G170
GRH235/HF26	GBH260/280 6X6	G210/230
GR/TF280	GBH260/280 6X4 —>1980	R370 JSQ 1984
GRH/TRH305	GLC/GLR190/230	CBH/CLM280/340
GRH/TRH350	G260/290	



Sampa Nr.

080.087

O.E.M. Nr.

5000 296 427

Dimension

ø110xø338x34/70

Description

Dust Cover

B90
B80/110/120



Sampa Nr.

080.088

O.E.M. Nr.

5000 296 428

Dimension

ø110xø338x34/70

Description

Dust Cover

B90
B80/110/120

Sampa Nr.

080.089

O.E.M. Nr.

**5010 098 794
(5010 098 795)**



Dimension

ø245xø466x46

Description

Dust Cover

AE380/385TI/420TI/500/520
PREMIUM TR 4X2 =>1999
PREMIUM 6X2&6X2/4 =>1999
AE MAGNUM390/420TI/430/470/560
PREMIUM PR 4X2 => 1999
PREMIUM 260 SP
MAGNUM E-TECH 400/440/480
PREMIUM TR 4X2 2000 =>
PREMIUM(FAB22E/H/J/Q/R)2000=>
PREMIUM PR 4X2 (FAB22A)2000=>
KERAX FAB 33A=>S 2000=>2002
PREMIUM TRACTEUR 4X2(FAB 22CC)
PREMIUM(FAB22EE/H/HB/JJ/QQ/RR)
PREMIUM PR 4X2 (FAB 22AA/AB)
KERAX (FAB 33AA/././SS)
KERAX (FAB33A/./R) 2003=>
PREMIUM 22C 071 => 1999
PUNCHER

Sampa Nr.

080.160

O.E.M. Nr.

5010 525 628



Dimension

ø218xø435x64

Description

Dust Cover

KERAX (FAB 33AA/././SS)
KERAX (FAB 33A/./R) 2003=>

Sampa Nr.

030.216

O.E.M. Nr.

7420 367 343



Dimension

234x446x54

Description

Dust Cover

KERAX DXI

Sampa Nr.

080.090

O.E.M. Nr.

**5000 792 560
(5000 792 558)**



Dimension

ø225xø470x33

Description

Dust Cover

CBH/CLM280/340 "G" MANAGER 4X2"
C230/280/300/340TI/CCH300 G340TI 4X4
CBH/CLM 320/385

Sampa Nr.

075.532

O.E.M. Nr.

5000 816 369



Dimension

ø230xø467x65

Description

Dust Cover Set

G260/290 "R" 1990->1992"
R370/390/420 ->1989 "R" 1993->"
R310/330/340/365 1984-> "G" MANAGER 6X2 & 6X4"
AE380/385TI/420TI/500/520 AE MAGNUM390/420TI/430/470/560

Sampa Nr.

080.091

O.E.M. Nr.

**5000 792 559
(5000 792 561)**



Dimension

ø225xø470x33

Description

Dust Cover

CBH/CLM280/340 "G" MANAGER 4X2"
C230/280/300/340TI/CCH300 G340TI 4X4
CBH/CLM 320/385

Sampa Nr.

075.544

O.E.M. Nr.

5000 816 935



Dimension

ø230xø465x54

Description

Dust Cover Set

G260/290 R310/330/340/365 1984->
R370/390/420 ->1989 "R" 1990->1992"

Brake



Sampa Nr.

095.509

O.E.M. Nr.

MCK-1171/N

Dimension

Description

Rep. Kit for Brake Caliper

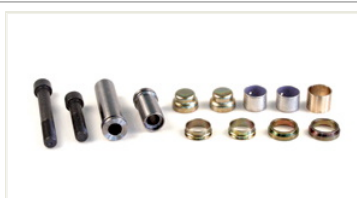

Sampa Nr.

095.510

O.E.M. Nr.

MCK-1102/N

Dimension

Description

Rep. Kit for Brake Caliper

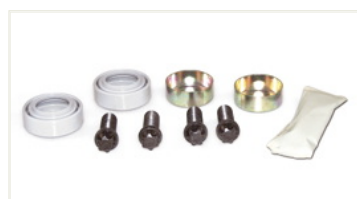

Sampa Nr.

095.511

O.E.M. Nr.

MCK 1253

Dimension

Description

Rep. Kit for Brake Caliper



Sampa Nr.

095.512

O.E.M. Nr.

MCK 1254

Dimension

Description

Rep. Kit for Brake Caliper



Sampa Nr.

095.574

O.E.M. Nr.

5001 866 989

Dimension

Description

Rep. Kit for Brake Caliper

MAGNUM DXI 12-VAR-120AV
PREMIUM DXI 11-FAB-27JC/TC
PREMIUM DXI 11-FAB-27RC/SC



Sampa Nr.

095.575

O.E.M. Nr.

5001 858 717

Dimension

Description

Rep. Kit for Brake Caliper

MAGNUM E-TECH 400/440/480
PREMIUM(FAB22E/H/J/Q/R)2000==>
PREMIUM PR 4X2 (FAB22A)2000==>
PREMIUM TRACTEUR 4X2(FAB 22CC)
PREMIUM(FAB22EE/HA/HB/JJ/QQ/RR)
PREMIUM PR 4X2 (FAB 22AA/AB)



Sampa Nr.

095.576

O.E.M. Nr.

5001 860 791

Dimension

Description

Rep. Kit for Brake Caliper

MAGNUM E-TECH 400/440/480
MIDLUM 42B3/4-44TMC.-45D./E.
PREMIUM TRACTEUR 4X2(FAB 22CC)
PREMIUM(FAB22EE/HA/HB/JJ/QQ/RR)
PREMIUM PR 4X2 (FAB 22AA/AB)
SISU



Sampa Nr.

095.577

O.E.M. Nr.

5001 866 400

Dimension

Description

Rep. Kit for Brake Caliper

MAGNUM DXI 12-VAR-120AV
PREMIUM DXI 11-FAB-27JC/TC
PREMIUM DXI 11-FAB-27RC/SC

Sampa Nr.	095.578	
O.E.M. Nr.	5001 858 718 (5001 860 792)	
Dimension		
Description	Rep. Kit for Brake Caliper	
MAGNUM E-TECH 400/440/480	PREMIUM PR 4X2 (FAB 22AA/AB)	
PREMIUM(FAB22E/H/J/Q/R)2000=>	MIDLUM 42B3/4-44TMC.-45D/E	
PREMIUM PR 4X2 (FAB22A)2000=>	SISU	
PREMIUM TRACTEUR 4X2(FAB 22CC)		
PREMIUM(FAB22EE/HA/HB/JJ/QQ/RR)		

Sampa Nr.	095.579	
O.E.M. Nr.	5001 866 398	
Dimension		
Description	Rep. Kit for Brake Caliper	
MAGNUM DXI 12-VAR-120AV		
PREMIUM DXI 11-FAB-27JC/TC		
PREMIUM DXI 11-FAB-27RC/SC		

Sampa Nr.	095.513	
O.E.M. Nr.	MCK 1139	
Dimension		
Description	Rep. Kit for Brake Caliper	

Sampa Nr.	095.514	
O.E.M. Nr.	MCK 1238	
Dimension		
Description	Rep. Kit for Brake Caliper	

Sampa Nr.	095.515	
O.E.M. Nr.	MCK 1171	
Dimension		
Description	Rep. Kit for Brake Caliper	

Sampa Nr.	095.516	
O.E.M. Nr.	MCK 1192	
Dimension		
Description	Rep. Kit for Brake Caliper	

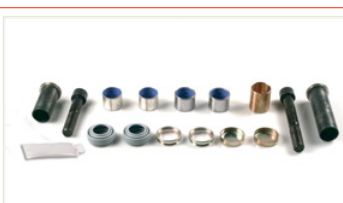
Sampa Nr.	095.517	
O.E.M. Nr.	5001 837 006	
Dimension		
Description	Rep. Kit for Brake Caliper	
AE380/385TI/420TI/500/520	MAGNUM E-TECH 400/440/480	
PREMIUM TR 4X2 ==>1999	PREMIUM TR 4X2 2000 ==>	
PREMIUM 6X2&6X2/4 ==>1999	PREMIUM(FAB22E/H/J/Q/R)2000==>	
AE MAGNUM390/420TI/430/470/560	PREMIUM PR 4X2 (FAB22A)2000==>	
PREMIUM PR 4X2 ==> 1999	PREMIUM PR 4X2 (FAB 22AA/AB)	
PREMIUM 260 SP	PREMIUM 22C 071 ==> 1999	

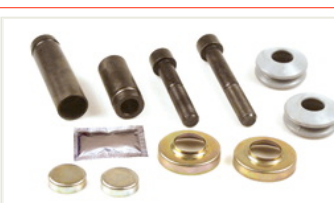
Sampa Nr.	095.580	
O.E.M. Nr.	5001 822 994	
Dimension		
Description	Rep. Kit for Brake Caliper	
AE380/385TI/420TI/500/520		
PREMIUM TR 4X2 ==>1999		
PREMIUM 6X2&6X2/4 ==>1999		
AE MAGNUM390/420TI/430/470/560		
PREMIUM PR 4X2 ==> 1999		

Brake



Sampa Nr.

095.524

O.E.M. Nr.

K 001300

Dimension

Description

Rep. Kit for Brake Caliper

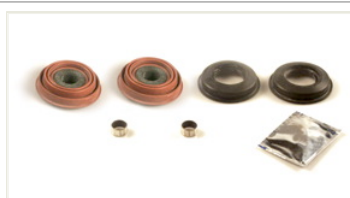

Sampa Nr.

095.572

O.E.M. Nr.

K 010603

Dimension

Description

Rep. Kit for Brake Caliper

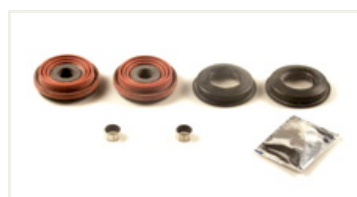

Sampa Nr.

095.573

O.E.M. Nr.

K 010604

Dimension

Description

Rep. Kit for Brake Caliper



Sampa Nr.

095.581

O.E.M. Nr.

K 000944

Dimension

Description

Rep. Kit for Brake Caliper



Sampa Nr.

095.521

O.E.M. Nr.

II 304130065

Dimension

Description

Rep. Kit for Brake Caliper



Sampa Nr.

095.519

O.E.M. Nr.

K 000696

Dimension

Description

Rep. Kit for Brake Caliper



Sampa Nr.

095.520

O.E.M. Nr.

K 000687

Dimension

Description

Rep. Kit for Brake Caliper



Sampa Nr.

095.525

O.E.M. Nr.

II 358510062

Dimension

Description

Rep. Kit for Brake Caliper

Sampa Nr.
095.530
O.E.M. Nr.
K 001274



Dimension

Description
Rep. Kit for Brake Caliper

Sampa Nr.
095.531
O.E.M. Nr.
K 000375



Dimension

Description
Rep. Kit for Brake Caliper

Sampa Nr.
095.568
O.E.M. Nr.
K 000472



Dimension

Description
Rep. Kit for Brake Caliper

Sampa Nr.
095.533
O.E.M. Nr.
II 339680062
(II 328090062)
(II 369100062)



Dimension

Description
Rep. Kit for Brake Caliper

Sampa Nr.
095.569
O.E.M. Nr.
K 001925



Dimension

Description
Rep. Kit for Brake Caliper

Sampa Nr.
095.570
O.E.M. Nr.
K 001532



Dimension

Description
Rep. Kit for Brake Caliper









Sampa Nr.
095.526
O.E.M. Nr.
93161192



Dimension













Description
Rep. Kit for Brake Caliper

Brake

	<p><i>Sampa Nr.</i> 095.518</p> <p><i>O.E.M. Nr.</i> II 368470064</p>		<p><i>Sampa Nr.</i> 095.527</p> <p><i>O.E.M. Nr.</i> II 197140062</p>
<p><i>Dimension</i></p>		<p><i>Dimension</i></p>	
<p><i>Description</i></p> <p>Rep. Kit for Brake Caliper</p>		<p><i>Description</i></p> <p>Rep. Kit for Brake Caliper</p>	
	<p><i>Sampa Nr.</i> 095.528</p> <p><i>O.E.M. Nr.</i> II 179320062</p>		<p><i>Sampa Nr.</i> 095.529</p> <p><i>O.E.M. Nr.</i> II 197330062</p>
<p><i>Dimension</i></p>		<p><i>Dimension</i></p>	
<p><i>Description</i></p> <p>Rep. Kit for Brake Caliper</p>		<p><i>Description</i></p> <p>Rep. Kit for Brake Caliper</p>	
	<p><i>Sampa Nr.</i> 095.522</p> <p><i>O.E.M. Nr.</i> II 39769F0063</p>		<p><i>Sampa Nr.</i> 095.571</p> <p><i>O.E.M. Nr.</i> K 001301</p>
<p><i>Dimension</i></p>		<p><i>Dimension</i></p>	
<p><i>Description</i></p> <p>Rep. Kit for Brake Caliper</p>		<p><i>Description</i></p> <p>Rep. Kit for Brake Caliper</p>	
	<p><i>Sampa Nr.</i> 095.523</p> <p><i>O.E.M. Nr.</i> K 000945</p>		<p><i>Sampa Nr.</i> 095.567</p> <p><i>O.E.M. Nr.</i> K 000029</p>
<p><i>Dimension</i></p>		<p><i>Dimension</i></p>	
<p><i>Description</i></p> <p>Rep. Kit for Brake Caliper</p>		<p><i>Description</i></p> <p>Rep. Kit for Brake Caliper</p>	

DIAPHRAGMS

R.V.I.

<p><i>Sampa Nr.</i></p> <p>095.101</p> <p><i>O.E.M. Nr.</i></p> <p>897 120 492.4</p>	 <p>Type 9" Short</p>	<p><i>Sampa Nr.</i></p> <p>095.108</p> <p><i>O.E.M. Nr.</i></p> <p>897 120 540.4</p>	 <p>Type 30" Short</p>
<p><i>Description</i></p> <p>Short Stroke</p>		<p><i>Description</i></p> <p>Short Stroke</p>	
<p><i>Sampa Nr.</i></p> <p>095.103</p> <p><i>O.E.M. Nr.</i></p> <p>897 120 505.4</p>	 <p>Type 12" Short</p>	<p><i>Sampa Nr.</i></p> <p>095.109</p> <p><i>O.E.M. Nr.</i></p> <p>897 120 550.4</p>	 <p>Type 36" Short</p>
<p><i>Description</i></p> <p>Short Stroke</p>		<p><i>Description</i></p> <p>Short Stroke</p>	
<p><i>Sampa Nr.</i></p> <p>095.105</p> <p><i>O.E.M. Nr.</i></p> <p>897 120 510.4</p>	 <p>Type 16" Short</p>	<p><i>Sampa Nr.</i></p> <p>095.110</p> <p><i>O.E.M. Nr.</i></p> <p>897 120 516.4</p>	 <p>Type 16" Long</p>
<p><i>Description</i></p> <p>Short Stroke</p>		<p><i>Description</i></p> <p>Long Stroke</p>	
<p><i>Sampa Nr.</i></p> <p>095.106</p> <p><i>O.E.M. Nr.</i></p> <p>897 120 520.4</p>	 <p>Type 20" Short</p>	<p><i>Sampa Nr.</i></p> <p>095.111</p> <p><i>O.E.M. Nr.</i></p> <p>897 120 526.4</p>	 <p>Type 20" Long</p>
<p><i>Description</i></p> <p>Short Stroke</p>		<p><i>Description</i></p> <p>Long Stroke</p>	
<p><i>Sampa Nr.</i></p> <p>095.107</p> <p><i>O.E.M. Nr.</i></p> <p>897 120 530.4</p>	 <p>Type 24" Short</p>	<p><i>Sampa Nr.</i></p> <p>095.112</p> <p><i>O.E.M. Nr.</i></p> <p>897 120 536.4</p>	 <p>Type 24" Long</p>
<p><i>Description</i></p> <p>Short Stroke</p>		<p><i>Description</i></p> <p>Long Stroke</p>	
<p><i>Sampa Nr.</i></p> <p>095.107</p> <p><i>O.E.M. Nr.</i></p> <p>897 120 530.4</p>	 <p>Type 24" Short</p>	<p><i>Sampa Nr.</i></p> <p>095.113</p> <p><i>O.E.M. Nr.</i></p> <p>897 120 546.4</p>	 <p>Type 30" Long</p>
<p><i>Description</i></p> <p>Short Stroke</p>		<p><i>Description</i></p> <p>Long Stroke</p>	

Wheel - Axle



Sampa Nr.

080.216

O.E.M. Nr.

5001 852 775

Dimension

ø20xø63x72.5

Description

Silent Block

PREMIUM 6X2&6X2/4 ==>1999
 AE MAGNUM390/420T/430/470/560
 MAGNUM E-TECH 400/440/480
 PREMIUM(FAB22E/H/J/Q/R)2000==>
 PREMIUM(FAB22EE/HA/HB/JJ/QQ/RR



Sampa Nr.

080.221

O.E.M. Nr.

5000 682 800

Dimension

ø95xø120x24

Description

Thrust Washer

C260/290
 R360 6X4->10/1983
 R310 6X4 JSQ 8/1984
 G 170/210/230/260/290
 S130/150T/170 (VF6JP)
 R370/390/420->1989
 R310/330/340/365 1984->
 M140/160/200/230
 AE380/385T/420T/500/520
 R 1990->1992 R 1983->
 C230/280/300/340T/CCH-300
 M/S 4X4 & INCENDIE
 ME/SE/CE/160/180/210
 MAXTER 6X4 8X4
 M/S 150/180/210/220/230T/250
 PS150/160
 G230/270 SP
 G220/270 BOM / 200/210/230T
 G MANAGER 6X2 & 6X4 / 4X2
 G340T TR 18T 6X6
 PREMIUM TR 4X2 ==>1999
 PREMIUM 6X2&6X2/4 ==>1999
 MAXTER 4X2-4X4
 AE MAGNUM390/420T/430/470/560

PREMIUM PR 4X2 ==> 1999
 KERAX==>1999
 PREMIUM 260 SP
 MIDLUM(FAB42B1 /2-43C1/2-43T/M)
 MAGNUM E-TECH 400/440/480
 PREMIUM TR 4X2 2000 ==>
 PREMIUM(FAB22E/H/J/Q/R)2000==>
 PREMIUM PR 4X2 (FAB22A)2000==>
 MIDLUM EXPORT (FAB 43E1-43E2)
 KERAX FAB 33A==>S 2000==>2002
 MIDLUM 42E3/4-44T/M/C-45D/E
 MIDLUM 4X4 47XA/47XC
 PREMIUM TRACTEUR 4X2(FAB 22CC)
 PREMIUM(FAB22EE/HA/HB/JJ/QQ/RR
 PREMIUM PR 4X2(FAB 22AA/AB)
 KERAX (FAB 33AA.././SS)
 KERAX (FAB33A../R) 2003==>
 MIDLUM CCF 4X4 (FAB 47XF)
 MACK MS200/250/300 1990->
 MACK CS200/250/300 1990->
 MIDLUM(FAB 42US-44US-45US)
 SISU
 PREMIUM 22C 071 ==> 1999



Sampa Nr.

080.217

O.E.M. Nr.

5010 368 906

Dimension

ø8,5/136.5x108x47.5

Description

Hub Cap

PREMIUM TR 4X2 ==>1999
 PREMIUM 6X2&6X2/4 ==>1999
 PREMIUM PR 4X2 ==> 1999

MAGNUM E-TECH 400/440/480
 PREMIUM(FAB22E/H/J/Q/R)2000==>
 PREMIUM(FAB22EE/HA/HB/JJ/QQ/RR



Sampa Nr.

080.218

O.E.M. Nr.

5010 368 902

Dimension

ø9/136.5x1.5

Description

Axle Gasket

PREMIUM TR 4X2 ==>1999
 PREMIUM 6X2&6X2/4 ==>1999
 PREMIUM PR 4X2 ==> 1999

MAGNUM E-TECH 400/440/480
 PREMIUM(FAB22E/H/J/Q/R)2000==>
 PREMIUM(FAB22EE/HA/HB/JJ/QQ/RR



Sampa Nr.

080.219

O.E.M. Nr.

7403 988 672

Dimension

M128x2/50xSW115

Description

Hub Cap

MAGNUM DXI 12-VAR-120AV
 PREMIUM DXI 11-FAB-27JC/TC

PREMIUM DXI 11-FAB-27RC/SC



Sampa Nr.

080.220

O.E.M. Nr.

7420 547 252

Dimension

M112x2/50xSW115

Description

Hub Cap

MAGNUM DXI 12-VAR-120AV
 PREMIUM DXI 11-FAB-27JC/TC

PREMIUM DXI 11-FAB-27RC/SC

Sampa Nr.

080.060

O.E.M. Nr.

5010 571 187



Dimension

ø124x52

Description

Hub Cap

PREMIUM TR 4X2 ==>1999
 AE MAGNUM390/420TI/430/470/560
 MAGNUM E-TECH 400/440/480
 PREMIUM TR 4X2 2000 ==>
 PREMIUM(FAB22E/H/J/Q/R)2000==>
 PREMIUM PR 4X2 (FAB22A)2000==>
 KERAX FAB 33A==>S 2000==>2002
 MIDLUM 42B3/4-44TA/C.-45D./E.
 PREMIUM TRACTEUR 4X2(FAB 22CC)
 PREMIUM(FAB22EE/HA/HB/JJ/QQ/RR
 PREMIUM PR 4X2 (FAB 22AA/AB)
 KERAX (FAB 33AA.././SS)
 KERAX (FAB33A.././R) 2003==>
 SISU

Sampa Nr.

080.067

O.E.M. Nr.

5010 224 222



Dimension

SW35/47

Description

Cap

TR/GR305 "G" MANAGER 6X2 & 6X4"
 TR/GR350 PREMIUM TR 4X2 ==>1999
 GB131/HR15 PREMIUM 6X2&6X2/4 ==>1999
 GB/TB191/231 MAXTER 4X2-4X4
 GC191/231 AE MAGNUM390/420TI/430/470/560
 GR191/231 PREMIUM PR 4X2 ==> 1999
 GR/TR280 KERAX ==> 1999
 R310 4X2 ->8/84 PREMIUM 260 SP
 R360 4X2 MAGNUM E-TECH 400/440/480
 PGC191/231 PREMIUM TR 4X2 2000 ==>
 G260/290 PREMIUM(FAB22E/H/J/Q/R)2000==>
 C260/290 PREMIUM PR 4X2 (FAB22A)2000==>
 S170 (FAB=SH) MIDLUM EXPORT (FAB 43E1-43E2)
 C210/CLR220 KERAX FAB 33A==>S 2000==>2002
 G170 MIDLUM 42B3/4-44TA/C.-45D./E.
 G210/230 MIDLUM 4X4 47XA/47XC
 S130/150TI (VF6JN) PREMIUM TRACTEUR 4X2(FAB 22CC)
 R370 JSQ 1984 PREMIUM(FAB22EE/HA/HB/JJ/QQ/RR
 R370/390/420 ==>1989 PREMIUM PR 4X2 (FAB 22AA/AB)
 R310/330/340/365 1984==> KERAX (FAB 33AA.././SS)
 CBH/CLM280/340 KERAX (FAB33A.././R) 2003==>
 G320 MIDLUM CCF 4X4 (FAB 47XF)
 AE380/385TI/420TI/500/520 MIDLUM(FAB 42US-44US-45US)
 MIDLINER GRANDE-BRETAGNE PREMIUM DXI 11 -FAB-27JC/TC
 "R" 1990==>1992" "R" 1993==>" PREMIUM DXI 11 -FAB-27RC/SC
 C230/280/300/340TI/CCH300 SISU
 MAXTER 6X4 8X4 PREMIUM 22C 071 ==> 1999
 "R" 1993==>"
 G220/270 BOM
 G200/210/230TI
 "G" MANAGER 4X2"

Sampa Nr.

075.065

O.E.M. Nr.

5000 815 713



Dimension

M56x2xSW85

Description

Axle Nut

Sampa Nr.

075.066

O.E.M. Nr.

5000 815 714



Dimension

ø56.5xø93x4.5

Description

Lock Washer

R370/390/420==>1989 "G" MANAGER 4x2
 R310/330/340/365 1984==> "G" MANAGER 6x2 & 6x4
 AE380/385TI/420TI500/520 AE MAGNUM 390/420
 "R"1990==>1992 TI/430/470/560
 "R" 1993==>

Sampa Nr.

030.262

O.E.M. Nr.

7420 399 428



Dimension

M93x3/ø106x31

Description

Cap for Steering Knuckle

MAGNUM DXI 12 -VAR-120AV
 PREMIUM DXI 11 -FAB-27JC/TC
 PREMIUM DXI 11 -FAB-27RC/SC

Wheel - Axle

	<p>Sampa Nr.</p> <p>080.509</p> <p>O.E.M. Nr.</p> <p>5000 793 849</p>		<p>Sampa Nr.</p> <p>080.510</p> <p>O.E.M. Nr.</p> <p>5000 793 828</p>
<p>Dimension</p> <p>ø46x280</p>		<p>Dimension</p> <p>ø40x241</p>	
<p>Description</p> <p>King Pin Set</p>		<p>Description</p> <p>King Pin Set</p>	
<p>GR191/231 GRH235/HF26 GRH/TRH305 GRH/TRH350 R310 4X2 ->8/84 R360 4X2 GBH/TBH280 1981-> GBH260/280 6X4 ->1980 GLC/GLR190/230 G260/290 C260/290 R360 6X4 -> 10/1983 R310 6X4 JSQ 8/1984 GLM/TLM280 C210/CLR220</p>	<p>G210/230 R370 JSQ 1984 R370/390/420 ->1989 R310/330/340/365 1984-> CBH/CLM280/340 G320 "R" 1990->1992" C230/280/300/340TI/CCH300 CBH/CLM 320/385 "R" 1993->" G220/270 BOM G200/210/230TI "G" MANAGER 4X2" "G" MANAGER 6X2 & 6X4"</p>	<p>GC191/231 GLC/GLR190/230 G260/290 G170 G210/230 G320 M140/160/200/230 MIDLINER GRANDE-BRETAGNE C230/280/300/340TI/CCH300</p>	<p>M/S 150/180/210/220/230TI/250 G230/270 SP G220/270 BOM G200/210/230TI "G" MANAGER 4X2" "G" MANAGER 6X2 & 6X4" G340TI TR 18T PG230/280</p>
	<p>Sampa Nr.</p> <p>080.511</p> <p>O.E.M. Nr.</p> <p>5000 794 320</p>		<p>Sampa Nr.</p> <p>080.512</p> <p>O.E.M. Nr.</p> <p>5000 336 305</p>
<p>Dimension</p> <p>ø46x280</p>		<p>Dimension</p> <p>ø35x178.5</p>	
<p>Description</p> <p>King Pin Set, Single</p>		<p>Description</p> <p>King Pin Set</p>	
	<p>Sampa Nr.</p> <p>080.511/1</p> <p>O.E.M. Nr.</p> <p>5000 794 320 S</p>	<p>JE13/15 JP11/13 JR/JX19/21 S170 (FAB=SH) S130/150TI/170 (VF6JP)</p>	<p>M/S 4X4 & INCENDIE ME/SE/CE/ 160/180/210 PS150/160 MACK MS200/250/300 1990-> MACK CS200/250/300 1990-></p>
<p>Dimension</p> <p>ø46x280</p>		<p>Dimension</p> <p>ø30x167</p>	
<p>Description</p> <p>King Pin Set, Double</p>		<p>Description</p> <p>King Pin Set</p>	
<p>GR191/231 GRH235/HF26 GRH/TRH305 GRH/TRH350 R310 4X2 ->8/84 R360 4X2 GBH/TBH280 1981-> GBH260/280 6X4 ->1980 GLC/GLR190/230 G260/290</p>	<p>C260/290 R360 6X4 -> 10/1983 R310 6X4 JSQ 8/1984 GLM/TLM280 C210/CLR220 G210/230 R370 JSQ 1984 R370/390/420 ->1989 R310/330/340/365 1984-> CBH/CLM280/340</p>	<p>JN55/60/85 S130/150TI (VF6JN) S100 MIDLINER GRANDE-BRETAGNE S140/160</p>	<p>M/S 150/180/210/220/230TI/250 PS150/160 S120/135 S135/150 (MOT 040226)</p>

Sampa Nr.

080.516

O.E.M. Nr.

5000 556 940



Dimension

M24x1.5/ø30xø38.2x257.5

Description

King Pin Set

ESSA5720
ESSA5731
S45/53/53RH/53RX/100/105R

Sampa Nr.

080.517

O.E.M. Nr.

**5000 784 185
(5000 794 319)**



Dimension

ø40x236

Description

King Pin Set

GC191/231 G170
TF231D G210/230
GF151D G230/270 SP
PGC191/231
GLC/GLR190/230
G260/290

Sampa Nr.

080.533

O.E.M. Nr.

5000 793 641



Dimension

ø28x153.5

Description

King Pin Set

JK55/60/65/75
S110/130 (VF6JK)
S100
MIDLINER GRANDE-BRETAGNE
S140/160
M/S 150/180/210/220/230TI/250
S120/135
S135/150 (MOT 040226)

Sampa Nr.

080.537

O.E.M. Nr.

0000 323 906



Dimension

ø30x213

Description

King Pin Set

Sampa Nr.

080.538

O.E.M. Nr.

5010 216 742 S



Dimension

ø50x236

Description

King Pin Set

AE420TI
AE520
PREMIUM TR 4x2 2000 —>

Sampa Nr.

080.539

O.E.M. Nr.

5010 056 002 S



Dimension

ø50x225

Description

King Pin Set

G260/290
R370/390/420 —> 1989
AE380/385TI/420TI/500/520
BUS TRACER
PR112/118
PREMIUM (6x2) (6x2/4) —> 1989
PREMIUM (FAB 22E/H/J/Q/R) 2000 —>
MAXTER (4x2) (4X4) (6x4) (8x4)
KERAX

Wheel - Axle



Sampa Nr.

080.540

O.E.M. Nr.

5001 836 749

Dimension

ø27.5/ø28x153

Description

King Pin Set

B70
B90
B80/110/120



Sampa Nr.

080.541

O.E.M. Nr.

5000 793 360

Dimension

ø27.5/ø28x153

Description

King Pin Set

B70
J35/48/55/60



Sampa Nr.

080.560

O.E.M. Nr.

5000 793 139

Dimension

ø35x224

Description

King Pin Set

GB131/HR15
GB/TB191/231
G260/290
G170



Sampa Nr.

080.561

O.E.M. Nr.

0000 323 944

Dimension

ø35x242

Description

King Pin Set

GB131/HR15
GB/TB191/231

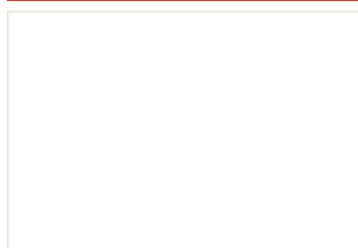

Sampa Nr.

O.E.M. Nr.

Dimension

Description

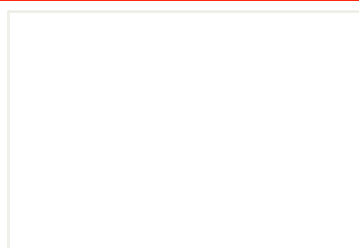

Sampa Nr.

O.E.M. Nr.

Dimension

Description

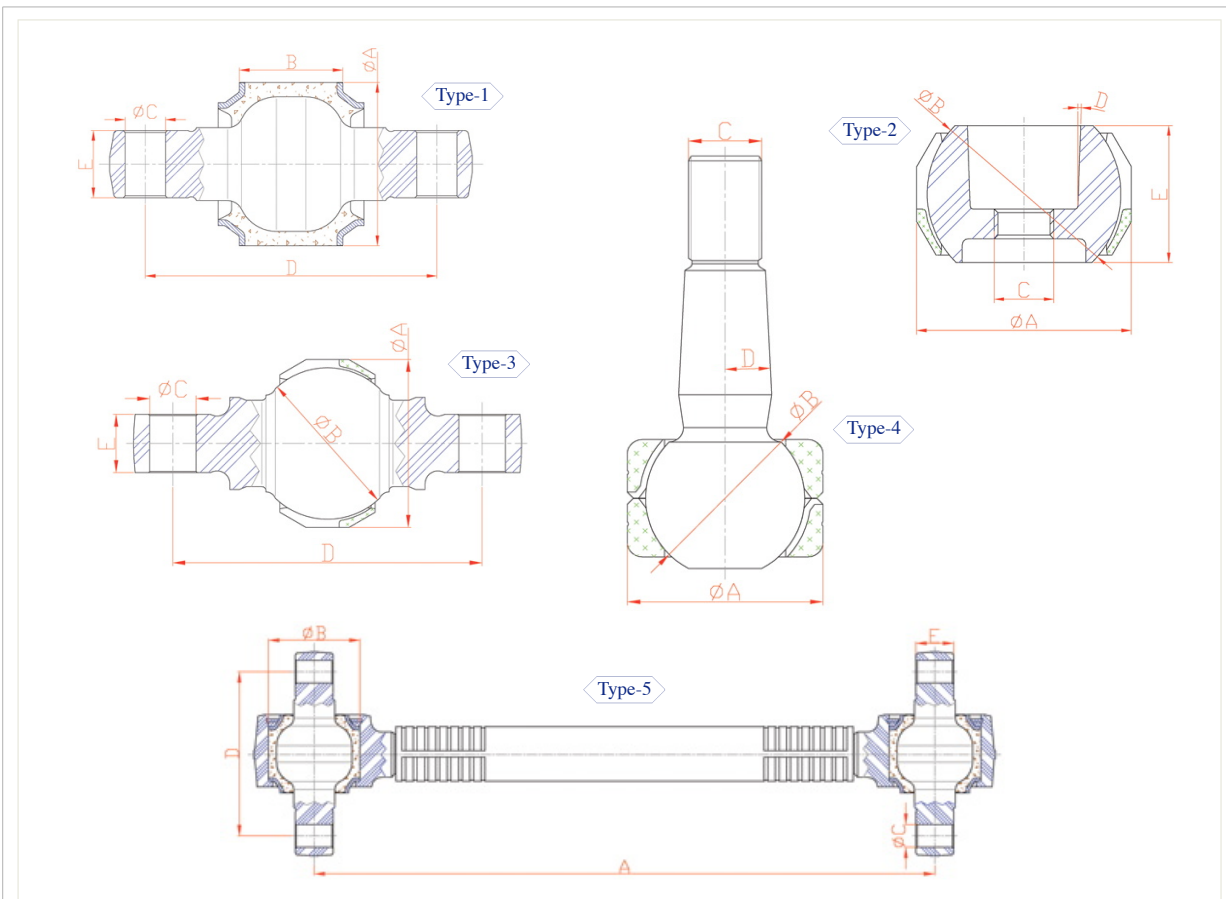

Sampa Nr.	O.E.M. Nr.	A	B	C	D	E	Repair Kit	Type
010.668	5001 836 091	ø75	48	ø19	130	24	-	1
010.578	5001 842 823	ø85	54	ø19	130	30	-	1
080.504	5000 802 123	ø85	54	ø19	145	30	-	1
080.542	5001 842 337	ø85	54	ø21	152	35	-	1
020.512	5001 014 520	ø72	ø65	M20x1.5	2°52'	46	-	2
080.507	0063 241 000	ø72	ø65	ø20	133	24	-	3
080.570	0003 404 170	ø72	ø65	ø19	145	30	-	3
010.534	0003 404 168	ø80	ø65	ø21	152	24	-	3
020.502	7701 011 267	ø80	ø65	ø19	130	30	-	3
080.505	5001 014 345	ø80	ø65	ø19	145	30	-	3
080.536	5001 832 613	ø80	ø65	M30x2	2°52'	-	-	4
080.543	5001 823 280	ø90	ø80	ø21	152	35	-	3
095.242	5010 094 839	575	ø90	ø21	152	35	080.543	5
095.243	5010 467 915	575	ø85	ø21	152	35	080.542	5
095.244	5010 094 941	575	ø80	ø19	145	30	080.505	5
095.245	5010 268 035	575	ø85	ø19	145	30	080.504	5

V-Stay - Axle Control Arm



Sampa Nr.

050.090

O.E.M. Nr.

5010 294 576

Dimension

ø90,5x73

Description

Axle Rod Mounting

MAXTER 6X4 8X4
 KERAX ==> 1999
 KERAX FAB 33A==>S 2000==>2002
 KERAX (FAB 33AAV.././SS)



Sampa Nr.

080.222

O.E.M. Nr.

5001 829 737

Dimension

ø17/122xø72x67/116

Description

Axle Rod Mounting

AE380/385TI/420TI/500/520
 R 1993—>
 AE MAGNUM390/420TI/430/470/560



Sampa Nr.

080.223

O.E.M. Nr.

5010 294 577

Dimension

ø21/135xø90,5x70/170

Description

Axle Rod Mounting

MAXTER 6X4 8X4
 KERAX==>1999
 KERAX FAB 33A==>S 2000==>2002
 KERAX (FAB 33AAV.././SS)



Sampa Nr.

010.668

O.E.M. Nr.

5001 836 091

Dimension

ø75xø19x130

Description

Rep. Kit for Axle Rod



Sampa Nr.

080.504

O.E.M. Nr.

5000 802 123
(5001 831 526)*Dimension*

ø85xø19x145

Description

Rep. Kit for Axle Rod

GRH/TRH305
 GRH/TRH350



Sampa Nr.

095.245

O.E.M. Nr.

5010 268 035

Dimension

575

Description

Tie Rod

CBH/CLM 320/385

Sampa Nr.

010.578

O.E.M. Nr.

5001 842 823



Dimension

ø85xø19x130

Description

Rep. Kit for Axle Rod

Sampa Nr.

020.512

O.E.M. Nr.

5001 014 520



Dimension

M20x1.5/ø72x46

Description

Rep. Kit for Axle Rod

Sampa Nr.

080.542

O.E.M. Nr.

5001 842 337



Dimension

ø85xø21x152

Description

Rep. Kit for Axle Rod

KERAX ==> 1999
 KERAX FAB 33A==>S 2000==>2002
 KERAX (FAB 33AA/././SS)
 KERAX (FAB33A/./R) 2003==>
 KERAX 33G ARMEE BANGLADESH
 KERAX 33K ARMEE BANGLADESH

Sampa Nr.

080.570

O.E.M. Nr.

0003 404 170



Dimension

ø72xø19x145

Description

Rep. Kit for Axle Rod, With Bolt

GBH260/280 6X4 —>1980

Sampa Nr.

095.243

O.E.M. Nr.

5010 467 915



Dimension

575

Description

Tie Rod

KERAX FAB 33A==>S 2000==>2002)
 KERAX (FAB 33AA/././SS)
 KERAX (FAB33A/./R) 2003==>
 KERAX 33G ARMEE BANGLADESH
 KERAX 33K ARMEE BANGLADESH

Sampa Nr.

080.570/1

O.E.M. Nr.

5000 819 415



Dimension

ø72

Description

Rep. Kit for Axle Rod, Without Bolt

GBH260/280 6X4 —>1980

V-Stay - Axle Control Arm



Sampa Nr.

080.507

O.E.M. Nr.

0063 241 000

Dimension

ø72xø20x133

Description

Rep. Kit for Axle Rod, With Bolt

C 38/38 T
C 3064
C 3464
C 3864 R



Sampa Nr.

080.505

O.E.M. Nr.

5001 014 345

Dimension

ø80xø19x145

Description

Rep. Kit for Axle Rod, With Bolt

GBH260/280 6X6	"R" 1993—>"
CBH/CLM280/340	"G" MANAGER 6X2 & 6X4"
AE380/385TI/420TI/500/520	AE MAGNUM390/420TI/430/470/560
"R" 1990—>1992"	KERAX ==> 1999
C230/280/300/340TI/CCH300	MAGNUM E-TECH 400/440/480
CBH/CLM 320/385	KERAX FAB 33A==>S 2000==>2002

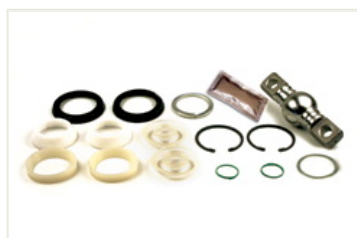

Sampa Nr.

010.534

O.E.M. Nr.

0003 404 168

Dimension

ø80xø21x152

Description

Rep. Kit for Axle Rod, With Bolt

GBH260/280 6X6
GBH260/280 6X4 —>1980



Sampa Nr.

080.505/1

O.E.M. Nr.

5001 014 424

Dimension

ø80

Description

Rep. Kit for Axle Rod, Without Bolt

GBH260/280 6X6	"R" 1993—>"
CBH/CLM280/340	"G" MANAGER 6X2 & 6X4"
AE380/385TI/420TI/500/520	AE MAGNUM390/420TI/430/470/560
"R" 1990—>1992"	KERAX ==> 1999
C230/280/300/340TI/CCH300	MAGNUM E-TECH 400/440/480
CBH/CLM 320/385	KERAX FAB 33A==>S 2000==>2002



Sampa Nr.

010.534/1

O.E.M. Nr.

5000 819 413

Dimension

ø80

Description

Rep. Kit for Axle Rod, Without Bolt

GRH235/HF26	R360 6X4 —> 10/1983
GRH/TRH305	R310 6X4 JSQ 8/1984
GRH/TRH350	R370 JSQ 1984
GBH/TBH280 1981—>	R370/390/420 —>1989
GBH260/280 6X6	R310/330/340/365 1984—>
GBH260/280 6X4 —>1980	CBH/CLM280/340
G260/290	
C260/290	



Sampa Nr.

095.244

O.E.M. Nr.

5010 094 941

(0023 123 253)

(5000 783 574)

(5010 064 641)

(5010 094 838)

Dimension

575

Description

Tie Rod

GRH235/HF26	CBH/CLM280/340
GRH/TRH305	AE380/385TI/420TI/500/520
GRH/TRH350	"R" 1990—>1992"
GBH/TBH280 1981—>	C230/280/300/340TI/CCH300
GBH260/280 6X6	CBH/CLM 320/385
G260/290	"R" 1993—>"
C260/290	"G" MANAGER 6X2 & 6X4"
R360 6X4 —> 10/1983	AE MAGNUM390/420TI/430/470/560
R310 6X4 JSQ 8/1984	KERAX ==> 1999
R370 JSQ 1984	MAGNUM E-TECH 400/440/480
R370/390/420 —>1989	KERAX FAB 33A==>S 2000==>2002
R310/330/340/365 1984—>	

Sampa Nr.

020.502

O.E.M. Nr.

7701 011 267



Dimension

ø80xø19x130

Description

Rep. Kit for Axle Rod, With Bolt

Sampa Nr.

080.543

O.E.M. Nr.

5001 823 280



Dimension

ø90xø21x152

Description

Rep. Kit for Axle Rod, With Bolt

MAXTER 6X4 8X4
G340TI 6X6
KERAX ==> 1999
KERAX FAB 33A==>S 2000==>2002
KERAX (FAB 33AA/././SS)
KERAX (FAB33A/./R) 2003==>

Sampa Nr.

080.518

O.E.M. Nr.

5000 819 414



Dimension

ø90

Description

Rep. Kit for Axle Rod, Without Bolt

GBH260/280 6X6
GBH260/280 6X4 —>1980

Sampa Nr.

080.543/1

O.E.M. Nr.

5001 823 279



Dimension

ø90

Description

Rep. Kit for Axle Rod, Without Bolt

MAXTER 6X4 8X4
G340TI 6X6
KERAX ==> 1999
KERAX FAB 33A==>S 2000==>2002
KERAX (FAB 33AA/././SS)
KERAX (FAB33A/./R) 2003==>

Sampa Nr.

080.536

O.E.M. Nr.

5001 832 613
(4090 435 642)



Dimension

M30x2/ø80x169.5

Description

Rep. Kit for Axle Rod, With Bolt

Sampa Nr.

095.242

O.E.M. Nr.

5010 094 839

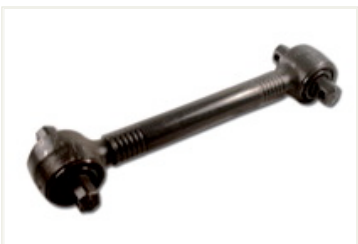

Dimension

575

Description

Tie Rod

MAXTER 6X4 8X4
G340TI 6X6
KERAX ==> 1999
KERAX FAB 33A==>S 2000==>2002
KERAX (FAB 33AA/././SS)
KERAX (FAB33A/./R) 2003==>

Engine - Flywheel



Sampa Nr.

080.066

O.E.M. Nr.

5010 130 072

Dimension

ø28xø99x65

Description

Rubber Mounting for Engine Suspension

C230/280/300/340TI/CCH300
MAXTER 6X4 8X4
PS150/160
G200/210/230TI
"G" MANAGER 4X2"
"G" MANAGER 6X2 & 6X4"
G340TI 6X6
G340TI 4X4
MAXTER 4X2-4X4
KERAX ==> 1999
PA200/210

PG230/280
MIDLUM(FAB42B1/2-43C1/2-43T/V)
MIDLUM EXPORT (FAB 43E1-43E2)
KERAX FAB 33A==>S 2000==>2002
KERAX (FAB 33AAV././SS)
KERAX (FAB33A././R) 2003==>
MACK MS200/250/300 1990—>
MACK CS200/250/300 1990—>
KERAX 33G ARMEE BANGLADESH
KERAX 33K ARMEE BANGLADESH



Sampa Nr.

080.558

O.E.M. Nr.

Dimension

ø28xø99x65

Description

Rep. Kit for Engine Mounting

KERAX ==> 1999
KERAX FAB 33A==>S 2000==>2002

KERAX (FAB 33AAV././SS)
KERAX (FAB33A././R) 2003==>



Sampa Nr.

080.131

O.E.M. Nr.

5000 704 265

Dimension

ø27xø80x30

Description

Rubber Mounting for Engine Suspension

GBH/TBH280 1981—>
GBH260/280 6X6
G260/290
GLM/TLM280
CBH/CLM280/340
AE380/385TI/420TI/500/520
C230/280/300/340TI/CCH300
MAXTER 6X4 8X4
CBH/CLM 320/385
PS150/160
G200/210/230TI
"G" MANAGER 4X2"
"G" MANAGER 6X2 & 6X4"
G340TI 6X6
G340TI 4X4
G340TI TR 18T
PREMIUM TR 4X2 ==>1999

PREMIUM 6X2&6X2/4 ==>1999
MAXTER 4X2-4X4
AE MAGNUM390/420TI/430/470/560
PREMIUM PR 4X2 ==> 1999
KERAX ==> 1999
PA200/210 PREMIUM 260 SP
PG230/280
MIDLUM(FAB42B1/2-43C1/2-43T/V)
MIDLUM EXPORT (FAB 43E1-43E2)
KERAX FAB 33A==>S 2000==>2002
KERAX (FAB 33AAV././SS)
KERAX (FAB33A././R) 2003==>
MACK MS200/250/300 1990—>
MACK CS200/250/300 1990—>
KERAX 33G ARMEE BANGLADESH
KERAX 33K ARMEE BANGLADESH



Sampa Nr.

080.100

O.E.M. Nr.

5010 239 498

Dimension

ø28xø106x64

Description

Rubber Mounting for Engine Suspension

AE380/385TI/420TI/500/520
G340TI TR 18T
PREMIUM TR 4X2 ==>1999
PREMIUM 6X2&6X2/4 ==>1999

AE MAGNUM390/420TI/430/470/560
PREMIUM PR 4X2 ==> 1999
PREMIUM 260 SP



Sampa Nr.

080.552

O.E.M. Nr.

Dimension

ø28xø106x64

Description

Rep. Kit for Engine Mounting

AE380/385TI/420TI/500/520
AE MAGNUM390/420TI/430/470/560

Sampa Nr.

O.E.M. Nr.

Dimension

Description

Sampa Nr.

080.131

O.E.M. Nr.

5000 704 265



Dimension

ø27xø80x30

Description

Rubber Mounting for Engine Suspension

GBH/TBH280 1981—>	PREMIUM 6X2&6X2/4 ==>1999
GBH260/280 6X6	MAXTER 4X2-4X4
G260/290	AE MAGNUM390/420TI/430/470/560
GLM/TLM280	PREMIUM PR 4X2 ==> 1999
CBH/CLM280/340	KERAX ==> 1999
AE380/385TI/420TI/500/520	PA200/210 PREMIUM 260 SP
C230/280/300/340TI/CCH300	PG230/280
MAXTER 6X4 8X4	MIDLUM(FAB42B1/2-43C1/2-43T/V)
CBH/CLM 320/385	MIDLUM EXPORT (FAB 43E1-43E2)
PS150/160	KERAX FAB 33A==>S 2000==>2002
G200/210/230TI	KERAX (FAB 33AA/././SS)
"G" MANAGER 4X2"	KERAX (FAB33A/././R) 2003==>
"G" MANAGER 6X2 & 6X4"	MACK MS200/250/300 1990—>
G340TI 6X6	MACK CS200/250/300 1990—>
G340TI 4X4	KERAX 33G ARMEE BANGLADESH
G340TI TR 18T	KERAX 33K ARMEE BANGLADESH
PREMIUM TR 4X2 ==>1999	

Sampa Nr.

080.155

O.E.M. Nr.

5000 704 264



Dimension

ø27.5xø100x64

Description

Rubber Mounting for Engine Suspension

GBH/TBH280 1981—>	CBH/CLM280/340
GBH260/280 6X6	CBH/CLM 320/385
G260/290	"G" MANAGER 4X2"
GLM/TLM280	"G" MANAGER 6X2 & 6X4"

Sampa Nr.

080.575

O.E.M. Nr.



Dimension

ø27.5xø100x64

Description

Rep. Kit for Engine Mounting

GBH/TBH280 1981—>	GLM/TLM280
GBH260/280 6X6	CBH/CLM280/340

Sampa Nr.

080.065

O.E.M. Nr.

5010 094 716



Dimension

M20x2.5/97/70 ShA

Description

Engine Mounting

CBH/CLM280/340
AE380/385TI/420TI/500/520
CBH/CLM 320/385
AE MAGNUM390/420TI/430/470/560
MAGNUM E-TECH 400/440/480
SISU

Sampa Nr.

080.138

O.E.M. Nr.

5010 130 602



Dimension

M20x2.5/97/50 ShA

Description

Engine Mounting

AE380/385TI/420TI/500/520
AE MAGNUM390/420TI/430/470/560

Sampa Nr.

080.068

O.E.M. Nr.

5010 316 158



Dimension

159x255x95

Description

Engine Mounting

AE MAGNUM390/420TI/430/470/560
MAGNUM E-TECH 400/440/480
SISU

Engine - Flywheel



Sampa Nr.

080.069

O.E.M. Nr.

5010 316 680

Dimension

132x369x130

Description

Engine Mounting, Left

PREMIUM TR 4X2 2000 ==>
 PREMIUM(FAB22E/H/J/Q/R)2000==>
 PREMIUM TRACTEUR 4X2(FAB 22CC)
 PREMIUM(FAB22EE/HA/HB/JJ/QQ/RR)
 PREMIUM PR 4X2 (FAB 22AA/AB)
 PREMIUM 22C 071 ==> 1999



Sampa Nr.

080.070

O.E.M. Nr.

5010 316 681

Dimension

132x369x130

Description

Engine Mounting, Right

PREMIUM TR 4X2 2000 ==>
 PREMIUM(FAB22E/H/J/Q/R)2000==>
 PREMIUM TRACTEUR 4X2(FAB 22CC)
 PREMIUM(FAB22EE/HA/HB/JJ/QQ/RR)
 PREMIUM PR 4X2 (FAB 22AA/AB)
 PREMIUM 22C 071 ==> 1999



Sampa Nr.

080.072

O.E.M. Nr.

5010 460 352

Dimension

132x369x130

Description

Engine Mounting, Right

PREMIUM TR 4X2 2000 ==>
 PREMIUM(FAB22E/H/J/Q/R)2000==>
 PREMIUM PR 4X2 (FAB22A)2000==>

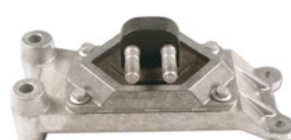

Sampa Nr.

080.151

O.E.M. Nr.

5010 460 351

Dimension

132x369x130

Description

Engine Mounting, Left

PREMIUM TR 4X2 2000 ==>
 PREMIUM(FAB22E/H/J/Q/R)2000==>
 PREMIUM PR 4X2 (FAB22A)2000==>

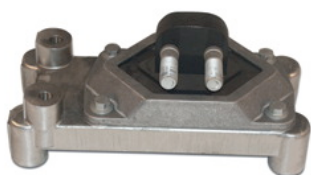

Sampa Nr.

080.170

O.E.M. Nr.

5010 460 353

Dimension

150x315x155

Description

Engine Mounting, Left

PREMIUM PR 4X2 ==> 1999
 PREMIUM 260 SP
 PREMIUM PR 4X2 (FAB22A)2000==>



Sampa Nr.

080.171

O.E.M. Nr.

5010 460 354

Dimension

150x315x155

Description

Engine Mounting, Right

PREMIUM PR 4X2 ==> 1999
 PREMIUM 260 SP
 PREMIUM PR 4X2 (FAB22A)2000==>

Sampa Nr.

080.172

O.E.M. Nr.

5010 460 240

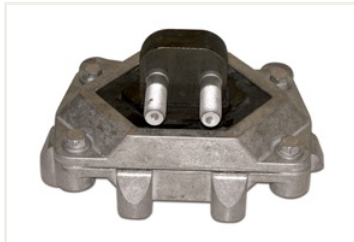

Dimension

180x250x140

Description

Engine Mounting, Left

KERAX(FAB 33AA.././SS)

Sampa Nr.

080.173

O.E.M. Nr.

5010 460 241



Dimension

180x250x140

Description

Engine Mounting, Right

KERAX(FAB 33AA.././SS)

Sampa Nr.

080.162

O.E.M. Nr.

5010 316 591



Dimension

ø20/160x106

Description

Engine Mounting, Left

PREMIUM TR 4X2 2000 ==>
PREMIUM TRACTEUR 4X2(FAB 22CC)
PREMIUM(FAB22EE/HA/HB/JJ/QQ/RR)
PREMIUM PR 4X2 (FAB 22AA/AB)
PREMIUM 22C 071 ==> 1999

Sampa Nr.

080.163

O.E.M. Nr.

5010 316 592



Dimension

ø20/160x106

Description

Engine Mounting, Right

PREMIUM TR 4X2 2000 ==>
PREMIUM TRACTEUR 4X2(FAB 22CC)
PREMIUM(FAB22EE/HA/HB/JJ/QQ/RR)
PREMIUM PR 4X2 (FAB 22AA/AB)
PREMIUM 22C 071 ==> 1999

Sampa Nr.

080.164

O.E.M. Nr.

5010 316 521



Dimension

ø20/160x106

Description

Engine Mounting, Left

PREMIUM TR 4X2 ==>1999
PREMIUM 6X2&6X2/4 ==>1999
PREMIUM PR 4X2 ==> 1999
PREMIUM 260 SP
PREMIUM TR 4X2 2000 ==>
PREMIUM(FAB22E/H/J/Q/R)2000==>
PREMIUM PR 4X2 (FAB22A)2000==>
PREMIUM 22C 071 ==> 1999

Sampa Nr.

080.165

O.E.M. Nr.

5010 316 522



Dimension

ø20/160x106

Description

Engine Mounting, Right

PREMIUM TR 4X2 ==>1999
PREMIUM 6X2&6X2/4 ==>1999
PREMIUM PR 4X2 ==> 1999
PREMIUM 260 SP
PREMIUM TR 4X2 2000 ==>
PREMIUM(FAB22E/H/J/Q/R)2000==>
PREMIUM PR 4X2 (FAB22A)2000==>
PREMIUM 22C 071 ==> 1999

Engine - Flywheel



Sampa Nr.

080.166

O.E.M. Nr.

5010 460 294

Dimension

ø20/160x106

Description

Engine Mounting, Left

PREMIUM TR 4X2 2000 ==>
 PREMIUM(FAB22E/H/J/Q/R)2000==>
 PREMIUM TRACTEUR 4X2(FAB 22CC)
 PREMIUM(FAB22EE/HA/HB/JJ/QQ/RR)
 PREMIUM PR 4X2 (FAB 22AA/AB)



Sampa Nr.

080.167

O.E.M. Nr.

5010 460 295

Dimension

ø20/160x116

Description

Engine Mounting, Right

PREMIUM TR 4X2 2000 ==>
 PREMIUM(FAB22E/H/J/Q/R)2000==>
 PREMIUM TRACTEUR 4X2(FAB 22CC)
 PREMIUM(FAB22EE/HA/HB/JJ/QQ/RR)
 PREMIUM PR 4X2 (FAB 22AA/AB)



Sampa Nr.

080.168

O.E.M. Nr.

5010 316 573

Dimension

ø20/160x106

Description

Engine Mounting, Left

PREMIUM PR 4X2==> 1999
 PREMIUM PR 4X2(FAB22A)2000==>



Sampa Nr.

080.169

O.E.M. Nr.

5010 316 574

Dimension

ø20/160x106

Description

Engine Mounting, Right

PREMIUM PR 4X2==> 1999
 PREMIUM PR 4X2(FAB22A)2000==>



Sampa Nr.

080.071

O.E.M. Nr.

5010 316 876

Dimension

M10/M12x46

Description

Engine Mounting

MIDLINER GRANDE-BRETAGNE MACK MS200/250/300 1990—>
 MS 4X4 & INCENDIE MACK CS200/250/300 1990—>
 MS 150/180/210/220/230TI/250
 S135/150 (MOT 040226)
 MS300 SUDAMERICA
 MIDLUM(FAB42B1/2-43C1/2-43T/V)
 MIDLUM EXPORT (FAB 43E1-43E2)

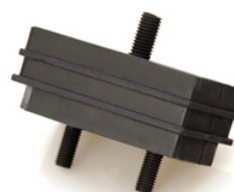

Sampa Nr.

080.148

O.E.M. Nr.

5010 467 526

Dimension

M10/M12x46

Description

Engine Mounting

MAXTER 6X4 8X4
 "G" MANAGER 4X2"
 "G" MANAGER 6X2 & 6X4"
 G340TI 6X6
 G340TI 4X4
 MAXTER 4X2-4X4
 KERAX ==> 1999

KERAX FAB 33A==>S 2000==>2002
 KERAX (FAB33A././R) 2003==>
 KERAX 33G ARMEE BANGLADESH
 KERAX 33K ARMEE BANGLADESH

Sampa Nr.
080.116

O.E.M. Nr.
5000 748 630



Dimension
ø16x72

Description
Engine Mounting

TR/GR305 R310/330/340/365 1984—>
GR/TR280 "R" 1990—>1992
GRH/TRH305 "R" 1993—>
R310 4X2 ->8/84
R310 6X4 JSQ 8/1984

Sampa Nr.
080.161

O.E.M. Nr.
5000 788 730



Dimension
ø19/ø35xø62/ø75x79.5

Description
Engine Mounting

TR/GR305 GLR230 4X4 SINPAR
GR/TR280 R370/390/420->1989
GRH/TRH305 R310/330/340/365 1984—>
R310 4X2—>8/84 R 1990—>1992
GLC/GLR190/230 R 1993—>
R310 6X4 JSQ 8/1984

Sampa Nr.
080.174

O.E.M. Nr.
5000 750 515



Dimension
ø22.5xø75x90

Description
Engine Mounting

GB131/HR15 M140/160/200/230
GF151D MIDLINER GRANDE-BRETAGNE
PJK/PJN/PJP S140/160
JE13/15 M/S 4X4 & INCENDIE
JN55/60/85 ME/SE/CE/160/180/210
JP11/13 M/S 150/180/210/220/230TI/250
JK55/60/65/75 PS150/160
JR/JX19/21 G200/210/230TI
S170 (FAB=SH) M210 4X4
J&S4X4->5/1991 MS300 SUDAMERICA
G170 MIDLUM(FAB42B1 /2-43C1 /2-43T/V)
S130/150TI (VF6JN) MIDLUM EXPORT (FAB 43E1-43E2)
S130/150TI/170 (VF6JP) MACK MS200/250/300 1990—>
S110/130(VF6JK) MACK CS200/250/300 1990—>

Sampa Nr.
080.248

O.E.M. Nr.
-



Dimension
ø16/ø32x58/70 ShA

Description
Engine Mounting

Sampa Nr.
080.255

O.E.M. Nr.
0945 331 007



Dimension
ø16/ø32x58/60 ShA

Description
Engine Mounting

GB/TB191/231	GLC/GLR190/230	G230/270 SP
GC191/231	G260/290	G220/270 BOM
GR191/231	GLR230 4X4 SINPAR	G MANAGER 4X2
GRH235/HF26	G210/230	G MANAGER 6X2 &
TF231D	770KB6 SP	6X4
PGC191/231	G320	PG230/280

Sampa Nr.
080.251

O.E.M. Nr.
0000 250 074



Dimension
ø30xø86x120

Description
Engine Mounting

Sampa Nr.
080.254

O.E.M. Nr.
0000 482 344



Dimension
ø100xø130x130

Description
Filter Hose

GBH260/280 6X4 —>1980

Propeller Shaft - Clutch



Sampa Nr.

080.123

O.E.M. Nr.

5000 589 888

Dimension

ø50

Description

Propeller Shaft Bearing

TR/GR305	R310 4X2 ->8/84	G170
GR191/231	G260/290	G210/230
GR/TR280	C260/290	



Sampa Nr.

080.139

O.E.M. Nr.

5000 242 914

Dimension

ø45

Description

Propeller Shaft Bearing

GB131/HR15	C210/CLR220
GB/TB191/231	G170
GC191/231	G210/230
GR191/231	S130/150TI/170 (VF6JP)
GF151D	M140/160/200/230
PJK/PJN/PJP	MIDLINER GRANDE-BRETAGNE
PGC191/231	S140/160
GLC/GLR190/230	C230/280/300/340TI/CCH300
JE13/15	ME/SE/CE/ 160/180/210
C260/290	PS150/160
JP11/13	S120/135
JR/JX19/21	S135/150 (MOT 040226)
S170 (FAB=SH)	MIDLUM(FAB42B1/2-43C1/2-43T/V)
GLR230 4X4 SINPAR	



Sampa Nr.

080.056

O.E.M. Nr.

5000 677 320

Dimension

M16x2/ø44x60

Description

Ball Joint

GBH/TBH280 1981—>	MAXTER 6X4 8X4
GBH260/280 6X6	CBH/CLM 320/385
G260/290	"R" 1993—>
C260/290	G230/270 SP
GLM/TLM280	G220/270 BOM
R370/390/420 —>1989	"G" MANAGER 4X2"
R310/330/340/365 1984—>	"G" MANAGER 6X2 & 6X4"
CBH/CLM280/340	G340TI 6X6
G320	G340TI 4X4
AE380/385TI/420TI/500/520	G340TI TR 18T
"R" 1990—>1992"	MAXTER 4X2-4X4
C230/280/300/340TI/CCH300	PG230/280

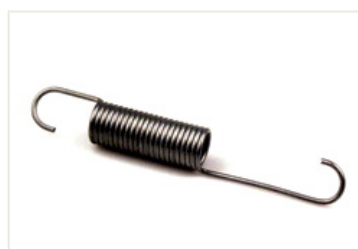

Sampa Nr.

080.230

O.E.M. Nr.

0000 165 918

Dimension

ø20x145

Description

Return Spring

TR/GR305	GBH/TBH280 1981—>
TR/GR350	PGC191/231
GB/TB191/231	GBH260/280 6X6
GC191/231	GBH260/280 6X4->1980
GR191/231	GLC/GLR190/230
GRH235/HF26	R360 6X4->10/1983
GR/TR280	R310 6X4 JSQ 8/1984
GRH/TRH305	GLM/TLM280
GRH/TRH350	GLR230 4X4 SINPAR
TF231D	770KB6 SP
R310 4X2—>8/84	G230/270 SP
R360 4X2	



Sampa Nr.

080.057

O.E.M. Nr.

5000 787 873

Dimension

ø44x17

Description

Ball Joint Bearing

R310 4X2 ->8/84
R360 4X2
GBH/TBH280 1981—>
GBH260/280 6X6
G260/290
C260/290
R360 6X4 —> 10/1983
R310 6X4 JSQ 8/1984
GLM/TLM280
R370 JSQ 1984
R370/390/420 —>1989
R310/330/340/365 1984—>
CBH/CLM280/340
G320
AE380/385TI/420TI/500/520
"R" 1990—>1992"
C230/280/300/340TI/CCH300
MAXTER 6X4 8X4
CBH/CLM 320/385
"R" 1993—>
G230/270 SP
G220/270 BOM
"G" MANAGER 4X2"
"G" MANAGER 6X2 & 6X4"
G340TI 6X6
G340TI 4X4
G340TI TR 18T
MAXTER 4X2-4X4
PG230/280

Sampa Nr.

080.153

O.E.M. Nr.

0023 535 072



Dimension

M14/ø80x66

Description

Gearbox Mounting

GR/TR280	G260/290
GBH/TBH280 1981—>	GLM/TLM280
GBH260/280 6X6	CBH/CLM280/340
GBH260/280 6X4 —>1980	CBH/CLM 320/385

Sampa Nr.

080.076

O.E.M. Nr.

5010 242 799

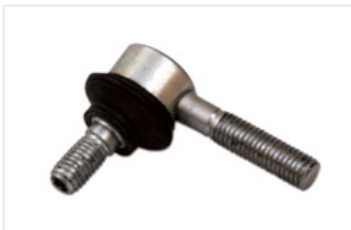

Dimension

M10x1.5

Description

Ball Joint

G210/230/260/290/320	AE MAGNUM390/420TI/430/470/560
AE380/385TI/420TI/500/520	PREMIUM PR 4X2 ==> 1999
"R" 1990—>1992"	KERAX ==> 1999
MAXTER 4X2-4X4-6X4-8X4	PG230/280
M/S 150/180/210/220/230TI/250	MIDLUM(FAB42B1/2-43C1/2-43T/V)
"R" 1993—>	PREMIUM TR 4X2 2000 ==>
G220/270 BOM	PREMIUM(FAB22E/H/J/Q/R)2000==>
G200/210/230TI	PREMIUM PR 4X2 (FAB22A)2000==>
"G" MANAGER "4X2 & 6X2 & 6X4"	MIDLUM EXPORT (FAB 43E1-43E2)
G340TI 6X6 / 4x4	MIDLUM 42B3/4-44T/V/C.-45D/E.
G340TI TR 18T	MACK MS200/250/300 1990—>
PREMIUM TR 4X2 ==>1999	SISU
PREMIUM 6X2&6X2/4 ==>1999	PREMIUM 22C 071 ==> 1999

Sampa Nr.

080.077

O.E.M. Nr.

5010 245 591

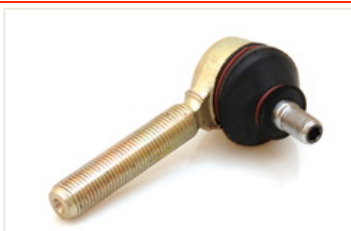

Dimension

M10x1.25/M14x1.5

Description

Ball Joint

PREMIUM TR 4X2 ==>1999	KERAX FAB 33A==>S 2000==>2002
PREMIUM 6X2&6X2/4 ==>1999	MIDLUM 42B3/4-44TA/V/C.-45D/E.
AE MAGNUM390/420TI/430/470/560	MIDLUM 4X4 47XA/47XC
PREMIUM PR 4X2 ==> 1999	PREMIUM TRACTEUR 4X2(FAB 22CC)
KERAX ==> 1999	PREMIUM(FAB22EE/HA/HB/JJ/QQ/RR)
PA 200/210	PREMIUM PR 4X2 (FAB 22AA/AB)
PREMIUM 260 SP	KERAX (FAB 33AA/././SS)
MIDLUM(FAB42B1/2-43C1/2-43T/V)	KERAX (FAB33A/././R) 2003==>
PREMIUM TR 4X2 2000 ==>	MIDLUM(FAB 42US-44US-45US)
PREMIUM(FAB22E/H/J/Q/R)2000==>	KERAX 33G / 33K ARMEE
PREMIUM PR 4X2 (FAB22A)2000==>	BANGLADESH
MIDLUM EXPORT (FAB 43E1-43E2)	

Sampa Nr.

080.224

O.E.M. Nr.

5000 750 738



Dimension

ø18xø56x70

Description

Silent Block for Gearbox

KERAX	G MANAGER
PREMIUM	MAXTER
MAGNUM	G260/290

Sampa Nr.

080.225

O.E.M. Nr.

5010 377 555



Dimension

ø18xø56x70

Description

Silent Block for Gearbox

PG230/280	PREMIUM
-----------	---------

Sampa Nr.

080.064

O.E.M. Nr.

5000 750 630



Dimension

M10/ø49x35.5

Description

Rubber Mounting for Exhaust

C260/290	C230/280/300/340TI/CCH300
C210/CLR220	PREMIUM

Sampa Nr.

080.250

O.E.M. Nr.

0000 689 778



Dimension

ø15xø50x20

Description

Rubber Mounting for Exhaust

TR/GR305	R310 4X2—>8/84	R360 6X4->10/1983
TR/GR350	R360 4X2	R310 6X4 JSQ 8/1984
GR/TR280	GBH/TBH280 1981—>	
GRH/TRH305	GBH260/280 6X6	
GRH/TRH350	G260/290	

Shock Absorber



Sampa Nr.

080.038

O.E.M. Nr.

-

Dimension

660 mm/350N

Description

Gas Spring



Sampa Nr.

080.232

O.E.M. Nr.

5010 227 221
(5010 445 375)

Dimension

405mm/150N

Description

Gas Spring

AE380/385TI/420TI/500/520
AE MAGNUM390/420TI/430/470/560
MAGNUM E-TECH 400/440/480
MAGNUM DX112 -VAR-120AV



Sampa Nr.

080.233

O.E.M. Nr.

5010 290 528
(5010 445 244)

Dimension

235mm/250N

Description

Gas Spring

PREMIUM TR 4X2 ==>1999
PREMIUM 6X2&6X2/4 ==>1999
PREMIUM PR 4X2 ==> 1999
KERAX ==>1999
SISU
PREMIUM 22C 071 ==> 1999
PREMIUM TR 4X2 2000 ==>
PREMIUM(FAB22E/H/J/Q/R)2000==>
PREMIUM PR 4X2 (FAB22A)2000==>
KERAX FAB 33A==>S 2000==>2002
PREMIUM TRACTEUR 4X2(FAB 22CC)
PREMIUM(FAB22EE/HA/HB/JJ/QQ/RR
PREMIUM PR 4X2 (FAB 22AA/AB)
KERAX (FAB 33AA.././SS)
KERAX (FAB33A.././R) 2003==>
PREMIUM DXI 11 -FAB-27JC/TC
PREMIUM DXI 11 -FAB-27RC/SC



Sampa Nr.

080.234

O.E.M. Nr.

5010 353 703

Dimension

635mm/200N

Description

Gas Spring

PREMIUM TR 4X2==>1999
PREMIUM 6X2&6X2/4 ==>1999
PREMIUM PR 4X2==> 1999
KERAX==>1999
PREMIUM 260 SP
PREMIUM TR 4X2 2000 ==>
PREMIUM(FAB22E/H/J/Q/R)2000—>
PREMIUM PR 4X2(FAB22A)2000==>
KERAX FAB 33A==>S 2000==>2002



Sampa Nr.

080.235

O.E.M. Nr.

5010 225 922

Dimension

635mm/350N

Description

Gas Spring

PREMIUM TR 4X2 ==>1999
PREMIUM 6X2&6X2/4==>1999
PREMIUM PR 4X2 ==> 1999



Sampa Nr.

080.236

O.E.M. Nr.

5010 468 003

Dimension

615mm/230N

Description

Gas Spring

PREMIUM 260 SP
PREMIUM TR 4X2 2000 ==>
PREMIUM(FAB22E/H/J/Q/R)2000==>
PREMIUM PR 4X2 (FAB22A)2000==>
KERAX FAB 33A==>S 2000==>2002
PREMIUM TRACTEUR 4X2(FAB 22CC)
PREMIUM(FAB22EE/HA/HB/JJ/QQ/RR
PREMIUM PR 4X2 (FAB 22AA/AB)
KERAX (FAB 33AA.././SS)
KERAX (FAB33A.././R) 2003==>
SISU

Sampa Nr.

080.237

O.E.M. Nr.

5010 578 586



Dimension

630mm/400N

Description

Gas Spring

PREMIUM DXI 11-FAB-27RC/SC PREMIUM DXI 11-FAB-27JC/TC

Sampa Nr.

080.073

O.E.M. Nr.

5010 377 224



Dimension

M12/ø39x28

Description

Rubber Mounting for Air Suspension

AE380/385TI/420TI/500/520 MAGNUM E-TECH 400/440/480
AE MAGNUM390/420TI/430/470/560

Sampa Nr.

080.074

O.E.M. Nr.

5010 570 047



Dimension

M10/ø39x28.5

Description

Rubber Mounting for Radiator

GB/TB191/231	G230/270 SP
GC191/231	G220/270 BOM
GR191/231	G200/210/230TI
GRH235/HF26	"G" MANAGER 4X2 & 6X2 & 6X4
SG2 DEP 1979	G340TI 4X4 6X6
PGC191/231	G340TI TR 18T
GBH260/280 6X6	PREMIUM TR 4X2 ==>1999
GBH260/280 6X4 -->1980	PREMIUM 6X2&6X2/4 ==>1999
G170/210/230/260/290/320	MAXTER 4X2-4X4
S130/150TI (VF6JN)	AE MAGNUM390/420TI/430/470/560
S130/150TI/170 (VF6JP)	PREMIUM PR 4X2 ==> 1999
770KB6 SP	S135/150 (MOT 040226)
F310/330/340/365 1984-->	M210 4X4
SG4 / SG3	KERAX ==> 1999
S100/110/130 (VF6JK)	PA200/210 / PG230/280
M140/160/200/230	PREMIUM 260 SP
AE380/385TI/420TI/500/520	MIDLUM(FAB42B1/2-43C1/2-43T/M)
"R"1990-->1992 / "R" 1993-->	MAGNUM E-TECH 400/440/480
S120/135/140/160	PREMIUM TR 4X2 ==>
M/S 4X4 & INCENDIE	PREMIUM(FAB22E/H/J/Q/R)2000==>
ME/SE/CE/ 160/180/210	PREMIUM PR 4X2 (FAB22A)2000==>
MAXTER 6X4 8X4	MIDLUM EXPORT (FAB 43E1-43E2)
M/S 150/180/210/220/230TI/250	KERAX FAB 33A==>S 2000==>2002
PS150/160	MIDLUM 42B3/4-44TA/C.-45D./E.

Sampa Nr.

030.229

O.E.M. Nr.

5001 835 165



Dimension

ø19xø50.5x26

Description

Rubber Bushing for Shock Absorber

AE380/385TI/420TI/500/520
G340TI TR 18T
PREMIUM TR 4X2 ==>1999
PREMIUM 6X2&6X2/4 ==>1999
AE MAGNUM390/420TI/430/470/560
PREMIUM PR 4X2 ==> 1999
KERAX ==> 1999
PREMIUM 260 SP
PG230/280
MAGNUM E-TECH 400/440/480
PREMIUM TR 4X2 2000 ==>
PREMIUM(FAB22E/H/J/Q/R)2000==>
KERAX FAB 33A==>S 2000==>2002
PREMIUM 22C 071 ==> 1999

Sampa Nr.

080.147

O.E.M. Nr.

5000 739 051



Dimension

M16/ø100x73

Description

Rubber Mounting for Air Suspension

GLC/GLR190/230	CBH/CLM280/340
JE13/15	C230/280/300/340TI/CCH300
C260/290	ME/SE/CE/ 160/180/210
GLR230 4X4 SINPAR	CBH/CLM 320/385
C210/CLR220	MACK CS200/250/300 1990-->

Sampa Nr.

080.252

O.E.M. Nr.

5000 418 144



Dimension

ø20xø42x42

Description

Rubber Mounting for Radiator

C260/290 C210/CLR220

Filler / Pedal / Gas



Sampa Nr.

080.055

O.E.M. Nr.

0000 149 310

Dimension

ø37xø54.5x31

Description

Filler Cap

TR/GR305/350	C210/CLR220
GB131/HR15	G170/210/230/260/290/320
GB/TB191/231	R370 JSQ 1984
GC191/231	770KB6 SP
GR191/231	R370/390/420 →1989
GRH235/HF26	R310/330/340/365 1984→
GR/TR280	CBH/CLM280/340
GRH/TRH305/350	M140/160/200/230
TF231D	AE380/385TI/420TI/500/520
GF151D	"R" 1990→1992"
R310 4X2 ->8/84	PREMIUM
R360 4X2	MAGNUM
PGC191/231	MIDLUM
GLC/GLR190/230	KERAX
JE13/15	MAXTER
C260/290	
R360 6X4 → 10/1983	
R310 6X4 JSQ 8/1984	
GLR230 4X4 SINPAR	

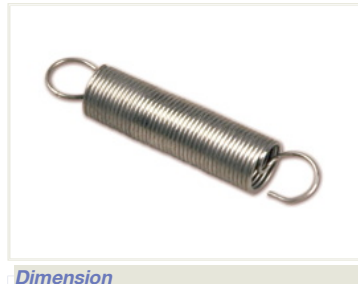

Sampa Nr.

080.150

O.E.M. Nr.

0000 270 526

Dimension

ø14.7x76.5

Description

Return Spring

GB/TB191/231	CBH/CLM 320/385
GC191/231	M/S 150/180/210/220/230TI/250
GR191/231	PS150/160
GRH235/HF26	"R" 1993→
TF231D	G230/270 SP
R310 4X2 ->8/84	G220/270 BOM
GBH/TBH280 1981→	G200/210/230TI
PGC191/231	"G" MANAGER 4X2"
GBH260/280 6X6	"G" MANAGER 6X2 & 6X4"
GLC/GLR190/230	G340TI 4X4/ 6X6
G260/290	G340TI TR 18T
R310 6X4 JSQ 8/1984	PREMIUM TR 4X2 ==>1999
GLM/TLM280	PREMIUM 6X2&6X2/4 ==>1999
GLR230 4X4 SINPAR	MAXTER 4X2-4X4
G170/210/230/320	AE MAGNUM390/420TI/430/470/560
R370 JSQ 1984	PREMIUM PR 4X2 ==> 1999
770KB6 SP	KERAX ==> 1999
R370/390/420 →1989	PREMIUM 260 SP
R310/330/340/365 1984→	PG230/280
CBH/CLM280/340	MIDLUM(FAB42B1/2-43C1/2-43T/V)
AE380/385TI/420TI/500/520	PREMIUM PR 4X2 (FAB22A)2000==>
"R" 1990→1992"	MACK CS200/250/300 1990→
C230/280/300/340TI/CCH300	
M/S 4X4 & INCENDIE	
MAXTER 6X4 8X4	

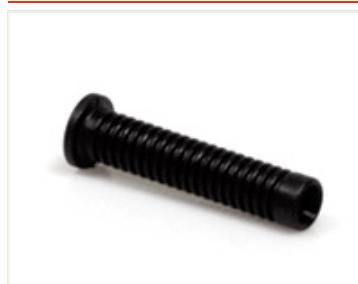

Sampa Nr.

080.257

O.E.M. Nr.

7700 693 776

Dimension

ø12x59

Description

Idle Speed Adjustment

GBH/TBH280 1981→	C230/280/300/340TI/CCH300
GBH260y280 6X6	MAXTER 6X4 8X4
JE13/15	CBH/CLM 320/385
C260/290	R 1993→
GLM/TLM280	G230/270 SP
C210/CLR220	G220/270 BOM
G170/210/230/260/290/320	G200/210/230TI
S130/150TI (VF6JN)	G MANAGER 4X2 & 6X2 & 6X4
S130/150TI/170 (VF6JP)	G340TI 4X4 & 6X6
R370/390/420->1989	PREMIUM
R310/330/340/365 1984→	MAXTER
CBH/CLM280/340	KERAX
AE380/385TI/420TI/500/520	MIDLUM
R 1990→1992	SISU



Sampa Nr.

080.061

O.E.M. Nr.

5516 031 803

Dimension

M73x4/48

Description

Filler Cap

GB131/HR15	R310/330/340/365 1984→
GB/TB191/231	S100/110/130 (VF6JK)
GC191/231	CBH/CLM280/340
GR191/231	M140/160/200/230
GRH235/HF26	AE380/385TI/420TI/500/520
TF231D	MIDLINER GRANDE-BRETAGNE
GF151D	"R" 1990→1992"
PJK/PJN/PJP	S140/160
PGC191/231	C230/280/300/340TI/CCH300
JE13/15	M/S 4X4 & INCENDIE
G260/290	ME/SE/CE/ 160/180/210
C260/290	MAXTER 6X4 8X4
JN55/60/85	CBH/CLM 320/385
JP11/13	M/S 150/180/210/220/230TI/250
JK55/60/65/75	"R" 1993→
S170 (FAB=SH)	S120/135
C210/CLR220	G220/270 BOM
G170/210/230/320	G200/210/230TI
S130/150TI (VF6JN)	"G" MANAGER 4X2"
S130/150TI/170 (VF6JP)	
R370/390/420 →1989	

Sampa Nr.

080.075

O.E.M. Nr.

5010 133 895



Dimension

M6x1L

Description

Ball Joint, Left

AE380/385TI/420TI/500/520 PREMIUM
"G" MANAGER KERAX
G340TI TR 18T SISU

Sampa Nr.

080.124

O.E.M. Nr.

5010 239 842



Dimension

M6x1R

Description

Ball Joint, Right

AE380/385TI/420TI/500/520
G340TI TR 18T
PREMIUM TR 4X2 ==>1999
PREMIUM 6X2&6X2/4 ==>1999
AE MAGNUM390/420TI/430/470/560
PREMIUM PR 4X2 ==> 1999
KERAX ==> 1999
KERAX FAB 33A==>S 2000==>2002

Sampa Nr.

080.260

O.E.M. Nr.

5010 294 307 C
(4911 N P01)
(4911 N P03)



Dimension

ø228x210

Description

Piston for Air Bellow

Sampa Nr.

080.125

O.E.M. Nr.

5010 211 555



Dimension

M6x1L

Description

Ball Joint, Left

AE380/385TI/420TI/500/520	AE MAGNUM390/420TI/430/470/560
M/S 150/180/210/220/230TI/250	PREMIUM PR 4X2 ==> 1999
"R" 1993-->	KERAX ==> 1999
G200/210/230TI	MIDLUM(FAB42B1/2-43C1/2-43T/M)
"G" MANAGER 4X2"	MAGNUM E-TECH 400/440/480
G340TI TR 18T	KERAX FAB 33A==>S 2000==>2002
PREMIUM TR 4X2 ==>1999	PREMIUM(FAB22EE/HA/HB/JJ/QQ/RR)
PREMIUM 6X2&6X2/4 ==>1999	MIDLUM(FAB 42US-44US-45US)

Sampa Nr.

080.256

O.E.M. Nr.

5010 152 854



Dimension

ø30xø45.5x45

Description

Bushing

TR/GR305	GRH/TRH350	GLR230 4X4 SINPAR
TR/GR350	GBH/TBH280 1981-->	770KB6 SP
GR/TR280	GLC/GLR190y230	
GRH/TRH305	GLM/TLM280	

Sampa Nr.

080.544

O.E.M. Nr.

-

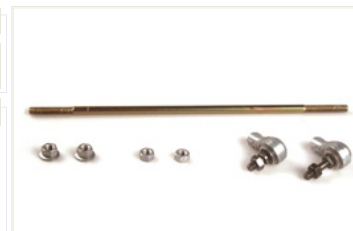

Dimension

M6x1

Description

Ball Joint Set

G340TI TR 18T
PREMIUM TR 4X2 ==>1999
PREMIUM 6X2&6X2/4 ==>1999

Sampa Nr.

080.253

O.E.M. Nr.

0000 490 601



Dimension

ø38xø152x51

Description

Dust Cover

GBH260/280 6X6
GBH260/280 6X4 -->1980