

Spare Parts for European Trucks & Trailers

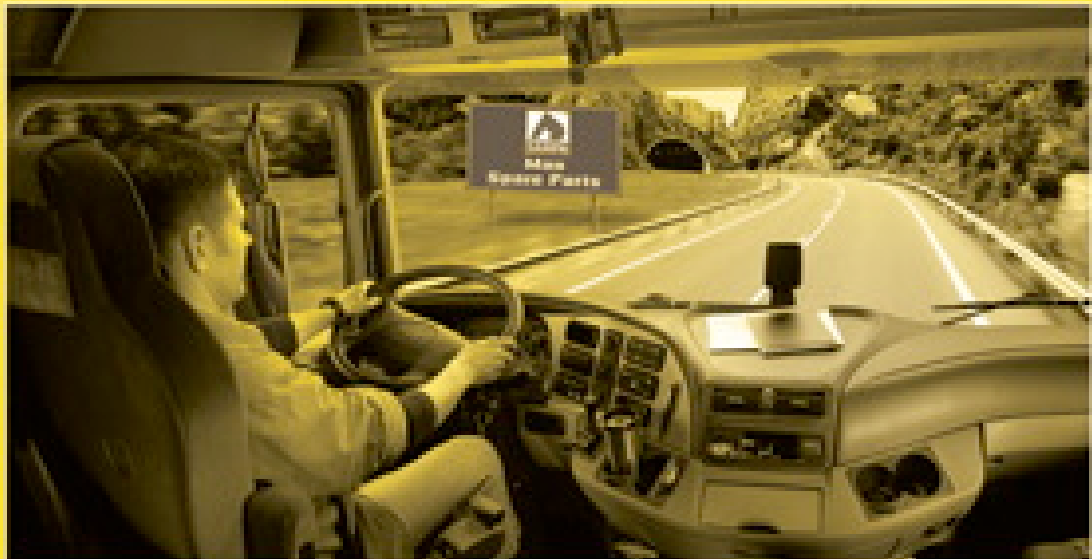

2

MAN

"technology, reliability & quality..."





www.sampalkw.com





"technology, reliability & quality..."

www.sampalkw.com

Sampa Nr.	
020.025	
O.E.M. Nr.	
81.43722.0062 (81.43722.0045)	
Dimension	$\varnothing 24 \times \varnothing 70 \times 105$
Description Rubber Bushing for Spring	
F 2000 ÖAF	

Sampa Nr.	
020.029	
O.E.M. Nr.	
81.43722.0061 (81.43722.0044)	
Dimension	$\varnothing 24 \times \varnothing 70 \times 95$
Description Rubber Bushing for Spring	
18.220/290/370 26T6 F 2000 ÖAF	

Sampa Nr.	
020.038	
O.E.M. Nr.	
81.43722.0051 (81.43722.0078) (81.43722.0079)	
Dimension	$\varnothing 20 \times \varnothing 57 \times 84$
Description Rubber Bushing for Spring	
12.220 14.280 L 2000 M 2000	

Sampa Nr.	
020.188	
O.E.M. Nr.	
81.43722.0070	
Dimension	$\varnothing 24 \times \varnothing 65 \times 95$
Description Rubber Bushing for Spring	
ECT18/26 TGA	

Sampa Nr.	
020.030	
O.E.M. Nr.	
81.96020.0250 (81.96020.0231) (81.96020.0252)	
Dimension	$\varnothing 16 \times \varnothing 50 \times 95$
Description Rubber Bushing for Spring	
10/11.150/180/190/220/230 12.220 13.210/220/230 6/8.90 F/FR 8/9.136 8/9.136 F/FR	
8/9.136/170 G 90 L 2000 M 2000 M 90	

Sampa Nr.	
020.148	
O.E.M. Nr.	
81.96210.5022 (81.96210.5021) (81.96210.5023)	
Dimension	h:127
Description Spring Cushion	
F 2000 F 90 L 2000 ÖAF	

Spring Suspension

MAN



Sampa Nr.

020.167

O.E.M. Nr.

81.96210.5025
(81.96210.5026)
(81.96210.5027)

Dimension

h:166

Description

Spring Cushion

ÖAF
F 2000



Sampa Nr.

020.208

O.E.M. Nr.

81.96210.0550

Dimension

h:154

Description

Spring Cushion

TGA
F 2000



Sampa Nr.

020.185

O.E.M. Nr.

81.96210.0555
(81.96210.0548)

Dimension

h:133

Description

Spring Cushion

F 2000
TGA



Sampa Nr.

020.186

O.E.M. Nr.

81.96210.0554
(81.96210.0547)

Dimension

h:133

Description

Spring Cushion

F 2000
TGA



Sampa Nr.

020.210

O.E.M. Nr.

06.01494.4933

Dimension

M20x2/260

Description

Spring Pin

F 2000
TGA



Sampa Nr.

020.211

O.E.M. Nr.

06.01494.4935

Dimension

M20x2/240

Description

Spring Pin

F 2000
TGA

Sampa Nr.	
020.103	
O.E.M. Nr.	
81.96210.0402	
Dimension	M12/41
Description	Spring Buffer
G 90 L 2000 M 2000	

Sampa Nr.	
020.168	
O.E.M. Nr.	
81.96210.0431 (81.96210.0532)	
Dimension	M8/19
Description	Spring Buffer
L 2000 M 2000 M 90	

Sampa Nr.	
020.081	
O.E.M. Nr.	
81.96101.0739 (81.96101.0690)	
Dimension	ø70x20
Description	Spring Buffer
G 90 L 2000 M 2000 M 90 M 2000 L M 2000 M	

Sampa Nr.	
011.250	
O.E.M. Nr.	
81.43407.0109 (81.43407.0509)	
Dimension	84x110x18
Description	Spring Buffer
18.220/290/370 ECT18 ECT26 F 2000 F 90	L 2000 M 2000 ÖAF TGA

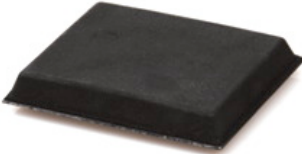
Sampa Nr.	
020.083	
O.E.M. Nr.	
83.96020.0506 (81.43400.6484)	
Dimension	105x87.5x18.5
Description	Spring Buffer
F 90 F 2000 ÖAF	

Sampa Nr.	
020.194	
O.E.M. Nr.	
81.43407.0102	
Dimension	100x140x18
Description	Spring Buffer
F 2000 ÖAF	

Spring Suspension

MAN

 <p>Dimension ø95.5x96</p> <p>Description Spring Buffer</p> <p>14/15.220 - 15/19.240 16.200/220/240/280/290/360/372 16/19/26/27/30/32/33/34.281/291/321/331/361 17.220/240 - 18.220/290/370 - 19.240 22/24/25.220/240/281/291/321/331/361 26/32.365 - 26T F 2000 - F 90 - L 2000 - M 2000 - M 90 ÖAF - TGA</p>	<p>Sampa Nr. 020.108</p> <p>O.E.M. Nr. 81.96020.6006 (81.96020.0172) (81.96020.0136) (81.96020.0110)</p>	 <p>Dimension ø70x80</p> <p>Description Spring Buffer</p> <p>6/8.90 8/9.136/170 G 90 L 2000 M 2000</p>	<p>Sampa Nr. 020.190</p> <p>O.E.M. Nr. 81.96020.0230 (81.96020.0277) (81.96020.0280)</p>
 <p>Dimension ø25x130</p> <p>Description Spring Pin</p> <p>12.170/192 14.170/192 16.170/192 17.170/192 M 90</p>	<p>Sampa Nr. 020.111</p> <p>O.E.M. Nr. 81.41306.0090 (81.41306.0070) (81.41306.0087)</p>	 <p>Dimension ø25x143</p> <p>Description Spring Pin</p> <p>14/15.220 15.240 16.240/280/290 ÖAF</p>	<p>Sampa Nr. 020.112</p> <p>O.E.M. Nr. 81.41306.0081 (81.41306.0072) (81.41306.0058)</p>
 <p>Dimension ø25x143</p> <p>Description Spring Pin</p> <p>14/15.220/15.240 16.200/240/280/290 19.240 26/32.240/281/301/321</p>	<p>Sampa Nr. 020.113</p> <p>O.E.M. Nr. 81.41306.0084 (81.41306.0071) (81.41306.0067) (81.41306.0080) (81.41306.0055)</p>	 <p>Dimension ø30x142</p> <p>Description Spring Pin</p> <p>19T F 2000 F 90 ÖAF</p>	<p>Sampa Nr. 020.114</p> <p>O.E.M. Nr. 81.41306.0095</p>

Sampa Nr.
020.115

O.E.M. Nr.
81.41306.0088



Dimension
ø30x143

Description
Spring Pin

16.220/240/281/291/321/331/361 26/27/30/32/33/34.281/291/321/331/361
17.220/240 26/32.365
19.240/281/291/321/331/361 F 90
22/24/25/26.220/240/281/291/321/331/361 M 90

Sampa Nr.
020.116

O.E.M. Nr.
81.41306.0089



Dimension
ø30x145

Description
Spring Pin

Sampa Nr.
020.117

O.E.M. Nr.
81.41306.0092
(81.91001.0453)



Dimension
ø30x160

Description
Spring Pin

30/32/33/34.281/291/321/331/361

Sampa Nr.
020.118

O.E.M. Nr.
81.41306.0085
(81.41306.0078)
(81.41306.0074)
(81.41306.0001)



Dimension
ø30x162

Description
Spring Pin

Sampa Nr.
020.119

O.E.M. Nr.
81.41306.0097



Dimension
ø30x164

Description
Spring Pin

19T F 90
F 2000 ÖAF

Description
Spring Pin

14.220
15/22/24/25/26.220/240
16.170/192/200/220/240/280/281/290/291/321/331/361
17.170/192/220/240
19.240/281/291/321/331/361
22/24/25/26/27/30/32/33/34.281/291/321/331/361
26/32.365
8/9.136
F 90
M 90
ÖAF

Sampa Nr.
020.121

O.E.M. Nr.
81.91020.0327
(81.91020.0255)



Dimension
ø40x161

Description
Spring Pin

Sampa Nr.
020.120

O.E.M. Nr.
81.41306.0096





Dimension
ø30x162

Description
Spring Pin

16.200/240/280/290
F 90

Spring Suspension

MAN

	<p><i>Sampa Nr.</i></p> <p>020.122</p> <p><i>O.E.M. Nr.</i></p> <p>81.41304.0043 (81.41304.0008) (81.43420.0014)</p>		<p><i>Sampa Nr.</i></p> <p>020.123</p> <p><i>O.E.M. Nr.</i></p> <p>81.41304.0042 (81.43420.0000)</p>
<p><i>Dimension</i></p> <p>ø25xø30x77.5</p> <p><i>Description</i></p> <p>Spring Bushing</p>		<p><i>Dimension</i></p> <p>ø25xø30x87.5</p> <p><i>Description</i></p> <p>Spring Bushing</p>	
<p>12.170/192 17.170/192</p>		<p>14.220 19.240</p>	
<p>14.170/192 M 90</p>		<p>15.220/240 26/32.240/281/301/321</p>	
<p>16.170/192 ÖAF</p>		<p>16.200/240/280/290</p>	
	<p><i>Sampa Nr.</i></p> <p>020.124</p> <p><i>O.E.M. Nr.</i></p> <p>81.41304.0041 (81.41304.0032)</p>		<p><i>Sampa Nr.</i></p> <p>020.125</p> <p><i>O.E.M. Nr.</i></p> <p>81.41304.0044 (81.41304.0052)</p>
<p><i>Dimension</i></p> <p>ø30xø36x77.5</p> <p><i>Description</i></p> <p>Spring Bushing</p>		<p><i>Dimension</i></p> <p>ø30xø36x87.5</p> <p><i>Description</i></p> <p>Spring Bushing</p>	
<p>12.170/192 17.170/192</p>		<p>16.200/220/240/280/281/290/291/321/331/361</p>	
<p>14.170/192 M 90</p>		<p>17.220/240 - 24.350/400</p>	
<p>16.170/192</p>		<p>18.220/290/310/313/350/370/400/420/460</p>	
		<p>19.240/281/291/321/331/361</p>	
		<p>22/24/25/26.220/240/281/291/321/331/361</p>	
		<p>26.281/291/321/331/361/365</p>	
		<p>27.281/291/321/331/361</p>	
		<p>30.281/291/321/331/361</p>	
		<p>32.281/291/321/331/361/365</p>	
		<p>33.281/291/321/331/361</p>	
		<p>34.281/291/321/331/361</p>	
		<p>EL 202/222/262</p>	
		<p>F 2000 - F 90 - M 2000 - M 90 - ND202</p>	
		<p>NG 242/252/262/272/312 - NGT 204</p>	
		<p>NL 202/205/213/222/232/250/252/262/312</p>	
		<p>NM 152 - ÖAF</p>	
		<p>UEL 242/272/292/312/322</p>	
	<p><i>Sampa Nr.</i></p> <p>020.126</p> <p><i>O.E.M. Nr.</i></p> <p>81.41304.0040 (81.41304.0038) (81.43420.0012)</p>		<p><i>Sampa Nr.</i></p> <p>020.127</p> <p><i>O.E.M. Nr.</i></p> <p>81.41304.0037 (81.41304.0031)</p>
<p><i>Dimension</i></p> <p>ø30xø36x97.3</p> <p><i>Description</i></p> <p>Spring Bushing</p>		<p><i>Dimension</i></p> <p>ø40xø46x97</p> <p><i>Description</i></p> <p>Spring Bushing</p>	
<p>14/15.220/15.240</p>			
<p>16.220/240/280/281/290/291/321/331/361</p>			
<p>17.220/240</p>			
<p>18.220/290/370</p>			
<p>19.240/281/291/321/331/361</p>			
<p>22.220/240/281/291/321/331/361</p>			
<p>24.220/240/281/291/321/331/361</p>			
<p>25.220/240/281/291/321/331/361</p>			
<p>26.220/240/281/291/321/331/361</p>			
<p>26.281/291/321/331/361/365</p>			
<p>30.281/291/321/331/361</p>			
<p>32.281/291/321/331/361/365</p>			
<p>33.281/291/321/331/361</p>			
<p>34.281/291/321/331/361</p>			
<p>8/9.136</p>			
<p>19T - F 2000 - F 90 - G 90 - M 2000 - M 90 - ÖAF</p>			



Sampa Nr.
020.130

O.E.M. Nr.
81.41304.0020



Dimension
ø42xø48x95

Description
Spring Bushing

Sampa Nr.
020.131

O.E.M. Nr.
81.41304.0050
(81.41304.0035)
(81.41304.0029)



Dimension
ø44xø48x95.5

Description
Spring Bushing

14/15.220/15.240 - 17.170/192/220/240
16.170/192/200/240/280/281/290/291/321/331/361
19.240/281/291/321/331/361
19T - F 90 - M 2000 - M 90

Sampa Nr.
020.143

O.E.M. Nr.
81.41350.0018



Dimension
ø125/ø145x275

Description
Cradle

26 T
F 2000
F 90
ÖAF
TGA

Sampa Nr.
020.209

O.E.M. Nr.
06.36959.0027
(06.36959.0030)



Dimension
ø95xø145x31/37

Description
Joint Bearing

F90
F 2000
TGA

Sampa Nr.
020.156

O.E.M. Nr.
81.41320.0092
(81.41320.0089)



Dimension
184x220x217

Description
Spring Bracket

26T/19T
F 2000
F 90
M 2000
ÖAF
TGA

Sampa Nr.
020.176

O.E.M. Nr.
81.96210.0508
(81.96210.0507)



Dimension
ø121xø150x100

Description
Bogie Suspension Bearing

F 2000
TGA

Sampa Nr.
020.145

O.E.M. Nr.
81.45503.0037



Dimension
M27x2/41

Description
Nut for Spring Pin

26T
F 2000

F 90
M 2000

ÖAF
TGA

Cabin

MAN



Sampa Nr.

020.028

O.E.M. Nr.

**81.96210.0437
(81.96210.0424)**

Dimension

ø16.5xø70.5x68

Description

Cabin Bushing

F 2000
F 90
M 2000
ÖAF



Sampa Nr.

020.032

O.E.M. Nr.

**81.96210.0407
(81.96210.0362)**

Dimension

ø15xø62x17

Description

Buffer for Cabin

F 2000
F 90
M 2000
ÖAF



Sampa Nr.

111.004

O.E.M. Nr.

**06.36950.0510
(81.93430.0008)
(81.93430.0009)
(81.93430.0010)**

Dimension

ø30xø47x18/22

Description

Cab Suspension Bearing

F 2000
F 90
M 2000
ÖAF



Sampa Nr.

020.034

O.E.M. Nr.

**81.90713.0909
(81.90712.0844)**

Dimension

ø33xø65x6

Description

Buffer for Cabin

F 2000
F 90
M 2000
ÖAF



Sampa Nr.

020.506

O.E.M. Nr.

81.96210.0407 S

Dimension

ø16.5xø70.5x68

Description

Rep. Kit for Cabin

F 2000
F 90
M 2000
ÖAF



Sampa Nr.

020.513

O.E.M. Nr.

81.96210.0407 S1

Dimension

ø16.5xø70.5x68

Description

Rep. Kit for Cabin

F 2000
F 90
M 2000
ÖAF



Sampa Nr.

020.031

O.E.M. Nr.

81.96210.0400



Dimension

ø16xø50x29

Description

Cabin Mounting

F 90
ÖAF

Sampa Nr.

020.032

O.E.M. Nr.

**81.96210.0407
(81.96210.0362)**



Dimension

ø15xø62x17

Description

Buffer for Cabin

F 2000
F 90
M 2000
ÖAF

Sampa Nr.

111.004

O.E.M. Nr.

**06.36950.0510
(81.93430.0008)
(81.93430.0009)
(81.93430.0010)**



Dimension

ø30xø47x18/22

Description

Cab Suspension Bearing

F 2000
F 90
M 2000
ÖAF

Sampa Nr.

020.034

O.E.M. Nr.

**81.90713.0909
(81.90712.0844)**



Dimension

ø33xø65x6

Description

Buffer for Cabin

F 2000
F 90
M 2000
ÖAF

Sampa Nr.

020.505

O.E.M. Nr.

81.96210.0400 S

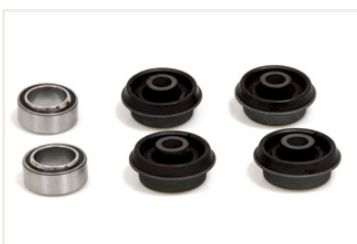

Dimension

ø16xø50x29

Description

Rep. Kit for Cabin

F 90
ÖAF

Sampa Nr.

020.514

O.E.M. Nr.

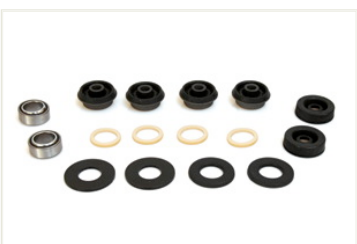

Dimension

ø16xø64x29

Description

Rep. Kit for Cabin

F 90
ÖAF

Cabin

MAN



Sampa Nr.

020.174

O.E.M. Nr.

85.96210.0019

Dimension

ø16.5x60x63.5x80

Description

Cabin Mounting

ECT18/26
TGA



Sampa Nr.

020.191

O.E.M. Nr.

85.41715.0006

Dimension

ø16.5/ø30x29

Description

Cabin Bushing

ECT18/26
TGA



Sampa Nr.

020.175

O.E.M. Nr.

85.96210.0021

Dimension

ø16xø53x58

Description

Cabin Mounting

ECT18/26
TGA
TGL
TGM



Sampa Nr.

111.070

O.E.M. Nr.

06.36950.0210

Dimension

ø30xø47x18/22

Description

Cab Suspension Bearing



Sampa Nr.

020.542

O.E.M. Nr.

81.41715.6014

Dimension

ø16.5x63.5x60x80

Description

Rep. Kit for Cabin

ECT18/26
TGA



Sampa Nr.

020.544

O.E.M. Nr.

81.41715.6013

Dimension

ø16.5x63.5x60x80

Description

Rep. Kit for Cabin

ECT18/26
TGA





Sampa Nr.	
020.141	
O.E.M. Nr. 81.96210.0536	
Dimension	M10/ø50.5x36
Description	Buffer for Cabin
F 2000 M 2000 ÖAF	

Sampa Nr.	
020.182	
O.E.M. Nr. 81.96210.0515 (81.96210.0482)	
Dimension	M10/ø50.5x36
Description	Buffer for Cabin
F 2000 M 2000 ÖAF	

Sampa Nr.	
020.045	
O.E.M. Nr. 81.96210.0348 (81.96210.0340) (81.96210.0349)	
Dimension	ø22xø58.5x47.5
Description	Cabin Mounting
12/14/16/17.170/192 18.220 322/352/402/422/462 FRH LION'S CITY LION'S CLASSIC LION'S COACH M 2000 M 90 RH 353/403/463	
SL 18.220/260/280 SUE 223/253/263/313 TGA	



Sampa Nr.	
020.102	
O.E.M. Nr. 81.96210.0353	
Dimension	ø30.5xø88x85
Description	Cabin Mounting
14/15.220/15.240 16/17.220/240/19.240 16/19.281/291/321/331/361 22/24/25/26.220/240/281/291/321/331/361 26/30/32/33/34.281/291/321/331/361 26/32.365 27/32/33/34.281/291/321/331/361	

Sampa Nr.	
020.048	
O.E.M. Nr. 81.96210.0393 (83.96210.0512)	
Dimension	ø25/40
Description	Cabin Mounting
TGA 19T 26T	

Sampa Nr.	
020.049	
O.E.M. Nr. 81.96210.0392 (83.96210.0515)	
Dimension	ø25/52
Description	Cabin Mounting
19T 26T	

Cabin

MAN

	<p><i>Sampa Nr.</i></p> <p>020.050</p> <p><i>O.E.M. Nr.</i></p> <p>85.96210.0012 (85.96210.0007) (81.96210.0012)</p>		<p><i>Sampa Nr.</i></p> <p>020.189</p> <p><i>O.E.M. Nr.</i></p> <p>81.96210.0316 (81.96210.0274)</p>
<p><i>Dimension</i></p> <p>ø22.5/ø94</p>		<p><i>Dimension</i></p> <p>ø20/153</p>	
<p><i>Description</i></p> <p>Cabin Mounting</p> <p>12.155 STAR 266M-STAR 8.125 STAR L 2000 M 2000</p>		<p><i>Description</i></p> <p>Cabin Mounting</p> <p>6/8.90 G 90 8/9.136 ÖAF</p>	
	<p><i>Sampa Nr.</i></p> <p>020.193</p> <p><i>O.E.M. Nr.</i></p> <p>81.96210.5011</p>		<p><i>Sampa Nr.</i></p> <p>020.033</p> <p><i>O.E.M. Nr.</i></p> <p>81.96210.0462 (81.96210.0369)</p>
<p><i>Dimension</i></p> <p>ø20/83</p>		<p><i>Dimension</i></p> <p>ø14xø30x48</p>	
<p><i>Description</i></p> <p>Cabin Mounting</p> <p>19.240 26.240/281/301/321 32.240/281/301/321</p>		<p><i>Description</i></p> <p>Cabin Mounting</p> <p>266M-STAR F 90 TGA AGGREGATE L 2000 TGL ECT18/26 M 2000 TGM F 2000 ÖAF</p>	
	<p><i>Sampa Nr.</i></p> <p>020.105</p> <p><i>O.E.M. Nr.</i></p> <p>81.96210.0339 (83.96210.0500)</p>		<p><i>Sampa Nr.</i></p> <p>020.212</p> <p><i>O.E.M. Nr.</i></p> <p>85.96210.0028</p>
<p><i>Dimension</i></p> <p>M16/ø129x91</p>		<p><i>Dimension</i></p> <p>ø16xø50x80</p>	
<p><i>Description</i></p> <p>Buffer for Cabin</p> <p>12.170/192 14.170/192 16.170/192 17.170/192</p>		<p><i>Description</i></p> <p>Cabin Bushing</p> <p>TGL TGM</p>	
			<p><i>Sampa Nr.</i></p> <p>020.214</p> <p><i>O.E.M. Nr.</i></p> <p>81.41722.6048 (81.41722.6051)</p>
		<p><i>Dimension</i></p> <p></p>	
		<p><i>Description</i></p> <p>Cabin Shock Absorber, With Air Bellow</p> <p>F 2000</p>	



Sampa Nr.	
020.001	
O.E.M. Nr.	
81.43704.0025	
	
Dimension	
ø55xø65x80.5	
Description	
Stabilizer Plastic Bearing	
12.170/192 14/15.220 15/19/26/32.240 16.200/240/280/290/360/372 16/17.170/192/220/240 16/19.281/291/321/331/361 22/24/25/26.220/240	22/24/25/26/27/32/33/34.281/291/3 21/331/361 26/30/32/33/34.281/291/321/331/3 61 26/32.301/365 M 90

Sampa Nr.	
080.001	
O.E.M. Nr.	
81.43704.0026	
	
Dimension	
ø38xø58/74	
Description	
Stabilizer Plastic Bearing	
16.200/240 16.240/280/290/360/372 16/19.281/291/321/331/361 22/24/25/26.281/291/321/331/361 26/32.281/301/321 26/27/32/33/34.281/291/321/331/361 30/32/33/34.281/291/321/331/361 22/24/25/26.220/240	14/15.220/15.240 16/17.220/240 19.240 H 26/32.240 26/32.365 19T4X4--- 16/17.220/240/19.240

Sampa Nr.	
020.003	
O.E.M. Nr.	
81.43704.0029	
	
Dimension	
ø45xø58/80	
Description	
Stabilizer Plastic Bearing	
ÖAF - M 90 - M 2000 - G 90 26/32/33/34.281/291/321/331/361 26/32.240/281/301/321/365 22/24/25/26/27/32/33/34.281/291/321/331/361 22/24/25/26.291/331/361 16/19.281/291/321/331/361 16/17/22/24/25/26.220/240 16.200/240/280/290/360/372 15/19.240 14/15.220 12/16/17.170/192	







Sampa Nr.	
020.004	
O.E.M. Nr.	
81.43704.0032	
	
Dimension	
ø60xø70/81	
Description	
Stabilizer Plastic Bearing	
14/15.220/15.240 16/17.220/240 16/19/22/24/25/26/30/32/33/34.281/291/321/331/361 22/24/25/26.220/240/291/331/361 F90	

Sampa Nr.	
020.041	
O.E.M. Nr.	
81.43704.0053	
	
Dimension	
ø35.5xø56.5x51.5	
Description	
Stabilizer Bearing	
6/8.90 8/9.136 8/9.136/170	G 90 L 2000 M 2000

Sampa Nr.	
020.042	
O.E.M. Nr.	
81.43704.0052	
	
Dimension	
ø31.5xø56.5x51.5	
Description	
Stabilizer Bearing	
6/8.90 F/FR G 90 L 2000	

Stabilizer

MAN

	<p><i>Sampa Nr.</i></p> <p>020.192</p>		<p><i>Sampa Nr.</i></p> <p>020.006</p>
<p><i>Dimension</i></p> <p>ø39xø56.5x51.5</p>	<p><i>O.E.M. Nr.</i></p> <p>81.43704.0038</p>	<p><i>Dimension</i></p> <p>ø16xø45x42</p>	<p><i>O.E.M. Nr.</i></p> <p>81.43271.0029 (81.43271.0008)</p>
<p><i>Description</i></p> <p>Stabilizer Bearing</p>		<p><i>Description</i></p> <p>Stabilizer Rubber Bushing</p>	
<p>6/8.90 8/9.136/170 G 90 L 2000 M 2000</p>		<p>12/14/16.170/192 14/15.220 15/19/26/32.240 16.240/280/290/360/372 16/17/22/24/25/26.220/240 16/19.281/291/321/331/361 22/24/25/26/27/30/32/33/34.281/291/321/331/361 M 90</p>	
	<p><i>Sampa Nr.</i></p> <p>020.007</p>		<p><i>Sampa Nr.</i></p> <p>020.024</p>
<p><i>Dimension</i></p> <p>ø22xø75x62</p>	<p><i>O.E.M. Nr.</i></p> <p>81.43722.0019 (81.43722.6051)</p>	<p><i>Dimension</i></p> <p>ø22xø65.5x62</p>	<p><i>O.E.M. Nr.</i></p> <p>81.43722.0021</p>
<p><i>Description</i></p> <p>Stabilizer Rubber Bushing</p>		<p><i>Description</i></p> <p>Stabilizer Rubber Bushing</p>	
<p>22/24/25/26.291/331/361 F 2000 F 90 ÖAF TGA</p>		<p>22/24/25/26.291/331/361 F 2000 M 90 ÖAF</p>	
	<p><i>Sampa Nr.</i></p> <p>020.044</p>		<p><i>Sampa Nr.</i></p> <p>020.170</p>
<p><i>Dimension</i></p> <p>ø18xø55x55</p>	<p><i>O.E.M. Nr.</i></p> <p>81.43271.0022</p>	<p><i>Dimension</i></p> <p>ø32xø55x72</p>	<p><i>O.E.M. Nr.</i></p> <p>81.96210.0150</p>
<p><i>Description</i></p> <p>Stabilizer Rubber Bushing</p>		<p><i>Description</i></p> <p>Stabilizer Rubber Bushing</p>	
		<p>16.240/280/281/290/291/321/331/360/361/370/372 19.281/291/321/331/361 22/24/25/26.220/240/281/291/321/331/361 L 2000 M 2000</p>	



Sampa Nr.
020.204

O.E.M. Nr.
81.43722.0022



Dimension
ø16xø45x47

Description
Stabilizer Rubber Bushing

10/11.150/180/190/220/230 - 12.220
13.210/220/230 - 14.220/280
16.200/240/280/290/360/370/372
18.220/260/280/310/313/350/360/370/400/410/420/460
22/24.330-420
24.310/350/400/460
26/32/33/34.281/291/321/331/361 - 26T
322/352/402/422/462 FRH
CENTROLINER
ECT18/26
F 2000
TGA
TGL
TGM
F 90

Sampa Nr.
020.027

O.E.M. Nr.
81.96210.0450
(81.43722.0038)
(81.96210.0469)



Dimension
ø16xø47.5x47

Description
Stabilizer Mounting

G 90
L 2000
LION'S CITY
LION'S CLASSIC
M 2000
M 90
ND 313/363
NG 243/263/313
NL 223/242/243/263/283/313
NMT 222 - NUE 263/313/353
ÖAF - RH 353/403
SG 28.260/310
SL 18.220/260/280
SUE 223/253/263/313
UEL 242/272/292/312/322

Sampa Nr.
020.036

O.E.M. Nr.
81.43722.0039



Dimension
ø22xø67.5x62

Description
Stabilizer Mounting

F 2000	L 2000	M 90	TGA
F 90	M 2000	ÖAF	

Sampa Nr.
020.037

O.E.M. Nr.
81.43722.0063



Dimension
ø22xø68x62

Description
Stabilizer Mounting

12.220	F 2000	M 90	TGM
13.210/220/230	F 90	NMT 222	
14.220/280	L 2000	ÖAF	
ECT18/26	M 2000	TGA	

Sampa Nr.
020.039

O.E.M. Nr.
81.43722.0040
(81.43722.0041)
(81.43722.0042)



Dimension
ø55xø83x70

Description
Stabilizer Mounting

12/14.220	F 90	NMT 222
13.210/220/230	L 2000	ÖAF
26T	M 2000	TGA
F 2000	M 90	TGL

Sampa Nr.
020.169

O.E.M. Nr.
81.43722.0059



Dimension
ø16xø50x47

Description
Stabilizer Mounting

322/352/402/422/462 FRH
18.220/260/280/290/310/313/350/360/370/400/410/420/460
22/24.330-420 - 24.310/350/400/460 - 26T
CENTROLINER - ECT18/26 - F 2000 - F 90 - L 2000
LION'S CITY - LION'S COACH - LION'S REGIO - LION'S STAR
M 2000 - M 90 - ND 313/363 - NG 243/263/313
NL 223/242/243/263/283/313 - NM 223/283 - NUE 263/313/353
ÖAF - RH 353/403/463
STARLINER - TGA - TGL - TGM
TOURLINER - TRENDLINER - UEL 242/272/292/312/313/322/353

O.E.M. Numbers are stated for comparison purposes only. It is not permitted to mention original numbers on invoices owners.



Stabilizer

MAN



Sampa Nr.

020.172

O.E.M. Nr.

81.43722.0047

Dimension

ø24xø64x44

Description

Stabilizer Mounting

12/14.220
18.220/230/250/280/310/313/350/360/370/400/410/420/460
24.310/350 - 28.270
AGGREGATE - EL 202/222/262
LION'S CLASSIC - ND 202 - NEW FLYER
NG 232/235/252/262/272/312 - NGT 204
NL 202/205/213/222/232/240/250/252/262/312 - NMT 222
SG 28.260/310 - SL 18.220/260/280 - SUE 223/253/263/313
UEL 242/272/292/312/322



Sampa Nr.

020.012

O.E.M. Nr.

81.43271.0080

Dimension

ø65.5xø15/100

Description

Silent Block for Stabilizer

18.220/290/370

F 2000

F 90

M 90

ÖAF



Sampa Nr.

020.013

O.E.M. Nr.

81.43271.0082

Dimension

ø65.5xø21/125

Description

Silent Block for Stabilizer

14/15.220	30/32/33/34.281/291/321/331/361
15/19.240	F 2000
16.200/220/240/280/290	F 90
16/19.281/291/321/331/361	ÖAF
17.220/240	TGA
26/32.240/281/291/301/321/331/361/365	
27/32/33/34.281/291/321/331/361	



Sampa Nr.

020.014

O.E.M. Nr.

81.43271.0083
(81.43271.0079)
(81.43271.0046)

Dimension

ø75xø21/125

Description

Silent Block for Stabilizer

F 2000

F 90

ÖAF



Sampa Nr.

020.015

O.E.M. Nr.

81.43271.0087

Dimension

ø65.5xø19/130

Description

Silent Block for Stabilizer

16.240/280/290/360/370/372
22/24.330-420
ÖAF



Sampa Nr.

020.022

O.E.M. Nr.

81.96210.0452

Dimension

ø47.5xø19/99

Description

Silent Block for Stabilizer

10/11.150/180/190/220/230

12.220

L 2000

M 2000

M 90



Sampa Nr.

020.023

O.E.M. Nr.

81.43271.0078
(81.43271.0032)



Dimension

ø75xø19/130

Description

Silent Block for Stabilizer

14.220
15/16/17/22/24/25/26.220/240
16/19.281/291/321/331/361
22/24/25/26/30/32/33/34.281/291/321/331/361

Sampa Nr.

020.040

O.E.M. Nr.

81.96210.0511



Dimension

ø47.5xø21/101

Description

Silent Block for Stabilizer

10/11.150/180/190/220/230
12.220
L 2000
M 2000
M 90

Sampa Nr.

020.162

O.E.M. Nr.

81.43722.0072



Dimension

ø68.5xø15/100

Description

Silent Block for Stabilizer

F 2000
TGA

Sampa Nr.

020.008

O.E.M. Nr.

81.43704.0057



Dimension

ø44.5xø67x60

Description

Stabilizer Half Bushing

10/11.150/180/190/220/230
12.220
13.210/220/230
16.200/240/280/290/360/370/372
18.310/350/360/370/400/410/420/460
22/24.330-420
24.310/350/400/460
CENTROLINER
F 2000
F 90
L 2000
LION'S CITY
LION'S CLASSIC
LION'S COACH
LION'S STAR
M 2000
M 90
MAN 322/352/402/422/462 FRH
ÖAF
RH 352/353/402/403/422/463
SG 28.260/310
SUE 223/253/263/313
TOURLINER
UEL 242/272/292/312/313/322/353

Sampa Nr.

011.077

O.E.M. Nr.

81.43271.0081



Dimension

ø54xø93.5/70x80







Description

Stabilizer Half Bushing

16.240/280/290/360/372
18.220/290/370
22/24.330-420
26T6X6
F 2000
F 90
ÖAF

Stabilizer

MAN

	<p><i>Sampa Nr.</i></p> <p>020.009</p> <p><i>O.E.M. Nr.</i></p> <p>81.43704.0060</p>		<p><i>Sampa Nr.</i></p> <p>020.010</p> <p><i>O.E.M. Nr.</i></p> <p>81.43704.0061</p>	
<p><i>Dimension</i></p> <p>ø55xø78x60</p>		<p><i>Dimension</i></p> <p>ø60xø78x60</p>		
<p><i>Description</i></p> <p>Stabilizer Half Bushing</p>		<p><i>Description</i></p> <p>Stabilizer Half Bushing</p>		
<p>14.280 22/24/25/26.291/331/361 F90 L 2000 M 2000</p>		<p>14.280 18.220/290/370 22/24/25/26.291/331/361 ECT18/26 F 2000 F 90</p>		<p>L 2000 M 2000 ÖAF TGA</p>
	<p><i>Sampa Nr.</i></p> <p>020.046</p> <p><i>O.E.M. Nr.</i></p> <p>81.43704.0044 (81.43704.0042)</p>		<p><i>Sampa Nr.</i></p> <p>020.047</p> <p><i>O.E.M. Nr.</i></p> <p>81.43704.0045 (81.43704.0028)</p>	
<p><i>Dimension</i></p> <p>ø55xø82x80</p>		<p><i>Dimension</i></p> <p>ø55xø87x80</p>		
<p><i>Description</i></p> <p>Stabilizer Half Bushing</p>		<p><i>Description</i></p> <p>Stabilizer Half Bushing</p>		
		<p>SL 200 SR 240/280 SUE 240</p>		
	<p><i>Sampa Nr.</i></p> <p>020.159</p> <p><i>O.E.M. Nr.</i></p> <p>81.43722.0052</p>		<p><i>Sampa Nr.</i></p> <p>020.161</p> <p><i>O.E.M. Nr.</i></p> <p>81.43722.0053</p>	
<p><i>Dimension</i></p> <p>ø34.5xø55x60</p>		<p><i>Dimension</i></p> <p>ø39xø55x60</p>		
<p><i>Description</i></p> <p>Stabilizer Mounting</p>		<p><i>Description</i></p> <p>Stabilizer Mounting</p>		
<p>L 2000 M 2000</p>		<p>12.220 14.280 L 2000 M 2000</p>		



Sampa Nr.
020.160

O.E.M. Nr.
81.43704.0078



Dimension
ø45xø75x51

Description
Stabilizer Mounting

18.260/310/313/350/360/370/400/410/420/460
322/352/402/422/462 FRH
ECT18/26 - F 2000
LION'S CITY - LION'S COACH - LION'S REGIO - LION'S STAR
ND 313/363 - NM 223/283
RH 353/403
STARLINER - TOURLINER - TRENDLINER
UEL 313/353 - TGA

Sampa Nr.
020.163

O.E.M. Nr.
81.43704.0077

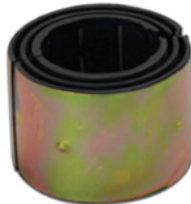

Dimension
ø50xø75x51

Description
Stabilizer Mounting

12.220 ND 313/363
14.220/280 NG 243/263/313
18.220/260/280/310 NL 223/242/243/263/283/313
CENTROLINER NUE 263/313/353
ECT26 TGA
L 2000 TGL
LION'S CITY TGM

Sampa Nr.
020.180

O.E.M. Nr.
81.43722.0083



Dimension
ø60xø88x60

Description
Stabilizer Mounting

ECT18/26
F 2000
TGA
TGM

Sampa Nr.
020.183

O.E.M. Nr.
81.43722.0068
(81.43722.0069)
(81.43722.0080)



Dimension
ø50xø84x72

Description
Stabilizer Mounting

F 2000
L 2000
ÖAF
TGA
TGM

Sampa Nr.
020.184

O.E.M. Nr.
81.43704.0074



Dimension
ø45xø65x51

Description
Stabilizer Mounting

18.220/260/290/310/313/350/360/370/400/410/420/460
26T
F 2000
M 2000
ÖAF

Sampa Nr.
020.177

O.E.M. Nr.
81.95301.0048







Dimension
ø83/46

Description
Stabilizer Mounting

GS UEH 270/290/320/370
MAN 292/332/362
SG 242/282/292/322
SL 202
SR 240/280
SUE 240/242/280

Stabilizer

MAN

	<p><i>Sampa Nr.</i></p> <p>020.016</p>		<p><i>Sampa Nr.</i></p> <p>020.017</p>
<p><i>Dimension</i></p> <p>ø55xø75x83</p>	<p><i>O.E.M. Nr.</i></p> <p>81.43271.0033</p>	<p><i>Dimension</i></p> <p>ø42xø68x68</p>	<p><i>O.E.M. Nr.</i></p> <p>81.43271.0074 (81.43271.0056)</p>
<p><i>Description</i></p> <p>Stabilizer Mounting</p>		<p><i>Description</i></p> <p>Stabilizer Mounting</p>	
<p>SG 242/280/282/292/322 SL 200/ 202 SR 280 SUE 240/242/280</p>		<p>SL 200 SR 240/280 SUE 240/280</p>	
	<p><i>Sampa Nr.</i></p> <p>020.018</p>		<p><i>Sampa Nr.</i></p> <p>020.019</p>
<p><i>Dimension</i></p> <p>ø55xø75x83</p>	<p><i>O.E.M. Nr.</i></p> <p>81.43316.0021</p>	<p><i>Dimension</i></p> <p>ø42xø68x68</p>	<p><i>O.E.M. Nr.</i></p> <p>81.44204.0012 (81.44204.0004)</p>
<p><i>Description</i></p> <p>Stabilizer Mounting</p>		<p><i>Description</i></p> <p>Stabilizer Mounting</p>	
<p>322/352/402/422/462 FRH 16.360/372 22/24.330-420 24.400/460 GS UEH 270/290/320/370 SG 242/280/292/322 SL 200/202 SUE 240/242/280</p>			
	<p><i>Sampa Nr.</i></p> <p>020.020</p>		<p><i>Sampa Nr.</i></p>
<p><i>Dimension</i></p> <p>ø58xø80x68</p>	<p><i>O.E.M. Nr.</i></p> <p>81.44204.0021 (81.44204.0020)</p>	<p><i>Dimension</i></p>	<p><i>O.E.M. Nr.</i></p>
<p><i>Description</i></p> <p>Stabilizer Mounting</p>		<p><i>Description</i></p>	
<p>322/352/402/422/462 FRH 16.360/372 22/24.330-420 24.400/460 GS UEH 270/290/320/370 LION'S COACH</p>		<p>MAN 292/332/362 SG 242/280/282/292/322 SL 200/202 SR 240/280 SUE 240/242/280</p>	



Sampa Nr.

020.043

O.E.M. Nr.

81.96210.0278



Dimension
ø27x43

Description

Stabilizer Bearing

6/8.90
8/9.136/170
G 90
L 2000
M 2000

Sampa Nr.

020.035

O.E.M. Nr.

81.96020.0286



Dimension
ø14xø37.5x51

Description

Stabilizer Rubber Bushing

6/8.90 F/FR
8/9.136/170
G 90
L 2000
M 2000

Sampa Nr.

020.080

O.E.M. Nr.

81.96210.0294



Dimension
ø12xø33.5x32

Description

Stabilizer Rubber Bushing

6/8.90
8/9.136/170
G 90
L 2000
M2000 M

Sampa Nr.

O.E.M. Nr.

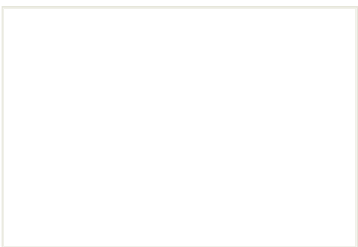

Dimension

Description

Sampa Nr.

020.526

O.E.M. Nr.

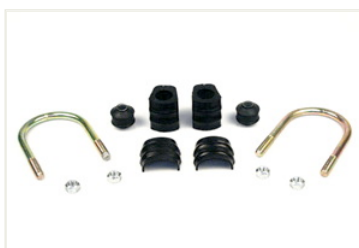

Dimension

Description

Stabilizer Bearing Kit

6/8.90
8/9.136/170
G 90
L 2000
M 2000

Sampa Nr.

O.E.M. Nr.

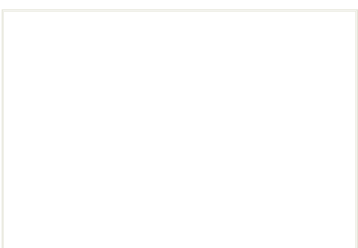

Dimension

Description

Brake

MAN



Sampa Nr.
111.005

O.E.M. Nr.
06.36959.0014
(06.36959.0011)
(06.36959.0018)
(81.93430.0004)

Dimension
ø42xø62x20/25

Description
Ball Bearing for Brake



Sampa Nr.
010.600

O.E.M. Nr.
81.50212.0036 S

Dimension
ø30

Description
Rep. Kit for Brake Shoe



Sampa Nr.
020.531

O.E.M. Nr.
81.51901.6006

Dimension
ø42

Description
Rep. Kit for Camshaft

322/352/402/422/462 FRH ... / 33/34.281/291/321/331/361
EL 202/222/262 - F 2000 - F 90 - M 2000 - M 90 - L 2000
LION'S CLASSIC - MAN 292/332/362
ND/NG/NGT/NL/NM/SD/SG/SL/GS/SL/SUE/UEL/ÖAF



Sampa Nr.
010.682

O.E.M. Nr.
81.50213.6006 S

Dimension
ø20

Description
Rep. Kit for Brake Shoe

10/11.150/180/190/220/230 - 14.170/192 - 14/15.220/15.240
F 2000 - F 90 - L 2000 -TGA - ÖAF
GS UEH 270/290/320/370
LION'S CITY - LION'S CLASSIC - LION'S COACH - NEW FLYER
M 2000 - M 90 - ND 202 - MAN 292/332/362

LION'S CLASSIC	M 90	L 2000
ÖAF	NEW FLYER	F 2000
M 2000	TGA	F 90



Sampa Nr.
010.592

O.E.M. Nr.
81.51901.6005

Dimension
ø42

Description
Rep. Kit for Camshaft

322/352/402/422/462 FRH	F 90	LION'S CLASSIC
33/34.281/291/321/331/361	L 2000	MAN 292/332/362
EL 202/222/262	M 2000	ND/NG/GS/NGT/NL/NM/SL/SD/SG/SUE/UEL/ÖAF
F 2000	M 90	



Sampa Nr.
010.593

O.E.M. Nr.
06.36959.0014 S

Dimension
ø42

Description
Rep. Kit for Camshaft



Sampa Nr.
100.089

O.E.M. Nr.
81.97610.0208
(81.97610.0118)

Dimension
ø26x243

Description
Brake Shoe Spring

14.170/192/220 - 15.220/15.240 ...
34.281/291/321/331/361
F 2000 - F 90 - L 2000 - M 2000 - M 90 - ÖAF - SL 200 - SUE



Sampa Nr.
100.090

O.E.M. Nr.
81.97610.0115
(81.97610.0123)

Dimension
ø26x234

Description
Brake Shoe Spring

14.220 - 15.220/240 ... - 30.281/291/321/331/361
322/352/402/422/462 FRH - EL 202/222/262 - F 2000
LION'S CITY - LION'S CLASSIC - NEW FLYER
MAN 292/332/362
NG - NL - NM - ÖAF - SD - SG - SL - SR - SUE - UEL



Sampa Nr.
020.197

O.E.M. Nr.
81.97610.0271



Dimension
ø30x240

Description
Brake Shoe Spring

16.200/220/240/280/281/290/291/321/331/360/361/370/372
17.220/240
18.310/350/370/400/420/460 - 19.240/281/291/321/331/361
22/24.330-420 - 22/24/25/26.291/331/361
24.310/350/400/460
26/32.240 - 26/32.281/301/321/365
F 2000 - F 90 - L 2000 - M 2000 - M 90
TGA
ÖAF

Sampa Nr.
020.195

O.E.M. Nr.
81.50101.5141
(81.50101.5142)



Dimension
ø265xø452x40

Description
Dust Cover

18.220/230/250/290/310/313/350/370/400/420/460 - 19T
24.350/400 - 28.270
F 2000 - F 90 - L 2000 - M 2000 - M 90 - ÖAF
LION'S CLASSIC
NEW FLYER
SG 28.260/310
SL 18.220/260/280
SUE 223/253/263/313
UEL 242/272/292/312/322

Sampa Nr.
020.087

O.E.M. Nr.
81.96210.0132



Dimension
M10/ø50x45

Description
Rubber Buffer for Brake Pressure Regulator

18.220/290/370 - 26/32.240/281/291/301/321/331/361/365
27/30/32/33/34.281/291/321/331/361 - ÖAF

Sampa Nr.
020.207

O.E.M. Nr.
81.97610.0001



Dimension
ø27x210

Description
Return Spring

14.220
15.220/240
16.200/220/240/280/281/290/291/321/331/360/361/370/372
17.220/240
19.281/291/321/331/361
19/26/32.240
22.220/240/281/291/321/331/361
22/24.330-420
24.220/240/281/291/321/331/361
25.220/240/281/291/321/331/361
26.220/240/281/291/301/321/331/361/365
27/30/33/34.281/291/321/331/361
32.281/291/301/321/331/361/365

Sampa Nr.
116.015

O.E.M. Nr.
81.93021.0117
(81.93021.0141)
(81.93021.0142)
(81.93021.0311)











Dimension
ø30xø34x47.5

Description
Brake Shoe Bushing

10/11.150/180/190/220/230 - 14/15.220/15.240
16.170/192/200/220/240/280/281/290/291/321/331/360/361/370/372
17.170/192/220/240
18.220/230/250/260/280/290/310/313/350/370/400/420/460
19.240/281/291/321/331/361 - 19T
22.220/240/281/291/321/331/361 - 22/24.330-420
24.220/240/281/291/310/321/331/350/361/400/460
25.220/240/281/291/321/331/361
26.220/240/281/291/301/321/331/361/365 - 26T
27/33/34.281/291/321/331/361
28.270
30/32/33/34.281/291/321/331/361
32.240/281/291/301/321/331/361/365
322/352/402/422/462 FRH
EL 202/222/262
GS UEH 270/290/320/370
LION'S CITY - LION'S CLASSIC - LION'S COACH - NEW FLYER
M 2000 - M 90 - F 2000 - F 90 - L 2000 -TGA - TGM - ÖAF
MAN 292/332/362
ND202
NG 232/235/242/252/262/272/312 - NGT 204
NL 202/205/213/222/232/240/250/252/262/312 - NM 152
SD 202
SG 242/280/282/292/322 - SG 28.260/310
SL 18.220/260/280 - SL 200/202
SR 240/280
SUE 223/240/242/253/263/280/313
UEL 242/272/292/312/322

Brake

MAN

 <p><i>Dimension</i></p> <p><i>Description</i></p> <p>Rep. Kit for Brake Caliper</p>	<p><i>Sampa Nr.</i></p> <p>095.509</p> <p><i>O.E.M. Nr.</i></p> <p>MCK-1171/N</p>	 <p><i>Dimension</i></p> <p><i>Description</i></p> <p>Rep. Kit for Brake Caliper</p>	<p><i>Sampa Nr.</i></p> <p>095.510</p> <p><i>O.E.M. Nr.</i></p> <p>MCK-1102/N</p>
 <p><i>Dimension</i></p> <p><i>Description</i></p> <p>Rep. Kit for Brake Caliper</p>	<p><i>Sampa Nr.</i></p> <p>095.511</p> <p><i>O.E.M. Nr.</i></p> <p>MCK 1253</p>	 <p><i>Dimension</i></p> <p><i>Description</i></p> <p>Rep. Kit for Brake Caliper</p>	<p><i>Sampa Nr.</i></p> <p>095.512</p> <p><i>O.E.M. Nr.</i></p> <p>MCK 1254</p>
 <p><i>Dimension</i></p> <p><i>Description</i></p> <p>Rep. Kit for Brake Caliper</p>	<p><i>Sampa Nr.</i></p> <p>095.513</p> <p><i>O.E.M. Nr.</i></p> <p>MCK 1139</p>	 <p><i>Dimension</i></p> <p><i>Description</i></p> <p>Rep. Kit for Brake Caliper</p>	<p><i>Sampa Nr.</i></p> <p>095.514</p> <p><i>O.E.M. Nr.</i></p> <p>MCK 1238</p>
 <p><i>Dimension</i></p> <p><i>Description</i></p> <p>Rep. Kit for Brake Caliper</p>	<p><i>Sampa Nr.</i></p> <p>095.515</p> <p><i>O.E.M. Nr.</i></p> <p>MCK 1171</p>	 <p><i>Dimension</i></p> <p><i>Description</i></p> <p>Rep. Kit for Brake Caliper</p>	<p><i>Sampa Nr.</i></p> <p>095.516</p> <p><i>O.E.M. Nr.</i></p> <p>MCK 1192</p>

<i>Sampa Nr.</i>	
095.524	
<i>O.E.M. Nr.</i> K 001300	
<i>Dimension</i>	
<i>Description</i>	
Rep. Kit for Brake Caliper	

<i>Sampa Nr.</i>	
095.572	
<i>O.E.M. Nr.</i> K 010603	
<i>Dimension</i>	
<i>Description</i>	
Rep. Kit for Brake Caliper	

<i>Sampa Nr.</i>	
095.573	
<i>O.E.M. Nr.</i> K 010604	
<i>Dimension</i>	
<i>Description</i>	
Rep. Kit for Brake Caliper	

<i>Sampa Nr.</i>	
095.581	
<i>O.E.M. Nr.</i> K 000944	
<i>Dimension</i>	
<i>Description</i>	
Rep. Kit for Brake Caliper	

<i>Sampa Nr.</i>	
095.521	
<i>O.E.M. Nr.</i> II 304130065	
<i>Dimension</i>	
<i>Description</i>	
Rep. Kit for Brake Caliper	







<i>Sampa Nr.</i>	
095.519	
<i>O.E.M. Nr.</i> K 000696	
<i>Dimension</i>	
<i>Description</i>	
Rep. Kit for Brake Caliper	

<i>Sampa Nr.</i>	
095.520	
<i>O.E.M. Nr.</i> K 000687	
<i>Dimension</i>	
<i>Description</i>	
Rep. Kit for Brake Caliper	

<i>Sampa Nr.</i>	
095.525	
<i>O.E.M. Nr.</i> II 358510062	
<i>Dimension</i>	
<i>Description</i>	
Rep. Kit for Brake Caliper	

Brake

MAN

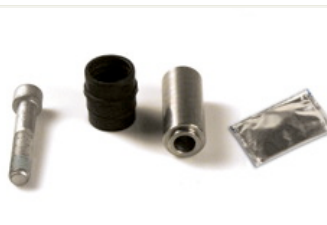
 <p><i>Dimension</i></p>	<p><i>Sampa Nr.</i></p> <p>095.530</p> <p><i>O.E.M. Nr.</i></p> <p>K 001274</p>	 <p><i>Dimension</i></p>	<p><i>Sampa Nr.</i></p> <p>095.531</p> <p><i>O.E.M. Nr.</i></p> <p>K 000375</p>
<p><i>Description</i></p> <p>Rep. Kit for Brake Caliper</p>		<p><i>Description</i></p> <p>Rep. Kit for Brake Caliper</p>	
 <p><i>Dimension</i></p>	<p><i>Sampa Nr.</i></p> <p>095.533</p> <p><i>O.E.M. Nr.</i></p> <p>II 339680062 (II 328090062) (II 369100062)</p>	 <p><i>Dimension</i></p>	<p><i>Sampa Nr.</i></p> <p>095.568</p> <p><i>O.E.M. Nr.</i></p> <p>K 000472</p>
<p><i>Description</i></p> <p>Rep. Kit for Brake Caliper</p>		<p><i>Description</i></p> <p>Rep. Kit for Brake Caliper</p>	
 <p><i>Dimension</i></p>	<p><i>Sampa Nr.</i></p> <p>095.569</p> <p><i>O.E.M. Nr.</i></p> <p>K 001925</p>	 <p><i>Dimension</i></p>	<p><i>Sampa Nr.</i></p> <p>095.570</p> <p><i>O.E.M. Nr.</i></p> <p>K 001532</p>
<p><i>Description</i></p> <p>Rep. Kit for Brake Caliper</p>		<p><i>Description</i></p> <p>Rep. Kit for Brake Caliper</p>	
 <p><i>Dimension</i></p>	<p><i>Sampa Nr.</i></p> <p>095.526</p> <p><i>O.E.M. Nr.</i></p> <p>93161192</p>	 <p><i>Dimension</i></p>	<p><i>Sampa Nr.</i></p> <p>095.518</p> <p><i>O.E.M. Nr.</i></p> <p>II 368470064</p>
<p><i>Description</i></p> <p>Rep. Kit for Brake Caliper</p>		<p><i>Description</i></p> <p>Rep. Kit for Brake Caliper</p>	

<i>Sampa Nr.</i>	
095.527	
<i>O.E.M. Nr.</i> II 197140062	
<i>Description</i>	<i>Dimension</i>
Rep. Kit for Brake Caliper	

<i>Sampa Nr.</i>	
095.528	
<i>O.E.M. Nr.</i> II 179320062	
<i>Description</i>	<i>Dimension</i>
Rep. Kit for Brake Caliper	

<i>Sampa Nr.</i>	
095.529	
<i>O.E.M. Nr.</i> II 197330062	
<i>Description</i>	<i>Dimension</i>
Rep. Kit for Brake Caliper	

<i>Sampa Nr.</i>	
095.522	
<i>O.E.M. Nr.</i> II 39769F0063	
<i>Description</i>	<i>Dimension</i>
Rep. Kit for Brake Caliper	

<i>Sampa Nr.</i>	
095.571	
<i>O.E.M. Nr.</i> K 001301	
<i>Description</i>	<i>Dimension</i>
Rep. Kit for Brake Caliper	





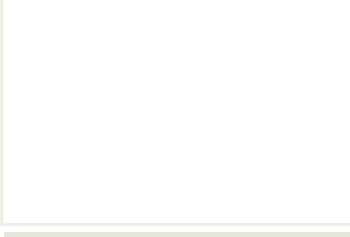







<i>Sampa Nr.</i>	
095.523	
<i>O.E.M. Nr.</i> K 000945	
<i>Description</i>	<i>Dimension</i>
Rep. Kit for Brake Caliper	

<i>Sampa Nr.</i>	
095.567	
<i>O.E.M. Nr.</i> K 000029	
<i>Description</i>	<i>Dimension</i>
Rep. Kit for Brake Caliper	

<i>Sampa Nr.</i>	
<i>O.E.M. Nr.</i>	
<i>Description</i>	<i>Dimension</i>
Rep. Kit for Brake Caliper	

DIAPHRAGMS

MAN

	<p><i>Sampa Nr.</i></p> <p>095.101</p> <p><i>O.E.M. Nr.</i></p> <p>897 120 492.4</p>		<p><i>Sampa Nr.</i></p> <p>095.108</p> <p><i>O.E.M. Nr.</i></p> <p>897 120 540.4</p>
<p>Type 9" Short</p> <p><i>Description</i></p> <p>Short Stroke</p>		<p>Type 30" Short</p> <p><i>Description</i></p> <p>Short Stroke</p>	
	<p><i>Sampa Nr.</i></p> <p>095.103</p> <p><i>O.E.M. Nr.</i></p> <p>897 120 505.4</p>		<p><i>Sampa Nr.</i></p> <p>095.109</p> <p><i>O.E.M. Nr.</i></p> <p>897 120 550.4</p>
<p>Type 12" Short</p> <p><i>Description</i></p> <p>Short Stroke</p>		<p>Type 36" Short</p> <p><i>Description</i></p> <p>Short Stroke</p>	
	<p><i>Sampa Nr.</i></p> <p>095.105</p> <p><i>O.E.M. Nr.</i></p> <p>897 120 510.4</p>		<p><i>Sampa Nr.</i></p> <p>095.110</p> <p><i>O.E.M. Nr.</i></p> <p>897 120 516.4</p>
<p>Type 16" Short</p> <p><i>Description</i></p> <p>Short Stroke</p>		<p>Type 16" Long</p> <p><i>Description</i></p> <p>Long Stroke</p>	
	<p><i>Sampa Nr.</i></p> <p>095.106</p> <p><i>O.E.M. Nr.</i></p> <p>897 120 520.4</p>		<p><i>Sampa Nr.</i></p> <p>095.111</p> <p><i>O.E.M. Nr.</i></p> <p>897 120 526.4</p>
<p>Type 20" Short</p> <p><i>Description</i></p> <p>Short Stroke</p>		<p>Type 20" Long</p> <p><i>Description</i></p> <p>Long Stroke</p>	
	<p><i>Sampa Nr.</i></p> <p>095.107</p> <p><i>O.E.M. Nr.</i></p> <p>897 120 530.4</p>		<p><i>Sampa Nr.</i></p> <p>095.112</p> <p><i>O.E.M. Nr.</i></p> <p>897 120 536.4</p>
<p>Type 24" Short</p> <p><i>Description</i></p> <p>Short Stroke</p>		<p>Type 24" Long</p> <p><i>Description</i></p> <p>Long Stroke</p>	
	<p><i>Sampa Nr.</i></p> <p>095.107</p> <p><i>O.E.M. Nr.</i></p> <p>897 120 530.4</p>		<p><i>Sampa Nr.</i></p> <p>095.113</p> <p><i>O.E.M. Nr.</i></p> <p>897 120 546.4</p>
<p>Type 24" Short</p> <p><i>Description</i></p> <p>Short Stroke</p>		<p>Type 30" Long</p> <p><i>Description</i></p> <p>Long Stroke</p>	



<p>Sampa Nr.</p> <p>100.033</p> <p>O.E.M. Nr.</p> <p>81.35710.0094 (81.35710.0044)</p> <p>Description</p> <p>Thrust Washer (No Hardening)</p>	<p>Dimension</p> <p>ø115xø145x32</p>	<p>Sampa Nr.</p> <p>100.033/1</p> <p>O.E.M. Nr.</p> <p>81.35710.0094 S (81.35710.0044 S)</p> <p>Description</p> <p>Thrust Washer (Surface Hardened)</p>	<p>Dimension</p> <p>ø115xø145x32</p>
<p>19T/26T EL 202/222/262 ND 202 NG 232/235/242/252/262/272/312</p>		<p>NGT 204 NL 202/213/222/232/240/250/252/262/312</p>	
<p>Sampa Nr.</p> <p>100.035</p> <p>O.E.M. Nr.</p> <p>81.35710.0093 (81.35710.0045)</p> <p>Description</p> <p>Thrust Washer (No Hardening)</p>	<p>Dimension</p> <p>ø110xø145x32</p>	<p>Sampa Nr.</p> <p>100.035/1</p> <p>O.E.M. Nr.</p> <p>81.35710.0093 S (81.35710.0045 S)</p> <p>Description</p> <p>Thrust Washer (Surface Hardened)</p>	<p>Dimension</p> <p>ø110xø145x32</p>
<p>16.200/240/280/290/360/370/372 22/24.330-420 27/30/33/34.281/291/321/331/361 26.281/291/321/331/361/365 32.281/291/321/331/361/365 EL 202/222/262 F 90 ND 202</p>		<p>NG 232/235/242/252/262/272/312 NGT 204 NL 202/205/213/222/232/240/250/252/262/312 SD 202 SL 200 SR 240/280 SUE 240/280</p>	
<p>Sampa Nr.</p> <p>020.101</p> <p>O.E.M. Nr.</p> <p>81.41401.0036</p> <p>Description</p> <p>Axle Buffer</p>	<p>Dimension</p> <p>ø81x332x81</p>	<p>Sampa Nr.</p> <p>020.198</p> <p>O.E.M. Nr.</p> <p>81.93001.0319</p> <p>Description</p> <p>Axle Bearing Bushing</p>	<p>Dimension</p> <p>ø40.5xø44.5x32</p>
<p>26.281/291/301/321/331/361 32.281/291/301/321/331/361 33.281/291/321/331/361 34.281/291/321/331/361</p>		<p>F 2000 F 90 L 2000</p> <p>M 2000 M 90 ÖAF</p>	

Wheel - Axle

MAN



Sampa Nr.

010.680

O.E.M. Nr.

81.36305.0015 S

Dimension

ø50x109

Description

King Pin Set

16.170/192	L 2000
16/17.220/240/19.240	M 2000
16/19.281/291/321/331/361	M 90
26/27/32/33/34.281/291/321/331/361	ÖAF
26/32.240/321	TGA
F 2000	
F 90	



Sampa Nr.

010.681

O.E.M. Nr.

81.36305.0014 S
(81.36305.0016 S)
(81.36305.6001 S)

Dimension

ø50xø64x119

Description

King Pin Set

16.170/192 - 6/17.220/240/19.240 - 16/19.281/291/321/331/361
 26/27/32/33/34.291/331/361 - 26/32.240/281/301/321
 F 2000 - F 90 - L 2000 - M 2000 - M 90 - TGA - ÖAF



Sampa Nr.

020.517

O.E.M. Nr.

81.44205.6010

Dimension

ø49.5/ø50x223

Description

King Pin Set

16.170/192/200/240/280/281/290/291/321/331/360/361/372
 17.170/192
 19.240/281/291/321/331/361
 22.220/240/281/291/321/331/361
 24.220/240/281/291/321/331/361
 25.220/240/281/291/321/331/361
 26.220/240/281/291/301/321/331/361/365
 30.281/291/321/331/361
 32.240/281/291/321/301/331/361/365
 33.281/291/321/331/361
 34.281/291/321/331/361
 SG 280/292
 SL 200
 SR 240/280
 SUE 240/280



Sampa Nr.

020.518

O.E.M. Nr.

81.44205.6013

Dimension

ø49.5xø50x223

Description

King Pin Set

16.170/192/200/240/280/281/290/291/321/331/360/361/370/372
 32.240/281/291/301/321/331/361/365 - 322/352/402/422/462 FRH
 F 2000 - F 90 - L 2000 - M 2000 - M 90 - ÖAF
 LION'S CLASSIC - LION'S COACH - NEW FLYER
 ND/NG/NGT/NL/NM/SD/SG/SL/SR/SUE/UEL



Sampa Nr.

020.520

O.E.M. Nr.

81.44205.6016

Dimension

ø34.5/ø35x174.5

Description

King Pin Set

G 90



Sampa Nr.

020.521

O.E.M. Nr.

81.44205.6024

Dimension

ø29.5/ø30x156

Description

King Pin Set



Sampa Nr.
020.527

O.E.M. Nr.
81.44205.6009

Dimension
ø44.5/ø45x213



Description
King Pin Set

14.170/192/220
15.220/240
16.170/192/220/240/281/291/321/331/361
17.170/192/220/240
19/30/33/34.281/291/321/331/361
26/32.240/281/291/301/321/331/361
F 90
M 90
ÖAF

Sampa Nr.
020.528

O.E.M. Nr.
81.44205.6018

Dimension
ø37.5/ø38x192



Description
King Pin Set

10.150/180/190/220/230 - 11.150/180/190/220/230
12.170/192 - 13.210/220/230 - M 90

Sampa Nr.
020.532

O.E.M. Nr.
81.44205.6025

Dimension
ø35/ø36x172



Description
King Pin Set

L 2000
M 2000

Sampa Nr.
020.533

O.E.M. Nr.
81.44205.6023

Dimension
ø50xø51x223



Description
King Pin Set

18.220/230/250/260/280/290/310/313/350/360/370/400/410/420/460
F 2000 - L 2000 - M 2000 - ÖAF
LION'S CITY - LION'S CLASSIC
NG/NL/SG/SL/SUE/UEL / NUE

Sampa Nr.
020.547

O.E.M. Nr.
81.44205.6027

Dimension
ø43x200



Description
King Pin Set

12/14.220 M 2000
14.280 NMT 222
L 2000

Sampa Nr.
020.540

O.E.M. Nr.
81.44205.6020

Dimension
ø34.5xø35x174.5



Description
King Pin Set

L 2000

Sampa Nr.
020.548

O.E.M. Nr.
81.44205.6030

Dimension
ø53x235



Description
King Pin Set

LION'S... TOURLINER 18.220/260/280/310
CENTROLINER TRENDLINER ECT18/26
TGA - TGM ND/NG/NL/NM/NUE/UEL

V-Stay - Axle Control Arm

MAN

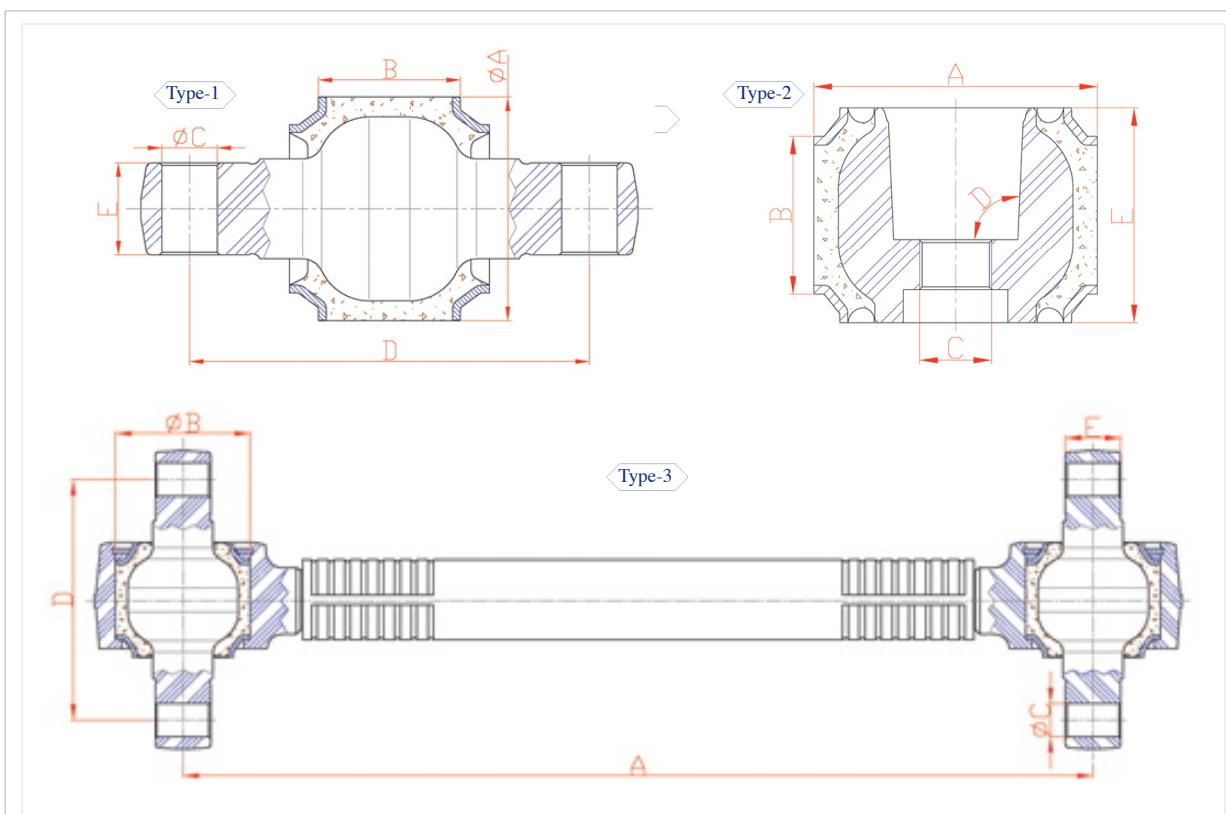

Sampa Nr.	O.E.M. Nr.	A	B	C	D	E	Repair Kit	Type
010.674	81.43220.6202	ø67	43	ø17	100	24	-	1
020.545	81.43220.6108 S	ø72	46.5	ø19	130	30	-	1
010.668	81.43230.6061	ø75	48	ø19	130	24	-	1
020.524	81.43230.6051	ø75	48	ø17	115	24	-	1
020.546	85.43220.6002	ø75	52	ø19	130	24	-	1
020.534	81.43230.6043 S	ø85	52.5	ø19	130	30	-	1
010.578	81.43220.6107	ø80	54	ø19	130	30	-	1
020.509	81.95302.0077	ø85	57.5	21.5/26	129	24	-	1
020.515	81.43270.6105	ø85	57.5	ø25	130	24	-	1
020.519	81.43220.6203	ø85	54	ø21	130	30	-	1
020.541	81.43220.6250	ø85	57.5	ø19	130	24	-	1
010.576	81.43270.6040	ø95	61	ø21	152	24	-	1
020.530	81.43220.6204	ø95	53	M24x2	2°52'	74	-	2
020.536	81.43270.6079	ø95	61	ø23	152	24	-	1
020.537	81.43315.0009	ø95	54	ø19	145	35	-	1
020.543	81.96401.0152	ø95	61	ø19	130	35	-	1
010.672	81.43270.6110	ø100	73	ø25	152	24	-	1
095.206	81.43230.6030	571	ø72	ø19	130	30	020.501	3
095.232	81.43220.6092	590	ø85	ø19	130	30	010.578	3
095.234	81.43220.6052	566	ø85	ø19	130	30	010.578	3
095.237	81.43220.6196	596	ø85	ø19	130	24	020.541	3

V-Stay - Axle Control Arm

MAN



Sampa Nr.

020.158

O.E.M. Nr.

81.96210.0447

Dimension

ø94xø19/130

Description

Axle Rod Mounting

18.220/230/250/280/310/313/350/370/400/420/460
22/24.330 - 24.310/350/400/460 - 28.270 - 322/352/402/422/462 FRH
LION'S... - RH 353/403-SG 28.260/310 - L 18.220/260/280



Sampa Nr.

010.674

O.E.M. Nr.

81.43220.6202

Dimension

ø67xø17/100

Description

Rep. Kit for Axle Rod

L 2000



Sampa Nr.

020.164

O.E.M. Nr.

81.96210.0448

Dimension

M24x2/ø94x75

Description

Axle Rod Mounting

18.220/230/250/280/310/313/350/370/400/420/460
... 322/352/402/422/462 FRH
LION'S CLASSIC - LION'S COACH - LION'S STAR
M 2000 - SG/SL/UFL



Sampa Nr.

010.668

O.E.M. Nr.

81.43230.6061

Dimension

ø75xø19/130

Description

Rep. Kit for Axle Rod

12/14/18.220
24.310/350
EL 202/222/262
ND 202
NG 232/235/242/252/262/272/312
NGT 204
NL 202/205/213/222/232/240/250/252/262/312
NM 152
NMT 222



Sampa Nr.

020.545

O.E.M. Nr.

81.43220.6108 S

Dimension

ø72xø19/130

Description

Rep. Kit for Axle Rod

16/17.170/192 F 90 ÖAF
22/24.330-420 M 90



Sampa Nr.

020.546

O.E.M. Nr.

85.43220.6002

Dimension

ø75xø19/130

Description

Rep. Kit for Axle Rod

14.280 ND 313/363
ECT18T/26T RH 403/463
F 2000 STARLINER
L 2000 TGA
LION'S COACH TOURLINER
LION'S REGIO TRENDLINER
LION'S STAR UEL 313/353



Sampa Nr.

020.524

O.E.M. Nr.

**81.43230.6051
(81.43230.6068)**

Dimension

ø75xø17/115

Description

Rep. Kit for Axle Rod

18.260/310/313... L 2000 - M 2000
24.350/400 - F 2000 M 90
F 90 ÖAF





Sampa Nr.	
020.534	
O.E.M. Nr.	
81.43230.6043 S	
Dimension	ø80xø19/130
Description	
Rep. Kit for Axle Rod	
12.170/192 14.170/192/220 15.220/240 16.220/240/280/281/290/291/321/331/360/361/370/372 17.220/240 19.281/291/321/331/361 22/24.330-420 22/24/25/26.220/240/281/291/321/331/361 F 90 M 90	

Sampa Nr.	
010.578	
O.E.M. Nr.	
81.43220.6107 (81.43220.6055)	
Dimension	ø85xø19/130
Description	
Rep. Kit for Axle Rod	
12/14.220 - 13.210/220/230 ... 322/352/402/422/462 FRH CENTROLINER LION'S CITY - LION'S CLASSIC - LION'S COACH - LION'S REGIO LION'S STAR - NEW FLYER - STARLINER - TOURLINER - TRENDLINER ND 202/313/363 - NG 232/ 235/242/243/252/262/263/272/312/313 NGT 204 NL 202/205/213/222/223/232/240/242/243/250/262/263/283/312/313 NM 223/283 - NMT 222 - NUE 263/313/353 - RH 353/403/463 SG 28.260/310 - SUE 223/253/263/313 TGA - UEL 313/353	

Sampa Nr.	
020.509	
O.E.M. Nr.	
81.95302.0077	
Dimension	ø85xø21.5/26x129
Description	
Rep. Kit for Axle Rod	
UEL 313/353 MAN 322/352/402/422/462 FRH RH 352/402/403/422	

Sampa Nr.	
095.232	
O.E.M. Nr.	
81.43220.6092 (81.43220.6067) (81.43220.6068) (81.43220.6090)	
Dimension	
Description	
Tie Rod	
26T F 2000 F 90	
ÖAF TGA	

Sampa Nr.	
020.515	
O.E.M. Nr.	
81.43270.6105	
Dimension	ø85xø25/130
Description	
Rep. Kit for Axle Rod	
ECT18/26 F 2000 ÖAF TGA	

Sampa Nr.		
095.234		
O.E.M. Nr.		
81.43220.6052 (81.43220.6010) (81.43220.6012) (81.43220.6013) (81.43220.6020) (81.43220.6035) (81.43220.6040) (81.43220.6041) (81.43220.6056)		
Dimension		566
Description		
Tie Rod		
26.240/281/291/301/321/331/361/365 27.281/291/321/331/361 30.281/291/321/331/361 - 32.240/281/291/301/321/331/361/365 33.281/291/321/331/361 - 34.281/291/321/331/361		

O.E.M. Numbers are stated for comparison purposes only. It is not permitted to mention original numbers on invoices owners.







Sampa Nr.	
020.537	
O.E.M. Nr.	
81.43315.0009	
Dimension	$\varnothing 95 \times \varnothing 19 / 145$
Description	Rep. Kit for Axle Rod
18.260/310/350/360/370/400/410/420/460 322/352/402/422/462 FRH LION'S COACH LION'S REGIO LION'S STAR RH 353/403/463 STARLINER TOURLINER TRENDLINER UEL 313/353	

Sampa Nr.	
020.543	
O.E.M. Nr.	
81.96401.0152	
Dimension	$\varnothing 95 \times \varnothing 19 \times 130$
Description	Rep. Kit for Axle Rod
F 2000 F 90 ÖAF TGA	

Sampa Nr.	
010.672	
O.E.M. Nr.	
81.43270.6110	
Dimension	$\varnothing 100 \times \varnothing 25 / 152$
Description	Rep. Kit for Axle Rod
ÖAF TGA F 2000	

Sampa Nr.	
020.535	
O.E.M. Nr.	
81.43250.6009	
Dimension	$\varnothing 20 \times \varnothing 46 \times 60$
Description	Rep. Kit for Axle Rod
8/9.136/170 G 90 L 2000 TGL	

Sampa Nr.	
020.501	
O.E.M. Nr.	
81.43220.6108 (81.43220.6132)	
Dimension	$\varnothing 72 \times \varnothing 19 / 130$
Description	Rep. Kit for Axle Rod
16.170/192 17.170/192 22/24.330-420 F 90 M 90 ÖAF	

Sampa Nr.	
095.206	
O.E.M. Nr.	
81.43230.6030 (81.43220.6096) (81.43220.6097) (81.43220.6098) (81.43220.6129) (81.43230.6014)	
Dimension	571
Description	Tie Rod
22/24.330-420 F 90 M 90	

V-Stay - Axle Control Arm

MAN

	<p><i>Sampa Nr.</i></p> <p>020.512</p> <p><i>O.E.M. Nr.</i></p> <p>81.43270.6065</p>		<p><i>Sampa Nr.</i></p> <p>020.503</p> <p><i>O.E.M. Nr.</i></p> <p>81.95301.6132 (81.43270.6080)</p>
<p><i>Dimension</i></p> <p>M20x1.5/ø72x46</p>		<p><i>Dimension</i></p> <p>M24x1.5/ø90x59</p>	
<p><i>Description</i></p> <p>Rep. Kit for Axle Rod</p>		<p><i>Description</i></p> <p>Rep. Kit for Axle Rod</p>	
<p>14.280 F 90 L 2000 M 2000 M 90 ÖAF</p>		<p>12.170/192 - 14.170/192 16.170/192/240/280/290/360/370/372 - 17.170/192 18.310/313/350/360/370/400/410/420/460 22/24.330-420 - 24.310/350/400/460 F 2000 - F 90 ÖAF</p>	
	<p><i>Sampa Nr.</i></p> <p>020.502</p> <p><i>O.E.M. Nr.</i></p> <p>81.43230.6043</p>		<p><i>Sampa Nr.</i></p> <p>020.504</p> <p><i>O.E.M. Nr.</i></p> <p>81.95301.6133</p>
<p><i>Dimension</i></p> <p>ø80xø19/130</p>		<p><i>Dimension</i></p> <p>ø90xø23/152</p>	
<p><i>Description</i></p> <p>Rep. Kit for Axle Rod</p>		<p><i>Description</i></p> <p>Rep. Kit for Axle Rod</p>	
<p>12.170/192 - 14.170/192 - 14.240 15.220/240 - 16.220/240/280/281/290/291/321/331/360/361/370/372 17.220/240 - 19.281/291/321/331/361 22/24.330-420 - 22/24/25/26.220/240/281/291/321/331/361 F 90 - M 90</p>		<p>12.170/192 14.170/192 16.170/192 17.170/192 22/24.330-420</p>	
	<p><i>Sampa Nr.</i></p> <p>020.539</p> <p><i>O.E.M. Nr.</i></p> <p>81.43270.6047</p>		<p><i>Sampa Nr.</i></p> <p>095.208</p> <p><i>O.E.M. Nr.</i></p> <p>81.43270.6030 (81.43270.6034) (81.43270.6054) (81.43270.6055) (81.43270.6078) (81.43270.9054) (81.43270.9078)</p>
<p><i>Dimension</i></p> <p>M24x1.5/ø90x60</p>		<p><i>Dimension</i></p> <p>621</p>	
<p><i>Description</i></p> <p>Rep. Kit for Axle Rod</p>		<p><i>Description</i></p> <p>V-Arm</p>	
		<p>14.220 15.220/240 16/17.220/240/281/291/321/331/361 19.281/291/321/331/361 22/24/25/26.220/240/281/291/321/331/361 F 2000 F 90</p>	

V-Stay - Axle Control Arm

MAN

Sampa Nr.

020.503

O.E.M. Nr.

81.95301.6132
(81.43270.6080)



Dimension

M24x1.5/ø90x59

Description

Rep. Kit for Axle Rod

12.170/192
14.170/192
16.170/192/240/280/290/360/370/372
17.170/192
18.310/313/350/360/370/400/410/420/460
22/24.330-420
24.310/350/400/460
F 2000
F 90
ÖAF

Sampa Nr.

020.515

O.E.M. Nr.

81.43270.6105



Dimension

ø85xø25/130

Description

Rep. Kit for Axle Rod

ECT18/26
F 2000
ÖAF
TGA

Sampa Nr.

095.233

O.E.M. Nr.

81.43270.6096

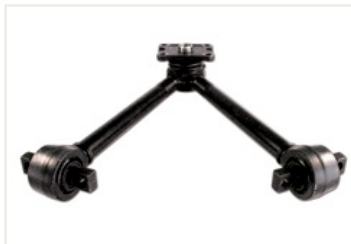

Dimension

627

Description

V-Arm

ECT 26T
TGA

Sampa Nr.

O.E.M. Nr.

Dimension

Description

Sampa Nr.

O.E.M. Nr.

Dimension

Description

Sampa Nr.

O.E.M. Nr.

Dimension

Description

Engine - Flywheel

MAN



Sampa Nr.

100.055

O.E.M. Nr.

51.02130.0013
(51.93020.0236)

Dimension

ø115xø120x21

Description

Intermediate Ring, (No Hardening)

D2066	D2842	G2866
D2530	D2865	G2876
D2565	D2866	GS UEH
D2566	D2876	270/290/320/370
D2676	E2866	
D2840	E2876	



Sampa Nr.

100.055/1

O.E.M. Nr.

51.02130.0013 S
(51.93020.0236 S)

Dimension

ø115xø120x21

Description

Intermediate Ring, (Surface Hardened)

D2066	D2842	G2866
D2530	D2865	G2876
D2565	D2866	GS UEH
D2566	D2876	270/290/320/370
D2676	E2866	
D2840	E2876	

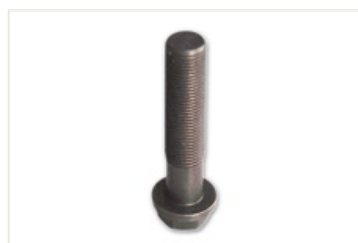

Sampa Nr.

020.062

O.E.M. Nr.

51.90020.0298
(51.90020.0349)
(51.90030.0025)

Dimension

M16x1.5/72

Description

Flywheel Bolt

D2066	D2842	E2876
D2565	D2865	G2866
D2566	D2866	G2876
D2676	D2876	
D2840	E2866	

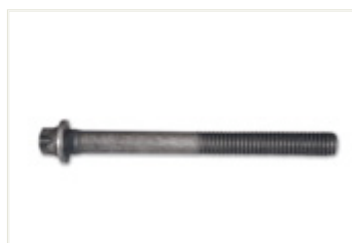

Sampa Nr.

020.063

O.E.M. Nr.

51.90020.0356
(51.90020.0284)
(51.90020.0357)
(51.90020.0381)
(51.90020.0275)

Dimension

Te14x2/140

Description

Cylinder Head Bolt

D0824
D0826
G0826



Sampa Nr.

020.065

O.E.M. Nr.

51.90490.0023
(51.90020.0269)
(51.90020.0235)

Dimension

M15x2/143

Description

Cylinder Head Bolt

D2530	D2866
D2565	D2876
D2566	E2866
D2840	E2876
D2842	G2866
D2865	G2876

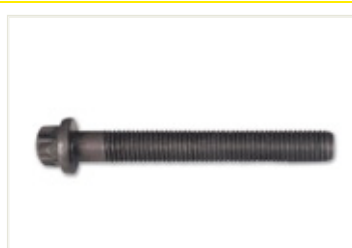

Sampa Nr.

020.066

O.E.M. Nr.

51.90490.0024
(51.90020.0270)
(51.90020.0236)

Dimension

M15x2/110

Description

Cylinder Head Bolt

D2530	D2866
D2565	D2876
D2566	E2866
D2840	E2876
D2842	G2866
D2865	G2876



Sampa Nr.

020.306

O.E.M. Nr.

81.96020.0341
(81.96020.0373)
(81.96020.0385)
(81.96020.0408)
(81.96020.0418)



Dimension

ø107x85

Description

Engine Mounting

18.220/260/290/310/313/350/360/370/400/410/420/460
 22/24.330-420 - 24.310/350/400/460 - 26T
 322/352/402/422/462 FRH
 D2840 - F 2000 - F 90 - M 2000
 LION'S COACH
 ÖAF
 RH 353/403/463
 TGA

Sampa Nr.

020.309

O.E.M. Nr.

81.96020.0205
(81.96020.0235)



Dimension

ø96x84

Description

Engine Mounting

10/11.150/180/190/220/230 - 12.170/192 - 14.170/192
 16.170/192 - 17.170/192
 8/9.136/170
 CENTROLINER - GOEPEL-AUFBAU - LION'S CITY
 D2866 - D2876 - G 90 - L 2000 - M 90
 NL 223/263/313
 ÖAF

Sampa Nr.

020.310

O.E.M. Nr.

81.96020.0202
(81.96020.0239)
(81.96210.0509)



Dimension

ø80x55.5

Description

Engine Mounting

10/11.150/180/190/220/230 - 12.170/192/220
 13.210/220/230 - 14.170/192/220
 16/17.170/192 - 266M-STAR
 6/8.90 F/FR - 8/9.136/170
 F 2000 - F 90 - G 90 - L 2000 - M 2000 - M 90
 ÖAF
 SG 292

Sampa Nr.

020.312

O.E.M. Nr.

81.96020.0382
(88.96210.0004)



Dimension

ø96x84

Description

Engine Mounting

10/11.150/180/190/220/230 - 12.220
 13.210/220/230 - 14.280 - 18.220/230/250/280
 266M-STAR - D0836 - F 90 - L 2000 - M 2000 - M 90
 LION'S CITY - LION'S CLASSIC
 ÖAF
 SL 18.220/260/280
 SUE 223/253/263/313

Sampa Nr.

020.313

O.E.M. Nr.

81.96020.0403
(81.96020.0391)



Dimension

ø96x84

Description

Engine Mounting

12.220 - 18.220/290/370 - 26T
 CENTROLINER
 F 2000 - F 90 - L 2000
 LION'S CITY
 M 2000
 NG 263/313 - NL 223/263/313
 ÖAF

Sampa Nr.

020.314

O.E.M. Nr.

81.96020.0386



Dimension

ø88x72

Description

Engine Mounting

322/352/402/422/462 FRH
 LION'S COACH
 RH 353/403/463

Engine - Flywheel / Propeller Shaft

MAN



Sampa Nr.

020.315

O.E.M. Nr.

81.96020.0384

Dimension

ø107x85

Description

Engine Mounting

322/352/402/422/462

FRH

12.220

CENTROLINER

LION'S CITY

LION'S COACH

NG 263/313

NL 223/263/313

NM 223/283

RH 353/403/463



Sampa Nr.

020.157

O.E.M. Nr.

81.39410.6017

(81.39410.6013)

(81.99804.3084)

Dimension

ø65

Description

Propeller Shaft Bearing

16.170/192/200/240/280/281/290/291/321/331/360/361/372

17.170/192

19.240/281/291/321/331/361

22.220/240/281/291/321/331/361

24.220/240/281/291/321/331/361

25.220/240/281/291/321/331/361

26.220/240/281/291/301/321/331/361/365

30.281/291/321/331/361

32.240/281/291/321/301/331/361/365

33.281/291/321/331/361

34.281/291/321/331/361

SG 280/292 - SL 200

SR 240/280

SUE 240/280



Sampa Nr.

020.318

O.E.M. Nr.

81.96020.0402

Dimension

ø126x105

Description

Engine Mounting

F 2000

ÖAF



Sampa Nr.

020.181

O.E.M. Nr.

81.39410.6018

(81.39410.6016)

Dimension

ø100

Description

Propeller Shaft Bearing

L 2000

M 2000



Sampa Nr.

020.319

O.E.M. Nr.

81.96020.0340

Dimension

ø88x72

Description

Engine Mounting

18.220/260/290/310/313/350/360/370/400/410/420/460

22/24.330-420

24.310/350/400/460

F 2000

F 90

NM 223/283

ÖAF



Sampa Nr.

020.213

O.E.M. Nr.

81.39410.6023

(81.39410.6031)

Dimension

ø85

Description

Propeller Shaft Bearing

12.220

18.220/290/370

26T

CENTROLINER

F 2000

F 90

L 2000

LION'S CITY

M 2000

NG 263/313

NL 223/263/313

ÖAF

Sampa Nr.

020.076

O.E.M. Nr.

81.95301.6202
(81.95301.6227)
(81.95301.6200)



Dimension

M10x1.25/M14x1.5

Description

Ball Joint

18.220/230/250/260/280/290/310 - 18.310/313/350/370/400/420/460
 22/24.330-420 - 24.310/350/400/460
 322/352/402/422/462 FRH
 8/9.136/170
 EL 202/222/262
 F 2000 - F 90 - G 90 - L 2000
 LION'S CITY - LION'S CLASSIC
 M 90 - M2000 L - M2000 M
 ÖAF
 RH 352/402/422 - RH 353/403 F
 SL 18.220/260/280 - SUE 223/242/253/263/313
 TGL - TGM
 UEL 242/272/292/312/ 313/322/353

Sampa Nr.

100.007

O.E.M. Nr.

81.95301.0045

Dimension

M10x1/M14x1.5

Description

Ball Joint

16.240/280/290/360/372
 12.170/192
 14.170/192
 16/17.170/192
 16.170/192
 16/19.281/291/321/331/361
 26/32/33/34.281/291/321/331/361
 26/27/32/33/34.281/291/321/331/361
 30/32/33/34.281/291/321/331/361
 16/17.220/240/19.240
 22/24/25/26.220/240
 14/15.220/15.240
 16/17.220/240
 26/32.365
 SUE 240/280
 SL 202

GS UEH 270/290/320/370
 8.125 STAR
 12.155 STAR
 18.220/230/250
 18.230/250
 L 2000
 M 2000
 L 2000
 MAN 292/332/362

Sampa Nr.

100.008

O.E.M. Nr.

81.95301.6171
(81.95301.6063)
(81.95301.6131)
(81.95301.6174)



Dimension

M10x1.5/M12x1.75L

Description

Ball Joint, Left

18.220/230/250
 18.220/290/370
 LION'S CLASSIC
 SL 18.220/260/280

TGM

Sampa Nr.

020.104

O.E.M. Nr.

81.96210.0089

Dimension

M16/ø100x74

Description

Gearbox Mounting

12.220
 14.280
 14/15.220
 15.240
 16.240/280/290/360/370/372
 16/17.220/240/19.240
 16/19.281/291/321/331/361
 18.220/280/310/313/310/350/360/370/400/410/420/460
 19.240 H
 22/24.330-420
 22/24/25/26.220/240/281/291/321/331/361
 24.350/400/460
 26/32.240/281/291/301/321/331/361/365
 27/33/34.281/291/321/331/361
 F 2000
 F 90
 ÖAF

Sampa Nr.

100.009

O.E.M. Nr.

81.95301.6170
(81.95301.6064)
(81.95301.6130)
(81.95301.6173)



Dimension

M10x1.5/M12x1.75R

Description

Ball Joint, Right

F 2000
 F 90
 G 90
 L 2000

M 2000
 M 90
 TGM
 TGL

MAN

Cooling System

MAN

 <p>Dimension ø13xø68.5x20</p> <p>Description Rubber Mounting for Radiator</p> <p>10/11.150/180/190/220/230 16.200/240/280/290/360/370/372 18.220/230/250/260/280/310/313/350/370/400/420 - 19.240 22/24.330-420 - 26/32.281/301/321 - 28.270 322/352/402/422/462 FRH EL 202/222/262 F 2000 - F 90 - TGA LION'S CITY - LION'S CLASSIC ND202 - NG 232/242/252/262/272/312 NL 202/205/213/222/232/250/252/262/310/312 - NM152</p>	<p>Sampa Nr. 020.082</p> <p>O.E.M. Nr. 81.96210.0248 (81.96210.0243)</p>	 <p>Dimension M8/ø40x30</p> <p>Description Rubber Mounting for Radiator</p>	<p>Sampa Nr. 020.088</p> <p>O.E.M. Nr. 81.96020.0056 (81.96020.7000) (51.96210.0002)</p>
 <p>Dimension M10/ø50x30</p> <p>Description Rubber Mounting for Radiator</p>	<p>Sampa Nr. 020.089</p> <p>O.E.M. Nr. 81.96210.0119</p>	 <p>Dimension ø22xø56x21.5</p> <p>Description Rubber Mounting for Radiator</p> <p>10/11.150/180/190/220/230 12/14.170/192 16/17.170/192 6/8.90 8.136 8/9.136/170</p> <p>F 2000 G 90 M 2000 M M 90 ÖAF</p>	<p>Sampa Nr. 020.092</p> <p>O.E.M. Nr. 81.96210.0240 (81.43706.0006)</p>
 <p>Dimension M10/ø50x45</p> <p>Description Rubber Mounting for Radiator</p> <p>18.220/230/250/260/280/310/313/350/370/400/420/460 22/24.330-420 - 24.350/400/460 L 2000 LION'S CITY M 90 RH 352/402/422 SL 18.220/260/280 - SUE 223/253/263/313</p>	<p>Sampa Nr. 020.094</p> <p>O.E.M. Nr. 81.96210.0100</p>	 <p>Dimension ø12xø38.5x44</p> <p>Description Rubber Mounting for Radiator</p> <p>10/11.150/180/190/220/230 - 12.220 13.210/220/230 - 14.220/280 - 18.220 18.310/313/350/370/400/420/460 22/24.330-420 - 24.310/350/400/460 - 26T - 28.270 F 2000 - F 90 LION'S CLASSIC - LION'S COACH - LION'S REGIO - TRENDLINER M 2000 - NM 223/283 ÖAF SG 28.260/310 - SUE 223/253/263/313</p>	<p>Sampa Nr. 020.187</p> <p>O.E.M. Nr. 81.96210.0426</p>



Sampa Nr.	
020.060	
O.E.M. Nr.	
51.90001.0167	
(51.90001.0122) (51.90430.0046)	
Dimension	M10x1.5/75
Description	Exhaust Manifold Bolt
D2566 D2842 D2866	

Sampa Nr.		
020.061		
O.E.M. Nr.		
51.90001.0169		
(51.90430.0044)		
Dimension	M10x1.5/55	
Description	Exhaust Manifold Bolt	
D0226 D0824 D0826	D2530 D2565 D2566	D2866 G0826

Sampa Nr.		
020.067		
O.E.M. Nr.		
51.90490.0029		
(51.90001.0168) (51.90490.0033)		
Dimension	M10x1.5/50	
Description	Exhaust Manifold Bolt	
D0824 D0826 D0834	D0836 D2840 D2866	

Sampa Nr.			
020.068			
O.E.M. Nr.			
51.90490.0030			
(51.90001.0156) (51.90001.0166)			
Dimension	M10x1.5/55		
Description	Exhaust Manifold Bolt		
D0824 D0826 D0834 D0836	D2565 D2566 D2840 D2842	D2866 E2866 F 2000 G2866	ÖAF

Sampa Nr.	
020.085	
O.E.M. Nr.	
81.96210.0101	
Dimension	M10/ø50x40
Description	Rubber Mounting for Exhaust
<p>12.220 - 14.220/280 - 15.220/15.240 ... 30/32/33/34.281/291/321/331/361 - 322/352/402/422/462 FRH CENTROLINER F 2000 - F 90 LION'S CITY - LION'S CLASSIC - LION'S COACH - LION'S STAR MAN 292/332/362 HF ND 313/363 - NG 232/235/252/262/263/272/312/313 - NL 202/213/205/222/223/232/240/242/243/250/252/262/283/310/312/313 NL/NUE 263/313/353 - NM 223/283 ÖAF - TGA RH 353/403/463 SG 242/292/322 - SG 28.260/310 SL 18.220/260/280 - SL 200/202 - SR 240/280 STARLINER - TOURLINER SUE 223/240/242/280/290/253/263/313 UEL 242/272/292/312/313/322/353</p>	

Sampa Nr.	
020.090	
O.E.M. Nr.	
81.96210.0052	
(81.96210.0301)	
Dimension	M8/ø40x30
Description	Rubber Mounting for Exhaust
<p>10/11.150/180/190/220/230 ... - 322/352/402/422/462 FRH 8/9.136/170 F 2000 - F 90 - G 90 - L 2000 LION'S CITY - CENTROLINER M 90 - M2000 L - M2000 M MAN 292 ND 202/313/363 FR - NG 232/242/252/262/263/272/312/313 NL 202/213/222/223/ 232 /250/252/262/ 263/310/312/313/353 NM 152/223/283 - NUE 263/313/353 ÖAF RH 352/353/402/403/422 SD 202 F - SG 242/280/292/322 - SL 200/202 SR 240/280 - SUE 240/242/280/290 TGA UEL 242/272/292/312/322</p>	

Exhaust / Shock Absorber

MAN

	Sampa Nr. 020.096
	O.E.M. Nr. 81.96210.0153 (81.96210.0127)
Dimension M10/ø50x30	
Description Rubber Mounting for Exhaust	
16.220/240/280/281/290/291/321/331/360/361/370 /372 17.220/240 18.220/290/370 FOC/R-SKD-RSA 19.240/281/291/321/331/361 22/24.330-420 22/24/25/26.291/331/361 26/32.240/281/301/321 28.270 30/32/33/34.281/291/321/331/361 CENTROLINER F 2000 F 90 L 2000 LION'S CITY M 2000 M NG 263/313 F NL 223/242 /243/283 NL/NUE 263/313/353 ÖAF RH 403/463 SD 202 F SG 28.260/310 SUE 223/242/253/263/313 TGA	

	Sampa Nr. 020.138
	O.E.M. Nr. 81.61140.0016
Dimension 685 mm	
Description Gas Spring	
ECT18/26 TGA	

	Sampa Nr. 020.139
	O.E.M. Nr. 81.74821.0095
Dimension 720 mm/220 N	
Description Gas Spring	
18.220/290/370 F 2000 F 90 M 2000 M 90 ÖAF	

	Sampa Nr. 020.097
	O.E.M. Nr. 81.96210.0130
Dimension M10/ø50x45	
Description Rubber Mounting for Exhaust	
19240 26/32.240 F 2000	

	Sampa Nr. 020.140
	O.E.M. Nr. 81.61130.6500
Dimension 350 mm/220 N	
Description Gas Spring	





Sampa Nr.	
020.051	
O.E.M. Nr.	
06.02815.8812	
(06.02814.2812)	
(06.02813.4812)	
(06.02792.5010)	
(06.02791.5010)	
Dimension	M12x1.5/35
Description	Tensilock Screw

Sampa Nr.	
020.052	
O.E.M. Nr.	
06.02815.8911	
(06.02792.5109)	
(06.02814.2911)	
(06.02813.4911)	
(06.02816.0911)	
Dimension	M14x1.5/30
Description	Tensilock Screw

Sampa Nr.	
020.053	
O.E.M. Nr.	
06.02815.8912	
(06.02814.2912)	
(06.02813.4912)	
(06.02792.5110)	
(06.02816.0912)	
(06.02791.5110)	
Dimension	M14x1.5/35
Description	Tensilock Screw

Sampa Nr.	
020.054	
O.E.M. Nr.	
06.02815.8914	
(06.02792.5112)	
(06.02813.4914)	
(06.02814.2914)	
(06.02819.0006)	
Dimension	M14x1.5/45
Description	Tensilock Screw

Sampa Nr.	
020.055	
O.E.M. Nr.	
06.02815.8916	
(06.02814.2916)	
(06.02813.4916)	
(06.02202.0609)	
Dimension	M14x1.5/55
Description	Tensilock Screw

Sampa Nr.	
020.056	
O.E.M. Nr.	
06.02815.8917	
(06.02814.2917)	
(06.02813.4917)	
Dimension	M14x1.5/60
Description	Tensilock Screw



Chassis - Body

MAN

 <p>Dimension M14x1.5/50</p> <p>Description Tensilock Screw</p>	<p>Sampa Nr. 020.146</p> <p>O.E.M. Nr. 06.02815.8915 (06.02813.4915) (06.02814.2915)</p>	 <p>Dimension M14x1.5/40</p> <p>Description Tensilock Screw</p>	<p>Sampa Nr. 020.147</p> <p>O.E.M. Nr. 06.02815.8913 (06.02792.5111) (06.02814.2913) (06.02813.4913)</p>
 <p>Dimension M14x1.5/70</p> <p>Description Tensilock Screw</p>	<p>Sampa Nr. 020.152</p> <p>O.E.M. Nr. 06.02813.4919 (06.02814.2919) (06.02815.8919)</p>	 <p>Dimension M14x1.5/14</p> <p>Description Flat Collar Nut</p>	<p>Sampa Nr. 020.151</p> <p>O.E.M. Nr. 06.11251.2105 (06.11251.8105) (06.11251.2005)</p>
 <p>Dimension M16x1.5/40</p> <p>Description Tensilock Screw</p>	<p>Sampa Nr. 020.057</p> <p>O.E.M. Nr. 06.02815.9013 (06.02791.5211) (06.02813.5013) (06.02792.5211) (06.02814.3013) (06.02816.1013)</p>	 <p>Dimension M16x1.5/50</p> <p>Description Tensilock Screw</p>	<p>Sampa Nr. 020.058</p> <p>O.E.M. Nr. 06.02815.9015 (06.02792.5213) (06.02814.3015)</p>

Sampa Nr.	
020.059	
O.E.M. Nr. 06.02815.9017 (06.02814.3017)	
Dimension	M16x1.5/60
Description	Tensilock Screw

Sampa Nr.	
020.153	
O.E.M. Nr. 06.02815.9022 (06.02814.3022) (06.02813.5022)	
Dimension	M16x1.5/85
Description	Tensilock Screw

Sampa Nr.	
020.150	
O.E.M. Nr. 06.11251.8108 (06.11251.2108)	
Dimension	M16x1.5/16
Description	Flat Collar Nut

Sampa Nr.	
020.091	
O.E.M. Nr. 81.96210.0289 (83.96210.0508)	
Dimension	M8/ø30x20
Description	Air Filter Mounting
<p>18.220/230/250 - EL 202/222/262 - F 90 LION'S CITY - LION'S CLASSIC M 2000 - NL 202/213/222/250/262/312 - ÖAF SL 200 - SR 240/280-12 M RUE 240/280 - SUE 240/280 - TGA</p>	

Sampa Nr.	
020.075	
O.E.M. Nr. 81.95301.6144 (06.36090.0605) (81.95301.7004)	
Dimension	M8x1.25/M8x1.25R
Description	Ball Joint, Right
<p>10/11.150/180/190/220/230 - 12.170/192 - 13.210/220/230 14.170/192 - 14/15.220/15.240 - 16.240/280/290/360/370/372 16/17.170/192/220/240/19.240 - 16/19.281/291/321/331/361 18.220/290/370 - 22/24.330-420 22/24/25/26.220/240/281/291/321/331/361 - 24.400/460 26/27/30/32/33/34.281/291/321/331/361 - 26/32.365 - 26T 6/8.90 - 8/9.136/170 CENTROLINER - LION'S CITY D2840 - ECT26 F 2000 - F 90 - G 90 - L 2000 - M 90 - TGA - ÖAF GS UEH 270/290/320/370 MAN 292/322/332/352/362/402/422/462 NG 242/272/312 - NGT 204 - NL/NUE 263/313/353 NL202/213/222/250/262/312 SG 242/280/282/292/322 - SL 200/202 - SR 240/280 - SUE 240/242/280 UEL 242/272/292/312/322</p>	

Sampa Nr.	
020.077	
O.E.M. Nr. 81.95301.6204	
Dimension	M8x1.25/M8x1.25L
Description	Ball Joint, Left
<p>10/11.150/180/190/220/230 13.210/220/230 F 90 G 90 L 2000 M 90 ÖAF SL202 SUE 240/280/290</p>	

