



# Elementos y kits de reparación de **Cabeza** **Tractora**

*Spares and repair  
kits for the **Truck***



**ONYARBI**  
industrias



**Industrias Onyarbi**, empresa fundada hace más de 20 años, ha expandido continuamente su gama de productos para todo tipo de vehículos industriales (Cabezas Tractoras y Semi-Remolques) de los fabricantes más importantes de Europa.

Con la experiencia y el afán de mejora continua, avalados por un sistema de gestión certificado por TÜV Rheiland según norma DIN EN ISO 9001:2000, alcanzamos nuestra meta, que no es otra que la satisfacción de nuestros clientes.

Dentro de la amplia gama de productos para la automoción presentamos este catálogo específico de **“Elementos y Kits de Reparación de Cabeza Tractora”**, dividiéndolo en los apartados de Rótulas de Dirección, Palancas Automáticas, Barra Estabilizadora, Kit de Tirantes, Amortiguadores y Kits de Reparación de Bulón de Mangueta.

La intención es dar continuidad al afán de superación en la calidad y competitividad de nuestros productos.





***Industrias Onyarbi**, a company founded more than 20 years ago, has been expanding its range of products continually for all kind of industrial vehicles (Trucks and Semi-Trailers) for the most important European manufacturers.*

*With our experience and the urge to improve continually, endorsed by a management system certified by TÜV Rheiland according to DIN EN ISO 9001:2000, we achieve our goals, which is non other than to satisfy our customers.*

*In our wide range of products for the Heavy Duty Industry we are bringing out a new specialized catalogue for **“Components and Repair kits for Truck”**, separated into six sections for Tie Rods Ends, Automatic Slack Adjusters, Stabilizer Group, Torque Rod Kits, Shock Absorbers and King Pin Sets.*

*Our intention is to continue to improve the quality and the competitiveness of our products.*



Aplicación Application	Vehículo Vehicule	Pág.
<b>Renault</b>	Magnum AE 420, Magnum AE 386, Premium, R340, R350	8
	Midliner (M-S)	8
	Midliner	9
	S, J	9
	<b>Volvo</b>	B6, F6
	F7, F10, F12, F16, FL6, FL7, FL10, FL12	10
	FL7, FL10, FL12	11
	F7, F10, F12, F16, FL7, FH12, FH16	11
	B7R, B10B, B10M, B12, F4, F10, F12, FL7, FL10	11
	B7R, B10B, B10M, B12, F4, F10, F12, FL7, FL10	12
<b>Scania</b>	Series 2, Series 3, Series 4	12
<b>MAN</b>	F2000, F90, M2000, M90, SG, SL, TGA	13
	F2000, L2000, M2000, M90	13
	F2000, L2000, M2000, M90	14
	G90, L2000, M2000	14
	L2000, M2000, M90, G90	14

Aplicación Application	Vehículo Vehicule	Pág.
<b>Mercedes</b>	ACTROS, ATEGO, AXOR	15
	ACTROS, ATEGO, AXOR	16
	T2, LK, MK, SK	16
	LP, LK, MK	16
<b>DAF</b>	F1600, F1700, F1800, F1900, F2000, F2100, F2200	17
	65DF, 75CF, F1300, F1400, F1500, F1600, F1700, F1900	17
	F45, F1200, F1700, F1900	18
<b>IVECO</b>	EUROCARGO, EUROSTAR, EUROTECH, EUROFIRE, EUROTRAKKER	18
	EUROCARGO, EUROSTAR, EUROTECH, EUROFIRE, EUROTRAKKER	19
	EUROCARGO	19
	ZETA, TURBOZETA	19
	75, 9A	20

**PALANCAS AUTOMÁTICAS AUTOMATIC SLACK ADJUSTERS**

Aplicación Application	Vehículo Vehicule	Pág.	
<b>Renault</b>	C290, G210, G230, G260, G290, G310, G340, G340TI, R310, R330, R360, R370, R390	22	
	MAGNUM, PREMIUM, AE	22	
	G170, G210, G230, G260, G290, G310, G340TI, G385TI, R310, R330, R360, R370, R390	22	
	MAXTER	22	
	<b>MAN</b>		23
	3 ejes rígidos	23	

Aplicación Application	Vehículo Vehicule	Pág.
<b>Scania</b>	Series 3 y 4, G112, P112, R112, R142, G82, P82, T93, T113, T143	24
	Series 4	24
<b>DAF</b>	55, 75, 85, 95, FA2100, FA2500, FA2800, FA3300, FA3600, FTS2800, FTS3300, FTS3600	25
	85, 95	25

**BARRA ESTABILIZADORA STABILIZER GROUP**

Aplicación Application	Vehículo Vehicule	Pág.
<b>RVI</b>	AE MAGNUM 380/385TI/ 420TI/500/520	28
	G (414x150) - (414x175)	29
	MAGNUM 390/420TI/430/470/ 560	30
	MAGNUM 390/430/470/560	31
	R340.TR4x2	32
	R	34
	<b>Volvo</b>	FL7, FL10, F10, F12, FH12, F16, FH16
F7, FL7, FS7, F10, FL10, F12, F16, N10		35
FH12, FH16		35
F10, F12, F16, FL10, FL12, NL10S, NL12S		36
FH12, FH16		36
FL7, FL10, F10, F12, F16, FH12, N10, N12		36
F7, F10, F12		36

Aplicación Application	Vehículo Vehicule	Pág.
<b>Volvo</b>	FH12, FH16, FM7	36
	FL7, FL10, FL12, F16, FH12, FH16, B10, B12	36
	FH12, FH16, F10, F12	37
	FL7	37
	F10, F12, F16, FL7, FL10, FH12, FH16	37
	F12, F16, FH12, FH16	37
<b>Scania</b>	T92, G93, P93, R93, T93, G112, P112, R112, R142, T142	38
	T114, R124, R143, K113, P93, P94	38
	G93, P93, R93, T93, P113, R113, R143, T143, 114G	38
	T92, G93, P93, R93, T93, G112, P112, R112, P113, R113, T113	38
	G93, P93, R93, T93, P113, R113, K113, T113, R142, T142, R143, T143	38

Aplicación Application	Vehículo Vehicule	Pág.	Aplicación Application	Vehículo Vehicule	Pág.
Renault		40	IVECO	260, 23AH, 34AH, 300, 32AH, 34AH, 260E30, 260E34, 260E37, 260E42, 260E47, 260E52, 340E34, 340E37, 340E42, 440E34, 440E37, 440E42, 440E52, 240E34, 240E38, 240E42	44
Volvo	F10, F12, F16	40		EURO RIDER 29, EURO RIDER 29A, EURO RIDER 35	44
	F12, F16	40	MAN	18192, 19242, 24192, 24242, 25372, 26372, 33272, S2000, F2000	44
	F7, F10, F12, FH12, FH16, B9, B10, B12	41		S2000	44
	FL7, FL10, F7, F10, F12, F16, FH16	41	Mercedes	1617L, 1619, 16242/LS, 1626, 1628, 1632, 1633, 1635, 1636, BM385, BM387, BM620, BM645, BM621	45
	FL7, FL10, FL12, F10, F12, F16, N10	41		ACTROS	45
	FL7, FL10, F10, F12, FH12, FH16	41			
	FL7, FL10, F12, F16, FH12, FH16	41			
Scania	Series 3 y 4	42			
		42			
	K112, K113	42			
DAF	F1900, F2100, F2300, F2500, F2700, F2800, F2900, F3600, F65, F75, F85, F95	43			
	F75, F85, F95, 75CF, 85CF, 95XF	43			
	F2100, F2300, F2500, F2700, F2800, F2900, F3200, F3300, F3600, F75, F85, F95	43			
	F1900, F2100, F2300, F2500, F2700, F2800, F2900, F3300, F3600, F65, F75, F85, F95	43			
		43			

**AMORTIGUADORES SHOCK ABSORBERS**
**RVI, VOLVO, SCANIA, MAN, DAF ..... pág. 48**
**KITS DE REP. BULÓN DE MANGUETA KING PIN SETS**

Aplicación Application	Vehículo Vehicule	Pág.	Aplicación Application	Vehículo Vehicule	Pág.
RVI	MAGNUM	50	Volvo	F7, F10, F12, F16, FL7, FL10, N7, N10, N12, FH12, C10M	56
	G200/210/230TI	51		F7, F10, F12, F16, F65, FL7, FL10, N7, N10, N12, B6, B7, B10, B57, B58	56
	GLC/GLR190/230	52	MAN		57
	PREMIUM TR - MAGNUM	53		SG220, SG240, SG242, SG292, SG312, SG322, SL, SR	57
	R310/330/340/365 Conducción a la derecha	54		F2000, F90, M90	57
	R310/330/340/365 Conducción a la izquierda	55			



## Condiciones Generales de Venta

Las presentes condiciones generales de venta son fijas, salvo que en los pedidos se estipulen reservas.

### **Precios**

Nuestros precios son dados a título indicativo y son revisables sin previo aviso. Las mercancías son facturadas al precio de tarifa en vigor en el momento del servicio. Las reclamaciones concernientes a la falta de piezas o de defectos visibles, deberán ser formuladas en el día de recepción de la mercancía.

### **Garantía**

Toda pieza fabricada por nosotros está garantizada contra todo defecto de fabricación hasta el final de un período de 3 meses a partir de la fecha de facturación al cliente. En caso de litigio, nuestra responsabilidad será limitada a reemplazar gratuitamente las piezas que sean reconocidas como defectuosas, después de nuestra certificación en nuestra fábrica, sin incurrir en ninguna otra indemnización de la forma o naturaleza que sea.

### **Devolución de piezas**

Las devoluciones deberán ser realizadas después de un acuerdo por nuestra parte, bien embaladas y siempre a nuestros almacenes de Irún.

### **Plazo de entrega**

Ningún atraso en las entregas puede ser objeto de anulación de pedido.

### **Fuero**

En caso de litigio, serán competentes los juzgados y tribunales correspondientes al domicilio social sito en Irún (Gipuzkoa), España.

## General Sale Conditions

*These general sale conditions are fixed, except for those orders in which stocks are stipulated.*

### **Prices**

*Our prices are only illustrative and can be reviewed without notice. Goods are invoiced at the net cost, at the current rates, at time of service. Complaints relating to the lack of pieces or to visible faults should be formulated the day of the goods reception.*

### **Guarantee**

*Every piece that we manufacture is guaranteed against every manufacture fault until the end of a period of three months from the invoicing date of the client. In the event of a lawsuit, our liability will be limited to replace free of charge the pieces considered as faulty, after our certification in our factory, without incurring any other kind of compensation.*

### **Return of pieces**

*Returns should be carried out after an agreement with us and they should be properly packed and always sent to our warehouse in Irún.*

### **Delivery time**

*Any delay in the deliveries could not be the aim of the cancellation of the order.*

### **Authority**

*In the event of a lawsuit, the appropriate tribunals and courts in Irún (Gipuzcoa), Spain will be competent.*





# **RÓTULAS DE DIRECCIÓN** **TIE RODS ENDS**

Aplicación *Application*

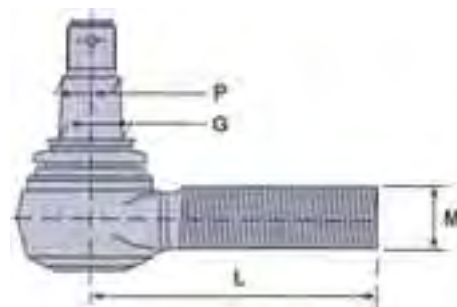
**RENAULT**



Ref. Onyarbi <i>Onyarbi ref.</i>	<b>80.13.01</b>	Ref. OEM <i>OEM ref.</i>	Vehículo <i>Vehicule</i>	M	L	P	G
 (derecho) <i>(right)</i>		5000288360	Magnum AE 420, Magnum AE 386, Premium, R 340, R 350	M30 x 1,5	125	27,1	30
		5000240688					
		5000242475					
		5000242479					
		5000242485					
		5000253852					
	5000275496						

Ref. Onyarbi <i>Onyarbi ref.</i>	<b>80.13.02</b>	Ref. OEM <i>OEM ref.</i>	Vehículo <i>Vehicule</i>	M	L	P	G
 (izquierdo) <i>(left)</i>		5000288361	Magnum AE 420, Magnum AE 386, Premium, R 340, R 350	M30 x 1,5	125	27,1	30
		5001832581					
		0033401170					

Ref. Onyarbi <i>Onyarbi ref.</i>	<b>80.13.03</b>	Ref. OEM <i>OEM ref.</i>	Vehículo <i>Vehicule</i>	M	L	P	G
 (derecho) <i>(right)</i>		5000242159	Midliner (M-S)	M30 x 1,5	115	23,5	26
		5000295214					
		5000812483					
		5001831473					
		5001850549					
		5001852264					
	7701016946						

Ref. Onyarbi <i>Onyarbi ref.</i>	<b>80.13.04</b>	Ref. OEM <i>OEM ref.</i>	Vehículo <i>Vehicule</i>	M	L	P	G
 (izquierdo) <i>(left)</i>		0003406218	Midliner (M-S)	M30 x 1,5	115	23,5	26
		5000295215					
		5001850550					



Ref. Onyarbi Onyarbi ref.	80.13.05	Ref. OEM OEM ref.	Vehículo Vehicule	M	L	P	G
 (derecho) (right)		5000823987	Midliner	M28 x 1,5	105	19,9	22
		0003406242					
		5000559335					

Ref. Onyarbi Onyarbi ref.	80.13.06	Ref. OEM OEM ref.	Vehículo Vehicule	M	L	P	G
 (izquierdo) (left)		5000559336	Midliner	M28 x 1,5	105	19,9	22
		5000823947					
		5000823997					

Ref. Onyarbi Onyarbi ref.	80.13.13	Ref. OEM OEM ref.	Vehículo Vehicule	M	L	P	G
 (derecho) (right)		0003406252	S, J	M24 x 1,5	95	18,1	20
		5000807554					
		5000814097					

Ref. Onyarbi Onyarbi ref.	80.13.14	Ref. OEM OEM ref.	Vehículo Vehicule	M	L	P	G
 (izquierdo) (left)		5000807553	S, J	M24 x 1,5	95	18,1	20
		5000814096					

Aplicación *Application*

**VOLVO**

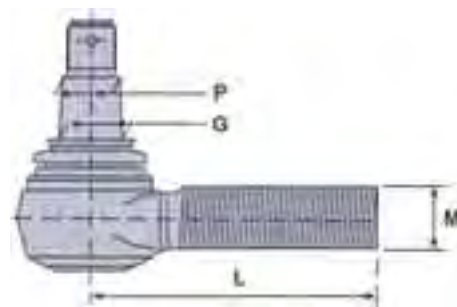



Ref. Onyarbi <i>Onyarbi ref.</i>	<b>80.13.05</b>	Ref. OEM <i>OEM ref.</i>	Vehículo <i>Vehicle</i>	M	L	P	G
 (derecho) <i>(right)</i>		1517440	B6, F6	M28 x 1,5	105	19,9	22
		1517444					
		1698191					

Ref. Onyarbi <i>Onyarbi ref.</i>	<b>80.13.06</b>	Ref. OEM <i>OEM ref.</i>	Vehículo <i>Vehicle</i>	M	L	P	G
 (izquierdo) <i>(left)</i>		1517439	B6, F6	M28 x 1,5	105	19,9	22
		1698190					

Ref. Onyarbi <i>Onyarbi ref.</i>	<b>80.13.07</b>	Ref. OEM <i>OEM ref.</i>	Vehículo <i>Vehicle</i>	M	L	P	G
 (derecho) <i>(right)</i>		1507823	F7, F10, F12, F16, FL6, FL7, FL10, FL12	M30 x 1,5	125	24	29
		1698532					
		1698846					
		3092472					
		3988968					

Ref. Onyarbi <i>Onyarbi ref.</i>	<b>80.13.08</b>	Ref. OEM <i>OEM ref.</i>	Vehículo <i>Vehicle</i>	M	L	P	G
 (izquierdo) <i>(left)</i>		1507822	F7, F10, F12, F16, FL6, FL7, FL10, FL12	M30 x 1,5	125	24	29
		1698533					
		1698847					
		3092471					
		3988965					

Ref. Onyarbi Onyarbi ref.	80.13.09	Ref. OEM OEM ref.	Vehículo Vehicule	M	L	P	G
 (derecho) (right)		1695585	FL7, FL10, FL12	M30 x 1,5	125	27	31,5
		1695776					
		1698557					

Ref. Onyarbi Onyarbi ref.	80.13.10	Ref. OEM OEM ref.	Vehículo Vehicule	M	L	P	G
 (izquierdo) (left)		1131744	FL7, FL10, FL12	M30 x 1,5	125	27	31,5
		1698558					
		1698840					
		6869744					

Ref. Onyarbi Onyarbi ref.	80.13.11	Ref. OEM OEM ref.	Vehículo Vehicule	M	L	P	G
 (izquierdo) (left)		3090728	F7, F10, F12, F16, FL7, FH12, FH16	M30 x 1,5	115	23,9	28,6
		3110001					
		3988968					

Ref. Onyarbi Onyarbi ref.	80.13.12	Ref. OEM OEM ref.	Vehículo Vehicule	M	L	P	G
 (derecho) (right)		3090727	F7, F10, F12, F16, FL7, FH12, FH16	M30 x 1,5	115	23,9	28,6

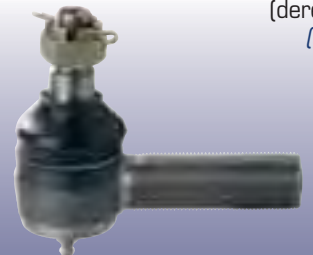
Ref. Onyarbi Onyarbi ref.	80.13.13	Ref. OEM OEM ref.	Vehículo Vehicule	M	L	P	G
 (derecho) (right)		1190778	B7R, B10B, B10M, B12, F4, F10, F12, FL7, FL10	M24 x 1,5	95	18,1	20
		1517449					
		1518142					

Las marcas, los símbolos y las referencias del constructor original son indicados para facilitar la identificación de las piezas y no implican que sean dichas partes.  
Brands, symbols and references of original constructor are indicated to help in part identification and this does not imply that they are said parts.

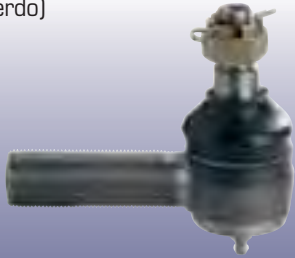
Ref. Onyarbi Onyarbi ref.	80.13.14	Ref. OEM OEM ref.	Vehículo Vehicule	M	L	P	G
(izquierdo) (left)		1517448	B7R, B10B, B10M, B12, F4, F10, F12, FL7, FL10	M24 x 1,5	95	18,1	20

Aplicación *Application*

**SCANIA**

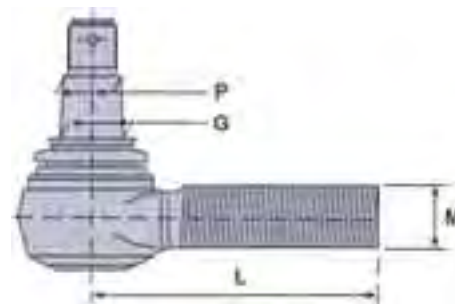

Ref. Onyarbi Onyarbi ref.	80.13.01	Ref. OEM OEM ref.	Vehículo Vehicule	M	L	P	G
(derecho) (right)		1358793	Series 2, Series 3, Series 4	M30 x 1,5	125	27,1	30
		283784					
		395010					

Ref. Onyarbi Onyarbi ref.	80.13.02	Ref. OEM OEM ref.	Vehículo Vehicule	M	L	P	G
(izquierdo) (left)		1358792	Series 2, Series 3, Series 4	M30 x 1,5	125	27,1	30
		1738380					
		283783					
		395009					

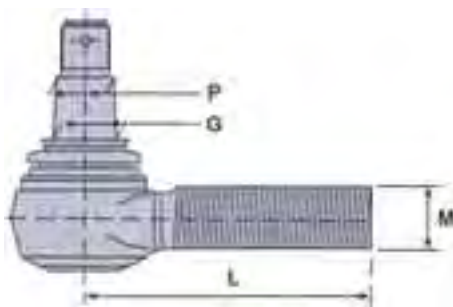

Aplicación *Application*

**MAN**

Ref. Onyarbi Onyarbi ref.	80.13.01	Ref. OEM OEM ref.	Vehículo Vehicule	M	L	P	G
 (derecho) (right)		81953010016	F2000, F90, M2000, M90, SG, SL, TGA	M30 x 1,5	125	27,1	30
		81953010084					
		81953016048					
		81953016049					
		81953016053					
		81953016090					
		81953016108					
		81953016112					
		81953016126					
		81953016143					
	81953016278						

Ref. Onyarbi Onyarbi ref.	80.13.02	Ref. OEM OEM ref.	Vehículo Vehicule	M	L	P	G
 (izquierdo) (left)		81953010015	F2000, F90, M2000, M90, SG, SL, TGA	M30 x 1,5	125	27,1	30
		81953010083					
		81953010087					
		81953016030					
		81953016043					
		81953016050					
		81953016054					
		81953016087					
		81953016091					
		81953016017					
	81953016125						

Ref. Onyarbi Onyarbi ref.	80.13.03	Ref. OEM OEM ref.	Vehículo Vehicule	M	L	P	G
 (derecho) (right)		81953010014	F2000, L2000, M2000, M90	M30 x 1,5	115	23,5	26
		81953010064					
		81953016067					
		81953016162					
		81953016239					
		9080415311					



Ref. Onyarbi Onyarbi ref.	80.13.04	Ref. OEM OEM ref.	Vehículo Vehicule	M	L	P	G
(izquierdo) (left) 		81953016068	F2000, L2000, M2000, M90	M30 x 1,5	115	23,5	26
		81953016163					
		90804153107					
		90804153113					

Ref. Onyarbi Onyarbi ref.	80.13.05	Ref. OEM OEM ref.	Vehículo Vehicule	M	L	P	G
 (derecho) (right)		81953016060	G90, L2000, M2000	M28 x 1,5	105	19,9	22
		81953016135					
		81953016140					
		81953016249					

Ref. Onyarbi Onyarbi ref.	80.13.06	Ref. OEM OEM ref.	Vehículo Vehicule	M	L	P	G
(izquierdo) (left) 		81953010079	G90, L2000, M2000	M28 x 1,5	105	19,9	22
		81953016139					
		81953016222					

Ref. Onyarbi Onyarbi ref.	80.13.13	Ref. OEM OEM ref.	Vehículo Vehicule	M	L	P	G
 (derecho) (right)		81953010077	L2000, M2000, M90, G90	M24 x 1,5	95	18,1	20
		81953016134					
		81953016142					
		81953016303					

Ref. Onyarbi Onyarbi ref.	80.13.14	Ref. OEM OEM ref.	Vehículo Vehicule	M	L	P	G
(izquierdo) (left) 		81953010078	L2000, M2000, M90, G90	M24 x 1,5	95	18,1	20
		81953016141					
		81953016304					

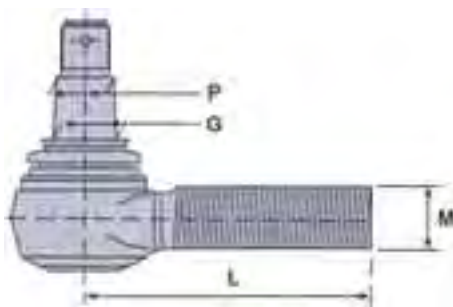



Aplicación *Application*

# MERCEDES

Ref. Onyarbi <i>Onyarbi ref.</i>	80.13.01	Ref. OEM <i>OEM ref.</i>	Vehículo <i>Vehicle</i>	M	L	P	G
 (derecho) <i>(right)</i>		0004600348	ACTROS, ATEGO, AXOR	M30 x 1,5	125	27,1	30
		0004602848					
		0004602948					
		0014600848					
		0014601248					
	0014602248						

Ref. Onyarbi <i>Onyarbi ref.</i>	80.13.02	Ref. OEM <i>OEM ref.</i>	Vehículo <i>Vehicle</i>	M	L	P	G
 (izquierdo) <i>(left)</i>		0004600648	ACTROS, ATEGO, AXOR	M30 x 1,5	125	27,1	30
		0004601248					
		0004603448					
		0004603548					
		0014600348					
		0014601448					
		0014602348					
		0014603148					
	0014603748						

Ref. Onyarbi <i>Onyarbi ref.</i>	80.13.03	Ref. OEM <i>OEM ref.</i>	Vehículo <i>Vehicle</i>	M	L	P	G
 (derecho) <i>(right)</i>		0003300248	ACTROS, ATEGO, AXOR	M30 x 1,5	115	23,5	26
		0003303235					
		0003383410					
		0004632229					
		0004633429					

Ref. Onyarbi Onyarbi ref.	80.13.04	Ref. OEM OEM ref.	Vehículo Vehicule	M	L	P	G
(izquierdo) (left) 		0003300148	ACTROS, ATEGO, AXOR	M30 x 1,5	115	23,5	26
		0013308835					
		3023300035					
		3023300135					
		3023300235					
	3023300335						

Ref. Onyarbi Onyarbi ref.	80.13.05	Ref. OEM OEM ref.	Vehículo Vehicule	M	L	P	G
 (derecho) (right)		0003301435	T2, LK, MK, SK	M28 x 1,5	105	19,9	22
		0003301535					
		0003309335					
		0003309535					

Ref. Onyarbi Onyarbi ref.	80.13.06	Ref. OEM OEM ref.	Vehículo Vehicule	M	L	P	G
(izquierdo) (left) 		0003303335	T2, LK, MK, SK	M28 x 1,5	105	19,9	22
		0003307235					
		0003309435					
		0003309635					

Ref. Onyarbi Onyarbi ref.	80.13.13	Ref. OEM OEM ref.	Vehículo Vehicule	M	L	P	G
 (derecho) (right)		0003300635	LP, LK, MK	M24 x 1,5	95	18,1	20
		0003308535					
		0003308735					
		0003382410					
		0004633229					

Ref. Onyarbi Onyarbi ref.	80.13.14	Ref. OEM OEM ref.	Vehículo Vehicule	M	L	P	G
(izquierdo) (left) 		0003300235	LP, LK, MK	M24 x 1,5	95	18,1	20
		0003300735					
		0003306835					
		0003308635					
		0003308835					

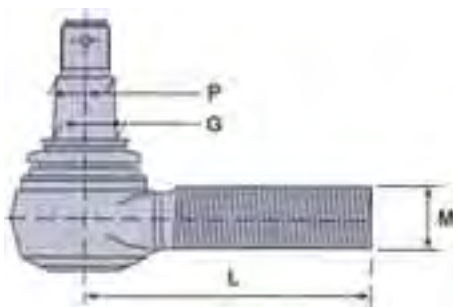



## Aplicación *Application*

# DAF

Ref. Onyarbi <i>Onyarbi ref.</i>	<b>80.13.01</b>	Ref. OEM <i>OEM ref.</i>	Vehículo <i>Vehicle</i>	M	L	P	G
 (derecho) <i>(right)</i>		0698450	F1600, F1700, F1800, F1900, F2000, F2100, F2200	M30 x 1,5	125	27,1	30
		0607981					
		1257890					
		1603789					

Ref. Onyarbi <i>Onyarbi ref.</i>	<b>80.13.02</b>	Ref. OEM <i>OEM ref.</i>	Vehículo <i>Vehicle</i>	M	L	P	G
 (izquierdo) <i>(left)</i>		0607053	F1600, F1700, F1800, F1900, F2000, F2100, F2200	M30 x 1,5	125	27,1	30
		0696225					
		1228115					

Ref. Onyarbi <i>Onyarbi ref.</i>	<b>80.13.03</b>	Ref. OEM <i>OEM ref.</i>	Vehículo <i>Vehicle</i>	M	L	P	G
 (derecho) <i>(right)</i>		0586753	65DF, 75CF, F1300, F1400, F1500, F1600, F1700, F1900	M30 x 1,5	115	23,5	26
		0607999					
		0694298					
		0694360					
		0698609					
		1229944					
	1326896						
	1331925						

Ref. Onyarbi <i>Onyarbi ref.</i>	<b>80.13.04</b>	Ref. OEM <i>OEM ref.</i>	Vehículo <i>Vehicle</i>	M	L	P	G
 (izquierdo) <i>(left)</i>		0311300	65DF, 75CF, F1300, F1400, F1500, F1600, F1700, F1900	M30 x 1,5	115	23,5	26
		0607998					
		1315447					
		1319838					
		1338714					

Ref. Onyarbi Onyarbi ref.	80.13.05	Ref. OEM OEM ref.	Vehículo Vehicule	M	L	P	G
 (derecho) (right)		0110197	F45, F1200, F1700, F1900	M28 x 1,5	105	19,9	22
		0607451					
		0607453					
		1228114					

Ref. Onyarbi Onyarbi ref.	80.13.06	Ref. OEM OEM ref.	Vehículo Vehicule	M	L	P	G
 (izquierdo) (left)		0607452	F45, F1200, F1700, F1900	M28 x 1,5	105	19,9	22
		0607454					
		0110196					

**Aplicación Application**

**IVECO**

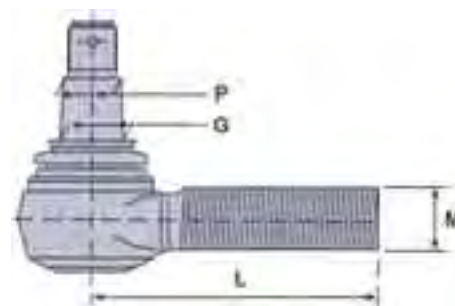

Ref. Onyarbi Onyarbi ref.	80.13.01	Ref. OEM OEM ref.	Vehículo Vehicule	M	L	P	G
 (derecho) (right)		2966252	EUROCARGO, EUROSTAR, EUROTECH, EUROFIRE, EUROTRAKKER	M30 x 1,5	125	27,1	30
		2969808					
		42483386					
		42488269					
		42489573					
		42489594					
		42491638					
		4802443					
	4833829						
	8122752						



Ref. Onyarbi Onyarbi ref.	80.13.02	Ref. OEM OEM ref.	Vehículo Vehicule	M	L	P	G
(izquierdo) (left)		2984061	EUROCARGO, EUROSTAR, EUROTECH, EUROFIRE, EUROTRAKKER	M30 x 1,5	125	27,1	30
		42489395					
		42491957					
		4802444					
		4833830					
		4688948					

Ref. Onyarbi Onyarbi ref.	80.13.03	Ref. OEM OEM ref.	Vehículo Vehicule	M	L	P	G
(derecho) (right)		2980323	EUROCARGO	M30 x 1,5	115	23,5	26
		42483520					
		42493781					

Ref. Onyarbi Onyarbi ref.	80.13.04	Ref. OEM OEM ref.	Vehículo Vehicule	M	L	P	G
(izquierdo) (left)		2980129	EUROCARGO	M30 x 1,5	115	23,5	26
		2984511					
		42493782					
		4833821					
		4833828					
		8122755					

Ref. Onyarbi Onyarbi ref.	80.13.05	Ref. OEM OEM ref.	Vehículo Vehicule	M	L	P	G
(derecho) (right)		2966321	ZETA, TURBOZETA	M28 x 1,5	105	19,9	22
		2966635					
		42484886					
		4833825					
		8193645					
		8558533					
		8582322					

Ref. Onyarbi Onyarbi ref.	80.13.06	Ref. OEM OEM ref.	Vehículo Vehicule	M	L	P	G
(izquierdo) (left)		2969507	ZETA, TURBOZETA	M28 x 1,5	105	19,9	22
		42484887					
		4833826					
		8123394					
		8193646					
		8558536					

Las marcas, los símbolos y las referencias del constructor original son indicados para facilitar la identificación de las piezas y no implican que sean dichas partes.  
Brands, symbols and references of original constructor are indicated to help in part identification and this does not imply that they are said parts.

Ref. Onyarbi Onyarbi ref.	80.13.13	Ref. OEM OEM ref.	Vehículo Vehicule	M	L	P	G
 (derecho) <i>(right)</i>		42480024	75, 9A	M24 x 1,5	95	18,1	20
		42491937					

Ref. Onyarbi Onyarbi ref.	80.13.14	Ref. OEM OEM ref.	Vehículo Vehicule	M	L	P	G
 (izquierdo) <i>(left)</i>		42480023	75, 9A	M24 x 1,5	95	18,1	20
		8193649					



**PALANCAS AUTOMÁTICAS  
AUTOMATIC SLACK ADJUSTERS**

# RENAULT



Ref. Onyarbi <i>Onyarbi ref.</i>	Lado <i>Side</i>	Ref. Haldex <i>Haldex ref.</i>	Ref. OEM <i>OEM ref.</i>	Vehículo <i>Vehicle</i>
11.11.12	Dcha. <i>Right</i>	79016	5000789895	C290, G210, G230, G260, G290, G310, G340, G340TI, R310, R330, R360, R370, R390
11.11.13	Izda. <i>Left</i>	79015	5000789894	



Ref. Onyarbi <i>Onyarbi ref.</i>	Lado <i>Side</i>	Ref. Haldex <i>Haldex ref.</i>	Ref. OEM <i>OEM ref.</i>	Vehículo <i>Vehicle</i>
80.14.02	Dcha. <i>Right</i>	79305	5010260028	MAGNUM, PREMIUM, AE
80.14.01	Izda. <i>Left</i>	79304	5010260027	





Ref. Onyarbi <i>Onyarbi ref.</i>	Lado <i>Side</i>	Ref. Haldex <i>Haldex ref.</i>	Ref. OEM <i>OEM ref.</i>	Vehículo <i>Vehicle</i>
80.14.03	Dcha. <i>Right</i>	79013	5010056685	G170, G210, G230, G260, G290, G310, G340TI, G385TI, R310, R330, R360, R370, R390
80.14.04	Izda. <i>Left</i>	79014	5010056686	



Ref. Onyarbi <i>Onyarbi ref.</i>	Lado <i>Side</i>	Ref. Haldex <i>Haldex ref.</i>	Ref. OEM <i>OEM ref.</i>	Vehículo <i>Vehicle</i>
80.14.05	Dcha. <i>Right</i>	79295	50010098861	MAXTER
80.14.06	Izda. <i>Left</i>	79294	50010098860	

	Ref. Onyarbi <i>Onyarbi ref.</i>	Lado <i>Side</i>	Ref. Haldex <i>Haldex ref.</i>	Ref. OEM <i>OEM ref.</i>	Vehículo <i>Vehicle</i>
	80.14.12	Dcha. <i>Right</i>	79209	81506106166	
	80.14.11	Izda. <i>Left</i>	79208	81506106165	

	Ref. Onyarbi <i>Onyarbi ref.</i>	Lado <i>Side</i>	Ref. Haldex <i>Haldex ref.</i>	Ref. OEM <i>OEM ref.</i>	Vehículo <i>Vehicle</i>
	80.14.13	Dcha./Izda. <i>Right/Left</i>	79212	81506106081	3 ejes rígidos

	Ref. Onyarbi <i>Onyarbi ref.</i>	Lado <i>Side</i>	Ref. Haldex <i>Haldex ref.</i>	Ref. OEM <i>OEM ref.</i>	Vehículo <i>Vehicle</i>
	80.14.15	Dcha. <i>Right</i>	79206	81506106139	
	80.14.14	Izda. <i>Left</i>	79205	81506106140	



# SCANIA



Ref. Onyarbi <i>Onyarbi ref.</i>	Lado <i>Side</i>	Ref. Haldex <i>Haldex ref.</i>	Ref. OEM <i>OEM ref.</i>	Vehículo <i>Vehicle</i>
80.14.20	Dcha. <i>Right</i>	72661	1112834	Series 3 y 4, G112, P112, R112, R142, G82, P82, T93, T113, T143
80.14.19	Izda. <i>Left</i>	72660	1112833	



Ref. Onyarbi <i>Onyarbi ref.</i>	Lado <i>Side</i>	Ref. Haldex <i>Haldex ref.</i>	Ref. OEM <i>OEM ref.</i>	Vehículo <i>Vehicle</i>
80.14.21	Dcha. <i>Right</i>	79442	1358634	Series 4
80.14.22	Izda. <i>Left</i>	79443	1358635	



Ref. Onyarbi <i>Onyarbi ref.</i>	Lado <i>Side</i>	Ref. Haldex <i>Haldex ref.</i>	Ref. OEM <i>OEM ref.</i>	Vehículo <i>Vehicule</i>
80.14.23	Dcha. <i>Right</i>	72523	159556	55, 75, 85, 95, FA2100, FA2500, FA2800, FA3300, FA3600, FTS2800, FTS3300, FTS3600
80.14.24	Izda. <i>Left</i>	72524	159557	



Ref. Onyarbi <i>Onyarbi ref.</i>	Lado <i>Side</i>	Ref. Haldex <i>Haldex ref.</i>	Ref. OEM <i>OEM ref.</i>	Vehículo <i>Vehicule</i>
80.14.26	Dcha. <i>Right</i>	72539	361543	85, 95
80.14.25	Izda. <i>Left</i>	72538	361544	





# **BARRA ESTABILIZADORA STABILIZER GROUP**

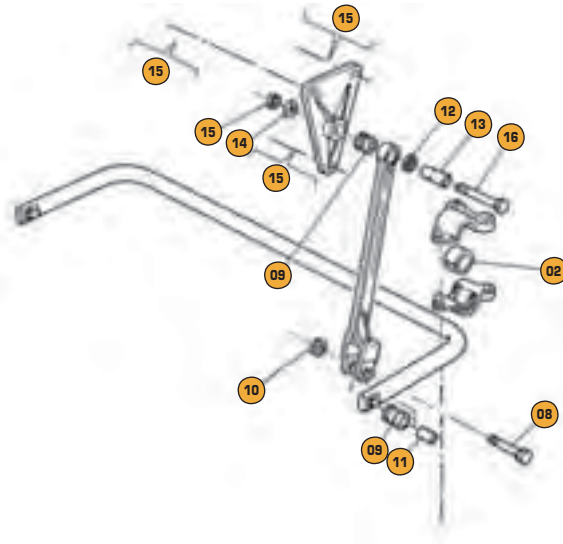

Nº	Designación	Designation	Ref. Onyarbi Onyarbi ref.	Ref. OEM OEM ref.
02	Casquillo	<i>Silentblock</i>	<b>11.10.83</b>	5010130022
08	Tornillo M-16x85	<i>Screw M-16x85</i>	<b>11.10.84</b>	5010095640
09	Casquillo	<i>Bush</i>	<b>11.10.27</b>	0000714088
10	Tuerca M-16x1,5 DIN 985	<i>Lock nut</i>	<b>80.01.15</b>	7703034032
11	Tubo concéntrico	<i>Steel bushing</i>	<b>11.10.86</b>	5010095657
12	Arandelas plana	<i>Washer</i>	<b>80.02.50</b>	5003053506
13	Tubo cónico	<i>Conic sleeve</i>	<b>11.10.87</b>	5010051018
14	Arandela cónica	<i>Conic washer</i>	<b>80.02.49</b>	5003058034
15	Tuerca DIN 934 M-16x1,5	<i>Nut M-16x1,5</i>	<b>80.01.37</b>	5003032236
16	Tornillo M-16x120	<i>Screw M-16x120</i>	<b>11.10.85</b>	5003101643

Ref. Onyarbi Onyarbi ref.	Ref. OEM OEM ref.	Designación	Designation	Cantidad Quantity
<b>11.10.82</b>	-	<b>Kit B. Estab. RVI Magnum</b>	<b>Kit B. Estab. Magnum</b>	
<b>11.10.27</b>	0000714088	Casquillo	<i>Bush</i>	<b>6</b>
<b>11.10.83</b>	5010130022	Casquillo	<i>Silentblock</i>	<b>2</b>
<b>11.10.84</b>	5010095640	Tornillo M-16x85	<i>Screw M-16x85</i>	<b>2</b>
<b>11.10.85</b>	5003101643	Tornillo M-16x120	<i>Screw M-16x120</i>	<b>2</b>
<b>11.10.86</b>	5010095657	Tubo concéntrico	<i>Steel bushing</i>	<b>2</b>
<b>11.10.87</b>	5010051018	Tubo cónico	<i>Conic sleeve</i>	<b>2</b>
<b>80.01.15</b>	6114000K	Tuerca M-16x1,5 DIN 985	<i>Lock nut</i>	<b>2</b>
<b>80.01.37</b>	5003032236	Tuerca DIN 934 M-16x1,5	<i>Nut M-16x1,5</i>	<b>8</b>
<b>80.02.49</b>	5003058034	Arandela cónica	<i>Conic washer</i>	<b>4</b>
<b>80.02.50</b>	5003053506	Arandelas plana	<i>Washer</i>	<b>2</b>

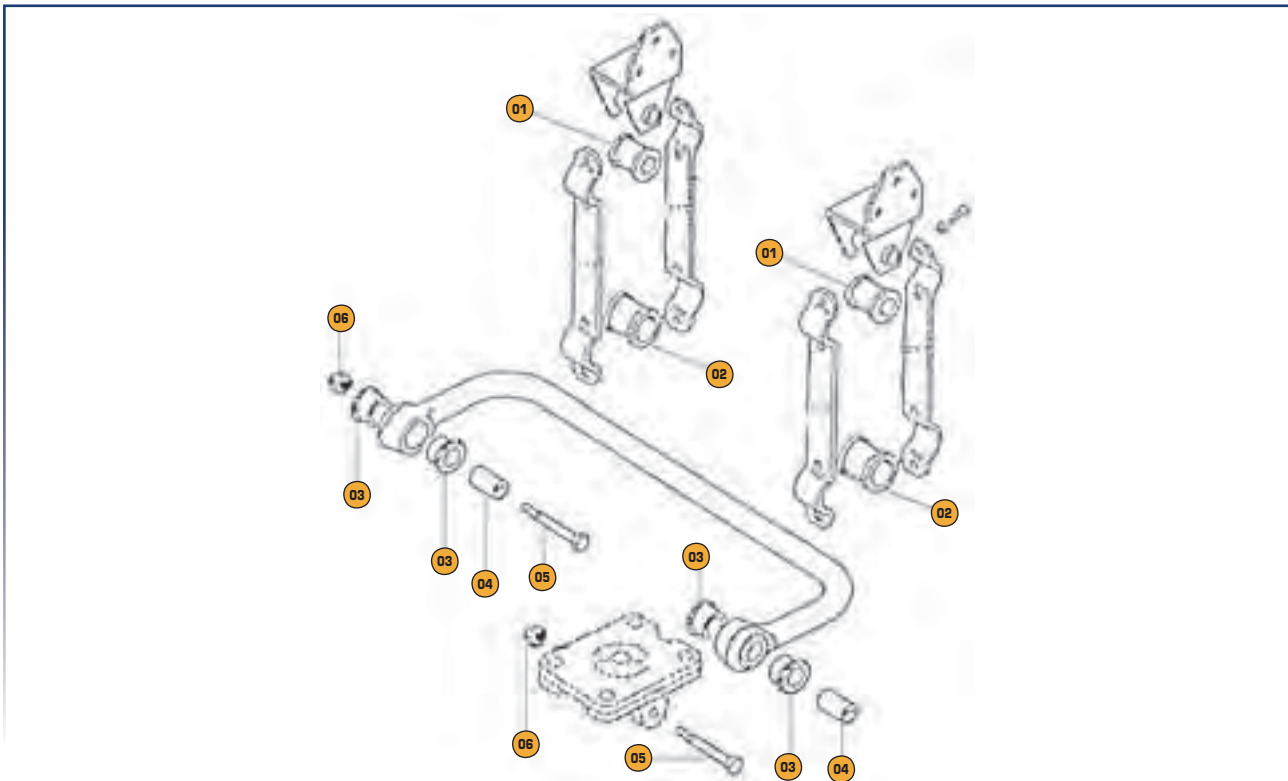

Nº	Designación	Designation	Ref. Onyarbi Onyarbi ref.	Ref. OEM OEM ref.
01	Carrete pequeño	Small bearing	11.10.10	5000279225
02	Carrete grande	Bearing	11.10.11	5000464786
03	Semi-carrete	Bearing	11.10.12	000790899
04	Casquillo	Sleeve	11.10.13	790871
05	Tornillo M-20x1,5x150 DIN 931	Screw	70.01.62	5003001990
06	Tuerca M-20x1,5 DIN 985	Lock nut	80.01.25	ESPO602010

Ref. Onyarbi Onyarbi ref.	Ref. OEM OEM ref.	Designación	Designation	Cantidad Quantity
<b>11.10.22</b>	-	<b>Kit Barra Estabilizadora</b>	<b>Bar kit</b>	
11.10.12	000790899	Semi-carrete	Bearing	4
11.10.13	790871	Casquillo	Sleeve	2
70.01.62	5003001990	Tornillo M-20x1,5x150 DIN 931	Screw	2
80.01.25	ESPO602010	Tuerca M-20x1,5 DIN 985	Lock nut	2

Ref. Onyarbi Onyarbi ref.	Ref. OEM OEM ref.	Designación	Designation	Cantidad Quantity
<b>11.10.23</b>	-	<b>Kit Palier Barra Estab.</b>	<b>Mounting bracket kit</b>	
11.10.10	5000279225	Carrete pequeño	Small bearing	2
11.10.11	5000464786	Carrete grande	Bearing	2

Ref. Onyarbi Onyarbi ref.	Ref. OEM OEM ref.	Designación	Designation	Cantidad Quantity
<b>11.10.41</b>	-	<b>Kit Comp. Barra Estabilizadora</b>	<b>Stabilizer B. kit</b>	
11.10.10	5000279225	Carrete pequeño	Small bearing	2
11.10.11	5000464786	Carrete grande	Bearing	2
11.10.12	000790899	Semi-carrete	Bearing	4
11.10.13	790871	Casquillo	Sleeve	2
70.01.62	5003001990	Tornillo M-20x1,5x150 DIN 931	Screw	2
80.01.25	ESPO602010	Tuerca M-20x1,5 DIN 985	Lock nut	2



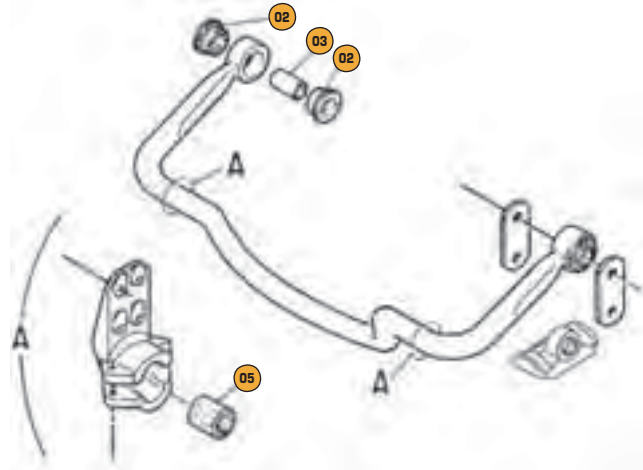

Nº	Designación	Designation	Ref. Onyarbi Onyarbi ref.	Ref. OEM OEM ref.
02	Casquillo	Half bush	11.10.93	5010239670
03	Casquillo zincado	Sleeve	11.10.94	5010239674
05	Casquillo	Sleeve	11.10.92	5010060356

Ref. Onyarbi Onyarbi ref.	Ref. OEM OEM ref.	Designación	Designation	Cantidad Quantity
<b>11.10.89</b>	-	<b>Kit Palier B. Estabilizadora</b>	<b>Estabil. B. kit</b>	
11.10.92	5010060356	Casquillo	Sleeve	2
11.10.93	5010239670	Casquillo	Half bush	4
11.10.94	5010239674	Casquillo zincado	Sleeve	2

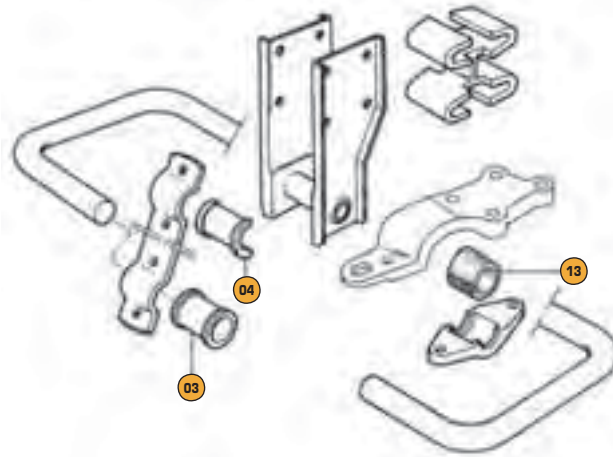

Nº	Designación	Designation	Ref. Onyarbi Onyarbi ref.	Ref. OEM OEM ref.
03	Carrete	<i>Bush</i>	11.10.90	5010066937
04	Semi-carrete	<i>Half bush</i>	11.10.91	5010066936
13	Casquillo	<i>Sleeve</i>	11.10.92	5010060356

Ref. Onyarbi Onyarbi ref.	Ref. OEM OEM ref.	Designación	Designation	Cantidad Quantity
<b>11.10.88</b>	-	<b>Kit Silentblock de Palier</b>	<b>Kit Silentblock Palier</b>	
11.10.90	5010066937	Carrete	<i>Bush</i>	2
11.10.91	5010066936	Semi-carrete	<i>Half bush</i>	4
11.10.92	5010060356	Casquillo	<i>Sleeve</i>	2

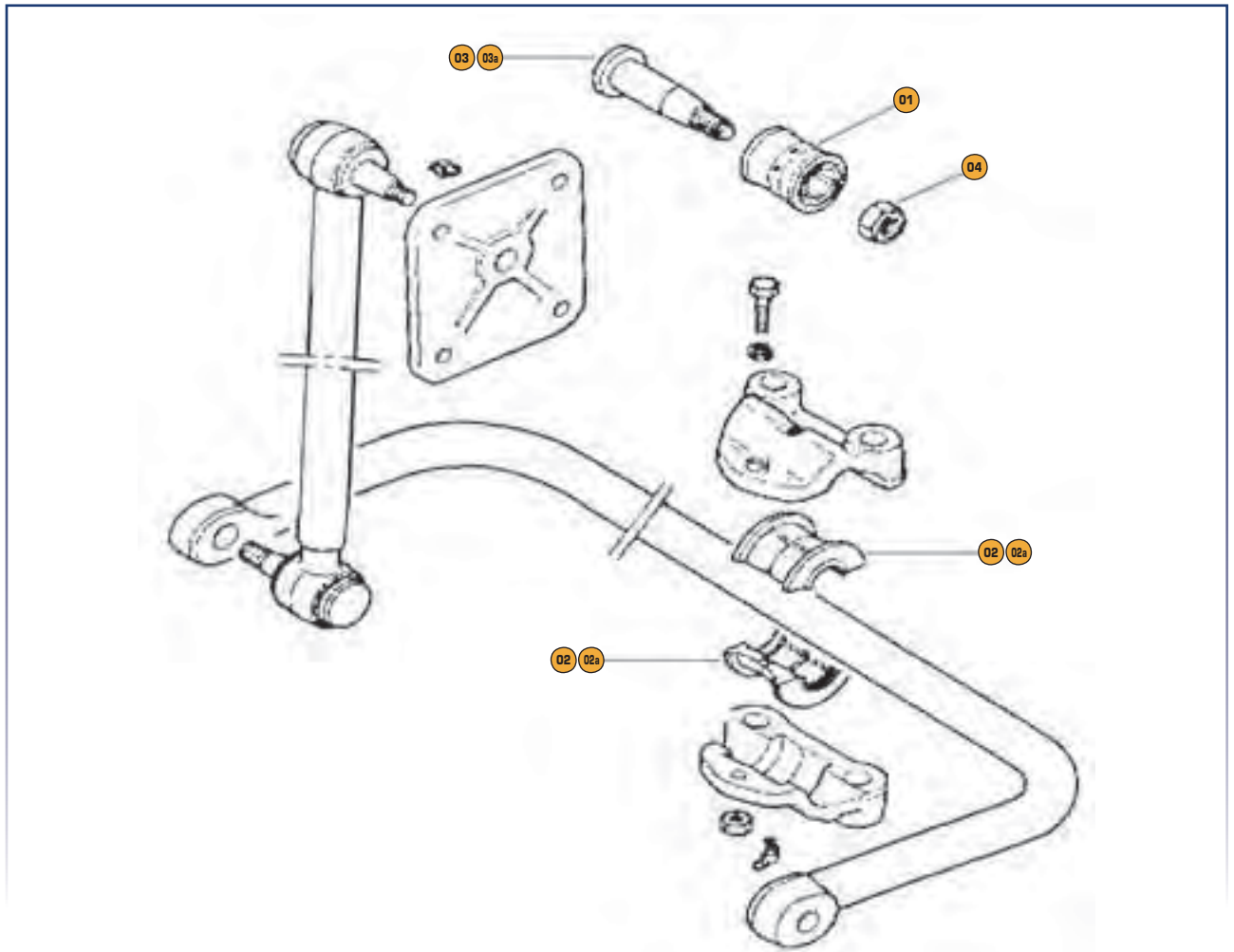

Nº	Designación	Designation	Ref. Onyarbi Onyarbi ref.	Ref. OEM OEM ref.
01	Casquillo	<i>Bush</i>	11.10.27	0000714088
02	Semi-casquillo. Barra D: 38	<i>Sleeve D: 38</i>	11.10.26	0000716243
02a	Semi-casquillo. Barra D: 41	<i>Half bush D: 41</i>	11.10.42	0000716242
03	Tornillo zincado L-115	<i>Bolt RVI</i>	11.10.24	0000714089
03a	Tornillo zincado L-108	<i>Bolt RVI</i>	11.10.25	5000297191
04	Tuerca M-20x1,5 DIN 985	<i>Lock nut</i>	80.01.25	ESPO602010

Ref. Onyarbi Onyarbi ref.	Ref. OEM OEM ref.	Designación	Designation	Cantidad Quantity
<b>11.10.43</b>	-	<b>Kit Palier B. Estab. Delant. 38</b>	<b>Mounting bracket kit</b>	
11.10.26	0000716243	Semi-casquillo. Barra D: 38	Sleeve D: 38	4
<b>11.10.44</b>	-	<b>Kit Palier B. Estab. Delant. 41</b>	<b>Mounting bracket kit</b>	
11.10.42	0000716242	Semi-casquillo. Barra D: 41	Half bush D: 41	4
<b>11.10.45</b>	-	<b>Kit Biela Barra Estabilizadora</b>	<b>Stab. Bar Camshaft Rep. Kit</b>	
11.10.24	0000714089	Tornillo zincado L-115	Bolt RVI	4
11.10.27	0000714088	Casquillo	Bush	4
80.01.25	ESPO602010	Tuerca M-20x1,5 DIN 985	Lock nut	4
<b>11.10.45.1</b>	-	<b>Kit Biela B. Estabil. Delantera</b>	<b>Stab. Bar Camshaft Rep. Kit</b>	
11.10.25	5000297191	Tornillo zincado L-108	Bolt RVI	4
11.10.27	0000714088	Casquillo	Bush	4
80.01.25	ESPO602010	Tuerca M-20x1,5 DIN 985	Lock nut	4
<b>11.10.46</b>	-	<b>Kit Comp. Barra Estabil. Delantera</b>	<b>Stab. Bar Camshaft Rep. Kit</b>	
11.10.24	0000714089	Tornillo zincado L-115	Bolt RVI	4
11.10.26	0000716243	Semi-casquillo. Barra D: 38	Sleeve D: 38	4
11.10.27	0000714088	Casquillo	Bush	4
80.01.25	ESPO602010	Tuerca M-20x1,5 DIN 985	Lock nut	4
<b>11.10.46.1</b>	-	<b>Kit Comp. Barra Estabil. Delantera</b>	<b>Stab. Bar Camshaft Rep. Kit</b>	
11.10.25	5000297191	Tornillo zincado L-108	Bolt RVI	4
11.10.26	0000716243	Semi-casquillo. Barra D: 38	Sleeve D: 38	4
11.10.27	0000714088	Casquillo	Bush	4
80.01.25	ESPO602010	Tuerca M-20x1,5 DIN 985	Lock nut	4
<b>11.10.46.2</b>	-	<b>Kit Comp. Barra Estabil. Delantera</b>	<b>Stab. Bar Camshaft Rep. Kit</b>	
11.10.24	0000714089	Tornillo zincado L-115	Bolt RVI	4
11.10.27	0000714088	Casquillo	Bush	4
11.10.42	0000716242	Semi-casquillo. Barra D: 41	Half bush D: 41	4
80.01.25	ESPO602010	Tuerca M-20x1,5 DIN 985	Lock nut	4
<b>11.10.46.3</b>	-	<b>Kit Comp. Barra Estabil. Delantera</b>	<b>Stab. Bar Camshaft Rep. Kit</b>	
11.10.25	5000297191	Tornillo zincado L-108	Bolt RVI	4
11.10.27	0000714088	Casquillo	Bush	4
11.10.42	0000716242	Semi-casquillo. Barra D: 41	Half bush D: 41	4
80.01.25	ESPO602010	Tuerca M-20x1,5 DIN 985	Lock nut	4

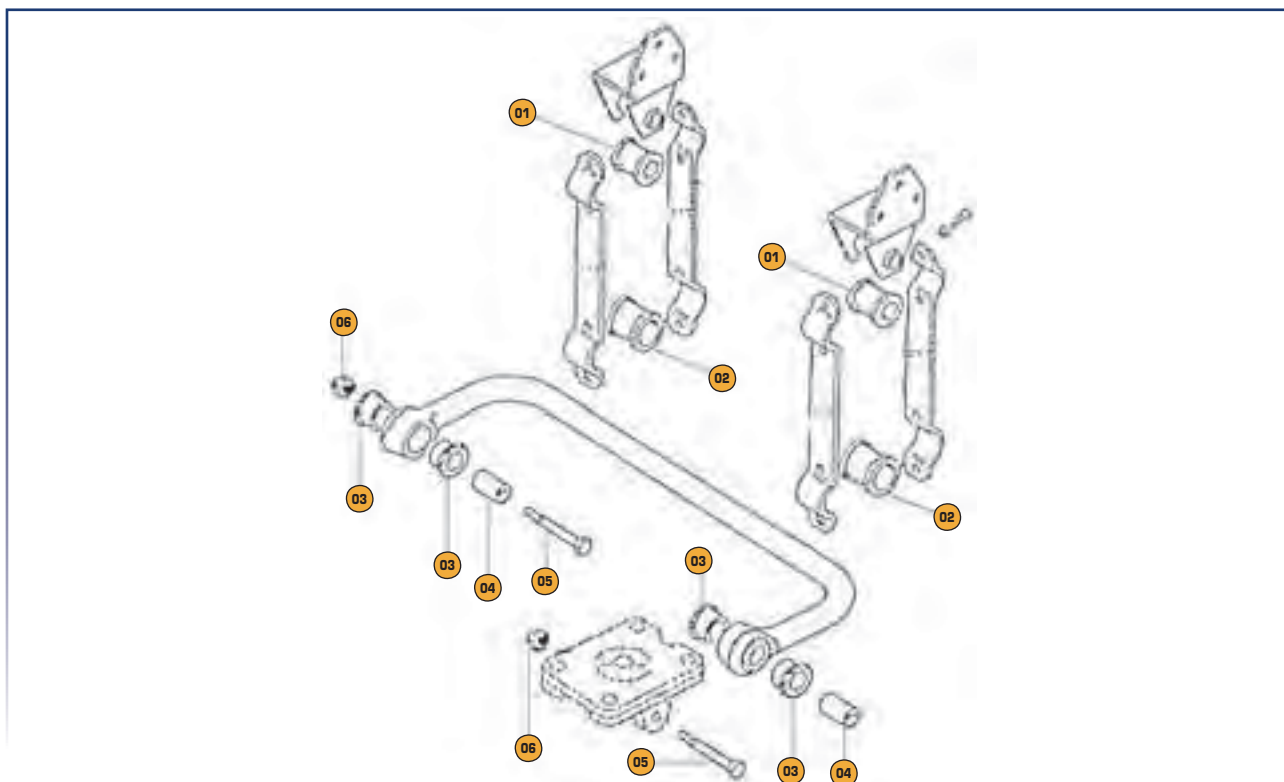

Nº	Designación	Designation	Ref. Onyarbi Onyarbi ref.	Ref. OEM OEM ref.
01	Carrete pequeño	<i>Small bearing</i>	11.10.10	5000279225
02	Carrete grande	<i>Bearing</i>	11.10.11	5000464786
03	Semi-carrete	<i>Bearing</i>	11.10.12	000790899
04	Casquillo	<i>Sleeve</i>	11.10.13	790871
05	Tornillo M-20x1,5x150 DIN 931	<i>Screw</i>	70.01.62	5003001990
06	Tuerca M-20x1,5 DIN 985	<i>Lock nut</i>	80.01.25	ESPO602010

Ref. Onyarbi Onyarbi ref.	Ref. OEM OEM ref.	Designación	Designation	Cantidad Quantity
<b>11.10.22</b>	-	<b>Kit Barra Estabilizadora</b>	<b>Bar kit</b>	
11.10.12	000790899	Semi-carrete	<i>Bearing</i>	4
11.10.13	790871	Casquillo	<i>Sleeve</i>	2
70.01.62	5003001990	Tornillo M-20x1,5x150 DIN 931	<i>Screw</i>	2
80.01.25	ESPO602010	Tuerca M-20x1,5 DIN 985	<i>Lock nut</i>	2

Ref. Onyarbi Onyarbi ref.	Ref. OEM OEM ref.	Designación	Designation	Cantidad Quantity
<b>11.10.23</b>	-	<b>Kit Palier Barra Estab.</b>	<b>Mounting bracket kit</b>	
11.10.10	5000279225	Carrete pequeño	<i>Small bearing</i>	2
11.10.11	5000464786	Carrete grande	<i>Bearing</i>	2

Ref. Onyarbi Onyarbi ref.	Ref. OEM OEM ref.	Designación	Designation	Cantidad Quantity
<b>11.10.41</b>	-	<b>Kit Comp. Barra Estabilizadora</b>	<b>Stabilizer B. kit</b>	
11.10.10	5000279225	Carrete pequeño	<i>Small bearing</i>	2
11.10.11	5000464786	Carrete grande	<i>Bearing</i>	2
11.10.12	000790899	Semi-carrete	<i>Bearing</i>	4
11.10.13	790871	Casquillo	<i>Sleeve</i>	2
70.01.62	5003001990	Tornillo M-20x1,5x150 DIN 931	<i>Screw</i>	2
80.01.25	ESPO602010	Tuerca M-20x1,5 DIN 985	<i>Lock nut</i>	2



Ref. Onyarbi <i>Onyarbi ref.</i>	Ref. OEM <i>OEM ref.</i>	Vehículo <i>Vehicule</i>
41.10.22	1605047	FL7, FL10, F10, F12, FH12, F16, FH16



Ref. Onyarbi <i>Onyarbi ref.</i>	Ref. OEM <i>OEM ref.</i>	Vehículo <i>Vehicule</i>
41.10.23	1605182	FL7, FL10, F10, F12, FH12, F16, FH16



Ref. Onyarbi <i>Onyarbi ref.</i>	Ref. OEM <i>OEM ref.</i>	Vehículo <i>Vehicule</i>
41.10.24	1607561	FL7, FL10, F10, F12, FH12, F16, FH16



Ref. Onyarbi <i>Onyarbi ref.</i>	Ref. OEM <i>OEM ref.</i>	Vehículo <i>Vehicule</i>
41.10.25	1589807	F7, FL7, FS7, F10, FL10, F12, F16, N10



Ref. Onyarbi <i>Onyarbi ref.</i>	Ref. OEM <i>OEM ref.</i>	Vehículo <i>Vehicule</i>
41.10.26	1611551	F7, FL7, FS7, F10, FL10, F12, F16, N10



Ref. Onyarbi <i>Onyarbi ref.</i>	Ref. OEM <i>OEM ref.</i>	Vehículo <i>Vehicule</i>
41.10.27	1624611	FH12, FH16





Ref. Onyarbi <i>Onyarbi ref.</i>	Ref. OEM <i>OEM ref.</i>	Vehículo <i>Vehicle</i>
41.10.28	1587261	F10, F12, F16, FL10, FL12, NL10S, NL12S



Ref. Onyarbi <i>Onyarbi ref.</i>	Ref. OEM <i>OEM ref.</i>	Vehículo <i>Vehicle</i>
41.10.30	1075179	FH12, FH16



Ref. Onyarbi <i>Onyarbi ref.</i>	Ref. OEM <i>OEM ref.</i>	Vehículo <i>Vehicle</i>
41.10.31	1575339	FL7, FL10, F10, F12, F16, FH12, N10, N12



Ref. Onyarbi <i>Onyarbi ref.</i>	Ref. OEM <i>OEM ref.</i>	Vehículo <i>Vehicle</i>
41.10.33	1573032	F7, F10, F12



Ref. Onyarbi <i>Onyarbi ref.</i>	Ref. OEM <i>OEM ref.</i>	Vehículo <i>Vehicle</i>
41.10.41	9516524	FH12, FH16, FM7



Ref. Onyarbi <i>Onyarbi ref.</i>	Ref. OEM <i>OEM ref.</i>	Vehículo <i>Vehicle</i>
41.10.43	1134955	FL7, FL10, FL12, F16, FH12, FH16, B10, B12



Ref. Onyarbi <i>Onyarbi ref.</i>	Ref. OEM <i>OEM ref.</i>	Vehículo <i>Vehicule</i>
41.10.42	1624605	FH12, FH16, F10, F12



Ref. Onyarbi <i>Onyarbi ref.</i>	Ref. OEM <i>OEM ref.</i>	Vehículo <i>Vehicule</i>
41.10.44	1608758	FL7



Ref. Onyarbi <i>Onyarbi ref.</i>	Ref. OEM <i>OEM ref.</i>	Vehículo <i>Vehicule</i>
41.10.45	1620750	F10, F12, F16, FL7, FL10, FH12, FH16



Ref. Onyarbi <i>Onyarbi ref.</i>	Ref. OEM <i>OEM ref.</i>	Vehículo <i>Vehicule</i>
41.10.46	1620753	F10, F12, F16, FL7, FL10, FH12, FH16



Ref. Onyarbi <i>Onyarbi ref.</i>	Ref. OEM <i>OEM ref.</i>	Vehículo <i>Vehicule</i>
41.10.47	8152450	F12, F16, FH12, FH16

# SCANIA



Ref. Onyarbi <i>Onyarbi ref.</i>	Ref. OEM <i>OEM ref.</i>	Vehículo <i>Vehicule</i>
71.10.01	213604	T92, G93, P93, R93, T93, G112, P112, R112, R142, T142



Ref. Onyarbi <i>Onyarbi ref.</i>	Ref. OEM <i>OEM ref.</i>	Vehículo <i>Vehicule</i>
71.10.02	1344190	T114, R124, R143, K113, P93, P94



Ref. Onyarbi <i>Onyarbi ref.</i>	Ref. OEM <i>OEM ref.</i>	Vehículo <i>Vehicule</i>
71.10.03	228483	G93, P93, R93, T93, P113, R113, R143, T143, 114G



Ref. Onyarbi <i>Onyarbi ref.</i>	Ref. OEM <i>OEM ref.</i>	Vehículo <i>Vehicule</i>
71.10.04	1429110	T92, G93, P93, R93, T93, G112, P112, R112, P113, R113, T113



Ref. Onyarbi <i>Onyarbi ref.</i>	Ref. OEM <i>OEM ref.</i>	Vehículo <i>Vehicule</i>
71.10.05	295751	G93, P93, R93, T93, P113, R113, K113, T113, R142, T142, R143, T143



**KIT DE TIRANTES  
TORQUE ROD KITS**

Aplicación *Application*

# RENAULT



Ref. Onyarbi <i>Onyarbi ref.</i>	Ref. OEM <i>OEM ref.</i>	Vehículo <i>Vehicle</i>
80.12.12	5001842823	

Aplicación *Application*

# VOLVO



Ref. Onyarbi <i>Onyarbi ref.</i>	Ref. OEM <i>OEM ref.</i>	Vehículo <i>Vehicle</i>
80.12.01	0274068	F10, F12, F16

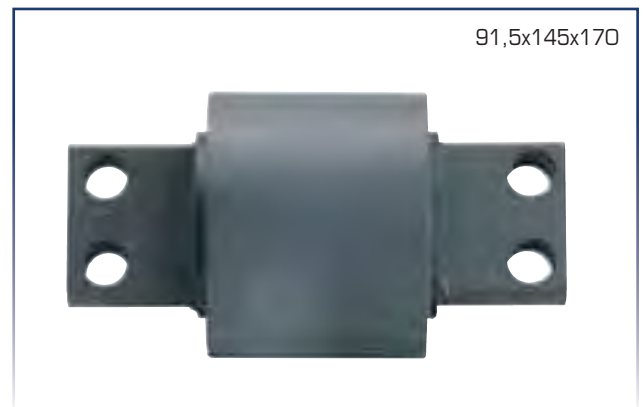

Ref. Onyarbi <i>Onyarbi ref.</i>	Ref. OEM <i>OEM ref.</i>	Vehículo <i>Vehicle</i>
80.12.02	1628107	F12, F16



91,5x125x150

Ref. Onyarbi <i>Onyarbi ref.</i>	Ref. OEM <i>OEM ref.</i>	Vehículo <i>Vehicule</i>
80.12.03	1614355	F7, F10, F12, FH12, FH16, B9, B10, B12



M16x2/138,5x96

Ref. Onyarbi <i>Onyarbi ref.</i>	Ref. OEM <i>OEM ref.</i>	Vehículo <i>Vehicule</i>
80.12.04	3173759	FL7, FL10, F7, F10, F12, F16, FH16



75x17x115

Ref. Onyarbi <i>Onyarbi ref.</i>	Ref. OEM <i>OEM ref.</i>	Vehículo <i>Vehicule</i>
80.12.05	0271187	FL7, FL10, FL12, F10, F12, F16, N10



95x152x23

Ref. Onyarbi <i>Onyarbi ref.</i>	Ref. OEM <i>OEM ref.</i>	Vehículo <i>Vehicule</i>
80.12.06	0274056	FL7, FL10, F10, F12, FH12, FH16



85x21x130

Ref. Onyarbi <i>Onyarbi ref.</i>	Ref. OEM <i>OEM ref.</i>	Vehículo <i>Vehicule</i>
80.12.11	0274019	FL7, FL10, F12, F16, FH12, FH16



# SCANIA



75x17x115

Ref. Onyarbi <i>Onyarbi ref.</i>	Ref. OEM <i>OEM ref.</i>	Vehículo <i>Vehicle</i>
80.12.05	1112506	Series 3 y 4



95x152x23

Ref. Onyarbi <i>Onyarbi ref.</i>	Ref. OEM <i>OEM ref.</i>	Vehículo <i>Vehicle</i>
80.12.06	1104336	



85x130x17

Ref. Onyarbi <i>Onyarbi ref.</i>	Ref. OEM <i>OEM ref.</i>	Vehículo <i>Vehicle</i>
80.12.12	628862	K112, K113



Ref. Onyarbi <i>Onyarbi ref.</i>	Ref. OEM <i>OEM ref.</i>	Vehículo <i>Vehicule</i>
80.12.01	0691703	F1900, F2100, F2300, F2500, F2700, F2800, F2900, F3600, F65, F75, F85, F95



Ref. Onyarbi <i>Onyarbi ref.</i>	Ref. OEM <i>OEM ref.</i>	Vehículo <i>Vehicule</i>
80.12.05	0689748	F75, F85, F95, 75CF, 85CF, 95XF



Ref. Onyarbi <i>Onyarbi ref.</i>	Ref. OEM <i>OEM ref.</i>	Vehículo <i>Vehicule</i>
80.12.06	0696321	F2100, F2300, F2500, F2700, F2800, F2900, F3200, F3300, F3600, F75, F85, F95



Ref. Onyarbi <i>Onyarbi ref.</i>	Ref. OEM <i>OEM ref.</i>	Vehículo <i>Vehicule</i>
80.12.11	0513757	F1900, F2100, F2300, F2500, F2700, F2800, F2900, F3300, F3600, F65, F75, F85, F95



Ref. Onyarbi <i>Onyarbi ref.</i>	Ref. OEM <i>OEM ref.</i>	Vehículo <i>Vehicule</i>
80.12.12	0689749	

# IVECO



Ref. Onyarbi <i>Onyarbi ref.</i>	Ref. OEM <i>OEM ref.</i>	Vehículo <i>Vehicle</i>
80.12.01	093192618	260, 23AH, 34AH, 300, 32AH, 34AH, 260E30, 260E34, 260E37, 260E42, 260E47, 260E52, 340E34, 340E37, 340E42, 440E34, 440E37, 440E42, 440E52, 240E34, 240E38, 240E42



Ref. Onyarbi <i>Onyarbi ref.</i>	Ref. OEM <i>OEM ref.</i>	Vehículo <i>Vehicle</i>
80.12.12	042488722	EURO RIDER 29, EURO RIDER 29A, EURO RIDER 35

# MAN



Ref. Onyarbi <i>Onyarbi ref.</i>	Ref. OEM <i>OEM ref.</i>	Vehículo <i>Vehicle</i>
80.12.05	81432306051	18192, 19242, 24192, 24242, 25372, 26372, 33272, S2000, F2000



Ref. Onyarbi <i>Onyarbi ref.</i>	Ref. OEM <i>OEM ref.</i>	Vehículo <i>Vehicle</i>
80.12.11	81432206203	S2000

# MERCEDES



Ref. Onyarbi <i>Onyarbi ref.</i>	Ref. OEM <i>OEM ref.</i>	Vehículo <i>Vehicule</i>
80.12.01	0003500613	1617L, 1619, 16242/LS, 1626, 1628, 1632, 1633, 1635, 1636, BM385, BM387, BM620, BM645, BM621



Ref. Onyarbi <i>Onyarbi ref.</i>	Ref. OEM <i>OEM ref.</i>	Vehículo <i>Vehicule</i>
80.12.05	0003500707	



Ref. Onyarbi <i>Onyarbi ref.</i>	Ref. OEM <i>OEM ref.</i>	Vehículo <i>Vehicule</i>
80.12.12	0003500506	ACTROS



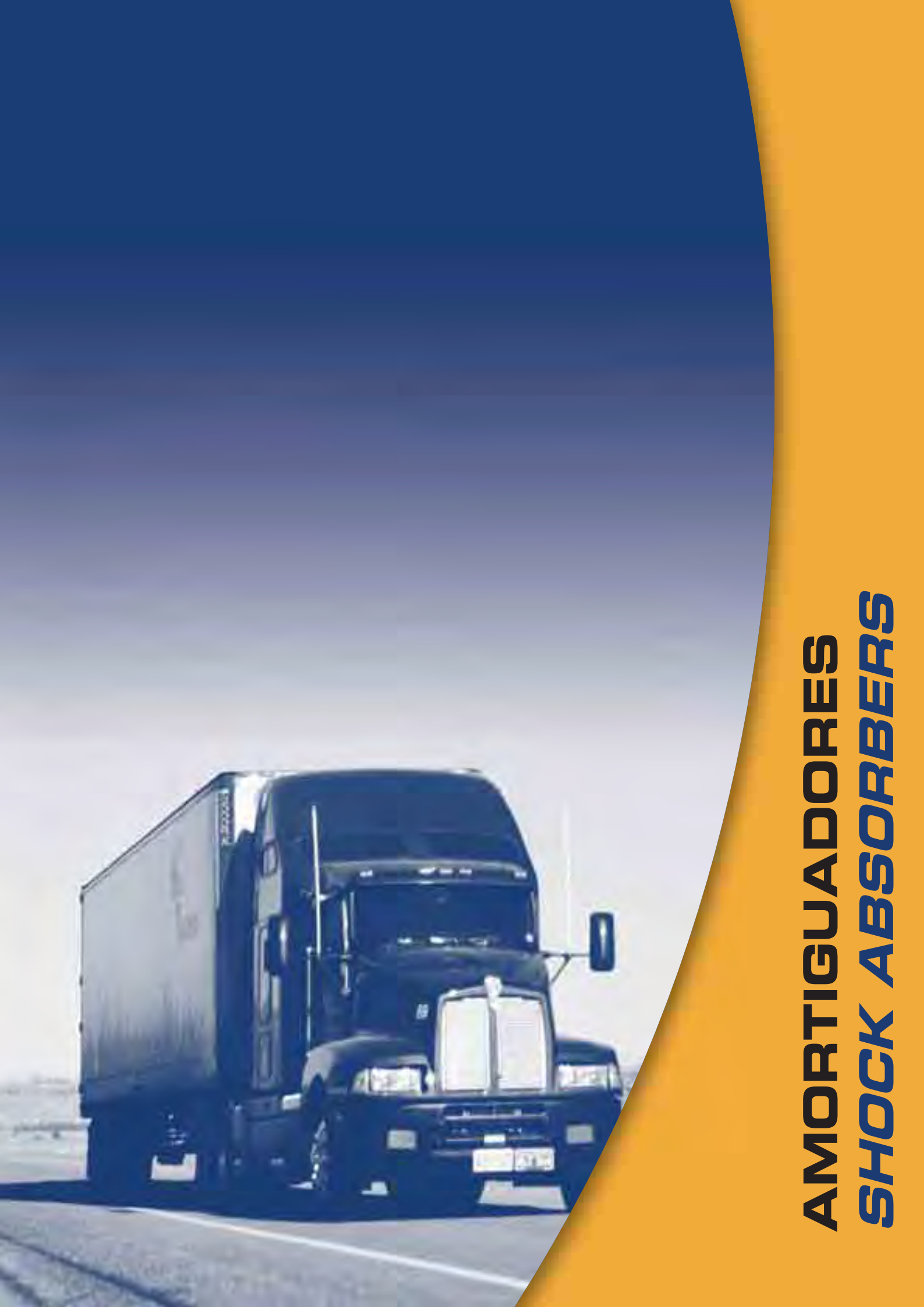

# **AMORTIGUADORES SHOCK ABSORBERS**



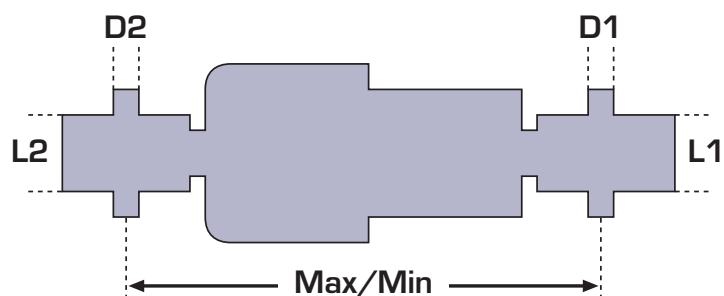

Ref. Onyarbi Onyarbi ref.	Ref. OEM OEM ref.	L min.	L máx.	D2	L2	D1	L1
<b>RVI</b>							
80.15.01	5010137052	427	677	20	45	20	45
80.15.02	5010095719	480	840	-	-	-	-
80.15.03	5000731488	429	734	-	-	-	-
80.15.04	5000725485	449	774	-	-	-	-
80.15.05	5010130401	360	600	-	-	-	-
<b>VOLVO</b>							
80.15.11	1629481	527	877	16	100	20	50
80.15.12	1629485	447	717	16	100	16	66
80.15.13	1591736	457	737	25	50	25	50
80.15.14	1136644	417	657	16	100	16	66
80.15.15	3987959	467	757	16	100	20	50
80.15.16	1591735	447	717	25	50	25	50
80.15.17	1591501	420	720	-	-	-	-
<b>SCANIA</b>							
80.15.21	1371448	488	828	-	-	20	50
80.15.22	216975	420	720	-	-	-	-
80.15.23	258420	370	620	-	-	-	-
80.15.24	1397523	557	937	20	50	20	50
80.15.25	307111	418	688	-	-	22	50
80.15.26	1327813	468	788	-	-	16	45
80.15.27	1323476	488	828	-	-	16	45
80.15.28	1340260	418	688	-	-	25	50
<b>MAN</b>							
80.15.31	81437016781	379	674	-	-	-	-
80.15.32	81437016426	437	697	16	50	16	50
80.15.33	81437016793	398	648	-	-	16	50
80.15.34	81437016354	369	614	-	-	-	-
80.15.35	81437016442	408	668	-	-	16	50
80.15.36	81437016597	410	700	-	-	-	-
80.15.37	81437016650	380	640	-	-	-	-
80.15.38	81437016406	417	657	20	62	29	130
80.15.39	81437016418	477	777	20	62	29	130
80.15.40	81437016492	400	680	-	-	-	-
<b>DAF</b>							
80.15.41	662531	390	660	-	-	-	-
80.15.42	1283723	388	628	-	-	20	50
80.15.43	740021	427	677	20	62	20	62
80.15.44	379132	458	768	-	-	25	50
80.15.45	617738	418	688	-	-	25	50
80.15.46	677975	437	697	25	50	25	50



**KITS REP. BULÓN DE MANGUETA**  
***KING PIN SETS***

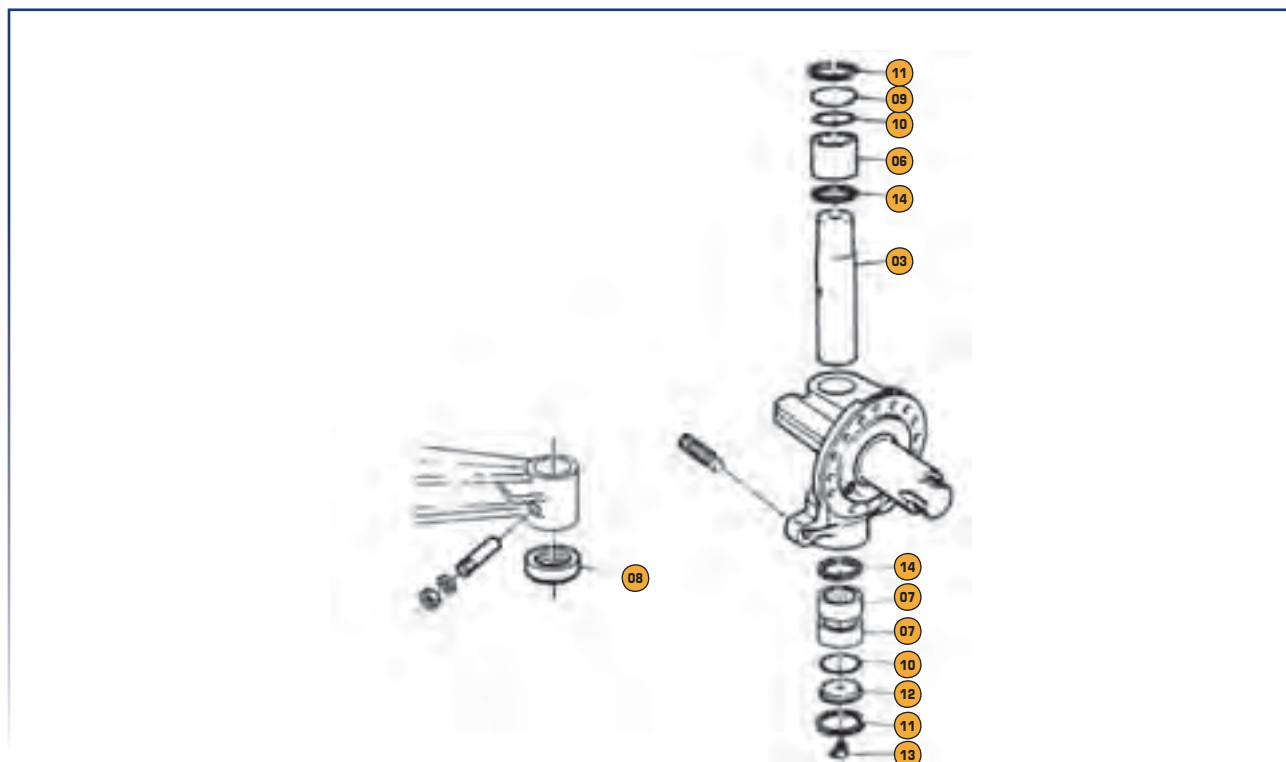

Nº	Designación	Designation	Ref. Onyarbi Onyarbi ref.	Ref. OEM OEM ref.
03	Bulón (50x225mm)	King pin 50x225mm	11.12.02	5010056002
06	Casquillo de bronce	King pin bush. 50x58x50mm	11.12.05	5000792140
07	Rodamiento	Bush	11.12.03	5010439415
08	Rodamiento 50x80x22mm	Trust bearing 50x80x22	11.12.04	5010358235
09	Tapa	Cap without hole	11.12.09	5010436005
10	Junta tórica 52,5x3mm	O.ring 52,5x3mm	11.12.07	0948381406
11	Circlip I60 DIN 472	Retaining ring I60 DIN 472	11.12.10	7703066039
12	Tapa con agujero	Holed cap	11.12.08	5010436004
13	Engrasador 45° M.8-125	Zerk grease 8x125	80.06.07	5005097016
14	Anillo	Bush	11.12.06	5010439195

Ref. Onyarbi Onyarbi ref.	Ref. OEM OEM ref.	Designación	Designation	Cantidad Quantity
<b>11.12.13</b>	-	<b>Kit Rep. Mangueta RVI</b>	<b>King Pin Kit</b>	
11.12.02	5010056002	Bulón (50x225mm)	King pin 50x225mm	1
11.12.03	5010439415	Rodamiento	Bush	2
11.12.04	5010358235	Rodamiento 50x80x22mm	Trust bearing 50x80x22mm	1
11.12.05	5000792140	Casquillo de bronce	King pin bush 50x58x50mm	1
11.12.06	5010439195	Anillo	Bush	2
11.12.07	0948381406	Junta tórica 52,5x3mm	O.ring 52,5x3mm	2
11.12.08	5010436004	Tapa con agujero	Holed cap	1
11.12.09	5010436005	Tapa	Cap without hole	1
11.12.10	7703066039	Circlip I60 DIN 472	Retaining rind I60 DIN 472	2
80.06.07	5005097016	Engrasador 45° M.8-125	Zerk grease 8x125	1

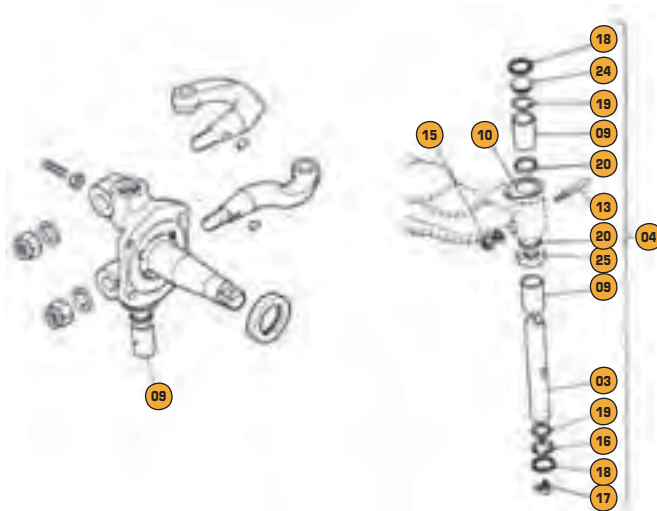

Nº	Designación	Designation	Ref. Onyarbi Onyarbi ref.	Ref. OEM OEM ref.
03	Pivote King pin (40x240)	King pin (40x240)	11.10.62	5010056583
04	Kit. rep. bulón de mangueta	Kit rep. pivot	11.10.79	5000793828
09	Casquillo bronce	King pin bush bronze	11.10.69	5010056582
13	Eje de pivote	Axle	11.10.59	5010056288
15	Tuerca DIN 936 M10 cincada	Nut	11.11.04	5003032162
16	Tapa cierre inferior bicromat.	Lower cap	11.10.58	5010056466
17	Engrasador MT-503 recto M8	Grease nipple	11.11.08	
18	Circlip I-48 DIN 472	Retaining ring	11.11.06	7703066033
19	Junta tórica 42,5x47,76x2,62	Rubber ring	11.11.07	5003065098
24	Tapa cierre superior bicromat.	Upper cap	11.10.54	5010056465
25	Rodamiento	Bearing	11.10.65	5010056925

Ref. Onyarbi Onyarbi ref.	Ref. OEM OEM ref.	Designación	Designation	Cantidad Quantity
<b>11.10.79</b>	<b>5000793828</b>	<b>Kit Rep. Bulón de Mangueta</b>	<b>Kit Rep. pivot</b>	
11.10.54	5010056465	Tapa cierre superior bicromat.	Upper cap	1
11.10.58	5010056466	Tapa cierre inferior bicromat.	Lower cap	1
11.10.59	5010056288	Eje de pivote	Axle	1
11.10.62	5010056583	Pivote King pin (40x240)	King pin (40x240)	1
11.10.65	5010056925	Rodamiento	Bearing	1
11.10.69	5010056582	Casquillo bronce	King pin bush bronze	2
11.10.73	5000793828	Kit elementos varios	Kit	1
11.10.75		Retén	Oil seal	2

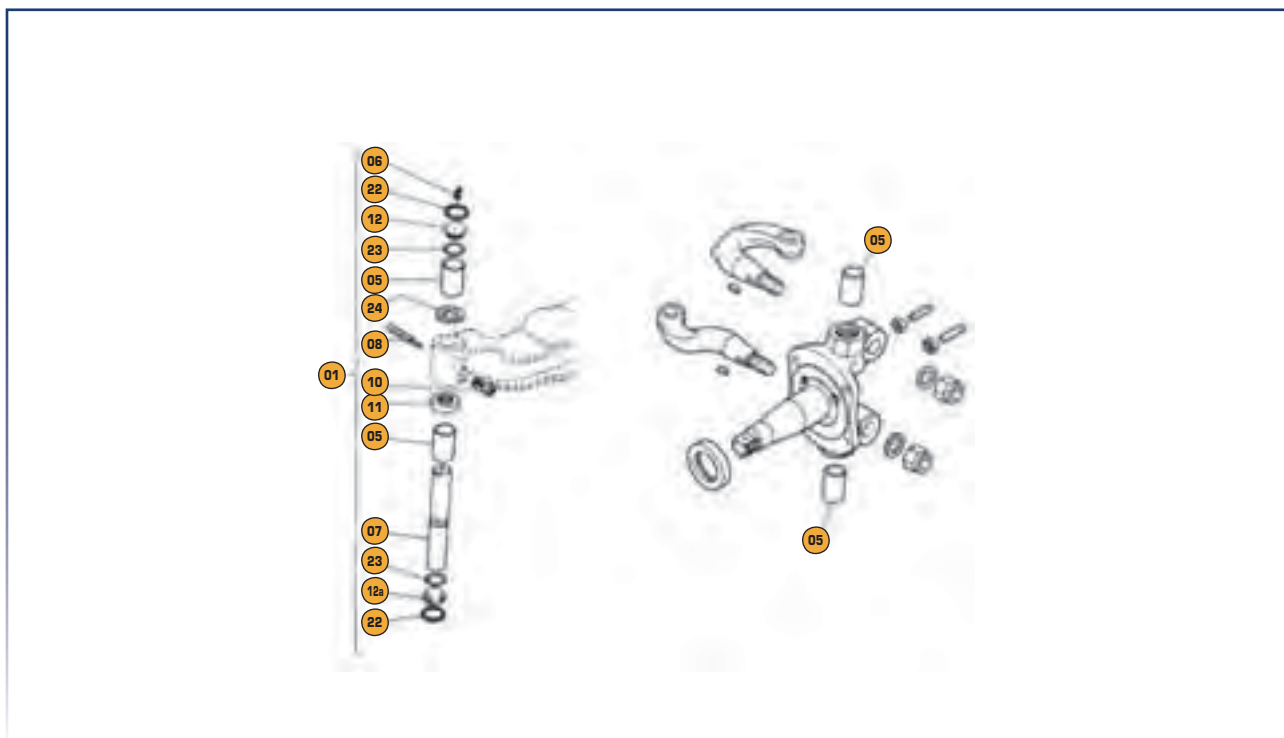

Nº	Designación	Designation	Ref. Onyarbi Onyarbi ref.	Ref. OEM OEM ref.
05	Casquillo bimetálico	<i>Bimetal king pin bush</i>	<b>11.10.68</b>	0000189901
06	Engrasador MT-506 a 45º M8	<i>Grease nipple</i>	<b>11.11.05</b>	851127900
07	Bulón (40x236)	<i>King pin (40x236)</i>	<b>11.10.61</b>	5000737530
08	Eje	<i>RVI axle</i>	<b>11.10.80</b>	0000181876
10	Tuerca DIN 936 M10 cincada	<i>Nut</i>	<b>11.11.04</b>	5003032162
11	Rodamiento	<i>Bearing</i>	<b>11.10.65</b>	5010056925
12	Tapa cierre inferior bicromat.	<i>Lower cap</i>	<b>11.10.57</b>	5010056114
12a	Tapa cierre superior bicromat.	<i>Upper cap</i>	<b>11.10.53</b>	5000761303
22	Circlip I-52 DIN 472	<i>Retaining ring</i>	<b>11.11.01</b>	5003066054
23	Junta tórica 36x42x3	<i>Rubber ring</i>	<b>11.11.11</b>	-

Ref. Onyarbi Onyarbi ref.	Ref. OEM OEM ref.	Designación	Designation	Cantidad Quantity
<b>11.10.78</b>	<b>5000794319</b>	<b>Kit Rep. Bulón de Mangueta</b>	<b>Kit Rep. pivot</b>	
11.10.53	5000761303	Tapa cierre superior bicromat.	<i>Upper cap</i>	1
11.10.57	5010056114	Tapa cierre inferior bicromat.	<i>Lower cap</i>	2
11.10.61	5000737530	Bulón (40x236)	<i>King pin (40x236)</i>	1
11.10.65	5010056925	Rodamiento	<i>Bearing</i>	1
11.10.68	0000189901	Casquillo bimetálico	<i>Bimetal king pin bush</i>	2
11.10.72	5000794319	Kit elementos varios	<i>Kit</i>	1
11.10.80	0000181876	Eje	<i>RVI axle</i>	1
11.10.81		Eje	<i>RVI axle</i>	1

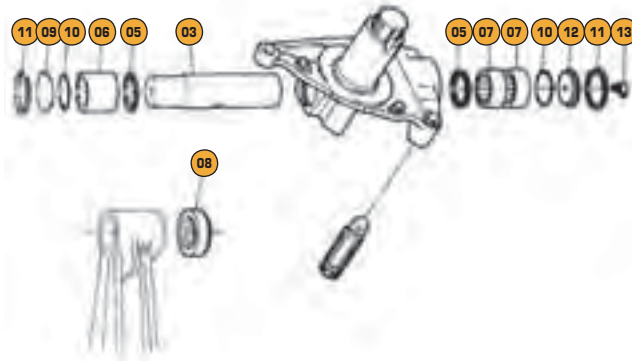

Nº	Designación	Designation	Ref. Onyarbi Onyarbi ref.	Ref. OEM OEM ref.
03	Bulón (50x235mm)	King pin (50x235)	11.12.01	5010216742
05	Anillo	Bush	11.12.06	5010439195
06	Casquillo de bronce	King pin bush 50x58x50mm	11.12.05	5000792140
07	Rodamiento	Bush	11.12.03	5010439415
08	Rodamiento 50x80x22mm	Trust bearing 50x80x22	11.12.04	5010358235
09	Tapa	Cap without hole	11.12.09	5010436005
10	Junta tórica 52,5x3mm	O. ring 52,5x3mm	11.12.07	0948381406
11	Circlip I-60 DIN 472	Retaining ring I-60 DIN 472	11.12.10	7703066039
12	Tapa con agujero	Holed cap	11.12.08	5010436004
13	Engrasador 45° M.8-125	Zerk grease 8x125	80.06.07	5005097016

Ref. Onyarbi Onyarbi ref.	Ref. OEM OEM ref.	Designación	Designation	Cantidad Quantity
<b>11.12.11</b>	-	<b>Kit Rep. Mangueta RVI</b>	<b>King pin kit</b>	
11.12.01	5010216742	Bulón (50x235mm)	King pin (50x235)	1
11.12.03	5010439415	Rodamiento	Bush	2
11.12.04	5010358235	Rodamiento 50x80x22mm	Trust bearing 50x80x22	1
11.12.05	5000792140	Casquillo de bronce	King pin bush 50x58x50mm	1
11.12.06	5010439195	Anillo	Bush	2
11.12.07	0948381406	Junta tórica 52,5x3mm	O. ring 52,5x3mm	2
11.12.08	5010436004	Tapa con agujero	Holed cap	1
11.12.09	5010436005	Tapa	Cap without hole	1
11.12.10	7703066039	Circlip I-60 DIN 472	Retaining ring I-60 DIN 472	2
80.06.07	5005097016	Engrasador 45° M.8-125	Zerk grease 8x125	1

Ref. Onyarbi Onyarbi ref.	Ref. OEM OEM ref.	Designación	Designation	Cantidad Quantity
<b>11.12.12</b>	-	<b>Kit Bulón Mangueta</b>	<b>King pin kit</b>	
11.12.01	5010216742	Bulón (50x235mm)	King pin (50x235)	1
11.12.03	5010439415	Rodamiento	Bush	2
11.12.04	5010358235	Rodamiento 50x80x22mm	Trust bearing 50x80x22	1
11.12.05	5000792140	Casquillo de bronce	King pin bush 50x58x50mm	1
11.12.06	5010439195	Anillo	Bush	2
11.12.07	0948381406	Junta tórica 52,5x3mm	O. ring 52,5x3mm	2
11.12.08	5010436004	Tapa con agujero	Holed cap	1
11.12.09	5010436005	Tapa	Cap without hole	1
11.12.10	7703066039	Circlip I-60 DIN 472	Retaining ring I-60 DIN 472	2
80.06.07	5005097016	Engrasador 45° M.8-125	Zerk grease 8x125	1



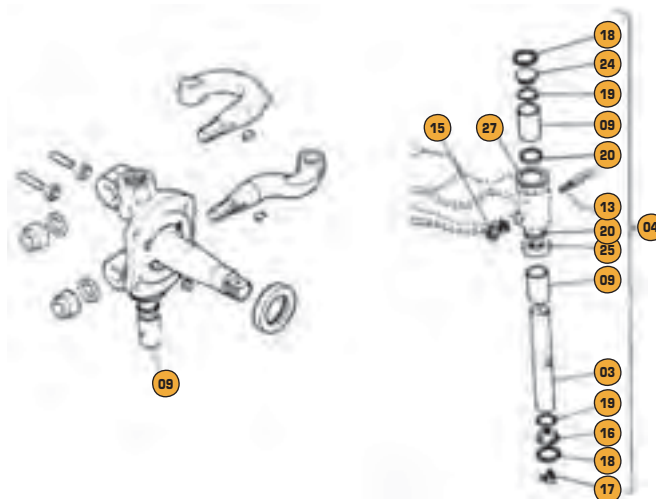

Nº	Designación	Designation	Ref. Onyarbi Onyarbi ref.	Ref. OEM OEM ref.
03	Pivote king pin (46x280)	King pin 46x280 bolt	11.10.60	5000737903
04	Kit rep. bulón de mangueta	Kit rep. pivot	11.10.77	5000793849
09	Casquillo bronce	King pin bush bronze	11.10.67	5000737796
13	Eje de pivote	Axle	11.10.59	5010056288
15	Tuerca DIN 936 M10 cincada	Nut	11.11.04	5003032162
16	Tapa cierre inferior bicromat.	Lower cap	11.10.56	5000737797
17	Engrasador MT-506 a 45º M8	Grease nipple	11.11.05	851127900
18	Circlip I-55 DIN 472	Retaining ring	11.11.09	7703066036
19	Junta tórica 48,9x54,14x2,62	Rubber ring	11.11.10	5003065099
24	Tapa cierre superior bicromat.	Upper cap	11.10.52	5010056390
25	Rodamiento	Bearing	11.10.64	5010056928

Ref. Onyarbi Onyarbi ref.	Ref. OEM OEM ref.	Designación	Designation	Cantidad Quantity
<b>11.10.77</b>	<b>5000793849</b>	<b>Kit Rep. Bulón de Mangueta</b>	<b>Kit Rep. pivot</b>	
11.1052	5010056390	Tapa cierre superior bicromat.	Upper cap	1
11.10.56	5000737797	Tapa cierre inferior bicromat.	Lower cap	1
11.10.59	5010056288	Eje de pivote	Axle	1
11.10.60	5000737903	Pivote king pin (46x280)	King pin 46x280 bolt	1
11.10.64	5010056928	Rodamiento	Bearing	1
11.10.67	5000737796	Casquillo bronce	King pin bush bronze	2
11.10.71	5000793849	Kit elementos varios	Kit	1
11.10.74		Retén	Oil seal	2

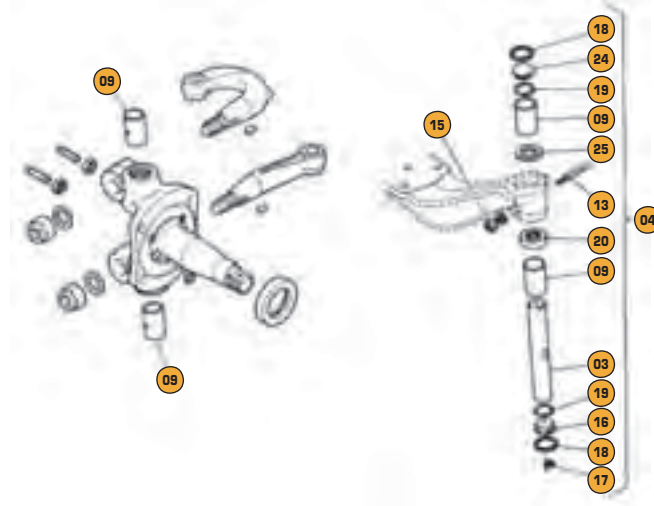

Nº	Designación	Designation	Ref. Onyarbi Onyarbi ref.	Ref. OEM OEM ref.
03	Pivote king pin (46x280)	King pin 46x280 bolt	11.10.60	5000737903
04	Kit rep. bulón de mangueta	Kit rep. pivot	11.10.76	5000794320
09	Casquillo bimetalico	Bimetal king pin bush	11.10.66	5005010019
13	Eje de pivote	Axle	11.10.59	5010056288
15	Tuerca DIN 936 M10 cincada	Nut	11.11.04	5003032162
16	Tapa cierre inferior bicromat.	Lower cap	11.10.55	5000737897
17	Engrasador MT-506 a 45º M8	Grease nipple	11.11.05	851127900
18	Circlip I-52 DIN 472	Retaining ring	11.11.01	5003066054
19	Junta tórica 42x48x3	Rubber ring	11.11.02	5000786411
20	Rodamiento	Bearing	11.10.63	5003090091
24	Tapa cierre superior bicromat.	Upper cap	11.10.51	5000737896



Ref. Onyarbi <i>Onyarbi ref.</i>	Ref. OEM <i>OEM ref.</i>	Vehículo <i>Vehicule</i>
41.14.02	3090266	F7, F10, F12, F16, FL7, FL10, N7, N10, N12, FH12, C10M



Ref. Onyarbi <i>Onyarbi ref.</i>	Ref. OEM <i>OEM ref.</i>	Vehículo <i>Vehicule</i>
41.14.01	3090267	F7, F10, F12, F16, F65, FL7, FL10, N7, N10, N12, B6, B7, B10, B57, B58



Ref. Onyarbi <i>Onyarbi ref.</i>	Ref. OEM <i>OEM ref.</i>	Vehículo <i>Vehicule</i>
81.10.01	81442056023	



Ref. Onyarbi <i>Onyarbi ref.</i>	Ref. OEM <i>OEM ref.</i>	Vehículo <i>Vehicule</i>
81.10.02	81442056010	SG220, SG240, SG242, SG292, SG312, SG322, SL, SR



Ref. Onyarbi <i>Onyarbi ref.</i>	Ref. OEM <i>OEM ref.</i>	Vehículo <i>Vehicule</i>
81.10.03	81442056013	F2000, F90, M90

A series of horizontal dotted lines spanning the width of the page, providing a guide for writing notes.

A series of horizontal dotted lines spanning the width of the page, intended for writing notes.

Lined writing area with horizontal dotted lines.



A series of horizontal dotted lines for writing notes.

A series of horizontal dotted lines for writing notes.

Lined writing area with horizontal dotted lines.

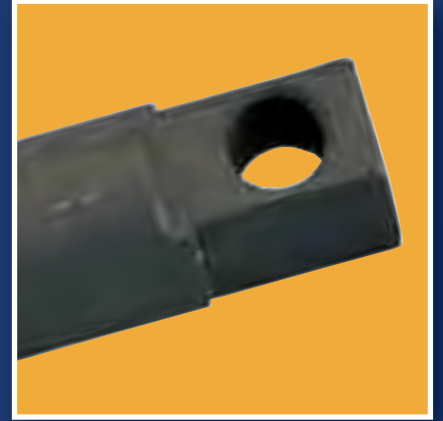

Polígono Arretxe-Ugalde | c/ Lekunberri nº 3 | 20305 IRUN (Gipuzkoa) - ESPAÑA

Tel. (+34) 943 616 382 | Fax (+34) 943 613 148

e-mail: [onyarbi@onyarbi.com](mailto:onyarbi@onyarbi.com) | web: [www.onyarbi.com](http://www.onyarbi.com)