

MOOG

**FIRST TO
MARKET**

1

FORD FIESTA KEEPS ON ROLLING

WITH MOOG'S BRAND-NEW
WHEEL END BEARING

MANUFACTURER : FORD

MODEL : Fiesta VII (2017 ->)

POSITION : Rear Axle

OE EQUIVALENT : 2123534, HCPC-2C299-B7B

MOOG REFERENCE : FD-WB-12991



www.moogparts.eu

PRMM02001-EN



REMARKABLE QUALITY

Our Steering & Suspension parts are engineered, tested and produced in-house to high standards of quality control. All backed by a **3-year guarantee**. New engineering innovations make MOOG the best it's ever been.

Best-ever ride comfort and outstanding durability.



©2018 Federal-Mogul Global Aftermarket EMEA, BVBA. MOOG is a trademark owned by Federal-Mogul LLC, or one or more of its subsidiaries, in one or more countries.

www.moogparts.co.uk

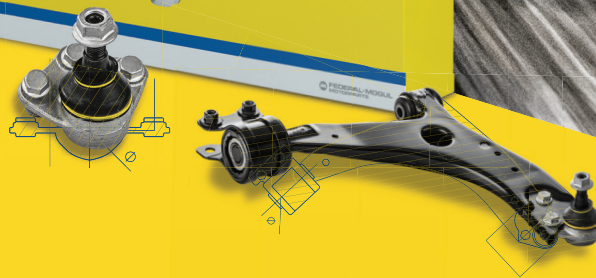

Go the extra mile.

MORE EFFICIENT PRODUCTION

HIGHLY AUTOMATED

DIFFERENTIATED PRODUCTS

BETTER SERVICE



GOING THE EXTRA MILE

At MOOG, we're always looking for ways to provide you with higher quality parts and better service. That's why we've gone the extra mile and opened our very own European MOOG production plant in Barcelona.

Not only does this **highly automated plant** optimise the production of our differentiated Steering & Suspension parts, it also ensures better control over the entire process. This means that we can offer you better parts exactly when you need them.

Automation also reduces production waste, which is good for our planet. In addition, it allows time for extra quality checks, such as checks on inbound materials, resulting in **better products**.

To top it all off, we've given our differentiated Steering & Suspension products distinctive, new packaging. As you can see, we really do go the extra mile to provide the parts and **service** you and your customers deserve.



©2018 Federal-Mogul Global Aftermarket EMEA, BVBA. MOOG is a trademark owned by Federal-Mogul LLC, or one or more of its subsidiaries, in one or more countries.

www.moogparts.eu

MOOG
Go the extra mile.

PRMMO1808_EN



CHASSIS PARTS





THE NASCAR® INSIDERS

Since 2017, there has been an agreement between MOOG and the NASCAR Whelen Euro Series™ to provide all competition cars with Steering & Suspension components. This agreement complements the long-standing NASCAR partnership, where since 1966, the MOOG brand has carried every Monster Energy NASCAR Cup Series champion to victory.



OUR MISSION

ONE BRAND, ONE MISSION, ONE FOCUS IN COMMUNICATION: GOING THE EXTRA MILE FOR OUR CLIENTS

In 2018, our priority is to 'Go the extra mile'. To ensure that you know that you can install MOOG parts with complete peace of mind. This will be even clearer with the launch of our differentiated products, for example introducing our very own Hybrid Core Technology.

If you're a wholesaler, you want to be sure that the parts you sell are solid, strong and durable, and offer drivers maximum comfort. Giving you that level of confidence is what we mean by going the extra mile.

For installers, this means no unexpected appointments with unhappy customers. Your customers won't come back with unexpected problems because there simply won't be any. This will save you precious time and money.

However, high quality products alone won't make you consider buying MOOG. To achieve that, we need to give you confidence and reassurance when it comes to fitting our parts. That's why our communications in 2018 will feature the line 'Go the extra mile.'



OUR PROMISE

MOOG PROVIDES THREE STRONG BENEFITS TO SUPPORT YOUR BUSINESS



N°1 CAR PARC COVERAGE

MOOG is proud to offer the most complete range of Steering & Suspension parts and wheel end bearings. We support distributors and installers in their ambition to give their customers the best service in the market. We extend our range with hundreds of new parts every year and whatever part you order, you can always count on MOOG's 3-year guarantee.

PRODUCT IS KEY

Our parts are designed, produced and tested to withstand extreme situations. Many of them feature our own Hybrid Core Technology which provides them with a unique edge. We're so confident about our outstanding durability that we offer a 3-year guarantee.



WE'RE PROBLEM SOLVERS

We know that your time is precious, so at MOOG, we offer you a wide range of tools to make your life easier and save you time. We have industry-leading online and offline catalogues, an online training centre and training videos. We back these up with our solution and technical bulletins, newsletter and e-mail alerts. Not to mention the MOOG quality check and much more...

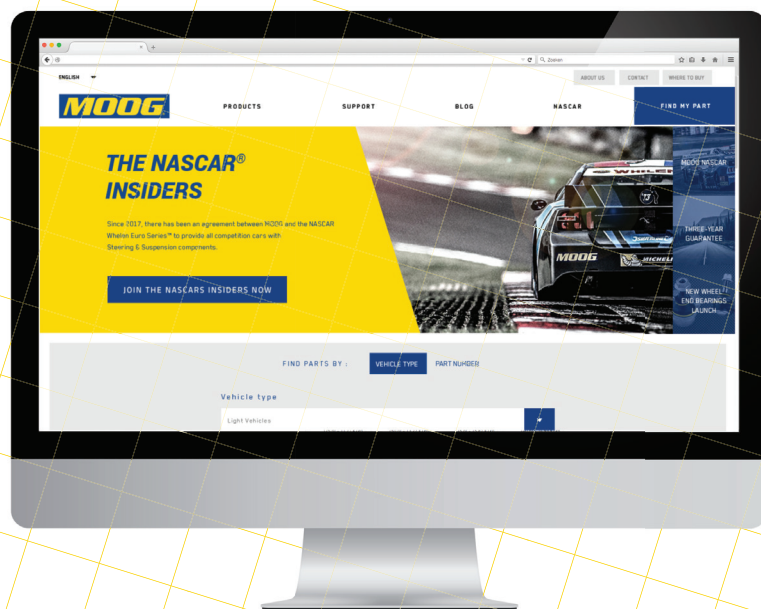

* Guarantee is subject to terms and conditions

** Car parc coverage according TecDoc data and Headline

EXCELLENT PRODUCTS FOR THE ULTIMATE IN COMFORT

OUTSTANDING PRODUCTS

Our parts are designed, produced and tested for an outstanding reliability. We're so confident in them that we offer a 3-year guarantee.

EXCEPTIONAL COMFORT

Our new differentiated parts offer the end-user more comfort, thanks to smoother, more precise steering, as well as more compliant suspension.

REMARKABLE QUALITY

All our parts are engineered, tested and produced in house to the high standards of quality control in the industry.



BALL JOINTS & LINK STABILISERS

BALL JOINTS THAT GO THE EXTRA MILE FOR YOU AND YOUR CUSTOMERS

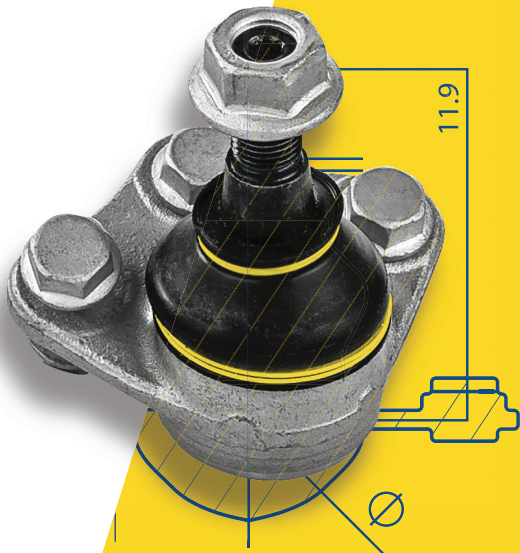

Recent innovations in our range of ball joints have ensured that they have the characteristics and performance that is expected from MOOG. **Induction hardening** has doubled stud strength and increased durability by a factor of five, which also improves safety. Durability is also enhanced thanks to the **new hybrid core carbon fibre bearing** which has better friction properties and the increase in radial deflection is reduced by 40% on average. Switching to a **new synthetic grease** makes the ball joint easier for you to fit as well as delivering optimum smoothness. The **zinc flake coating** on accessories not only looks better, it also improves corrosion resistance, while the **flanged nuts** allow higher locking force which boosts safety. Both our press-in and bolted ball joints have **new housing coatings** which improve their appearance and resistance to corrosion.

As you can see, we've gone the extra mile with all these innovations to ensure that your customers can enjoy years of smooth, safe motoring.

GOING THE EXTRA MILE FOR STABILITY

Our range of link stabilisers is full of innovations which ensure that they deliver exceptional durability and comfort. The housing coating improves the link's appearance and allows it to be colour-matched to the new steel cap closing. This closing not only looks better, it is also stronger which enhances durability. The **new synthetic grease** makes installation easier and delivers optimum smoothness. The **new flanged nut** allows higher locking forces and improves safety, while its **zinc flake coating** makes it exceptionally resistant to corrosion. We've gone the extra mile with these innovations to ensure that our link stabilisers offer the performance that is expected from a MOOG product.

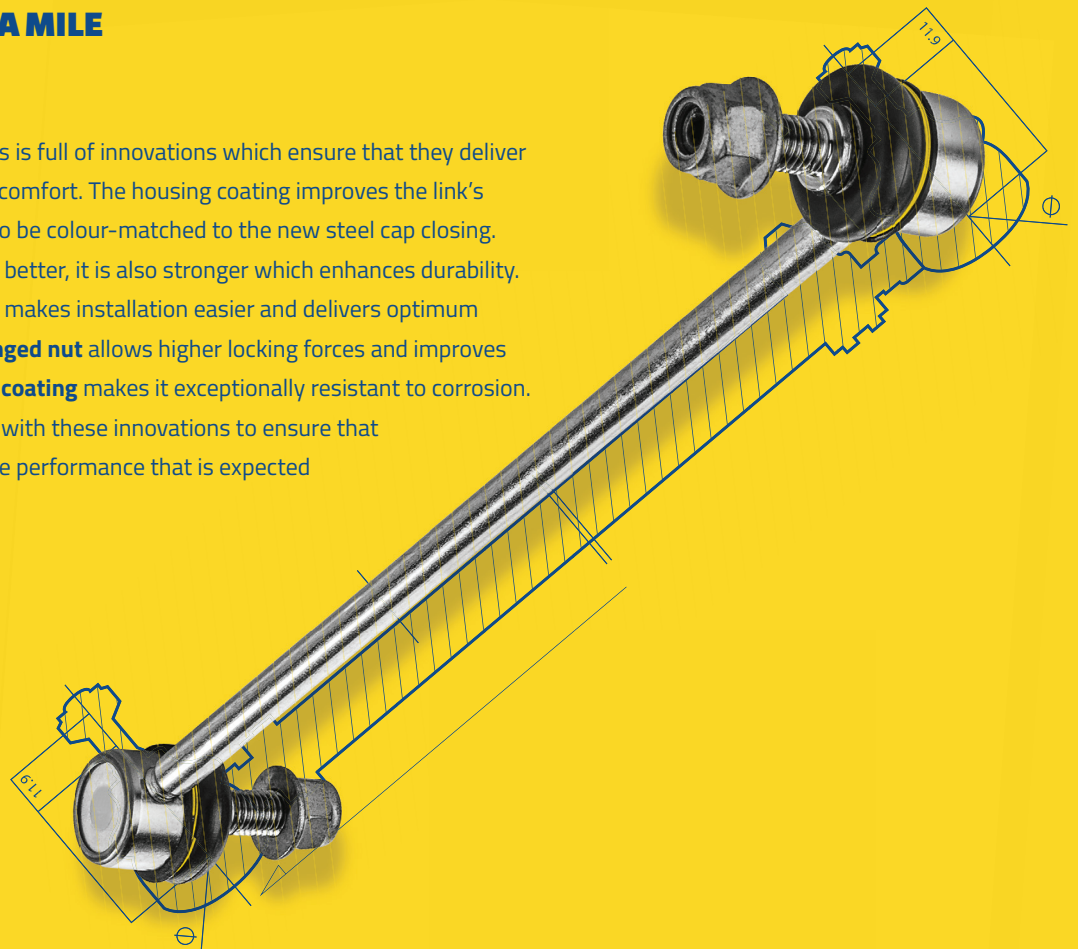

CONTROL ARMS

GOING THE EXTRA MILE FOR TOTAL CONTROL

Every single component in a control arm not only has to be extremely **durable and resistant** to corrosion and wear, they also have to deliver a **smooth and comfortable driving experience** . The innovations in our range of control arms are designed to ensure that they possess these very properties. To improve safety, the studs are **induction hardened** for strength and durability, while their **new hybrid core carbon fibre bearings** reduce the increase in radial deflection by 40% on average. Our **zinc flake coating** on accessories is far more corrosion-resistant than common phosphate coatings and also has an improved appearance. Fitting the control arm ball joint is far easier thanks to the use of **new synthetic grease** which also improves driving comfort and durability. The steel used for our sheet metal arms is **over 200% stronger** while our aluminium arms are **sand blasted which** , not only gives a better appearance, this also prevents cracks which enhances safety. When it comes to total control, we're sure it pays to go the extra mile.



TIE ROD ENDS & AXIAL RODS

GOING THE EXTRA MILE TO STAY ON THE RIGHT TRACK

Each driver wants steering that's **pin accurate** and which provides good feel and an excellent response in all conditions. The innovations we've incorporated in our range of tie rod ends ensure that they deliver. **Induction hardening** makes the studs five times more durable and twice as strong, ensuring that our tie rod ends are far safer in the long term. The **new hybrid core carbon fibre bearing** has better friction properties and the increase in radial deflection is reduced by 40% on average. The **new synthetic grease** in the bearing makes it easier for you to install, and gives your customers optimum smoothness. The **zinc flake coating** on the accessories not only looks better, it has outstanding corrosion-resistance. We've also gone the extra mile for you by adding **flanges to the nuts** which provides a larger surface thus increasing the locking force and therefore safety.

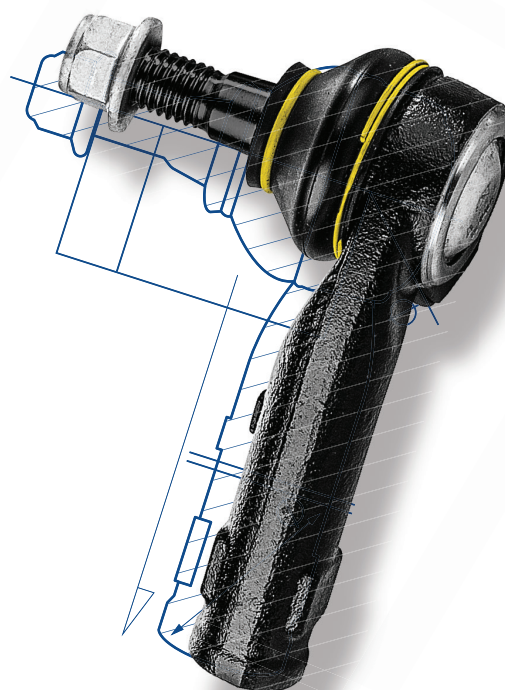

GOING THE EXTRA MILE TO MAKE THE RIGHT CONNECTION

Axial rods are a vital link in the steering system which you need to be able to **rely on**. The innovations in our range of axial rods ensure this essential durability. The **new hybrid core carbon fibre bearing** has superior friction properties and the increase in axial deflection is reduced by 40% on average. Smoothness of operation and installation are guaranteed, thanks to the **new synthetic grease** in the bearing. We've gone the extra mile with the **zinc flake coating on** the counter nut, which not only looks good but is also extremely resistant to corrosion.

PREVIOUS MOOG

NEW MOOG



BRIGHT NEW PACKAGING FOR BRIGHT NEW PARTS

At MOOG, we're always looking for improvement, both to our parts and to our service. With our **recent innovations** we've really gone the extra mile in making our products even better and, to expand our manufacturing footprint, we've opened our own **MOOG production plant**, in Barcelona. This will provide better control over our production to deliver an even better service.

We thought that we'd celebrate this by giving our differentiated Steering & Suspension products **distinctive, new packaging**. From now on, you'll be able to recognize them instantly in their bright new packaging.

WHEEL END BEARINGS

WHEEL END BEARINGS FOR THE NEXT GENERATION

MOOG is a **global market player** in wheel end bearings. Every part that is provided meets the same **stringent specifications** as the corresponding OE part. Wherever bearings are patented, MOOG provides the OE parts. In this way, MOOG always offers a part you can fully trust.

In line with the unquestioned quality reputation of its Steering & Suspension components, MOOG also offers an extensive range of wheel end bearings, comprising over 1,200 references, covering all LV and LCV types.

92%

COVERAGE

An extensive range covering all generations

With over 92% coverage and continuous new product introductions, MOOG demonstrates its commitment to be installers' and distributors' preferred supplier and partner of choice for wheel end bearings.

** EMEA Car parc coverage according TecDoc data and Headline*



True peace of mind

MOOG wheel end bearings are engineered, tested and validated to meet or exceed OE standards and come with a 3-year guarantee.



Everything included in the box

Every single wheel end bearing contains the necessary hardware and accessories such as bolts, nuts, washers, circlips, split pins, seals and caps for a perfect and trouble free installation.

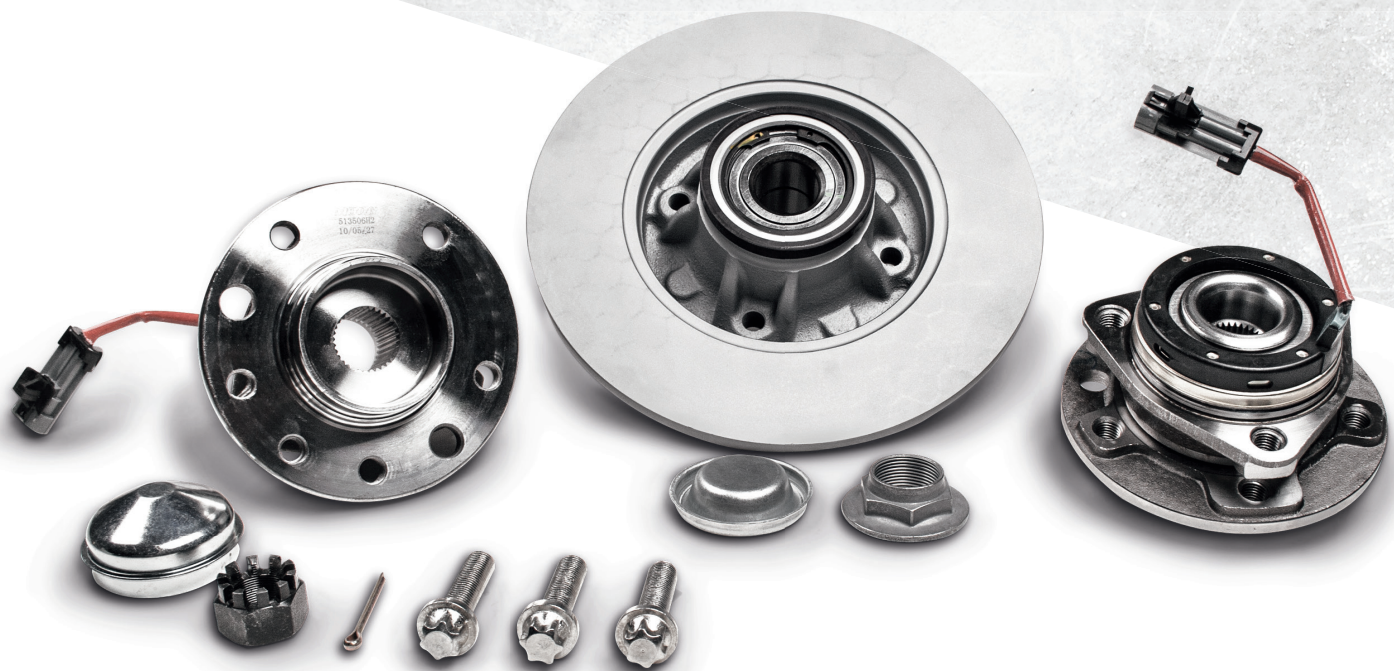

WHAT'S IN IT FOR YOU

AN EXTENSIVE RANGE COVERING ALL GENERATIONS

BRAKE DISC HUB ASSEMBLY KITS ARE COVERED IN THE RANGE

**A FULL ACCESSORIES PROGRAM
(INCLUDED IN EACH BOX) ALLOWS FOR CONVENIENT INSTALLATION**

3-YEAR GUARANTEE

OE LEVEL QUALITY

OE PARTS ARE PROVIDED WHEREVER BEARINGS ARE PATENTED

ONLINE CATALOGUE AT WWW.MOOGPARTS.EU

PRINTED CATALOGUE DEDICATED TO WHEEL END BEARINGS

TECHNICAL TIPS & TRICKS

VIRTUAL TRAININGS AVAILABLE 24/7 ONLINE

RANGE & COVERAGE

STEERING



DRAG LINKS & CENTRE ARMS
40 REFERENCES



AXIAL RODS
644 REFERENCES



STEERING RACK GAITER KITS
298 REFERENCES



TIE ROD ASSEMBLIES:
274 REFERENCES



TIE ROD ENDS
1027 REFERENCES

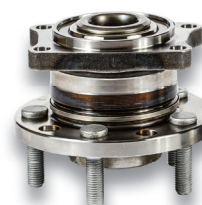

WHEEL END BEARINGS
1264 REFERENCES

SUSPENSION



WISHBONES
870 REFERENCES



TRACK CONTROL ARMS
740 REFERENCES



REPAIR KITS
99 REFERENCES



BALL JOINTS
610 REFERENCES



STABILISER LINK BARS
720 REFERENCES

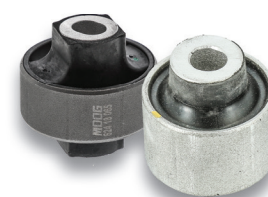

RUBBER-TO-METAL
2031 REFERENCES

**ROLLING CHANGE
1ST OF AUGUST 2018**



OLD



NEW

NEW WHEEL END BEARING BOXES ARE COMING YOUR WAY

With MOOG, we want our **products** to **stand out** from the crowd.
It starts with the **packaging**...

TIMELINE MOOG

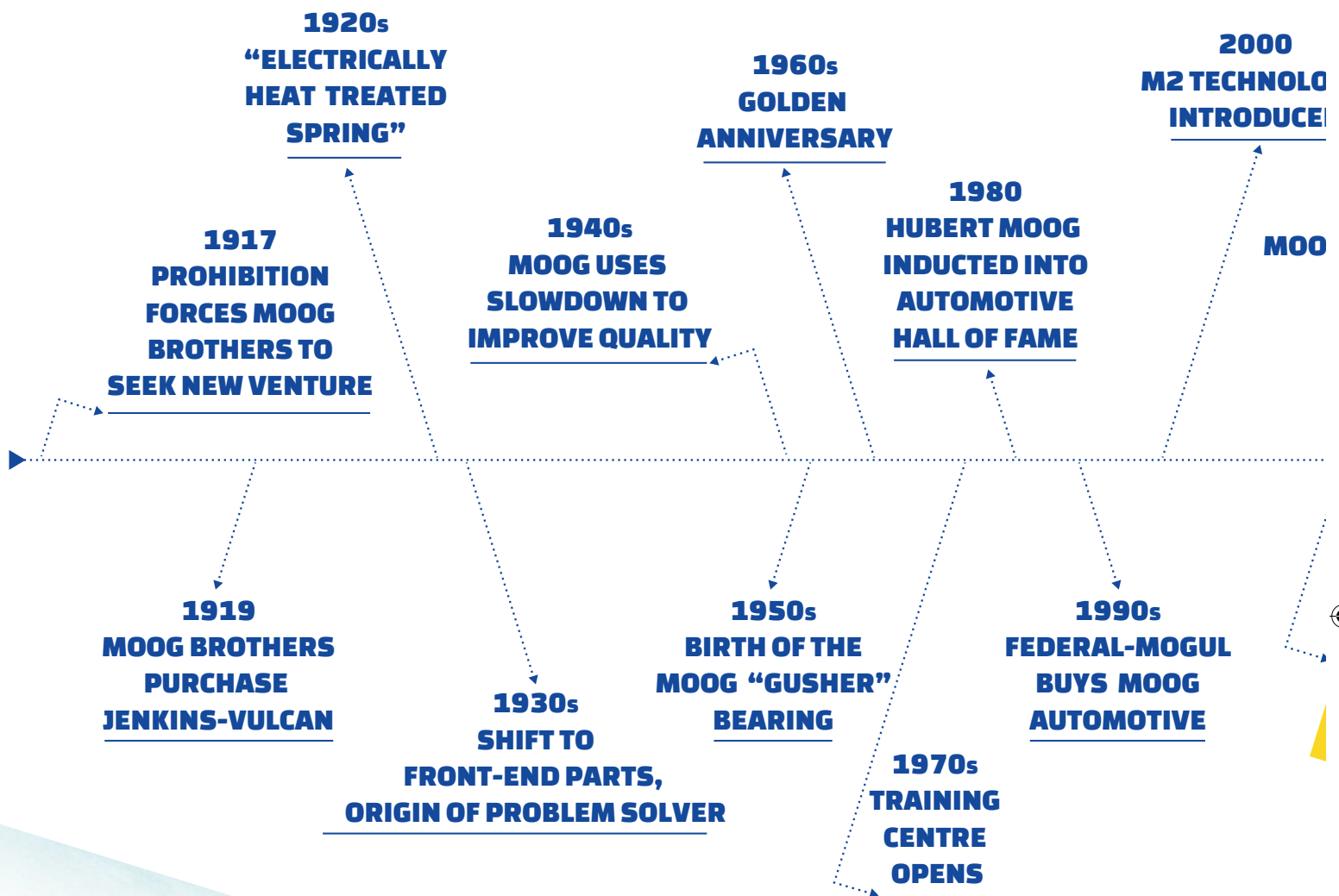

**DO
NOLOGY
DUCE**

**2008
MOOG LAUNCHED
IN ASIA**

2011
▶ **100% CATAPHORESIS
COATING**
▶ **COMMERCIAL
VEHICLES PROGRAM**

2014
**PIONEERING
COVERAGE
EXPANSION**

2016



2018
▶ **HYBRID CORE TECHNOLOGY**
▶ **PLANT OPENING "BARCELONA"**
▶ **STEERING & SUSPENSION
PRODUCT DIFFERENTIATION**

**2001
MOOG LAUNCHED
IN EUROPE**

2015
▶ **OFFICIAL STEERING &
SUSPENSION OF NASCAR®**
▶ **EUROPEAN TESTING
CENTRE OPENS**

2012
▶ **MOOG WEBSITE**
▶ **SUPPORT PACK
AND TRAINING**

2017
**SPONSORING NASCAR
WHELEN EURO SERIES™**

2018
HYBRID CORE TECHNOLOGY
PLANT OPENING "BARCELONA"
**STEERING & SUSPENSION PRODUCT
DIFFERENTIATION**



MOOG: QUALITY ON EVERY LEVEL

The professional service and quality of the parts used make all the difference for a workplace. That's why MOOG offers a range of Steering & Suspension parts and wheel end bearings that is second to none.

COUNT ON MOOG TO IMPROVE YOUR PROFITABILITY

We are well aware that time is the crucial factor in the profitability of your workplace and the satisfaction of your customers. So everything we do, we do to allow faster working, higher productivity and better profitability for the workplace.

DESIGNED AND TESTED TO THE HIGHEST STANDARDS

As a leading aftermarket supplier, we believe our parts' performance should be the best. That's why we invest heavily in testing and re-engineering not only our products, but also the machinery on our automated production lines, according to the highest industry standards, to ensure quality and safety for drivers.



QUALITY GUARANTEED

Thanks to a comprehensive New Product Introduction process and rigorous development and testing procedures we are confident about the quality of our products. That's why every MOOG part is backed-up by a 3-year guarantee.*

On top of this, any feedback from the market is used by our engineers to drive continuous product innovations and improvements. That's our guarantee for your peace of mind.

* Guarantee is subject to terms and conditions.



AN EASY SOURCE TO GET THE MOST OUT OF THE AVAILABLE MOOG TOOLS



QUICK IDENTIFICATION OF MOOG PARTS ON E-CATALOGUE

- Fitting diagrams with separate images of front and rear axles
- Clear photos of each part
- Includes daily updates on new vehicle listings and NPI's

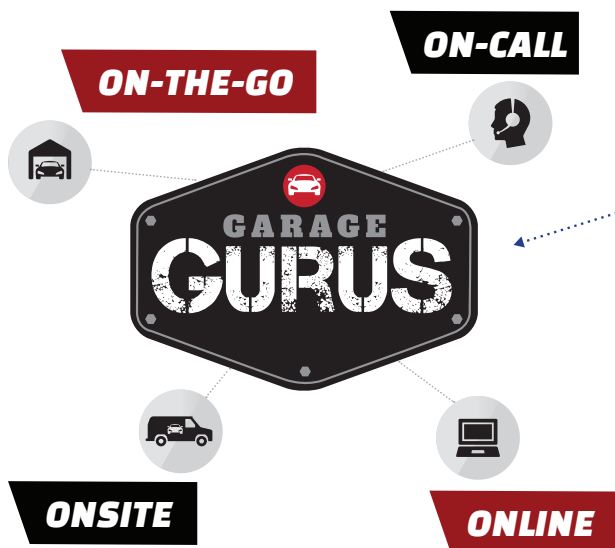
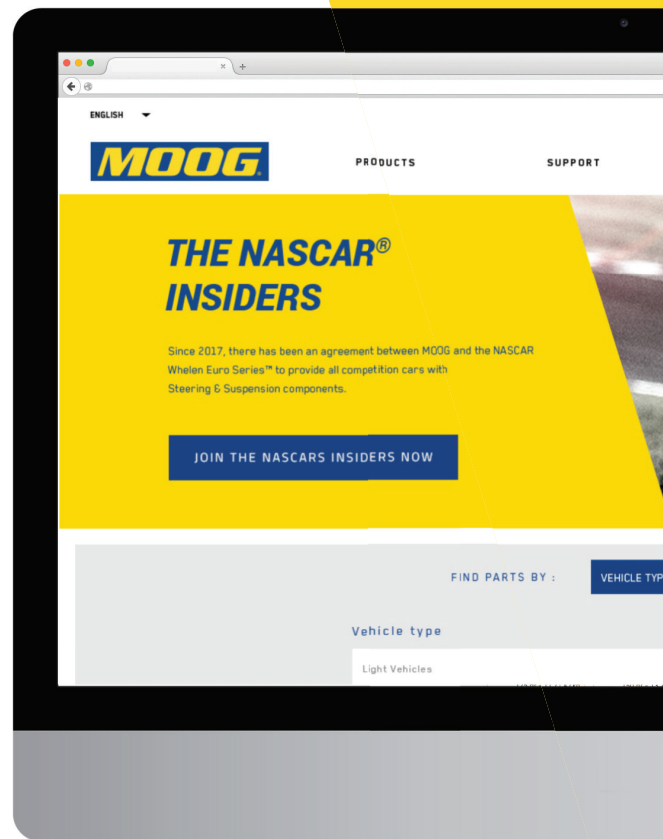
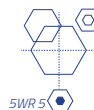

TRAINING BECOMES EASY WITH VIRTUAL CAMPUS

- Steering & Suspension parts training tailored to your needs
- Full 24/7 access to 8 online courses and webinars
- Choose your level of expertise and speed



QUICK CHECK IF IT'S ORIGINAL MOOG QUALITY

- Our anti-counterfeit program immediately informs you
- Latest Priospot technology assures that each box contains original MOOG parts

 www.moogparts.eu

Also available in other languages:

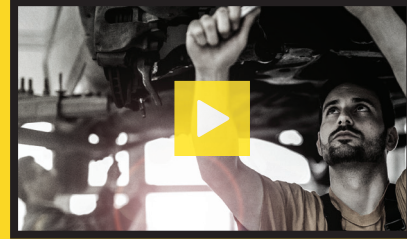

VIDEOS

- MOOG makes your chassis repairs easy
- Check out our videos for news and updates

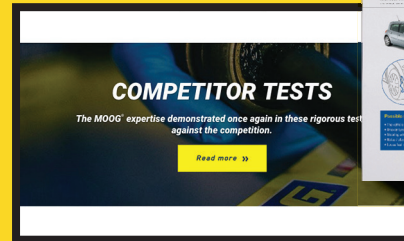
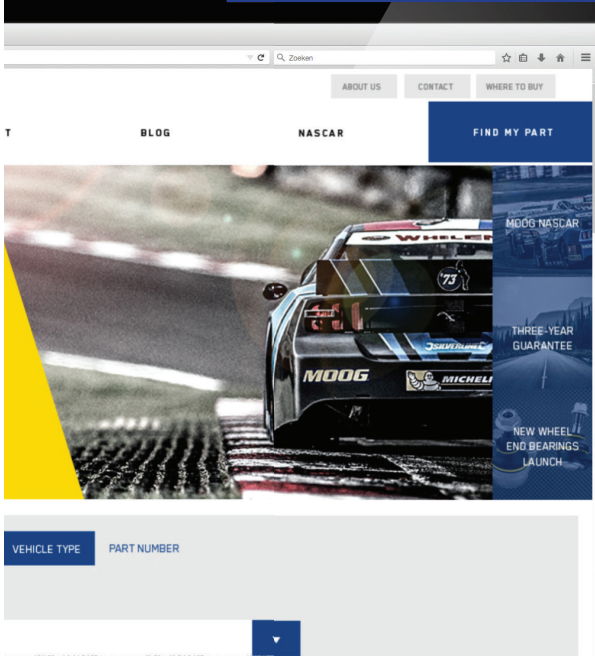

ALWAYS UP-TO-DATE ON PRODUCTS AND SERVICES

- Download our full range of product specifications
- Concise newsletters with value-adding information
- Solution and technical bulletins

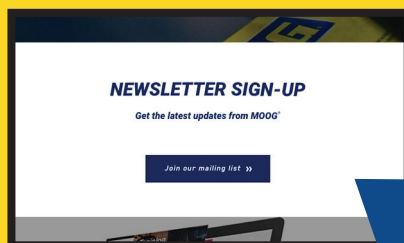

**SUBSCRIBE NOW
ON MOOGPARTS.EU AND
RECEIVE REGULAR UPDATES!**

MOOG E-MAIL ALERTS

- Stay up-to-date and subscribe to our e-mail alerts

MOOG

NASCAR

OFFICIAL STEERING & SUSPENSION OF NASCAR



MOOG

JOIN THE

NASCAR[®] INSIDERS

FEDERAL-MOGUL
MOTORPARTS

NASCAR
WHELEN
EURO SERIES

©2018 Federal-Mogul Global Aftermarket EMEA, BVBA. NASCAR[®] is a registered trademark of the National Association for Stock Car Auto Racing, Inc. NASCAR Whelen Euro Series[™] is a registered trademark of SARL DutyCar. The NASCAR Whelen Euro Series[™] logo and word mark are used under license by the National Association for Stock Car Auto Racing, Inc., and Whelen Engineering Company, Inc. MOOG is a trademark owned by Federal-Mogul LLC, or one or more of its subsidiaries, in one or more countries. All other trademarks shown are the property of their respective owner(s).

MOOG®

STEERING & SUSPENSION FOR COMMERCIAL VEHICLES



QUALITY AND SAFETY FIRST AT MOOG®

Chassis components play a vital role in keeping vehicles stable, ensuring predictable handling and safe operation throughout a vehicle's lifetime. Today, the majority of commercial vehicles in Europe weigh over 16 tonnes (and some as much as 30 tonnes), so the loads and stresses that a truck's chassis must cope with are huge. Because we understand this, all MOOG® parts meet or exceed OE quality standards and undergo rigorous testing to ensure that they offer the highest quality and reliability.



EASY TO INSTALL

With over 1.000 references, MOOG offers an extensive range of Steering & Suspension parts for trucks and busses. We keep in touch with market needs through continuous new product introductions. Every single MOOG part comes with all the necessary hardware and accessories. In addition, repair kits and pre-assembled parts are also available to ensure a perfect and hassle-free installation.



PRODUCT IS KEY

MOOG parts are designed, produced and tested to withstand extreme situations. Our engineers use the original equipment as the master to develop all MOOG products. The metallurgy and geometry of every original part is identified, measured and improved whenever possible. Next, every product is subjected to extensive testing to ensure optimal performance and maximum durability.

WE'RE PROBLEM SOLVERS

We know that your time is precious, so at MOOG, we offer you a wide range of tools to make your life easier and save you time. We have industry-leading online and offline catalogues, an online training centre and training videos. We back these up with our solution and technical bulletins, newsletter and e-mail alerts. Not to mention the MOOG quality check and much more...

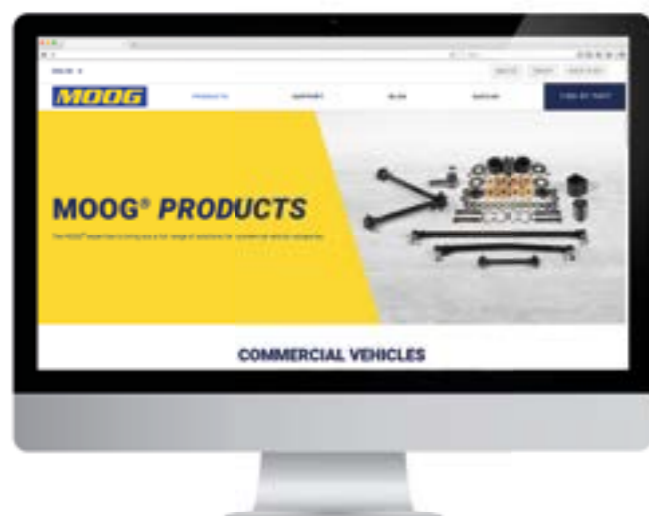

MOOG: YOUR ONE-STOP-SHOP, COVERING ALL MAJOR COMMERCIAL VEHICLE BRANDS AND PART TYPES

The actual MOOG CV range offers more than 1000 parts, one of the widest in Steering & Suspension.

- ▶ DAF
- ▶ Iveco
- ▶ MAN
- ▶ Mercedes-Benz
- ▶ Renault
- ▶ Scania
- ▶ Volvo



Tie Rod Ends / Ball Joints /
Ball Sockets / Gearshift Links /
Joint Shift Rods



Track Control Arms
Rods / Strut Stabilisers



V-Bars



Tie Rod Assemblies /
Tie Rods Steering



Bushings / Silent Blocks / Repair Kits /
Stabilisers Bushes /
Rubber Metal-bearings



Drag Links / Centre Rods /
Rod Assemblies

MOOG QUALITY

As a leading aftermarket supplier, we make sure that our parts provide a long-term solution for customer problems. We believe our products have to perform even better than the original equipment.

DESIGN BASED ON OE MASTER

When our engineers develop any new MOOG product, they use the original equipment part as a master. They identify and evaluate the geometry and metallurgy of these original parts and improve them wherever they can. Each product is then tested exhaustively to ensure that we can guarantee optimum performance and maximum durability. The advantage of hindsight.

QUALITY THAT MEETS THE ORIGINALS

MOOG offers more than just quality parts. We provide trust. All our products undergo extensive testing and they are compared to original equipment as well as to our competitors' parts.

TESTED FOR GREATER TRUST

The reason is simple: if issues crucial to Steering & Suspension parts are not detected in time, it can cause serious problems for the vehicle's longevity as well as for the driver's safety. When these parts have to be replaced, this has to be done with reliable parts. And that is exactly what MOOG offers. The numbers don't lie.

THE 4 STEPS TO LAUNCHING A PERFECT NEW MOOG PRODUCT

MOOG offers one of the most complete ranges of Steering & Suspension parts. We support distributors and installers in their ambition to give their customers the best service and the best quality in the market. The MOOG CV product offering is continuously expanding. Every single new part follows the same four steps before being introduced.

STEP 1



NEW PRODUCT INTRODUCTION PREPARATION

- ▶ Define the scope.
- ▶ Plan resources: people and test equipment.
- ▶ The company, as a global supplier, employs engineers with decades of experience with evaluating OEM and competitor's products.

STEP 2



DESIGN VALIDATION

- ▶ Purchase the OE part as a master or reference for the MOOG product and measure the critical parameters.
- ▶ Compare the proposed design with the OE design in terms of dimensions, material and physical properties.
- ▶ When the product meets or exceeds the test results of the OE, engineers will approve the part for design.

STEP 3

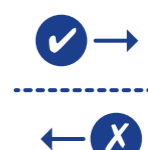

PRODUCT & PROCESS VALIDATION

- ▶ When the part is approved, a production process will be drawn up. The quality department must validate this process.
- ▶ Before the final production release, first off the line samples are tested and measured for conformity.

STEP 4



PRODUCT LAUNCH

- ▶ Packaging matters, which is why we provide kits containing the part and all the necessary hardware such as bolts and washers.
- ▶ Every part will be subjected to a pre-delivery inspection at the manufacturing plant and one last inbound control at our distribution centre has to ensure the product's quality and consistency.





A PRODUCT QUALITY THAT MATCHES OR EXCEEDS OEM REQUIREMENTS

MOOG puts a lot of attention on the overall quality of every single part. This means that every product meets or exceeds OE specifications. In order to guarantee this, MOOG has introduced procedures, materials and (production and testing) methods that are often unique in the market. Some examples of this are...

IN-HOUSE VALIDATION

TESTED ACCORDING TO THE HIGHEST INDUSTRY STANDARDS

In order to guarantee a superior performance, our test facilities in St. Louis (USA) and Kontich (Belgium) examine all aspects of our products. This includes: materials, durability, wear, fit-form-function, OE specification conformity and OE load capability examinations. This allows a reactive and fast-paced development process. Additionally, we ensure every part arrives and leaves in perfect condition through inwards and outbound controls at our distribution centres.

PRODUCT DESIGN

METROLOGY (DIMENSIONAL)

MATERIALS

DURABILITY TESTING

ENVIRONMENTAL TESTING

VEHICLE TESTING

VEHICLE INSPECTION

MACHINE SHOP



DUST COVERS

Chloroprene for rubber and Polyurethane for plastic dust covers go through dynamic rotation and swinging tests in a climate chamber where water jet pressure, temperature and frequency is adjustable.



CLAMPS, NUTS & BOLTS

Metallurgical analysis for each component and accessory is undertaken. Even for the smallest or seemingly less important components such as nuts and bolts.



HOUSINGS

CNC Lathe machined housings with correct tolerances are further strengthened with induction hardening (up to 60 Hrc). Depending on the type of housing, a protective coating is applied - a manganese phosphate coating for female housings and an electrostatic painting for male housings.



BALL PIN

MOOG only uses OE material as this component is subject to the highest dynamic load through various radial and axial directions. Even with heat/induction treatment or cementation, cracks inside the ball pin can cause premature failures. MOOG uses the unique Magnaflux method to detect internal cracks within the ball pin for 100% crack control.



TUBE

All tubes are manufactured with seamless steel (ST 52 NBK DIN 2391). The Eddy Current method is used to detect possible flaws or cracks in conductive materials. The tubes go through a 100% Normalisation Process, which is a required method to refine grain structure.

TROUBLE TRACING IN CV

Periodic inspection of the Steering & Suspension system is essential. Our clients often ask us why MOOG is superior to another product. Here are some of the shortcomings you can encounter with products from other brands:

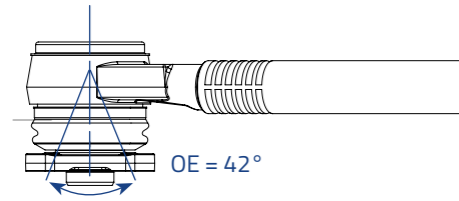

V-BAR: OSCILLATION ANGLE

FACT: Oscillation angle was measured as 38°.

WITH MOOG: The angle should be minimum 42° according to OE specifications. Lower oscillation may cause part breakage.



V-BAR / TORQUE ROD: COATING OF REPAIR KITS

FACT: There is no coating on the products and the surface of repair kits appears damaged by exposure to external agents.

WITH MOOG: All products are protected by the best applicable coating (electrostatic, phosphate, cataphoresis, etc.)



V-BAR / TORQUE ROD: TUBE MATERIAL HARDNESS

FACT: Spectral analysis reveals that tube hardness is measured as 50-60 HB.

WITH MOOG: The hardness of the correct tube material DIN 2391 St52-NBK should be between 135-160 HB. MOOG follows this standard for all its products.

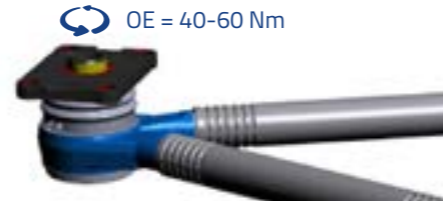

V-BAR: FLANGE ROTATION TORQUE

FACT: Flange rotation torque measurements of competitor products range between 230-270 Nm.

WITH MOOG: According to OE criteria, it should be between 40-100 Nm. MOOG products are always between 40-100 Nm.



V-BAR / TORQUE ROD: SURFACE QUALITY OF REPAIR KITS

FACT: The surface quality of repair kits is poor and big burrs appear, which results in a low quality appearance of the product.

WITH MOOG: The product is always of excellent standard. MOOG always makes sure its products are the benchmark before going to market.



V-BAR / TORQUE ROD: TUBE MATERIAL PROTECTION

FACT: Whilst the thickness of the coating conforms to standards, there are big burrs on the product.

WITH MOOG: All products are protected by the best applicable coating. Remember, MOOG was one of the first companies to introduce cataphoresis coating on sheet metal wishbones and is continuously improving its protection measures.



V-BAR: SURFACE QUALITY OF CENTRAL BUSH

FACT: The surface quality of the central bush is Ra: 3.2.

WITH MOOG: The value in OE and MOOG products is Ra: 0.4. Roughness may affect flange rotation torque negatively and can cause quicker abrasions on a plastic bearing surface.



V-BAR / TORQUE ROD: CIRCLIP ASSEMBLY MISTAKE

FACT: Repair kits are assembled in a vertical position against the tube axis.

WITH MOOG: In order to achieve a higher resistance, circlips should be assembled at a 45° position on the tube axis.

MOOG MULTI-RING ASSEMBLY SOLUTION TACKLES TWO MAJOR ISSUES!

THE PROBLEM – circlip ring breakdowns

A circlip ring used by a well-known CV manufacturer failed frequently causing a high replacement rate. So the question was, how do we reinforce it?

THE COMPETITION – from one problem to another

A competitor of MOOG put a solution forward: the diameter was slightly enlarged and the tangential force was increased.

THE CONSEQUENCES – OE compatibility fails

But modifying the design created a problem – the part no longer fit with other OE parts. What's more, bigger circlips with deeper ring channels had to be grooved into the part.

This meant that only the competitor's replacement parts fit.

THE SOLUTION – Meet MOOG's "Multicycle Ring"!

MOOG has reinforced the circlip by a technique called the multicycle ring. This solution respects OE design and ring groove dimensions. As a result repair kits or OE parts can now be quickly and easily fitted.



MOOG's solution respects the OE design

Multicycle ring: reinforces parts, respects OE dimensions

IT'S EASY TO SEE WHY MOOG IS SO PASSIONATE WITH OE SPECIFICATIONS

Other providers develop solutions that may well address one problem, but neglect overall OE specifications. The consequences become clear only at the moment of assembly: while the part in question may be stronger and more wear-resistant, it simply doesn't fit the "original" counterpart in the vehicle. When it comes to enforcing the V-bar and torque rod assembly, this means the ring groove dimensions must be preserved in order to make other replacement kits and OE parts fit.

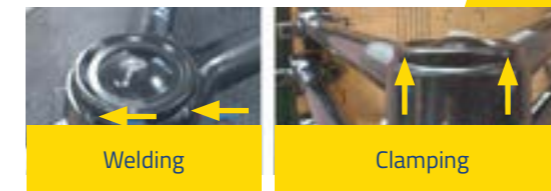

V-BAR : CAP CLOSING METHOD

FACT: Welding is used in order to close the caps.

WITH MOOG: The best method is the "closely united method" which is used for MOOG products.



BUILT TO LAST: MATERIALS & PROTECTION ACCORDING TO MOOG



HIGH-QUALITY STEEL MATERIALS

- ▶ All materials used meet or exceed the Original Equipment specification.



RUBBER FORMULATION

- ▶ Maximum lifespan thanks to protecting additives against oil, ozone and hydrocarbons. High resistance to age related cracking.
- ▶ The natural/synthetic rubber formulation ensures optimal performance and allows for more elastic deformation under stress, without cracking.

LONG LIVE MOOG: UNIQUE PROTECTION MEASURES

In order to extend the durability and safe operating life of every MOOG CV part, our engineers developed some protective measures that are quite unique in the market.



CORROSION PROTECTION

- ▶ MOOG corrosion treatments are tested under extreme conditions to ensure maximum rust and pollutant protection.

MOOG tests for longer than 500 hours.

- ▶ Longer protection against oxidisation
Improved durability.



HEAT TREATMENT

- ▶ Localised surface hardening in high-stress areas on ball spheres provide much-needed wear-resistance for longer product life.
- ▶ Distortion is minimised and parts dimensions remain constant to reduce play between ball sphere and housing.
 - ▶ **Increased durability**
 - ▶ **Improved stability**
 - ▶ **Reduced noise**



WHAT'S IN IT FOR YOU

INSTALLER BENEFITS

- ▶ MOOG's extensive experience from the LV aftermarket
- ▶ Market-leading range and coverage
- ▶ OE level production & testing procedures
- ▶ OE matching or exceeding quality
- ▶ Enhanced protection against friction and rust
- ▶ Excellent value for money

END USER BENEFITS

- ▶ Reduced downtime for commercial fleet
- ▶ Enhanced safety and performance
- ▶ Tested and proven OE quality
- ▶ Precise steering, stable suspension
- ▶ Smoother drive results, less noise
- ▶ Less breakdowns
- ▶ Reduced fuel consumption and CO₂ emissions

AN EASY SOURCE TO GET THE MOST OUT OF THE AVAILABLE MOOG TOOLS



QUICK IDENTIFICATION OF MOOG PARTS ON E-CATALOGUE

www.moogparts.eu

Also available in other languages:



VIDEOS

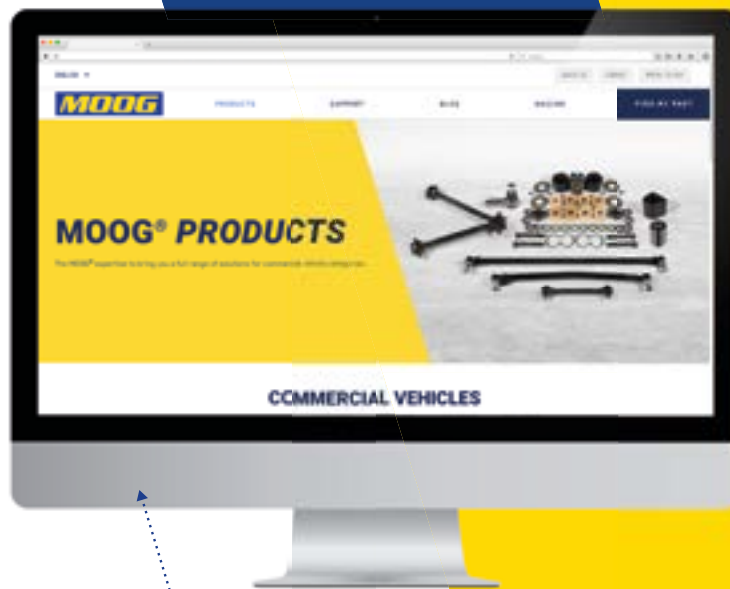

ON-THE-GO **ON-CALL**

ONSITE **ONLINE**

TRAINING BECOMES EASY WITH VIRTUAL CAMPUS



SUBSCRIBE NOW ON MOOGPARTS.EU AND RECEIVE REGULAR UPDATES!

MOOG E-MAIL ALERTS

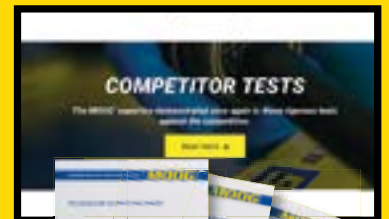

ALWAYS UP-TO-DATE ON PRODUCTS AND SERVICES