

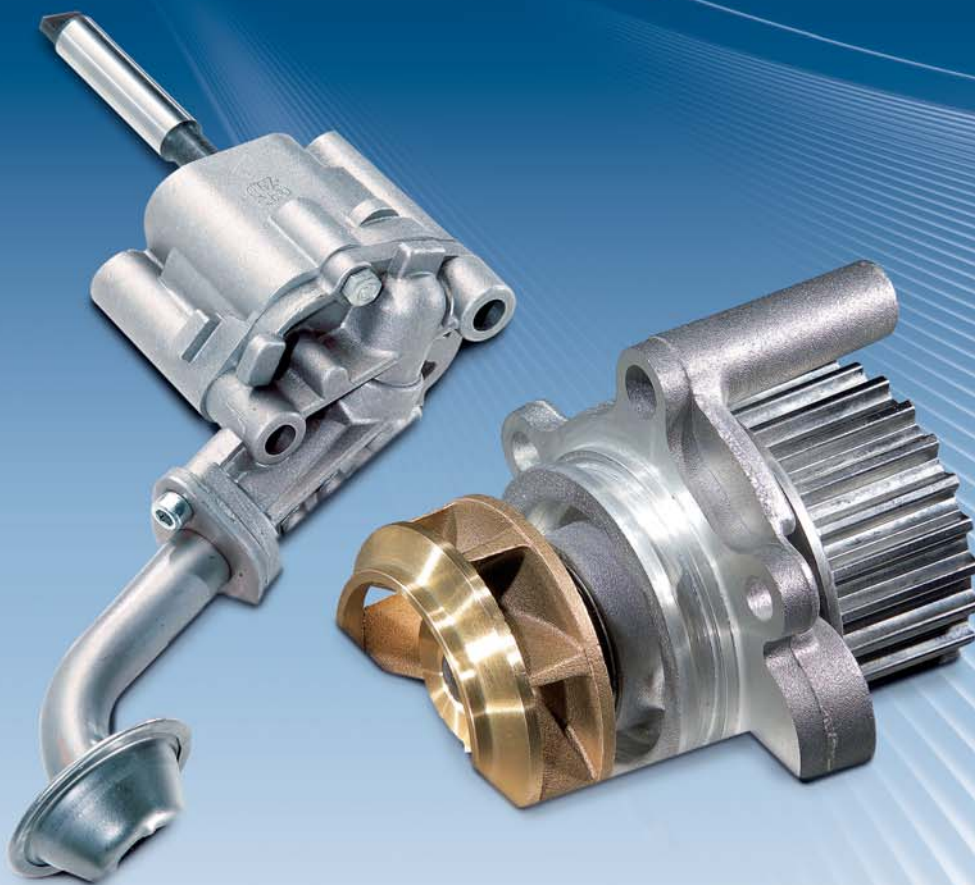

2009



Wasserpumpen | Ölpumpen
Water pumps | Oil pumps
Pompes à eau | Pompes à huile
Bombas de agua | Bombas de aceite
Водяные насосы | Масляные насосы



Please visit ...

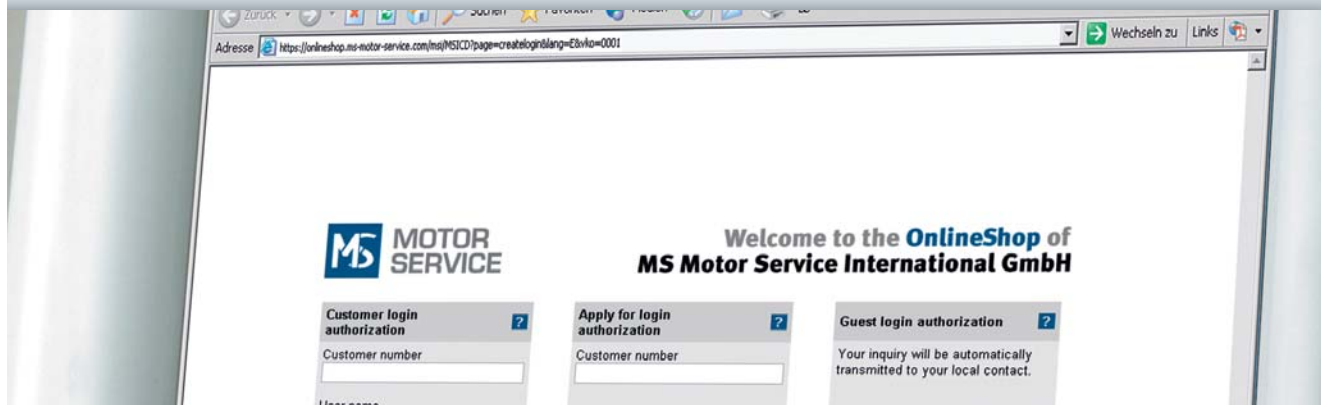

<http://onlineshop.ms-motor-service.com>



- DE** Melden Sie sich in unserem OnlineShop als Kunde mit Ihrem Passwort an oder nutzen Sie den Gastzugang.
- EN** Just register at our OnlineShop as a customer with your password or click on guest access.
- FR** Connectez-vous comme client avec votre mot de passe à notre boutique ou servez-vous de l'accès visiteur.
- ES** Conectarse como cliente con su corresp. contraseña a nuestra tienda on line o pulsar acceso huésped.
- RU** Зарегистрируйтесь в нашем OnlineShop как клиент с вашим паролем или как гость.

MS Motor Service Product Disc



- DE** Die Inhalte des Onlineshop, sind auch als elektronischer Katalog auf der „Motor Service Product Disc“ verfügbar. Kontaktieren Sie hierzu Ihren Ansprechpartner.
- EN** The information in our online shop is also available as electronic catalogue on the “Motor Service Product Disc”. Please get in touch with your contact person in this regard.
- FR** Les informations de notre boutique en ligne sont également disponibles sous forme de catalogue électronique sur le CD Rom «Motor Service Product Disc». Veuillez contacter votre correspondant habituel à cet égard.
- ES** Los contenidos de la tienda en línea también están disponibles como catálogo electrónico en el “Motor Service Product Disc”. Por favor, contacte con su corresponsal comercial.
- RU** Содержание Интернет-магазина имеется также в виде электронного каталога на компакт-диске продуктов Motor Service („Motor Service Product Disc“). По этому поводу обращайтесь, пожалуйста, к Вашему непосредственному контактному лицу.



2009

WASSERPUMPEN / ÖLPUMPEN

WATER PUMPS / OIL PUMPS

POMPES À EAU / POMPE À HUILE

BOMBAS DE AGUA / BOMBAS DE ACEITE

ВОДЯНЫЕ НАСОСЫ / МАСЛЯНЫЕ НАСОСЫ

DE	Grundlagen	Seite	2
	Hinweise zur Benutzung des Kataloges	Seite	4
EN	Basics	Page	18
	Instructions for using the catalogue	Page	20
FR	Généralités	Page	34
	Précisions sur l'utilisation du catalogue	Page	36
ES	Fundamentos	Página	50
	Indicaciones para la utilización del catálogo	Página	52
RU	Основы	страница	66
	Указания по использованию каталога	страница	68

Disclaimer

Namen, Beschreibungen, Nummern von Motoren, Fahrzeugen, Produkten, Herstellern etc. sind nur zu Vergleichszwecken aufgeführt.
Die im Katalog enthaltenen Teile sind Ersatzteile in garantierter KS-Qualität für die aufgeführten Motoren und Fahrzeuge.

Names, descriptions, figures of engines, vehicles, products, manufacturers etc. are only for reference.
The parts in this catalogue are spare parts of KS guaranteed quality, suitable for the applications listed.

Les noms, les descriptions et les numéros de moteur, véhicules, produits, constructeurs etc. figurant dans ce catalogue ne sont donnés qu'à des fins de comparaison.
Les articles de ce catalogue sont des pièces de rechange de qualité garantie KS pour les applications mentionnées.

La nomenclatura y las descripciones de motores, vehículos, productos, fabricantes etc. que aparecen en este catálogo, sólo se indican para fines de comparación.
Las partes que aparecen en este catálogo son repuestos de garantizada calidad KS, para las aplicaciones indicadas.

Наименования, описания, номера двигателей, транспортных средств, продуктов, изготовителей и т. п. являются только информацией для сравнения.

Детали, названные в каталоге, являются запасными частями качества KS для перечисленных двигателей и транспортных средств.

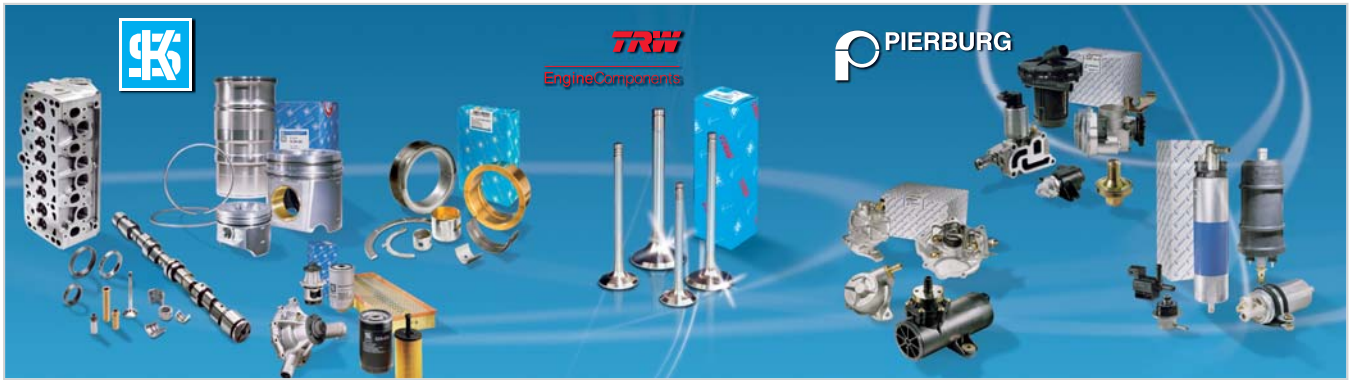

MS Motor Service International GmbH

ist die Vertriebsorganisation für die weltweiten Aftermarket-Aktivitäten der Kolbenschmidt Pierburg AG. Sie ist ein führender Anbieter von Motor-komponenten für den freien Ersatz-teilmarkt mit den Premium-Marken KOLBENSCHMIDT, PIERBURG und TRW Engine Components. Ein breites

und tiefes Sortiment ermöglicht den Kunden, Motorenteile aus einer Hand zu beziehen. Als Problemlöser für Handel und Werkstatt bietet Sie darüberhinaus ein umfangreiches Leistungspaket und die technische Kompetenz als Tochtergesellschaft eines großen Automobilzulieferers.

Kolbenschmidt Pierburg Gruppe

Als langjährige Partner der Automobilhersteller entwickeln die Unternehmen der Kolbenschmidt Pierburg Gruppe innovative Komponenten und Systemlösungen mit anerkannter Kompetenz in Luftversorgung und Schadstoffreduzierung, bei Öl-, Wasser- und Vakuumpumpen, bei Kolben, Motorblöcken und Gleitlagern.

Wichtige Hinweise

MS Motor Service International GmbH wird im Folgenden mit MSI abgekürzt.

Die Angaben in diesem Katalog sind sorgfältig bearbeitet, aber unverbindlich. Für die Richtigkeit dieser Angaben übernehmen wir keine Gewähr. Insbesondere können Änderungen der Ausrüstung durch die Fahrzeug oder Motorenhersteller bzw. Änderungen der Bezeichnungen nicht ausgeschlossen werden. Bitte erkundigen Sie sich gegebenenfalls bei unserem Technischen Kundenservice. Informationen über eventuelle Fehler im Katalog sind uns stets willkommen und werden in den zukünftigen Ausgaben korrigiert. Namen, Beschreibungen und Nummernangaben von Fahrzeugen oder Herstellern u. ä. sind nur zu Vergleichszwecken aufgeführt. Die im Katalog aufgeführten Teile sind Ersatzteile in KS-Qualität.

Abbildungen, Schemazeichnungen und andere Angaben dienen der Erläuterung und Darstellung und können nicht als Grundlage für Einbau, Lieferumfang und Konstruktion verwendet werden. Dies gilt insbesondere für Herstellerangaben. Angaben über Original-Ersatzteilnummern der Fahrzeug- und Motorenhersteller dienen nur zu Vergleichszwecken. Sie sind keine Herkunftsbezeichnungen und dürfen gegenüber Dritten nicht verwendet werden. Für die Anwendung der Vergleichslisten können wir insbesondere wegen möglicher Änderungen und/oder Maßdifferenzen der einzelnen Hersteller keine Haftung übernehmen. Soweit der Katalog Artikel beinhaltet, die nicht von MSI hergestellt wurden, stammen die Produktangaben und Daten vom jeweiligen Hersteller. Es wird keine Haftung übernommen für die Richtigkeit der Daten und dass

das Produkt für den beabsichtigten Verwendungszweck geeignet ist. Um dies sicherzustellen, ist in jedem Fall vor Einbau der fachkundige Rat des Herstellers oder dessen autorisierter Vertragswerkstatt einzuholen. Die im Katalog angebotenen Teile sind nicht für den Einsatz in Luftfahrzeugen bestimmt. Bei der Verwendung in Marine-Motoren ist darauf zu achten, dass bei gleicher Motorbezeichnung unterschiedliche Motorenteile (z.B. Kolben) zum Einsatz kommen können. Nachdruck, Nachahmung und Vervielfältigung, auch auszugsweise, ist nur mit unserer schriftlichen Genehmigung und mit Quellenangabe gestattet. Mit Erscheinen dieses Kataloges verlieren frühere Ausgaben ihre Gültigkeit.

Änderungen vorbehalten.

Wertvolle technische Informationen finden Sie in

Service
Tipps & Infos

Einsehbar sind diese Broschüren auch auf unserer Homepage

www.ms-motor-service.com



Inhaltsverzeichnis	Seite
Wichtige Hinweise	2
Qualitätsmanagement.....	3
1. Hinweise zur Benutzung des Kataloges	4
2. Produktinformationen.....	6
2.1 Wasserpumpen.....	6
2.1.1 Kühlkreislauf	6
2.1.2 Bestandteile einer Wasserpumpe	7
2.1.3 Bauarten	8
2.1.4 Technische Übersicht	9
2.1.5 Wichtiger Hinweis	10
2.1.6 Schäden.....	10
2.2 Ölpumpen	11
2.2.1 Motorschmierung	11
2.2.2 Motorschmiersysteme.....	12
2.2.3 Bauarten und Pumpenausführung	13
2.2.4 Ölpumpen-Antriebsarten	14
2.2.5 Allgemeine Einbauhinweise.....	15
2.2.6 Ursachenermittlung / Schadendiagnose	16
3. Hauptanwendungen / Produktabbildungen	81
4. Programmergänzungen.....	163
5. Herstellerverzeichnis	167
6. Produktprogramm	171
7. Vergleichsliste.....	1271
8. Formblatt „Quality Information Report“	
9. Verkaufs- und Lieferbedingungen	

Qualitätsmanagement

Unsere Erzeugnisse zeichnen sich durch hohe Präzision aus, die durch professionelle Produkt- und Prozessentwicklung, moderne Fertigungsmethoden und umfassende Kontrollen erreicht wird. Unser Qualitätsmanagement ist nach ISO 9001 und ISO/TS 16949 zertifiziert und wird ständig weiterentwickelt. Sollte trotz der laufend durchgeführten Kontrollen während des Produktionsprozesses und der gründlichen Endkontrolle ein Material- oder Fertigungsfehler auftreten, übernehmen wir selbstverständlich innerhalb der Verjährungsfrist entweder die Instandsetzung des Motors oder den Ersatz des beanstandeten Erzeugnisses. Derartige Beanstandungen müssen

uns binnen einer Frist von 30 Tagen nach Auftreten des Schadens schriftlich mitgeteilt werden. Die Verjährungsfrist für Mängelansprüche beträgt 24 Monate, gerechnet ab Ablieferung der Sache. Mängelansprüche erlöschen, wenn der Liefergegenstand von fremder Seite oder durch Einbau von Teilen fremder Herkunft verändert wird, es sei denn, dass der Mangel nicht in ursächlichem Zusammenhang mit der Veränderung steht. Sie erlöschen weiter, wenn Handhabung und Einbau nach geltender Vorschrift nicht befolgt wurde. Normaler Verschleiß und Beschädigung durch unsachgemäße Behandlung sind von der Gewährleistung ausgeschlossen.







1. Hinweise zur Benutzung des Kataloges

Motorenindex

Am Anfang des jeweiligen Herstellers befindet sich eine ausführliche Suchhilfe.
Die Motorenbezeichnung sind aufsteigend alphanumerisch sortiert.

DEUTSCH

		INDEX		DEUTZ					
		Cyl.	 mm	cm ³		Comp. Ratio ε	kW	PS	Pos
A 6 M 816	D (AN)	6	142 x 160	15204	2	16:1	145-172	197-234	45
A 6 M 816 R	D (LA)	6	142 x 160	15204	2	16:1			45
A 6 M 816 U	D (LA)	6	142 x 160	15204	2	16:1			45
A 6 M 816 W	D (LA)	6	142 x 160	15204	2	16:1			45
A 8 M 816	D (A)	8	142 x 160	20272	2	16:1	190-230	259-313	45
A 8 M 816 C	D (LA)	8	142 x 160	20272	2	16:1			45
A 8 M 816 CR	D (LA)	8	142 x 160	20272	2	16:1			45
A 8 M 816 R	D (LA)	8	142 x 160	20272	2	16:1			45
A 8 M 816 U	D (LA)	8	142 x 160	20272	2	16:1			45
A 8 M 816 W	D (LA)	8	142 x 160	20272	2	16:1			45
A 12 M 816	D (A)	12	142 x 160	30438	2	16:1	162-321	220-436	45
A 12 M 816 C	D (LA)	12	142 x 160	30438	2	16:1			45
A 12 M 816 CR	D (LA)	12	142 x 160	30438	2	16:1			45
A 12 M 816 R	D (LA)	12	142 x 160	30438	2	16:1			45
A 12 M 816 U	D (LA)	12	142 x 160	30438	2	16:1			45
A 12 M 816 W	D (LA)	12	142 x 160	30438	2	16:1			45
A 16 M 816	D (A)	16	142 x 160	40544	2	16:1	216-427	295-581	45

Kraftstoffart
B = Benzin | D = Diesel | G = Gas

Ladeart
A = Aufgeladen
AN = Sauger
K = Kompressor
LA = Aufgeladen mit Ladeluftkühlung



Positionsnummer

Produktdaten

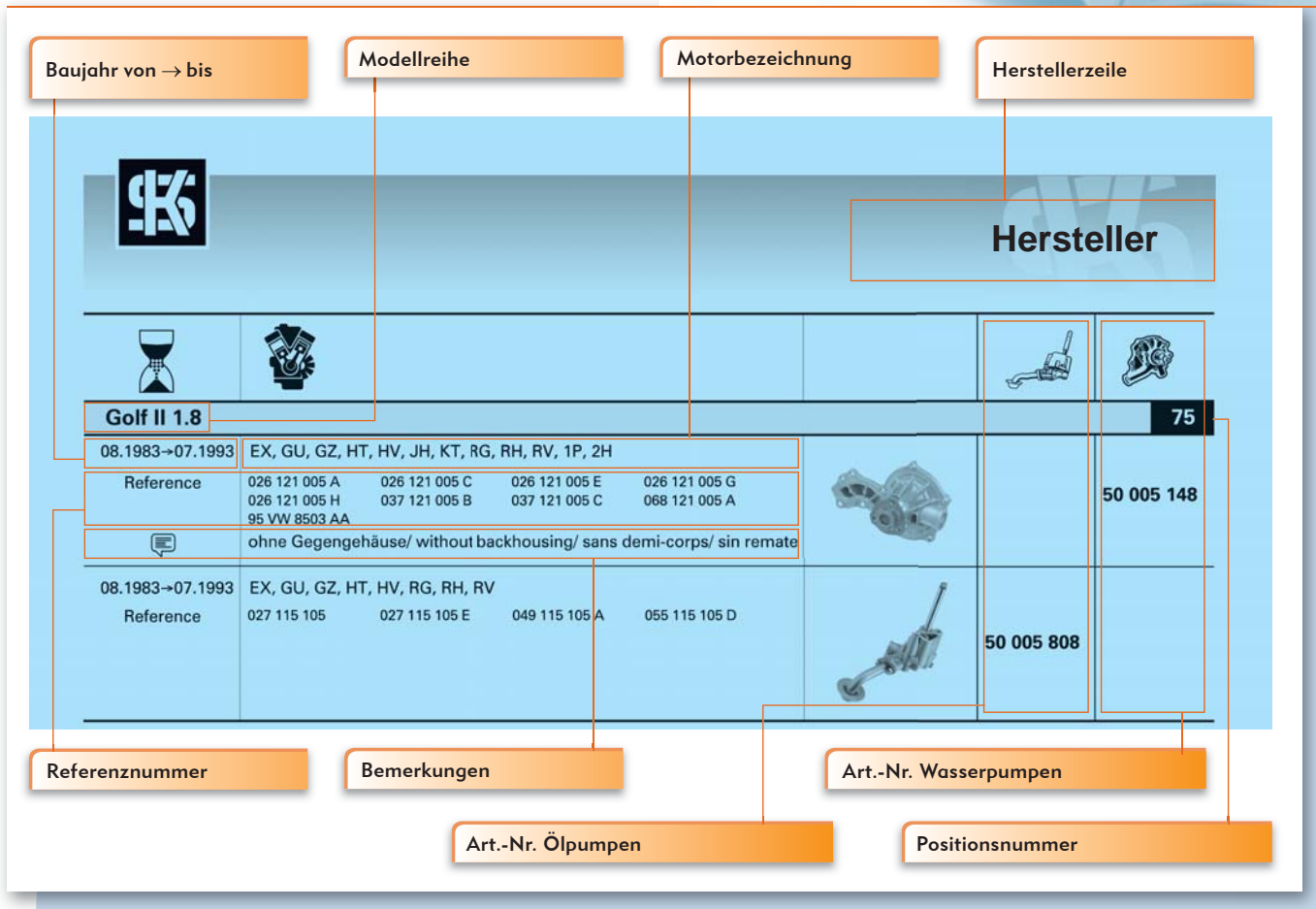
Die Katalogseiten bestehen aus den nachstehend aufgeführten Informationsblöcken:



The screenshot shows a catalog page for a Golf II 1.8. It features a table with columns for model years, model series, motor designations, and manufacturer parts. Callout boxes point to specific elements: 'Baujahr von → bis' (Year), 'Modellreihe' (Model series), 'Motorbezeichnung' (Motor designation), 'Herstellerzeile' (Manufacturer line), 'Referenznummer' (Reference number), 'Bemerkungen' (Remarks), 'Art.-Nr. Ölpumpen' (Oil pump part number), 'Art.-Nr. Wasserpumpen' (Water pump part number), and 'Positionsnummer' (Position number). The 'Herstellerzeile' is labeled 'Hersteller'.

Baujahr von → bis	Modellreihe	Motorbezeichnung	Herstellerzeile
08.1983→07.1993	EX, GU, GZ, HT, HV, JH, KT, RG, RH, RV, 1P, 2H		75
Reference	026 121 005 A 026 121 005 C 026 121 005 E 026 121 005 G 026 121 005 H 037 121 005 B 037 121 005 C 068 121 005 A 95 VW 8503 AA		50 005 148
	ohne Gegengehäuse/ without backhousing/ sans demi-corps/ sin remate		
08.1983→07.1993	EX, GU, GZ, HT, HV, RG, RH, RV		
Reference	027 115 105 027 115 105 E 049 115 105 A 055 115 105 D		50 005 808

2. Produktinformationen

2.1 Wasserpumpen

2.1.1 Kühlkreislauf

Das Kühlsystem stellt einen geschlossenen Kreislauf dar. Es hat die Aufgabe, das thermische Gleichgewicht im Motor sicherzustellen, denn erst bei optimalen Temperaturen bestehen für den Motor optimale Betriebsbedingungen: dann ist der Wirkungsgrad hoch und die Verbrennung vollständig, was auch wiederum die Umweltbelastung reduziert. Als Kühlflüssigkeit wird im Kühlkreislauf entsprechend der Herstellervorgabe eine Mischung aus reinem Wasser, Frost- und Korrosionsschutzmittel verwendet. Der Siedepunkt dieser Mischung liegt höher als der von Wasser und ermöglicht bei einem Überdruck von 1,4 bar Kühlmitteltemperaturen von bis zu 120°C.

Der Thermostat regelt den Kühlkreislauf in Abhängigkeit der Temperatur der Kühlflüssigkeit: bei kaltem Motor bleibt er geschlossen, so daß möglichst schnell die Betriebstemperatur erreicht wird (kleiner Kühlkreislauf); erst ab einer bestimmten Temperatur öffnet er und der große Kühlkreislauf über den Kühler wird zugeschaltet. Die über einen Riemen angetriebene Wasserpumpe fördert das Kühlmittel und gewährleistet nach dem Öffnen des Thermostats den gleichmäßigen und schnellen Transport des Kühlmittels vom Motor zum Kühler: Dort wird die erhitzte Kühlflüssigkeit abgekühlt – entweder durch den Fahrtwind, sofern dies ausreicht oder aber ein Kühlerlüfter saugt zusätzlich Luft an.

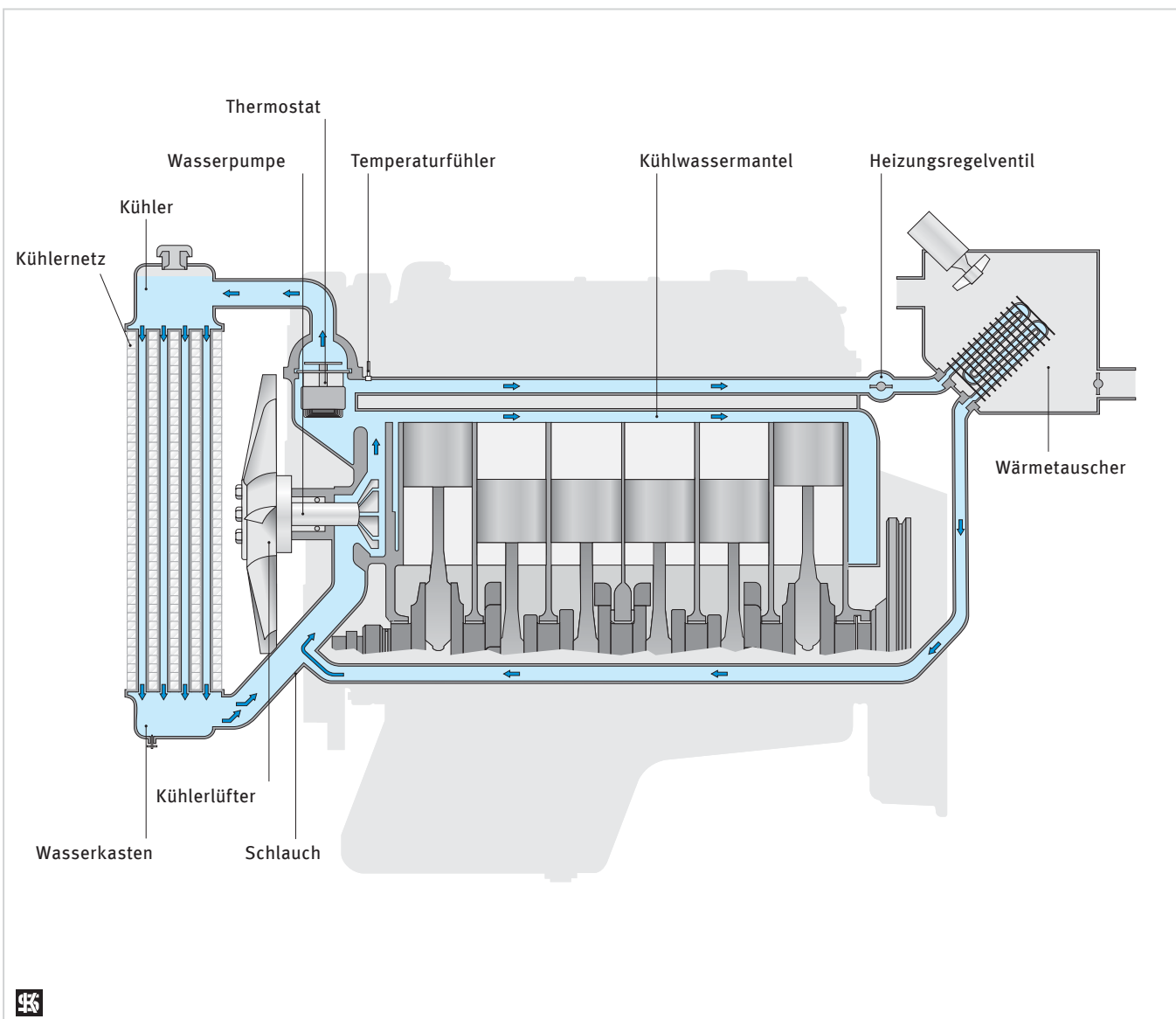

2.1.2 Bestandteile einer Wasserpumpe

Zentrales Element einer Kühlmittelpumpe für Kraftfahrzeugmotoren ist das Schaufelrad, auch Rotor oder Flügelrad genannt. Je nach Typ kann es unterschiedlich viele Schaufeln haben, die gerade oder gekrümmt und entweder radial oder aber tangential angeordnet sind. Die Ausführung und Abmessung des Flügelrades bestimmen maßgeblich die Leistungsfähigkeit der Wasserpumpe.

Weitere Bestandteile sind die Antriebswelle und Lagerung, die bei Wasserpumpen fast immer eine einbaufertige Einheit bilden. Auf der Förderseite nimmt die Lagerwelle das Schaufel-

rad auf und auf der Antriebsseite sind Flansch oder Riemenscheibe befestigt. Das Pumpengehäuse ist aus Aluminium- oder Eisenguß. An ihm werden je nach Pumpentyp die verschiedensten Anbauelemente wie z. B. Halterungen für Schläuche, Thermostate, Stopfen, etc. befestigt. Das Pumpengehäuse hat außerdem eine Leckage-Bohrung, die zur Kontrolle dient. Die Wellendichtung hat für Dichtheit zwischen Gehäuse und Lagerwelle zu sorgen: von Ihrer Funktionalität hängt die Lebensdauer einer Wasserpumpe im Wesentlichen ab.

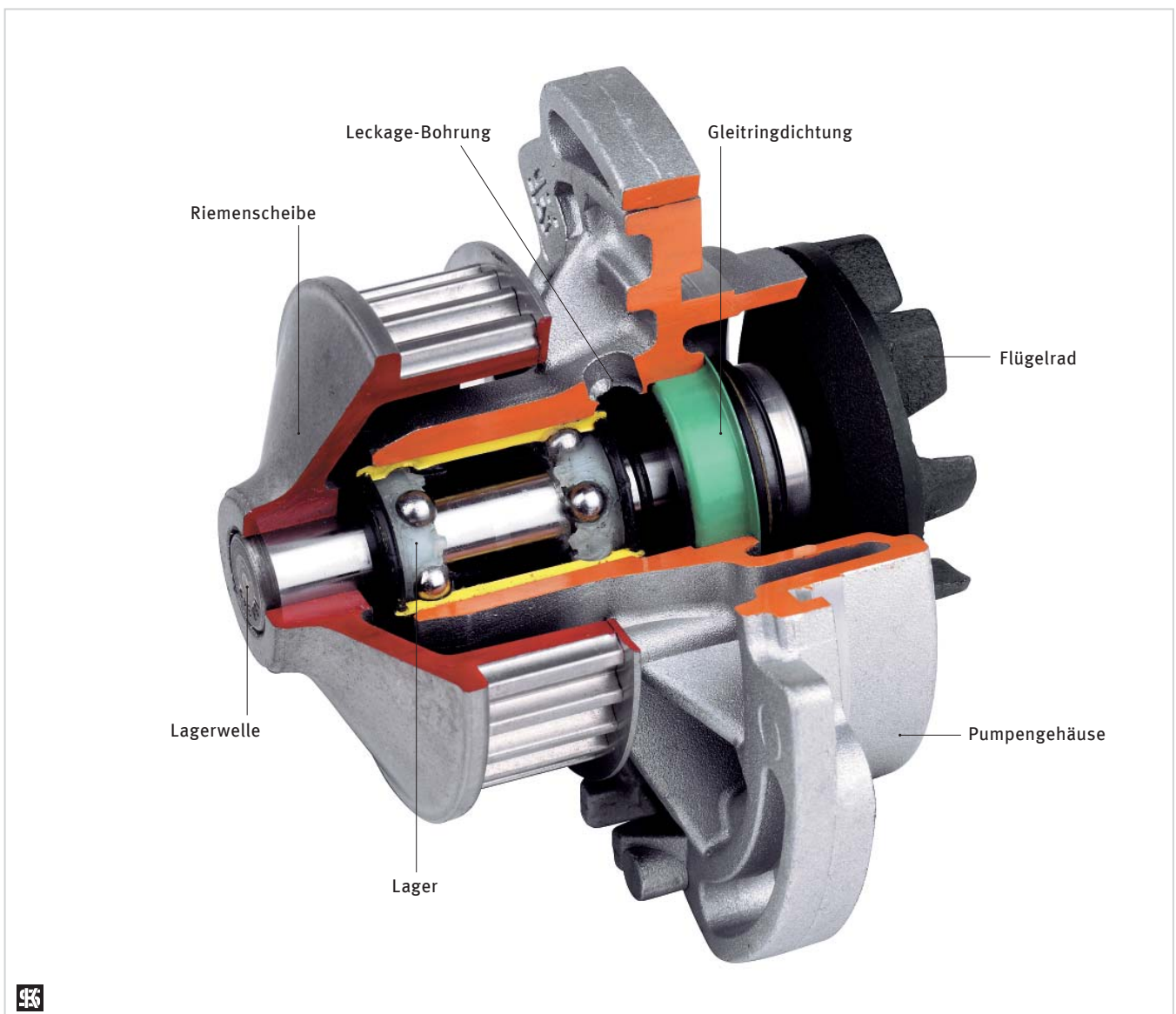

2.1.3 Bauarten

Wasserpumpen sind sehr unterschiedlich in der Bauart und somit auch im Aussehen. Die Antriebsart und die Gehäuseausführung sind die beiden auffälligsten Unterscheidungsmerkmale:

Antriebsart

Die Wasserpumpe wird über einen Riemen vom Motor angetrieben. Dies geschieht entweder über den Zahnriemen der Nockenwellensteuerung oder über den Keilriemen bzw.

Keilrippenriemen von der Kurbelwelle aus. Ist die Riemenscheibe nicht bereits Bestandteil der Pumpe, muß sie noch an den Flansch der Antriebswelle geschraubt werden.



Antrieb über Zahnriemen



Antrieb über Keilriemen



Pumpe ohne Riemenscheibe

Gehäuseausführung

Wasserpumpen können offen oder geschlossen sein. Bei offenen Pumpen befindet sich am Motor eine Anflansfläche, an der die Pumpe befestigt und mit

einem Dichtring oder einer Flachdichtung abgedichtet wird. Das Gegenstück des Pumpengehäuses ist Bestandteil des Motors. Geschlossene Pumpen hingegen stellen eine kom-

plette Baugruppe dar: Ein Gegenstück, eine Platte oder ein Deckel, verschließen das Pumpengehäuse und dichten es ab.



Pumpe mit Befestigungsflansch



Pumpe mit Gehäuse

2.1.4 Technische Übersicht

Verschiedene Störungen können im Zusammenhang mit dem Kühlsystem auftreten. Hier eine Auflistung der wesentlichen Probleme und ihrer Ursachen sowie der Maßnahmen, um die jeweilige Störung zu beheben.

Symptome	Mögliche Ursache	Maßnahme
Überhitzung	zu wenig Kühlmittel im Kühlkreislauf	Kühlmittel nachfüllen
	Kondensator der Klimaanlage verstopft	Kondensator reinigen ggf. ersetzen
	Kühlernetz verstopft	Kühler reinigen ggf. ersetzen
	Thermostat öffnet nicht	Thermostat prüfen ggf. ersetzen
	Umlauf des Kühlmittels behindert	Kühlsystem reinigen und durchspülen
	Fehlfunktion der Wasserpumpe	Wasserpumpe ersetzen
	Fehlfunktion der Lüfterkupplung	Lüfterkupplung ersetzen
	Fehlfunktion des Kühlerlüfters	Kühlerlüfter und Lüftermotor überprüfen
	Fehlfunktion des Lüfterrelais	Lüfterrelais überprüfen
	Antriebsriemen rutscht, bzw. ist gerissen	Antriebsriemen nachspannen, bzw. ersetzen
Korrosion	Verunreinigungen im Kühlmittel	Kühlsystem reinigen, durchspülen und neu befüllen
Kühlmittelverlust	Schlauch beschädigt	Schlauch austauschen
	Wasserpumpe undicht	Wasserpumpe erneuern
	Kühlernetz defekt	Kühler reparieren ggf. ersetzen
	Thermostat-Abdeckung defekt	Thermostat-Abdeckung ersetzen
	Defekt am Zylinderkopf	Zylinderkopf und Zylinderkopfdichtung überprüfen
	Stopfen im Kühlsystem undicht	Stopfen erneuern
Keine Beheizung des Innenraums	Heizschlauch defekt	Heizschlauch ersetzen
	Wärmetauscher verstopft	Wärmetauscher reinigen ggf. ersetzen
	Thermostat defekt	Thermostat erneuern



■ Einbau von Wasserpumpen

Damit Ihre neue KS-Wasserpumpe im passenden Fahrzeug korrekt eingebaut wird, befolgen Sie bitte bei der Montage die allgemeinen Hinweise, der Einbauanleitung, die in der Verpackung beiliegt.

2.1.5 Wichtiger Hinweis

Die richtige Wartung des Kühlsystems ist für die Funktionstüchtigkeit des Motors unabdingbar. Wird eine neue KS Wasserpumpe eingebaut, müssen auch die für den Kühlkreislauf wichtigen Bauteile wie Steuerriemen, Spannrollen, Thermostat, Schläuche und Klemmen überprüft

und gegebenenfalls ausgetauscht werden. In das Kühlsystem darf kein reines Wasser eingefüllt werden. Das vom Fahrzeughersteller vorgeschriebene Kühlmittel enthält Inhibitoren mit korrosionshemmender Wirkung und vermeidet Schäden an der Wasser-

pumpe und den anderen Teilen im Kühlkreislauf. Verschiedene Kühlmittel sind untereinander nicht mischbar. Qualitativ minderwertige Kühlmittel können Schäden verursachen und das ganze System lahm legen.

2.1.6 Schäden

Schadensbild	Mögliche Ursache	Abhilfe
Kondensat an der Leckagebohrung	Soll-Leckage	Einlaufzeit des Wellendichtringes beträgt 1-3 Stunden
Kühlmittelaustritt an der Leckagebohrung	Korrosion im Kühlsystem, Betrieb mit reinem Wasser (ohne Kühlmittelzusatz)	Kühlsystem reinigen, Kühlmittel einfüllen
Korrosion an der Lauffläche des Flügelrades	Wellendichtring chemisch geschädigt durch verschmutztes Kühlmittel	Kühlsystem reinigen, Kühlmittel einfüllen
Lochkorrosion/Kavitation an Flügelrad, Gehäuse oder Welle	Temperatur zu hoch, überaltertes/falsches Kühlmittel	Kühlmittel vorschriftsmäßig wechseln, Betriebstemperaturen des Kühlsystems prüfen (Kontrolle von Kühler, Thermostat, Lüfter)
Vom Antriebsrad gelöste Seitenführung (Anlaufscheiben)	Steuerriemenflucht nicht in Ordnung, Fehlmontage von Führungsrollen und Riemenspanner	Ausrichtung korrigieren, bzw. Steuerriemen ersetzen
Korrosion im gesamten Kühlsystem	Defekte Zylinderkopfdichtung, falsches/verbrauchtes Kühlmittel	Zylinderkopfdichtung erneuern, Kühlsystem reinigen
Wasseraustritt an Schlauchstutzen und Gehäusedichtung	Mitgelieferte Dichtung nicht eingesetzt, unfachmännische Handhabung von Dichtungsmasse	Dichtung immer einsetzen, Dichtungsmasse nach Vorschrift verwenden
Zahnprofil des Antriebrades eingelaufen, Gummiabrieb vom Steuerriemen	Spannung des Steuerriemens zu hoch	Steuerriemen erneuern und nach Herstellervorgabe einstellen
Ermüdungsbruch des Wasserpumpenlagers	Vibrationen und Unwucht durch schadhafte Lüfterkupplung oder Spannrollen, Spannung des Steuerriemens zu hoch	Wasserpumpe und defekte Bauteile erneuern

2.2 Ölpumpen

2.2.1 Motorschmierung

Das Motorschmiersystem hat die Aufgabe, die Motorenbauteile mit einer ausreichenden Menge an Schmieröl zu versorgen. Es stellt ein in sich geschlossenes System dar, indem das Öl eine Vielzahl von Aufgaben übernehmen muss.

- Schmierung aller gleitenden Teile
- Kühlung der Motorenteile - Schutz vor Überhitzung
- Abführen von Ablagerungen, Verbrennungsrückständen und Abrieb
- Korrosionsschutz
- Dämpfung von Geräuschen und Schwingungen
- Feinstabdichtung (z. B. Kolbenringe)
- Kraftübertragung

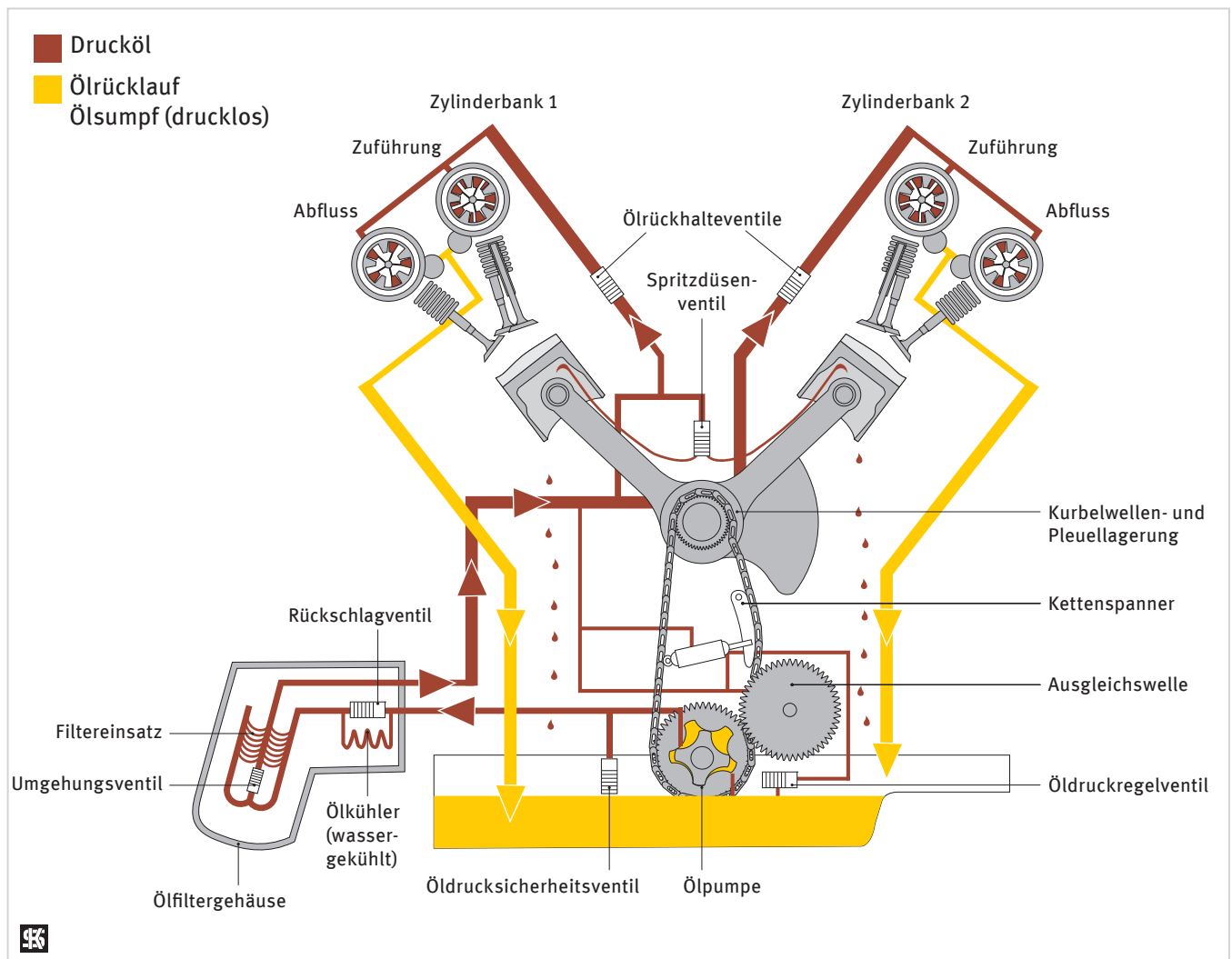

Ölkreislauf

2.2.2 Motorschmiersysteme

Im Bereich der Motorölschmierung unterscheidet man folgende Schmiersysteme:

- Druckumlaufschmierung
- Trockensumpfschmierung

■ Druckumlaufschmierung

Bei dieser Art von Schmierung, die bei fast allen Viertaktmotoren Anwendung findet, wird das Öl mit Hilfe einer Pumpe über Leitungen oder Kanäle an eine Vielzahl von Schmierstellen befördert.

Neben den verschiedenen Wellenlagerstellen werden unter anderem noch hydraulische Ventilausgleichselemente (Hydrostößel), Kipphebel, Steuerketten, Steuerkettenspanner aber auch die Kolben mit ausreichend Öl versorgt.

Zur Reinigung des Öls sind zwischen Ölpumpe und Schmierstellen verschiedene Arten von Grob-, Fein und Feinstfiltern eingesetzt. Zur Kühlung des Öls werden häufig luft- oder wasserdurchströmte Ölkühler eingesetzt.

Zu hoher Öldruck, der vorwiegend während der Kaltstartphase aber auch bei höheren Drehzahlen auftreten kann, wird über ein entsprechendes Druckbegrenzungsventil verhindert. Dieses ist auf der Druckseite nahe der Pumpe oder direkt in das Pumpengehäuse eingebaut und lässt überhöhten Druck in die Ölwanne entweichen

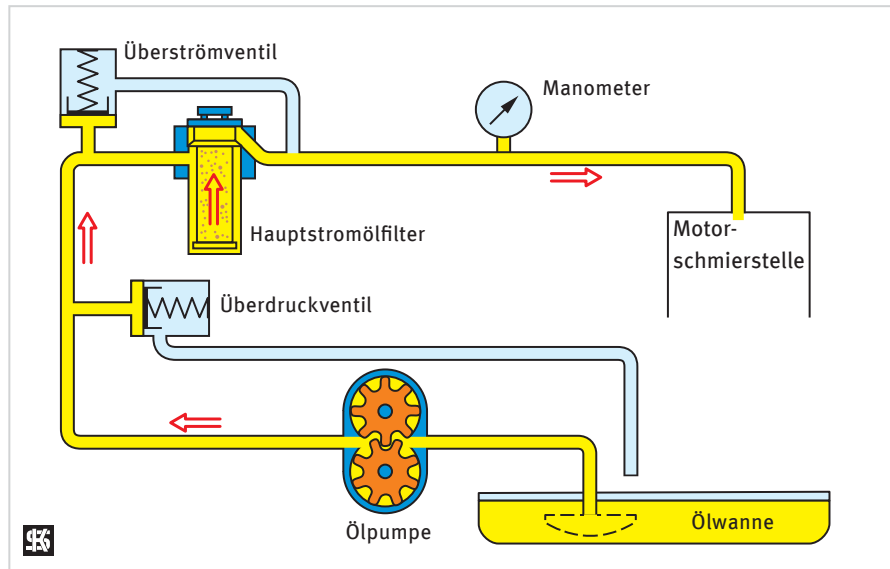

Druckumlaufschmierung

■ Trockensumpfschmierung

Die Trockensumpfschmierung stellt eine besondere Art der Druckumlaufschmierung dar. Bei diesem System wird das aus dem Motor zurücklaufende Öl, durch eine spezielle Absaugpumpe von der Ölwanne in

einen separaten Ölvorratsbehälter gepumpt. Von hier aus wird das Motorenöl mittels Druckförderpumpe an die entsprechenden Schmierstellen weitergeleitet. Der Vorteil dieser Konstruktion ist, dass trotz extremer

Schräglage oder auftretender Zentrifugalkräfte immer eine ausreichende Ölversorgung gewährleistet ist. Aus diesem Grund findet diese Technik häufig im Geländewagenbau oder im Rennsport Anwendung.

2.2.3 Bauarten und Pumpenausführung

Ölpumpen sind in ihrer Bauart und in ihrem Aussehen recht unterschiedlich.

Das Pumpenprinzip, die Antriebsart sowie die Gehäuseausführung sind die auffälligsten Unterscheidungsmerkmale.

Je nach Anwendungszweck, Einbauort und Förderleistung werden Ölpumpen verwendet, die nach unterschiedlichen Pumpenprinzipien arbeiten.

Die am häufigsten verwendeten Pumpenkonstruktionen sind:

- Zahnradpumpen
- Sichelpumpen
- Rotorpumpen

■ Zahnradpumpen

Bei der Zahnradpumpe wird das Öl durch die Drehbewegung zweier Zahnräder zwischen den Zähnen und der Wand transportiert. Durch das Ineinandergreifen des Zahnradpaares wird verhindert, dass das Öl in die Wanne zurückfließen kann. So entsteht auf der einen Seite ein Überdruck, während auf der Saugseite ein Unterdruck entsteht.

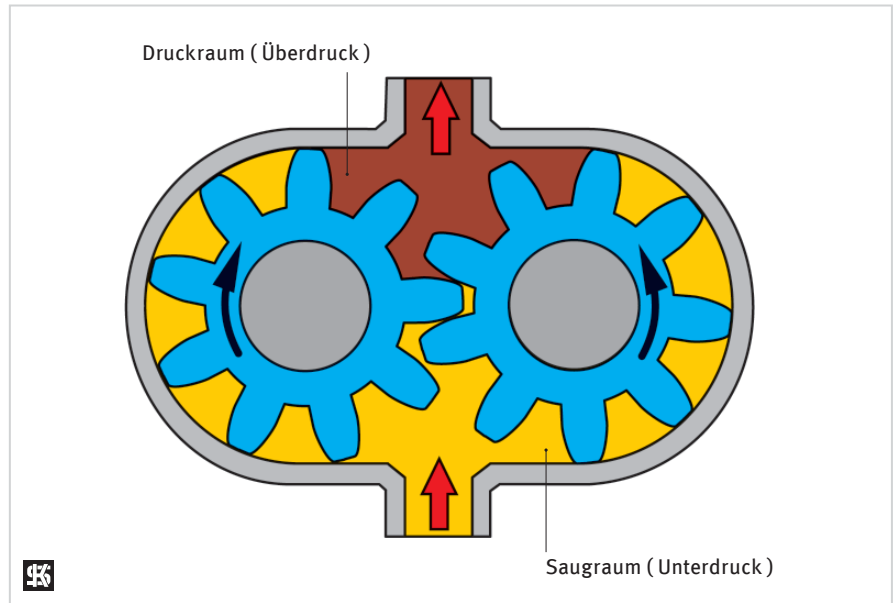

■ Sichelpumpe

Bei der Sichelpumpe ist zum Innenrad ein im Pumpengehäuse gelagertes Außenzahnrad exzentrisch angeordnet. Wie auch bei der normalen Zahnradpumpe wird das Öl in den Zahnzwischenräumen transportiert. Durch das fortlaufende Drehen der Pumpe entsteht -auf der Seite auf der die Zähne auseinander laufen- ein Unterdruckbereich. Dies ist die Saugseite der Pumpe. In dem Bereich wo die Zähne wieder ineinander greifen entsteht ein Überdruck. Hier wird das Drucköl abgeführt.

Der Vorteil der Sichelpumpe gegenüber der normalen Zahnradpumpe liegt in einer erhöhten Förderleistung, speziell bei niedrigen Drehzahlen. Saug

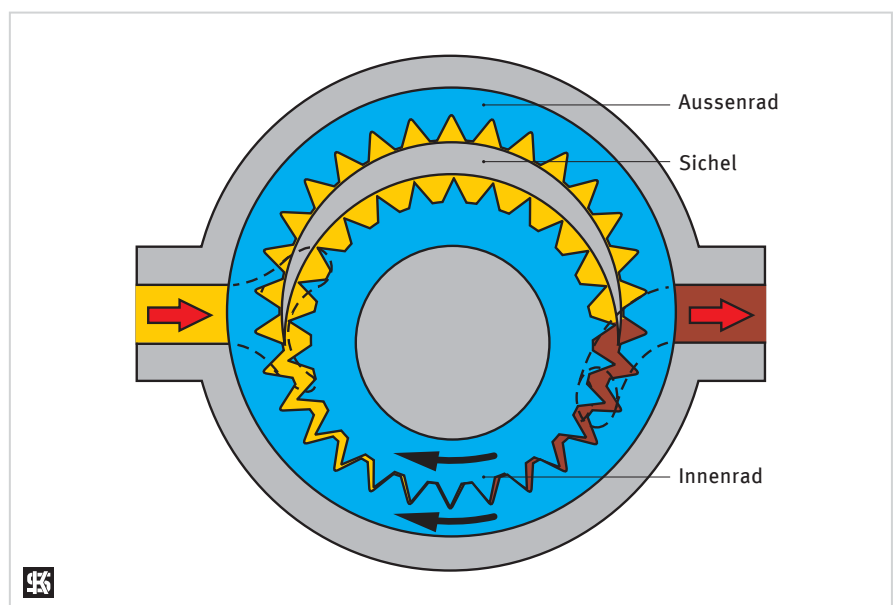

■ Rotorpumpe

Die Rotorpumpe besteht aus einem innenverzahnten Außenrotor und einem außenverzahnten Innenrotor. Der Außenrotor wälzt sich über die Zähne des Innenrotors ab und dreht sich auf diese Weise im Pumpengehäuse. Der Innenrotor besitzt einen Zahn weniger als der Außenrotor, so dass bei einer Umdrehung Flüssigkeit von der jeweils einen in die nächste Zahnücke des Außenrotors transportiert wird.

Bei der Drehbewegung vergrößern sich die Räume auf der Saugseite, während sie sich auf der Druckseite entsprechend verkleinern.

Mit dieser Bauart kann man bei hohem Förderstrom hohe Drücke erzeugen.

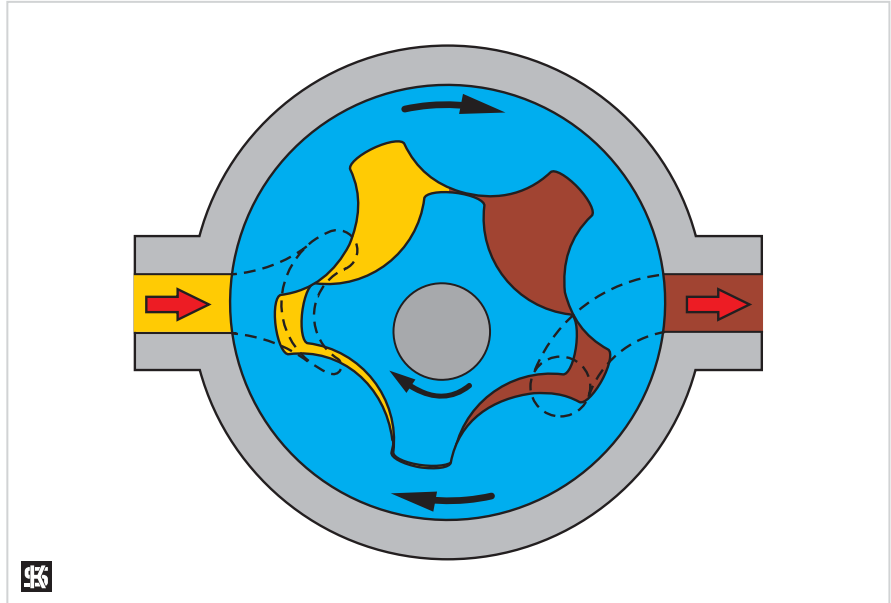

2.2.4 Ölpumpen-Antriebsarten

Ölpumpen werden in der Regel direkt vom Motor angetrieben. Der Antrieb erfolgt entweder direkt über Verzahnungen oder Steckverbindungen auf der Kurbelwelle oder über Zahnräder, Antriebskette oder Zahnriemen.



Pumpe mit Steckantrieb



Pumpe mit Zahnradantrieb

2.2.5 Allgemeine Einbauhinweise

Um die korrekte Funktion und Lebensdauer der Pumpe zu gewährleisten, müssen beim Einbau der neuen Pumpe in jedem Fall die Montagevorschriften des Motorenherstellers beachtet werden.

Es sollten jedoch immer die folgenden, allgemeinen Einbauhinweise beachtet werden:

- Altöl ablassen und eventuell auf vorhandene Verunreinigungen prüfen. Vor allem metallische Verunreinigungen lassen oftmals auf mechanischen Verschleiß einzelner Motorkomponenten schließen.
- Beim Einbau der Pumpe muss unbedingt auf Sauberkeit geachtet werden. Das Ölsaugrohr ist in der Regel nur mit einem Grobsieb versehen. Im Motor verbliebene Schmutz- oder Metallpartikel könnten nach der Reparatur ungehindert in das Innere der neuen Pumpe gelangen und dort innerhalb kurzer Zeit erneut zu Verschleiß führen. Alle mit dem Öl in Verbindung stehenden Bauteile, Kanäle sowie das Ölsaugrohr sollten daher möglichst einer Reinigung unterzogen werden.
- Beim Einbau einer neuen Ölpumpe muss stets auch der Ölfilter gewechselt werden. Ist das Öldrucksystem stark verschmutzt, muss dieses zusätzlich einer Reinigung unterzogen werden.
- Vor dem Einbau der neuen Pumpe muss diese mit der Geometrie der alten Pumpe verglichen werden.
- Der Pumpenantrieb (Verzahnung, Keilverbindungen, Kettenräder und Antriebsketten/-riemen) muss auf mögliche Schäden hin überprüft werden.
- Bevor die Pumpe montiert wird, müssen alle beweglichen Teile der Pumpe (Zahnräder, Wellen) mit dem vorgeschriebenen Motorenöl eingeeilt werden.
- Bei der Montage ist auf richtigen Sitz der Pumpe zu achten. Die Pumpe darf bei Montageproblemen (Anlageprobleme, Schiefstand) nicht mittels Schraubkraft zur Anlage am Gehäuse gebracht werden. Beschädigungen der Pumpe, Funktionsstörungen und Undichtheiten können die Folge sein.
- Beim Einbau der Ölpumpe und des Ölsaugrohrs sind stets neue Dichtungen und Dichtringe zu verwenden. Eine generelle Verwendung von flüssigen Dichtmittel ist zu vermeiden. Diese dürfen nur dort verwendet und eingesetzt werden, wo dies vom Motorenhersteller vorgesehen ist.
- Die Befestigungsschrauben der Pumpe müssen beim Einbau mit dem vom Motorenhersteller vorgeschriebenen Anzugsdrehmoment und der entsprechenden Anzugsreihenfolge angezogen werden.
- Sind flüssige oder mechanische Schraubensicherungen vorgesehen, müssen diese nach Vorschrift des Motorenherstellers verwendet werden.
- Bevor der Motor wieder in Betrieb genommen wird, empfehlen wir das Befüllen des Ölsystems mit einem separaten Druckbehälter (Aufdrückverfahren). Die Druckseite des Ölsystems wird dabei vollständig mit Öl befüllt und entlüftet. Man befüllt das System in der Regel solange bis das Öl an den höchsten bzw. am weitesten von der Ölpumpe entfernten Schmierstellen im Motor angekommen ist. Das Öl sollte dabei an den Kipphebeln oder aus den Lagerstellen der Nockenwelle austreten. Schäden die beim Anlassen des Motors durch mangelnden Öldruck entstehen könnten, werden somit vermieden.
- Nach dem „Aufdrücken“ des Ölsystems wird der Motor bis zum vorgeschriebenen Ölpegel befüllt.
- Beim ersten Anlassen des Motors nach dem Pumpenwechsel, sollte der Motor innerhalb weniger Sekunden Öldruck aufbauen. Wird kein Öldruck erzeugt, muss der Startvorgang unterbrochen bzw. der Motor abgestellt und die Ursache behoben werden. Das Hochdrehen des Motors, um den Aufbau des Öldrucks zu beschleunigen, muss in jedem Fall unterbleiben.
- Verwenden Sie nur vom Motorenhersteller vorgeschriebene und freigegebene Öle.
- Warten Sie den Motor nach den Vorgaben des Herstellers.

2.2.6 Ursachenermittlung / Schadendiagnose

Das Schmiersystem und auch die Motormechanik bestehen aus einer Vielzahl von festen und beweglichen Teilen. Jedes Bauteil ist sowohl spezifisch für sich, als auch am Zusammenspiel mit anderen Komponenten beteiligt. Öldruck- und Ölversorgungsprobleme können daher vielfältige Ursachen haben. Beim Ausfall eines Bauteils wird häufig das ganze Schmiersystem in Mitleiden-

schaft gezogen. Wird das Problem nicht rechtzeitig erkannt oder gar ignoriert, leiden alle in Verbindung stehenden Bauteile darunter. Häufig kommt es trotz kleiner Ursache zum Totalschaden des Motors. Bevor der Austausch der Ölpumpe in Erwägung gezogen wird, sollten die folgenden Punkte überprüft und mögliche Schäden beseitigt werden.

■ Ursachen von zu geringem oder fehlendem Öldruck

- Ölstand zu niedrig
- Viskosität des Öls zu niedrig (zu dünn)
- Ölschaumbildung im Kurbelgehäuse durch zu hohen Ölstand oder durch ungeeignetes Öl mit falscher Additivierung, bzw. durch verunreinigtes Öl
- Verstopftes Ölsaugsieb
- Undichtes Ölsaugrohr (es wird nur Luft angesaugt)
- Hängendes (offen stehendes) Öldruckregelventil
- Verstopfter Ölfilter
- Verstopfte Ölkanäle, Schlauchleitungen und Ölkühler
- Offenstehende oder abgebrochene Ölspritzdüsen (Kolbenspritzkühlung)
- Fehlende oder heraus gefallene Verschlussstopfen in druckführenden Kanälen von Motorblock, Zylinderkopf und Kurbelwelle.
- Verschlissene Gleitlager von Kurbelwelle, Nockenwellen, Ausgleichswellen und Kipphebelwellen.
- Verschlissene oder defekte Komponenten wie Hydrostößel, Turbolader Einspritzpumpen oder Kraftstoffhochdruckpumpen.
- Undichte Dichtflächen im Motor.

■ Ursachen bei zu hohem Öldruck

(in der Regel handelt es sich nicht um einen Defekt an der Ölpumpe)

- Viskosität des Öls zu hoch (zu dickflüssig).
- Öldruckregelventil arbeitet nicht (bleibt geschlossen).
- Ölfilter verstopft.
- Öldruckleitungen verstopft.
- Es wurde versehentlich eine Pumpe mit zu hoher Förderleistung eingebaut.

EN

BASICS



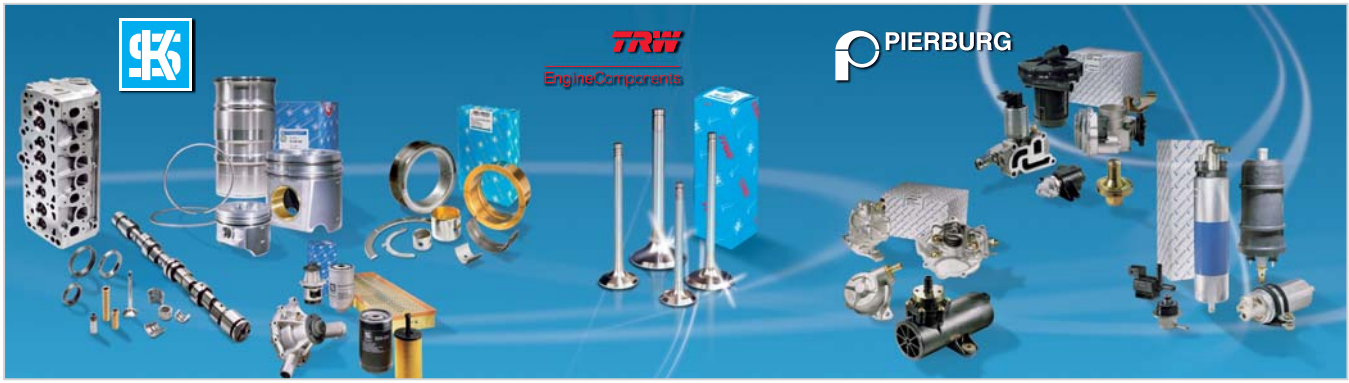

MS Motor Service International GmbH is the sales organisation for the worldwide aftermarket activities of Kolbenschmidt Pierburg AG. We are a leading supplier of engine components for the independent aftermarket, featuring the premium brands KOLBENSCHMIDT, PIERBURG and TRW Engine Components.

The product range is both broad and deep, enabling customers to procure all engine components from one source. As a problem solver in the marketplace and in the workshop, MS offers extensive services and the technical expertise that you would expect from the subsidiary of one of the largest automotive suppliers.

Kolbenschmidt Pierburg Group
As a long-standing partner of the automotive manufacturers, the companies in the Kolbenschmidt Pierburg Group develop innovative components and system solutions with renowned competence in the fields of air supply and emission control, for oil, water and vacuum pumps, for pistons, engine blocks and engine bearings.

Important Instructions

MS Motor Service International GmbH is here in after abbreviated to MSI.

Although the information provided in this catalogue has been carefully compiled, we cannot guarantee its accuracy and do not accept any liability for errors. Particularly we do not undertake any warranty for changes in the equipment by the manufacturers of vehicles or engines nor for changes in the designation of the parts. In case of doubt you are requested to contact our Technical Customer Service. Any references to errors in the catalogue which you may advise are welcome and will lead to corrections in future issues of the catalogue. Names, descriptions, numbers of vehicles or manufacturers etc. are only stated for reference. All products in the catalogue are spare

parts of KS quality. All figures, schematic drawings and other data serve for explanatory and for illustration purposes only; hence they must not be used as a basis for installation work, scope of supply and design. This applies especially to information provided by manufacturers. Information and data relating to original spare parts numbers of vehicle and engine manufactures only serve for comparison and reference. They are not original designations and must not be used when dealing with third parties. We cannot undertake any liability for the use of these reference lists to changes and/or dimensional variances by the individual manufactures. To the extent that the catalogue includes articles not produced by MSI, the product characteristics and data originate from the respective

manufacturer. Liability for the correctness of the data and suitability of the product for the intended purpose of application is expressly excluded. In order to safeguard suitability, it is in each specific case essential to obtain expert advice from the manufacturer or its authorized repair shop. The parts listed in the catalogue are not intended for use in aircraft. When using marine engines, please note that the same engine designations (e.g. pistons) can be used for different engine parts. This information may not be reproduced in any form, not even as an excerpt, without our prior written consent and must include the proper references. The publication of this catalogue renders all former issues obsolete.

Subject to change without notice.

Useful technical information can be found in

Service
Tips & Information

These brochures can also be viewed on our homepage www.ms-motor-service.com



ENGLISH

Index	Page
Important Instructions	18
Quality Management	19
1. Instruction for Using the Catalogue	20
2. Product Information	22
2.1 Water pumps	22
2.1.1 Cooling Circuit	22
2.1.2 Components of a Water Pump	23
2.1.3 Types of Construction	24
2.1.4 Technical Survey	25
2.1.5 Important Note	26
2.1.6 Damage	26
2.2 Oil pumps	27
2.2.1 Engine lubrication	27
2.2.2 Engine lubrication systems	28
2.2.3 Types of construction and pump designs	29
2.2.4 Types of oil pump drives	30
2.2.5 General installation instructions	31
2.2.6 Troubleshooting / damage diagnosis	32
3. Main Applications / Product Pictures	81
4. Additions to the range	163
5. Index of manufacturers	167
6. Product range	171
7. Cross reference chart	1271
8. Form “Quality Information Report”	
9. General Conditions of Sale and Delivery	

Quality Management

A distinguishing feature of our products is their high level of precision, achieved by the application of the most modern manufacturing methods. Our Quality Assurance – in line with DIN EN ISO 9001 and ISO/TS 16949 – is carried out continuously; both during the manufacturing process and at the final inspection. If, however, a material or manufacturing defect should occur, in spite of the continuous inspection carried out during the production process and the thorough final inspection, we will either undertake the repair work of the engine or will replace the defective product. Complaints of this nature must be communicated to us





in writing within a period of 30 days after the occurrence of the damage. The expiration date for guarantee claims is 24 months from the date that the article is delivered. Warrantee claims shall be forfeited if the item supplied is modified by an outside agent or by the installation of parts manufactured by an outside source, unless the defect has no causal relationship with the modification. The guarantee also ceases if the applicable handling and assembly specifications are not complied with. The guarantee excludes normal wear and damage caused by improper handling.



1. Instructions for Using the Catalogue

Engine Index

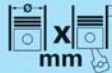
Every manufacturer information starts with two comprehensive indices serving as search-support tools: The engine designations are sorted in ascending order and alphanumerically.

		INDEX								
		Cyl.	 mm	cm ³		Comp. Ratio ϵ	kW	PS	Pos	
A 6 M 816	D (AN)	6	142 x 160	15204	2	16:1	145-172	197-234	45	
A 6 M 816 R	D (LA)	6	142 x 160	15204	2	16:1			45	
A 6 M 816 U	D (LA)	6	142 x 160	15204	2	16:1			45	
A 6 M 816 W	D (LA)	6	142 x 160	15204	2	16:1			45	
A 8 M 816	D (A)	8	142 x 160	20272	2	16:1	190-230	259-313	45	
A 8 M 816 C	D (LA)	8	142 x 160	20272	2	16:1			45	
A 8 M 816 CR	D (LA)	8	142 x 160	20272	2	16:1			45	
A 8 M 816 R	D (LA)	8	142 x 160	20272	2	16:1			45	
A 8 M 816 U	D (LA)	8	142 x 160	20272	2	16:1			45	
A 8 M 816 W	D (LA)	8	142 x 160	20272	2	16:1			45	
A 12 M 816	D (A)	12	142 x 160	30438	2	16:1	162-321	220-436	45	
A 12 M 816 C	D (LA)	12	142 x 160	30438	2	16:1			45	
A 12 M 816 CR	D (LA)	12	142 x 160	30438	2	16:1			45	
A 12 M 816 R	D (LA)	12	142 x 160	30438	2	16:1			45	
A 12 M 816 U	D (LA)	12	142 x 160	30438	2	16:1			45	
A 12 M 816 W	D (LA)	12	142 x 160	30438	2	16:1			45	
A 16 M 816	D (A)	16	142 x 160	40544	2	16:1	216-427	295-581	45	

Type of Fuel
B = gasoline | D = diesel | G = gas

Type of charging
A = super charged
AN = normally aspirated engine
K = compressor
LA = charge-air cooling

Item number

Product data

The catalogue pages consist of the information blocks listed below:

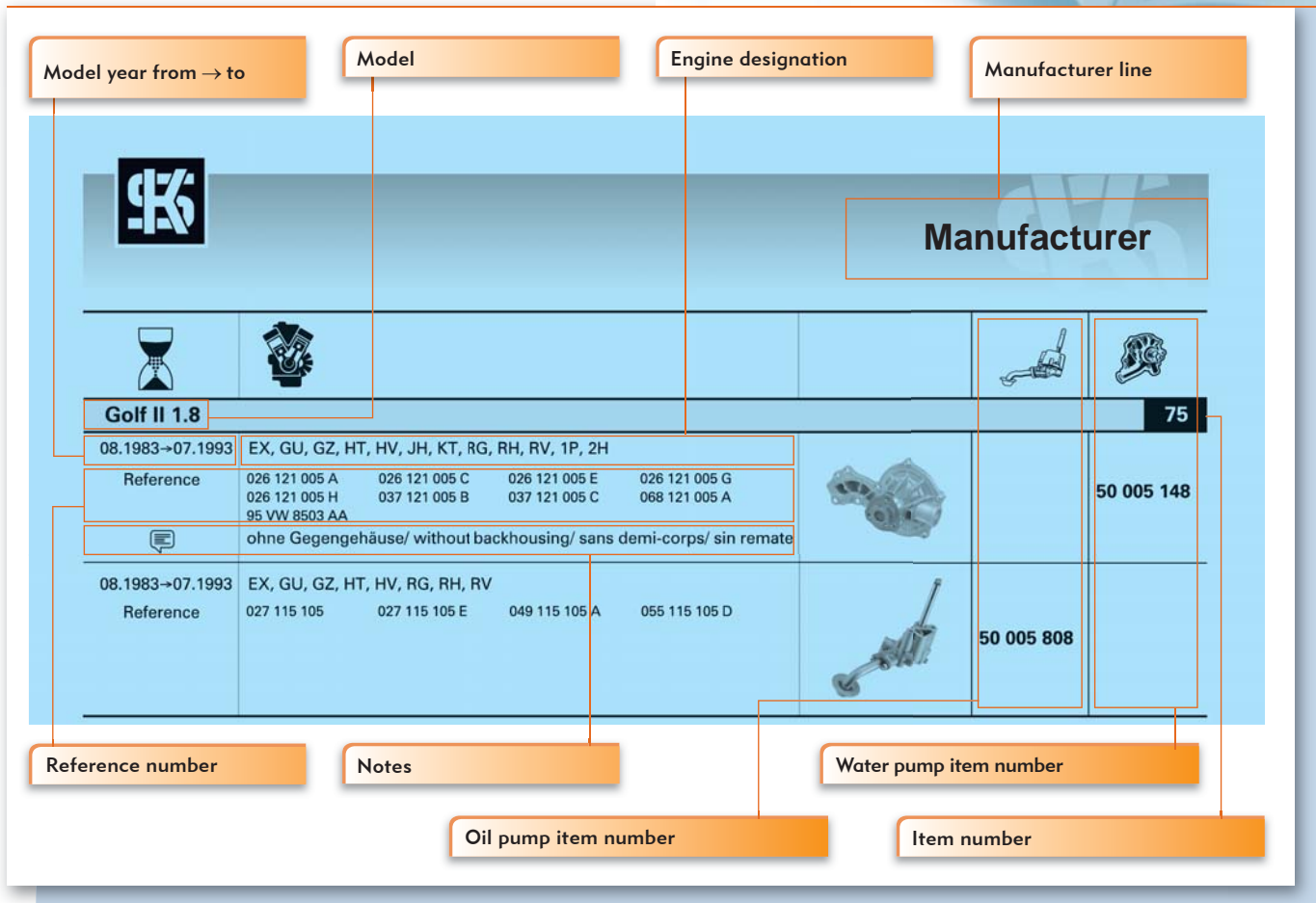

The diagram illustrates the layout of a product data table with callouts for various fields. The table is organized into several sections:

- Header Section:** Includes 'Model year from → to', 'Model', 'Engine designation', and 'Manufacturer line' callouts.
- Manufacturer Section:** Features the manufacturer logo and the name 'Manufacturer'.
- Product Identification Section:** Contains 'Golf II 1.8' and '75'.
- Reference and Notes Section:** Lists model years (08.1983→07.1993), model codes (EX, GU, GZ, HT, HV, JH, KT, RG, RH, RV, 1P, 2H), and reference numbers (026 121 005 A-G, 026 121 005 H, 037 121 005 B, 037 121 005 C, 068 121 005 A, 95 VW 8503 AA). A note specifies 'ohne Gegengehäuse/ without backhousing/ sans demi-corps/ sin remate'.
- Item Numbers Section:** Lists model years (08.1983→07.1993), model codes (EX, GU, GZ, HT, HV, RG, RH, RV), and reference numbers (027 115 105, 027 115 105 E, 049 115 105 A, 055 115 105 D). It also includes 'Water pump item number' (50 005 148) and 'Oil pump item number' (50 005 808).
- Bottom Callouts:** 'Reference number', 'Notes', 'Water pump item number', 'Oil pump item number', and 'Item number'.

ENGLISH

2. Product Information

2.1 Water pumps

2.1.1 Cooling Circuit

The cooling system constitutes a closed circuit. Its function is to safeguard the thermal balance in the engine because it is only at optimum temperatures that the engine finds optimum operating conditions: this will result in a high efficiency and complete combustion which in turn minimizes the impact on the environment.

In accordance with the manufacturer specification, a mixture of pure water, antifreeze and corrosion protecting agents will be used as coolant in the system. The boiling point of this mixture is above that of water and allows coolant temperatures of up to 120°C at a gauge pressure of 1.4 bar.

The thermostat will control the cooling circuit as a function of the coolant temperature: when the engine is still cold, it remains closed so that the operating temperature is reached as quickly as possible (small cooling circuit); only above a defined temperature level will it open to activate the large cooling circuit via the radiator. The water pump, which is driven through a belt, will deliver the coolant and, after thermostat opening, ensure the uniform and quick transfer of the coolant from the engine to the radiator: there the warm coolant is cooled again – either by the slip stream, if this is sufficient, or by a radiator fan which takes in additional air.

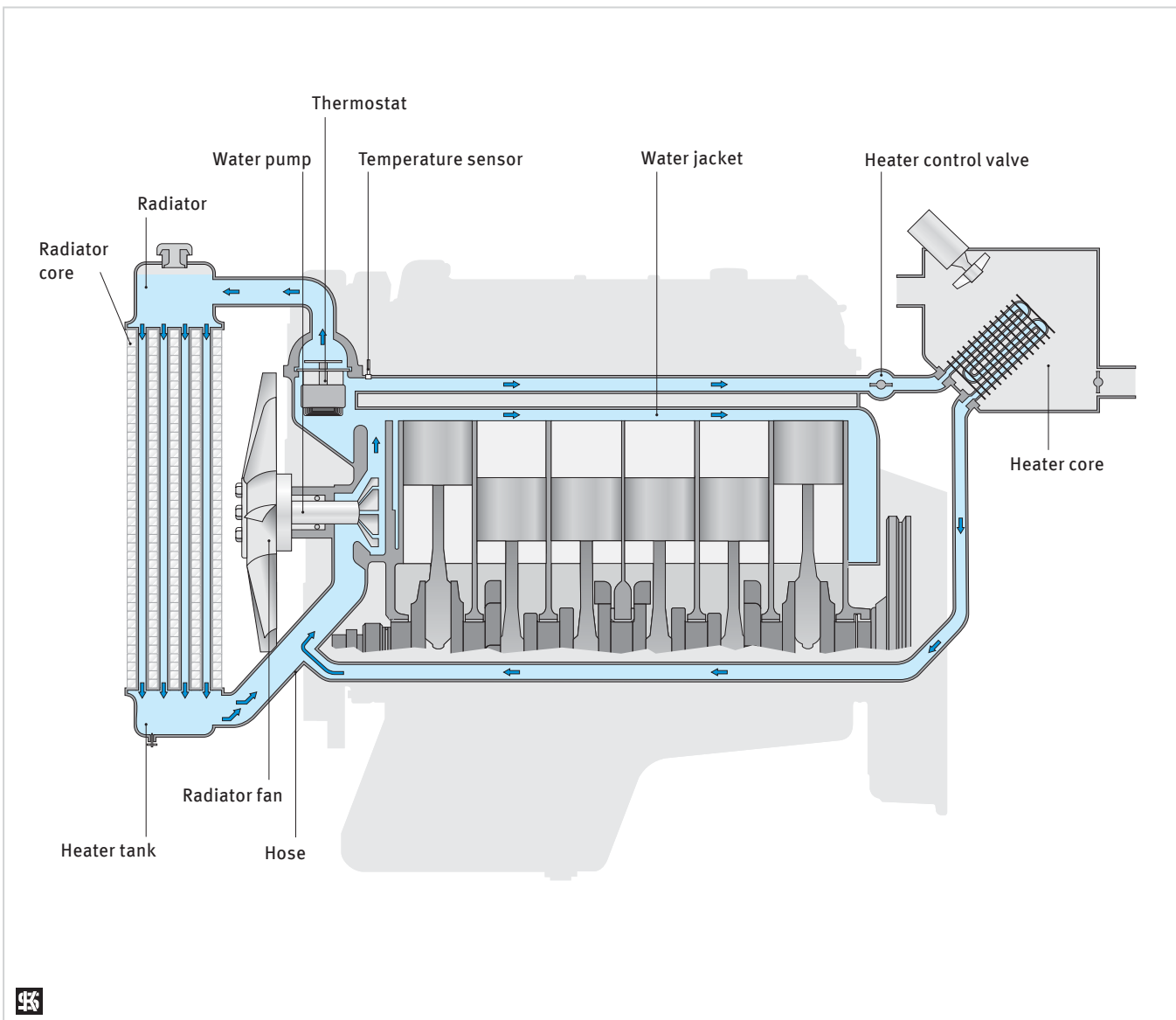

2.1.2 Components of a Water Pump

The central element of a coolant pump for motor vehicle engines is the impeller, also called rotor. Depending on the type, it may have differing numbers of blades which may be straight or curved and arranged either radially or tangentially. The design and dimensions of the impeller will decisively influence the efficiency of the water pump. Further components are the driving shaft and bearing which in the case of water pumps almost always constitute one preassembled unit ready for installation. On the delivery side, the bearing shaft accommodates

the impeller and on the driving side, the flange or pulley is arranged. The pump housing is made of cast aluminium or iron. Depending on the pump type, the most diverse elements are attached to it such as holders for hoses, thermostats, plugs etc. The pump housing is also furnished with a leak bore which serves for checking. The shaft seal has the function to keep the transition between housing and bearing shaft tight: its functionality essentially warrants the service life of the water pump.

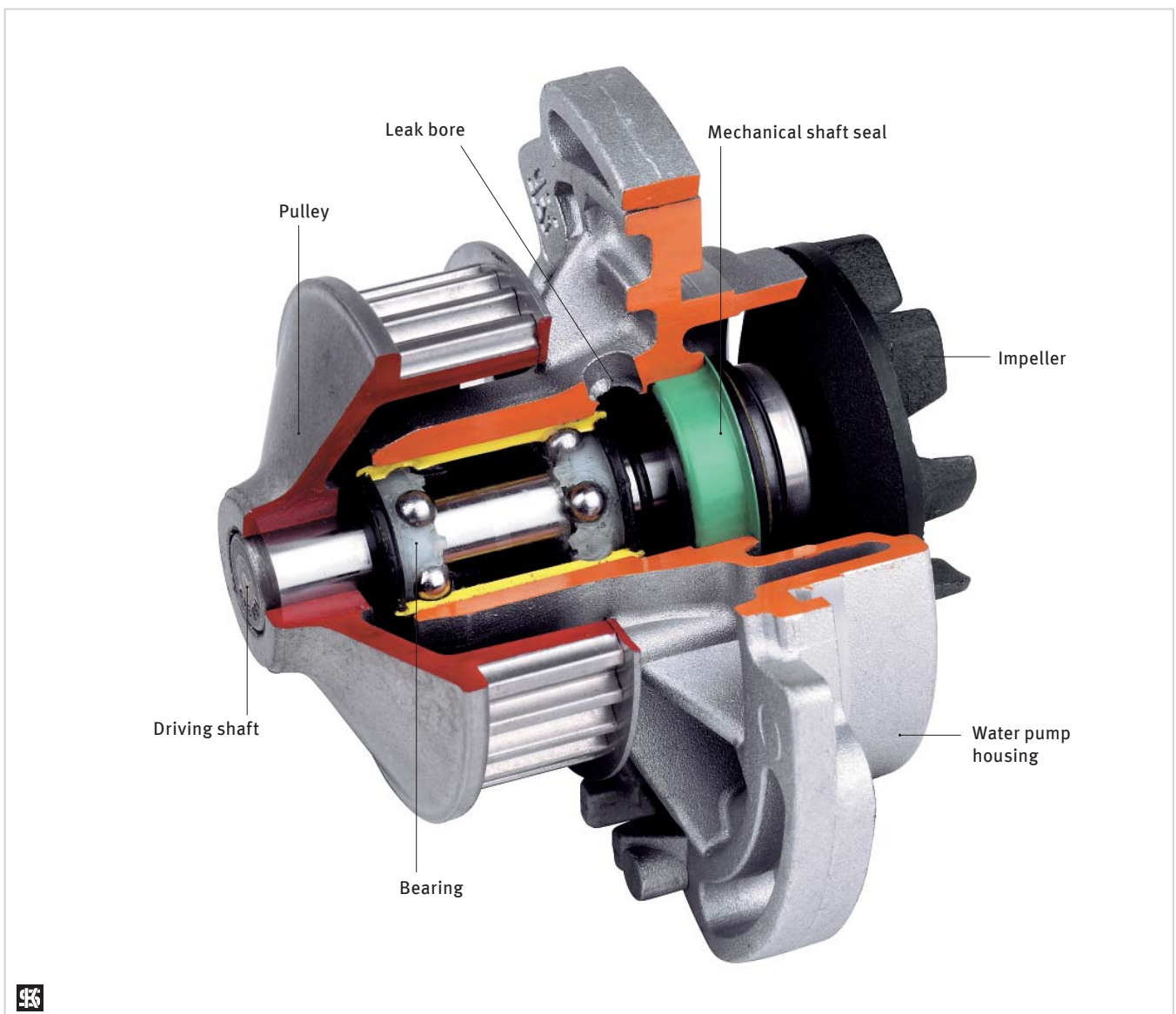

2.1.3 Types of Construction

The design of water pumps may vary widely and hence also their appearance. The construction of the housing and the type of drive are the most conspicuous differentiating features:

■ Type of Drive

The water pump is driven by the engine through a belt. This is either achieved through the timing belt of the camshaft control or through the

V-belt and/or poly-rib belt from the crankshaft. If the pulley is not part of the pump, it has to be bolted to the flange of the driving shaft.



Timing belt drive



V-belt drive



Pump without pulley

■ Housing Design

Water pumps may be of open or closed design. In the case of open pumps, the engine possesses a flange-mounting

face to which the pump is fastened and sealed by means of a sealing ring or a flat gasket. The mating piece of the pump housing is part of the

engine. Closed pumps in contrast constitute a complete assembly: a counterpart, a plate or a cover will close the pump housing and seal it.



Pump with mounting flange



Pump with housing

ENGLISH

2.1.4 Technical Survey

In connection with the cooling system, various disturbances may occur.

Below please find a list of the most frequent problems, their causes as

well as the actions to be taken in order to eliminate such disturbances.

Symptom	Possible Cause	Remedies
Overheating	Insufficient coolant in the cooling circuit	Refill coolant
	Air-conditioner condenser clogged	Clean condenser and replace, if necessary
	Finned-tube core blocked	Clean radiator and replace, if necessary
	Thermostat does not open	Check thermostat and replace, if necessary
	Coolant circulation constrained	Clean and rinse cooling system
	Malfunction of water pump	Replace water pump
	Malfunction of fan clutch	Replace fan clutch
	Malfunction of radiator fan	Check fan and fan motor
	Malfunction of fan relay	Check fan relay
	Belt slips, is broken	Retension / replace belt
Corrosion	Impurities in coolant	Clean, rinse and refill cooling system
Coolant loss	Hose damaged	Exchange hose
	Water pump leaky	Replace water pump
	Finned-tube core defective	Repair radiator or replace, if necessary
	Thermostat cover defective	Replace thermostat cover
	Defect at cylinder head	Check cylinder head and head gasket
	Plug on coolant system leaky	Replace plug
No heating of compartment	Heating hose defective	Replace heating hose
	Heater core clogged	Clean heater core and replace, if necessary
	Thermostat defective	Replace thermostat



■ Installation of water pumps

To ensure that your new KS water pump is installed into the appropriate vehicle, please observe the mounting instructions enclosed in the package.

2.1.5 Important Note

Proper maintenance of the cooling system is essential for the proper functioning of the engine. When installing a new KS water pump one should ensure that other components which are important for the cooling circuit such as drive belts, tension-

ing rollers, thermostat, hoses and clamps be inspected and exchanged as necessary. The cooling system must not be operated with pure water. The coolant prescribed by the vehicle manufacturer contains anti-corrosive inhibitors and

prevents damage to the water pump and other parts of the cooling circuit. Different coolants must not be mixed with each other. Coolants of inferior quality can cause damage and render the whole system inoperative.

2.1.6 Damage

Symptom	Possible cause	Remedy
Condensate around leakage bore	Permissible leakage	Shaft seal has a running-in period of 1–3 hours
Coolant leaks out via leakage bore	Corrosion in cooling system, due to the use of water without coolant additive	Clean cooling system, add coolant
Corrosion on rotor bearing surface	Shaft seal damaged chemically by contaminated coolant	Clean cooling system, add coolant
Pitting corrosion/cavitation on rotor, casing or shaft	Temperature too high; overaged or wrong coolant	Exchange coolant as prescribed, check operating temperatures of cooling system (check cooler, thermostat, fan)
Lateral guidance detached from drive wheel (thrust washers)	Incorrect alignment of timing belt, incorrect mounting of guide pulleys and belt tensioner	Correct alignment or replace drive belt
Corrosion throughout cooling system	Defective cylinder head gasket, wrong/used up coolant	Replace cylinder head gasket, clean cooling system
Water leaks from hose connection piece and housing seal	Failure to use seal included in delivery, improper use of sealing agent	Always install seal, use sealing agent as specified
Tooth profile of drive wheel worn, rubber on timing belt abraded	Tension of timing belt too high	Replace timing belt and adjust in accordance with manufacturer's specifications
Fatigue fracture of water pump bearing	Vibration and unbalance due to damaged fan coupling or tensioning rollers, tension of timing belt too high	Replace water pump and defective components

ENGLISH

2.2 Oil pumps

2.2.1 Engine lubrication

The task of the engine lubrication system is to provide the engine components with a sufficient quantity of lubricating oil. It represents a closed system in which the oil has to assume a number of tasks.

- Lubrication of all sliding parts
- Cooling of the engine parts – overheating protection
- Removal of deposits, combustion residues and abraded particles
- Corrosion protection
- Damping of noise and vibrations
- Micro sealing (e.g. piston rings)
- Power transmission

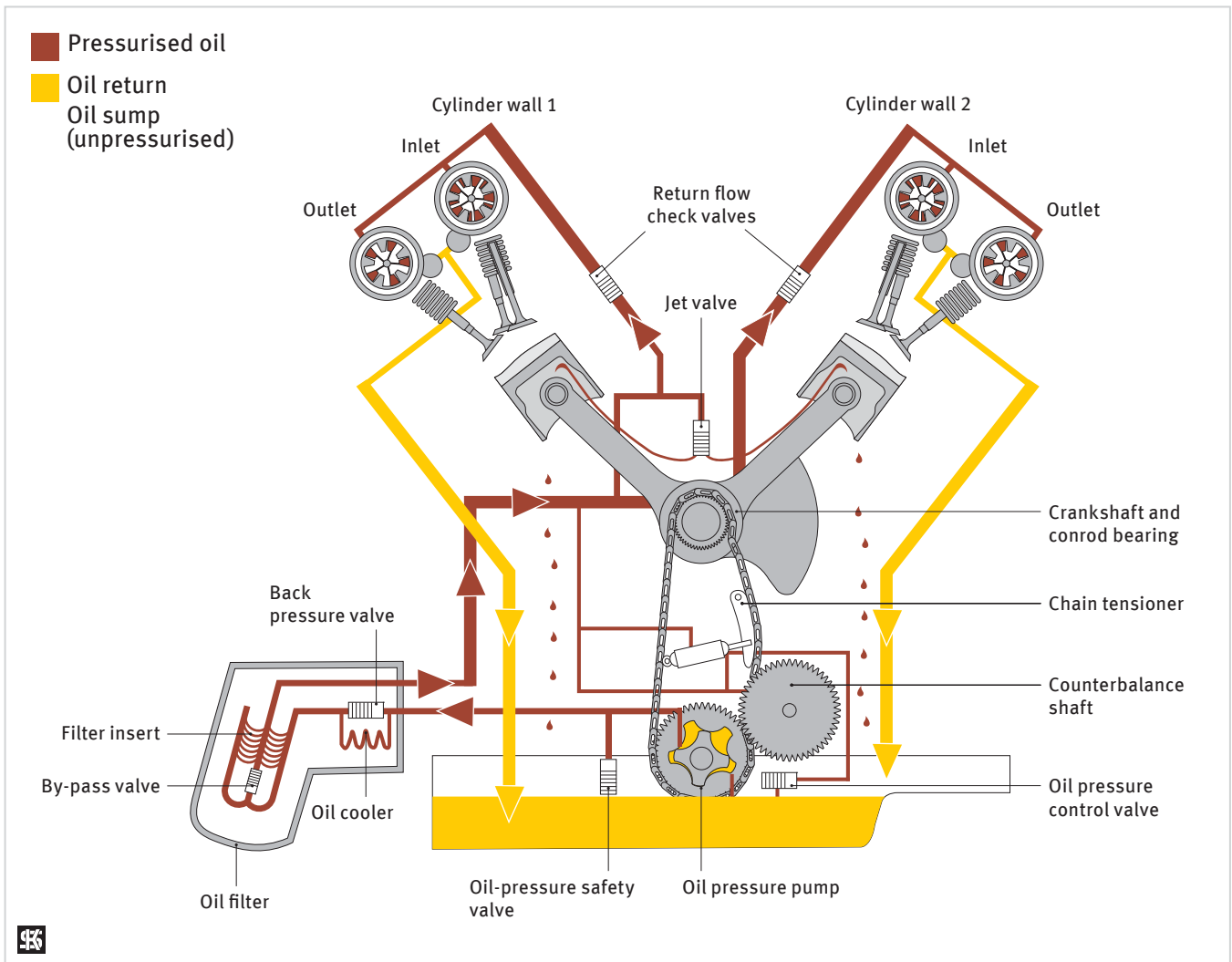

Oil circulation

2.2.2 Engine lubrication systems

In the field of engine lubrication a distinction is made between the following lubrication systems:

- Forced-feed lubrication
- Dry sump lubrication

■ Forced-feed lubrication

With this kind of lubrication, used in almost all four-stroke engines, the oil is fed by a pump over lines or ducts to a number of lubrication points. Besides the various shaft bearing positions, hydraulic valve adjusting elements (hydraulic valve lifters), rocker arms, timing chains, cam chain tensioners and even the pistons, among other things, are supplied with sufficient oil.

Different types of filters, from coarse, fine to micro, are used between the oil pump and the lubrication points to clean the oil. Air flow or water flow oil coolers are often used to cool the oil.

Oil pressure that is too high, often occurring during the cold start phase, but also in the case of high engine speeds, is prevented by a pressure limiting valve. It is installed on the pressure side near the pump or directly in the pump housing. It allows the excessive pressure to escape into the oil pan.

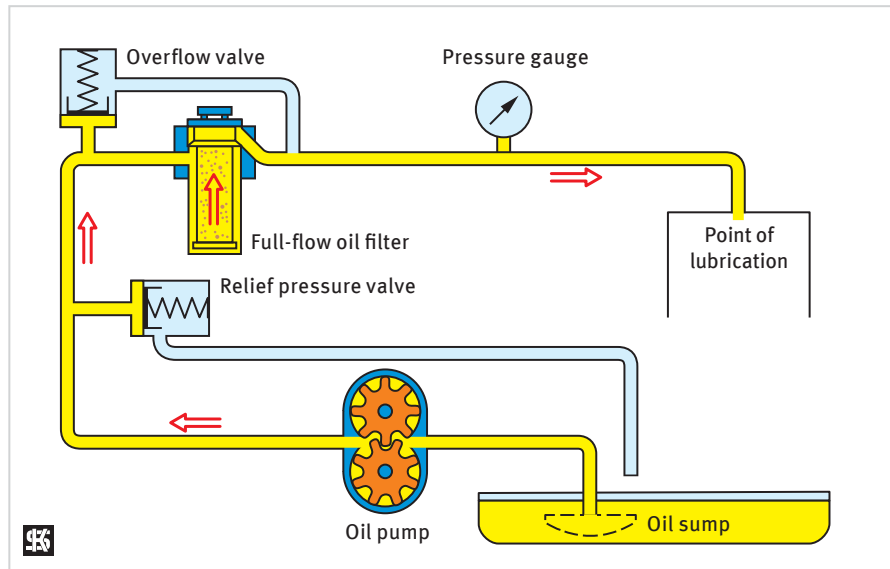

Forced-feed lubrication

■ Dry sump lubrication

Dry sump lubrication represents a special type of forced-feed lubrication. In this system the oil returning from the engine is pumped by a special extraction pump from the oil pan to a separate oil reservoir. From

here the engine oil is forwarded by a pressure feed pump to the respective lubrication points. The advantage of this design is that it always guarantees a sufficient oil supply even when the vehicle is at an extreme angle,

or despite the occurrences of centrifugal force. For this reason, this technology is often used in off-road or racing vehicles.

2.2.3 Types of construction and pump designs

Oil pumps are quite different in their type of construction and in their appearance. The pumping principle, the type of drive and the housing design are the most obvious distinctions.

Depending on the purpose, installation location and delivery rate, oil pumps that operate on the most different pumping principles are used.

The most frequently used pump constructions are:

- Gear pumps
- Crescent pumps
- Rotor pumps

■ Gear pumps

In a gear pump, the oil is transported by the rotation of two gear wheels between the teeth and the wall. The interlocking of the gear wheels prevents the oil from flowing back into the pan. So on one side overpressure occurs whilst a vacuum is created on the suction side.

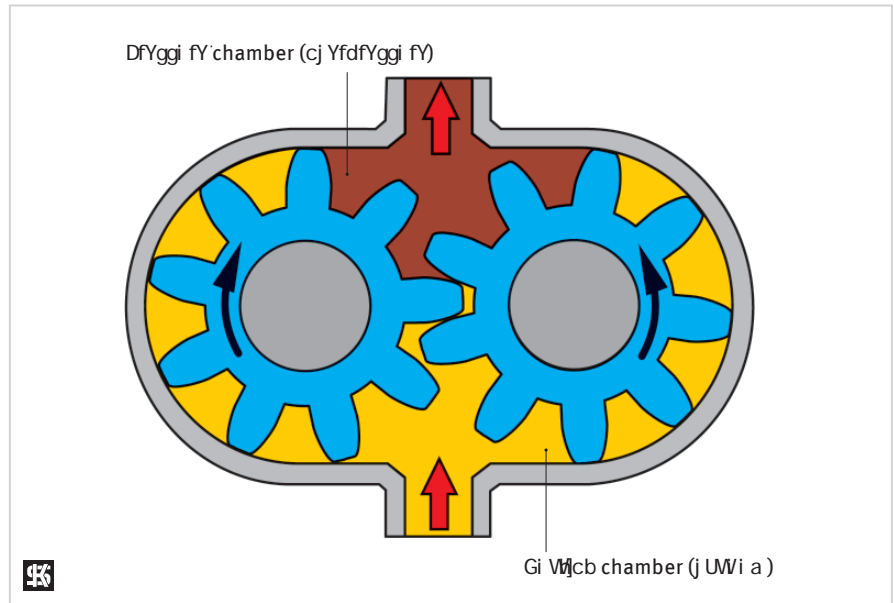

■ Crescent pump

In a crescent pump, an external gear wheel located in the pump housing is arranged eccentrically to the inside wheel. As is the case with a normal gear pump, the oil is transported in the spaces between the teeth. The continuous rotation of the pump creates a vacuum on the side where the teeth separate from each other. This is the suction side of the pump. In the area where the teeth mesh together again, an overpressure is created. This is where the pressurised oil is forced out.

The advantage of the crescent pump over the normal gear pump is an increased delivery rate, particularly at low engine speeds.

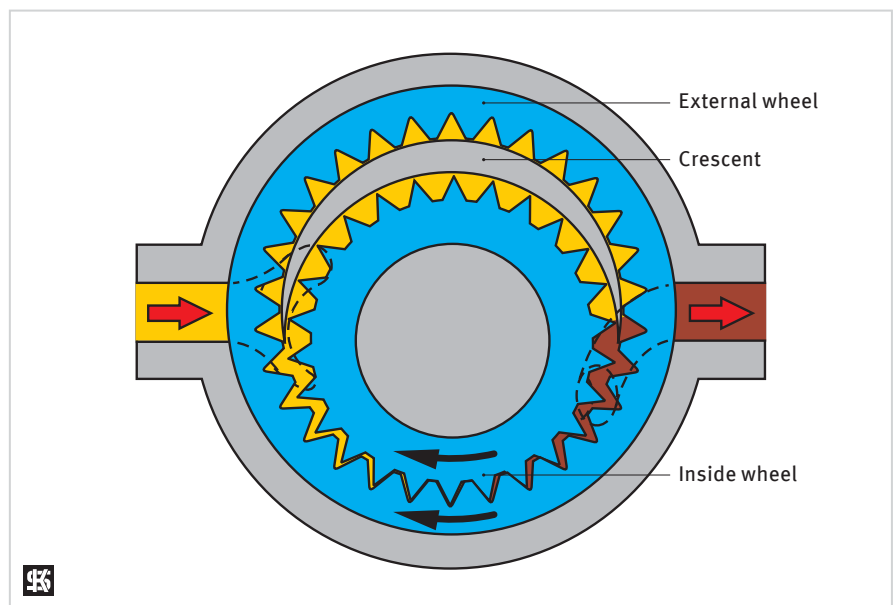

ENGLISH

■ **Rotor pump**

The rotor pump consists of an external rotor with teeth on the inside and an internal rotor with teeth on the outside. The external rotor rolls over the teeth of the internal rotor and in this manner rotates in the pump housing. The internal rotor has one tooth less than the external rotor, which causes fluid to be carried from one respective cavity to the next tooth cavity of the external rotor.

During rotation the cavities on the suction side increase whilst those on the pressure side decrease accordingly.

With this type of construction high pressure can be generated when there is a high delivery rate.

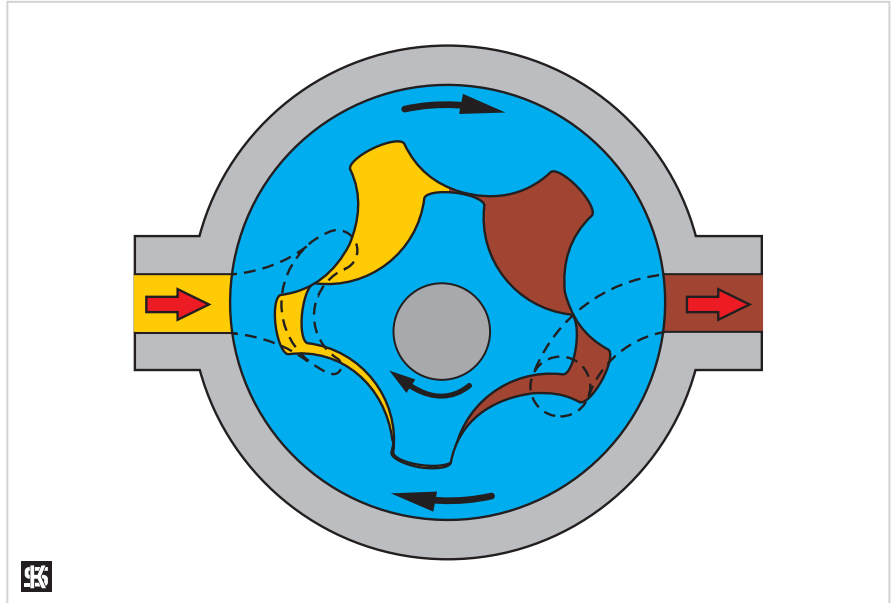

2.2.4 Types of oil pump drives

Usually oil pumps are driven directly by the engine. The drive is created either directly by gearing or plug connections on the crankshaft or via gear wheels, drive chains or toothed belts.



Pump with plug connector



Pump with gear drive

2.2.5 General installation instructions

To ensure the correct functioning and product life of the pump, the installation specifications of the engine manufacturer must definitely be observed when a new pump is being installed. The following, general installation instructions, however, must always be adhered to:

- Drain the used oil and check for potential impurities. Especially metallic impurities often indicate mechanical wear on individual engine components.
- Whenever a pump is to be installed, cleanliness is essential. The oil intake pipe is usually supplied with only a coarse strainer. After a repair, dirt and metal particles remaining in the engine could easily reach the interior of the new pump which would again be worn within a short period of time. Therefore, all components and ducts connected with the oil, as well as the oil intake pipe, should be cleaned if possible.
- Whenever a new oil pump is installed, the oil filter must always be changed as well. If the oil pressure system is heavily soiled, it must also be cleaned.
- Before a new pump is installed, it must be compared to the dimensions of the old pump.
- The pump drive train (gearing, keyed joints, sprockets and drive chains/belts) must be checked for possible damage.
- Before the pump is installed, all moveable parts of the pump (gear wheels, shafts) must be lubricated using the prescribed engine oil.
- During installation, make sure that the pump fits well in its place. If there are problems in the installation (fastening problems, angle position) the pump must not be screwed to the housing by force. This could cause damage to the pump, malfunctions and leaks.
- Whenever the oil pump and the oil intake pipe are to be installed, new gaskets and sealing rings must always be used. The general use of liquid sealants should be avoided. These should only be used where intended by the engine manufacturer.
- During installation, only the torque specified by the engine manufacturer should be used to tighten the fixings screws for the pump.
- If liquid screw adhesives or mechanical screw locking devices are intended, they must be used in accordance with the engine manufacturer's specifications.
- Prior to restarting the engine, we recommend filling the oil system with a separate pressure tank (pressure application process). In the process, the pressure side of the oil system will be filled completely with oil and vented. Usually the system is filled until the oil reaches the engine lubrication points that are the highest and the farthest away from the oil pump. In the process, the oil should escape at the rocker arms or camshaft bearing positions. This will prevent damage that could be caused by insufficient oil pressure when the engine is being started.
- After "applying pressure" to the oil system, the engine will be filled to the specified oil level.
- When the engine is being started for the first time after the pump has been replaced, the engine will build up oil pressure in a few seconds. If no oil pressure is generated, the start-up procedure must be stopped or the engine shut off to remedy the cause of this fault. Revving-up the engine to accelerate oil pressure build-up must be avoided in any case.
- Use only the oils prescribed and authorised by the engine manufacturer.
- Service the engine according to the manufacturer's specifications.

2.2.6 Troubleshooting / damage diagnosis

The lubrication system and the engine mechanics consist of a number of fixed and moveable parts. Each component is involved specifically for itself as well as in conjunction with other components. For this reason, oil pressure and oil supply problems can have multiple causes. When one component fails, often the entire lubrication system is affected. If

the problem is not detected in time, or even ignored, all the associated components will be impaired. Often a small problem can cause the complete destruction of the engine. Before the replacement of an oil pump is considered, check the options below and remedy any potential damage.

■ Problems caused if oil pressure is insufficient or absent

- Oil level too low
- Oil viscosity too low (too thin)
- Oil foam in crankcase because oil level is too high, due to unsuitable oil with wrong additive, or due to dirty oil
- Oil intake strainer clogged
- Leak in oil intake pipe (only air is drawn in)
- Sticking (open) oil pressure control valve
- Clogged oil filter
- Clogged oil ducts, hose lines and oil cooler
- Always open or broken oil spray nozzles (piston oil-spray cooling)
- Missing or fallen out plugs on pressure carrying ducts of the engine block, cylinder head and crankshaft.
- Worn bearings in crankshaft, camshaft, balance shafts and rocker shafts.
- Worn or defective components such as hydraulic valve lifters, turbochargers, injection pumps or high pressure fuel pumps.
- Leaky sealing surfaces in the engine

■ Problems caused if oil pressure is excessive

(Usually these are not caused by a defective oil pump)

- Oil viscosity too high (too thick)
- Oil pressure control valve does not work (remains closed)
- Oil filter clogged
- Oil pressure lines clogged
- A pump with an excessive delivery rate was installed by mistake

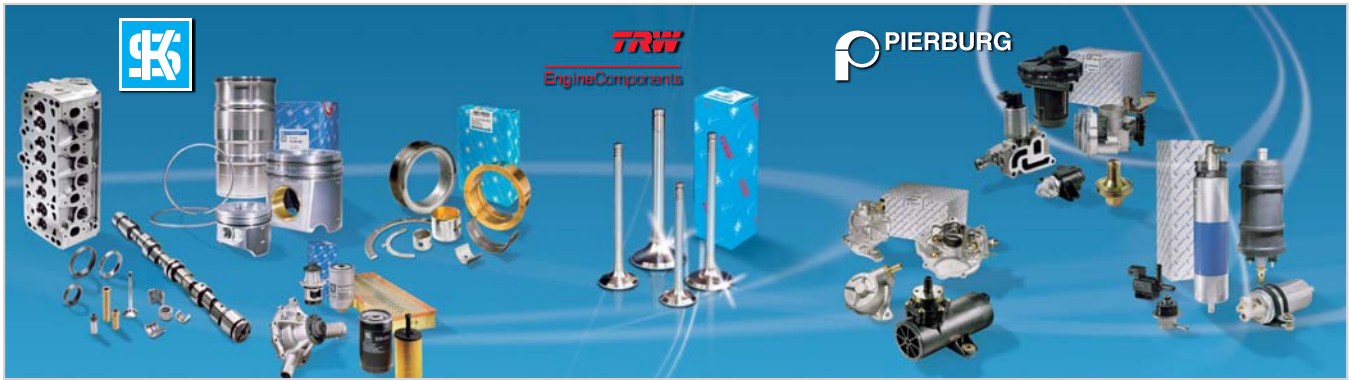

MS Motor Service International GmbH est l'organisme de distribution responsable du marché de la rechange au niveau mondial de la Kolbenschmidt Pierburg AG. Elle est l'un des premiers fournisseurs de composants de moteur pour le marché libre de la rechange sous les grandes marques KOLBENSCHMIDT, PIERBURG et TRW Engine Components.

Un assortiment large et profond permet aux clients MSI d'acquérir leurs pièces moteur d'une seule source. Pour résoudre tous les problèmes, MSI propose, au grossiste comme à l'atelier, un ensemble imposant de prestations de service ainsi que la compétence technique en tant que filiale d'un grand équipementier automobile.

Kolbenschmidt Pierburg Group

En tant que partenaires de longue date de l'industrie automobile, les entreprises du groupe Kolbenschmidt Pierburg développent de manière compétente des solutions innovatrices pour composants, modules et systèmes dans le domaine de l'alimentation en air et pour la réduction des émissions nocives, dans la production des pompes à huile, à eau et à vide, ainsi que des pistons, des blocs moteur et des coussinets.

Note importante

Par la suite, MS Motor Service International GmbH est abrégée par MSI.

Les informations et données réunies dans ce catalogue ont fait l'objet d'un travail méticuleux, mais n'engagent pas notre responsabilité. Nous ne répondons pas des modifications apportées à nos produits ou à leurs désignations par les constructeurs automobiles ou de moteurs. En cas de doute, veuillez vous adresser à notre service après-vente technique. De même, toutes les notifications d'erreurs éventuelles relevées dans ce catalogue seront les bienvenues et seront corrigées dans les versions futures. Les noms, les descriptions et les numéros de véhicules ou de constructeurs, etc. figurant dans ce catalogue ne sont donnés qu'à des fins de comparaison. Les articles mentionnés dans le catalogue sont des pièces de rechange de qualité KS.

Les représentations, les dessins schématiques et autres éléments sont destinés à expliquer et à illustrer nos produits et ne peuvent en aucun cas servir de base à l'installation des pièces, à la définition des étendues de fournitures et à la conception. Les numéros de pièce détachée d'origine utilisés par les fabricants de véhicules et de moteurs et que nous reprenons dans ce catalogue ne s'entendent qu'à des fins de comparaison. Ils ne constituent pas des désignations de provenance et ne doivent pas être utilisés dans les rapports avec des tiers. De ce fait, le contenu des listes comparatives ne saurait engager notre responsabilité, notamment en raison des modifications éventuellement apportées par les fabricants et/ou que des écarts de dimension pouvant exister entre l'un et l'autre. Dans la mesure où ce catalogue contient des articles qui n'ont pas été fabriqués par MSI, c'est de leurs fabricants que proviennent

les informations et données fournies. Nous ne répondons pas de l'exactitude de ces informations et données ni de l'aptitude des produits à la finalité prévue. Afin de vous en assurer, veuillez, avant de les installer, prendre contact avec le fabricant ou l'un de ses concessionnaires autorisés qui sauront vous conseiller en expert. Les pièces proposées dans ce catalogue ne sont pas destinées au montage sur des avions ou des hélicoptères. En cas d'application sur des moteurs marins, il est possible que, sous le même code moteur, des pièces moteur (par exemple les pistons) différentes doivent être montées. Toute copie ou reproduction, intégrale ou partielle, faite sans notre consentement écrit et sans indication de source, est illicite. La présente édition remplace et annule toutes les éditions précédentes.

Modifications réservées.

Vous trouverez d'importantes informations techniques dans

Service
Conseils & infos

Ces brochures peuvent être également consultées sur notre page d'accueil

www.ms-motor-service.com



FRANÇAIS

Tables des matières	Page
Note important	34
Gestion de la qualité	35
1. Précision sur l'utilisation du catalogue	36
2. Informations techniques sur le produit.....	38
2.1 Pompes à eau	38
2.1.1 Circuit de refroidissement	38
2.1.2 Eléments constitutifs d'une pompe à eau	39
2.1.3 Types de construction	40
2.1.4 Tableau technique.....	41
2.1.5 Information importante	42
2.1.6 Détériorations	42
2.2 Pompes à huile	43
2.2.1 Lubrification du moteur.....	43
2.2.2 Systèmes de lubrification des moteurs.....	44
2.2.3 Types de construction et modèles de pompes.....	45
2.2.4 Types d'entraînement des pompes à huile.....	46
2.2.5 Instructions générales de montage.....	47
2.2.6 Détection des causes / Diagnostic des dégâts.....	48
3. Applications principales / Illustrations de produits	81
4. Compléments de la gamme	163
5. Index des constructeurs.....	167
6. Gamme.....	171
7. Liste de correspondance	1271
8. Formulaire «Quality Information Report»	
9. Conditions Générales de Vente et de Livraison	

Gestion de la qualité

Nos produits se distinguent par leur haute précision, obtenue grâce au développement professionnel des produits et procédés que nous pratiquons, aux méthodes de fabrication modernes que nous mettons en œuvre et aux contrôles très complets que nous effectuons. Notre système de gestion de la qualité est certifié selon DIN EN ISO 9001 et ISO/TS 16949 et nous ne cessons de le faire évoluer.

Si, en dépit des contrôles effectués tout au long du processus de production et du rigoureux contrôle final, un défaut de matière ou de fabrication apparaissait sur un produit KS, nous prendrions en charge, durant la période de prescription, ou bien la remise en état du moteur ou bien le remplacement du produit vicié. Les

réclamations pour vices doivent nous parvenir par écrit dans un délai de 30 jours suivant la date à laquelle le défaut a été constaté.

La période de prescription concernant les réclamations pour vices est de 24 mois, à compter de la date de livraison des pièces concernées. Toute réclamation pour vices est exclue, si les pièces ont été modifiées par des tiers ou par incorporation de pièces provenant de tiers, sauf lorsqu'il n'existe pas de rapport de cause à effet entre le défaut et les modifications apportées. Il en est de même, si les pièces n'ont pas été manipulées et montées conformément aux instructions fournies.

Notre garantie ne couvre pas l'usure normale et tout endommagement dû à des conditions d'utilisation impropre.



1. Précision sur l'utilisation du catalogue

Listes de moteurs

Au début de chaque section, consacrée à un constructeur, se trouve une aide recherche détaillée: Les désignations de moteurs sont classées par ordre croissant alphanumérique.



INDEX

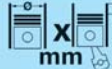

		Cyl.	 mm	cm ³		Comp. Ratio ϵ	kW	PS	Pos	
A 6 M 816	D	(AN)	6	142 x 160	15204	2	16:1	145-172	197-234	45
A 6 M 816 R	D	(LA)	6	142 x 160	15204	2	16:1			45
A 6 M 816 U	D	(LA)	6	142 x 160	15204	2	16:1			45
A 6 M 816 W	D	(LA)	6	142 x 160	15204	2	16:1			45
A 8 M 816	D	(A)	8	142 x 160	20272	2	16:1	190-230	259-313	45
A 8 M 816 C	D	(LA)	8	142 x 160	20272	2	16:1			45
A 8 M 816 CR	D	(LA)	8	142 x 160	20272	2	16:1			45
A 8 M 816 R	D	(LA)	8	142 x 160	20272	2	16:1			45
A 8 M 816 U	D	(LA)	8	142 x 160	20272	2	16:1			45
A 8 M 816 W	D	(LA)	8	142 x 160	20272	2	16:1			45
A 12 M 816	D	(A)	12	142 x 160	30438	2	16:1	162-321	220-436	45
A 12 M 816 C	D	(LA)	12	142 x 160	30438	2	16:1			45
A 12 M 816 CR	D	(LA)	12	142 x 160	30438	2	16:1			45
A 12 M 816 R	D	(LA)	12	142 x 160	30438	2	16:1			45
A 12 M 816 U	D	(LA)	12	142 x 160	30438	2	16:1			45
A 12 M 816 W	D	(LA)	12	142 x 160	30438	2	16:1			45
A 16 M 816	D	(A)	16	142 x 160	40544	2	16:1	216-427	295-581	45

Type de carburant
B = essence | D = gas-oil | G = gaz







Alimentation de moteur
A = moteur suralimenté
AN = moteur atmosphérique
K = compresseur
LA = moteur suralimenté avec intercooler

Repère

FRANÇAIS

Données concernant les produits

Les pages de catalogue sont composées de blocs d'information repris ci-après:

Année de construction de → à		Modèle		Désignation du moteur		Ligne consacrée au constructeur	
						Constructeur	
							
Golf II 1.8						75	
08.1983→07.1993	EX, GU, GZ, HT, HV, JH, KT, RG, RH, RV, 1P, 2H						
Reference	026 121 005 A	026 121 005 C	026 121 005 E	026 121 005 G	Repère		50 005 148
	026 121 005 H	037 121 005 B	037 121 005 C	068 121 005 A			
	95 VW 8503 AA						
	ohne Gegengehäuse/ without backhousing/ sans demi-corps/ sin remate						
08.1983→07.1993	EX, GU, GZ, HT, HV, RG, RH, RV						
Reference	027 115 105	027 115 105 E	049 115 105 A	055 115 105 D	Repère		50 005 808
N° de référence d'origine		Observations		Repère			
				N° de référence de la pompe à huile		N° de référence de la pompe à eau	

2. Informations techniques sur le produit

2.1 Pompes à eau

2.1.1 Circuit de refroidissement

Le système de refroidissement fonctionne en circuit fermé. Son rôle est d'assurer l'équilibre thermique dans le moteur, car ce n'est qu'à des températures optimales que le moteur atteint son meilleur niveau de fonctionnement, c'est-à-dire un rendement élevé et une combustion complète, ce qui, à son tour, diminue les émissions polluantes.

Le liquide de refroidissement utilisé dans le circuit de refroidissement est un mélange d'eau et de produit antigel et anticorrosion, généralement recommandé par le fabricant. Le

point d'ébullition de ce mélange est supérieur à celui de l'eau et autorise, à une pression de 1,4 bar, des températures du liquide de refroidissement pouvant aller jusqu'à 120°C.

Le thermostat régule le circuit de refroidissement en fonction de la température du liquide de refroidissement. A moteur froid, il reste inactif, afin que la température de service soit atteinte le plus vite possible (petit circuit de refroidissement). Ce n'est qu'à partir d'une température déterminée que le thermostat se déclenche, élargissant la fonction

de refroidissement au radiateur (grand circuit de refroidissement). La pompe à eau, entraînée à travers une courroie, fait circuler le liquide de refroidissement et en assure, après déclenchement du thermostat, le transport régulier et rapide, du moteur au radiateur. Dans le radiateur le liquide de refroidissement chaud est refroidi soit par l'air arrivant sur le radiateur, lorsque la voiture roule, soit par l'action du ventilateur associé au radiateur qui aspire un supplément d'air.

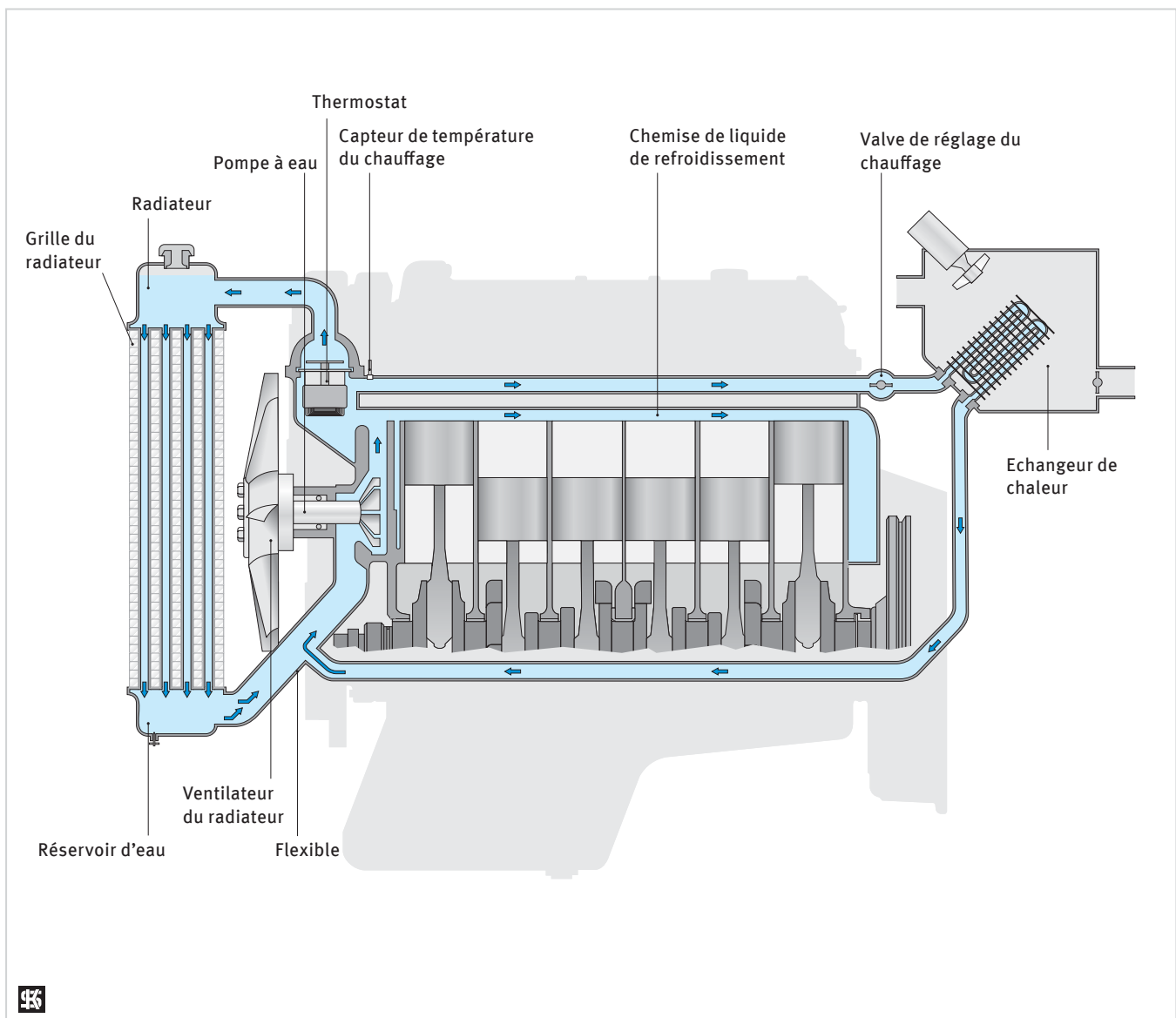

FRANÇAIS

2.1.2 Éléments constitutifs d'une pompe à eau

L'élément central d'une pompe à eau pour automobiles est l'ailette, aussi appelée rotor. Suivant le type, elle peut avoir un nombre différent d'ailes qui peuvent être droites ou courbées et être arrangées de façon radiale ou tangentielle. La configuration et les dimensions de l'ailette sont déterminantes pour le volume de débit de la pompe à eau.

D'autres éléments constitutifs de la pompe à eau sont l'arbre d'entraînement et les paliers qui forment presque toujours un ensemble prêt au montage. L'arbre d'entraînement porte, côté refoulement, la roue à aubes et, côté entraînement, une bride ou une poulie.

Le corps de la pompe est en aluminium ou en fonte sur lequel sont fixés différents éléments annexes, tels que raccords de flexibles, thermostats, bouchons, etc. En outre, le corps de pompe comporte un orifice de fuite qui sert au contrôle. Le joint d'étanchéité d'arbre assure l'étanchéité entre corps et arbre d'entraînement. C'est donc elle qui détermine en grande partie la durée de vie de la pompe à eau.

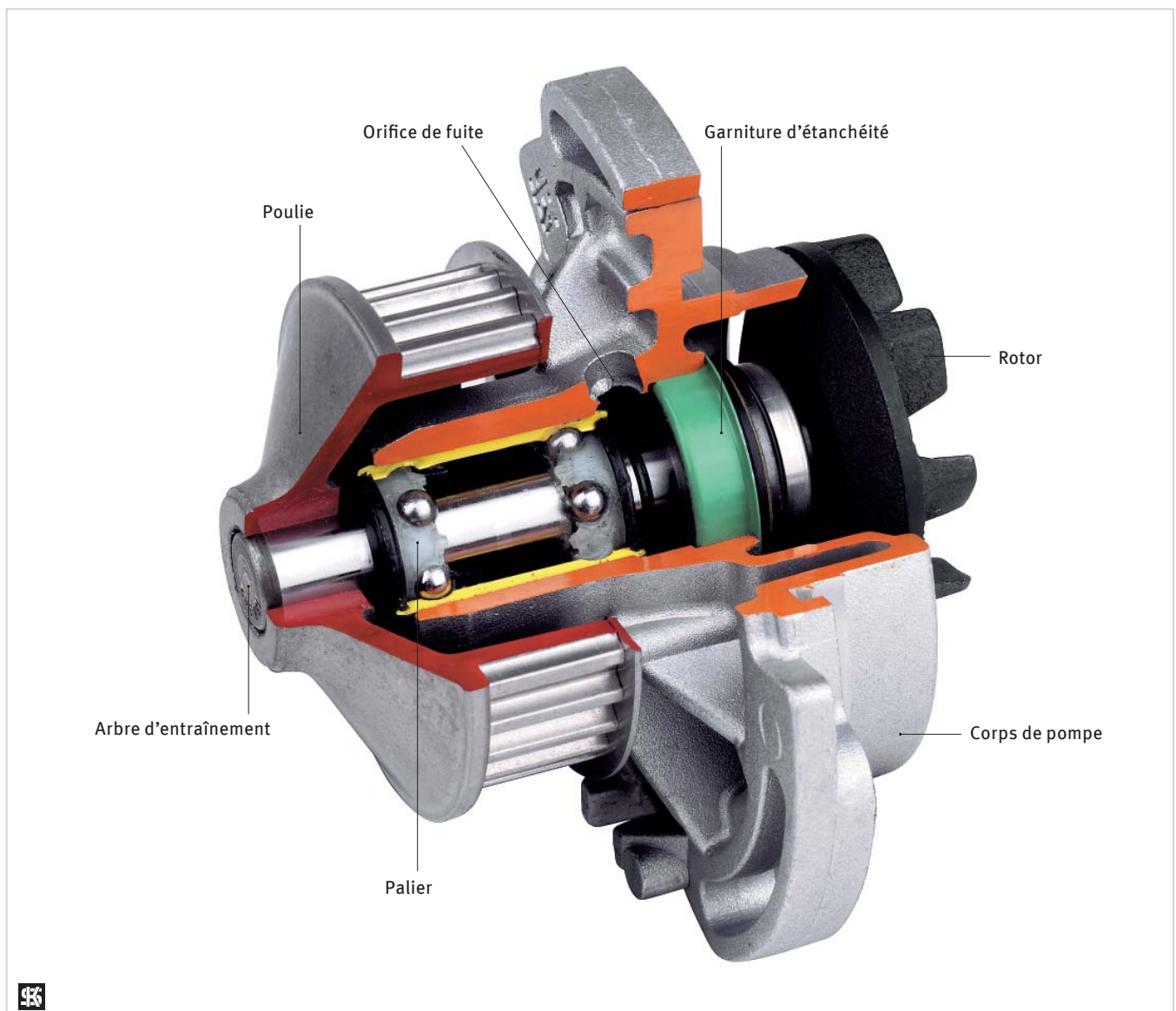

2.1.3 Types de construction

Les pompes à eau diffèrent fortement suivant le type de construction et donc l'aspect. La configuration du corps et le type d'entraînement sont les deux caractéristiques distinctives les plus notables:

■ Type d'entraînement

La pompe à eau est entraînée par le moteur via une courroie. Celle-ci est soit la courroie de distribution commandant l'arbre à cames, soit la courroie trapézoïdale ou striée venant

du vilebrequin. Si la poulie n'est pas prévue d'origine sur la pompe, elle doit être vissée sur la bride de l'arbre d'entraînement.



Entraînement par courroie de distribution



Entraînement par courroie trapézoïdale



Pompe sans poulie

■ Configuration du corps de pompe

Les pompes à eau peuvent être ouvertes ou fermées. Dans le cas des pompes ouvertes, il est prévu sur le moteur un emplacement de fixation de la pompe, avec,

entre les deux, un élément d'étanchéité sous forme d'anneau d'étanchéité ou de joint plat. L'élément de reprise sur lequel se fixe le corps de pompe fait partie intégrante du

moteur. En revanche, les pompes fermées constituent un ensemble en soi, comportant une plaque ou un couvercle qui les ferment.



Pompe avec bride de fixation



Pompe avec boîtier

2.1.4 Tableau technique

Différents incidents peuvent survenir au niveau du système de refroidissement. Ci-après une liste reprenant les principaux problèmes, leurs causes et les mesures à prendre pour y remédier:

Symptôme	Cause possible	Remède
Surchauffe	Manque de liquide de refroidissement	Rajouter du liquide de refroidissement
	Condenseur de la climatisation bouché	Nettoyer ou remplacer le condenseur
	Grille du radiateur bouchée	Nettoyer ou remplacer le refroidisseur
	Thermostat ne réagit pas	Vérifier ou remplacer le thermostat
	Circulation du liquide gênée	Nettoyer le système de refroidissement
	Dysfonctionnement de la pompe à eau	Remplacer la pompe à eau
	Dysfonctionnement de l'embrayage du ventilateur	Remplacer l'embrayage du ventilateur
	Dysfonctionnement du ventilateur du radiateur	Vérifier le ventilateur du refroidisseur et le moteur du ventilateur
	Dysfonctionnement du relais du ventilateur	Vérifier le relais du ventilateur
	Courroie d'entraînement patine/ cassée	Tendre/ remplacer la courroie
Corrosion	Impuretés dans le liquide de refroidissement	Nettoyer le circuit de refroidissement, le rincer et le remplir à nouveau
Pertes de liquide de refroidissement	Flexible endommagé	Remplacer le flexible
	Pompe à eau fuit	Remplacer la pompe à eau
	Grille du radiateur défectueuse	Réparer ou remplacer le radiateur
	Capuchon du thermostat défectueux	Remplacer le capuchon
	Défaillance sur la culasse	Vérifier la culasse et le joint de culasse
	Bouchon sur le système fuit	Remplacer le bouchon
Chauffage ne fonctionne pas	Conduite de chauffage défectueuse	Remplacer la conduite
	Echangeur de chaleur bouché	Nettoyer ou remplacer l'échangeur
	Thermostat défectueux	Remplacer le thermostat



■ Montage des pompes à eau
 Afin d'assurer un montage correct de votre nouvelle pompe à eau KS sur le bon véhicule, veuillez respecter les instructions générales de montage se trouvant dans l'emballage.

2.1.5 Information importante

Un entretien correct du système de refroidissement est indispensable au bon fonctionnement du moteur. Au changement de la pompe à eau, les autres composants importants de la circulation d'eau de refroidissement tels que les courroies, les galets, les thermostats, les condui-

tes et les colliers de serrage doivent également être contrôlés et, si nécessaire, changés.

Le système de refroidissement ne doit pas être rempli d'eau pure. Le liquide de réfrigération prescrit par le constructeur contient des inhibiteurs réduisant la corrosion et évi-

tent des avaries sur la pompe à eau et les autres organes du circuit de refroidissement.

Certains liquides de refroidissement ne peuvent pas être mélangés entre eux. Des liquides de qualité inférieure peuvent provoquer des dégâts et paralyser tout le système.

2.1.6 Détériorations

Aspect de la panne	Cause possible	Elimination
Condensation à l'orifice de vidange	Fuite normale	Le rodage de la garniture d'étanchéité dure de 1 à 3 heures.
Fuite de liquide à l'orifice de vidange	Corrosion dans le système de refroidissement, fonctionnement à l'eau pure (sans additif pour radiateur)	Nettoyer tout le système. Remplir avec un liquide correct
Corrosion sur les parois de la roue à aubes	Garniture détruite chimiquement par un liquide encrassé	Nettoyer tout le système. Remplir avec un liquide correct
Orifice de corrosion/ cavitation sur la roue, le boîtier ou l'axe	Température trop élevée, mauvais liquide de refroidissement ou trop vieux	Changer le liquide conformément aux prescriptions, contrôler les températures de service du système de refroidissement (contrôle du radiateur, du thermostat, du ventilateur)
Guidage latéral sorti du pignon d'entraînement (rondelles de butée)	Mauvais alignement de la courroie d'entraînement d'arbre à cames, erreur de montage des poulies et du tendeur de courroie	Corriger sa position, éventuellement changer la courroie d'entraînement
Corrosion dans tout le système de refroidissement	Joint de culasse défectueux, mauvais liquide de refroidissement, ou trop vieux	Changer le joint de culasse. Nettoyer tout le système
Fuite d'eau aux conduites de raccordement et au joint du boîtier	Le joint fourni n'a pas été monté, la pâte d'étanchéité a mal été placée.	Toujours monter le joint, utiliser la pâte d'étanchéité correctement
Usure des dents de la roue d'entraînement, traces de caoutchouc de la courroie.	Tension trop forte de la courroie d'entraînement	Changer la courroie d'entraînement et la régler conformément aux prescriptions du constructeur.
Rupture par fatigue du palier de la pompe à eau	Des vibrations ont été provoquées par un ventilateur ou un galet défectueux, tension trop importante de la courroie d'entraînement	Changer la pompe à eau ainsi que les pièces défectueuses.

2.2 Pompes à huile

2.2.1 Lubrification du moteur

Le système de lubrification du moteur a pour fonction d'apporter de l'huile de lubrification en quantité suffisante vers les organes du moteur. Il se présente sous forme d'un circuit fermé dans lequel l'huile doit assumer un grand nombre de fonctions.

- Lubrification de toutes les parties soumises au frottement
- Refroidissement des organes du moteur - Protection contre la surchauffe
- Evacuation des dépôts, des restes de combustion et d'abrasion
- Protection contre la corrosion
- Amortissement des bruits et des vibrations
- Étanchéification de précision (par exemple au niveau des segments du piston)
- Transmission de force

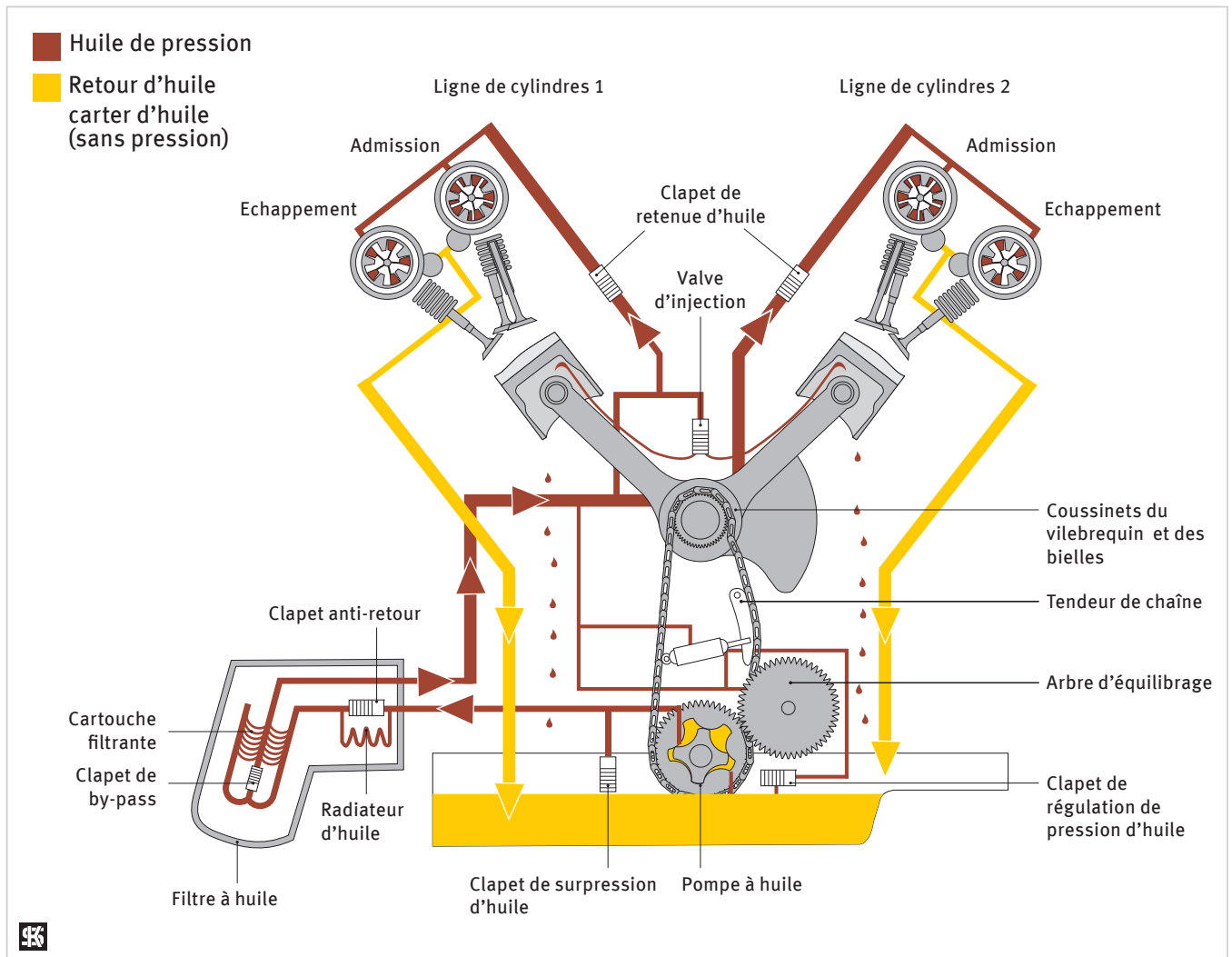

Circulation d'huile

FRANÇAIS

2.2.2 Systèmes de lubrification des moteurs

Dans le domaine de la lubrification du moteur, on distingue les systèmes suivants:

- Lubrification par circulation forcée
- Graissage à carter sec

■ Lubrification par circulation forcée

Dans ce type de lubrification, utilisé sur la plupart des moteurs à quatre temps, l'huile est guidée au travers de conduites ou de canaux vers les nombreux points de lubrification grâce à une pompe.

Mis à part les coussinets d'arbre, d'autres éléments tels que ceux de l'équilibrage des soupapes (poussoirs hydrauliques), les culbuteurs, les chaînes de distribution, les tendeurs de chaîne mais aussi les pistons doivent être alimentés avec suffisamment d'huile.

Entre la pompe à huile et les points de lubrification, le nettoyage de l'huile est pris en charge par différents types de filtres grossiers, fins et extra-fins. Le refroidissement de l'huile est souvent assuré par des radiateurs à huile traversés par de l'air ou de l'eau.

Une pression trop élevée, pouvant survenir principalement pendant la phase de démarrage à froid ou à très haut régime du moteur, peut être

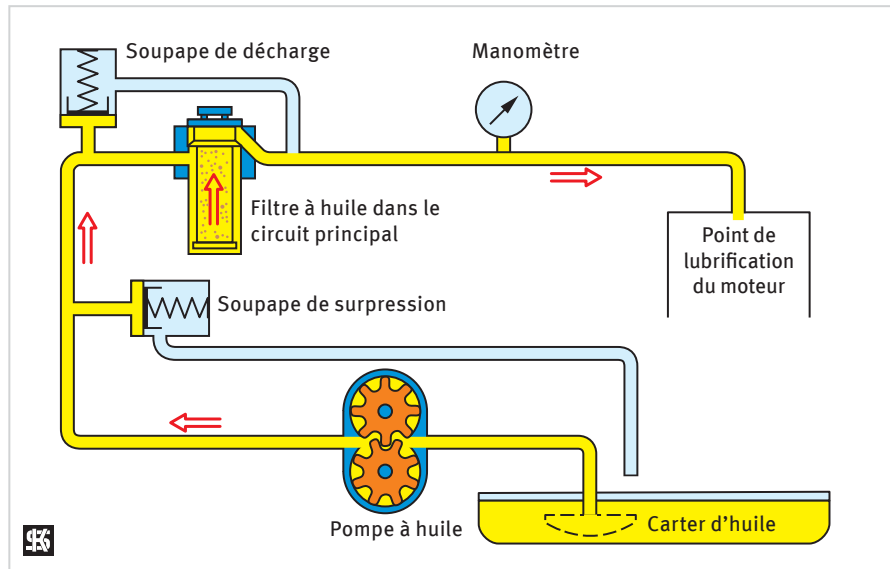

Lubrification par circulation forcée

évitée grâce à une soupape de limitation de pression. Celle-ci est placée à la sortie de la pompe ou directement sur le boîtier de la pompe et refoule la surpression d'huile vers le carter.

■ Graissage à carter sec

Le graissage à carter sec représente une forme particulière de la lubrification par circulation forcée. Dans ce système, l'huile refoulée par le moteur dans le carter est aspirée par une pompe spéciale vers un réservoir de provision d'huile séparé. C'est à

partir de là que l'huile de moteur est conduite vers les points de lubrification au travers de la pompe d'alimentation en pression. L'avantage de ce système consiste dans le fait que malgré une position extrêmement inclinée ou face à de fortes forces

centrifuge, une bonne alimentation en huile reste assurée. Pour cette raison, cette technique est souvent utilisée dans la construction des véhicules tous terrains ou en compétition automobile.

2.2.3 Types de construction et modèles de pompes

Les types de construction et la forme des pompes à huile sont très diverses. Les caractéristiques de différenciation principales sont leur principe de fonctionnement, leur mode d'entraînement et la forme du boîtier.

En fonction de leur domaine d'application, du lieu d'emplacement et de leur débit, différentes pompes à huile fonctionnant selon des principes divers sont sélectionnées.

Les modèles de pompes les plus souvent rencontrés sont:

- les pompes à engrenages
- les pompes à engrenages internes
- les pompes à rotors

■ Pompes à engrenages

Dans le cas de la pompe à engrenages, l'huile est convoyée par le mouvement circulaire de deux roues crantées et passe entre les dents et la paroi interne. L'huile entraînée par les dents des engrenages ne peut plus retourner vers le carter. De cette manière, il y a surpression d'un côté tandis que se constitue une dépression du côté aspiration.

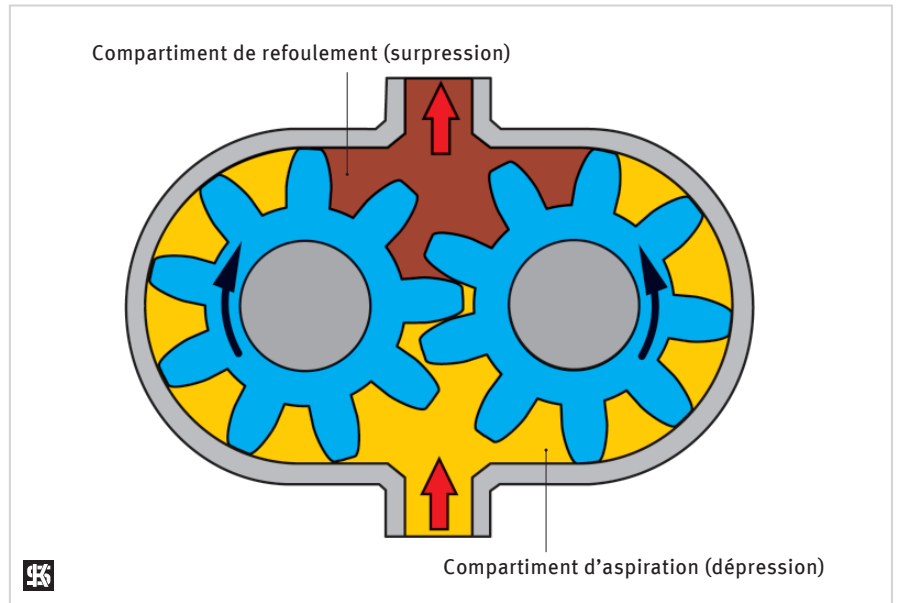

■ Pompe à engrenages internes

Dans la pompe à engrenages internes, la roue crantée interne s'emboîte de manière excentrique dans une autre roue crantée fixée sur le pourtour du boîtier de la pompe. Comme dans le cas de la pompe à engrenages normale, l'huile est transportée par les espaces entre les dents. Au cours du mouvement rotatif de la pompe, une zone de dépression se forme du côté où les dents se séparent. Ceci est le côté aspiration de la pompe. Dans la zone où les dents s'engrènent de nouveau, il y a formation d'une surpression. A cet endroit, l'huile est refoulée.

L'avantage de la pompe à engrenages internes par rapport à la pompe à engrenages normale réside dans un débit plus important, surtout à bas régime.

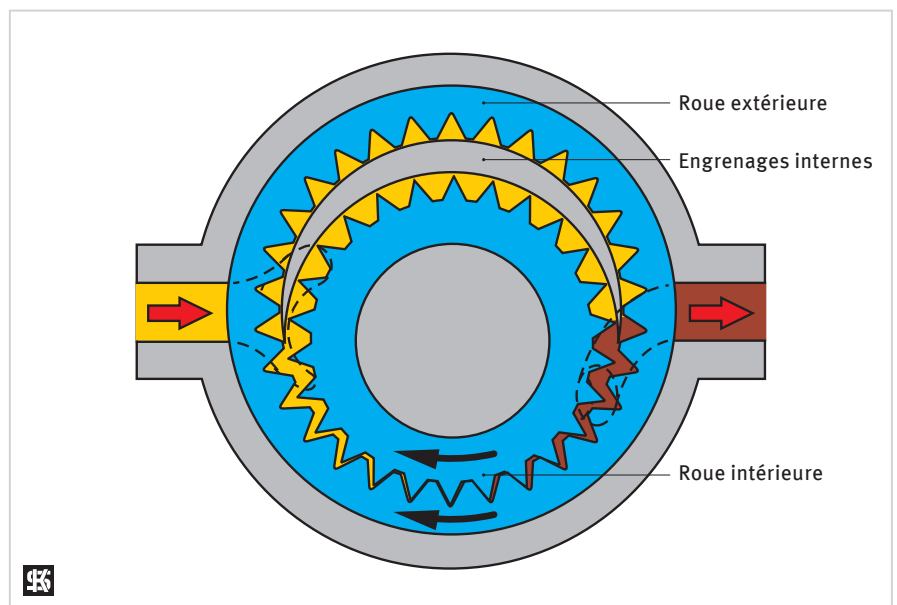

■ Pompes à rotors

La pompe à rotors est composée d'un rotor externe avec des dents orientées vers l'intérieur et d'un rotor interne avec des dents orientées vers l'extérieur. Le rotor externe s'engrène sur les dents du rotor interne et, de cette manière, tourne dans le boîtier de la pompe. Le rotor interne possède une dent de moins que le rotor externe, si bien qu'en tournant, le liquide est transporté d'un vide d'entredent à l'autre du rotor externe. Au cours du mouvement rotatif, les espaces s'agrandissent du côté aspiration, tandis qu'ils se réduisent proportionnellement du côté refoulement. Ce type de construction permet d'obtenir une forte pression à haut débit.

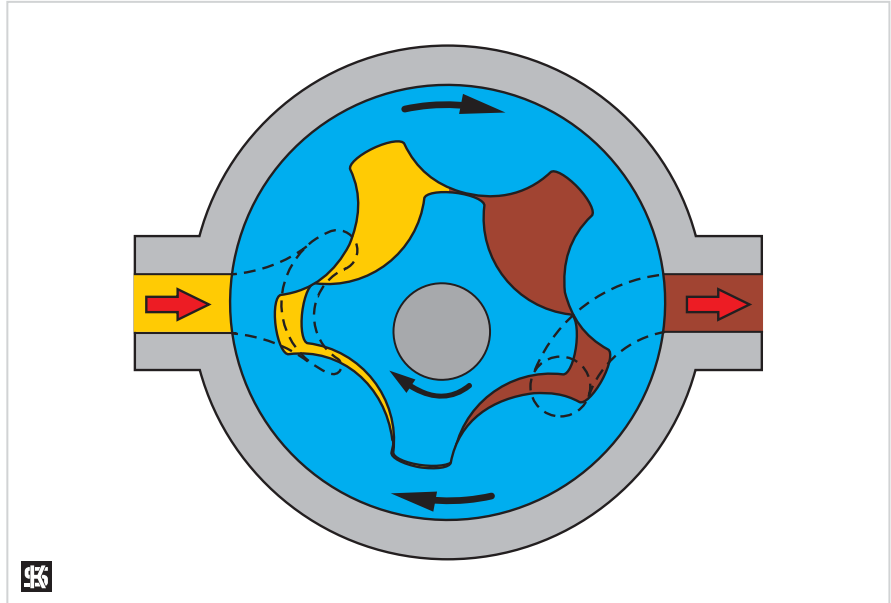

2.2.4 Types d'entraînement des pompes à huile

En règle générale, les pompes à huile sont entraînées directement par le moteur. L'entraînement a lieu directement par des dentures ou des systèmes d'emboîtement sur le vilebrequin ou encore par des engrenages, des chaînes de distribution ou des courroies crantées.



Pompe à entraînement enfichable



Pompe à engrenage

2.2.5 Instructions générales de montage

Les prescriptions de montage du fabricant du moteur doivent être impérativement respectées de manière à assurer un bon fonctionnement et une longue durée de vie de la pompe.

Par ailleurs, les instructions générales de montage suivantes doivent être suivies:

- Vidanger la vieille huile. Celle-ci doit être contrôlée à la recherche d'éventuelles impuretés. En particulier les impuretés métalliques laissent souvent supposer une usure mécanique de certains organes du moteur.
- Tout au long du montage de la pompe, la propreté est d'une extrême importance. En général, la conduite d'aspiration d'huile n'est équipée que d'un crible grossier. Après la réparation, les impuretés ou particules métalliques restant dans le moteur peuvent pénétrer sans difficulté à l'intérieur de la nouvelle pompe et provoquer une nouvelle usure prématurée. Pour cette raison, tous les organes, canaux et conduites d'aspiration en relation directe avec l'huile doivent être si possible correctement nettoyés.
- Au montage d'une nouvelle pompe à huile, le filtre à huile doit toujours être changé. Si c'est tout le système de pression d'huile qui est fortement encrassé, il doit être entièrement soumis à un nettoyage.
- Avant le montage de la nouvelle pompe, elle doit être comparée à la géométrie de l'ancienne pompe.
- L'entraînement de la pompe (dentes, clavetages, roues à chaînes et courroies) doit être contrôlé à la recherche d'éventuels dégâts.
- Avant le montage de la pompe, tous les organes mobiles de la pompe (engrenages, arbres) doivent être graissés avec l'huile de moteur prescrite.
- Au montage, il faut veiller au bon positionnement de la pompe. En cas de difficultés au montage (problème de disposition, inclinaison) la pompe ne doit, pas être disposée sur le dispositif en forçant sur les vis du boîtier. Ceci peut provoquer une détérioration de la pompe, des pannes de fonctionnement ou des fuites d'huile.
- Les joints et les bagues d'étanchéité doivent toujours être changés au montage de la pompe et de la conduite d'aspiration d'huile. En général, l'utilisation d'une pâte d'étanchéité doit être évitée. Celle-ci ne peut être employée et utilisée qu'aux endroits prévus par le constructeur du moteur.
- Les vis de fixation de la pompe doivent être vissées au couple imposé par le constructeur du moteur ainsi que dans le bon ordre.
- Si des arrêts de vis liquides ou mécaniques sont prescrits, ils doivent être utilisés conformément aux prescriptions du fabricant du moteur.
- Avant que le moteur ne soit remis en route, il est conseillé de remplir le système de circulation d'huile par un réservoir de pression séparé. (système d'engagement par pression). Le côté pression du système de circulation d'huile est ainsi complètement rempli d'huile et purgé d'air. Normalement, on remplit le système jusqu'à ce que l'huile atteigne la partie la plus haute du moteur ou les points de lubrification les plus éloignés de la pompe. L'huile doit aller jusqu'à sortir des culbuteurs ou des coussinets de l'arbre à cames.
- De cette manière, les dégâts dus à un manque de pression d'huile au démarrage du moteur peuvent être évités.
- Après la „mise sous pression“ du système de circulation d'huile, le moteur est rempli d'huile jusqu'au niveau de jauge prescrit.
- Au premier démarrage après l'échange de la pompe, la pression d'huile du moteur doit être atteinte en quelques secondes. Si ce n'est pas le cas, le processus de démarrage doit être interrompu et le moteur coupé afin de détecter les causes de la panne. Il ne faut en aucun cas augmenter le régime du moteur pour essayer d'accélérer la montée de la pression d'huile.
- Les huiles utilisées doivent être prescrites et homologuées par le constructeur du moteur.
- L'entretien du moteur doit être fait conformément aux prescriptions du constructeur du moteur.

2.2.6. Détection des causes / Diagnostic des dégâts

Le système de lubrification et toute la partie mécanique du moteur sont constitués d'un grand nombre d'éléments fixes et mobiles. Chaque composant est impliqué, que ce soit spécifiquement ou en corrélation avec d'autres organes. C'est pourquoi les problèmes d'alimentation en huile

peuvent avoir les causes les plus diverses. En cas de panne d'un seul élément de la construction, c'est souvent tout le système de lubrification qui en subit les répercussions. Si le problème n'est pas écarté suffisamment tôt ou est même ignoré, tous les organes en relation en

souffrent également. Il arrive souvent qu'une petite cause engendre la détérioration totale du moteur. Avant d'envisager le changement de la pompe à huile, les points suivants doivent être contrôlés et les causes de dégâts possibles également écartées.

■ Causes d'une pression d'huile trop faible ou inexistante

- Niveau d'huile trop bas
- Viscosité de l'huile trop basse (trop liquide)
- Formation d'une mousse d'huile dans le carter du vilebrequin dû à un niveau d'huile trop élevé ou à l'utilisation d'une huile incorrecte avec de mauvais additifs ou encore à de l'huile encrassée
- Crible de la conduite d'aspiration d'huile bouché
- Conduite d'aspiration d'huile mal étanchée (c'est de l'air qui est aspiré)
- Soupape de limitation de pression d'huile bloquée (souvent en position ouverte)
- Filtre à huile bouché
- Canalisations, conduites ou radiateur d'huile bouchés
- Injecteur d'huile cassé ou restant ouvert (refroidissement injecté dans le piston)
- Capuchons manquants ou tombés des canalisations de pression d'huile au niveau du bloc moteur, de la culasse ou du vilebrequin
- Coussinets usés sur le vilebrequin, l'arbre à cames, l'arbre du compensateur ou sur les culbuteurs
- Éléments usés ou défectueux tels que les poussoirs hydrauliques, les turbos, les pompes à injection ou les pompes à carburant à haute pression
- Défauts d'étanchéité sur les surfaces du moteur

■ Causes d'une pression d'huile trop élevée

(en règle générale, il ne s'agit pas d'une panne de la pompe à huile)

- Viscosité de l'huile trop élevée (trop épaisse)
- Soupape de limitation de pression d'huile qui ne travaille pas (reste fermée)
- Filtre à huile bouché
- Conduite de pression d'huile bouchée
- Par mégarde, une pompe à trop haut débit a été installée

ES FUNDAMENTOS



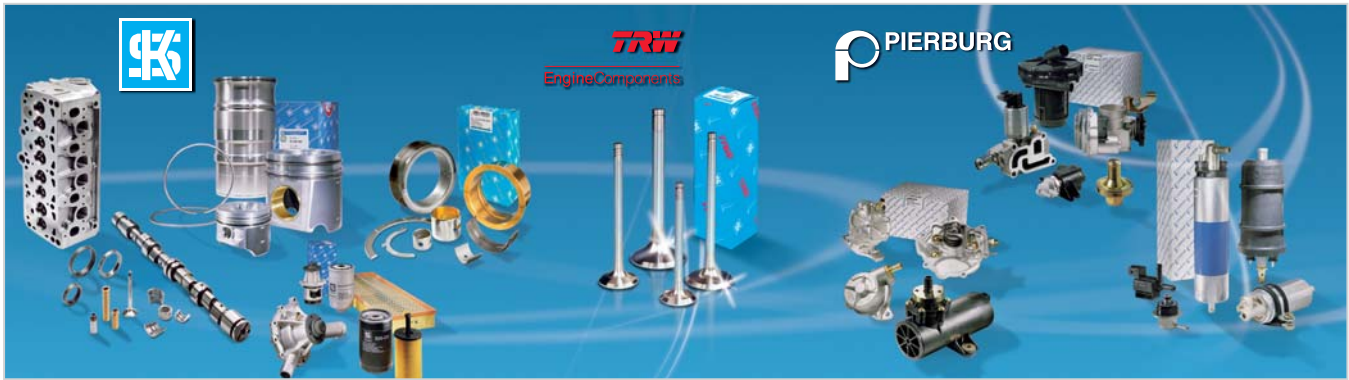

MS Motor Service International GmbH es la organización distribuidora para las actividades mundiales de posventa de la compañía Kolbenschmidt Pierburg AG. Somos una proveedora líder en materia de componentes para motores en el mercado libre de repuestos ofreciendo las marcas de primera KOLBEN-SCHMIDT, PIERBURG y TRW Engine Components. Nuestra amplia y detallada gama de productos hace que los clientes puedan adquirir las piezas motrices de

Nota importante

Par la suite, MS Motor Service International GmbH est abrégée par MSI.

Las informaciones y datos recogidos en este catálogo no son vinculantes aunque hayan sido elaborados conscientemente. Todas las reclamaciones de indemnización relacionada con ellos están excluidas. No respondemos de las modificaciones hechas a nuestros productos o a sus designaciones por los fabricantes de automóviles o motores. En caso de duda, diríjase a nuestro departamento técnico de posventa. Cualquier notificación de errores será bienvenida a fin de corregirlos para las versiones posteriores. Las denominaciones, descripciones y números de los automóviles o fabricantes etc. que aparecen en este catálogo, sólo tienen un fin comparativo. Las piezas mencionadas en el catálogo son repuestos cuya calidad corresponde a la de KS.

un solo proveedor.

Solucionamos los problemas del comercio y de los talleres y ofrecemos, además, un amplio paquete de servicios y la competencia técnica propia de una filial de una gran

Las representaciones, dibujos esquemáticos y otros datos explican e ilustran nuestros productos y no se pueden tomar, en ningún caso, como base para la instalación de piezas ni para definir el alcance de suministro o el diseño. Esto vale también para los datos del fabricante.

Las referencias para los repuestos originales utilizadas por los fabricantes de automóviles y motores que aparecen en el presente catálogo se entienden únicamente a título de comparación. Ellas no son designaciones de procedencia ni deben utilizarse frente a terceros. Por lo tanto, no respondemos del contenido de las listas comparativas, sobre todo por los cambios que podrían efectuar eventualmente los fabricantes y/o por dimensiones diferentes que ellos podrían mencionar. La información y los datos de los artículos no fabricados por MSI contenidos

provee-dora de la industria automotriz.

El grupo Kolbenschmidt Pierburg Siendo asociados de los fabricantes de automóviles desde muchos años, las empresas del grupo Kolbenschmidt Pierburg desarrollan componentes innovadores y soluciones de sistema y gozan de una competencia reconocida en las áreas de alimentación de aire y reducción de contaminantes, bombas de aceite, de agua y de vacío, pistones, bloques de motor y

en este catálogo proceden de sus fabricantes. No nos responsabilizamos de su exactitud ni de que los productos sean idóneos para la finalidad prevista. En todo caso, antes de efectuar el montaje contáctese con el fabricante o con uno de sus concesionarios oficiales para que le suministren la información necesaria. Las piezas ofrecidas en el catálogo no están destinadas al uso en aviones o helicópteros. En el caso de usarlas en motores marinos, quizá sea necesario montar piezas motrices diferentes (p.ej., pistones) en motores con códigos iguales. Las copias o reproducciones integrales o parciales realizadas sin nuestro consentimiento escrito y sin indicación de la fuente son ilícitas. La presente versión sustituye y anula todas las versiones anteriores. Nos reservamos el derecho a efectuar modificaciones sin previo aviso.

Nos reservamos el derecho de hacer cambios.

Usted encontrará valiosas informaciones técnicas en

Servicio
Sugerencias & informaciones

Estos prospectos también pueden verse en nuestra página web www.ms-motor-service.com



Índice	Página
Nota importante	50
Declaración de garantía	51
1. Indicaciones para la utilización	52
2. Informaciones técnicas sobre el producto	54
2.1 Bombas de agua	54
2.1.1 Circuito de refrigeración.....	54
2.1.2 Componentes de una bomba de agua.....	55
2.1.3 Tipos de construcción	56
2.1.4 Tabla técnica	57
2.1.5 Recomendación importante.....	58
2.1.6 Averías.....	58
2.2 Bombas de aceite	59
2.2.1 Lubricación del motor	59
2.2.2 Sistemas de lubricación para motores	60
2.2.3 Tipos de construcción y modelo de bombas.....	61
2.2.4 Tipos de motores para bombas de aceite.....	62
2.2.5 Indicaciones generales para el montaje	63
2.2.6 Averiguación de causas / diagnóstico de daños.....	64
3. Aplicaciones principales/ Ilustraciones de producto	81
4. Adiciones al programa	163
5. Lista de fabricantes	167
6. Programa de productos	171
7. Lista de comparación	1271
8. Formulario “Quality Information Report”	
9. Condiciones de venta y entrega	

Gestión de calidad

Nuestros productos destacan por su alta precisión conseguida gracias al desarrollo profesional de productos y procesos, modernos métodos de fabricación y amplios controles. Nuestro sistema de gestión de calidad está certificado según DIN EN ISO 9001 e ISO/TS 16949 y lo complementamos y perfeccionamos constantemente. Si el material o la fabricación de alguno de nuestros productos fueran defectuosos, a pesar de los controles efectuados durante el proceso de producción y del riguroso control final de calidad, nos encargaremos de reacondicionar el motor o de sustituir el producto afectado dentro del período de prescripción . Las reclamaciones se nos deben comunicar





por escrito dentro de un plazo de 30 días contados a partir de la fecha en que fue detectado el defecto. El período de prescripción para reclamaciones por defectos es de 24 meses contados desde la fecha de entrega del producto. Las reclamaciones por defectos están excluidas si el producto ha sido modificado por terceros o se ha incorporado piezas procedentes de terceros, salvo que no haya una relación causal entre el defecto y la modificación efectuada. Lo mismo vale para productos manipulados o instalados en desacuerdo con las instrucciones facilitadas. Nuestra garantía no cubre el desgaste normal ni los daños resultantes de usos inadecuados.



1. Indicaciones para la utilización del catálogo

Indices de motores

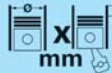
Ofrecemos una ayuda detallada para búsquedas al principio de la mención de cada fabricante.. Las designaciones de los motores están clasificadas en orden ascendente alfanumérico.

		INDEX								
		Cyl.	 mm	cm ³		Comp. Ratio ϵ	kW	PS	Pos	
A 6 M 816	D (AN)	6	142 x 160	15204	2	16:1	145-172	197-234	45	
A 6 M 816 R	D (LA)	6	142 x 160	15204	2	16:1			45	
A 6 M 816 U	D (LA)	6	142 x 160	15204	2	16:1			45	
A 6 M 816 W	D (LA)	6	142 x 160	15204	2	16:1			45	
A 8 M 816	D (A)	8	142 x 160	20272	2	16:1	190-230	259-313	45	
A 8 M 816 C	D (LA)	8	142 x 160	20272	2	16:1			45	
A 8 M 816 CR	D (LA)	8	142 x 160	20272	2	16:1			45	
A 8 M 816 R	D (LA)	8	142 x 160	20272	2	16:1			45	
A 8 M 816 U	D (LA)	8	142 x 160	20272	2	16:1			45	
A 8 M 816 W	D (LA)	8	142 x 160	20272	2	16:1			45	
A 12 M 816	D (A)	12	142 x 160	30438	2	16:1	162-321	220-436	45	
A 12 M 816 C	D (LA)	12	142 x 160	30438	2	16:1			45	
A 12 M 816 CR	D (LA)	12	142 x 160	30438	2	16:1			45	
A 12 M 816 R	D (LA)	12	142 x 160	30438	2	16:1			45	
A 12 M 816 U	D (LA)	12	142 x 160	30438	2	16:1			45	
A 12 M 816 W	D (LA)	12	142 x 160	30438	2	16:1			45	
A 16 M 816	D (A)	16	142 x 160	40544	2	16:1	216-427	295-581	45	









Tipo de combustible
B = gasolina | D = diesel | G = gas

Tipo de sobrealimentación
A = sobrealimentación
AN = motor aspirante
K = compresor
LA = aire de sobrealimentación refrigerado

Número de posición

Datos relativos de los productos

Las páginas del catálogo están formadas por bloques de información, tal como aparecen a continuación:

Año de construcción, desde → hasta		Modelo		Designación del motor		Línea para fabricar tes	
 Fabricante							
							
Golf II 1.8						75	
08.1983→07.1993		EX, GU, GZ, HT, HV, JH, KT, RG, RH, RV, 1P, 2H				Número de posición	
Reference		026 121 005 A	026 121 005 C	026 121 005 E	026 121 005 G	50 005 148	
		026 121 005 H	037 121 005 B	037 121 005 C	068 121 005 A		
		95 VW 8503 AA					
		ohne Gegengehäuse/ without backhousing/ sans demi-corps/ sin remate					
08.1983→07.1993		EX, GU, GZ, HT, HV, RG, RH, RV				Número de posición	
Reference		027 115 105	027 115 105 E	049 115 105 A	055 115 105 D	50 005 808	
Número de referencia		Observaciones		N° de Ref. para bombas de agua		N° de Ref. para bombas de aceite	
						Número de posición	

2. Informaciones técnicas sobre el producto

2.1 Bombas de agua

2.1.1 Circuito de refrigeración

El sistema de refrigeración funciona en circuito cerrado. Su función consiste en asegurar el equilibrio térmico en el motor, ya que sólo con temperaturas óptimas se consiguen condiciones de funcionamiento óptimas en el motor, es decir: alto rendimiento y combustión completa, lo que a su vez reduce las emisiones.

Como líquido refrigerante se utiliza en el circuito una mezcla de agua y un producto anticongelante y anti-

corrosivo recomendado generalmente por el fabricante. El punto de ebullición de esta mezcla es superior al del agua, por lo que a una sobrepresión de 1,4 bares, la temperatura del líquido refrigerante puede ascender hasta 120°C. El termostato regula el circuito de refrigeración en función de la temperatura del líquido refrigerante. Con el motor frío, permanece sin activarse para que pueda alcanzar lo más rápidamente posible la temperatura de servicio del motor

(circuito pequeño de refrigeración). Sólo a partir de una temperatura determinada, el termostato se activa, abriendo el circuito grande de refrigeración que incluye el radiador.

La bomba de agua accionada a través de una correa asegura la circulación del líquido refrigerante y lo transporta, tras activación del termostato, del motor al radiador. El líquido refrigerante caliente lo enfría el aire que recibe el radiador cuando el automóvil se desplaza, y, adicionalmente, por el aire aspirado

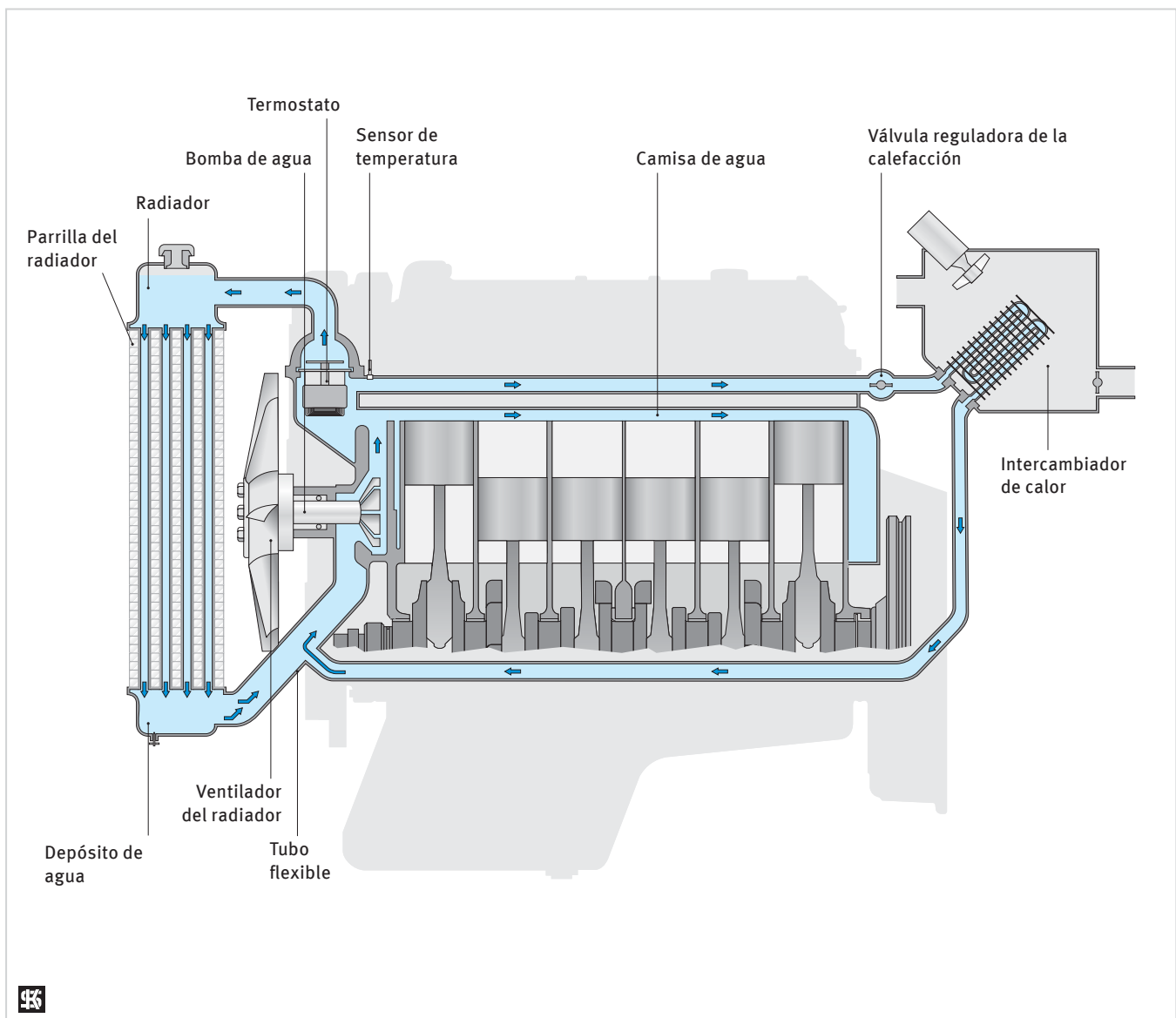

ESPAÑOL

2.1.2 Componentes de una bomba de agua

El elemento central de una bomba de líquido refrigerante para motores de automóviles es la rueda de álabes o rotor que, según el tipo, puede tener un número variable de álabes, de forma recta o curvada, montadas radial o tangencialmente. La configuración y las dimensiones de la rueda de álabes determinan en gran parte la potencia de la bomba de agua. Otros componentes son el eje motor y el cojinete que forman casi siempre una unidad lista para el montaje. El eje motor lleva, en el lado de descarga, la rueda de álabes y, en el

lado de accionamiento, una brida o polea. El cuerpo de la bomba está fabricado en aluminio o fundición de hierro y tiene, según el tipo de bomba, diversos elementos conexos, tales como los elementos de sujeción para los tubos flexibles, los termostatos, tapones, etc. El cuerpo de bomba tiene, además, un taladro de fugas que sirve para control. El retén del eje asegura la estanqueidad entre cuerpo y eje motor: de su buen funcionamiento depende esencialmente la vida útil

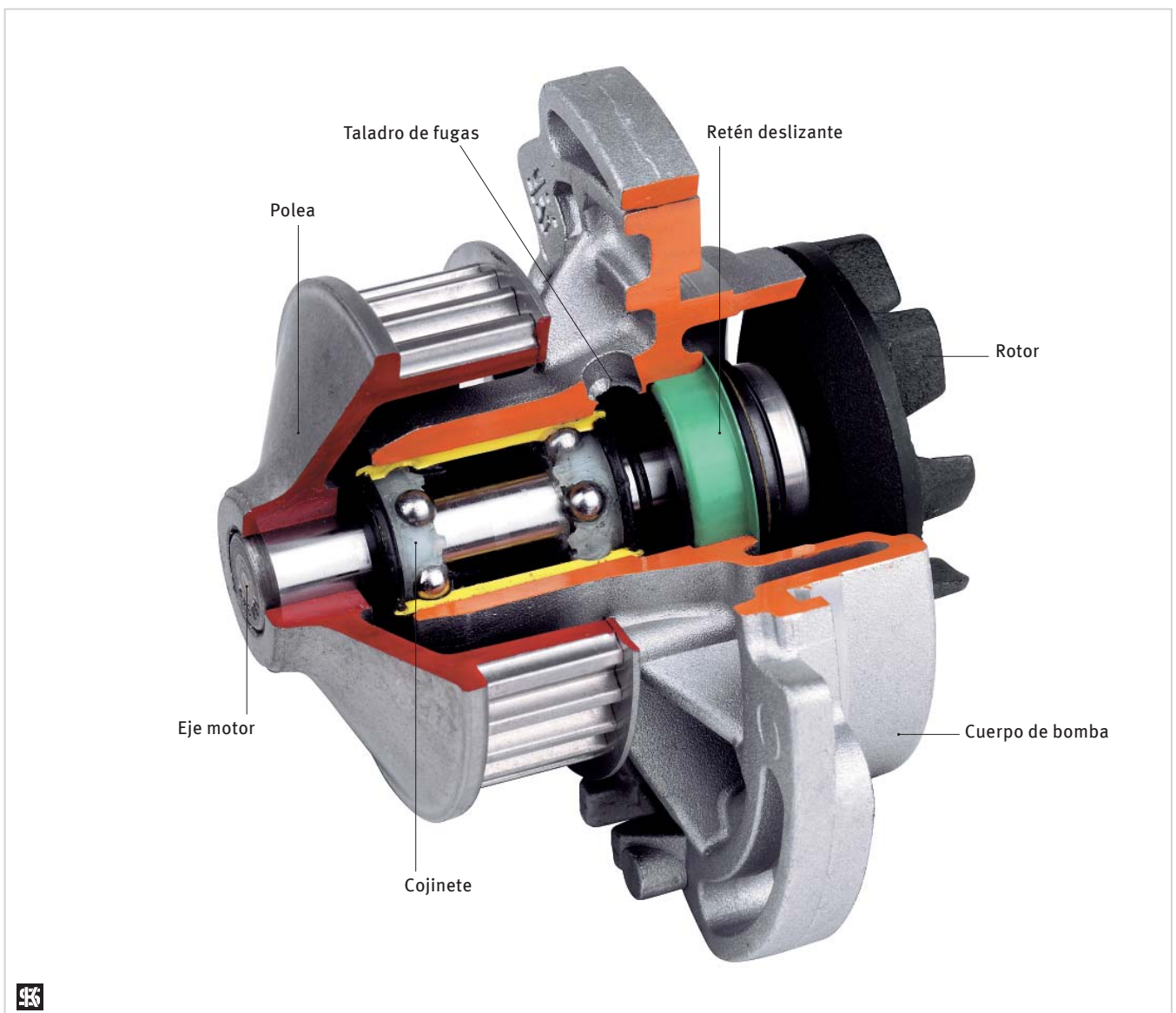

2.1.3 Tipos de construcción

Las bombas de agua varían sobremanera en cuanto al tipo de construcción y, por consiguiente, en cuanto a su aspecto exterior. La configuración del cuerpo y el tipo de accionamiento son las dos características distintivas más destacadas:

Tipo de accionamiento

La bomba de agua es accionada por el motor a través de una correa que puede ser la correa de distribución

correspondiente al sistema de accionamiento del árbol de levas o la correa trapezoidal o acanalada

que viene del cigüeñal. Si la polea no forma parte de la bomba, hay que atornillarla a la brida del eje motor.



accionamiento por correa de distribución



accionamiento por correa trapezoidal



bomba sin polea

Configuración del cuerpo de la bomba

Las bombas de agua pueden ser abiertas o cerradas. En el caso de las bombas abiertas hay una zona de acoplamiento en el motor en

donde está fijada la bomba mediante un retén y una junta plana que se encargan de la estanqueidad. El remate del cuerpo de bomba forma parte del

motor. En cambio, las bombas cerradas constituyen una unidad en sí con una placa o tapa que cierra y estanca el cuerpo de bomba. una placa o tapa que cierra y estanca



Bomba con brida de fijación



Bomba con carcasa

2.1.4 Tabla técnica

Varios tipos de averías pueden afectar el sistema de refrigeración. En la

tabla siguiente están recopilados los principales problemas, sus causas y

las medidas para medidas para solucionarlos.

Síntoma	Causa posible	Remedio
Sobrecalentamiento	cantidad insuficiente de líquido refrigerante	Añadir líquido en el circuito de refrigeración
	condensador del aire acondicionado obstruido	limpiar y, eventualmente, sustituir el condensador
	parrilla del radiador obstruida	limpiar y/ o sustituir el radiador
	termostato no responde	controlar y/ o sustituir el termostato
	circulación del líquido refrigerante impedida	limpiar y lavar el sistema de refrigeración
	avería en la bomba de agua	sustituir la bomba de agua
	avería en el embrague del ventilador	sustituir el embrague del ventilador
	avería en el ventilador del radiador	controlar el ventilador y su motor
	avería en el relé del ventilador	controlar el relé del ventilador
	correa de accionamiento se desliza/ está rota	tender/ sustituir la correa de accionamiento
Corrosión	impurezas en el líquido de refrigeración	limpiar el sistema refrigerante, lavar y rellenar
Pérdida de líquido refrigerante	manguera dañada	sustituir la manguera
	bomba de agua tiene fugas	sustituir la bomba de agua
	parrilla del radiador defectuosa	reparar y/ o sustituir el radiador
	tapa del termostato defectuosa	sustituir la tapa del termostato
	avería en la culata	controlar la culata y la junta de culata
	tapón en el sistema refrigerante tiene fugas	sustituir el tapón
Calefacción no funciona	manguera de calefacción defectuosa	sustituir la manguera de calefacción
	intercambiador de calor obstruido	limpiar o sustituir el intercambiador
	termostato defectuoso	sustituir el termostato



■ Montaje de bombas de agua

Siga las recomendaciones generales para el montaje y el manual de instrucciones que se encuentra en el embalaje a fin de que su nueva bomba de agua KS sea instalada correctamente en el vehículo pertinente.

2.1.5 Recomendación importante

Es indispensable hacer un mantenimiento correcto al sistema de refrigerante para que el motor funcione bien. Hay que revisar y cambiar eventualmente ciertas piezas importantes para el circuito de enfriamiento como la correa de distribución, los rodillos tensores, el termos-

tato, las mangueras y las pinzas cuando se monte una nueva bomba de agua KS.

No se debe llenar agua limpia en el sistema de enfriamiento. El agente refrigerante prescrito por el fabricante del automóvil contiene inhibidores con efecto anticorrosivo que

impiden que se dañe la bomba y las demás piezas del circuito.

Los diferentes agentes refrigerantes no deben ser mezclados porque son incompatibles. Los agentes refrigerantes de baja calidad pueden dañar el sistema y dejarlo enteramente inutilizable.

2.1.6 Averías

Cuadro clínico	Causa probable	Ayuda
Agua de condensación en el agujero de derrame	Derrame nominal	Tiempo de rodaje de la junta del segmento de deslizamiento corresponde a 1 - 3 horas
Fuga de agente refrigerante en el agujero de derrame	Sistema de enfriamiento corroído Funcionamiento con agua limpia (sin aditivo refrigerante)	Limpiar el sistema de enfriamiento Rellenar agente refrigerante
Corrosión en la superficie de rodadura de la rueda de aletas	Segmento de deslizamiento dañado químicamente por agente refrigerante sucio	Limpiar el sistema de enfriamiento Rellenar agente refrigerante
Corrosión cavitación en el agujero de la rueda de aletas, del cárter o del eje	Temperatura muy alta, refrigerante usado o erróneo	Cambiar el agente refrigerante de la manera prescrita, controlar las temperaturas de servicio del sistema refrigerante (control del radiador, termostato, ventilador)
Guía lateral suelta de la rueda de accionamiento (discos de arranque)	Juego de la correa de mando no está ok, mal montaje de los rodillos guía y del tensor de la correa	Corregir la alineación o cambiar la correa
Sistema de enfriamiento totalmente corroído	Junta de culata defectuosa, refrigerante erróneo o usado	Cambiar la junta de la culata Limpiar el sistema de enfriamiento
Fuga de agua en las tubuladuras de empalme para la manguera y la junta del cárter	Junta suministrada sin instalar; mal tratamiento de la masa para la junta.	Colocar siempre la junta; usar la masa para la junta de acuerdo de la manera prescrita
Perfil dentado de la rueda de accionamiento desgastado; fricción de la goma de la correa de distribución	Correa demasiado tensada	Cambiar la correa y montar la nueva de acuerdo con las instrucciones del fabricante
Rotura por fatiga del cojinete de la bomba de agua	Vibraciones y desequilibrio por daños del acoplamiento del ventilador o de los rodillos tensores, tensión muy elevada de la correa de mando	Cambiar la boma de agua y las piezas defectuosas

2.2 Bombas de aceite

2.2.1 Lubricación del motor

El sistema lubricador cumple la función de alimentar las piezas motrices con suficiente aceite. Se trata de un sistema cerrado dentro del cual el aceite se encarga de realizar numero-sas tareas:

- Lubricación de todas las piezas deslizantes
- Enfriamiento de las piezas motrices - Protección contra sobrecalentamiento
- Evacuación de sedimentos, residuos de combustión y carbonilla
- Protección anticorrosiva
- Atenuación de ruidos y vibraciones
- Hermetización finísima (p.ej., de los segmentos de los pistones)
- Transmisión de fuerza

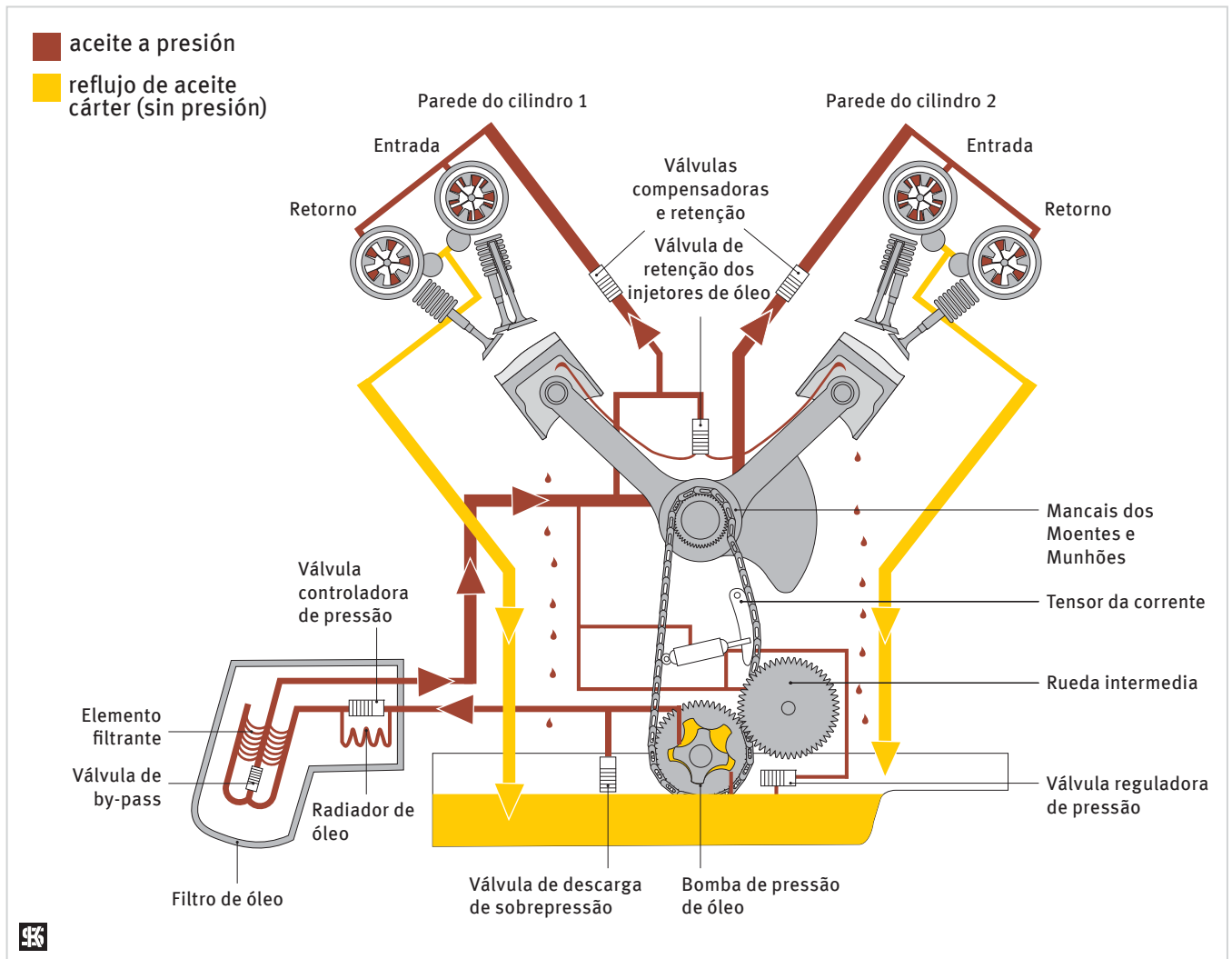

Circulación del aceite

2.2.2 Sistemas de lubricación para motores

Hay dos sistemas diferentes para lubricar los motores con aceite:

- Lubricación con alta presión en circuito cerrado
- Lubricación por cárter seco

Lubricación con alta presión en circuito cerrado

Con este tipo de lubricación – empleada por casi todos los motores de cuatro tiempos – el aceite llega a los sitios correspondientes a través de tuberías o canales valiéndose de una bomba.

Tanto los elementos hidráulicos para compensar las válvulas (taqués hidráulicos), el balancín, las cadenas de distribución, el tensor de dichas cadenas y los pistones, reciben suficiente aceite lubricante, además de los diferentes lugares destinados al apoyo de los árboles.

Entre la bomba y los lugares que necesitan lubricación hay varios tipos de filtros bastos, finos y finísimos para depurar el aceite. Para enfriar el aceite se emplean a menudo dispositivos por los que circula aire o agua.

La válvula limitadora correspondiente se encarga de evitar que la presión ascienda demasiado, fenómeno que suele producirse sobre todo durante la fase de arranque en

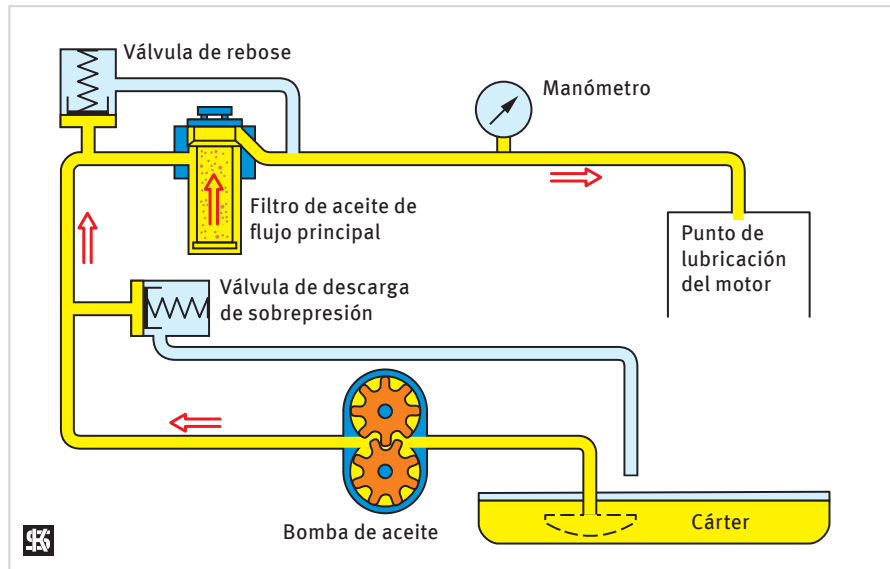

Lubricación con alta presión en circuito cerrado

pase al cárter de aceite.

frío pero también cuando el motor funciona con revoluciones elevadas. Dicha válvula está ubicada en el lado de presión cercano a la bomba o incorporada directamente en la caja de la bomba permitiendo de este modo que la presión excesiva

Lubricación por cárter seco

Esta lubricación es un tipo especial de la de alta presión en circuito cerrado. La particularidad de este sistema reside en que una bomba especial succiona el aceite expulsado del motor y lo impulsa desde el cárter hacia un recipiente separado

para reserva de lubricante. La bomba de elevadora de presión impulsa el aceite del motor desde ese recipiente y lo conduce a los lugares pertinentes. La ventaja de esta construcción es que siempre habrá suficiente alimentación de aceite a pesar de una

posición extremadamente inclinada o cuando se produzcan fuerzas centrífugas. Por ese motivo se emplea con frecuencia esa técnica en la construcción de todoterrenos o en automóviles de carrera.

2.2.3 Tipos de construcción y modelos de bombas

Las bombas de aceite difieren bastante en cuanto a construcción y aspecto. Las características principales más llamativas que las diferencian son el principio de bombeo, el tipo de accionamiento y el modelo de la caja.

Los principios diferentes empleados por las bombas dependen de la finalidad, el lugar de montaje y la capacidad volumétrica.

Las construcciones más frecuentes son:

- Bombas de engranajes dentados
- Bombas de tambor en media luna
- Bombas de rotor

■ Bombas de engranajes dentados

En este caso la rotación de los dos engranajes situados entre los dientes y la pared transportan el aceite. Cuando los dientes del par de engranajes entran unos en los otros, éstos impiden que el aceite vuelva al cárter. Por ese motivo se origina una sobrepresión en un lado y una presión negativa en la parte de succión.

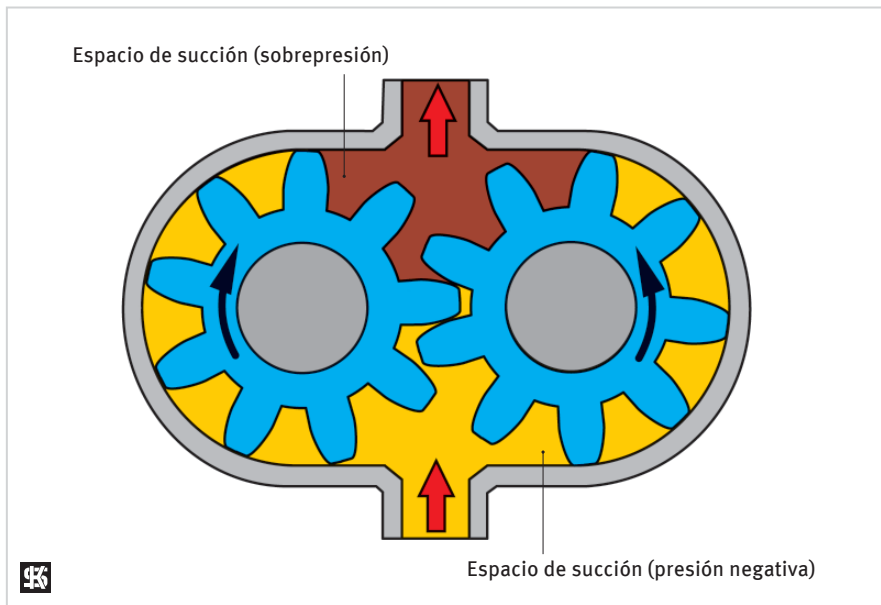

■ Bomba de tambor en media luna

En este caso el engranaje exterior está montado excéntricamente en la caja de la bomba con respecto al engranaje interior. Lo mismo que en el caso de la bomba de engranaje dentado, el aceite fluye también a través de los espacios intermedios de los dientes. La rotación continua de la bomba genera un sector con presión negativa en el lado en que los dientes se separan. Éste es el lado de succión de la bomba. La sobrepresión, por el contrario, se produce en el espacio en que los dientes vuelven a engranar. En ese momento se evacúa el aceite a presión.

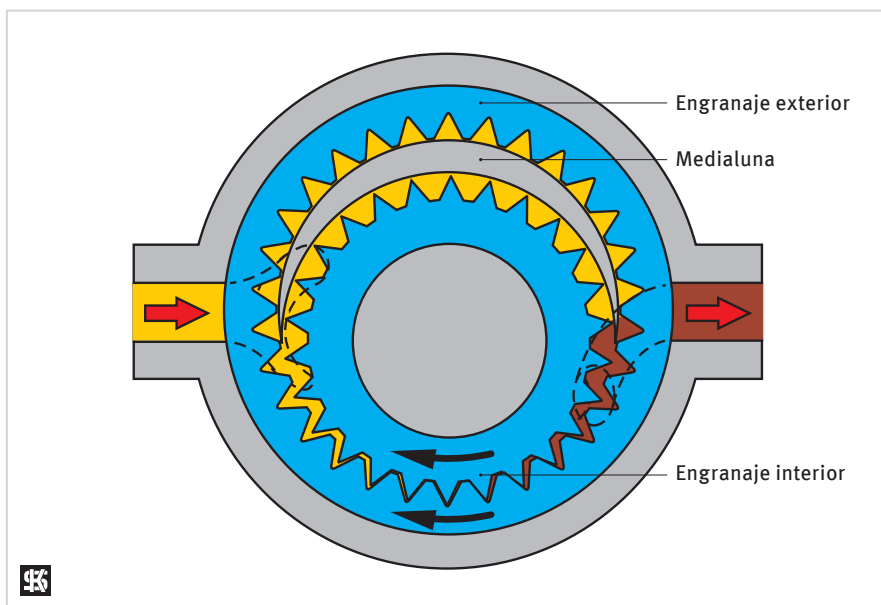

La ventaja de la bomba de tambor en media luna, comparándola con una de engranaje dentado normal, reside en el aumento de la capacidad volumétrica funcionando especialmente con bajas revoluciones.

■ **Bomba de rotor**

Esta bomba está compuesta de un rotor exterior engranado hacia dentro y otro interior engranado hacia fuera. El rotor exterior se mueve sobre los dientes del rotor interior y gira de esa manera dentro de la caja de la bomba. El rotor interior tiene un diente menos que el exterior de modo que el líquido va pasando de un diente del rotor exterior al próximo durante la rotación.

Los espacios aumentan en el lado de succión y se reducen en el lado de presión mientras se efectúa el movimiento giratorio.

Con este tipo de construcción se logra la generación de presiones altas con elevado caudal.

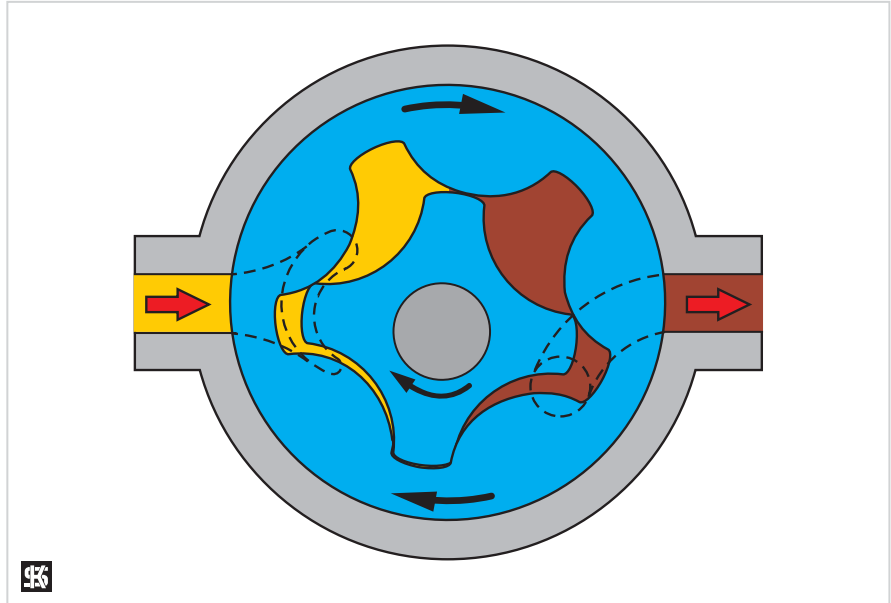

2.2.4 Tipos de motores para bombas de aceite

Las bombas de aceite en general están accionadas directamente por el motor. El accionamiento se produce directamente a través de los engranajes o de las conexiones de enchufe situadas en el cigüeñal o mediante engranajes dentados, cadenas de accionamiento o correas dentadas.



Bomba con accionamiento enchufable



Bomba con accionamiento por rueda dentada

2.2.5 Indicaciones generales para el montaje

Es indispensable acatar en todo caso las instrucciones del fabricante del motor cuando se instale una bomba nueva a fin de que ésta funcione correctamente y tenga una larga vida útil.

Hay que seguir siempre las instrucciones generales mencionadas a continuación:

- Evacúe el aceite usado. Fíjese si hay suciedades en el aceite usado. Los residuos metálicos suelen desgastar mecánicamente los componentes individuales del motor.
- Es imprescindible que el entorno esté limpio antes de montar la bomba. El tubo de aspiración tiene generalmente una sola criba grande. Después de haber efectuado la reparación podrían llegar con facilidad al interior de la bomba nueva las partículas metálicas o de suciedad remanentes en el motor y causar desgastes en breve tiempo. Por ese motivo es conveniente limpiar a fondo todas las piezas relacionadas con el aceite, los canales y el tubo de succión de aceite.
- Cambie siempre el filtro cuando monte una bomba nueva de aceite. Es necesario efectuar una limpieza adicional cuando el sistema de presión de aceite esté demasiado sucio.
- Compare la geometría de la bomba nueva con la antigua antes de montar la nueva.
- Hay que fijarse en que los elementos de accionamiento de la bomba – el engranaje, las uniones por chaveta, las ruedas catalinas, las correas y cadenas de accionamiento – no estén dañados.
- Lubrique todas las piezas móviles de la bomba (engranajes, árboles) con el aceite para motor prescrito antes de montarla.
- Preste atención a que la bomba esté alojada correctamente al efectuar el montaje. No haga fuerza de tornillo para instalar la bomba en la caja cuando se presenten problemas al colocarla o porque queda torcida. El montaje forzado podría ocasionar daños y fugas a la bomba o perturbar sus funciones.
- Use siempre juntas y retenes nuevos al montar la bomba de aceite y el tubo de succión. Evite el uso en general de agentes obturadores líquidos. Dichos agentes tienen que emplearse únicamente en los lugares previstos por el fabricante del motor.
- Apriete los tornillos de fijación de la bomba con el par previsto por el fabricante del motor siguiendo el orden de apriete correspondiente.
- Emplee los aseguramientos líquidos o mecánicos previstos para los tornillos de acuerdo con las instrucciones del fabricante del motor.
- Recomendamos llenar el sistema de aceite con un recipiente de presión por separado (procedimiento de aplicación a presión) antes de encender de nuevo el motor. El lado de presión del sistema de aceite se llenará de aceite y se purgará por completo. El sistema se llenará normalmente hasta que el aceite llegue a los puntos de lubricación del motor más elevados o más alejados de la bomba de aceite. El aceite debería salir entonces a los balancines o a los puntos de apoyo del árbol de leva. Así se evitan los daños por falta de presión de aceite que podrían ocurrir al arrancar el motor.
- Después de haber efectuado el procedimiento de “aplicación a presión” en el sistema de lubricación, el motor se llenará de aceite hasta el nivel prescrito.
- El motor debería generar presión al cabo de unos cuantos segundos al encenderlo por primera vez después de haber cambiado la bomba. Si no se produce presión, hay que interrumpir el proceso de arranque o apagar el motor y solucionar el problema. En todo caso no hay que forzar el motor a fin de acelerar la generación de la presión del aceite.
- Emplee únicamente los aceites prescritos y permitidos por el fabricante del motor.
- Haga el mantenimiento del motor siguiendo las instrucciones del fabricante.

2.2.6 Averiguación de causas / diagnóstico de daños

Tanto el sistema de lubricación como la mecánica del motor están formados por numerosas piezas fijas y móviles. Cada pieza está relacionada específicamente con otros componentes o funciona conjuntamente con ellos. En consecuencia, los problemas

de presión y alimentación de aceite pueden tener varias causas. El sistema de lubricación entero se ve afectado a menudo cuando falla una pieza constructiva. Todas las piezas relacionadas con la dañada se perjudicarán también si se hace caso omiso

del problema o éste no es detectado a tiempo. Es frecuente que de una falla nimia resulten daños funestos para el motor. Verifique y arregle los daños mencionados a continuación antes de cambiar la bomba de aceite.

■ Causas de falta o deficiencia de presión de aceite

- Nivel de aceite demasiado bajo
- Viscosidad del aceite demasiado baja (película muy delgada)
- Formación de espuma en el cárter del cigüeñal a causa de un nivel de aceite muy alto o por emplear uno inadecuado con aditivo erróneo o porque el aceite está sucio
- Criba de succión de aceite obstruida
- Tubo de succión de aceite permeable (sólo aspira aire)
- Válvula reguladora de presión de aceite suspendida (abierta)
- Filtro de aceite obstruido
- Canales de aceite, tuberías flexibles y enfriadores obstruidos
- Inyectores de aceite abiertos o rotos (enfriamiento del pistón por inyección)
- Tapones que falten o se hayan caído en los canales conductores de presión del bloque del motor, de la culata y el cigüeñal
- Cojinetes de fricción del cigüeñal, árboles de levas, árboles compensadores y árboles de balancines desgastados
- Componentes desgastados o defectuosos como el taqué hidráulico, el turbocargador, las bombas de inyección o las bombas de alta presión de combustible
- Superficies permeables en el motor

■ Causas de la elevada presión de aceite

(no se trata por lo general de un defecto en la bomba de aceite)

- Viscosidad del aceite demasiado alta (película muy espesa)
- Válvula reguladora de presión de aceite no funciona (permanece cerrada)
- Filtro de aceite obstruido
- Tubos de presión de aceite obstruidos
- Montaje por descuido de una bomba con una capacidad volumétrica demasiado elevada

RU

ОСНОВЫ





MS Motor Service International GmbH
 это организация по сбыту продуктов концерна KOLBENSCHMIDT PIERBURG AG, активно действующая на мировом рынке обслуживания автомобилей. Мы являемся ведущей фирмой, предлагающей компоненты двигателей для свободного рынка запасных частей известных марок KOLBENSCHMIDT, PIERBURG и TRW Engine Components. Широкий и всеобъемлющий ассортимент обес-

печивает заказчикам возможность получать детали двигателей из одних рук. В качестве решения проблем для торговли и мастерской мы, как дочерняя фирма крупного поставщика автомобильной промышленности, предлагаем, кроме того, обширную гамму услуг и техническую компетенцию.

Kolbenschmidt Pierburg Gruppe
 Как многолетние партнёры производителей автомобилей предприятия группы Kolbenschmidt Pierburg разрабатывают новаторские компоненты и системные решения с признанной компетентностью в области снабжения воздуха и снижения содержания вредных веществ, масляных, водяных и вакуумных насосов, поршней, блоков цилиндров и подшипников скольжения.

Важные примечания

MS Motor Service International GmbH в последующем будет сокращаться как MSI.

Данные продуктов в этом каталоге тщательно проработаны, но не являются для нас обязательными. Мы не гарантируем правильность данных. Мы не можем исключить изменений комплектации со стороны изготовителей автомобилей, а также двигателей или изменений обозначений. В каждом конкретном случае просим навести справки в нашем центре технического обслуживания клиентов. Мы всегда рады сообщениям об ошибках в нашем каталоге и исправим их в следующих изданиях. Наименования, описания или номера автомобилей или изготовителей и т. п. приведены как информация для сравнений. Детали, названные в каталоге, являются запасными частями качества KS, но не подлинными частями. Рисунки, схемы и другие

данные приведены для объяснений и дадут Вам общее представление, однако, они не являются основой для монтажа, объема поставки и конструкции. В особенности это касается данных изготовителей. Данные о номерах подлинных запасных частей изготовителей автомобилей и двигателей служат только для сравнения. Они не говорят о происхождении и не могут применяться по отношению к третьим лицам. Мы не берем на себя никаких гарантий за использование сравнительных данных, прежде всего, из-за возможных изменений и/или различий в размерах того или иного изготовителя. Если этот каталог содержит изделия, которые были изготовлены не MSI, то приводятся сведения об изделии и технические данные соответствующего производителя. Мы не берём на себя ответственность за правильность этих данных и за то, что этот продукт подходит для предполагае-

мого назначения. Для гарантирования ответственности каждый раз перед монтажом необходимо обратиться за профессиональным советом производителя или его мастерской, авторизованной на основании контракта. Детали, предлагающиеся в этом каталоге, не предназначены для использования в летательных аппаратах. При их использовании в корабельных двигателях помните, что, несмотря на идентичные обозначения на двигателях всё же могут подходить другие детали двигателя (например, поршни). Перепечатка, воспроизведение и размножение, в том числе и отдельных частей, возможно только с нашего предварительного письменного согласия и с указанием источника. С появлением нового каталога старый теряет свою силу.

Оставляем за собой право на внесение изменений.

Полезную техническую информацию Вы найдёте в

Сервис
 рекомендации и информация

Эти брошюры Вы можете просмотреть также на нашей домашней страничке в Интернете.

www.ms-motor-service.com



Условия продажи и поставки	Страница
Важные примечания	66
Обеспечение качества	67
1. Указания по использованию каталога.....	68
2. Информация о продукте.....	70
2.1 Водяные насосы	70
2.1.1 Контур системы охлаждения.....	70
2.1.2 Компоненты водяного насоса	71
2.1.3 Типы	72
2.1.4 Технический обзор	73
2.1.5 Важное указание	74
2.1.6 Повреждения	74
2.2 Масляные насосы	75
2.2.1 Смазка двигателя.....	75
2.2.2 Системы смазки двигателя	76
2.2.3 Конструктивные типы и исполнения насосов	77
2.2.4 Виды приводов масляных насосов	78
2.2.5 Общие указания по монтажу.....	79
2.2.6 Выявление причин / Диагностика на предмет повреждений	80
3. Основные применения / Иллюстрации продуктов	81
4. Дополнение к программе	163
5. Перечень производителей	167
6. Производственный ассортимент	171
7. Список для сравнения	1271
8. Формуляр “Quality Information Report”	
9. Условия продажи и поставки	

Обеспечение качества

Наша продукция отличается высокой точностью, которая достигается благодаря профессиональной разработке продукта и технологических процессов, современным технологическим методам и широкому контролю. Наша система обеспечения качества сертифицирована по DIN EN ISO 9001 и ISO/TS 16949 и постоянно совершенствуется.

Если же, несмотря на непрерывно проводимый контроль во время производственного процесса и основательный заключительный контроль, все-таки возникнет дефект материала или изготовления, то мы, само собой разумеется, берем на себя или ремонт двигателя, или замену рекламируемого изделия в течение гарантийного срока.

Рекламации подобного рода необходимо направлять нам письменно в течение 30 дней после обнаружения повреждения.

Срок гарантии на наши изделия составляет 24 месяца, считая с момента поставки изделия. Гарантия теряет силу, если поставленный продукт был изменен третьей стороной или были вмонтированы части иного происхождения, за исключением случаев, когда дефект не связан с такими изменениями. Гарантия также теряет силу, если обращение с деталями или их монтаж осуществлялись не в соответствии с действующими предписаниями. Гарантия не распространяется на естественный износ и повреждение в результате неправильного обращения.



1. Указания по использованию каталога

Индекс двигателей

Каждый изготовитель имеет в начале подробное описание помощи к поиску. Отсортировано по обозначениям двигателей в алфавитно-цифровом порядке возрастания.

		INDEX		DEUTZ					
		Cyl.	mm	cm ³		Comp. Ratio ϵ	kW	PS	Pos
A 6 M 816	D (AN)	6	142 x 160	15204	2	16:1	145-172	197-234	45
A 6 M 816 R	D (LA)	6	142 x 160	15204	2	16:1			45
A 6 M 816 U	D (LA)	6	142 x 160	15204	2	16:1			45
A 6 M 816 W	D (LA)	6	142 x 160	15204	2	16:1			45
A 8 M 816	D (A)	8	142 x 160	20272	2	16:1	190-230	259-313	45
A 8 M 816 C	D (LA)	8	142 x 160	20272	2	16:1			45
A 8 M 816 CR	D (LA)	8	142 x 160	20272	2	16:1			45
A 8 M 816 R	D (LA)	8	142 x 160	20272	2	16:1			45
A 8 M 816 U	D (LA)	8	142 x 160	20272	2	16:1			45
A 8 M 816 W	D (LA)	8	142 x 160	20272	2	16:1			45
A 12 M 816	D (A)	12	142 x 160	30438	2	16:1	162-321	220-436	45
A 12 M 816 C	D (LA)	12	142 x 160	30438	2	16:1			45
A 12 M 816 CR	D (LA)	12	142 x 160	30438	2	16:1			45
A 12 M 816 R	D (LA)	12	142 x 160	30438	2	16:1			45
A 12 M 816 U	D (LA)	12	142 x 160	30438	2	16:1			45
A 12 M 816 W	D (LA)	12	142 x 160	30438	2	16:1			45
A 16 M 816	D (A)	16	142 x 160	40544	2	16:1	216-427	295-581	45

Вид топлива
В = Бензин | D = Дизель | G = Газ

Вид заряда
A = С наддувом
AN = Всасывающее устройство
K = Компрессор
LA = Заряжен устройством охлаждения воздуха

Номер позиции

Данные продукта

Страницы каталога состоят из ниже представленных информационных блоков:

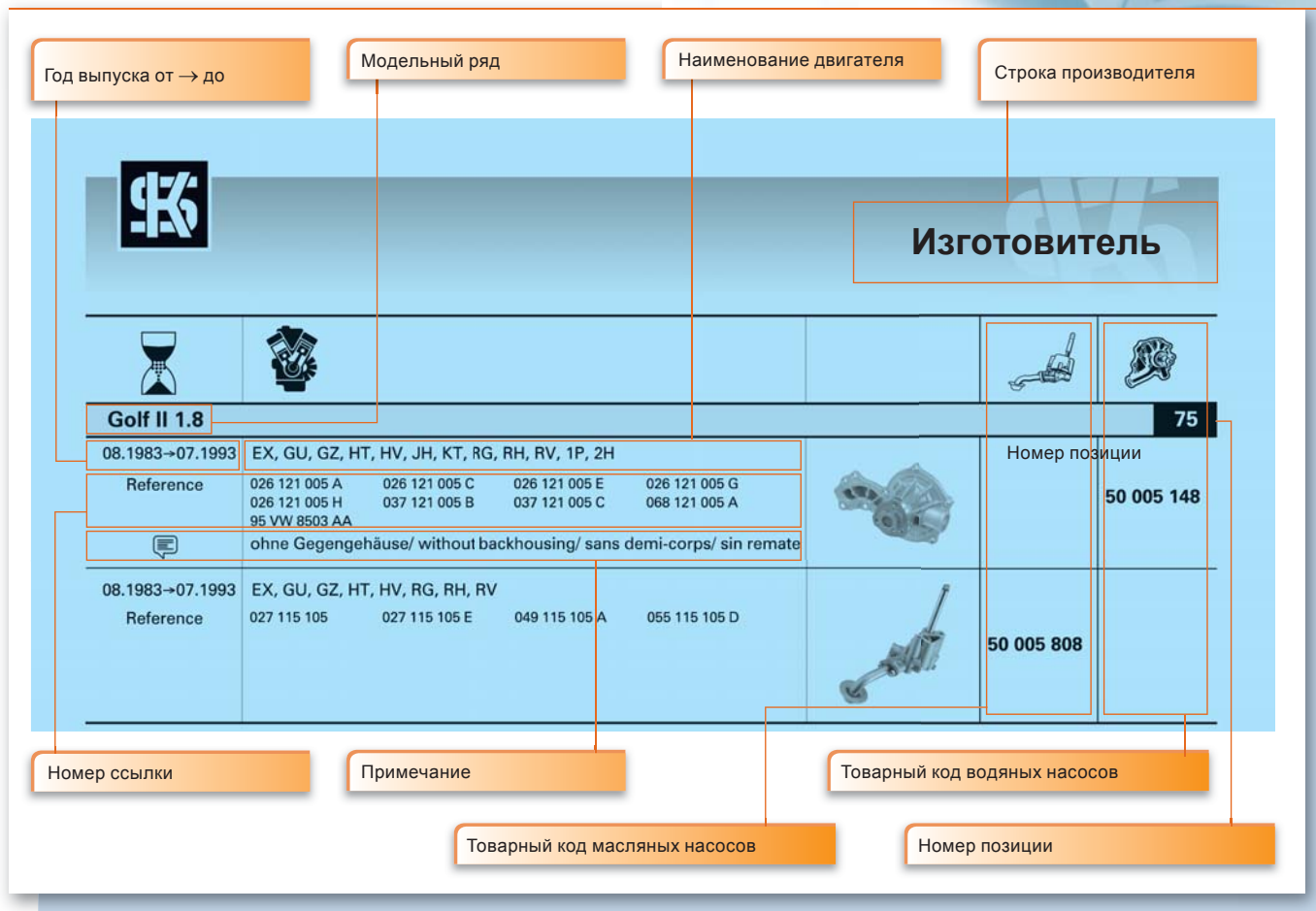

The screenshot shows a catalog entry for a VW Golf II 1.8. The entry is organized into several sections:

- Header:** Includes the manufacturer logo (VW) and the name "Изготовитель".
- Model and Engine:** "Год выпуска от → до" (08.1983→07.1993), "Модельный ряд" (EX, GU, GZ, HT, HV, JH, KT, RG, RH, RV, 1P, 2H), and "Наименование двигателя" (Golf II 1.8).
- Reference Table:**

Reference	026 121 005 A	026 121 005 C	026 121 005 E	026 121 005 G
	026 121 005 H	037 121 005 B	037 121 005 C	068 121 005 A
	95 VW 8503 AA			
- Note:** "ohne Gegengehäuse/ without backhousing/ sans demi-corps/ sin remate".
- Part Numbers:** "Товарный код масляных насосов" (027 115 105, 027 115 105 E, 049 115 105 A, 055 115 105 D) and "Товарный код водяных насосов" (50 005 808).
- Position Number:** "Номер позиции" (75, 50 005 148).

Callouts from the image identify the following elements:

- Год выпуска от → до
- Модельный ряд
- Наименование двигателя
- Строка производителя
- Изготовитель
- Год выпуска от → до
- Модельный ряд
- Наименование двигателя
- Номер ссылки
- Примечание
- Товарный код масляных насосов
- Товарный код водяных насосов
- Номер позиции

2. Информация о продукте

2.1 Водяные насосы

2.1.1 Контур системы охлаждения

Система охлаждения представляет собой закрытый цикл. Задачей этой системы является обеспечение термического равновесия двигателя, поскольку только при оптимальных температурах двигатель имеет оптимальные условия эксплуатации: тогда коэффициент полезного действия высокий и сгорание будет полным, что опять же снижает нагрузку на окружающую среду.

В качестве охлаждающей жидкости в контуре системы охлаждения и в соответствии с заданными изготовителем параметрами исполь-

зуется смесь из чистого антикоррозионного, морозостойкого и водозащитного средства. Точка кипения этой смеси выше, чем воды и позволяет при превышении давления на 1,4 бар иметь температуру до 120°C.

Термостат регулирует контур системы охлаждения в зависимости от температуры жидкости: при холодном двигателе он закрыт, так что рабочая температура достигается по возможности быстро (небольшой контур системы охлаждения); только после определенной температуры он

открывается, а большой контур системы охлаждения закрывается радиатором.

Водяной насос, приводимый в действие ремнем, нагнетает охлаждающее средство и после открытия термостата гарантирует равномерную и быструю подачу охлаждающего средства от двигателя к радиатору, в котором нагретая охлаждающая жидкость охлаждается – либо за счет встречного потока воздуха, либо его вентилятор дополнительно всасывает воздух.

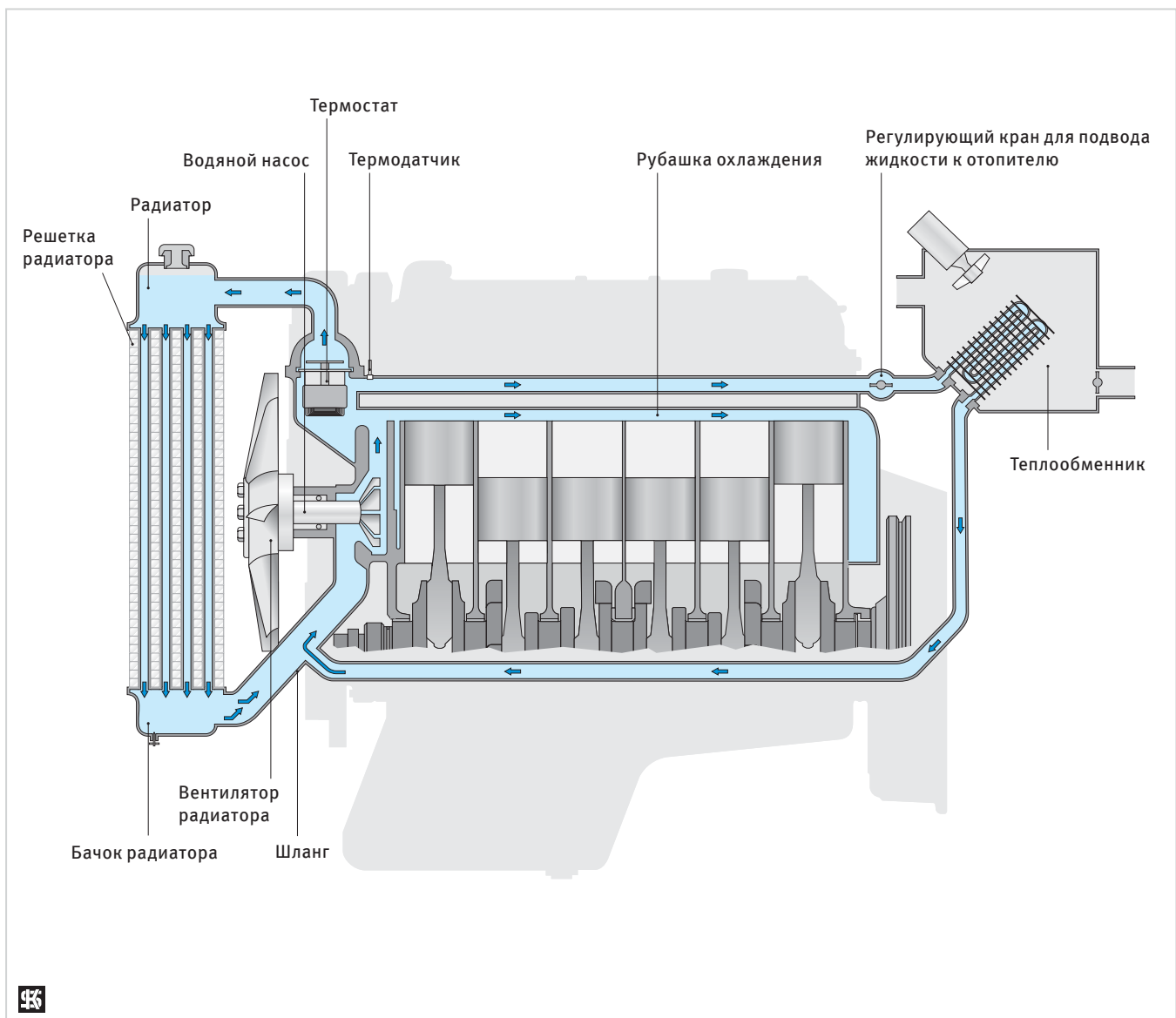

2.1.2 Компоненты водяного насоса

Центральным элементом насоса с охлаждающими средствами для автомобильных двигателей является лопастное колесо, а также ротор или крыльчатка вентилятора. В зависимости от типа может быть много различных лопастей, которые устанавливаются прямо или изогнуто, радиально или тангенциально. Конструкция и размеры крыльчатки вентилятора соизмеримо определяют эффективную мощность водяного насоса. Другими компонентами являются приводной вал и подшипники, которые у водяных насосов почти всегда образуют готовый монтажный узел.

На подающей стороне подшипниковый вал принимает лопастное колесо, а на стороне привода укреплены фланец или шкив. Корпус насоса из алюминиевой или железной отливки. На нем в зависимости от типа насоса крепятся такие различные навесные элементы, как, например, стягивающие хомуты для шлангов, термостаты, пробки и т. д.. Кроме того, у корпуса насоса есть отверстие для утечки, служащее для контроля.

Уплотнение вала, служащее для уплотнения между корпусом и валом подшипника: от его функциональности существенно зависит срок службы водяного насоса.

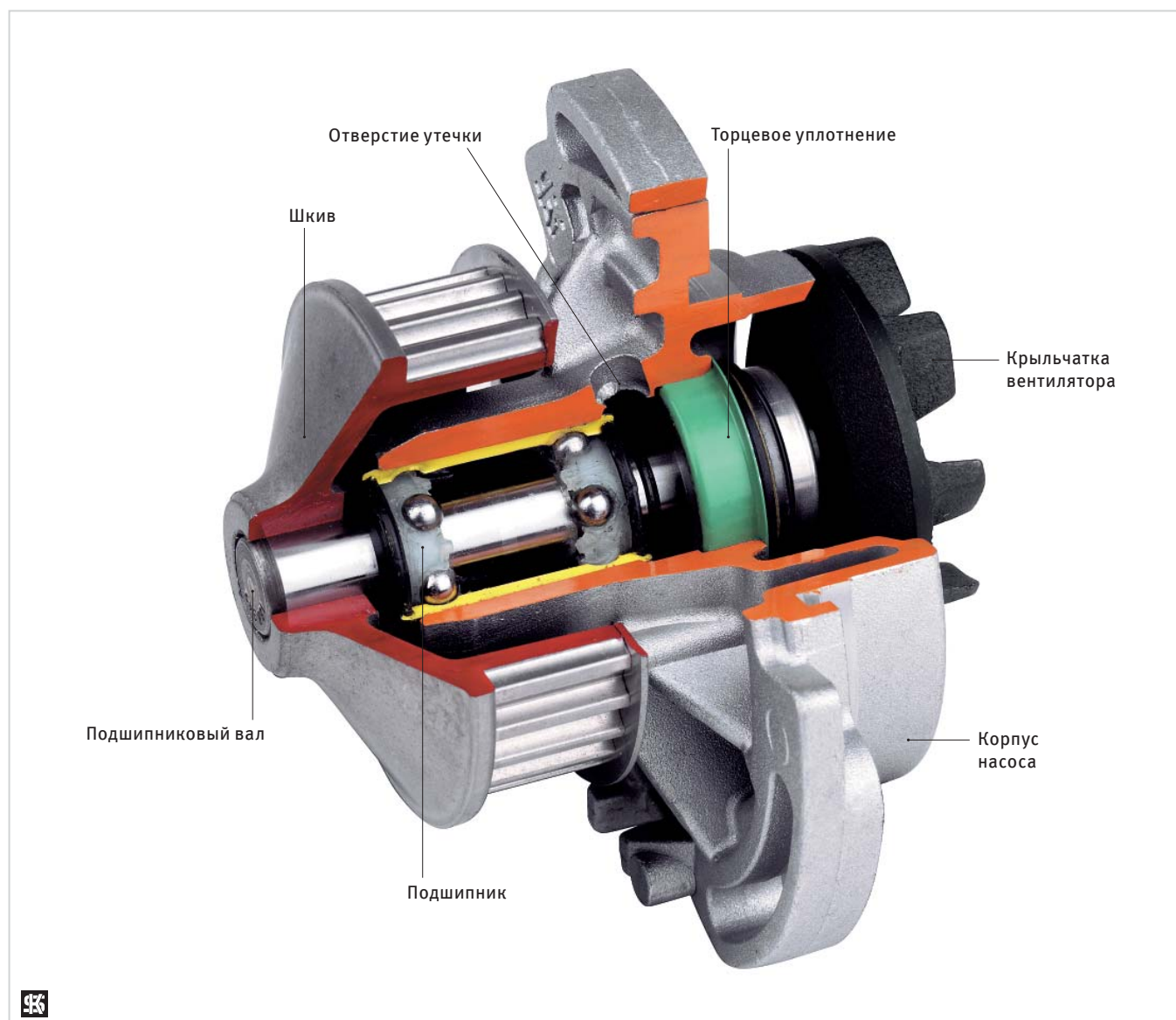

2.1.3 Типы

Водяные насосы очень различны по типу и, естественно, внешне. Вид привода и конструкция корпуса являются двумя отличительными признаками, бросающимися в глаза.

Вид привода

Водяной насос приводится в действие с помощью ремня. Это происходит либо при использовании зубчатого приводного ремня рас-

пределительного вала или при использовании клиновидного или поликлинового ремня от коленчатого вала. Если ременный шкив

еще не является составной частью насоса, то тогда он должен быть привинчен к фланцу приводного вала.



Привод через зубчатый ремень



Привод через клиновидный ремень



Насос без шкива

Конструкция корпуса

Водяные насосы могут быть открытыми или закрытыми. У открытых насосов на двигателе есть торцевая поверхность, на которой насос крепится и гермети-

зуется уплотнительным кольцом или плоским уплотнением. Сопряженная деталь корпуса насоса является составной частью двигателя. Закрытые насосы, наоборот,

представляют собой комплектную конструктивную группу: сопряженная деталь, пластина или крышка закрывают корпус насоса и герметизируют его.



Насос с фланцем крепления



Насос с корпусом

2.1.4 Технический обзор

Различные помехи могут возникнуть в связи с системой охлаждения. Ниже дается перечень значи-

тельных проблем и причин их возникновения, а также меры по уст-

ранению соответствующих неполадок.

Симптом	Возможная причина	Меры по устранению
Перегрев	Слишком мало жидкости системы охлаждения в контуре системы охлаждения	Долить жидкость системы охлаждения
	Забит конденсатор вентиляционной установки	Почистить и при необходимости заменить
	Забита сетка радиатора	Почистить радиатор и при необходимости заменить
	Термостат не открывается	Проверить термостат и при необходимости заменить
	Затруднена циркуляция жидкости системы охлаждения	Почистить и промыть систему охлаждения
	Дефектная функция водяного насоса	Заменить водяной насос
	Дефектная функция муфты вентилятора	Заменить муфту вентилятора
	Дефектная функция вентилятора радиатора	Проверить вентилятор радиатора и мотора
	Дефектная функция реле вентилятора	Проверить реле вентилятора
	Приводной ремень скользит или порван	Приводной ремень скользит или порван
Коррозия	Загрязнения в жидкости системе охлаждения	Систему охлаждения почистить, промыть и вновь провентилировать
Потеря жидкости системы охлаждения	Поврежден шланг	Заменить шланг
	Водяной насос негерметичен	Заменить водяной насос новым
	Сетка радиатора дефектная	Отремонтировать и при необходимости заменить радиатор
	Футляр термостата дефектный	Заменить футляр термостата
	Дефект на головке цилиндра	Проверить головку цилиндра и уплотнение головки цилиндра
	Пробка в системе охлаждения негерметична	Заменить пробку новой
Внутреннее пространство не нагревается	Дефектный шланг подачи нагретого воздуха	Заменить шланг подачи нагретого воздуха
	Забит теплообменник	Почистить теплообменник и при необходимости заменить
	Термостат дефектный	Заменить термостат новым



■ Монтаж водяных насосов

Для правильной установки Вашего нового водяного насоса марки KS в подходящее транспортное средство следуйте, пожалуйста, при монтаже общим указаниям и инструкции по монтажу, прилагаемой к упаковке.

2.1.5 Важное указание

Для рабочего двигателя обязательно правильное техническое обслуживание системы охлаждения. При установке нового водяного насоса марки KS необходимо проверить и при необходимости заменить важные элементы контура системы охлаждения двигателя, такие как: приводной ремень, ролики натяжения, тер-

мостат, соединительные шланги и стягивающие хомуты. Разрешено заполнение системы охлаждения только рекомендованной жидкостью. Рекомендованная изготовителем завода жидкость системы охлаждения содержит добавки, которые препятствуют коррозии и предотвращают повреждение водяного насоса и

других элементов в контуре системы охлаждения двигателя. Жидкости, отличающиеся друг от друга по своему химическому составу, категорически не допускаются смешивать. Низкокачественные жидкости системы охлаждения приводят к повреждению и выходу из строя всей системы охлаждения.

2.1.6 Повреждения

Вид повреждений	Возможные причины	Устранения повреждений
Конденсат на отверстиях утечки	Заданная неплотность	Время приработки торцевого уплотнения длится 1–3 ч.
Утечка жидкости системы охлаждения в поврежденных местах	Коррозия в системе охлаждения, эксплуатация с водой	Промыть контур системы охлаждения, залить требуемой жидкостью системы охлаждения
Коррозия на рабочей поверхности крыльчатки	Химическое повреждение уплотнения вала в связи с применением загрязненной жидкости системы охлаждения	Промыть контур системы охлаждения, залить требуемой жидкостью системы охлаждения
Коррозия / кавитация рабочей поверхности крыльчатки, корпуса и вала	Слишком высокая температура, старая / неправильная охлаждающая жидкость	Замену жидкости системы охлаждения производить согласно инструкции, проверить рабочую температуру системы (проверка радиатора, термостата, вентилятора)
Боковой увод, происходящий от ведущего колеса (регулирующие шайбы)	Соосность приводного ремня не в порядке, неправильный монтаж направляющих роликов и натяжного устройства ремня	Отрегулировать систему приводных ремней и при необходимости заменить
Коррозия во всей системе охлаждения	Испорченная прокладка головки Цилиндра неправильная / отработанная охлаждающая жидкость	Заменить прокладку головки цилиндра, промыть контур системы охлаждения
Утечка воды через штуцерные соединения и уплотнительные сальники	Входящая в комплект поставки прокладка не использовалась, неквалифицированное обращение с герметизирующей массой	Всегда использовать прокладки и герметизирующий материал согласно инструкции
Износ профиля зуба ведущей шестерни, износ приводного ремня	Черезмерное натяжение приводного ремня	Заменить приводные ремни и отрегулировать согласно рекомендации или по инструкции завода изготовителя
Усталостное разрушение подшипника водяного насоса	Вибрация и дисбаланс из-за поврежденной муфты вентилятора или поврежденных роликов натяжения, слишком большое натяжение приводного ремня	Заменить водяной насос и испорченные элементы конструкции

2.2 Масляные насосы

2.2.1 Смазка двигателя

Система смазки двигателя имеет задачу обеспечивать конструктивным элементам двигателя достаточные количества смазывающего масла. Это представляет собой замкнутую систему, в которой масло должно брать на себя большое количество задач:

- Смазка всех скользящих деталей
- Охлаждение деталей двигателя – защита от перегрева
- Очистение от отложений, от остаточных продуктов сгорания и от износа
- Защита от коррозии
- Подавление шумов и гашение колебаний
- Уплотнение предельно высокого класса качества (например, поршневых колец)
- Передача силы и энергии

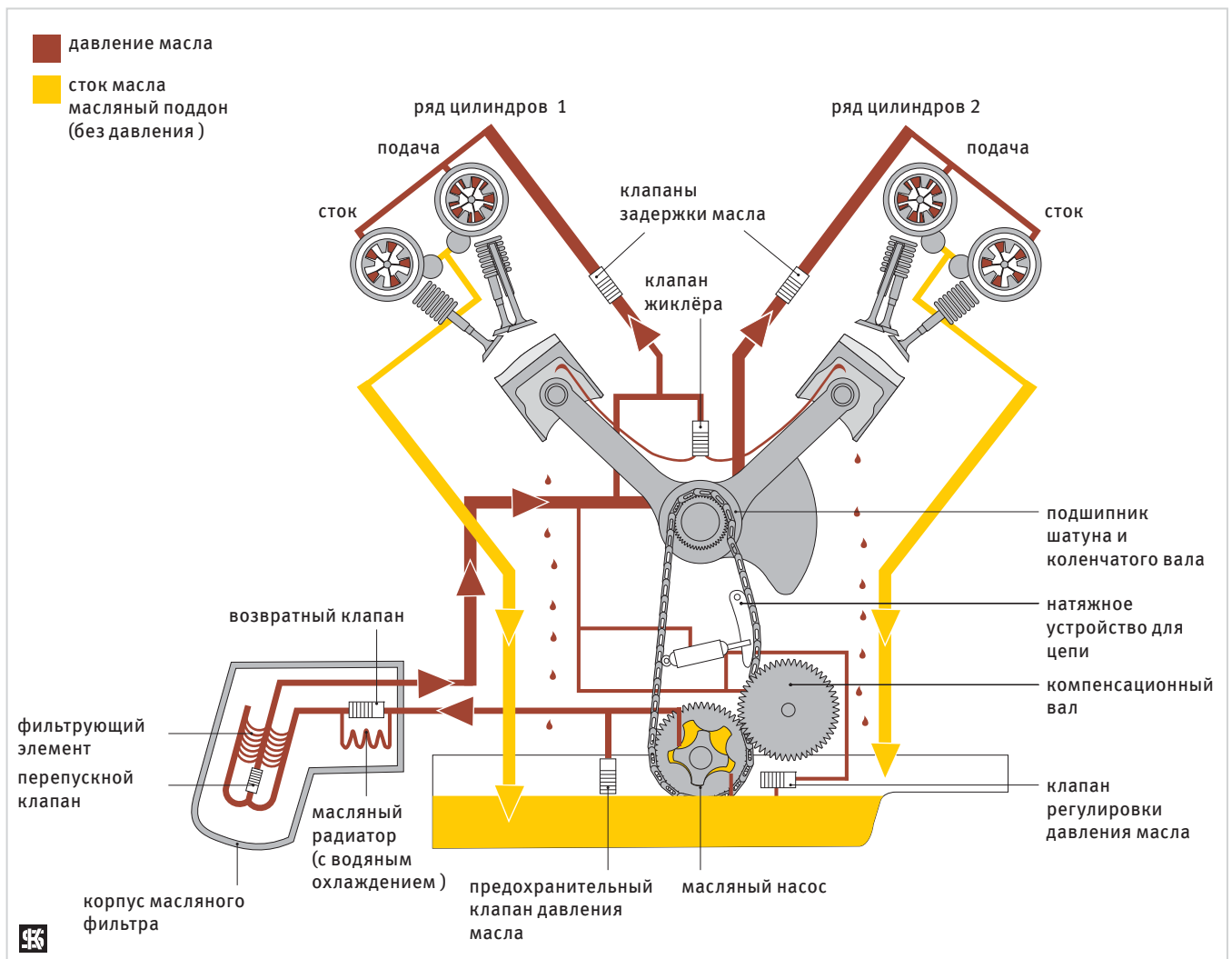

Циркуляция масла

2.2.2 Системы смазки двигателя

В области масляной смазки двигателя различают следующие системы смазок:

- Циркуляционная смазка под давлением
- Смазка с сухим картером

■ Циркуляционная смазка под давлением

В этом виде смазки, нашедшей своё применение почти во всех четырёхтактных двигателях, масло при помощи насоса движется через провода или каналы по большому количеству мест смазки. Помимо различных опорных мест валов достаточным количеством масла обеспечиваются также и гидравлические компенсационные элементы (гидравлические толкатели) клапанов, клапанные коромысла, цепи приводов валов и их натяжные устройства, а также поршни.

Для очистки масла между масляным насосом и местами смазок вставлены различные виды фильтров грубой, тонкой и предельно тонкой очистки. Для охлаждения масла часто применяются воздушные или водяные масляные радиаторы.

Образованию чрезмерно повышенного давления масла, которое может возникнуть преимущественно во время пуска холодного двигателя или при повышенных оборотах, препятствуется посредством

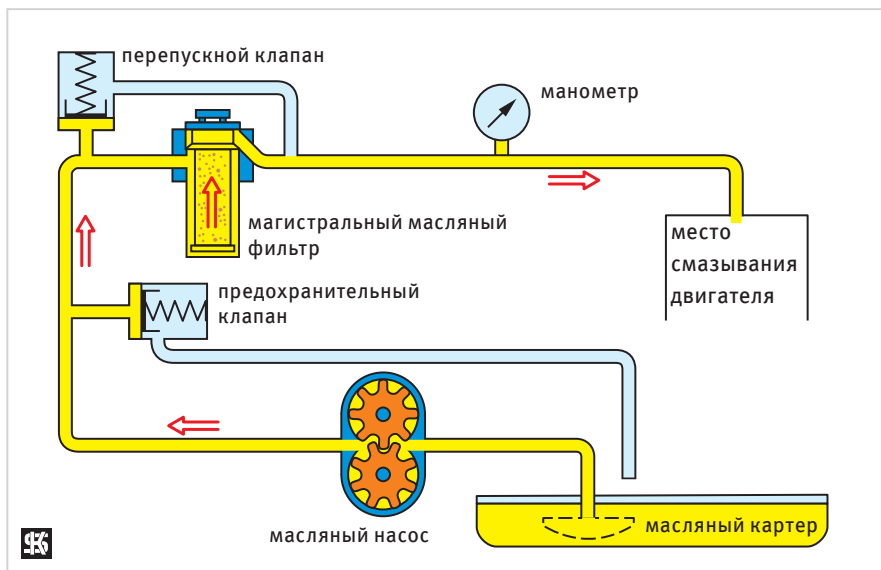

Циркуляционная смазка под давлением

соответствующего клапана ограничения давления. Он встроен близко к насосу со стороны нагнетания или непосредственно на корпусе насоса и даёт выйти чрезмерно высокому давлению в масляный картер.

■ Смазка с сухим картером

Смазка с сухим картером представляет собой особый вид циркуляционной смазки под давлением. В этой системе масло, текущее из двигателя обратно, при помощи специального отсасывающего насоса закачивается в отдельный запасный масляный резервуар.

Отсюда при помощи насоса подачи под давлением масло двигателя движется дальше в соответствующие места смазки. Преимущество такой конструкции заключается в том, что несмотря на наклонное экстремальное положение или возникающие центробежные

силы, всегда гарантируется достаточное обеспечение маслом. По этой причине такая конструкция часто находит своё применение в производстве вездеходов или в гоночном спорте.

2.2.3 Конструктивные типы и исполнения насосов

Масляные насосы по их конструкциям и внешнему виду очень разнообразны.

Принцип насоса, вид привода, а также исполнение корпуса являются наиболее часто встречающимися отличиями.

В зависимости от цели применения, места встраивания и мощности используются масляные насосы, работающие по различным принципам.

Наиболее часто встречающиеся конструкции насосов следующие:

- Зубчатые насосы
- Шестерённые насосы
- Роторные насосы

■ Зубчатые насосы

В зубчатых насосах транспортировка масла осуществляется между зубьями и стенкой посредством вращательных движений двух зубчатых колёс. Сцепление пары зубчатых колёс препятствует вытеканию масла обратно в картер. Таким образом, с одной стороны образуется зона повышенного давления, в то время как со стороны впуска появляется зона пониженного давления.

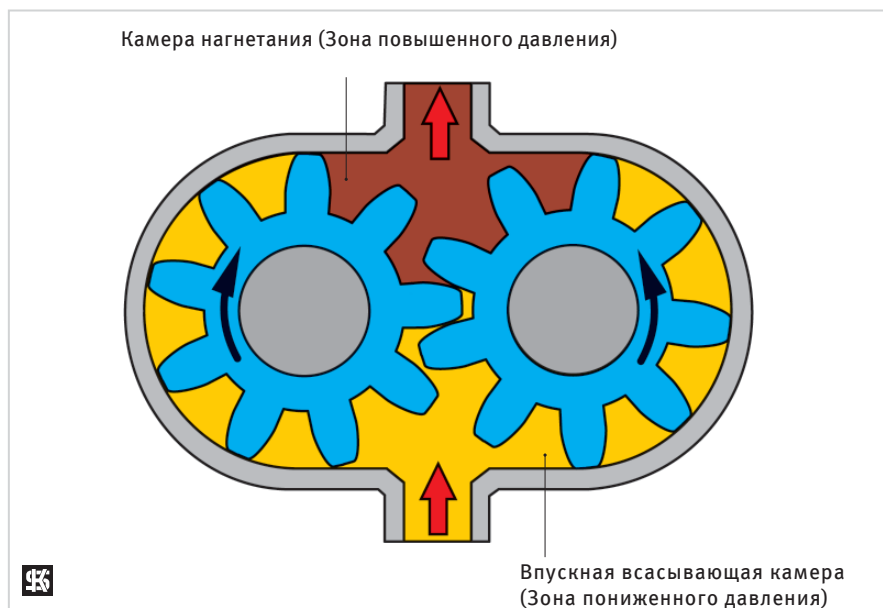

■ Шестерённый насос

В шестерённом насосе к внутреннему колесу эксцентрично расположено внешнее зубчатое колесо, находящееся в корпусе насоса. Как и в обыкновенном зубчатом насосе, масло транспортируется в промежуточные пространства между зубьями. При продолжающемся вращении насоса с одной стороны, в которой зубья движутся по направлению друг от друга, образуется зона пониженного давления. Это всасывающая сторона насоса. А в месте, где зубья снова сцепляются друг с другом, создаётся повышенное давление. Здесь имеет место выталкивание масла под давлением.

Преимущество шестерённых насосов по отношению к обыкновенным зубчатым заключается в более высокой мощности насоса, особенно при малой частоте вращения.

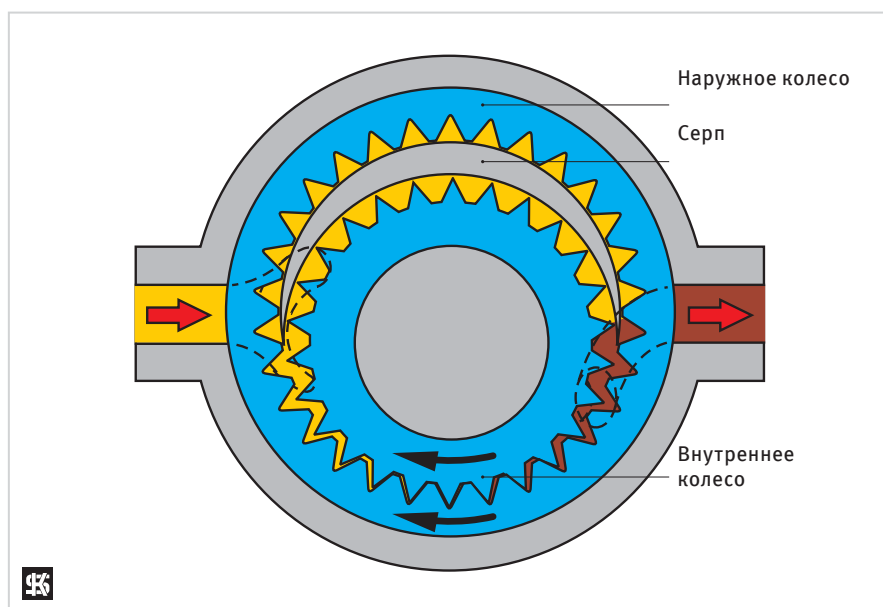

■ Роторный насос

Роторный насос состоит из наружного ротора с внутренними зубьями и из внутреннего ротора с наружными зубьями. Наружный ротор обкатывается поверх зубьев внутреннего ротора и, таким образом, вращается в корпусе насоса. Внутренний ротор имеет на один зуб меньше, нежели наружный ротор, так что при вращении осуществляется транспортировка жидкости из одного промежутка между зубьями наружного ротора в следующий. При вращательном движении пространства со стороны всасывания увеличиваются, в то время как со стороны нагнетания они уменьшаются. Такая конструкция способна при большом потоке транспортируемого материала производить высокое давление.

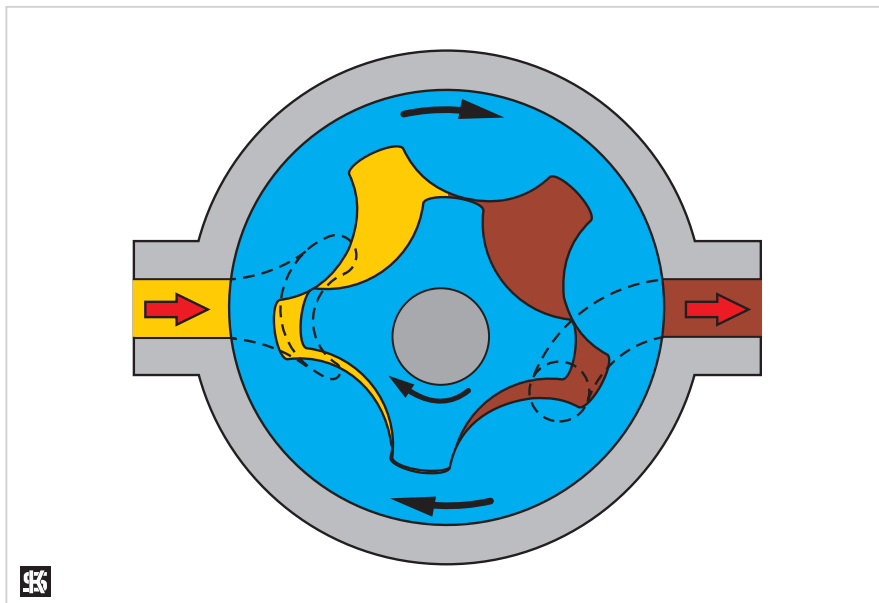

2.2.4 Виды приводов масляных насосов

Как правило, масляные насосы приводятся в движение непосредственно от двигателя. Привод осуществляется либо напрямую через зубчатое зацепление либо через штекерные соединения на коленчатом валу или через зубчатые колёса, приводные цепи или через зубчатые ремни.



Насос со штекерным приводом



Насос с шестеренчатым приводом

2.2.5 Общие указания по монтажу

Для обеспечения правильной работы и долговечности насоса во время установки нового насоса необходимо всегда соблюдать предписания по монтажу производителя двигателя.

Всё же всегда необходимо следовать так же следующим общим указаниям:

- Выпустите залитое масло. Его необходимо проверить на возможное загрязнение. Прежде всего, металлические загрязняющие частицы часто являются причиной закупоривания и механического износа отдельных компонентов двигателя.
- При установке насоса обязательно следите за чистотой. Труба всасывания масла, как правило, оснащена только одним фильтром грубой очистки. Металлические и загрязняющие частицы могут после ремонта беспрепятственно попасть вовнутрь нового насоса и в короткое время стать причиной повторного износа. Поэтому необходимо почистить по-возможности все элементы конструкции, каналы и трубу всасывания масла, которые связаны с маслом.
- При установке нового масляного насоса всегда необходимо менять так же масляный фильтр. Если система давления масла сильно загрязнена, её так же необходимо подвергнуть дополнительной чистке.
- Перед установкой нового масляного насоса его необходимо сравнить с геометрией старого насоса.
- Привод насоса (зубчатые зацепления, цепные колёса, приводные цепи и ремни) необходимо проверить на возможные повреждения.
- Перед установкой насоса необходимо смазать предписанным маслом все движущиеся части насоса (зубчатые колёса, валы).
- При установке необходимо обратить внимание на правильное положение насоса. При возникновении монтажных проблем (неправильное прилегание, косое положение) не привинчивайте его с силой по отношению к креплениям на корпусе. Это может послужить причиной повреждения насоса, функциональных неполадок и негерметичностей.
- При монтаже масляного насоса и трубы всасывания масла необходимо всегда использовать новые уплотнения и уплотнительные кольца. Избегайте общего использования жидких средств уплотнения. Их разрешается использовать и встраивать только там, где это предписано изготовителем двигателя.
- Крепёжные винты насоса должны при установке затягиваться с учётом моментов затяжек, предписанных изготовителем двигателя, и соответствующей последовательности затягивания винтов.
- Если предусмотрены предохранительные шайбы против произвольного отвинчивания, то их необходимо использовать согласно предписанию изготовителя двигателя.
- Перед запуском двигателя мы рекомендуем заполнить систему масла при помощи специального напорного резервуара для подачи под давлением (метод вдавливания). При этом сторона нагнетания системы масла оказывается полностью заполненной маслом, и в ней нет воздуха. Как правило, систему заполняют до тех пор, пока масло не попадёт в места смазки двигателя, расположенные в самых высоких и в самых отдалённых от масляного насоса местах. При этом масло должно выступить на клапанных коромыслах или из опорных мест распределительного вала. Таким образом, исключаются повреждения, которые могут возникнуть при запуске двигателя с недостаточным давлением масла.
- После «создания давления» в масляной системе двигатель заполняется до предписанного уровня масла.
- При пуске двигателя после смены масляного насоса двигателю необходимо несколько секунд, чтобы создать давление масла. Если давление масла не создаётся, тогда необходимо прервать процесс пуска, немедленно заглушите двигатель и устраните причину. В этом случае откажитесь от идеи работы двигателя на высоких оборотах с целью ускорения образования давления масла в системе.
- Пользуйтесь только теми маслами, которые предписывает и рекомендует производитель двигателя. Делайте профилактику двигателю согласно срокам от производителя.

2.2.6 Выявление причин / Диагностика на предмет повреждений

Система смазки и также механика двигателя состоят из большого количества подвижных и неподвижных деталей. Каждый элемент конструкции участвует как специфически для себя, так и во взаимодействии с другими компонентами. Поэтому проблемы давления и подачи масла могут иметь раз-

личные причины. При выходе из строя одного из элементов конструкции страдает вся система смазки. Если проблему не увидеть своевременно или вообще проигнорировать, то от этого будут страдать все взаимосвязанные элементы конструкции. Часто, несмотря на небольшую по значи-

мости причину, двигатель полностью выходит из строя. Перед тем, как ставить вопрос о замене масляного насоса, необходимо перепроверить следующие пункты и устранить возможные неполадки.

■ Причины, служащие низкому давлению масла или его отсутствию

- Слишком низкий уровень масла
- Слишком низкая вязкость масла (слишком жидкое)
- Образование масляной пены в кривошипной камере по причине слишком высокого уровня масла или неподходящего масла с неподходящими присадками или по причине загрязнения масла
- Закупорено сито всасывания масла
- Неплотная труба всасывания масла (всасывается только воздух)
- Висячий (открытый) клапан регулировки давления масла
- Забитый масляный фильтр
- Закупоренные масляные каналы, шланги подачи масла и масляный радиатор
- Открытые или отломленные сопла впрыскивания масла (охлаждение поршней методом впрыска)
- Отсутствующие или выпавшие пробки закупоривания каналов, через которые подаётся давление, блока двигателя, головки цилиндров и коленчатого вала
- Изношенный подшипник скольжения коленчатого, распределительного, компенсационного вала и вала коромысла
- Изношенные или дефектные компоненты, такие как гидротолкатель, турбокомпрессор, впрыскивающие топливные насосы или топливные насосы высокого давления
- Неплотные уплотнительные поверхности в двигателе

■ Причины слишком высокого давления масла

(как правило, речь не идёт о неисправности масляного насоса)

- Слишком высокая вязкость масла (слишком густое)
- Не работает клапан регулировки давления масла (остаётся закрытым)
- Забит масляный фильтр
- Закупорена проводка, по которой поступает масло под давлением
- По недоразумению был установлен слишком мощный насос



DE Hauptanwendungen

EN Main applications

FR Applications principales

ES Aplicaciones principales

RU Основные применения





MAIN APPLICATIONS

50 005 000



BMW	POS
2.8 (E3)	3
2500 (E3)	1
2800 (E3)	2
3.0 CSi (E3)	4
3.0 Si (E3)	5
3.0i Bavaria (E3) (USA)	6
3.3 Li (E3)	7
2.5 CS (E9)	14
525 2.5 (E12)	27
528 2.8 (E12)	28
528i (E12) (USA)	29
530 3.0i (E12) (USA)	30
728 2.8 (E23)	39
730 3.0 (E23)	41
733 3.2i (E23)	43
630 CS (E24)	47
633 CSi (E24)	48

50 005 002



BMW	POS
1500 (E6)	8
1800 (E6)	9
2002 ti (E6)	10
2000 (E9)	13
2000 1.8 (E9)	12
1502 (E10)	15
1600 (E10)	16
1602 (E10)	17
1802 (E10)	18
2000 ti (E10)	19
2002 (E10)	20
2002 (E10) (USA)	21
518 1.8 (E12)	23
520 2.0 (E12) (USA)	25
318 1.8 (E21)	34

50 005 003



Corsa C 1.2i 16V	107
Corsa C 1.4i 16V	109
Meriva 1.4i 16V	123
Tigra B 1.4i 16V	161

50 005 004



BMW	POS
528i (E12) (USA)	29
728 2.8i (E23)	40
732 3.2i (E23)	42
735i (E23)	44
745i turbo (E23)	45
628 CSi (E24)	46
633 CSi (E24)	48
635 CSi (E24)	49
525 2.5i (E28)	55
528 2.8i (E28)	57
535 3.4i (E28)	58
M 535 3.4i (E28)	59
730 3.0i (E32)	76
735 3.5i (E32)	77
535 3.5i (E34)	89

50 005 001



AUDI	POS
A3 1.6 FSI 16V	6
SKODA	POS
Octavia 1.6 FSI 16V	17
VOLKSWAGEN	POS
Eos 1.6 FSI 16V	64
Golf V 1.6 FSI 16V	143
Jetta 1.6 FSI 16V	168
Passat 1.6 FSI 16V	238
Touran 1.6 FSI 16V	355

50 005 003



OPEL	POS
Agila 1.0i 12V	3
Agila 1.2i 16V	4
Astra G 1.4i 16V	34
Astra H 1.2i 16V	46
Astra H 1.4i 16V	47
Astra H 1.8i 16V	50
Combo 1.4i 16V	65
Corsa C 1.0i 12V	94
Corsa C 1.2i 16V	95
Corsa C 1.4i 16V	97
Corsa D 1.0i 16V	104
Corsa D 1.2i 16V	105
Corsa D 1.4i 16V	106
Meriva 1.4i 16V	153
Tigra B 1.4i 16V	211
VAUXHALL	POS
Agila 1.0i 12V	1
Agila 1.2i 16V	2
Astra H 1.2i 16V	42
Astra H 1.4i 16V	43
Combo 1.4i 16V	94
Corsa C 1.0i 12V	106

50 005 005



BMW	POS
316 1.6i (E30)	60
518 1.8i (E34)	79

50 005 006



ALFA ROMEO	POS
159 1.8i 16V	11
OPEL	POS
Astra G 1.6i 16V	36
Astra H 1.6i 16V	48
Astra H 1.8i 16V	50
Meriva 1.6i 16V	155





MAIN APPLICATIONS

50 005 006	
Signum 1.8i 16V	200
Vectra C 1.6i 16V	233
Vectra C 1.8i 16V	234
Zafira B 1.6i 16V	250
Zafira B 1.8i 16V	251
VAUXHALL	POS
Astra G 1.6i 16V	32
Astra H 1.6i 16V	44
Astra H 1.8i 16V	46
Meriva 1.6i 16V	125
Signum 1.8i 16V	153
Vectra C 1.6i 16V	172
Vectra C 1.8i 16V	173
Zafira B 1.6i 16V	189
Zafira B 1.8i 16V	190

50 005 007	
	
VOLKSWAGEN	POS
California 1.9 TDI	34
California 2.5 TDI	38
Touareg 2.5 TDI	352
Transporter T5 2.5 TDI	377

50 005 008	
	
AUDI	POS
A3 3.2i 24V	13
TT 3.2i 24V	93
SEAT	POS
Alhambra 2.8i 24V	7
Leon 2.8i Cupra 4 24V	78
VOLKSWAGEN	POS
Bora 2.8i VR6 24V	13
California 3.2i	40
Eos 3.2i 24V	66
Golf IV 2.8i VR6 24V	138
Golf IV 3.2i 24V	139
Golf V 3.2i 24V	149
New Beetle 3.2i 24V	227
Sharan 2.8i VR6 24V	348
Touareg 3.2i 24V	353
Transporter T5 3.2i 24V	378

50 005 009	
	
BMW	POS
1800 (E6)	9
2000 1.8 (E9)	12
1802 (E10)	18
518 1.8 (E12)	23
316 1.8 (E21)	33
318 1.8 (E21)	34
318 1.8i (E21)	35
518 1.8 (E28)	50
518 1.8i (E28)	51
316 1.8 (E30)	61
316 1.8i (E30)	62
318 1.8i (E30)	63
320 1.8i (E30) (AUS/J/S/USA)	65
320 1.8i (E30) (USA)	67

50 005 010	
	
MERCEDES-BENZ	POS
Sprinter 308 CDI	134
Sprinter 311 CDI	137
Sprinter 314 CDI	141
Sprinter 408 CDI	143
Sprinter 411 CDI	146
Sprinter 413 CDI	148
Sprinter 414 CDI	150
Sprinter 416 CDI	151

50 005 011	
	
BMW	POS
316 1.6i 16V (E46)	122
316 1.8i 16V (E46)	123
318 2.0i 16V (E46)	126
X3 2.0i 16V (E83)	132
Z4 2.0i (E85)	133
116 1.6i 16V (E87)	134
118 2.0i 16V (E87)	135
120 2.0i 16V (E87)	136

50 005 011	
316 1.6i 16V (E90)	137
318 2.0i 16V (E90)	138
320 2.0i 16V (E90)	139
318 2.0i 16V (E91)	140
320 2.0i 16V (E91)	141
316 1.6i 16V (E92)	142

50 005 013	
	
FORD	POS
Transit 2.4 DI 16V	108
Transit 2.4 TDCi 16V	107
Transit 2.4 TDDi	106

50 005 018	
	
BMW	POS
320/6 2.0 (E21)	37
323 2.3i (E21)	38
520 2.0i (E28)	52
525e 2.7i (E28)	56
320 1.8i (E30) (J/USA)	66
320 2.0i (E30)	68
320 2.0i (E30) (AUS/CH/S)	69
323 2.3i (E30)	70
323 2.3i (E30) (CH)	71
325 2.5i (E30)	74

50 005 019	
	
BMW	POS
1800 (E6)	9
2002 tii (E6) (USA)	11
2000 1.8 (E9)	12
1802 (E10)	18
2002 tii (E10) (USA)	22



MAIN APPLICATIONS

50 005 019



518 1.8 (E12)	23
520 2.0 (E12)	24
315 1.6 (E21)	31
316 1.6 (E21)	32
316 1.8 (E21)	33
318 1.8 (E21)	34
318 1.8i (E21)	35
320 2.0i (E21)	36
518 1.8 (E28)	50
318 1.8i (E30)	63
320 1.8i (E30) (AUS/J/S/USA)	65
320 1.8i (E30) (USA)	67

50 005 020



BMW	POS
520/6 2.0 (E12)	26
320/6 2.0 (E21)	37
323 2.3i (E21)	38

50 005 021



MERCEDES-BENZ	POS
280 SE 3.5 (108)	262
280 SE 3.5 (111)	263
300 SE 3.5 (109)	290
300 SEL 4.5 (109)	291
350 SE (116)	297
350 SL (107)	299
450 SE (116)	308
450 SL (107)	310

50 005 027



RENAULT	POS
Clio II 1.5 dCi	16
Clio III 1.5 dCi	24
Grand Scénic 1.5 dCi	51
Mégane II 1.5 dCi	135

50 005 027



Modus 1.5 dCi	143
Scénic II 1.5 dCi	234
SUZUKI	POS
Jimny 1.5 DDiS	15

50 005 028



MERCEDES-BENZ	POS
190 2.0 (201)	185
200 (123)	200
230 E (123)	216
230 GE (460)	221
230 GE (461)	222
O 309 2.3	505
Series 208 2.3	617
Series 210 2.3	620
Series 308 2.3	627
Series 310 2.3	631
Series 408 2.3	657
Series 409 2.3	661
Series 410 2.3	663

50 005 029



MERCEDES-BENZ	POS
190 2.0 (201)	185
190 E 2.0 (201)	192
200 (123)	200
230 E (123)	216
230 GE (460)	221
230 GE (461)	222
O 309 2.3	505
Series 208 2.3	617
Series 210 2.3	620
Series 308 2.3	627
Series 310 2.3	631
Series 408 2.3	657
Series 409 2.3	661
Series 410 2.3	663

50 005 030



MERCEDES-BENZ	POS
380 SE (126)	301
380 SL (107)	303
500 SE (126)	314
500 SL (107)	317

50 005 031



MERCEDES-BENZ	POS
E 200 D (124)	50
190 D (201)	187
200 D (124)	205
Engine	992

50 005 032





HANOMAG	POS
Series F 20	1
MERCEDES-BENZ	POS
200 (115)	199
200 (123)	200
200 D (115)	203
200 D (123)	204
220 (115)	207
220 D (115)	209
220 D (123)	210
230 (123)	215
230 G (460)	219
230.4 (115)	224
230.6 (114)	225
240 D (115)	226
240 D (123)	227
240 D (USA) (115)	228
240 D 3.0 (115)	229
240 GD (460)	230
240 GD (461)	231
250 (114)	232
280 E (116)	250



50 005 035	
280 GE (460)	253
280 GE (461)	254
280 S (108)	255
280 S (116)	256
280 SE (108)	258
280 SE (111)	259
280 SE (116)	260
280 SE (126)	261
280 SL (107)	264
280 SL (113)	265
300 D (115)	270
300 D (123)	271
300 D Turbo (123)	268
300 GD (460)	277
300 GD (461)	278
300 SD Turbo (USA) (116)	281
300 SD Turbo (USA) (126)	282
300 SE 2.8 (109)	285
350 SE 2.8 (116)	298
350 SL 2.8 (107)	300
380 SE 2.8 (126)	302
450 SE 2.8 (116)	309
450 SL 2.8 (107)	311
500 SE 2.8 (126)	316
MB 100 2.0 D	486
MB 90 2.0 D	485
O 309 2.3	505
O 309 D 2.2	506
O 309 D 2.4	507
MB-Trac 100	534
MB-Trac 90	533
U 404	576
U 421	579
U 600	584
Series 206 D 2.0	613
Series 206 D 2.2	614
Series 207 D 2.0	615
Series 207 D 2.4	616
Series 208 2.3	617
Series 210 2.3	620
Series 306 D 2.0	622
Series 306 D 2.2	623
Series 307 D 2.0	624
Series 307 D 2.4	626
Series 308 2.3	627
Series 308 D 2.4	629
Series 310 2.3	631
Series 406 D 2.2	647
Series 406 D 2.4	648
Series 407 D 2.2	652
Series 407 D 2.4	653
Series 408 2.3	657
Series 409 2.3	661
Series 410 2.3	663
Series 507 D 2.4	665
Engine	992
SEAT	POS
132 2.0 D	2
2000 D	3
STEYR	POS
City Bus SC 6 F 55	3

50 005 036	
	
MERCEDES-BENZ	POS
C 200 D (202)	12
C 220 D (202)	16
E 200 D (210)	51
E 220 D (210)	55
Engine	992

50 005 038	
	
MERCEDES-BENZ	POS
250 (123)	233
280 (123)	248
280 E (123)	251
280 S (126)	257
280 SE (126)	261
380 SE 2.8 (126)	302
500 SE 2.8 (126)	316

50 005 040	
	
RENAULT	POS
Clio I 1.4i	7
Clio II 1.4i	14
Express 1.4i	46
Kangoo 1.4i	55
Mégane 1.4i	105
Mégane Classic 1.4i	116
Mégane Grandtour 1.4i	125
Rapid 1.4i	214
Scénic 1.4i	222

50 005 042	
	
OPEL	POS
Ascona A 1.2	6
GT 1.1	113
Kadett A 1.0	115
Kadett B 1.1	116
Kadett B 1.2	117
Kadett C 1.0	119
Kadett C 1.2	120
Manta A 1.2	143

50 005 043	
	
OPEL	POS
Admiral A 2.8	1
Admiral B 2.8	2
Ascona A 1.6	7
Ascona A 1.9	8
Ascona B 1.6	11
Ascona B 1.9	12
Ascona B 2.0	13
Ascona B 2.0i	14
Ascona C 1.6	17
Commodore A 2.8	71
Commodore B 2.5	72
Commodore B 2.5 24V	73
Commodore B 2.8	74
Commodore B 2.8i	75
Commodore C 2.5	76
GT 1.9	114
Kadett B 1.9	118
Kadett C 1.6	121
Kadett C 2.0i	122
Kadett E 1.6	134
Kapitän 2.8	142
Manta A 1.6	144
Manta A 1.9	145
Manta B 1.6	148
Manta B 1.9	150
Manta B 2.0	151
Rekord C 1.5	180
Rekord C 1.7	181
Rekord C 1.9	182
Rekord D 1.7	183
Rekord D 1.9	184
Rekord D 2.0	185
Rekord E 1.7	188



MAIN APPLICATIONS

50 005 043	
Rekord E 2.0	191
VAUXHALL	POS
Astra D 1.6	5
Carlton II 2.0i	61
Cavalier I 1.6	73
Cavalier I 1.9	74
Cavalier I 2.0	75
Cavalier II 1.6	77

50 005 044



MINI (BMW)	POS
One 1.6i (R50)	2
One 1.6i (R52)	1

50 005 045



OPEL	POS
Ascona B 1.2	9
Kadett A 1.0	115
Kadett C 1.0	119
Kadett C 1.2	120
Manta B 1.2	146

50 005 049



DAEWOO	POS
Espero 1.8i	4
Espero 2.0i	5
OPEL	POS
Ascona C 1.6	17
Ascona C 1.8i	21
Astra F 1.8i	30
Kadett D 1.6	125
Kadett D 1.8i	127

50 005 049	
Kadett E 1.8	138
Kadett E 1.8i	139
Manta B 1.8	149
Rekord E 1.8	189
Rekord E 1.8i	190
VAUXHALL	POS
Astra D 1.6	5
Astra D 1.8i	7
Astra E 1.8	16
Astra E 1.8i	17
Astra F 1.8i	26
Belmont 1.8i	55
Carlton II 1.8	60
Cavalier II 1.6	77
Cavalier II 1.8i	81
Manta 1.8	121

50 005 051



OPEL	POS
Corsa A 1.0	77
Corsa A 1.2	78
Kadett A 1.0	115
Kadett D 1.2	123
Kadett E 1.2	128
VAUXHALL	POS
Astra E 1.2	8
Belmont 1.2	49
Nova 1.0	133
Nova 1.2i	135

50 005 052



OPEL	POS
Ascona B 1.3	10
Ascona C 1.3	16
Corsa A 1.3	80
Corsa A 1.3i	81
Kadett D 1.3	124
Kadett E 1.3	129
Kadett E 1.3i	130
Manta B 1.3	147
VAUXHALL	POS
Astra D 1.3	4
Astra E 1.3	9

50 005 052	
Astra E 1.3i	10
Belmont 1.3	50
Cavalier I 1.3	72
Cavalier II 1.3	76
Chevette 1.3	90
Nova 1.3	136
Nova 1.3i	137

50 005 053



OPEL	POS
Ascona B 2.0 D	15
Bedford-Blitz 2.0 D	56
Bedford-Blitz 2.3 D	57
Rekord D 2.0 D	186
Rekord D 2.1 D	187
Rekord E 2.0 D	192
Rekord E 2.1 D	193
Rekord E 2.3 D	194
VAUXHALL	POS
Carlton II 2.3 D	62

50 005 055



OPEL	POS
Ascona C 1.6 D	19
Kadett D 1.6 D	126
Kadett E 1.6 D	136
VAUXHALL	POS
Astra D 1.6 D	6
Astra E 1.6 D	14
Belmont 1.6 D	54
Cavalier II 1.6 D	79

MAIN APPLICATIONS



MAIN APPLICATIONS

50 005 056



ALFA ROMEO	POS
147 1.9 JTD 16V	4
147 1.9 JTDM 16V	5
156 1.9 JTD 16V	7
156 1.9 JTDM 16V	8
156 2.4 JTDM 20V	10
159 1.9 JTD 16V	13
159 2.4 JTDM 20V	14
166 2.4 JTDM 20V	16
Brera 2.4 JTDM 20V	17
GT 1.9 JTDM 16V	18
Spider 2.4 JTDM 20V	19

FIAT / IVECO	POS
Bravo 1.9 JTD 16V	11
Croma 1.9 JTD 16V	14
Croma 2.4 JTD 20V	16
Stilo 1.9 JTD	98
Stilo 1.9 JTD 16V	99

LANCIA	POS
Thesis 2.4 JTD 20V	9

OPEL	POS
Astra H 1.9 CDTI 16V	51
Signum 1.9 CDTI 16V	202
Vectra C 1.9 CDTI 16V	235
Zafira B 1.9 CDTI 16V	252

SAAB	POS
9-3 1.9 TiD 16V	2
9-5 1.9 TiD 16V	8

VAUXHALL	POS
Astra H 1.9 CDTI 16V	47
Signum 1.9 CDTI 16V	154
Vectra C 1.9 CDTI 16V	174
Zafira B 1.9 CDTI 16V	191

50 005 057



FIAT / IVECO	POS
Albea 1.2i 16V	2
Barchetta 1.2i 16V	3
Brava 1.2i 16V	5
Bravo 1.2i 16V	8

50 005 057



Doblò 1.2i 16V	32
Idea 1.2i 16V	60
Marea 1.2i 16V	62
Palio 1.0i	69
Palio 1.2i 16V	72
Petra 1.2i 16V	80
Punto 1.2i 16V	83
Siena 1.0	95
Siena 1.2i 16V	96
Stilo 1.2i 16V	97
LANCIA	POS
Y 1.2i 16V	12
Ypsilon 1.2i 16V	16

50 005 059



DAEWOO	POS
Nexia 1.5i	20

OPEL	POS
Astra F 1.4	23
Astra F 1.4i	24
Astra F 1.6i	26
Astra G 1.6i	35
Astra Classic 1.6i	54
Combo 1.2i	62
Combo 1.4i	64
Corsa A 1.2	78
Corsa A 1.2i	79
Corsa A 1.4	82
Corsa A 1.4i	83
Corsa A 1.6i	86
Corsa B 1.2i	87
Corsa B 1.4i	89
Kadett D 1.2	123
Kadett E 1.2	128
Kadett E 1.4	131
Kadett E 1.6	134
Vectra A 1.4	212
Vectra A 1.6	213
Vectra A 1.6i	214
Vectra B 1.6i	223

VAUXHALL	POS
Astra E 1.4	11
Astra F 1.4	20
Astra F 1.4i	21
Astra F 1.6i	23
Astra G 1.6i	31
Belmont 1.4	51
Cavalier III 1.4	83
Cavalier III 1.6i	84
Combo 1.2i	91
Combo 1.4i	93
Corsa B 1.2i	100
Corsa B 1.4i	101
Nova 1.2	134
Nova 1.2i	135
Nova 1.4	138
Nova 1.4i	139

50 005 059



Nova 1.6i	140
Vectra B 1.6i	163

50 005 061



SEAT	POS
Cordoba 1.6i 16V	28
Ibiza 1.6i 16V	49

SKODA	POS
Fabia 1.6i 16V	8
Roomster 1.6i 16V	28

VOLKSWAGEN	POS
Golf V 1.4 FSI 16V	141
Polo 1.4 FSI 16V	282
Polo 1.6i 16V	286
Polocross 1.6i 16V	305

50 005 062



FORD	POS
Capri 2.0	3
Capri 2.3	4
Capri 2.8i	5
Granada 2.0	57
Granada 2.3	59
Granada 2.8	62
Granada 2.8i	63
Scorpio 2.8i	88
Sierra 2.8i	94
Taurus 2.0	99
A 0407	118

50 005 063



FORD	POS
Capri 1.6	2
Capri 2.0	3
Granada 2.0	57



MAIN APPLICATIONS

50 005 063	
Scorpio 2.0	85
Sierra 1.6	89
Sierra 1.8	90
Sierra 2.0i	92
Taunus 1.3	97
Taunus 1.6	98
Taunus 2.0	99
Transit 1.6	103
Transit 2.0	104

50 005 064



FORD	
Escort 1.1	8
Escort 1.3	9
Fiesta 1.0	19
Fiesta 1.1	22
Fiesta 1.3	25
Fiesta 1.6	30
Orion 1.3	73

50 005 065



FORD	
Escort 1.3	9
Escort 1.6	13
Fiesta 1.3	25
Fiesta 1.6	30
Orion 1.3	73
Orion 1.6	77

50 005 067



FORD	
Granada 2.8i	63
Scorpio 2.8i	88
Sierra 2.0	91
Sierra 2.3	93
Sierra 2.8i	94

50 005 068	
	

FORD	
Escort 1.1	8
Escort 1.3	9
Escort 1.3i	10
Fiesta 1.0	19
Fiesta 1.1	22
Fiesta 1.1i	23
Orion 1.3	73
Orion 1.3i	74

50 005 072



CHEVROLET	
Aveo 1.4i	3
Kalos 1.4i	7

DAEWOO	
Cielo 1.5i 16V	2
Espero 1.5i 16V	3
Kalos 1.4i	8
Lanos 1.4i	13
Lanos 1.5i 16V	14
Nexia 1.5i 16V	21
Racer 1.5i 16V	26

50 005 073



DAEWOO	
Cielo 1.5i	1
Lanos 1.6i 16V	15
Nexia 1.5i	20
Racer 1.5i	25

50 005 074	
	

DAEWOO	
Leganza 2.0i 16V	16
Magnus 2.0i 16V	17
New Brougham 2.0i 16V	18
New Prince 2.0i 16V	19
Nubira 2.0i 16V	24
Super Saloon 2.0i 16V	28

OPEL	
Astra H 2.0i Turbo 16V	52
Omega B 2.2i 16V	175
Zafira B 2.0i Turbo 16V	253

VAUXHALL	
Astra H 2.0i Turbo 16V	48
Omega B 2.2i 16V	144
Zafira B 2.0i Turbo 16V	192

50 005 075



CHEVROLET	
Aveo 1.2i	2
Kalos 1.2i	6

DAEWOO	
Kalos 1.2i	7
Tico 0.8	30

50 005 076



CHEVROLET	
Aveo 1.4i 16V	4
Aveo 1.6i 16V	5
Kalos 1.4i 16V	8
Kalos 1.6i 16V	9
Lacetti 1.4i 16V	10
Lacetti 1.6i 16V	11
Nubira 1.4i 16V	12
Nubira 1.6i 16V	13
Rezzo 1.6i 16V	14
Tacuma 1.6i 16V	15



MAIN APPLICATIONS

50 005 076



DAEWOO	POS
Kalos 1.4i 16V	9
Kalos 1.6i 16V	10
Lacetti 1.4i 16V	11
Lacetti 1.6i 16V	12
Lanos 1.6i 16V	15
Nubira 1.4i 16V	22
Nubira 1.6i 16V	23
Rezzo 1.6i 16V	27
Tacuma 1.6i 16V	29

50 005 077



DAIHATSU	POS
Applause 1.6i 16V	3
Charade 1.0	4
Charade 1.3i 16V	5
Charade 1.5i 16V	6
Charade 1.6i 16V	7
Grand Move 1.5 i 16V	13
Grand Move 1.6 i 16V	14
Hijet 1.3 i 16V	15
Pyzar 1.5 i 16V	16
Pyzar 1.6 i 16V	17
Terios 1.3 i 16V	19

50 005 078



DAIHATSU	POS
Applause 1.6 16V	2
Feroza 1.6 16V	11
Feroza 1.6i 16V	12

50 005 079



HONDA	POS
Accord 1.6 12V	1
Accord 1.8 12V	3
Accord 2.0 12V	5
Accord 2.0 i 12V	7
Vigor 1.6 12V	42

50 005 080



HONDA	POS
Accord 1.8 i 16V	4
Accord 2.0 i 16V	8
Accord 2.2 i 16V	9
Accord 2.3 i 16V	10
Ascot 2.0 i 16V	13
Odyssey 2.3 i 16V	34
Prelude 2.0 i 16V	35
Shuttle 2.3 i 16V	38
Vigor 2.0 i 16V	43

ROVER	POS
618i 16V	28
620 Si	30
620i 16V	31

50 005 081



HONDA	POS
Accord 1.8 i 16V	4
Accord 2.0 i 16V	8

50 005 082



HONDA	POS
Accord 2.0 TDi	6
Civic 2.0 TDi	21

ROVER	POS
Discovery 2.0i 16V	5
220 SD	16
220 SDi	17
220i 16V	18
220i Turbo 16V	19
420 SD	24
420 SDi	25
420i 16V	26
420i Turbo 16V	27
620 SDi	29
620i Turbo 16V	32
820i 16V	34
820i Turbo 16V	35

50 005 084



HONDA	POS
Acura Integra 1.6 i 16V	11
CRX 1.6 i 16V	15
Civic 1.3 16V	16
Civic 1.4 i 16V	17
Civic 1.5 i 16V	18
Civic 1.6 i 16V	19
Concerto 1.4 i 16V	22
Concerto 1.5 i 16V	23
Concerto 1.6 i 16V	24
Domani 1.4 i 16V	25

ROVER	POS
25 1.6i 16V	10
45 1.6i 16V	11
216i 16V	13
416i	20
416i 16V	21



MAIN APPLICATIONS

50 005 096



Avante 2.0 CRDi 16V	46
Click 1.5 CRDi 12V	4
Elantra 2.0 CRDi 16V	58
Getz 1.5 CRDi 12V	13
Lantra 2.0 CRDi 16V	59
Lavita 1.5 CRDi 12V	16
Matrix 1.5 CRDi 12V	17
Santa Fe 2.0 CRDi 16V	40
Trajet 2.0 CRDi 16V	42
Tucson 2.0 CRDi 16V	43
Verna 1.5 CRDi 12V	52
KIA	POS
Carens 2.0 CRD 16V	2
Cerato 2.0 CRD 16V	11
Sportage 2.0 CRDi 16V	12

50 005 097



HYUNDAI	POS
Accent 1.6i 16V	55
Click 1.6i 16V	5
Coupé 1.6i 16V	6
Elantra 1.6i 16V	49
Getz 1.4i 16V	12
Getz 1.6i 16V	14
Matrix 1.6i 16V	18
Verna 1.6i 16V	54
KIA	POS
Cerato 1.6i 16V	8

50 005 098



HYUNDAI	POS
Atos 1.0i 12V	1
Atos 1.1i 12V	2
Santro 1.0i 12V	26

50 005 100



ISUZU	POS
Bighorn 2.8 TD	1
Bighorn 2.8 TDI	2
Trooper 2.8 TD	4
Trooper 2.8 TDI	5
OPEL	POS
Frontera A 2.8 TDI	111

50 005 102



VOLVO	POS
240 1.8	1
240 2.0i Turbo	3
240 2.1	4
240 2.1i	5
240 2.1i Turbo	6
240 2.3	7
240 2.3i	8
360 2.0	14
740 2.0	29
740 2.0i Turbo	30
740 2.3	31
740 2.3i	33
760 2.3	37
760 2.3i Turbo	38

50 005 106



VOLVO	POS
240 2.0	2
240 2.3	7
360 2.0	14
440 2.0	19
740 2.0	29
740 2.3	31
740 2.3i Turbo	32

50 005 106



760 2.3	37
760 2.3i Turbo	38
940 2.0	48
940 2.0i Turbo 16V	49
940 2.3	50
940 2.3i	51
940 II 2.3i Turbo	56
960 2.0i Turbo 16V	58
960 2.3	59
960 2.3i Turbo	61

50 005 107



RENAULT	POS
Laguna I 2.0i 16V	68
Laguna Grandtour 2.0i 16V	84
Safrane 2.0i 16V	219

VOLVO	POS
740 2.3i 16V	34
740 2.9i 24V	36
850 2.0i	42
850 2.0i 20V	41
850 2.0i Turbo 20V	43
850 2.3i Turbo 20V	44
850 2.4i	45
850 2.4i 20V	46
940 2.3i 16V	52
940 2.9i 24V	55
960 2.3i 16V	60
960 2.9i 24V	64
C70 2.3i Turbo 20V	70
C70 2.4i Turbo 20V	69
C70 2.5i 20V	71
S40 1.6i 16V	72
S40 1.8i 16V	74
S40 1.9i Turbo 16V	75
S40 2.0i 16V	78
S40 2.0i 20V	79
S40 2.0i Turbo 16V	80
S60 2.3i Turbo 20V	82
S70 2.0i	84
S70 2.0i 20V	85
S70 2.0i Turbo 20V	86
S70 2.3i T5 Turbo 20V	87
S70 2.4i Turbo 20V	88
S70 2.5i	89
S70 2.5i 20V	90
V40 1.8i 16V	99
V40 1.9i Turbo 16V	100
V40 2.0i 16V	103
V40 2.0i 20V	104
V40 2.0i Turbo 16V	105
V70 2.0i	109
V70 2.0i 20V	110
V70 2.0i Turbo 20V	111
V70 2.3i Turbo 20V	112
V70 2.4i Turbo 20V	113



50 005 107	
V70 2.5i	114
V70 2.5i 20V	115
V70 II 2.3 Turbo 20V	118

50 005 110

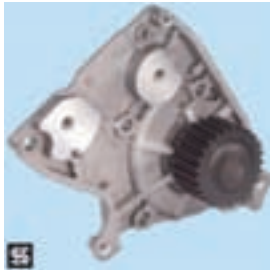

KIA	POS
Sportage 2.0i 16V	9
MAZDA	POS
626 2.0i 16V	60

50 005 111



KIA	POS
Avella 1.3i 16V	1
Pride 1.1	4
Pride 1.3i 16V	5
Sephia 1.6i	6
MAZDA	POS
121 1.1	1
121 1.3i 16V	4
323 1.3	26
323 1.3i 16V	27
Demio 1.3i 16V	13
MX-3 1.6i 16V	16
Revue 1.3i 16V	21

50 005 115



MAZDA	POS
323 1.5i 16V	30

50 005 115	
Eunos Roadster 1.6i 16V	28
MX-5 1.6i 16V	17

50 005 116



MAZDA	POS
626 1.6	38
626 1.8	46
626 2.0	55
626 2.0i	59
626 2.2i 12V	62
929 2.0	39
Bongo 1.8	12
Capella 1.6	40
Capella 1.8	52
Capella 2.0	56
E 2000i	14
Eunos 1.8	29
Persona 1.8	20

50 005 117



MAZDA	POS
323 2.0i 16V	41
626 2.0i 16V	60
Anfini 2.0i 16V	11
MX-6 2.0i 16V	47
Premacy 2.0i 16V	48

50 005 118



MAZDA	POS
323 2.0i 24V	42

50 005 118	
626 2.5i 24V	63
Eunos 800 2.3i Turbo 24V	33
Lantis 2.0i 24V	15
MX-6 2.5i 24V	57
Millenia 2.3i Turbo 16V	19
Xedos 6 2.0i 24V	22
Xedos 9 2.0i 24V	23
Xedos 9 2.3i Turbo 24V	24
Xedos 9 2.5i 24V	25

50 005 119



FORD	POS
Fiesta 1.25i 16V	24
Fiesta 1.4i 16V	29
Fiesta 1.6i 16V	31
Focus 1.4i 16V	35
Focus 1.6 TI-VCT 16V	37
Focus 1.6i 16V	36
Focus C-Max 1.6i 16V	44
Fusion 1.25i 16V	49
Fusion 1.4i 16V	50
Fusion 1.6i 16V	51
Puma 1.4i 16V	82
Puma 1.6i 16V	83
Puma 1.7i 16V	84
MAZDA	POS
121 1.25i 16V	2
2 1.2i 16V	6
2 1.4i 16V	8
2 1.6i 16V	9
VOLVO	POS
C30 1.6i 16V	65
S40 1.6i 16V	72
V40 1.6i 16V	98
V50 1.6i 16V	106

50 005 120



FORD	POS
Fiesta 1.3i	26
KA 1.3i	64
MAZDA	POS
121 1.3i	3



MAIN APPLICATIONS

50 005 121



MAZDA

POS

323 1.8i 16V	32
323 1.8i 16V Turbo	34
323 1.8i Turbo	31
MX-5 1.6i 16V	17

50 005 123



Sapporo 2.4i	68
Shogun 2.3 TD	69
Shogun 2.5 TD	70
Sigma 2.3 TD	72
Space Gear 2.5 TD	73
Strada Gear 2.5 TD	79
L 200 2.3 TD	81
L 200 2.5 TD	82
L 300 2.3 TD	83
L 300 2.4i	84
L 300 2.5 TD	85
L 400 2.5 TD	86

50 005 124



HYUNDAI

POS

Galloper I 2.5 TD	8
Galloper II 2.5 TD	9
H1 2.5 TD	32
H100 2.5 TD	15
Satellite 2.5 TD	27
Starex 2.5 TD	41

KIA

POS

Pregio 2.5 TD	3
---------------	---

MAZDA

POS

Pajero 2.5 TD	61
L 200 2.5 TD	82

50 005 125



MAZDA

POS

Colt 1.6i	20
Colt 1.6i 16V	21
Lancer 1.6i 16V	42
Pajero Pinin 1.8 GDi 16V	58

FORD

POS

Bronco 2.3 TD	1
---------------	---

HYUNDAI

POS

Galloper I 2.5 TD	8
Galloper II 2.5 TD	9
H100 2.5 TD	15

MAZDA

POS

Canter 2.3 TD	1
Canter 2.5 TD	2
Delica 2.5 TD	22
Galant 2.3 TD	28
Galant 2.4	29
Montero 2.5 TD	56
Pajero 2.3 TD	60
Pajero 2.5 TD	61

50 005 126



MAZDA

POS

Chariot 2.0 D	10
Chariot 2.0 TD	11
Colt 2.0 TD	13
Eterna 2.0 TD	25
Galant 2.0 TD	27
Lancer 2.0 D	34
Lancer 2.0 TD	35
Libero 2.0 D	46
Libero 2.0 TD	47
Mirage 2.0 D	55
Mirage 2.0 TD	49
RVR 2.0 TD	66
Space Runner 2.0 TD	74
Space Wagon 2.0 TD	78

50 005 127



MAZDA

POS

Canter 2.8 D	3
Pajero 2.8 D	62
Pajero 3.2 TD	64

50 005 128



CHRYSLER

POS

Voyager I 3.0	5
---------------	---

HYUNDAI

POS

Galloper II 3.0i	10
Sonata I 3.0i V6	51
Sonata II 3.0i	60
Sonata III 3.0i	61

MAZDA

POS

Eterna 2.0i Turbo	23
Galant 2.0i Turbo	31
Lancer 2.0i Turbo	33
Mirage 2.0i Turbo	54
Pajero 2.0	59





MAIN APPLICATIONS

50 005 128	
Pajero 3.0	63
RVR 2.0i Turbo	65
Sapporo 2.0 Turbo	67

50 005 129	
	
MITSUBISHI	POS
Eterna 2.0i 24V	24
Galant 2.0i 24V	26
Galant 2.5i V6 24V	30
Legnum 2.0i 24 V	44
Sigma 2.0i 24 V	71

50 005 132	
	
AUDI	POS
A3 1.9 TDI	9
SEAT	POS
Cordoba 1.9 SDI	35
Cordoba 1.9 TDI	34
Ibiza 1.9 SDI	55
Ibiza 1.9 TDI	57
Inca 1.9 SDI	65
Leon 1.9 SDi	75
Leon 1.9 TDI	74
Toledo 1.9 TDI	91
SKODA	POS
Octavia 1.9 SDi	22
Octavia 1.9 TDI	21
VOLKSWAGEN	POS
Bora 1.9 SDI	7
Bora 1.9 TDI	8
Caddy 1.9 SDI	25
Caddy 1.9 TDI	24
Gol 1.9 TDI	88
Golf IV 1.9 SDI	133
Golf IV 1.9 TDI	134
Jetta 1.9 SDI	177
Jetta 1.9 TDI	176
New Beetle 1.9 TDI	224
Polo 1.9 SDI	291
Polo 1.9 TDI	292
Polo Classic 1.9 TDI	296

50 005 133	
	
MITSUBISHI	POS
Carisma 1.3i 16V	4
Colt 1.3i 12V	15
Colt 1.3i 16V	16
Colt 1.5i	19
Lancer 1.3i 12V	37
Lancer 1.3i 16V	38
Lancer 1.5i	41
Legnum 1.3i 12V	43
Libero 1.3i 12V	45
Mirage 1.3i 12V	51
Space Star 1.3i 16V	75

50 005 134	
	
MITSUBISHI	POS
Carisma 1.6i 16V	5
Carisma 1.8 GDi 16V	7
Carisma 1.8i 16V	6
Pajero Pinin 1.8 GDi 16V	58
Pajero io 1.8 GDI 16V	57
Space Star 1.8 GDi 16V	76

50 005 135	
	
NISSAN	POS
Patrol 2.8 TD	30
Patrol GR 2.8 TD	31

50 005 136	
	
NISSAN	POS
100 NX 2.0 GTI	3
Almera 2.0i 16V	7
Almera Tino 2.0 16V	11
Prairie 2.0i 16V	34
Primera 2.0i 16V	43
Primera Traveller 2.0i 16V	48
Pulsar 2.0i 16V	50
Serena 2.0 16V	53
Sunny 2.0i 16V	58

50 005 137	
	
SEAT	POS
Arosa 1.0i	13
Arosa 1.4i	14
Cordoba 1.0i	19
Cordoba 1.4i	23
Ibiza 1.0i	39
Ibiza 1.4i	44
Inca 1.4i	60
VOLKSWAGEN	POS
Caddy 1.4i	14
Lupo 1.0i	210
Lupo 1.4i	212
Polo 1.0i	270
Polo 1.4i	280
Engine	393

50 005 138	
	
SEAT	POS
Terra 1.3 D	79



MAIN APPLICATIONS

50 005 138



VOLKSWAGEN	POS
Polo 1.3 D	279
Polo 1.4 D	283

50 005 139



SEAT	POS
Arosa 1.4i	14
Cordoba 1.4i	23
Cordoba 1.6i	27
Ibiza 1.4i	44
Ibiza 1.6i	48
Inca 1.4i	60
Inca 1.6i	62
SKODA	POS
Felicia 1.6i	12
Octavia 1.6i	16
VOLKSWAGEN	POS
Caddy 1.4i	14
Caddy 1.6i	19
Gol 1.4i	77
Gol 1.6i	79
Golf III 1.4i	115
Golf III 1.6i	116
Polo 1.05i	272
Polo 1.3i	277
Polo 1.4i	280
Polo 1.6i	285
Vento 1.4i	383
Vento 1.6i	384

50 005 140



AUDI	POS
Fox 1.6	89
80 1.3	96
80 1.5	97
80 1.6	98
80 1.6 D	100
80 1.6i	99
80 1.7	102
100 1.6i	125
4000 1.6	145
4000 1.6 D	146
VOLKSWAGEN	POS
Caddy 1.5	17
Campmobil 1.6	41
Campmobil 1.6 D	42
Campmobil 1.6 TD	43
Dasher 1.5 D (USA)	56
Dasher 1.6 (USA)	57

50 005 140



Fox 1.6 (USA)	73
Golf I 1.5	95
Golf I 1.5 D	96
Golf I 1.6	97
Golf I 1.6i	98
Ilitis 1.7	157
Jetta 1.5	163
Jetta 1.6	164
Jetta 1.6 D	169
Jetta 1.6 TD	170
Jetta 1.6i	165
Passat 1.3	233
Passat 1.5	234
Passat 1.5 D	235
Passat 1.6	236
Passat 1.6 D	239
Passat 1.6 TD	240
Passat 1.6i	237
Pickup 1.6 (USA)	266
Quantum 1.6 D	308
Rabbit 1.5	312
Rabbit 1.5 D	313
Rabbit 1.6	314
Rabbit 1.6 D	315
Santana 1.6	320
Santana 1.6 D	321
Santana 1.6 TD	322
Scirocco 1.5	336
Scirocco 1.5i	337
Scirocco 1.6	338
Scirocco 1.6i	339
Transporter T2 1.6	360
Transporter T2 1.6 D	365
Transporter T3 1.6 TD	366
Vanagon 1.6 D	380

50 005 141



NISSAN	POS
Almera 1.8i 16V	6
Almera Tino 1.8i 16V	10
Primera 1.8i 16V	39
Primera Traveller 1.8i 16V	46
Sentra 1.8i 16V	51
Wingroad 1.8 16V	68

50 005 142



AUDI	POS
Fox 1.3	88
50 1.1	94
50 1.3	95
80 1.3	96
4000 1.3	144
VOLKSWAGEN	POS
Derby 0.9	58
Derby 1.0i	59
Derby 1.1	60
Derby 1.3	61
Derby 1.3i	62
Fox 1.3	70
Gol 1.05	75
Gol 1.3i	76
Golf I 1.1	93
Golf I 1.3	94
Golf II 1.05	103
Golf II 1.3	104
Golf II 1.3i	105
Jetta 1.05	158
Jetta 1.1	159
Jetta 1.3	160
Jetta 1.3i	161
Passat 1.3	233
Polo 0.8	268
Polo 0.9	269
Polo 1.05	271
Polo 1.05i	272
Polo 1.0i	270
Polo 1.1	273
Polo 1.3	276
Polo 1.3i	277
Polo 1.3i G40	278
Quantum 1.3	307
Santana 1.3	319
Scirocco 1.1	334
Scirocco 1.3	335

50 005 145



AUDI	POS
Coupé 1.9i	77
Coupé 2.0i	78
Coupé 2.1i	81
Coupé 2.2i	82



MAIN APPLICATIONS

50 005 145		50 005 146		50 005 148	
Coupé 2.3i	84	VOLVO	POS	Cordoba 2.0i 16V	37
Quattro 2.2i Turbo 20V	90	240 2.4 D	9	Ibiza 1.6i	48
Quattro 2.2i Turbo 25V	91	740 2.4 D	35	Ibiza 1.8i	50
80 1.9i	105	760 2.4 D	39	Ibiza 1.8i 16V	51
80 2.0i	109	780 2.4 TDi	40	Ibiza 1.9 D	54
80 2.1i	111	940 2.4 D	53	Ibiza 1.9 SDI	55
80 2.2i	112	960 2.4 TD	62	Ibiza 1.9 TD	56
80 2.3i	114			Ibiza 1.9 TDI	57
90 2.0i	120			Ibiza 2.0i	58
90 2.2i	122			Ibiza 2.0i 16V	59
90 2.3i	123			Inca 1.6i	62
100 1.9i	128			Inca 1.7 SDI	63
100 2.0i	129			Inca 1.9 D	64
100 2.2	133			Inca 1.9 SDI	65
100 2.2i	134			Toledo 1.6i	82
100 2.2i Turbo	135			Toledo 1.8i	85
100 2.3i	136			Toledo 1.8i 16V	86
200 2.2i	141			Toledo 1.9 D	89
200 2.2i Turbo	143			Toledo 1.9 TD	90
200 2.2i Turbo 20V	142			Toledo 1.9 TDI	91
4000 2.2i	148			Toledo 2.0i	92
5000 2.2i	151			Toledo 2.0i 16V	93
5000 2.3i	152			VOLKSWAGEN	POS
VOLKSWAGEN	POS	AUDI	POS	Caddy 1.5	17
Passat 1.9i	247	A4 1.9 TDI	18	Caddy 1.6	18
Passat 2.0i	251	A6 1.9 TDI	31	Caddy 1.6 D	20
Passat 2.1i	257	A6 2.0i	32	Caddy 1.6i	19
Passat 2.2i	258	A6 2.0i 16V	33	Caddy 1.7 SDI	21
Quantum 2.0i	310	Cabriolet 1.9 TDI	68	Caddy 1.8i	22
Quantum 2.2i	311	Cabriolet 2.0i	69	Caddy 1.9 D	23
Santana 1.8i	324	Cabriolet 2.0i 16V	70	Caddy 1.9 SDI	25
Santana 1.9i	325	Coupé 1.6	74	Caddy 1.9 TDI	24
Santana 2.0i	326	Coupé 1.8	75	California 1.8i	31
Santana 2.1i	327	Coupé 1.8i	76	California 1.9 D	32
		Coupé 2.0i	78	California 1.9 TD	33
		Coupé 2.0i 16V	79	California 2.0i	35
		Fox 1.6	89	Campmobil 1.6	41
		80 1.3	96	Campmobil 1.6 D	42
		80 1.6	98	Campmobil 1.6 TD	43
		80 1.6 D	100	Corrado 1.8i 16V	49
		80 1.6 TD	101	Corrado 1.8i G60	50
		80 1.6i	99	Corrado 2.0i	51
		80 1.7	102	Corrado 2.0i 16V	52
		80 1.8	103	Dasher 1.6 (USA)	57
		80 1.8i	104	Derby 1.8i	63
		80 1.9 D	106	Fox 1.8 (USA)	74
		80 1.9 TD	107	Gol 1.6	78
		80 1.9 TDI	108	Gol 1.6 D	80
		80 1.9i	105	Gol 1.6 TD	81
		80 2.0i	109	Gol 1.6i	79
		80 2.0i 16V	110	Gol 1.8	82
		90 1.6 TD	117	Gol 1.8i	83
		90 1.8	118	Gol 1.8i 16V	84
		90 1.8i	119	Gol 1.9 D	86
		100 1.6i	125	Gol 1.9 SDI	89
		100 1.8	126	Gol 1.9 TD	87
		100 1.8i	127	Gol 1.9 TDI	88
		100 2.0i	129	Gol 2.0i	90
		100 2.0i 16V	130	Gol 2.0i 16V	91
		4000 1.6 D	146	Golf I 1.5	95
		4000 1.8	147	Golf I 1.6 D	99
		FORD	POS	Golf I 1.6i	98
		Galaxy 1.9 TDI	53	Golf I 1.7i	101
		SEAT	POS	Golf I 1.8i	102
		Alhambra 1.9 TDI	5	Golf II 1.6	106
		Alhambra 2.0i	6	Golf II 1.6 D	108
		City Golf 1.6i (CN)	18	Golf II 1.6 TD	109
		Cordoba 1.6i	27	Golf II 1.6i	107
		Cordoba 1.8i	29	Golf II 1.8	110
		Cordoba 1.8i 16V	30	Golf II 1.8i	111
		Cordoba 1.9 D	32		
		Cordoba 1.9 SDI	35		
		Cordoba 1.9 TD	33		
		Cordoba 1.9 TDI	34		
		Cordoba 2.0i	36		



MAIN APPLICATIONS



MAIN APPLICATIONS

50 005 153



Ibiza 1.05i	41
Ibiza 1.3	43
Ibiza 1.4i	44
Ibiza 1.6i	48
VOLKSWAGEN	POS
Gol 1.05	75
Gol 1.3i	76
Golf II 1.05	103
Golf II 1.3i	105
Golf III 1.4i	115
Golf III 1.6i	116
Jetta 1.05	158
Jetta 1.3	160
Jetta 1.3i	161
Polo 1.05	271
Polo 1.05i	272
Polo 1.3	276
Polo 1.3i	277
Polo 1.3i G40	278
Vento 1.4i	383
Vento 1.6i	384

50 005 154



AUDI	POS
A2 1.4i 16V	2
SEAT	POS
Arosa 1.4i 16V	15
Cordoba 1.4i 16V	24
Ibiza 1.4i 16V	45
Inca 1.4i 16V	61
Leon 1.4i 16V	66
Toledo 1.4i 16V	80
SKODA	POS
Fabia 1.4 FSI 16V	6
Fabia 1.4i 16V	5
Octavia 1.4 FSI 16V	15
Octavia 1.4i 16V	14
VOLKSWAGEN	POS
Bora 1.4i 16V	1
Caddy 1.4 FSI 16V	16
Caddy 1.4i 16V	15
Golf IV 1.4i 16V	127
Golf V 1.4 FSI 16V	141
Golf V 1.4i 16V	140
Golf Plus 1.4 FSI 16V	150
Golf Plus 1.4i 16V	151
Jetta 1.4i 16V	162
Lupo 1.4i 16V	213
New Beetle 1.4i 16V	221
Polo 1.4 FSI 16V	282
Polo 1.4i 16V	281
Polo Sedan 1.4 FSI 16V	298
Polocross 1.4 FSI 16V	303
Polocross 1.4i 16V	302

50 005 155



AUDI	POS
A4 1.6i	14
A4 1.8i	15
A4 1.8i 20V	16
A4 1.8i Turbo 20V	17
A6 1.8i	28
A6 1.8i 20V	29
A6 1.8i Turbo 20V	30
Cabriolet 1.8i 20V	67
VOLKSWAGEN	POS
Passat 1.6	236
Passat 1.8i	242
Passat 1.8i 20V	244
Passat 1.8i Turbo 20V	245

50 005 156



AUDI	POS
A4 1.6i	14
A4 1.8i	15
A4 1.8i 20V	16
A4 1.8i Turbo 20V	17
A6 1.8i	28
A6 1.8i 20V	29
A6 1.8i Turbo 20V	30
Cabriolet 1.8i 20V	67
VOLKSWAGEN	POS
Passat 1.6	236
Passat 1.8i	242
Passat 1.8i 20V	244
Passat 1.8i Turbo 20V	245

50 005 158



AUDI	POS
A4 1.9 TDI	18
A6 1.9 TDI	31
SEAT	POS
Arosa 1.7 SDI	17
Ibiza 1.9 TDI	57

50 005 158



SKODA	POS
Felicia 1.9 D	13
VOLKSWAGEN	POS
Caddy 1.9 D	23
Gol 1.9 SDI	89
Lupo 1.7 SDI	217
Passat 1.9 TDI	250
Passat 2.3i 20V	259
Polo 1.7 SDI	287
Polo 1.9 D	290
Polo 1.9 SDI	291
Polo 1.9 TDI	292
Vento 1.9 SDI	389
Vento 1.9 TDI	388

50 005 159



SEAT	POS
Toledo 2.3i 20V	96
Toledo 2.3i 25V	97
VOLKSWAGEN	POS
Bora 2.3i 20V	11
Bora 2.3i 25V	12
Golf III 2.3i 20V	124
Golf IV 2.3i 25V	137
New Beetle 2.3i 25V	226
Passat 2.3i 20V	259

50 005 160



VOLKSWAGEN	POS
Campmobil 1.9	44
Campmobil 1.9i	45
Transporter T2 1.9	362
Transporter T2 1.9i	363
Vanagon 1.9	381



MAIN APPLICATIONS

50 005 162



VOLKSWAGEN	POS
Campmobil 2.1i	46
Transporter T2 2.1i	364
Vanagon 2.1i	382

50 005 163



VOLKSWAGEN	POS
California 2.4 D	36
California 2.5i	37
Caravelle 2.4 D	48
EuroVan 2.4 D	67
EuroVan 2.5i	68
Transporter T4 2.4 D	371
Transporter T4 2.5i	372

50 005 164



MERCEDES-BENZ	POS
Sprinter 214 2.3	132
Sprinter 314 2.3	140
Sprinter 414 2.3	149
Vito 113 2.0	183
VOLKSWAGEN	POS
LT 28	183
LT 31	188
LT 35	192
LT 40	197
LT 45	200
LT 46	203

50 005 164

LT 50	205
LT 55	208

50 005 165



FORD	POS
Galaxy 2.8i VR6 24V	56
Galaxy VR6 2.8i	55
MERCEDES-BENZ	POS
V 280 (638)	158
SEAT	POS
Alhambra 2.8i 24V	7
Leon 2.8i Cupra 4 24V	78
VOLKSWAGEN	POS
Bora 2.8i VR6 24V	13
California 2.8i VR6	39
Corrado 2.8i VR6 (USA)	53
Corrado 2.9i VR6	54
EuroVan 2.8i	69
Gol 2.8i VR6	92
Golf III VR6 2.8i	125
Golf III VR6 2.9i	126
Golf IV 2.8i VR6 24V	138
Jetta 2.8i VR6	181
Jetta 2.8i VR6 24V	182
Passat 2.8i VR6	262
Passat 2.9i VR6	265
Sharan 2.8i VR6	347
Sharan 2.8i VR6 24V	348
Transporter T4 2.8i VR6	374
Vento 2.8i VR6	392

50 005 166



AUDI	POS
A4 2.6i	25
A4 2.8i 30V	27
A6 2.6i	40
A6 2.8i	42
A6 2.8i 24V	43
A6 2.8i 30V	44
A8 2.8i	50

50 005 166

A8 2.8i 30V	51
Cabriolet 2.8i	72
Cabriolet 2.8i	73
Coupé 2.6i	86
Coupé 2.8i	87
80 2.6i	115
80 2.8i	116
100 2.8i	140
VOLKSWAGEN	POS
Passat 2.8i VR6 30V	264

50 005 167



AUDI	POS
A4 2.4i 30V	22
A4 2.6i	25
A4 2.8i 24V	26
A4 2.8i 30V	27
A6 2.4i 30V	37
A6 2.6i	40
A6 2.7i Turbo 30V	41
A6 2.8i	42
A6 2.8i 24V	43
A6 2.8i 30V	44
A8 2.8i	50
A8 2.8i 30V	51
S4 2.7i 30V	61
Cabriolet 2.6i	72
Cabriolet 2.8i	73
Coupé 2.6i	86
Coupé 2.8i	87
80 2.6i	115
80 2.8i	116
SKODA	POS
Superb 2.8i 30V	36
VOLKSWAGEN	POS
Passat 2.8i V6 24V	263
Passat 2.8i VR6 30V	264

50 005 168



AUDI	POS
A4 2.5 TDI	23
A4 2.5 TDI 24V	24
A6 2.5 TDI	38
A6 2.5 TDI 24V	39
A6 Allroad 2.5 TDI 24V	47
A8 2.5 TDI	49



MAIN APPLICATIONS

50 005 168



SKODA	POS
Superb 2.5 TDI 24V	35
VOLKSWAGEN	POS
Passat 2.5 TDI	260
Passat 2.5 TDI 24V	261

50 005 169



NISSAN	POS
Almera 2.0 D	8
Primera 2.0 D	41
Primera 2.0 TD	42
Primera Traveller 2.0 TD	47
Sunny 2.0 D	57

50 005 170



DACIA	POS
Logan 1.6i 16V	2
NISSAN	POS
Kubistar 1.6i 16V	22
RENAULT	POS
Clio II 1.4i 16V	15
Clio II 1.6i 16V	18
Clio III 1.4i 16V	23
Clio III 1.6i 16V	25
Grand Scénic 1.6i 16V	52
Kangoo 1.5 dCi	56
Kangoo 1.6i 16V	58
Laguna I 1.6i 16V	62
Laguna II 1.6i 16V	72
Laguna Grandtour 1.6i 16V	78
Mégane 1.4i 16V	106
Mégane 1.6i 16V	108
Mégane Classic 1.4i 16V	117
Mégane Classic 1.6i 16V	119
Mégane Grandtour 1.4i 16V	126
Mégane Grandtour 1.6i 16V	128
Mégane II 1.4i 16V	134
Mégane II 1.6i 16V	136
Modus 1.4i 16V	142
Modus 1.6i 16V	144
Scénic 1.4i 16V	223
Scénic 1.6i 16V	225
Scénic II 1.4i 16V	233
Scénic II 1.6i 16V	235
Symbol 1.4i 16V	241
Thalia II 1.4i 16V	245

50 005 171



NISSAN	POS
Almera 1.5 dCi	4
Kubistar 1.5 dCi	21
Micra 1.5 dCi	28
RENAULT	POS
Clio II 1.5 dCi	16
Clio III 1.5 dCi	24
Kangoo 1.5 dCi	56
Mégane II 1.5 dCi	135
Modus 1.5 dCi	143
Scénic II 1.5 dCi	234
Symbol 1.5 dCi	242
Thalia II 1.5 dCi	246

SUZUKI	POS
Jimny 1.5 DDiS	15

50 005 172



NISSAN	POS
100 NX 1.6 16V	2
100 NX 1.6i 16V	1
Almera 1.6i 16V	5
Primera 1.6 16V	37
Primera 1.6i 16V	38
Primera Traveller 1.6i 16V	45
Pulsar 1.6i 16V	49
Serena 1.6i 16V	52
Sunny 1.6 16V	55
Sunny 1.6i 16V	56
Vanette 1.6i 16V	66

50 005 173



ISUZU	POS
Fargo 2.7 D	3
NISSAN	POS
Cabstar 2.5 D	14
Pick-up 2.5 D	32

50 005 173



Pick-up 2.7 D	33
Terrano 2.7 D	59
Trade 2.5 D	63
Urvan 2.5 D	64
Urvan 2.7 D	65

50 005 174



FORD	POS
Maverick 2.7 TD	65
NISSAN	POS
Bluebird 2.0 D	13
Patrol 2.7 TD	29
Serena 2.0 D	54
Terrano 2.7 TD	60
Terrano II 2.7 TD	61
Vanette 2.0 D	67

50 005 175



NISSAN	POS
Terrano II 2.7 TDi	62

50 005 176



SUBARU	POS
Forester 2.0i 16V	1
Forester 2.0i Turbo 16V	2
Impreza 1.6i 16V	3
Legacy 2.2i 16V	4
Legacy 3.0i 24V	6



MAIN APPLICATIONS

50 005 177



SUBARU	POS
Justy 1.3i	5
SUZUKI	POS
Alto 1.0i	3
Alto 1.1i 16V	4
Baleno 1.3i 16V	5
Carry 1.3i 16V	8
Jimny 1.3i 16V	14
Samurai 1.3i	26
Swift 1.3i	32
Swift 1.3i 16V	33
Wagon R+ 1.3i 16V	40

50 005 178



SUZUKI	POS
Samurai 1.3	25
SJ 413 1.3	28

50 005 179



SUZUKI	POS
Baleno 1.6i 16V	6
Baleno 1.8i 16V	7
Grand Vitara 1.6i 16V	10
Swift 1.6i 16V	34
Vitara 1.6i	37
Vitara 1.6i 16V	38
X-90 1.6i 16V	42

50 005 180



FIAT / IVECO	POS
Sedici 1.6i 16V	93
SUBARU	POS
Justy 1.3i 16V	7
Justy 1.5 16V	9
SUZUKI	POS
Aerio 1.3i 16V	1
Aerio 1.5i 16V	2
Escudo 1.6i 16V	9
Grand Vitara 1.6i 16V	10
Ignis 1.3i 16V	12
Jimny 1.3i 16V	14
Liana 1.3i 16V	16
Liana 1.5i 16V	17
New Ignis 1.3i 16V	18
New Ignis 1.5i 16V	20
New Swift 1.5i 16V	22
New Swift 1.6i 16V	23
New Swift R+ 1.3i 16V	24
Samurai 1.3i 16V	27
Solio 1.3i 16V	29
Swift 1.3i 16V	33
SX4 1.5i 16V	35
SX4 1.6i 16V	36
Vitara 1.6i 16V	38
Wagon R+ 1.3i 16V	40

50 005 181



AUDI	POS
A8 3.7i 32V	53
A8 4.2i 32V	55
S6 4.2i 32V	63
S8 4.2i 32V	65

50 005 182



DAIHATSU	POS
Delta 2.0 D	9

50 005 182

TOYOTA	POS
Avensis I 2.0 D-4D	11
Caldina 2.2 TD	32
Camry 2.0 D	34
Camry 2.2 TD	36
Carina I 1.8 D	40
Carina II 2.0 D	43
Carina E 2.0 D	47
Carina E 2.0 TD	48
Corolla 1.8 D	69
Corolla 2.0 D	70
Corona 1.8 D	79
Corona 2.0 D	81
Corona 2.2 TD	82
Gaia 2.2 TD	101
Ipsum 2.2 TD	111
LiteAce 1.8 D	125
LiteAce 2.0 D	126
Model F 2.0 D	133
Picnic 2.2 TD	144
Sprinter 1.8 D	177
Sprinter 2.0 D	178
Vista 2.2 TD	197

50 005 183



TOYOTA	POS
Allion 1.8i 16V	2
Auris 1.4i 16V	5
Avensis I 1.6i 16V	8
Avensis I 1.8i 16V	9
Avensis II 1.6i 16V	13
Caldina 1.8i 16V	30
Celica 1.8i 16V	50
Corolla 1.4i 16V	64
Corolla 1.6i 16V	67
Corolla 1.8i 16V	68
Corolla Verso 1.6i 16V	73
Corolla Verso 1.8i 16V	74
Isis 1.8i 16V	113
Matrix 1.8i 16V	131
Opa 1.8i 16V	139
Premio 1.8i 16V	153
RAV4 1.8i 16V	164
Spacio 1.8i 16V	171
Vista 1.8i 16V	195
Wish 1.8i 16V	206

50 005 184



TOYOTA	POS
Avensis I 1.6i 16V	8
Carina II 1.6i 16V	41

MAIN APPLICATIONS



MAIN APPLICATIONS

50 005 184



Carina E 1.6i 16V	44
Celica 1.6i 16V dopp	49
Conquest 1.6i 16V	58
Corolla 1.6i 16V	67
Corona 1.6i 16V	77
Spacio 1.6i 16V	170
Sprinter 1.6i 16V	175

50 005 186



TOYOTA	POS
Blizzard 2.4 D	28
Blizzard 2.4 TD	29
Chaser 2.4 D	53
Chaser 2.4 TD	54
Cressida 2.4 D	85
Cresta 2.4 D	88
Cresta 2.4 TD	89
Crown 2.4 D	90
Dyna 100 2.5 D	95
Dyna 150 2.5 D	96
Dyna 150 2.8 D	97
HiAce 2.4 D	103
HiAce 2.4 TD	104
HiAce 2.8 D	105
HiLux 2.4 D	107
HiLux 2.4 TD	108
Land Cruiser 2.4 D	118
Land Cruiser 2.4 TD	119
Land Cruiser 2.8 D	120
Mark II 2.4 D	128
Mark II 2.4 TD	129
Prado 2.4 D	150
Prado 2.4 TD	149
Prado 2.8 D	151
ToyoAce 2.4 D	190
4-Runner 2.4 TD	214
4-Runner 2.8 D	215

50 005 187



DAIHATSU	POS
Delta 2.0i 16V	10

TOYOTA	POS
Avensis I 2.0i 16V	10
Caldina 2.0i 16V	31

50 005 187



Camry 2.0i 16V	33
Camry 2.2i	35
Camry Solara 2.2i 16V	38
Carina II 2.0i 16V	42
Carina E 2.0i 16V	46
Celica 2.0i 16V	51
Celica 2.2i	52
Corona 1.8i 16V	78
Corona 2.0i 16V	80
Cresta 1.8i 16V	87
Curren 1.8i 16V	92
Curren 2.0i 16V	93
Gaia 2.0i 16V	100
Ipsium 2.0i 16V	109
Mark II 1.8i 16V	127
MR2 2.0i 16V	134
MR2 2.2i 16V	135
Nadia 2.0i 16V	136
Picnic 2.0i 16V	143
RAV4 2.0i 16V	165
Vista 2.0i 16V	196
Windom 2.0i 16V	205

50 005 188



TOYOTA	POS
Allion 1.5i 16V	1
Auris 1.5i 16V	6
Avanza 1.5i 16V	7
bB 1.3i 16V	22
bB 1.5i 16V	23
Belta 1.3i 16V	24
Belta 1.5i 16V	25
Blade 1.5i 16V	26
Corolla 1.3i 16V	63
Corolla 1.5i 16V	66
Echo 1.5i 16V	98
Ist 1.4 D-4D	115
Ist 1.5i 16V	116
Platz 1.3i 16V	145
Platz 1.5i 16V	146
Porte 1.3i 16V	147
Porte 1.5i 16V	148
Premio 1.5i 16V	152
Prius 1.5i 16V	157
Probox 1.3i 16V	158
Probox 1.5i 16V	159
Ractis 1.5i 16V	162
Raum 1.5i 16V	163
Scion xD 1.5i 16V	167
Sienta 1.5i 16V	168
Spacio 1.5i 16V	169
Succeed 1.5i 16V	186
Urban Cruiser 1.5i 16V	191
Vios 1.3i 16V	193
Vios 1.5i 16V	194
Vitz 1.3i 16V	199

50 005 188



Vitz 1.4 D-4D	200
Vitz 1.5i 16V	201
Will 1.3i 16V	203
Will 1.5i 16V	204
Yaris I 1.3i 16V	209
Yaris I 1.4 D-4D	210
Yaris I 1.5i 16V	211
Yaris Verso 1.4 D-4D	212
Yaris Verso 1.5i 16V	213

50 005 189



DAIHATSU	POS
Sirion 1.3 i 16V	18
YRV 1.3 i 16V Turbo	20

TOYOTA	POS
Vitz 1.0i 16V	198
Yaris I 1.0i 16V	208

50 005 192



TOYOTA	POS
Blizzard 2.4 TD	29
Chaser 2.4 TD	54
Cressida 2.4 TD	86
Cresta 2.4 TD	89
Crown 2.4 TD	91
Land Cruiser 2.4 TD	119
Mark II 2.4 TD	129
Prado 2.4 TD	149

50 005 193



TOYOTA	POS
Coaster 4.2 D	55
Coaster 4.2 TD	56



50 005 193	
Cygnus 4.2 TD	94
Land Cruiser 4,2 TD 24V	123
Land Cruiser 4.2 D	121
Land Cruiser 4.2 TD	122

50 005 194



TOYOTA		POS
Conquest 1.3i 16V	57	
Corolla 1.3	60	
Corolla 1.3 12V	61	
Corolla 1.3i 12V	62	
Corolla 1.3i 16V	63	
Corolla 1.5 12V	65	
Corolla 1.5i 16V	66	
Corona 1.5 12V	76	
Corsa 1.3 16V	83	
Corsa 1.5i 16V	84	
Paseo 1.3i 16V	141	
Paseo 1.5i 16V	142	
Raum 1.5i 16V	163	
Sprinter 1.3 12V	173	
Sprinter 1.3 16V	174	
Starlet 1.3	182	
Starlet 1.3 12V	183	
Starlet 1.3i 16V	184	
Starlet 1.5 12V	185	
Tercel 1.5 12V	188	
Tercel 1.5i 16V	189	

50 005 196



DAIHATSU		POS
Charmant 1.3	8	

TOYOTA		POS
Corolla 1.2	59	
Corolla 1.3	60	
LiteAce 1.3	124	
Publica 1000	160	
Publica 1200	161	
Sprinter 1.2	172	
Starlet 1.0	179	
Starlet 1.0 12V	180	
Starlet 1.2	181	
Starlet 1.3	182	

50 005 197



TOYOTA		POS
Avensis I 1.8i 16V	9	
Avensis II 1.8i 16V	14	
Caldina 1.8i 16V	30	
Carina E 1.8i 16V	45	
Celica 1.8i 16V	50	
Corolla 1.8i 16V	68	
Corona 1.8i 16V	78	
Curren 1.8i 16V	92	
Sprinter 1.8i 16V	176	

50 005 198



TOYOTA		POS
Avensis I 2.0 D-4D 16V	12	
Avensis II 2.0 D-4D 16V	16	
Avensis Verso 2.0 D-4D 16V	19	
Corolla 2.0 4-4D 16V	71	
Corolla Verso 2.0 D-4D 16V	75	
Ipsium 2.0 D-4D 16V	110	
Previa 2.0 D-4D 16V	155	
RAV4 2.0 D-4D 16V	166	

50 005 203



MERCEDES-BENZ		POS
Series 1113	698	
Series 1216	709	
Series 1313	722	

50 005 203

Series 1317	725
Series 1413	729
Series 1417	731
Series 1517	746
Series 1519	748
Series 1617	755
Series 1621	759
Engine	992

50 005 205



MAN		POS
Series F 292	341	
Series FR 292	378	
Series FRH 292	379	
Series HF 292	388	
Series R 292	415	
Series SG 240	435	
Series SG 242	436	
Series SG 292	439	
Series SR 292	447	
Series SUE 240	452	
Engine	513	

MERCEDES-BENZ		POS
Series 1644	774	
Series 1650	775	
Series 2444	883	
Series 2636	916	
Series 2645	920	
Series 3036	933	
Series 3250	947	
Series 3336	953	
Series 3536	960	
Series 3820	967	
Series 3850	971	
Series 4050	973	
Series 4436	976	
Series 4850	984	
Series 5436	990	
Series 6036	991	
Engine	992	

50 005 206



MAZDA		POS
3 1.4i 16V	35	
3 1.6i 16V	45	



50 005 207



HANOMAG

POS

Series F 130	6
Series F 193	8
Series F 263	9

MAN

POS

Series 14.220	36
Series 15.200	44
Series 15.220	45
Series 15.240	47
Series 16.200	50
Series 16.220	51
Series 16.232	52
Series 16.240	53
Series 16.256	55
Series 16.280	56
Series 16.320	57
Series 17.220	61
Series 17.240	64
Series 17.241	65
Series 18.241	71
Series 19.200	83
Series 19.240	84
Series 19.256	86
Series 19.280	89
Series 19.320	95
Series 20.280	118
Series 20.320	121
Series 22.220	127
Series 22.240	128
Series 22.280	129
Series 22.320	133
Series 24.220	149
Series 24.240	152
Series 26.240	186
Series 26.256	188
Series 26.280	191
Series 26.320	197
Series 28.280	230
Series 30.232	241
Series 30.240	242
Series 30.256	243
Series 30.280	244
Series 30.320	249
Series 32.232	259
Series 32.240	260
Series 32.280	262
Series 32.320	268
Series 38.320	308

MERCEDES-BENZ

POS

O 303	499
O 305	501
O 307	502
Series 1019	697
Series 1219	712
Series 1419	733
Series 1424	736
Series 1619	757

50 005 207



Series 1624	761
Series 1626	763
Series 1632	768
Series 1719	779
Series 1819	797
Series 1916	814
Series 1919	815
Series 1924	820
Series 1926	822
Series 1928	824
Series 1932	827
Series 2026	840
Series 2032	844
Series 2219	852
Series 2224	856
Series 2226	858
Series 2232	861
Series 2624	906
Series 2626	907
Series 2628	909
Series 2632	912
Series 3332	950
Engine	992

50 005 210



HANOMAG

POS

Series F 130	6
Series F 193	8
Series F 263	9

MAN

POS

Series 11.168	13
Series 12.168	20
Series 13.168	28
Series 13.192	29
Series 14.168	34
Series 14.192	35
Series 14.220	36
Series 15.168	42
Series 15.192	43
Series 15.220	45
Series 15.240	47
Series 16.168	48
Series 16.192	49
Series 16.220	51
Series 16.232	52
Series 16.240	53
Series 16.256	55
Series 16.280	56
Series 16.320	57
Series 16.321	58
Series 17.220	61
Series 17.240	64
Series 17.241	65
Series 18.241	71
Series 19.168	81
Series 19.192	82
Series 19.240	84

50 005 210



Series 19.256	86
Series 19.280	89
Series 19.281	90
Series 19.320	95
Series 19.321	96
Series 20.192	117
Series 20.280	118
Series 20.281	119
Series 20.320	121
Series 20.321	122
Series 22.192	125
Series 22.220	127
Series 22.240	128
Series 22.280	129
Series 22.281	130
Series 22.320	133
Series 22.321	134
Series 24.192	148
Series 24.220	149
Series 24.240	152
Series 26.240	186
Series 26.256	188
Series 26.280	191
Series 26.281	192
Series 26.320	197
Series 26.321	198
Series 28.280	230
Series 30.232	241
Series 30.240	242
Series 30.256	243
Series 30.280	244
Series 30.281	245
Series 30.320	249
Series 30.321	250
Series 32.232	259
Series 32.240	260
Series 32.280	262
Series 32.281	263
Series 32.320	268
Series 32.321	269
Series 33.321	284
Series 38.320	308
Series 48.321	331
Engine	513

MERCEDES-BENZ

POS

Tourismo O 350	494
O 302	498
O 303	499
O 304	500
O 305	501
O 307	502
O 330	515
O 340	516
O 403	522
O 404	523
O 405	524
O 407	526
O 408	527
O 550 Integro	530
Series 1019	697
Series 1219	712
Series 1222	713
Series 1224	714
Series 1225	715
Series 1226	716
Series 1227	717
Series 1228	718
Series 1231	719
Series 1234	720
Series 1245	721



MAIN APPLICATIONS

50 005 210		50 005 210		50 005 210	
Series 1419	733	Series 2031	843	Series 2825	925
Series 1422	735	Series 2032	844	Series 2828	926
Series 1424	736	Series 2033	845	Series 2833	927
Series 1425	737	Series 2035	846	Series 3025	928
Series 1426	738	Series 2036	847	Series 3028	929
Series 1427	739	Series 2038	848	Series 3031	930
Series 1428	740	Series 2044	849	Series 3033	931
Series 1429	741	Series 2050	850	Series 3035	932
Series 1431	742	Series 2053	851	Series 3036	933
Series 1442	743	Series 2219	852	Series 3038	934
Series 1517	746	Series 2222	854	Series 3050	935
Series 1619	757	Series 2224	856	Series 3053	936
Series 1622	760	Series 2225	857	Series 3228	937
Series 1624	761	Series 2226	858	Series 3229	938
Series 1625	762	Series 2228	859	Series 3231	939
Series 1626	763	Series 2229	860	Series 3233	940
Series 1627	764	Series 2232	861	Series 3234	941
Series 1628	765	Series 2233	862	Series 3235	942
Series 1629	766	Series 2235	863	Series 3238	943
Series 1632	768	Series 2236	864	Series 3240	944
Series 1633	769	Series 2238	865	Series 3244	945
Series 1634	770	Series 2244	866	Series 3248	946
Series 1635	771	Series 2327	869	Series 3250	947
Series 1636	772	Series 2422	871	Series 3253	948
Series 1638	773	Series 2425	873	Series 3328	949
Series 1644	774	Series 2426	874	Series 3332	950
Series 1719	779	Series 2427	875	Series 3333	951
Series 1722	781	Series 2428	876	Series 3335	952
Series 1726	784	Series 2429	877	Series 3336	953
Series 1727	785	Series 2433	878	Series 3338	954
Series 1728	786	Series 2434	879	Series 3344	955
Series 1729	787	Series 2435	880	Series 3528	956
Series 1732	788	Series 2436	881	Series 3529	957
Series 1733	789	Series 2438	882	Series 3534	958
Series 1735	790	Series 2444	883	Series 3535	959
Series 1748	791	Series 2448	885	Series 3536	960
Series 1750	792	Series 2522	888	Series 3538	961
Series 1819	797	Series 2524	889	Series 3544	962
Series 1824	800	Series 2527	890	Series 3548	963
Series 1827	802	Series 2528	891	Series 3550	964
Series 1829	803	Series 2529	892	Series 3553	965
Series 1831	804	Series 2531	893	Series 3636	966
Series 1834	805	Series 2532	894	Series 3833	968
Series 1835	806	Series 2534	895	Series 3835	969
Series 1838	808	Series 2535	896	Series 3836	970
Series 1840	809	Series 2536	897	Series 4044	972
Series 1844	811	Series 2538	898	Series 4050	973
Series 1850	812	Series 2539	899	Series 4150	974
Series 1853	813	Series 2540	900	Series 4435	975
Series 1916	814	Series 2544	901	Series 4436	976
Series 1919	815	Series 2550	903	Series 4445	977
Series 1922	818	Series 2553	904	Series 4635	978
Series 1924	820	Series 2622	905	Series 4645	979
Series 1925	821	Series 2624	906	Series 4648	980
Series 1926	822	Series 2626	907	Series 4836	981
Series 1927	823	Series 2627	908	Series 4838	982
Series 1928	824	Series 2628	909	Series 4844	983
Series 1929	825	Series 2629	910	Series 4850	984
Series 1932	827	Series 2631	911	Series 4853	985
Series 1933	828	Series 2632	912	Series 4936	986
Series 1935	830	Series 2633	913	Series 5035	987
Series 1936	831	Series 2634	914	Series 5038	988
Series 1938	832	Series 2635	915	Series 5248	989
Series 1944	834	Series 2636	916	Series 5436	990
Series 1945	835	Series 2638	918	Series 6036	991
Series 1948	836	Series 2644	919	Engine	992
Series 2024	838	Series 2645	920		
Series 2025	839	Series 2648	921		
Series 2026	840	Series 2650	922		
Series 2027	841	Series 2653	923		
Series 2028	842	Series 2822	924		



MAIN APPLICATIONS

50 005 211



MERCEDES-BENZ		POS
O 302		498
Series 1621		759
Series 1624		761
Series 1921		817
Series 1924		820
Series 1928		824
Series 1929		825
Series 2024		838
Series 2223		855
Series 2224		856
Series 2624		906
Series 2628		909
Engine		992

50 005 214



SCANIA		POS
K 124		25
P 124		26
R 124		27
T 124		28
Century 12.35		33
Engine		41

50 005 215



FORD		POS
Cougar 2.0i 16V		6
Escort 1.6i 16V		16
Focus 1.8i 16V		38
Focus 2.0i 16V		41
Focus ST 170 2.0i 16V		42
Mondeo 1.6i 16V		66
Mondeo 1.8i 16V		67
Orion 1.6i 16V		79

50 005 215



Tourneo Connect 1.8i 16V	102
Transit Connect 1.8i 16V	112

50 005 216



FORD		POS
Fiesta 1.8 TDI		20
Focus 1.8 DI		39
Focus 1.8 TDCi		40
Focus C-Max 1.8 TDCi		46
Transit Connect 1.8 TDCi		113

50 005 217



CUMMINS		POS
Engine		1

VOLVO-BM		POS
EC 210		1
EW 170		2
EW 180		3

50 005 219



CUMMINS		POS
Engine		1

50 005 220



FORD		POS
Tractor 6610		124
Tractor 6710		125
Tractor 7610		126
Tractor 7710		127

50 005 221



SAAB		POS
90 2.0		12
99 2.0		13
900 I 2.0		14
900 I 2.0i Turbo		15
900 I 2.0i Turbo 16V		16
900 I 2.1 16V		17
9000 2.0i Turbo 16V		21

50 005 223



RENAULT		POS
Laguna I 3.0i		71
Laguna Grandtour 3.0i		90

SAAB		POS
9-3 2.0i 16V		3
9-3 2.0i Turbo 16V		4
9-3 2.3i 16V		6
9-3 2.3i Turbo 16V		7
9-5 2.3i Turbo 16V		10
900 II 2.0i Turbio 16V		18
9000 2.0i Turbo 16V		21



MAIN APPLICATIONS

50 005 224



OPEL	POS
Calibra 2.5i 24V	61
Omega B 2.5i 24V	177
Omega B 3.0i 24V	179
Sintra 3.0i 24V	204
Vectra A 2.5i 24V	222
Vectra B 2.5i 24V	231
Vectra B 500 2.5i 24V	232
SAAB	POS
9-5 3.0i Turbo 24V	11
900 II 2.5i 24V	19
9000 3.0i 16V	24
VAUXHALL	POS
Calibra 2.5i 24V	59
Cavalier III 2.5i 24V	89
Omega B 2.5i 24V	146
Vectra B 2.5i 24V	171

50 005 225



SAAB	POS
9000 2.0i 16V	20
9000 2.3i 16V	22
9000 2.3i Turbo 16V	23

50 005 226



FORD	POS
Tractor 6610	124
Tractor 6710	125

50 005 227



FORD	POS
Tractor 4610	123

50 005 229



JOHN DEERE	POS
Series JD 310	1
Series JD 350	2
Series MD 925	3
Series MD 932	4
Series MD 950	5
Series MD 955	6
Series MD 960	7
Series 830	8
Series 840	9
Series 890	10
Series 930	11
Series 940	12
Series 1020	13
Series 1030	14
Series 1040	15
Series 1050 C	16
Series 1120	17
Series 1130	18
Series 1140	19
Series 1520	20
Series 1530	21
Series 1630	22
Series 1640	23
Series 1840	24
Series 2020	25
Series 2040	26
Series 2130	27
Series 2140	28
Series 2840	29
Series 3030	30
Series 3040	31
Series 3120	32
Series 3130	33
Series 3135	34
Series 3140	35
Series 3210	36
Series 4030	38
Series 4040	39
Series 6600	41
Engine	42

50 005 230



JOHN DEERE	POS
Series 3040	31
Series 3310	37
Series 4040	39
Series 6100	40
Engine	42

50 005 231



IHC-CASE (CNH)	POS
Series 1700	3
Series 1820	4
Series H 65 B/C	12
MASSEY-FERGUSON	POS
44	5
45	6
87-6	15
102	18
187-6	26
400	49
450	51
500	53
500-7	54
510	56
515	57
520	58
542	59
1095	65
1098	66
1100	67
1105	68
1200	69
3366	73
4488	74
PERKINS	POS
Engine	1

MAIN APPLICATIONS



MAIN APPLICATIONS

50 005 232



PERKINS
Engine

POS
1

50 005 235



IHC-CASE (CNH)
Series 475

POS
9

MASSEY-FERGUSON

POS

30	3
50	7
165	19
186	24
3303	71
3305	72
7000	75

PERKINS
Engine

POS
1

50 005 239



PERKINS
Engine

POS
1

50 005 233



PERKINS
Engine

POS
1

50 005 236



PERKINS
Engine

POS
1

50 005 240



PERKINS
Engine

POS
1

50 005 234



FIAT / IVECO
Series 48
Series 520
Series AC 160

POS
184
216
232

PERKINS
Engine

POS
1

50 005 237



PERKINS
Engine

POS
1

50 005 241



CUMMINS
Engine

POS
1

50 005 242



CUMMINS
Engine

POS
1

MAIN APPLICATIONS



MAIN APPLICATIONS

50 005 245



FIAT / IVECO POS

Series 84	193
Series 100	196
Series 175	203
Series 600	217
Series 700	223
Series 820	224
Series 3300	230
Series M 100	242
Series M 84	243

IHC-CASE (CNH) POS

Series 1210	1
Series 1310	2
Series 660	11

MASSEY-FERGUSON POS

50	7
50 H	8
86	13
87	14
95	16
99	17
165	19
168	20
180	22
187	25
265	32
270	33
275	34
487	52
575	60
1080	64

PERKINS POS

Engine	1
--------	---

RENAULT TRUCKS (RVI) POS

Series 350	1
Series 380	2
Series 440	3
Series 450	4
Series 480	5
Series 500	6
Series 530	7
Series 550	8
Series 560	9
OK 010 K	11
OK 05 K	12

VOLVO POS

F 406	130
F 407	131
F 82	128
F 83	129

VOLVO-BM POS

L 30	4
------	---

50 005 246



FIAT / IVECO POS

Series 84	193
Series 100	196
Series 175	203
Series 600	217
Series 700	223
Series 820	224
Series 3300	230
Series M 100	242
Series M 84	243

IHC-CASE (CNH) POS

Series 1210	1
Series 1310	2
Series 660	11

MASSEY-FERGUSON POS

50	7
50 H	8
86	13
87	14
95	16
99	17
165	19
168	20
180	22
187	25
265	32
270	33
275	34
487	52
575	60
1080	64

PERKINS POS

Engine	1
--------	---

RENAULT TRUCKS (RVI) POS

Series 350	1
Series 380	2
Series 440	3
Series 450	4
Series 480	5
Series 500	6
Series 530	7
Series 550	8
Series 560	9
OK 010 K	11
OK 05 K	12

VOLVO POS

F 406	130
F 407	131
F 82	128
F 83	129

VOLVO-BM POS

L 30	4
------	---

50 005 247



FIAT / IVECO POS

Series ACF 110	233
Series ACP 40 / 50	234

PERKINS POS

Engine	1
--------	---

50 005 248



PERKINS POS

Engine	1
--------	---

50 005 249



PERKINS POS

Engine	1
--------	---

50 005 250



MASSEY-FERGUSON POS

65	10
----	----

MAIN APPLICATIONS



MAIN APPLICATIONS

50 005 250



PERKINS	POS
Engine	1

50 005 251



PERKINS	POS
Engine	1

50 005 252



FIAT / IVECO	POS
Series 84	193
Series 100	196
Series 175	203
Series 600	217
Series 700	223
Series 820	224
Series 3300	230
Series ACF 110	233
Series ACP 40 / 50	234
Series M 100	242
Series M 84	243

IHC-CASE (CNH)	POS
Series 1210	1
Series 1310	2
Series 660	11

MASSEY-FERGUSON	POS
50	7
50 H	8
86	13
87	14
95	16
99	17
165	19
168	20
180	22
187	25
265	32
270	33
275	34
487	52
575	60
1080	64

PERKINS	POS
Engine	1

50 005 252



RENAULT TRUCKS (RVI)	POS
Series 350	1
Series 380	2
Series 440	3
Series 450	4
Series 480	5
Series 500	6
Series 530	7
Series 550	8
Series 560	9
OK 010 K	11
OK 05 K	12
VOLVO	POS
F 406	130
F 407	131
F 82	128
F 83	129
VOLVO-BM	POS
L 30	4

50 005 253



RENAULT	POS
Clio I 1.2	4
Clio I 1.2i	5
Clio I 1.4	6
Clio I 1.4i	7
Express 1.4i	46
R 19 1.2i	180
R 19 1.4i	182
Rapid 1.4i	214

50 005 254



RENAULT	POS
Avantime 1.9 dTi	1
Clio II 1.9 DTi	20
Espace III 1.9 dTi	33
Espace IV 1.9 dCi	38
Kangoo 1.9 dCi	61
Kangoo 1.9 dTi	60
Laguna I 1.9 dCi	65
Laguna I 1.9 dTi	66
Laguna II 1.9 dCi	74
Master 1.9 dCi	91
Master 1.9 dTi	103
Mégane 1.9 dCi	111
Mégane 1.9 dTi	112
Mégane II 1.9 dCi	137

50 005 254



Scénic 1.9 dCi	230
Scénic 1.9 dTi	229
Scénic II 1.9 dCi	236
Trafic 1.9 dCi 100	251
Trafic 1.9 dCi 80	250

50 005 301



MITSUBISHI	POS
Carisma 1.9 TD	8

NISSAN	POS
Interstar 1.9 DTi	17

OPEL	POS
Movano 1.9 DTi	160

RENAULT	POS
Avantime 1.9 dTi	1

Clio I 1.7	8
------------	---

Clio I 1.8i	9
-------------	---

Clio I 1.8i 16V	10
-----------------	----

Clio I 1.9 D	11
--------------	----

Clio I 2.0i Williams 16V	12
--------------------------	----

Clio II 1.9 D	19
---------------	----

Clio II 1.9 DTi	20
-----------------	----

Espace III 1.9 dTi	33
--------------------	----

Espace III 2.0i	34
-----------------	----

Espace III 2.0i 16V	35
---------------------	----

Express 1.6 D	47
---------------	----

Express 1.9 D	48
---------------	----

Kangoo 1.9 D	59
--------------	----

Kangoo 1.9 dCi	61
----------------	----

Kangoo 1.9 dTi	60
----------------	----

Laguna I 1.8i	63
---------------	----

Laguna I 1.9 dTi	66
------------------	----

Laguna I 2.0i	67
---------------	----

Laguna Grandtour 1.8i	79
-----------------------	----

Laguna Grandtour 1.9 dTi	81
--------------------------	----

Laguna Grandtour 2.0i	83
-----------------------	----

Master 1.9 dTi	103
----------------	-----

Mégane 1.9 D	110
--------------	-----

Mégane 1.9 TD	113
---------------	-----

Mégane 1.9 dTi	112
----------------	-----

Mégane 2.0i	114
-------------	-----

Mégane 2.0i 16V	115
-----------------	-----

Mégane Classic 1.9 D	120
----------------------	-----

Mégane Classic 1.9 TD	121
-----------------------	-----

Mégane Classic 1.9 dTi	122
------------------------	-----

Mégane Classic 2.0i	124
---------------------	-----

Mégane Grandtour 1.9 D	129
------------------------	-----

Mégane Grandtour 1.9 TD	130
-------------------------	-----

Mégane Grandtour 1.9 dTi	131
--------------------------	-----

Mégane Grandtour 2.0i	133
-----------------------	-----

R 5 1.7	159
---------	-----

R 5 1.7i	160
----------	-----

R 9 1.6 D	166
-----------	-----

R 9 1.7	167
---------	-----

R 9 1.7i	168
----------	-----

R 11 1.6 D	173
------------	-----

R 11 1.7	174
----------	-----

R 11 1.7i	175
-----------	-----

R 19 1.7	183
----------	-----

R 19 1.7i	184
-----------	-----



MAIN APPLICATIONS

50 005 301		50 005 302		50 005 306	
R 19 1.8i	185	R 19 1.4	181		CITROEN POS C 25 2.5 D 45 C 25 2.5 TD 46 CX 2.4i 47 CX 2.5 D 50 CX 2.5 TD 51 CX 2.5i 48 CX 2.5i Turbo 49 FIAT / IVECO POS Ducato 10 2.5 D 37 Ducato 14 2.5 D 45 Ducato 18 2.5 D 51 PEUGEOT POS J5 2.5 D 159 J5 2.5 TD 160 J9 2.5 D 163
R 19 1.8i 16V	186	R 19 1.4i	182		
R 19 1.9 D	187	R 21 1.4	192		
R 19 1.9 TD	188	Rapid 1.1	210		
R 21 1.7	193	Rapid 1.4	213		
R 21 1.7i	194	Rapid 1.4i	214		
R 21 1.9 TD	195	50 005 303			
Rapid 1.6 D	215		AUTOBIANCHI POS Y 10 1.1 i.e. fire 1 FIAT / IVECO POS Cinquecento 1.1i 13 Palio 1.2i 71 Panda I 1.0 76 Panda I 1.0i 77 Panda I 1.1i 78 Panda I 750 73 Punto 1.1i 81 Punto 1.2i 82 Seicento 1.1i 94 Tipo 1.1 103 Tipo 1.1i 104 Uno 45 1.0 115 Uno 45 1.0i 116 Uno 60 1.1 118 Uno 60 1.1i 119 Uno Mondo 1.0i 120 Uno Mondo 1.1 121 LANCIA POS Y 1.1i 10 Y 1.2i 11 Y 10 1.0 13 Y 10 1.0i 14 Y 10 1.1i 15		
Rapid 1.9 D	216				
Scénic 1.9 TD	228				
Scénic 1.9 dTi	229				
Scénic 2.0i	231				
Spider 2.0i 16V	239				
Trafic 1.7	248				
Engine	261				
VAUXHALL POS					
Movano 1.9 DTI	130				
VOLVO POS					
340 1.6 D	10				
340 1.7	11				
360 1.7	13				
440 1.6	15				
440 1.7	16				
440 1.7i Turbo	18				
440 1.8i	17				
440 2.0	19				
460 1.6i	20				
460 1.7	21				
460 1.7i Turbo	22				
460 1.8i	23				
460 1.9 TD	24				
460 2.0	25				
480 1.7	26				
480 1.7i Turbo	27				
480 2.0	28				
S40 1.9 TD	76				
V40 1.9 TD	101				
50 005 302		50 005 304		50 005 307	
	RENAULT POS Clio I 1.1 3 Express 1.0 42 Express 1.1 43 Express 1.4 45 Express 1.4i 46 R 5 1.2 150 R 5 1.4 152 R 9 1.1 162 R 9 1.2 163 R 9 1.4 164 R 9 1.4 Turbo 165 R 11 1.1 169 R 11 1.2 170 R 11 1.4 171 R 11 1.4 Turbo 172		FORD POS Granada 2.5 TD 61 Scorpio 2.5 TD 87 PEUGEOT POS 505 2.3 TD 111 505 2.5 TD 113 604 2.5 TD 115		CITROEN POS BX 1.6 18 BX 1.6i 19 BX 1.8 D 20 BX 1.9 24 BX 1.9 D 25 BX 1.9i 22 BX 1.9i 16V 23 C 15 1.8 D 42 C 25 2.0 44 Visa 1.6i 72 Visa 1.8 D 73 ZX 1.6i 105 FIAT / IVECO POS Ducato 18 2.0 50 PEUGEOT POS 205 1.6i 18 205 1.8 D 19 205 1.9i 21 305 1.6 36 305 1.9 D 38 305 1.9i 37 309 1.6 64 309 1.6i 65 309 1.9i 68



MAIN APPLICATIONS

50 005 307



405 1.6	75
405 1.9i	79

50 005 308



RENAULT POS

Clio I 1.2	4
Clio I 1.2i	5
Clio I 1.4i	7
Express 1.4i	46
R 19 1.2i	180
R 19 1.4	181
R 19 1.4i	182
Rapid 1.4i	214

50 005 309



RENAULT POS

R 21 2.0i	197
Safrane 2.0i	218
Safrane 2.2i 12V	220

50 005 310



CITROEN POS

AX 1.0	1
AX 1.1	2
AX 1.3	4
AX 1.4	5
AX 1.4 D	6
AX 1.4i	7
Berlingo 1.1i	9
BX 1.1	15
BX 1.4	16
BX 1.4i	17
C2 1.1i	26
C3 1.1i	28
C 15 1.0	38
C 15 1.1	39

50 005 310



C 15 1.4	40
C 15 1.4i	41
Saxo 1.1i	68
Saxo 1.4i	69
ZX 1.1	100
ZX 1.1i	101
ZX 1.4i	103
PEUGEOT POS	
106 1.0	1
106 1.0i	2
106 1.1i	3
106 1.4	4
106 1.4 D	5
106 1.4i	6
205 1.0	10
205 1.0i	11
205 1.1i	13
205 1.3	14
205 1.4	15
205 1.4i	16
206 1.4i	24
306 1.1i	39
306 1.4	40
306 1.4i	41
307 1.4i	51
309 1.4	62
405 1.4	73
1007 1.4i	138
Partner 1.1i	164
Partner 1.4	165
Partner 1.4i	166
Ranch 1.4i	172
ROVER POS	
114 D	12

50 005 311



RENAULT POS

R 4 1.0	146
R 4 1.1	147
R 5 1.0	148
R 5 1.1	149
R 5 1.3	151
R 5 1.4	152
R 5 1.4 Alpine	154
R 5 1.4i Alpine Turbo	157
R 5 1.4i Turbo	156
R 6 1.1	161
Rodeo 5 1.1	217

50 005 312



RENAULT POS

R 5 1.1	149
R 5 1.3	151
R 5 1.4	152

50 005 313



CITROEN POS

Evasion 2.0i	53
Jumper 2.0	59
Xantia 1.9 TD	78
Xantia 2.0i	79
Xantia 2.0i 16V	80
XM 2.0	83
XM 2.0i	84
XM 2.0i Turbo	85
XM 2.1 D 12V	86
XM 2.1 TD 12V	87
ZX 2.0i	112

FIAT / IVECO POS

Ducato 10 2.0	35
Ducato 12 2.0	41
Ducato 14 2.0	43
Scudo 1.9 D	90
Ulysse 1.9 TD	107
Ulysse 2.0i	110

PEUGEOT POS

205 1.8 TD	20
306 1.9 D	46
306 1.9 TD	47
306 2.0i	48
306 2.0i 16V	49
309 1.8 TD	67
405 1.9 TD	82
405 2.0i	83
405 2.0i Turbo 16V	85
405 2.0i 16 V	84
406 1.9 TD	89
406 2.0i Turbo	91
605 2.0	116
605 2.0i	117
605 2.1 D 12V	119
806 1.9 TD	128



MAIN APPLICATIONS

50 005 313	
806 2.0i	129
Boxer 1.9 D	142
Boxer 1.9 TD	143
Boxer 2.0	144
Boxer 2.0i	145
Boxer II 2.0i	150
Expert 1.9 D	153
Expert 1.9 TD	154
Partner 1.8 D	169
Partner 1.9 D	170
ROVER	POS
218 D	14
218 TD	15
418 D	22
418 TD	23

50 005 314	
	
FORD	POS
Granada 2.5 D	60
PEUGEOT	POS
505 2.5 D	112

50 005 316	
	
RENAULT	POS
R 21 2.0i	197
R 21 2.1 D	200
R 21 2.1 TD	201
R 21 2.2i	202
Trafic 2.1 D	254

50 005 317	
	
RENAULT	POS
Espace II 2.1 TD	31

50 005 318	
	
RENAULT	POS
R 25 2.1 TD	207

50 005 319	
	
CITROEN	POS
BX 1.9i 16V	23
Evasion 1.8i	52
ZX 1.6i	105
FIAT / IVECO	POS
Scudo 1.8i	89
Ulysse 1.8i	106
PEUGEOT	POS
205 1.6i	18
205 1.9i	21
305 1.9i	37
306 1.8i	43
309 1.6i	65
309 1.9i	68
405 1.8i	77
405 1.9i	79
406 1.8i	87
806 1.8i	127
Expert 1.8i	152
Partner 1.8i	168

50 005 320	
	
CITROEN	POS
BX 1.8 D	20
BX 1.8 TD	21
BX 1.9 D	25
C 15 1.8 D	42

50 005 320	
Visa 1.6i	72
Visa 1.8 D	73
Xantia 1.9 TD	78
PEUGEOT	POS
205 1.8 D	19
205 1.8 TD	20
305 1.9 D	38
306 1.9 D	46
306 1.9 TD	47
309 1.8 TD	67
309 1.9 D	70
405 1.8 TD	78
405 1.9 D	81
405 1.9 TD	82
J5 1.9 D	158
ROVER	POS
218 D	14
218 TD	15
418 D	22
418 TD	23

50 005 321	
	
ALFA ROMEO	POS
30 AR 8	20
30 AR 8 Turbo	21
35 AR 8	22
35 AR 8 Turbo	23
40 AR 8	24
40 AR 8 Turbo	25
FIAT / IVECO	POS
Daily 2.5 28.8	17
Daily 2.5 30.8	18
Daily 2.5 32.8	19
Daily 2.5 35.8	20
Daily 2.5 40.8	21
Daily-Turbo 35.10	24
Daily-Turbo 45.10	27
Daily-Turbo 49.10	29
Ducato 13 2.4 D	42
Ducato 14 2.5 D	45
Ducato 14 2.5 D Turbo	46
Series 40	183
Series 238	207
Series 900	226
Series A 40-8	231
OM	POS
Grinta 30.8	2
Grinta 35.10	3
Grinta 35.8	5
Grinta 40.8	7
Grinta 45.10	8
Grinta 49.10	10
RENAULT	POS
Master P28 2.4 D	94

MAIN APPLICATIONS



MAIN APPLICATIONS

50 005 321



Master T28 2.4 D	97
Master T28 2.5 D	98
Master T30 2.4 D	99
Master T30 2.5 D	100
Master T35 2.4 D	101
Master T35 2.5 D	102
Traffic 2.5 D	256
Engine	261
RENAULT TRUCKS (RVI)	POS
B 90	10

50 005 322



CITROEN	POS
Evasion 2.1 TD 12V	57
Xantia 2.1 TD 12V	82
XM 2.1 TD 12V	87
FIAT / IVECO	POS
Ulysse 2.1 TD 12V	112
LANCIA	POS
Zeta 2.1 TD 12V	21
PEUGEOT	POS
406 2.1 TD 12V	94
605 2.1 TD 12V	120
806 2.1 TD 12V	133

50 005 323



CHRYSLER	POS
Cherokee 2.1 TD	1
Jeep CJ-7 2.0	3
Jeep CJ-7 2.1 D	4
RENAULT	POS
R 20 2.1 D	190
R 20 2.1 TD	191
R 25 2.1 D	206
R 30 2.1 TD	209
Traffic 2.0	252
Traffic 2.1 D	254

50 005 324



FIAT / IVECO	POS
Tipo 1.7 D	105

50 005 325



RENAULT	POS
Espace I 2.0	26
Espace I 2.0i	27
Espace I 2.1 TD	28
Espace I 2.2i	29
Fuego 2.0	49
Fuego 2.1 TD	50
R 18 2.0	176
R 18 2.1 D	177
R 18 2.1 TD	178
R 20 2.0	189
R 20 2.1 D	190

50 005 326



RENAULT	POS
Clio I 1.1	3
Express 1.0	42
Express 1.1	43
Express 1.4	45
Express 1.4i	46
R 5 1.2	150
R 5 1.4	152
R 9 1.1	162
R 9 1.2	163
R 9 1.4	164
R 9 1.4 Turbo	165
R 11 1.1	169
R 11 1.2	170
R 11 1.4	171
R 11 1.4 Turbo	172
R 19 1.4	181
R 19 1.4i	182
R 21 1.4	192

50 005 326



Rapid 1.1	210
Rapid 1.4	213
Rapid 1.4i	214

50 005 329



CITROEN	POS
C5 2.0 HDi	35
C8 2.0 HDi 16V	37
Evasion 2.0 HDi	55
Evasion 2.0 HDi 16V	56
Jumper 2.0 HDi	60
Jumpy 2.0 HDi	65
Jumpy 2.0 HDi 16V	66
Xantia 2.0 HDi	81
Xsara 2.0 HDi	97
Xsara Picasso 2.0 HDi	99
FIAT / IVECO	POS
Ducato 10 2.0 JTD	36
Ducato 14 2.0 JTD	44
Ducato 15 2.0 JTD	48
Scudo 1.9 D	90
Scudo 2.0 JTD	91
Ulysse 2.0 JTD	108
Ulysse 2.0 JTD 16V	109
LADA	POS
2123 2.0 TD	2
LANCIA	POS
Phedra 2.0 JTD 16V	8
Zeta 2.0 JTD	18
Zeta 2.0 JTD 16V	19
PEUGEOT	POS
206 1.9 D	29
206 2.0 HDi	32
306 1.9 D	46
306 2.0 HDi	50
307 2.0 HDi	56
406 2.0 HDi	92
607 2.0 HDi	123
806 2.0 HDi	131
806 2.0 HDi 16V	132
807 2.0 HDi 16V	135
Boxer 2.0 HDi	146
Boxer II 2.0 HDi	151
Expert 1.9 D	153
Expert 2.0 HDi 16V	156
Expert 2.0 HDi	155
Partner 1.9 D	170
Partner 2.0 HDi	171
Ranch 1.9 D	173
SUZUKI	POS
Grand Vitara 2.0 HDi	11
Vitara 2.0 HDi	39



MAIN APPLICATIONS

50 005 330



FIAT / IVECO	POS
Ducato 2.5 D Turbo	54
PEUGEOT	POS
605 2.4 TD	121
Boxer 2.5 D	147
Boxer 2.5 TD	148

50 005 331



FIAT / IVECO	POS
Ducato 2.5 D Turbo	54
PEUGEOT	POS
605 2.4 TD	121
Boxer 2.5 D	147
Boxer 2.5 DI TD	149
Boxer 2.5 TD	148

50 005 332



ALFA ROMEO	POS
145 1.9 JTD	1
146 1.9 JTD	2
147 1.9 JTD	3
156 1.9 JTD	6
156 2.4 JTD	9
166 2.4 JTD	15
FIAT / IVECO	POS
Brava 1.9 JTD	7
Bravo 1.9 JTD	10
Marea 1.9 JTD	65
Marea 2.4 JTD	63
Marengo 1.9 JTD	66
Multipla 1.9 JTD	68

50 005 332

Stilo 1.9 JTD 16V	99
LANCIA	POS
Kappa 2.4 TD	3
Lybra 1.9 JTD	5
Lybra 2.4 JTD	6

50 005 333



PEUGEOT	POS
306 1.9 TD	47
406 1.9 TD	89
806 1.9 TD	128
Partner 1.9 D	170

50 005 334



FIAT / IVECO	POS
Elba 1.4i	55
Elba 1.6i	56
Fiorino 1.4i	58
Fiorino 1.6i	59
Tempra 1.4	101
Tempra 1.4i	102

50 005 335



NISSAN	POS
Kubistar 1.1i	20
RENAULT	POS
Clio I 1.2i	5
Clio II 1.2i	13
Clio II 1.6i	17
Clio III 1.2i 16V	22
Kangoo 1.2i	54

50 005 335

Modus 1.2i 16V	141
Twingo 1.2i	258

50 005 336



RENAULT	POS
Espace III 2.2 TD 12V	37
Laguna I 2.2 D 12V	69
Laguna I 2.2 TD 12V	70
Laguna Grandtour 2.2 D	86
Laguna Grandtour 2.2 D 12V	87
Laguna Grandtour 2.2 TD 12V	88
Safrane 2.2 TD 12V	221

50 005 337



RENAULT	POS
Laguna I 2.2 D 12V	69
Laguna Grandtour 2.2 D	86
Laguna Grandtour 2.2 D 12V	87

50 005 339



CITROEN	POS
AX 1.4	5
BX 1.4	16
BX 1.4i	17
C 15 1.4	40
ZX 1.4	102
LADA	POS
Samara 1.5 D	3
NISSAN	POS
Micra 1.5 D	27
PEUGEOT	POS
106 1.4	4
106 1.4i	6
106 1.5 D	7
106 1.6i	8

MAIN APPLICATIONS



50 005 339



205 1.4	15
205 1.4i	16
206 1.6i	27
306 1.4	40
306 1.6i	42
309 1.4	62
309 1.4i	63
405 1.4	73
405 1.4i	74
Partner 1.4	165
ROVER	POS
Metro 1.5 D	8

50 005 340



RENAULT	POS
Mégane 1.6i	107
Mégane Classic 1.6i	118
Mégane Grandtour 1.6i	127
Scénic 1.6i	224

50 005 341



RENAULT	POS
Espace II 2.0i	30
Espace II 2.2i	32
Master T28 2.2i	96
R 21 2.0i	197
R 21 2.0i 12V	198
R 21 2.0i Turbo	199
R 21 2.2i	202
R 25 2.0i 12V	205
R 25 2.2i	208
Trafic 2.2i	255

50 005 366



DEUTZ	POS
AgroCompact 3.30	63
AgroCompact 3.70	65

50 005 366



AgroXtra DX 4.07	10
Engine	131
Gabelstapler / Forklift	14
Intrac 2002	15
Intrac 2003	16
Intrac 2004	17
Series D 4006	69
Series D 4007	71
Series D 4206	23
Series D 4505	73
Series D 4506	74
Series D 4507	75
Series D 4807	77
Series D 5006	79
Series D 5206	81
Series D 5207	83
Series D 5506	85
Series D 6006	88
Series D 6007	90
Series D 6206	92
Series D 6207	95
Series D 6507	99
Series D 6806	101
Series D 6807	104
Series D 6907	107
Series D 7006	111
Series D 7007	114
Series D 7206	119
Series D 7207	122
Series D 7807	124
Series DX 3.10	30
Series DX 3.30	31
Series DX 3.50	32
Series DX 3.60	33
Series DX 3.65	34
Series DX 3.70	35
Series DX 3.80	36
Series DX 3.90	37
Series DX 4.10	38
Series DX 4.17	39
Series DX 4.30	40
Series DX 4.31	41
Series DX 50	45
Series DX 55	46
Series M 1000	91
Series M 3330	116
Series M 3360	117
Series M 3370	118
Series M 600	78
Series M 66	57
Series M 660	80
Series M 750	82
Series M 770	84
Series M 80	58
Series M 88	59
Series M 900	86
Series M 922	87
Series M 980	89
IHC-CASE (CNH)	POS
Series 3944	5
Series 3945	6

50 005 367



DEUTZ POS

Actor 5510	1
AgroPrima 4.51	2
AgroPrima 4.56	3
AgroPrima 6.06	4
AgroStar 4.61	5
AgroStar 4.68	6
AgroStar 4.71	7
AgroStar 4.78	8
AgroStar 6.11	9
AgroXtra DX 4.47	11
AgroXtra DX 4.57	12
AgroXtra DX 6.07	13
Engine	131
Intrac 2005	18
Intrac 6.05	19
Series D 10006	128
Series D 13006	129
Series D 16006	130
Series D 7506	123
Series D 8006	125
Series D 9006	126
Series D 9009	127
Series DX 110	24
Series DX 4.30	40
Series DX 4.50	42
Series DX 4.57	43
Series DX 4.70	44
Series DX 6.05	47
Series DX 6.06	48
Series DX 6.10	49
Series DX 85	53
Series DX 86	54
Series DX 90	55
Series DX 92	56
Series M 1000	91
Series M 1002	93
Series M 1080	94
Series M 110	60
Series M 1102	96
Series M 120	62
Series M 1200	97
Series M 1202	100
Series M 1250	98
Series M 1300	102
Series M 2385	110
Series M 2480	112
Series M 2580	113
Series M 2680	115
Series M 3360	117
Series M 4030	121
Series M 980	89
IHC-CASE (CNH)	POS
Series 3960	7
Series 3961	8



50 005 368



DEUTZ	POS
Engine	131
Serie SF 3008	21
Series M 1620	106
Series M 2000	68
Series M 230	67
Series M 256	70
Series M 260	72
TAM	POS
260	3

50 005 369



DEUTZ	POS
Intrac 6.60	20
Series DX 140	25
Series DX 145	26
Series DX 160	27
Series DX 230	28
Series DX 6.50	50
Series DX 6.60	51
Series DX 7.10	52
Series M 1300	102
Series M 1302	103
Series M 1322	105
Series M 160	64
Series M 168	61
Series M 2685	108
Series M 2780	109
Series M 3610	120

50 005 425



MERCEDES-BENZ	POS
190 2.0 (201)	185
190 E 1.8 (201)	191
190 E 2.0 (201)	192
190 E 2.3 (201)	193
190 E 2.3-16 (201)	194

50 005 425



190 E 2.5-16 (201)	195
190 E 2.5-16 EVOLUTION (201)	196
200 (124)	201
200 E (124)	206
230 E (124)	217

50 005 427



MERCEDES-BENZ	POS
G 500 (463)	94
420 SE (126)	306
420 SL (107)	307
500 GE (463)	313
500 SE (126)	314
500 SL (107)	317
560 SE (126)	319

50 005 428



MERCEDES-BENZ	POS
300 GD (460)	277
300 GD (461)	278
MB 100 2.4 D	488
MB 120 2.4 D	490
MB 140 2.4 D	491
MB 160 2.4 D	492
MB 180 2.4 D	493
O 309 D 2.4	507
MB-Trac 100	534
MB-Trac 120	535
MB-Trac 140	536
MB-Trac 150	537
MB-Trac 160	538
MB-Trac 180	539
Series 207 D 2.4	616
Series 307 D 2.4	626
Series 308 D 2.4	629
Series 407 D 2.4	653
Engine	992

50 005 430



MERCEDES-BENZ	POS
E 420 (124)	81
E 500 (124)	84
S 420 (140)	112
S 500 (140)	115
400 E 4.2 (124)	304
400 SE 4.2 (140)	305
500 E (124)	312
500 SE (140)	315
500 SL (129)	318

50 005 433



MERCEDES-BENZ	POS
C 180 (202)	7
C 180 (203)	8
C 200 (202)	9
C 220 (202)	15
C 230 (202)	19
CLK 200 (208)	34
E 200 (124)	47
E 200 (210)	48
E 220 (124)	54
E 230 (210)	58
ML 230 (163)	96
SLK 200 (170)	123
200 E (124)	206
220 E (124)	211

50 005 434



MERCEDES-BENZ	POS
C 280 (202)	27
E 280 (124)	69
E 280 (210)	70
E 320 (124)	77



MAIN APPLICATIONS

50 005 434



E 320 (210)	78
G 320 (460)	91
SL 320 (129)	119
280 E (124)	252
300 E 3.2 (124)	275
300 SE 2.8 (124)	286
300 SE 2.8 (126)	287
320 E (124)	295

SSANGYONG

POS

Actyon 3.2i 24V	1
Chairman 2.8 i 24V	2
Chairman 3.2 i 24V	3
Korando 3.2i 24V	20
Musso 3.2i 24V	18
Rexton 3.2i 24V	8
Rodius 3.2i 24V	9
Stavic 3.2i 24V	10

50 005 435



MERCEDES-BENZ

POS

S 280 (140)	103
S 300 3.2 (140)	105
S 320 (140)	107
300 SE 2.8 (140)	288
300 SE 3.2 (140)	289

50 005 436



MERCEDES-BENZ

POS

C 280 (202)	27
E 280 (124)	69
E 280 (210)	70
E 320 (124)	77
E 320 (210)	78
G 320 (460)	91
SL 280 (129)	118
SL 320 (129)	119
280 E (124)	252
300 E 3.2 (124)	275
300 SE 2.8 (124)	286
300 SE 2.8 (126)	287
320 E (124)	295

SSANGYONG

POS

Actyon 3.2i 24V	1
-----------------	---

50 005 436



Chairman 2.8 i 24V	2
Chairman 3.2 i 24V	3
Korando 3.2i 24V	20
Musso 3.2i 24V	18
Rexton 3.2i 24V	8
Rodius 3.2i 24V	9
Stavic 3.2i 24V	10

50 005 437



MERCEDES-BENZ

POS

G 320 (463)	92
S 280 (140)	103
S 300 3.2 (140)	105
S 320 (140)	107
300 SE 2.8 (140)	288
300 SE 3.2 (140)	289

SSANGYONG

POS

Korando 3.2i 24V	20
------------------	----

50 005 439



MERCEDES-BENZ

POS

C 250 D (202)	24
E 200 D (124)	50
E 250 D (124)	63
E 250 D (210)	64
E 250 D Turbo (124)	65
E 290 D Turbo (210)	71
E 300 D (124)	73
E 300 D (210)	74
E 300 D Turbo (124)	75
G 300 D (463)	89
G 350 D Turbo (463)	93
S 350 D Turbo (140)	110
Sprinter 208 D 2.3	127
Sprinter 210 D 2.9	128
Sprinter 212 D 2.9	130
Sprinter 308 D 2.3	135
Sprinter 310 D 2.9	136
Sprinter 312 D 2.9	138
Sprinter 408 D 2.3	144
Sprinter 410 D 2.9	145
Sprinter 412 D 2.9	147
V 230 TD (638)	157
Vario 512 D 2.9	161
Vario 612 D 2.9	162
Vario 614 D 2.9	164
Vario 810 D 2.9	167
Vario 812 D 2.9	169

50 005 439



Vario 814 D 2.9	171
Vario 815 D 2.9	173
Viano 110 D 2.3	175
Vito 108 D 2.3	179
Vito 110 D 2.3	181
190 D 2.5 (201)	188
190 D 2.5 Turbo (201)	189
200 D (124)	205
250 D (124)	237
250 D Turbo (124)	238
250 GD (460)	239
250 GD (461)	240
250 GD (463)	241
290 GD (461)	266
290 GD Turbo (461)	267
300 D (124)	272
300 D Turbo (124)	269
300 GD (463)	279
300 SD 3.5 Turbo (140)	283
300 SD Turbo (USA) (126)	282
350 GD Turbo (463)	296
MB 100 2.3 D	487
MB 100 2.9 D	489
O 405 GTZ	525
U 100	566
U 100 turbo	567
U 90	563
U 90 turbo	564
Series UX 100	612
Series 208 D 2.3	618
Series 209 D 2.9	619
Series 210 D 2.9	621
Series 307 D 2.3	625
Series 308 D 2.3	628
Series 309 D 2.9	630
Series 310 D 2.9	632
Series 408 D 2.3	658
Series 410 D 2.9	664
Series 508 D 2.3	667
Engine	992

SSANGYONG

POS

Istana 2.3 D	4
Istana 2.9 D	5
Korando 2.3 D	14
Korando 2.9 D	17
Korando 2.9 TD	19
Musso 2.3 D	13
Musso 2.9 D	15
Musso 2.9 TD	16
Rexton 2.9 TD	7

50 005 440



MERCEDES-BENZ

POS

E 300 (124)	72
260 E (124)	245
260 E (126)	246
300 E (124)	273
300 E 2.6 (124)	274
300 SE (126)	284
300 SL (107)	292



MAIN APPLICATIONS

50 005 441



MERCEDES-BENZ	POS
300 SE (126)	284
300 SL (107)	292

50 005 446

300 SL (107)	292
300 SL (129)	293

50 005 447



MERCEDES-BENZ	POS
190 E 2.6 (201)	197
300 SE (126)	284
300 SL (107)	292

50 005 454



MERCEDES-BENZ	POS
E 420 (124)	81
E 420 (210)	82
E 500 (124)	84
S 420 (140)	112
S 500 (129)	114
S 500 (140)	115
SL 500 (129)	121
400 E 4.2 (124)	304
400 SE 4.2 (140)	305
500 E (124)	312
500 SE (140)	315
500 SL (129)	318

50 005 442



MERCEDES-BENZ	POS
E 300 (124)	72
G 300 (463)	88
190 E 2.6 (201)	197
260 E (124)	245
260 E (126)	246
300 E (124)	273
300 E 2.6 (124)	274
300 GE (463)	280
300 SE (126)	284
300 SL (107)	292
300 SL (129)	293

50 005 449



MERCEDES-BENZ	POS
300 E (124)	273
300 E-24 (124)	276
300 SL-24 (129)	294

50 005 455



MERCEDES-BENZ	POS
C 200 CDI (202)	13
C 200 CDI (203)	14
C 220 CDI (202)	17
C 220 CDI (203)	18
C 270 CDI (203)	26
CLK 270 CDI (209)	39
E 200 CDI (210)	52
E 220 CDI (210)	56
E 270 CDI (210)	67
G 270 CDI (461)	87
ML 270 CDI (163)	97
Engine	992

50 005 446



MERCEDES-BENZ	POS
E 300 (124)	72
G 300 (463)	88
190 E 2.6 (201)	197
260 E (124)	245
260 E (126)	246
300 E (124)	273
300 E 2.6 (124)	274
300 GE (463)	280
300 SE (126)	284

50 005 452



MERCEDES-BENZ	POS
300 E (124)	273
300 E-24 (124)	276
300 SL-24 (129)	294

50 005 456



CHRYSLER	POS
Crossfire 3.2i	2
MERCEDES-BENZ	POS
C 240 (202)	22
C 240 (203)	23
C 280 (202)	27



MAIN APPLICATIONS

50 005 456



C 320 (203)	28
CL 500 (215)	30
CLK 240 (209)	38
CLK 320 (208)	40
CLK 320 (209)	41
CLK 430 (208)	42
CLK 500 (209)	43
CLS 500 (219)	46
E 240 (210)	59
E 240 (211)	60
E 240 2.6 (211)	62
E 240.2.6 (210)	61
E 280 (210)	70
E 320 (210)	78
E 320 (211)	79
E 430 (210)	83
E 500 (211)	85
G 320 (463)	92
G 500 (463)	94
ML 320 (163)	98
ML 350 3.7 (163)	99
S 280 (220)	104
S 320 (220)	108
S 350 3.7 (220)	109
S 370 (220)	111
S 430 (220)	113
S 500 (220)	116
SL 280 (129)	118
SL 320 (129)	119
SL 350 3.7 (230)	120
SL 500 (129)	121
SL 500 (230)	122
SLK 320 (170)	126

STEYR POS

G 320 (Steyr)	5
G 500 (Steyr)	6

50 005 457



CHRYSLER POS

Crossfire 3.2i	2
----------------	---

MERCEDES-BENZ POS

C 240 (202)	22
C 240 (203)	23
C 280 (202)	27
C 320 (203)	28
C 43 AMG (202)	29
CL 500 (215)	30
CL 55 AMG (215)	31
CLK 240 (209)	38
CLK 320 (208)	40
CLK 320 (209)	41
CLK 430 (208)	42
CLK 500 (209)	43
CLK 55 AMG (208)	44
CLK 55 AMG (209)	45
CLS 500 (219)	46
E 240 (210)	59
E 240 (211)	60
E 240 2.6 (211)	62

50 005 457



E 240.2.6 (210)	61
E 280 (210)	70
E 320 (210)	78
E 320 (211)	79
E 430 (210)	83
E 500 (211)	85
E 55 AMG (210)	86
G 320 (463)	92
G 500 (463)	94
G 55 AMG (463)	95
ML 320 (163)	98
ML 350 3.7 (163)	99
ML 430 (163)	100
ML 500 (163)	101
ML 55 AMG (163)	102
S 280 (220)	104
S 320 (220)	108
S 350 3.7 (220)	109
S 370 (220)	111
S 430 (220)	113
S 500 (220)	116
S 55 AMG (220)	117
SL 280 (129)	118
SL 320 (129)	119
SL 350 3.7 (230)	120
SL 500 (129)	121
SL 500 (230)	122
SLK 320 (170)	126

STEYR POS

G 320 (Steyr)	5
G 500 (Steyr)	6

50 005 470



MERCEDES-BENZ POS

A 140 (168)	1
A 160 (168)	2
A 160 CDI (168)	3
A 170 CDI (168)	4
A 190 (168)	5

50 005 471



MERCEDES-BENZ POS

A 140 (168)	1
A 160 (168)	2
A 160 CDI (168)	3
A 170 CDI (168)	4
A 190 (168)	5

50 005 471



A 210 Evolution (168)	6
Vaneo 1.6	159
Vaneo 1.9	160

50 005 474



MERCEDES-BENZ POS

V 200 (638)	153
V 230 (638)	156
Viano 200 (Italy)	176
Viano 230 (Italy)	177
Vito 113 2.0	183
Vito 114 2.0	184

50 005 475



MERCEDES-BENZ POS

V 200 (638)	153
V 230 (638)	156
Viano 200 (Italy)	176
Viano 230 (Italy)	177
Vito 113 2.0	183
Vito 114 2.0	184

SSANGYONG POS

Korando 2.0i 16V	11
Musso 2.0i 16V	12
Rexton 2.0i 16V	6

50 005 490



MERCEDES-BENZ POS

C 250 D Turbo (202)	25
E 250 D Turbo (124)	65
E 250 D Turbo (210)	66
E 300 D Turbo (124)	75
E 300 D Turbo (210)	76



MAIN APPLICATIONS

50 005 490	
G 300 D Turbo (463)	90
G 350 D Turbo (463)	93
S 300 D Turbo (140)	106
S 350 D Turbo (140)	110
250 D Turbo (124)	238
300 D Turbo (124)	269
300 SD 3.5 Turbo (140)	283
350 GD Turbo (463)	296
Engine	992
STEYR	POS
G 300 TD (Steyr)	4

50 005 491	
	
MERCEDES-BENZ	POS
C 200 Kompressor (202)	10
C 230 Kompressor (202)	20
CLK 200 Kompressor (208)	35
CLK 230 Kompressor (208)	37
E 200 Kompressor (210)	49
SLK 200 Kompressor (170)	124
SLK 230 Kompressor (170)	125

50 005 510	
	
BMW	POS
520 2.0i (E28)	52
320 1.8i (E30) (J/USA)	66
320 2.0i (E30)	68
325 2.5i (E30)	74
520 2.0i (E34)	81
525 2.5i (E34)	84
Z1 2.5i	143

50 005 511	
	
BMW	POS
524dt 2.4 (E28)	54
324dt 2.4 (E30)	73
524td 2.4 (E34)	83

50 005 512	
	
BMW	POS
524d 2.4 (E28)	53
524dt 2.4 (E28)	54
324d 2.4 (E30)	72
324dt 2.4 (E30)	73
524td 2.4 (E34)	83

50 005 513	
	
BMW	POS
520 2.0i 24V (E34)	82
525 2.5i 24V (E34)	85
320 2.0i 24V (E36)	98
323 2.3i 24V (E36)	99
325 2.5i 24V (E36)	100
328 2.8i 24V (E36)	103
Z3 2.0i 24V (E36/7)	106
Z3 2.8i 24V (E36/7)	107
728 2.8i 24V (E38)	109
520 2.0i 24V (E39)	113
523 2.5i 24V (E39)	114
528 2.8i 24V (E39)	117
320 2.0i 24V (E46)	127
328 2.8i 24V (E46)	129
ROVER	POS
Defender 110 2.8i 24V	3

50 005 514	
	
BMW	POS
318 1.8i (E30)	63
518 1.8i (E34)	79
316 1.6i (E36)	91

50 005 515	
	
BMW	POS
318 1.8i 16V (E30)	64
518g 1.8i (E34)	80
316 1.9i (E36)	93
316g 1.6i (E36)	92
318 1.8i 16V (E36)	94
318 1.9i 16V (E36)	95
318g 1.8i (E36)	97
Z3 1.9i (E36/7)	104
Z3 1.9i 16V (E36/7)	105
316 1.9i (E46)	124
316g 1.6i (E46)	121
318 1.9i (E46)	125

50 005 516	
	
BMW	POS
525td 2.5 (E34)	86
525tds 2.5 (E34)	87
318tds 1.7 (E36)	96
325td 2.5 (E36)	101
325tds 2.5 (E36)	102
725tds 2.5 (E38)	108
525td 2.5 (E39)	115
525tds 2.5 (E39)	116
OPEL	POS
Omega B 2.5 TD	178
VAUXHALL	POS
Omega B 2.5 TD	147

50 005 517	
	
BMW	POS
730 3.0i (E32)	76
740 4.0i 32V (E32)	78
530 3.0i V8 (E34)	88
540 4.0i 32V (E34)	90

MAIN APPLICATIONS



MAIN APPLICATIONS

50 005 519



BMW	POS
840 Ci 32V (E31)	75
735 3.5i 32V (E38)	111
740 4.0i 32V (E38)	112
535 3.5i 32V (E39)	119
540 4.4i 32V (E39)	120

50 005 530



FORD	POS
Escort 1.4	11
Escort 1.4i	12
Escort 1.6	13
Escort 1.6i	14
Escort 1.6i Turbo	15
Fiesta 1.3	25
Fiesta 1.4	27
Fiesta 1.4i	28
Fiesta 1.6	30
Orion 1.4	75
Orion 1.4i	76
Orion 1.6i	78

50 005 550



AUDI	POS
A6 2.2i Turbo 25V	35
A6 2.3i	36
S2 2.2i Turbo 20V	58
S4 2.2i Turbo 25V	60
S6 2.2i Turbo 25V	62
Cabriolet 2.3i	71
Coupé 2.0i 20V	80
Coupé 2.2i Turbo 20V	83

50 005 550



Coupé 2.3i 20V	85
80 2.2i Turbo 20V	113
80 2.3i	114
90 2.0i 20V	121
90 2.3i	123
90 2.3i 20V	124
100 2.3i	136

50 005 551



AUDI	POS
A6 2.5 TDI	38
100 2.4 D	137
VOLKSWAGEN	POS
California 2.4 D	36
California 2.5 TDI	38
California 2.5i	37
Caravelle 2.4 D	48
EuroVan 2.4 D	67
EuroVan 2.5i	68
LT 28 D	184
LT 28 SDI	185
LT 28 TDI	187
LT 31 D	189
LT 35 D	193
LT 35 SDI	194
LT 35 TDI	196
LT 40 D	198
LT 45 D	201
LT 46 TDI	204
LT 50 D	206
Transporter T4 2.4 D	371
Transporter T4 2.5 TDI	373
Transporter T4 2.5i	372
VOLVO	POS
850 2.5 TDI	47
S70 2.5 TDI	91
V70 2.5 TDI	116

50 005 552



AUDI	POS
100 2.5 TDI	139

50 005 553



AUDI	POS
100 2.0 TDI	132
100 2.4 D	137
100 2.5 TD	138

50 005 554



AUDI	POS
A3 1.9 TDI	9
A3 2.0 TDI 16V	12
A4 1.9 TDI	18
A6 1.9 TDI	31
FORD	POS
Galaxy 1.9 TDI	53
SEAT	POS
Alhambra 1.9 TDI	5
Altea 2.0 TDI 16V	12
Cordoba 1.9 TDI	34
Ibiza 1.9 TDI	57
Leon 1.9 TDI	74
Leon 2.0 TDI 16V	77
Toledo 1.9 TDI	91
Toledo 2.0 TDI 16V	95
SKODA	POS
Fabia 1.9 TDI	10
Octavia 1.9 TDI	21
Octavia 2.0 TDI 16V	25
Superb 1.9 TDI	31
Superb 2.0 TDI 16V	34
VOLKSWAGEN	POS
Bora 1.9 TDI	8
Bora 2.0 TDI 16V	10
Golf IV 1.9 TDI	134
Golf V 2.0 TDI 16V	148
Golf Plus 2.0 TDI 16V	155
Jetta 2.0 TDI 16V	180
New Beetle 1.9 TDI	224
Passat 1.9 TDI	250
Passat 2.0 TDI 16V	256
Polo 1.9 TDI	292
Sharan 1.9 TDI	344
Touran 2.0 TDI 16V	359
Vento 2.0 TDI 16V	391



MAIN APPLICATIONS

50 005 555



AUDI	POS
A6 2.5 TDI	38
100 2.4 D	137
VOLKSWAGEN	POS
California 2.4 D	36
California 2.5 TDI	38
California 2.5i	37
Campmobil 2.4	47
Caravelle 2.4 D	48
Crafter 2.5 TDI	55
EuroVan 2.4 D	67
EuroVan 2.5i	68
LT 28 D	184
LT 28 SDI	185
LT 28 TD	186
LT 28 TDI	187
LT 31 D	189
LT 31 TD	190
LT 35 D	193
LT 35 SDI	194
LT 35 TD	195
LT 35 TDI	196
LT 40 D	198
LT 40 TD	199
LT 45 D	201
LT 45 TD	202
LT 46 TDI	204
LT 50 D	206
LT 50 TD	207
LT 55 TD	209
Transporter T4 2.4 D	371
Transporter T4 2.5 TDI	373
Transporter T4 2.5i	372
VOLVO	POS
850 2.5 TDI	47
940 2.4 TDi	54
940 II 2.4 TD	57
960 2.4 TDi	63
S70 2.5 TDI	91
V70 2.5 TDI	116

50 005 556



AUDI	POS
A2 1.2 TDI	1
A2 1.4 TDI	3

50 005 556

A3 1.9 TDI	9
FORD	POS
Galaxy 1.9 TDI	53
SEAT	POS
Alhambra 1.9 TDI	5
Altea 1.9 TDI	10
Arosa 1.4 TDI	16
Cordoba 1.4 TDI	26
Cordoba 1.9 TDI	34
Ibiza 1.4 TDI	47
Ibiza 1.9 TDI	57
Leon 1.9 TDI	74
Toledo 1.9 TDI	91
SKODA	POS
Fabia 1.4 TDI	7
Fabia 1.9 TDI	10
Octavia 1.9 TDI	21
Roomster 1.4 TDI	27
Roomster 1.9 TDI	29
VOLKSWAGEN	POS
Bora 1.9 TDI	8
Caddy 1.9 TDI	24
Caddy 2.0 SDI	26
Caddy Maxi 1.9 TDI	29
California 1.9 TDI	34
Fox 1.4 TDI	71
Golf V 1.9 TDI	145
Golf V 2.0 SDI	147
Golf Plus 1.9 TDI	153
Jetta 1.9 TDI	176
Lupo 1.2 TDI	211
Lupo 1.4 TDI	215
Maxi 1.9 TDI	219
Passat 1.9 TDI	250
Polo 1.4 TDI	284
Polo 1.9 TDI	292
Polo Sedan 1.4 TDI	299
Polocross 1.4 TDI	304
Polocross 1.9 TDI	306
Sharan 1.9 TDI	344
Touran 1.9 TDI	356
Transporter T5 1.9 TDI	375
Vento 1.9 TDI	388

50 005 601



SCANIA	POS
R 143	29
R 144	30
T 144	31
Engine	41

50 005 602



VOLVO	POS
CH 200	124
CH 230 T	125
F 10	126
F 12	127
FL 10	134
FS 10	135
FS 12	136
N 10	137
N 12	138
NL 10	139
NL 12	140
Engine	141
VOLVO-BM	POS
Engine	5

50 005 604



FIAT / IVECO	POS
100 E15 EuroCargo	138
100 E18 EuroCargo	139
100 E21 EuroCargo	140
120 E15 EuroCargo	141
120 E18 EuroCargo	142
130 E15 EuroCargo	144
130 E18 EuroCargo	145
135 E18 EuroCargo	147
135 E23 EuroCargo	148
150 E15 EuroCargo	149
150 E18 EuroCargo	150
170 E18 EuroCargo	152
180 E21 EuroCargo	154
315 E18 EuroCargo	157
60 E10 EuroCargo	123
60 E12 EuroCargo	124
60 E14 EuroCargo	125
65 E12 EuroCargo	126
65 E14 EuroCargo	127
75 E12 EuroCargo	128
75 E14 EuroCargo	129
75 E15 EuroCargo	130
80 E14 EuroCargo	131
80 E15 EuroCargo	132
80 E18 EuroCargo	133
80 E21 EuroCargo	134
95 E15 EuroCargo	135
95 E18 EuroCargo	136
95 E21 EuroCargo	137

MAIN APPLICATIONS



50 005 605



FIAT / IVECO

POS

Series 50-9	185
Series 60-11	187
Series 65-12	188
Series 75-12	190
Series 79-12	191
Series 95-14	195
Series 109-14	197
Series 115-14	199
Series 115-17	200
Series 135-14	201
Series 135-17	202

50 005 606



FIAT / IVECO

POS

120 E23 EuroCargo	143
130 E23 EuroCargo	146
135 E23 EuroCargo	148
150 E23 EuroCargo	151
170 E23 EuroCargo	153
260 E23 EuroCargo	155
280 E23 EuroCargo	156

50 005 607



FIAT / IVECO

POS

Series 190	204
Series 190-36	205
Series 220	206
Series 240	208
Series 260	209

50 005 607



190 TurboStar	244
240 TurboStar	245
260 TurboStar	246
190 TurboTech	247
220 TurboTech	250
240 TurboTech	248
260 TurboTech	249

50 005 608



FIAT / IVECO

POS

Series 190	204
Series 190-36	205
Series 220	206
Series 240	208
Series 260	209
190 TurboStar	244
240 TurboStar	245
260 TurboStar	246
190 TurboTech	247
220 TurboTech	250
240 TurboTech	248
260 TurboTech	249

50 005 609



FIAT / IVECO

POS

190 E42 EuroStar	158
240 E42 EuroStar	159
260 E42 EuroStar	160
400 E42 EuroStar	161
440 E42 EuroStar	162
180 E42 EuroTech	163
240 E42 EuroTech	164
260 E42 EuroTech	165
440 E42 EuroTech	166
180 E42 EuroTrakker	167
190 E37 EuroTrakker	168
190 E42 EuroTrakker	169
240 E42 EuroTrakker	170
260 E37 EuroTrakker	171
260 E42 EuroTrakker	172
340 E37 EuroTrakker	173
340 E42 EuroTrakker	174
380 E37 EuroTrakker	175

50 005 609



400 E37 EuroTrakker	176
400 E42 EuroTrakker	177
410 E37 EuroTrakker	178
410 E42 EuroTrakker	179
440 E37 EuroTrakker	180
440 E42 EuroTrakker	181
720 E42 EuroTrakker	182
Series 330	214

50 005 610



FIAT / IVECO

POS

190 E42 EuroStar	158
240 E42 EuroStar	159
260 E42 EuroStar	160
400 E42 EuroStar	161
440 E42 EuroStar	162
180 E42 EuroTech	163
240 E42 EuroTech	164
260 E42 EuroTech	165
440 E42 EuroTech	166
180 E42 EuroTrakker	167
190 E37 EuroTrakker	168
190 E42 EuroTrakker	169
240 E42 EuroTrakker	170
260 E37 EuroTrakker	171
260 E42 EuroTrakker	172
340 E37 EuroTrakker	173
340 E42 EuroTrakker	174
380 E37 EuroTrakker	175
400 E37 EuroTrakker	176
400 E42 EuroTrakker	177
410 E37 EuroTrakker	178
410 E42 EuroTrakker	179
440 E37 EuroTrakker	180
440 E42 EuroTrakker	181
720 E42 EuroTrakker	182
Series 330	214

50 005 612



MAN

POS

Series 19.500	114
Series 19.502	115
Series 19.603	116









MAIN APPLICATIONS

50 005 615 		50 005 615 		50 005 616 			
Series 2050	850	Series 3038	934				
Series 2053	851	Series 3050	935				
Series 2219	852	Series 3053	936				
Series 2222	854	Series 3228	937				
Series 2224	856	Series 3231	939				
Series 2225	857	Series 3233	940				
Series 2226	858	Series 3234	941				
Series 2228	859	Series 3235	942				
Series 2232	861	Series 3238	943				
Series 2233	862	Series 3240	944				
Series 2235	863	Series 3244	945				
Series 2236	864	Series 3248	946				
Series 2238	865	Series 3250	947	MERCEDES-BENZ POS			
Series 2244	866	Series 3253	948			O 303	499
Series 2327	869	Series 3328	949			O 330	515
Series 2422	871	Series 3332	950			O 404	523
Series 2425	873	Series 3333	951			Series 1222	713
Series 2426	874	Series 3335	952			Series 1224	714
Series 2427	875	Series 3336	953			Series 1225	715
Series 2428	876	Series 3338	954			Series 1226	716
Series 2429	877	Series 3344	955			Series 1227	717
Series 2433	878	Series 3528	956			Series 1228	718
Series 2434	879	Series 3529	957			Series 1422	735
Series 2435	880	Series 3534	958			Series 1426	738
Series 2436	881	Series 3535	959			Series 1428	740
Series 2438	882	Series 3536	960			Series 1429	741
Series 2444	883	Series 3538	961			Series 1442	743
Series 2448	885	Series 3544	962			Series 1622	760
Series 2524	889	Series 3548	963			Series 1625	762
Series 2527	890	Series 3550	964			Series 1627	764
Series 2528	891	Series 3553	965			Series 1628	765
Series 2529	892	Series 3636	966			Series 1629	766
Series 2531	893	Series 3833	968			Series 1722	781
Series 2532	894	Series 3835	969			Series 1726	784
Series 2534	895	Series 3836	970			Series 1728	786
Series 2535	896	Series 4044	972			Series 1729	787
Series 2536	897	Series 4050	973			Series 1733	789
Series 2538	898	Series 4150	974			Series 1735	790
Series 2539	899	Series 4435	975			Series 1824	800
Series 2540	900	Series 4436	976			Series 1829	803
Series 2544	901	Series 4445	977			Series 1922	818
Series 2550	903	Series 4635	978			Series 1926	822
Series 2553	904	Series 4645	979			Series 1928	824
Series 2622	905	Series 4648	980			Series 1929	825
Series 2624	906	Series 4836	981			Series 2222	854
Series 2626	907	Series 4838	982			Series 2225	857
Series 2627	908	Series 4844	983			Series 2228	859
Series 2628	909	Series 4850	984			Series 2229	860
Series 2629	910	Series 4853	985			Series 2422	871
Series 2631	911	Series 4936	986	Series 2426	874		
Series 2632	912	Series 5035	987	Series 2427	875		
Series 2633	913	Series 5038	988	Series 2429	877		
Series 2634	914	Series 5248	989	Series 2522	888		
Series 2635	915	Series 5436	990	Series 2527	890		
Series 2636	916	Series 6036	991	Series 2529	892		
Series 2638	918	Engine	992	Series 2628	909		
Series 2644	919			Series 2629	910		
Series 2645	920			Series 2635	915		
Series 2648	921			Series 3229	938		
Series 2650	922			Series 3328	949		
Series 2653	923			Series 3528	956		
Series 2822	924			Series 3529	957		
Series 2825	925			Series 3535	959		
Series 2828	926			Engine	992		
Series 2833	927						
Series 3025	928						
Series 3028	929						
Series 3031	930						
Series 3033	931						
Series 3035	932						
Series 3036	933						



MAIN APPLICATIONS

50 005 617 		50 005 618 		50 005 619 	
					
FORD	POS	HANOMAG	POS	Actros 1843	327
Tractor 8070	128	Series F 110	5	Actros 1844	328
HANOMAG	POS	Series F 130	6	Actros 1846	329
Series F 45	2	MERCEDES-BENZ	POS	Actros 1848	330
MERCEDES-BENZ	POS	O 302	498	Actros 1850	331
O 302	498	O 309 D 5.7	509	Actros 1853	332
O 321	513	U 435	582	Actros 1854	333
O 322	514	Series 613	673	Actros 1857	334
MB-Trac 1100	545	Series 810	683	Actros 1858	335
MB-Trac 1300	546	Series 811	684	Actros 2031	336
MB-Trac 1300 turbo	547	Series 813	686	Actros 2032	337
MB-Trac 1500 turbo	549	Series 911	689	Actros 2035	338
U 100	566	Series 913	691	Actros 2036	339
U 110	568	Series 917	693	Actros 2040	340
U 1100	589	Series 1013	694	Actros 2041	341
U 1150	590	Series 1017	696	Actros 2043	342
U 125	570	Series 1113	698	Actros 2044	343
U 1300	593	Series 1213	706	Actros 2046	344
U 1500	597	Series 1217	710	Actros 2048	345
U 416	578	Series 1313	722	Actros 2050	346
U 65	557	Series 1317	725	Actros 2053	347
U 70	559	Series 1413	729	Actros 2054	348
U 80	561	Series 1417	731	Actros 2531	349
U 84	562	Series 1419	733	Actros 2532	350
U 90	563	Series 1420	734	Actros 2535	351
U 900	587	Series 1513	744	Actros 2536	352
Series 311	633	Series 1517	746	Actros 2539	353
Series 312	634	Series 1613	753	Actros 2540	354
Series 321	638	Series 1617	755	Actros 2541	355
Series 322	639	Series 1619	757	Actros 2543	356
Series 323	640	Series 1620	758	Actros 2544	357
Series 327	641	Series 2219	852	Actros 2546	358
Series 328	642	Series 2220	853	Actros 2548	359
Series 329	643	Engine	992	Actros 2550	360
Series 710	677	50 005 619 		Actros 2553	361
Series 911	689			Actros 2554	362
Series 1113	698	IHC-CASE (CNH)	POS	Actros 2557	363
Series 1313	722	Series 600	10	Actros 2558	364
Series 1317	725	MERCEDES-BENZ	POS	Actros 2631	365
Series 1413	729	Actros 1831	320	Actros 2632	366
Series 1513	744	Actros 1832	321	Actros 2635	367
Series 1517	746	Actros 1835	322	Actros 2636	368
Series 1713	776	Actros 1836	323	Actros 2640	369
Series 1813	793	Actros 1839	324	Actros 2641	370
Engine	992	Actros 1840	325	Actros 2643	371
		Actros 1841	326	Actros 2644	372
				Actros 2646	373
				Actros 2648	374
				Actros 2650	375
				Actros 2653	376
				Actros 2654	377
				Actros 2657	378
				Actros 2658	379
				Actros 3231	380
				Actros 3232	381
				Actros 3235	382
				Actros 3236	383
				Actros 3240	384
				Actros 3241	385
				Actros 3243	386
				Actros 3244	387
				Actros 3248	388
				Actros 3331	389
				Actros 3332	390
				Actros 3335	391
				Actros 3336	392
				Actros 3340	393
				Actros 3341	394
				Actros 3343	395
				Actros 3344	396
				Actros 3346	397

MAIN APPLICATIONS



MAIN APPLICATIONS

50 005 619



Actros 3348	398
Actros 3350	399
Actros 3353	400
Actros 3354	401
Actros 3357	402
Actros 3358	403
Actros 4140	404
Actros 4141	405
Actros 4143	406
Actros 4144	407
Actros 4146	408
Actros 4148	409
Actros 4150	410
Travego O 580	496
Engine	992

50 005 620



FIAT / IVECO

POS

Series 75	189
Series 80	192
Series 90	194
Series 100	196
Series 110	198
Series 300	210
Series 314	211
Series 315	212
Series 316	213
Series 645	218
Series 650	219
Series 655	220
Series 662	221
Series 672	222
Series 980	228
Series 1000	229
Series DI 20	235
Series DI 25	236
Series DI 30	237
Series DI 35	238
Series DI 40	239
Series DI 70	240
Series DI 80	241

OM

POS

110	1
-----	---

50 005 621



FIAT / IVECO

POS

Daily-Turbo 30.8	22
Daily-Turbo 35.12	25
Daily-Turbo 35.8	23

50 005 621



Daily-Turbo 40.12	26
Daily-Turbo 45.12	28
Daily-Turbo 49.12	30
Daily-Turbo 59.12	31
Ducato 10 2.5 D Turbo	38
Ducato 10 2.8 D Turbo	39
Ducato 11 2.8 D Turbo	40
Ducato 14 2.5 D Turbo	46
Ducato 14 2.8 D Turbo	47
Ducato 15 2.8 D Turbo	49
Ducato 18 2.5 D Turbo	52
Ducato 18 2.8 D Turbo	53
Engine	251

OM

POS

Grinta 35.12	4
Grinta 40.12	6
Grinta 45.12	9
Grinta 49.12	11
Grinta 59.12	12

RENAULT

POS

Master 2.5 TD	92
Master 2.8 dTi	93

50 005 623



FIAT / IVECO

POS

Series 50-9	185
Series 60-11	187
Series 65-12	188
Series 75-12	190
Series 79-12	191
Series 95-14	195
Series 109-14	197
Series 115-14	199
Series 115-17	200
Series 135-14	201
Series 135-17	202

50 005 624



FIAT / IVECO

POS

Series 50-9	185
Series 60-9	186

50 005 625



MERCEDES-BENZ

POS

Engine	992
--------	-----

50 005 626



MERCEDES-BENZ

POS

Engine	992
--------	-----

50 005 627





MERCEDES-BENZ

POS

Vario 612 D 4.2	163
Vario 614 D 4.2	165
Vario 615 D 4.2	166
Vario 810 D 4.2	168
Vario 812 D 4.2	170
Vario 814 D 4.2	172
Vario 815 D 4.2	174
Atego 1015	427
Atego 1017	428
Atego 1018	429
Atego 1023	430
Atego 1024	431
Atego 1214	432
Atego 1215	433
Atego 1217	434
Atego 1218	435
Atego 1223	436
Atego 1224	437
Atego 1225	438
Atego 1228	439
Atego 1317	440
Atego 1318	441
Atego 1323	442
Atego 1324	443
Atego 1325	444
Atego 1328	445













MAIN APPLICATIONS

50 005 627		50 005 627		50 005 628	
Atego 1517	446	Series 1517	746	Actros 3231	380
Atego 1518	447	Series 1618	756	Actros 3232	381
Atego 1523	448	Series 1622	760	Actros 3235	382
Atego 1524	449	Series 1718	778	Actros 3236	383
Atego 1525	450	Series 1722	781	Actros 3240	384
Atego 1528	451	Series 1725	783	Actros 3241	385
Atego 1721	452	Series 1728	786	Actros 3243	386
Atego 1722	453	Series 2423	872	Actros 3244	387
Atego 1725	454	Series 2428	876	Actros 3248	388
Atego 1728	455	Series 2828	926	Actros 3331	389
Atego 1823	456	Engine	992	Actros 3332	390
Atego 1828	457			Actros 3335	391
Atego 1923	458	50 005 628		Actros 3336	392
Atego 2223	459			Actros 3340	393
Atego 2523	460	MERCEDES-BENZ	POS	Actros 3341	394
Atego 2528	461	Actros 1831	320	Actros 3343	395
Atego 2623	462	Actros 1832	321	Actros 3344	396
Atego 2628	463	Actros 1835	322	Actros 3346	397
Atego 3228	464	Actros 1836	323	Actros 3348	398
Atego 712	411	Actros 1839	324	Actros 4140	404
Atego 714	412	Actros 1840	325	Actros 4141	405
Atego 715	413	Actros 1841	326	Actros 4143	406
Atego 716	414	Actros 1843	327	Actros 4144	407
Atego 717	415	Actros 1844	328	Actros 4146	408
Atego 812	416	Actros 1846	329	Actros 4148	409
Atego 814	417	Actros 1848	330	Engine	992
Atego 815	418	Actros 2031	336		
Atego 817	419	Actros 2032	337	50 005 629	
Atego 818 Blue Tec	420	Actros 2035	338		
Atego 823	421	Actros 2036	339	MERCEDES-BENZ	POS
Atego 915	422	Actros 2040	340	O 301	497
Atego 917	423	Actros 2041	341	O 402	521
Atego 918	424	Actros 2043	342	MB-Trac 1000	544
Atego 923	425	Actros 2044	343	MB-Trac 1100	545
Atego 925	426	Actros 2046	344	MB-Trac 1300 turbo	547
Axor 1823	465	Actros 2048	345	MB-Trac 1400 turbo	548
Axor 1828	466	Actros 2531	349	MB-Trac 1600 turbo	550
Axor 2523	470	Actros 2532	350	Series 814	687
Axor 2528	471	Actros 2535	351	Series 817	688
Axor 2628	475	Actros 2536	352	Series 914	692
Citaro O 530	476	Actros 2539	353	Series 917	693
Cito O 520	479	Actros 2540	354	Series 1017	696
Conecto O 345	480	Actros 2541	355	Series 1114	699
Econic 1823	481	Actros 2543	356	Series 1117	702
Econic 1828	482	Actros 2544	357	Series 1120	703
Econic 2628	483	Actros 2546	358	Series 1121	704
Freightliner (USA)	484	Actros 2548	359	Series 1124	705
O 500	529	Actros 2631	365	Series 1214	707
U 300	574	Actros 2632	366	Series 1217	710
U 3000	609	Actros 2635	367	Series 1222	713
U 400	575	Actros 2636	368	Series 1224	714
U 4000	610	Actros 2640	369	Series 1231	719
U 500	583	Actros 2641	370	Series 1314	723
U 5000	611	Actros 2643	371	Series 1317	725
Series 614	674	Actros 2644	372	Series 1320	727
Series 615	675	Actros 2646	373	Series 1324	728
Series 711	678	Actros 2648	374	Series 1414	730
Series 712	679				
Series 811	684				
Series 817	688				
Series 914	692				
Series 917	693				
Series 1114	699				
Series 1115	700				
Series 1117	702				
Series 1215	708				
Series 1218	711				
Series 1317	725				
Series 1318	726				
Series 1417	731				
Series 1418	732				

MAIN APPLICATIONS



MAIN APPLICATIONS

50 005 629 		50 005 630 		50 005 631 		
Series 1417	731	Series 18.222	68	Series 18.232	70	
Series 1419	733	Series 18.232	70	Series 18.262	73	
Series 1420	734	Series 18.262	73	Series 18.272	74	
Series 1514	745	Series 18.272	74	Series 24.192	148	
Series 1517	746	Series 24.192	148	Series 24.222	150	
Series 1520	749	Series 24.222	150	Series 24.232	151	
Series 1524	751	Series 24.232	151	Series 24.262	154	
Series 1614	754	Series 24.262	154	Series 24.272	155	
Series 1617	755	Series 24.272	155	Series EM 192	340	
Series 1619	757	Series EM 192	340	Series NG 272	395	
Series 1620	758	Series NG 272	395	Series NM 192	408	
Series 1717	777	Series NM 192	408	Series NM 223	409	
Series 1720	780	Series NM 223	409	Series SM 192	444	
Series 1722	781	Series SM 192	444	Engine	513	
Series 1724	782	Engine	513	STEYR	POS	
Series 1814	794	50 005 631 		8 S 22	1	
Series 1816	795			9 S 22	2	
Series 1817	796					
Series 1820	798	50 005 632 				
Series 1821	799					
Series 1920	816	MAN		MERCEDES-BENZ		
Series 2020	837	Alé		POS		
Series 2024	838	Arena 8.5		O 303		499
Series 2219	852	Midi Beta		O 304		500
Series 2220	853	Series 7.153		O 305		501
Series 2222	854	Series 8.220		O 330		515
Series 2320	867	Series 8.224		O 340		516
Series 2420	870	Series 9.224		O 405		524
Series 2517	886	Series 10.153		O 407		526
Series 2521	887	Series 10.190		O 408		527
Engine	992	Series 10.220		Series 2638		918
50 005 630 		Series 10.224		Series 3538		961
		Series 11.190		Engine		992
		Series 11.192		50 005 633 		
MAN		Series 11.230				
POS		Series 11.232				
Alé		Series 12.152		MERCEDES-BENZ		
Arena 8.5		Series 12.162		POS		
Midi Beta		Series 12.192		Forst-Trac		531
Series 11.190		Series 12.220		MB-Trac 700		540
Series 11.192		Series 12.222		MB-Trac 800		541
Series 11.230		Series 12.224		MB-Trac 900 Turbo		543
Series 11.232		Series 12.232		U 110		568
Series 12.192		Series 12.262		U 130		571
Series 12.220		Series 12.272		U 140		572
Series 12.222		Series 12.272		Series 609		670
Series 12.232		Series 13.220				
Series 12.262		Series 13.230				
Series 12.272		Series 14.152				
Series 13.220		Series 14.162				
Series 13.230		Series 14.192				
Series 14.192		Series 14.222				
Series 14.222		Series 14.224				
Series 14.232		Series 14.232				
Series 14.262		Series 14.262				
Series 14.272		Series 14.272				
Series 17.192		Series 15.224				
Series 17.222		Series 17.192				
Series 17.232		Series 17.222				
Series 17.272		Series 17.232				
Series 18.192		Series 17.272				
Series 18.222		Series 18.192				
Series 18.224		Series 18.222				
		Series 18.224				



50 005 633	
Series 610	671
Series 611	672
Series 614	674
Series 709	676
Series 710	677
Series 711	678
Series 712	679
Series 714	680
Series 809	682
Series 810	683
Series 811	684
Series 812	685
Series 813	686
Series 814	687
Series 912	690
Series 913	691
Series 914	692
Series 1114	699
Series 1214	707
Engine	992

50 005 634	
	
VOLVO	POS
340 1.6 D	10
360 1.6 D	12
FH 16-550	132
FH 16-610	133

50 005 720	
	
FORD	POS
Escort 1.6 D	17
Fiesta 1.6 D	32
Orion 1.6 D	80

50 005 721	
	
FORD	POS
Capri 1.6	2
Capri 2.0	3
Granada 2.0	57
Scorpio 2.0	85
Sierra 1.6	89
Sierra 1.8	90
Sierra 2.0i	92
Taurus 1.3	97
Taurus 1.6	98
Taurus 2.0	99

50 005 725	
	
FORD	POS
Escort 1.8 D	18
Fiesta 1.8 D	34
Orion 1.8 D	81
MAZDA	POS
121 1.8 D	5

50 005 727	
	
FORD	POS
Tourneo 2.5 D	100
Tourneo 2.5 TDi	101
Transit 2.5 D	109
Transit 2.5 DI	111
Transit 2.5 TD	110
A 0407	118

50 005 732	
	
OPEL	POS
Ascona C 2.0i	22
Astra F 1.8i	30
Astra F 2.0i	32
Calibra 2.0i	58
Frontera A 2.0i	107
Frontera A 2.0i 16V	108
Kadett E 1.8i	139
Kadett E 2.0i	140
Omega A 2.0i	165
Omega B 2.0i	172
Omega B 2.0i 16V	173
Vectra A 1.8i	218
Vectra A 2.0i	219
Vectra B 2.0i	226
VAUXHALL	POS
Carlton III 2.0i	65
Frontera A 2.0i 16V	117
Omega B 2.0i	141
Omega B 2.0i 16V	142
Vectra B 2.0i	166

50 005 733	
	
OPEL	POS
Ascona C 1.6	17
Ascona C 1.6i	18
Astra F 1.4	23
Astra F 1.6i	26
Corsa A 1.4	82
Corsa A 1.4i	83
Corsa A 1.6i	86
Kadett E 1.4	131
Kadett E 1.6	134
Kadett E 1.6i	135
Vectra A 1.4	212
Vectra A 1.6	213
VAUXHALL	POS
Astra E 1.4	11
Astra E 1.6i	15
Astra F 1.4	20
Belmont 1.4	51
Cavalier II 1.6i	78
Cavalier III 1.4	83
Nova 1.4	138
Nova 1.6i	140

MAIN APPLICATIONS



MAIN APPLICATIONS

50 005 734



LADA	POS
110 2.0 i 16V	1
OPEL	POS
Astra F 1.7 D	28
Astra F 1.7 TD	29
Astra F 1.8i 16V	31
Astra F 2.0i 16V	33
Astra G 1.7 TD	38
Astra G 2.0i 16V	41
Astra G 2.0i Turbo 16V	42
Calibra 2.0i 16V	59
Calibra 2.0i Turbo 16V	60
Frontera A 2.2i 16V	109
Kadett E 2.0i 16V	141
Omega B 2.0i 16V	173
Speedster 2.0i Turbo 16V	205
Vectra A 1.7 D	215
Vectra A 2.0i 16V	220
Vectra A 2.0i Turbo 16V	221
Vectra B 1.8i 16V	225
Vectra B 2.0i 16V	227
Zafira A 2.0i 16V	245
Zafira A 2.0i Turbo 16V	246
VAUXHALL	POS
Astra E 2.0i 16V	19
Astra F 1.7 TD	25
Astra F 1.8i 16V	27
Astra F 2.0i 16V	29
Astra G 1.7 TD	34
Astra G 2.0i 16V	37
Astra G 2.0i Turbo 16V	38
Belmont 2.0i 16V	56
Calibra 2.0i 16V	58
Cavalier III 2.0i 16V	88
Frontera A 2.2i 16V	118
Omega B 2.0i 16V	142
Sintra 2.2i 16V	156
Vectra B 1.8i 16V	165
Vectra B 2.0i 16V	167
VX 220 2.0i Turbo 16V	180
Zafira A 2.0i 16V	185
Zafira B 2.0i Turbo 16V	193

50 005 735



OPEL	POS
Ascona C 1.6	17
Ascona C 1.8	20
Ascona C 1.8i	21
Ascona C 2.0i	22
Astra F 1.8i	30
Astra F 2.0i	32
Calibra 2.0i	58
Frontera A 2.0i	107
Kadett D 1.6	125
Kadett E 1.8	138
Kadett E 1.8i	139
Kadett E 2.0i	140
Omega A 1.8	163
Omega A 1.8i	164
Omega A 2.0i	165
Omega B 2.0i	172
Vectra A 1.8	217
Vectra A 1.8i	218
Vectra A 2.0i	219
VAUXHALL	POS
Astra D 1.6	5
Astra E 1.8	16
Astra E 1.8i	17
Astra F 1.8i	26
Belmont 1.8i	55
Carlton III 1.8	63
Carlton III 1.8i	64
Carlton III 2.0i	65
Cavalier II 1.6	77
Cavalier II 1.8	80
Cavalier II 1.8i	81
Cavalier III 1.8	85
Omega B 2.0i	141

50 005 736



OPEL	POS
Ascona C 1.6 D	19
Astra F 1.7 D	28
Kadett D 1.6 D	126
Kadett E 1.6 D	136
Kadett E 1.7 D	137
Vectra A 1.7 D	215
VAUXHALL	POS
Astra D 1.6 D	6

50 005 736



Astra E 1.6 D	14
Belmont 1.6 D	54
Cavalier II 1.6 D	79

50 005 737



LADA	POS
110 2.0 i 16V	1
OPEL	POS
Astra F 2.0i 16V	33
Calibra 2.0i 16V	59
Calibra 2.0i Turbo 16V	60
Kadett E 2.0i 16V	141
Vectra A 2.0i 16V	220
Vectra A 2.0i Turbo 16V	221
VAUXHALL	POS
Astra E 2.0i 16V	19
Astra F 2.0i 16V	29
Belmont 2.0i 16V	56
Calibra 2.0i 16V	58
Cavalier III 2.0i 16V	88

50 005 738



OPEL	POS
Astra 1.4i 16V	25
Astra F 1.6i 16V	27
Astra G 1.4i 16V	34
Astra G 1.6i 16V	36
Astra Classic 1.6i 16V	55
Combo 1.4i 16V	65
Corsa B 1.4i 16V	88
Corsa B 1.6i 16V	92
Tigra 1.4i 16V	207
Tigra 1.6i 16V	208
Vectra B 1.6i 16V	224
Zafira A 1.6i 16V	242
SKODA	POS
Superb 1.9 TDI	31
Superb 2.0 TDI	33
VAUXHALL	POS
Astra F 1.4i 16V	22
Astra F 1.6i 16V	24
Astra G 1.4i 16V	30
Astra G 1.6i 16V	32
Corsa B 1.4i 16V	102





MAIN APPLICATIONS

50 005 738	
Corsa B 1.6i 16V	104
Tigra 1.4i 16V	158
Tigra 1.6i 16V	159
Vectra B 1.6i 16V	164
Zafira A 1.6i 16V	182

50 005 739	
	
OPEL	POS
Corsa A 1.5 D	84
Corsa A 1.5 TD	85
Kadett E 1.5 TD	133

50 005 740	
	
DAEWOO	POS
Imperial 3.0i	6
OPEL	POS
Frontera A 2.4i	110
Monza A 3.0i	159
Omega A 2.3 D	166
Omega A 2.3 TD	167
Omega A 2.4i	168
Omega A 2.6i	169
Omega A 3.0i	170
Omega A 3.0i 24V	171
Senator A 3.0i	195
Senator B 2.5i	196
Senator B 2.6i	197
Senator B 3.0i	198
Senator B 3.0i 24V	199
VAUXHALL	POS
Carlton III 2.3 D	66
Carlton III 2.3 TD	67
Carlton III 2.4i	68
Carlton III 2.6i	69
Carlton III 3.0i	70
Carlton III 3.0i 24V	71
Frontera A 2.4i	119
Senator A 3.0	148
Senator B 2.5i	149
Senator B 2.6i	150
Senator B 3.0i	151
Senator B 3.0i 24V	152

50 005 741	
	
OPEL	POS
Astra F 1.7 TD	29
Combo 1.7 D	67
Corsa A 1.5 D	84
Corsa A 1.5 TD	85
Corsa B 1.5 D	90
Corsa B 1.5 TD	91
Corsa B 1.7 D	93
Kadett E 1.5 TD	133
VAUXHALL	POS
Combo 1.7 D	96
Corsa B 1.7 D	105

50 005 746	
	
OPEL	POS
Astra F 1.7 TD	29
Combo 1.7 D	67
Corsa B 1.7 D	93
Vectra A 1.7 TD	216
VAUXHALL	POS
Combo 1.7 D	96
Corsa B 1.7 D	105

50 005 747	
	
OPEL	POS
Astra G 1.8i 16V	40
Astra H 1.8i 16V	50
Corsa C 1.8i 16V	103
Meriva 1.8i 16V	158
Signum 1.8i 16V	200
Tigra B 1.8i 16V	210

50 005 747	
Vectra B 1.8i 16V	225
Vectra C 1.8i 16V	234
Zafira A 1.8i 16V	244
SAAB	POS
9-3 1.8i 16V	1
VAUXHALL	POS
Astra G 1.8i 16V	36
Astra H 1.8i 16V	46
Corsa C 1.8i 16V	115
Meriva 1.8i 16V	129
Signum 1.8i 16V	153
Tigra B 1.8i 16V	162
Vectra B 1.8i 16V	165
Vectra C 1.8i 16V	173
Zafira A 1.8i 16V	184

50 005 748	
	
OPEL	POS
Astra G 2.0 DI 16V	43
Astra G 2.0 DTi 16V	44
Frontera B 2.2 DTi 16V	112
Omega B 2.0 DTi 16V	174
Omega B 2.2 DTi 16V	176
Signum 2.0 16V DTi	201
Sintra 2.2 TDI 16V	203
Vectra B 2.0 DI 16V	228
Vectra B 2.0 DTi 16V	229
Vectra C 2.0 DTi 16V	236
Zafira A 2.0 DI 16V	247
Zafira A 2.0 DTi 16V	248
SAAB	POS
9-3 2.2 TiD 16V	5
9-5 2.2 TiD 16V	9
VAUXHALL	POS
Astra G 2.0 DI 16V	39
Astra G 2.0 DTi 16V	40
Frontera B 2.2 DTi 16V	120
Omega B 2.0 DTi 16V	143
Omega B 2.2 DTi 16V	145
Signum 2.0 DTi 16V	155
Sintra 2.2 TDI 16V	157
Vectra B 2.0 DI 16V	168
Vectra B 2.0 DTi 16V	169
Vectra C 2.0 DTi 16V	175
Zafira A 2.0 DI 16V	186
Zafira A 2.0 DTi 16V	187

MAIN APPLICATIONS



MAIN APPLICATIONS

50 005 749



OPEL	POS
Corsa A 1.5 TD	85
Corsa B 1.5 TD	91
VAUXHALL	POS
Corsa B 1.5 TD	103

50 005 750



SEAT	POS
Cordoba 1.9 SDI	35
Ibiza 1.9 SDI	55
SKODA	POS
Fabia 1.9 SDI	9
VOLKSWAGEN	POS
Fox 1.9 SDI	72
Polo 1.9 SDI	291
Polo Sedan 1.9 SDI	300
Spacefox 1.9 SDI	349
Sportvan 1.9 SDI	350
Suran 1.9 SDI	351

50 005 751



FORD	POS
Fiesta 2.0i 16V	21
Focus 2.0i 16V	41
Focus C-Max 1.8i 16V	45
Focus C-Max 2.0i 16V	47
Mondeo 1.8 SCi 16V	68
Mondeo 1.8i 16V	67
Mondeo 2.0i 16V	69
S-Max 2.0i 16V	95
MAZDA	POS
5 1.8i 16V	36
6 1.8i 16V	37

50 005 751



6 2.3i 16V	54
MX-5 1.8i 16V	18

50 005 752



FORD	POS
Mondeo 2.0 DI 16V	70
Mondeo 2.0 TDCI 16V	71
JAGUAR	POS
X-Type 2.0 d 16V	1

50 005 753



NISSAN	POS
Almera 2.2 DTi 16V	9
Almera Tino 2.2 DTi 16V	12
Primera 2.2 DTi 16V	44
X-Trail 2.2 TDi 16V	69
X-Trail 2.2 dCi 16V	70

50 005 754



AUDI	POS
A2 1.6 FSI 16V	4
SEAT	POS
Leon 1.6i 16V	70
Toledo 1.6i 16V	83
VOLKSWAGEN	POS
Bora 1.6 FSI 16V	4
Bora 1.6i 16V	3
Golf IV 1.6 FSI 16V	130
Golf IV 1.6i 16V	129
Lupo 1.6i 16V	216
Polo 1.6i 16V	286

50 005 755



OPEL	POS
Astra G 1.7 DTI 16V	39
Astra H 1.7 CDTi 16V	49
Combo 1.7 CDTi 16V	70
Combo 1.7 DI 16V	68
Combo 1.7 DTI 16V	69
Corsa C 1.7 CDTi 16V	102
Corsa C 1.7 DI 16V	100
Corsa C 1.7 DTI 16V	101
Meriva 1.7 CDTi 16V	157
Meriva 1.7 DTI 16V	156
VAUXHALL	POS
Astra G 1.7 DTI 16V	35
Astra H 1.7 CDTi 16V	45
Combo 1.7 CDTi 16V	99
Combo 1.7 DI 16V	97
Combo 1.7 DTI 16V	98
Corsa C 1.7 CDTi 16V	114
Corsa C 1.7 DI 16V	112
Corsa C 1.7 DTI 16V	113
Meriva 1.7 CDTi 16V	127
Meriva 1.7 DI 16V	128
Meriva 1.7 DTI 16V	126

50 005 756



MITSUBISHI	POS
Carisma 1.9 CDi	9
Carisma 1.9 TD	8
Space Star 1.9 CDi	77
NISSAN	POS
Interstar 1.9 dCi	16
Primastar 2.0i 16V	35
OPEL	POS
Movano 1.9 DTI	160
Vivaro 1.9 DI	238
Vivaro 1.9 DTI	239
Vivaro 2.0i 16V	240
RENAULT	POS
Avantime 2.0i Turbo 16V	2
Espace IV 1.9 dCi	38
Espace IV 2.0i 16V	39
Espace IV 2.0i Turbo 16V	40
Grand Scénic 2.0i 16V	53
Laguna I 1.9 dCi	65
Laguna I 2.0i 16V	68
Laguna II 1.8i 16V	73
Laguna II 1.9 dCi	74



MAIN APPLICATIONS

50 005 756	
Laguna II 2.0i 16V	75
Laguna II 2.0i Turbo 16V	76
Laguna Grandtour 1.8i 16V	80
Laguna Grandtour 1.9 dCi	82
Laguna Grandtour 2.0i 16V	84
Laguna Grandtour 2.0i Turbo16V	85
Master 1.9 dCi	91
Master 1.9 dTi	103
Mégane 1.9 dCi	111
Mégane 1.9 dTi	112
Mégane Classic 1.9 dCi	123
Mégane Classic 1.9 dTi	122
Mégane Grandtour 1.9 dCi	132
Mégane Grandtour 1.9 dTi	131
Mégane II 2.0i 16V	138
Mégane II 2.0i 16V Sport	140
Mégane II 2.0i Turbo 16V	139
Scénic 1.9 dCi	230
Scénic 1.9 dTi	229
Scénic II 1.9 dCi	236
Scénic II 2.0i 16V	237
Scénic II 2.0i Turbo 16V	238
Trafic 1.9 dCi 100	251
Trafic 1.9 dCi 80	250
Trafic 2.0i 16V	253
Vel Satis 2.0i Turbo 16V	259
VAUXHALL	POS
Movano 1.9 DTI	130
Vivaro 1.9 DTI	177
Vivaro 2.0i 16V	178
VOLVO	POS
S40 1.9 TDI	77
V40 1.9 TDI	102

50 005 757	
PEUGEOT	POS
106 1.1i	3
206 1.1i	23
Partner 1.1i	164

50 005 758	
MAZDA	POS
2 1.4 CDi	7

50 005 758	
PEUGEOT	POS
107 1.4 HDI	9
206 1.4 HDi	26
207 1.4 HDi	34
307 1.4 HDI	53
1007 1.4 HDI	139
TOYOTA	POS
Aygo 1.4 D-4D	20

50 005 759	
RENAULT	POS
Clio I 1.2i	5
Express 1.2i	44
Rapid 1.2i	212
Twingo 1.2i	258

50 005 760	
FIAT / IVECO	POS
Dobló 1.3 JTD 16V	34
Idea 1.3 JTD 16V	61
Palio 1.3 JTD	70
Panda II 1.3 JTD 16V	79
Punto 1.3 JTD 16V	84
LANCIA	POS
Musa 1.3 JTD 16V	7
Ypsilon 1.3 JTD 16V	17
OPEL	POS
Agila 1.3 CDTi 16V	5
Combo 1.3 CDTi 16V	63
Corsa C 1.3 CDTi 16V	96
Meriva 1.3 CDTi 16V	152
Tigra B 1.3 CDTi 16V	209
SUBARU	POS
Justy 1.3 TDI 16V	8
SUZUKI	POS
Ignis 1.3 DDiS	13
New Ignis 1.3 DDiS 16V	19
New Swift 1.3 DDiS 16V	21
Solio 1.3 DDiS 16V	30
Swift 1.3 DDiS	31
Wagon R+ 1.3 DDiS	41
VAUXHALL	POS
Agila 1.3 CDTi 16V	3
Combo 1.3 CDTi 16V	92
Corsa C 1.3 CDTi 16V	108

50 005 760	
Meriva 1.3 CDTi 16V	122
Tigra B 1.3 CDTi 16V	160

50 005 761	
PEUGEOT	POS
206 2.0 HPi 16V	31
206 2.0i 16V	30
307 2.0i 16V	55
307 CC 2.0i 16V	58
406 1.8i 16V	88
406 2.0 HPi 16V	93
406 2.0i 16V	90
407 1.8i 16V	97
407 2.0i 16V	98
607 2.0i 16V	122
806 2.0i 16V	130
807 2.0i 16V	134
Expert 2.0i 16V	157

50 005 762	
FORD	POS
Fiesta 1.6 TDCi 16V	33
Fusion 1.6 TDCi 16V	52
MAZDA	POS
3 1.6 CDi 16V	49
PEUGEOT	POS
206 1.6 HDi 16V	28
207 1.6 HDi 16V	35
307 1.6 HDi 16V	54
308 1.6 HDi 16V	60
407 1.6 HDi 16V	96
1007 1.6 HDi 16V	141
Partner 1.6 HDi 16V	167
VOLVO	POS
C30 1.6 TDI 16V	66
S40 1.6 TDI 16V	73
V50 1.6 TDI 16V	107

MAIN APPLICATIONS



MAIN APPLICATIONS

50 005 763



NISSAN	POS
Cube 1.4i 16V	15
Micra 1.0i 16V	23
Micra 1.2i 16V	24
Micra 1.4i 16V	26

50 005 766



CITROEN	POS
C2 1.4i 16V	27
C3 1.4i 16V	29
C4 1.4i 16V	31
PEUGEOT	POS
206 1.4i 16V	25
207 1.4i 16V	33
307 1.4i 16V	52
1007 1.4i 16V	140

50 005 769



SEAT	POS
Cordoba 1.0i 16V	20
Cordoba 1.4i 16V	24
Ibiza 1.0i 16V	40
Ibiza 1.4i 16V	45
VOLKSWAGEN	POS
Polo 1.4i 16V	281

50 005 764



VOLVO	POS
S60 2.4 TDI 20V	83
S80 2.4 TDI 20V	93
S80 2.9i Turbo 24V	97
V70 II 2.4 TDi 20V	120
XC70 2.4 TDI 20V	121
XC90 2.4 TDI 20V	122
XC90 2.9i Turbo 24V	123

50 005 767



MERCEDES-BENZ	POS
E 320 CDI (210)	80

50 005 770



SEAT	POS
Cordoba 1.2i 12V	21
Ibiza 1.2i 12V	42

50 005 765



CITROEN	POS
C4 2.0i 16V	32
PEUGEOT	POS
407 2.2i 16V	100
607 2.2i 16V	125
807 2.2i 16V	136

50 005 768



SKODA	POS
Fabia 1.0i	1
Fabia 1.4i	4

50 005 771



AUDI	POS
A6 3.0i 30V	45
A8 3.0i 30 V	52

MAIN APPLICATIONS



MAIN APPLICATIONS

50 005 772



SEAT	POS
Arosa 1.0i	13
VOLKSWAGEN	POS
Lupo 1.0i	210

50 005 773



MERCEDES-BENZ	POS
C 180 (203)	8

50 005 774



FORD	POS
Cougar 2.5i 24V	7
Mondeo 2.5i 24V	72

50 005 775



AUDI	POS
A3 1.6i	5
A3 2.0 FSI 16V	10
A4 2.0 FSI 16V	20
SEAT	POS
Altea 1.6 SRE	9
Altea 2.0 FSI 16V	11
Leon 1.6 SRE	69
Leon 2.0 FSI 16V	76
Toledo 1.6 SRE	84
Toledo 2.0 FSI 16V	94

SKODA	POS
Octavia 1.6i	16
Octavia 2.0 FSI 16V	24

VOLKSWAGEN	POS
Caddy 1.6	18
Caddy 1.6i	19
Caddy Maxi 1.6i	28
Eos 2.0 FSI 16V	65
Golf V 1.6i	142
Golf V 2.0 FSI 16V	146
Golf Plus 1.6 SRE	152
Golf Plus 2.0 FSI 16V	154
Jetta 1.6i	165
Jetta 2.0 FSI 16V	179
Maxi 1.6i	218
Passat 1.6i	237
Passat 2.0 FSI 16V	254
Touran 1.6i	354
Touran 2.0 FSI 16V	357

50 005 776



MERCEDES-BENZ	POS
V 200 CDI 2.2 (638)	154
V 220 CDI (638)	155
Vito 108 CDI 2.2	178
Vito 110 CDI 2.2	180
Vito 112 CDI 2.2	182
Engine	992

50 005 777



AUDI	POS
A6 4.2i 40V	46
A8 3.7i 40V	54
A8 4.2i 40V	56
S6 4.2i 40V	64
S8 4.2i 40V	66

50 005 778



BMW	POS
840 Ci 32V (E31)	75
735 3.5i 32V (E38)	111
740 4.0i 32V (E38)	112
535 3.5i 32V (E39)	119
540 4.4i 32V (E39)	120
X5 4.4i 32V (E53)	131

50 005 779



CITROEN	POS
Berlingo 2.0 HDi	14
C4 2.0 HDi 16V	33
C4 Picasso 2.0 HDi 16V	34
C5 2.0 HDi 16V	36
C8 2.0 HDi 16V	37
Grand C4 Picasso 2.0 HDi 16V	58
Jumpy 2.0 HDi 16V	66
FIAT / IVECO	POS
Scudo 2.0 JTD 140 16V	92

MAIN APPLICATIONS



MAIN APPLICATIONS

50 005 779



Ulysse 2.0 JTD 16V	109
Ulysse 2.2 JTD 16V	113
FORD	POS
Focus 2.0 TDCi 16V	43
Focus C-Max 2.0 TDCi 16V	48
Galaxy 2.0 TDCi 16V	54
S-Max 2.0 TDCii 16V	96
LANCIA	POS
Phedra 2.0 JTD 16V	8
PEUGEOT	POS
307 2.0 HDi 16V	57
307 CC 2.0 HDi 16V	59
308 2.0 HDi 16V	61
406 2.2 HDi 16V	95
407 2.0 HDi 16V	99
607 2.0 HDi 16V	124
607 2.2 HDi Biturbo 16V	126
807 2.0 HDi 16V	135
807 2.2 HDi 16V	137
Expert 2.0 HDi 16V	156
VOLVO	POS
C30 2.0 TD 16V	67
C70 2.0 TD 16V	68
S40 2.0 TDI 16V	81
S80 2.0 TD 16V	92
V50 2.0 TDI 16V	108
V70 II 2.0 TD 16V	117

50 005 780



FIAT / IVECO	POS
Barchetta 1.6i 16V	4
Brava 1.6i 16V	6
Bravo 1.6i 16V	9
Doblò 1.6i 16V	33
Marea 1.6i 16V	64
Multipla 1.6i 16V	67
LANCIA	POS
Dedra 1.6i 16V	1
Delta 1.6i 16V	2
Lybra 1.6i 16V	4

50 005 781



VOLKSWAGEN	POS
LT 28 TDI	187
LT 35 TDI	196
LT 46 TDI	204

50 005 782



MERCEDES-BENZ	POS
Sprinter 211 CDI	129
Sprinter 213 CDI	131
Sprinter 216 CDI	133
Sprinter 311 CDI	137
Sprinter 313 CDI	139
Sprinter 316 CDI	142
Sprinter 411 CDI	146
Sprinter 413 CDI	148
Sprinter 416 CDI	151
Sprinter 616 CDI	152
Engine	992

50 005 783



AUDI	POS
A3 1.9 TDI	9
A3 2.0 TDI	11
A4 1.9 TDI	18
A4 2.0 TDI	21
A6 1.9 TDI	31
FORD	POS
Galaxy 1.9 TDI	53
SEAT	POS
Alhambra 1.9 TDI	5
SKODA	POS
Fabia 1.9 TDI	10
Octavia 1.9 TDI	21
Roomster 1.9 TDI	29
Superb 1.9 TDI	31
Superb 2.0 TDI 16V	34
VOLKSWAGEN	POS
Bora 1.9 TDI	8
Golf IV 1.9 TDI	134
New Beetle 1.9 TDI	224
Passat 2.0 TDI	255
Sharan 1.9 TDI	344

50 005 784



BMW	POS
320d 16V (E46)	128

50 005 785



BMW	POS
730d 3.0 24V (E38)	110
530d 3.0 24V (E39)	118
330d 3.0 24V (E46)	130
ROVER	POS
Range Rover III 3.0 Td6	9

50 005 786



BMW	POS
730d 3.0 24V (E38)	110
530d 3.0 24V (E39)	118



MAIN APPLICATIONS

50 005 787 



FORD **POS**

Fiesta 1.3i	26
KA 1.3i	64

50 005 791 



NISSAN **POS**

Micra 1.0i 16V	23
Micra 1.3i 16V	25

50 005 793 



OPEL **POS**

Astra F 1.4i 16V	25
Astra G 1.6i 16V	36
Astra Classic 1.6i 16V	55
Meriva 1.6i 16V	155
Vectra B 1.6i 16V	224
Vectra C 1.6i 16V	233
Zafira A 1.6i 16V	242

VAUXHALL **POS**

Astra G 1.6i 16V	32
Meriva 1.6i 16V	125
Vectra B 1.6i 16V	164
Vectra C 1.6i 16V	172
Zafira A 1.6i 16V	182

50 005 788 





HONDA **POS**

CRV 2.0 i 16V	14
---------------	----

50 005 792 



50 005 794 



NISSAN **POS**

Interstar 2.2 dCi 16V	18
Interstar 2.5 dCi 16V	19
Primastar 2.5 dCi 16V	36

OPEL **POS**

Movano 2.2 DTI 16V	161
Movano 2.5 CDTI 16V	162
Vivaro 2.5 CDTI 16V	241

RENAULT **POS**

Espace III 2.2 dCi 16V	36
Espace IV 2.2 dCi 16V	41
Laguna II 2.2 dCi 16V	77
Laguna Grandtour 2.2 dCi 16V	89
Master 2.5 dCi 16V	104
Master T28 2.2 dCi 16V	95
Trafic II 2.5 dCi 16V	257
Vel Satis 2.2 dCi 16V	260

VAUXHALL **POS**

Movano 2.2 DTI 16V	131
Movano 2.5 DTI 16V	132
Vivaro 2.5 CDTI 16V	179

50 005 789 



HONDA **POS**

Civic 1.6 i 16V	19
FR-V 1.7i 16V	28
Stream 1.7 i 16V	40

ALFA ROMEO **POS**

159 1.9 JTS 16V	12
-----------------	----

CHEVROLET **POS**

Astra G 2.2i 16V	1
------------------	---

FIAT / IVECO **POS**

Croma 2.2i 16V	15
----------------	----

OPEL **POS**

Astra G 2.2i 16V	45
Speedster 2.2i 16V	206
Vectra B 2.2i 16V	230
Vectra C 2.2i 16V	237
Zafira A 2.2i 16V	249

VAUXHALL **POS**

Astra G 2.2i 16V	41
Vectra B 2.2i 16V	170
Vectra C 2.2i 16V	176
VX 220 2.2i 16V	181
Zafira A 2.2i 16V	188

50 005 790 



KIA **POS**

Sorento 2.5 CRDi 16V	7
----------------------	---



MAIN APPLICATIONS

50 005 795



NISSAN	POS
Primera 1.9 dCi	40
RENAULT	POS
Mégane II 1.9 dCi	137

50 005 798



VOLVO	POS
S80 2.5 TDI	94
V70 II 2.5 TDI	119

50 005 800



VOLKSWAGEN	POS
California 1.9 D	32
California 1.9 TD	33
Transporter T4 1.9 D	368
Transporter T4 1.9 TD	369

50 005 796



VOLVO	POS
S40 1.8i 16V	74
V40 1.8i 16V	99

50 005 799



DAIHATSU	POS
Altis 2.4i 16V	1
TOYOTA	POS
Allion 2.0i 16V	3
Alphard 2.4i 16V	4
Avensis I 2.0i 16V	10
Avensis II 2.0i 16V	15
Avensis II 2.4i 16V	17
Avensis Verso 2.0i 16V	18
Blade 2.4i 16V	27
Caldina 2.0i 16V	31
Camry 2.4i 16V	37
Camry Solara 2.4i 16V	39
Corolla 2.4i 16V	72
Estima 2.4i 16V	99
Gaia 2.0i 16V	100
Harrier 2.4i 16V	102
Highlander 2.4i 16V	106
Ipsum 2.0i 16V	109
Ipsum 2.4i 16V	112
Isis 2.0i 16V	114
Kluger 2.4i 24V	117
Mark X 2.4i 16V	130
Matrix 2.4i 16V	132
Noah 2.0i 16V	137
Noah 2.4i 16V	138
Opa 2.0i 16V	140
Premio 2.0i 16V	154
Previa 2.4i 16V	156
RAV4 2.0i 16V	165
Tarago 2.4i 16V	187
Vanguard 2.4i 16V	192
Voxy 2.0i 16V	202
Wish 2.0i 16V	207

50 005 801



SEAT	POS
Cordoba 2.0i 16V	37
Ibiza 2.0i 16V	59
Toledo 2.0i 16V	93
VOLKSWAGEN	POS
Corrado 2.0i 16V	52
Golf II 2.0i 16V	114
Golf III 2.0i 16V	123
Passat 2.0i 16V	252

50 005 797



VOLVO	POS
S80 2.8i Turbo 24V	95
S80 2.9i 24V	96

50 005 802



VOLKSWAGEN	POS
Campmobil 1.6 D	42
Transporter T2 1.6 D	365

MAIN APPLICATIONS



MAIN APPLICATIONS

50 005 803



SEAT	POS
Cordoba 1.8i 16V	30
Ibiza 1.8i 16V	51
Toledo 1.8i 16V	86
VOLKSWAGEN	POS
Corrado 1.8i 16V	49
Gol 1.8i 16V	84
Golf I 1.5 D	96
Golf I 1.6 D	99
Golf II 1.8i 16V	112
Jetta 1.6 D	169
Jetta 1.8i 16V	174
Passat 1.8i 16V	243
Scirocco 1.8i 16V	342

50 005 805



SEAT	POS
Alhambra 2.0i	6
Cordoba 2.0i	36
Ibiza 2.0i	58
Toledo 2.0i	92
VOLKSWAGEN	POS
Corrado 2.0i	51
Gol 2.0i	90
Golf III 2.0i	122
Passat 2.0i	251
Polo 2.0i	293
Polo Classic 2.0i	297
Sharan 2.0i	345
Vento 2.0i	390

50 005 806

Gol 1.9 TDI	88
Golf II 1.6 TD	109
Golf III 1.9 D	118
Golf III 1.9 SDI	121
Golf III 1.9 TD	119
Golf III 1.9 TDI	120
Golf IV 1.9 TDI	134
Jetta 1.6 TD	170
Passat 1.6 TD	240
Passat 1.9 D	248
Passat 1.9 TD	249
Passat 1.9 TDI	250
Polo 1.9 D	290
Polo 1.9 SDI	291
Polo 1.9 TDI	292
Sharan 1.9 TDI	344
Vento 1.9 D	386
Vento 1.9 SDI	389
Vento 1.9 TD	387
Vento 1.9 TDI	388

50 005 804



AUDI	POS
80 1.6 D	100
80 1.6 TD	101
VOLKSWAGEN	POS
Passat 1.5 D	235
Passat 1.6 D	239
Passat 1.6 TD	240
Santana 1.6 D	321
Santana 1.6 TD	322

50 005 806



FORD	POS
Galaxy 1.9 TDI	53
SEAT	POS
Alhambra 1.9 TDI	5
Cordoba 1.9 D	32
Cordoba 1.9 SDI	35
Cordoba 1.9 TD	33
Cordoba 1.9 TDI	34
Ibiza 1.9 D	54
Ibiza 1.9 SDI	55
Ibiza 1.9 TD	56
Ibiza 1.9 TDI	57
Inca 1.7 SDI	63
Inca 1.9 D	64
Inca 1.9 SDI	65
Toledo 1.9 D	89
Toledo 1.9 TD	90
Toledo 1.9 TDI	91
VOLKSWAGEN	POS
Caddy 1.7 SDI	21
Caddy 1.9 D	23
Caddy 1.9 SDI	25
Caddy 1.9 TDI	24
Gol 1.6 TD	81
Gol 1.9 SDI	89

50 005 807



SEAT	POS
Arosa 1.7 SDI	17
SKODA	POS
Felicia 1.9 D	13
VOLKSWAGEN	POS
Caddy 1.9 D	23
Lupo 1.7 SDI	217
Polo 1.7 SDI	287
Polo 1.9 D	290
Polo 1.9 SDI	291

50 005 808



SEAT	POS
Cordoba 1.6i	27
Cordoba 1.8i	29
Ibiza 1.6i	48
Ibiza 1.8i	50
Inca 1.6i	62
Toledo 1.6i	82

MAIN APPLICATIONS



MAIN APPLICATIONS

50 005 808



Toledo 1.8i	85
VOLKSWAGEN	POS
Caddy 1.5	17
Caddy 1.6	18
Caddy 1.6i	19
Caddy 1.8i	22
Golf I 1.5	95
Golf I 1.6	97
Golf I 1.6i	98
Golf I 1.7i	101
Golf I 1.8i	102
Golf II 1.6	106
Golf II 1.6i	107
Golf II 1.8	110
Golf II 1.8i	111
Golf III 1.6i	116
Golf III 1.8i	117
Golf III 2.0i	122
Jetta 1.5	163
Jetta 1.6	164
Jetta 1.6i	165
Jetta 1.7	171
Jetta 1.8	172
Jetta 1.8i	173
Passat 1.6	236
Passat 1.6i	237
Passat 1.8i	242
Polo 1.6i	285
Polo 1.8i	288
Polo Classic 1.8i	294
Rabbit 1.5	312
Rabbit 1.6	314
Rabbit 1.7	317
Scirocco 1.5	336
Scirocco 1.5i	337
Scirocco 1.6	338
Scirocco 1.6i	339
Scirocco 1.7i	340
Scirocco 1.8i	341
Vento 1.6i	384
Vento 1.8i	385

50 005 810



VOLKSWAGEN	POS
Corrado 1.8i G60	50
Golf II 1.8i G60	113
Passat 1.8i G60	246

50 005 813



AUDI	POS
Coupé 1.6	74
Coupé 1.8	75
Coupé 1.8i	76
80 1.3	96
80 1.6	98
80 1.6i	99
80 1.7	102
80 1.8	103
80 1.8i	104
90 1.8	118
90 1.8i	119
100 1.6i	125
100 1.8	126
100 1.8i	127

50 005 811



AUDI	POS
A4 1.8i	15
A4 1.8i 20V	16
A4 1.8i Turbo 20V	17
A6 1.8i 20V	29
Cabriolet 1.8i 20V	67

VOLKSWAGEN	POS
Passat 1.3	233
Passat 1.6	236
Passat 1.6i	237
Passat 1.8	241
Passat 1.8i	242
Santana 1.3	319
Santana 1.6	320
Santana 1.8	323

50 005 809



VOLKSWAGEN	POS
Caddy 1.6 D	20
Golf I 1.6 D	99
Golf I 1.6 TD	100
Golf II 1.6 D	108
Golf II 1.6 TD	109
Jetta 1.6 D	169
Jetta 1.6 TD	170
Rabbit 1.6 D	315
Rabbit 1.6 TD	316

50 005 812



VOLKSWAGEN	POS
Campmobil 1.6	41
Campmobil 1.9	44
Campmobil 1.9i	45
Campmobil 2.1i	46
Transporter T2 1.6	360
Transporter T2 1.9	362
Transporter T2 1.9i	363
Transporter T2 2.1i	364

50 005 814



PEUGEOT	POS
404 2.0 D	72
504 2.0 D	105
504 2.3 D	106
504 2.5 D	107
505 2.3 D	110
505 2.3 TD	111
505 2.5 D	112
604 2.3 TD	114
J 7 2.3 D	161
J9 2.3 D	162



50 005 818



Meriva 1.6i	124
Meriva 1.6i 16V	125
Tigra 1.4i 16V	158
Tigra 1.6i 16V	159
Vectra B 1.6i	163
Vectra B 1.6i 16V	164
Vectra C 1.6i 16V	172
Zafira A 1.6i 16V	182
Zafira A 1.6i 16V (Gas)	183
Zafira B 1.6i 16V	189

50 005 819



AUDI POS

A3 1.6i	5
A3 1.8i 20V	7
A3 1.8i Turbo 20V	8
A3 1.9 TDI	9
A4 1.6i	14
A4 1.8i Turbo 20V	17
A4 1.9 TDI	18
A6 1.8i	28
A6 1.8i 20V	29
A6 1.8i Turbo 20V	30
A6 1.9 TDI	31
S3 1.8i Turbo 20V	59
TT 1.8i Turbo 20V	92

FORD POS

Galaxy 1.9 TDI	53
----------------	----

SEAT POS

Alhambra 1.8i Turbo 20V	4
Alhambra 1.9 TDI	5
Alhambra 2.0i	6
Altea 1.6 SRE	9
Cordoba 1.6i	27
Cordoba 1.8i Turbo 20V	31
Cordoba 1.9 SDI	35
Cordoba 1.9 TDI	34
Cordoba 2.0i	36
Ibiza 1.6i	48
Ibiza 1.8i Cupra 20V	53
Ibiza 1.8i Turbo 20V	52
Ibiza 1.9 SDI	55
Ibiza 1.9 TDI	57
Ibiza 2.0i	58
Inca 1.9 SDI	65
Leon 1.6 SRE	69
Leon 1.6i	68
Leon 1.8i 20V	71
Leon 1.8i Cupra R 20V	73
Leon 1.8i Turbo 20V	72
Leon 1.9 SDI	75
Leon 1.9 TDI	74
Toledo 1.6 SRE	84
Toledo 1.6i	82
Toledo 1.8i 20V	87
Toledo 1.8i Turbo 20V	88
Toledo 1.9 TDI	91

SKODA POS

Fabia 1.9 SDI	9
Fabia 1.9 TDI	10

50 005 819



Fabia 2.0i	11
Octavia 1.6i	16
Octavia 1.8i 20V	18
Octavia 1.8i Turbo 16V	19
Octavia 1.8i Turbo 20V	20
Octavia 1.9 SDi	22
Octavia 1.9 TDI	21
Octavia 2.0i	23
Roomster 1.9 TDI	29
Superb 1.8i Turbo 20V	30
Superb 1.9 TDI	31
Superb 2.0i	32

VOLKSWAGEN POS

Bora 1.6i	2
Bora 1.8i 20V	5
Bora 1.8i Turbo 20V	6
Bora 1.9 SDI	7
Bora 1.9 TDI	8
Bora 2.0i	9
Caddy 1.6	18
Caddy 1.6i	19
Caddy 1.9 SDI	25
Caddy 1.9 TDI	24
Caddy 2.0i EcoFuel	27
Golf III 1.6i	116
Golf IV 1.6i	128
Golf IV 1.8i 20V	131
Golf IV 1.8i Turbo 20V	132
Golf IV 1.9 SDI	133
Golf IV 1.9 TDI	134
Golf IV 2.0i	135
Golf V 1.6 SRE	144
Golf V 1.6i	142
Golf Plus 1.6 SRE	152
Jetta 1.6 SRE	166
Jetta 1.6i	165
New Beetle 1.6i	222
New Beetle 1.8i T 20V	223
New Beetle 1.9 TDI	224
New Beetle 2.0i	225
Passat 1.6	236
Passat 1.6i	237
Passat 1.8i Turbo 20V	245
Passat 1.9 TDI	250
Passat 2.0i	251
Polo 1.6i	285
Polo 1.8i Turbo 20V	289
Polo 1.9 SDI	291
Polo 1.9 TDI	292
Polo 2.0i	293
Polo Classic 1.9 TDI	296
Sharan 1.8i Turbo 20V	343
Sharan 1.9 TDI	344
Sharan 2.0i	345
Touran 1.6i	354
Touran 2.0i EcoFuel	358
Transporter T5 2.0i	376

50 005 820



CITROEN POS

AX 1.1	2
AX 1.1i	3
AX 1.4	5
AX 1.4 D	6
AX 1.4i	7
Berlingo 1.1i	9
Berlingo 1.4i	10
BX 1.1	15
BX 1.4	16
BX 1.4i	17
C3 Pluriel 1.4i	30
C 15 1.0	38
C 15 1.1	39
C 15 1.4	40
C 15 1.4i	41
Saxo 1.0i	67
Saxo 1.1i	68
Saxo 1.4i	69
Xsara 1.4i	88
ZX 1.1	100
ZX 1.1i	101
ZX 1.4i	103

PEUGEOT POS

106 1.4 D	5
205 1.0	10
205 1.1	12
205 1.1i	13
205 1.4	15
205 1.4i	16
405 1.4	73
Partner 1.1i	164
Partner 1.4i	166

50 005 821



FORD POS

Granada 2.0i	58
Scorpio 2.0i	86
Sierra 2.3	93
Transit 1.6	103
Transit 2.0	104
Transit 2.0i	105



MAIN APPLICATIONS

50 005 822



AUDI	POS
A6 2.0i	32
Cabriolet 2.0i	69
Coupé 2.0i	78
80 1.9i	105
80 2.0i	109
100 2.0i	129
VOLKSWAGEN	POS
Gol 1.6i	79
Gol 1.8i	83
Gol 2.0i	90
Parati 1.6i	228
Parati 1.8i	229
Parati 2.0i	231
Saveiro 1.6i	328
Saveiro 1.8i	330
Saveiro 2.0i	332

50 005 823



OPEL	POS
Ascona C 1.6	17
Ascona C 1.8	20
Ascona C 1.8i	21
Ascona C 2.0i	22
Astra F 1.8i	30
Astra F 2.0i	32
Calibra 2.0i	58
Frontera A 2.0i	107
Kadett E 1.6	134
Kadett E 1.8	138
Kadett E 1.8i	139
Kadett E 2.0i	140
Omega A 1.8	163
Omega A 1.8i	164
Omega A 2.0i	165
Vectra A 1.8	217
Vectra A 1.8i	218
Vectra A 2.0i	219
VAUXHALL	POS
Astra D 1.6	5
Astra E 1.8	16
Astra E 1.8i	17
Astra E 2.0i	18
Astra F 1.8i	26
Astra F 2.0i	28
Calibra 2.0i	57

50 005 823

Carlton III 1.8	63
Carlton III 1.8i	64
Carlton III 2.0i	65
Cavalier II 1.6	77
Cavalier II 1.8	80
Cavalier II 1.8i	81
Cavalier II 2.0i	82
Cavalier III 1.8	85
Cavalier III 1.8i	86
Cavalier III 2.0i	87
Frontera A 2.0i	116

50 005 824

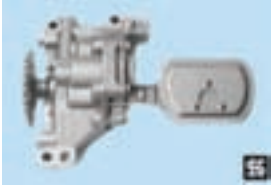

CITROEN	POS
Evasion 2.0 HDi	55
Evasion 2.0 HDi 16V	56
FIAT / IVECO	POS
Scudo 2.0 JTD	91
Scudo 2.0 JTD 140 16V	92
Ulysse 2.0 JTD	108
Ulysse 2.0 JTD 16V	109
LANCIA	POS
Phedra 2.0 JTD 16V	8
Zeta 2.0 JTD	18
PEUGEOT	POS
406 2.0 HDi	92
806 2.0 HDi	131
806 2.0 HDi 16V	132
Expert 2.0 HDi 16V	156

50 005 825



CITROEN	POS
Xantia 1.9 TD	78
Xsara 1.9 TD	95
ZX 1.9 TD	111
PEUGEOT	POS
306 1.9 TD	47
405 1.9 TD	82
406 1.9 TD	89

50 005 826



CITROEN	POS
Berlingo 1.9 D	13
C 15 1.9 D	43

50 005 826

Jumpy 1.9 D	64
Xsara 1.9 D	94
PEUGEOT	POS
306 1.9 D	46
Expert 1.9 D	153
Partner 1.9 D	170

50 005 827



MAN	POS
Series 13.192	29
Series 14.192	35
Series 14.272	41
Series 15.192	43
Series 16.192	49
Series 16.321	58
Series 19.192	82
Series 19.321	96
Series 19.331	99
Series 19.332	100
Series 19.361	103
Series 19.372	106
Series 19.422	110
Series 20.321	122
Series 22.321	134
Series 22.331	135
Series 22.332	136
Series 22.361	137
Series 22.362	138
Series 23.372	143
Series 24.331	163
Series 24.332	164
Series 24.361	168
Series 24.362	169
Series 24.372	171
Series 24.422	177
Series 25.372	183
Series 25.422	184
Series 26.322	199
Series 26.422	210
Series F 292	341
Series F 332	342
Series F 362	343
Series F 90	344
Series FR 292	378
Series FRH 292	379
Series FRH 362	381
Series H 332	384
Series H 362	385
Series HF 292	388
Series HF 332	389
Series HF 362	390
Series NG 232	392
Series NL 232	401
Series NL 233	402
Series NUE 233	410
Series R 292	415
Series RUE 240	429
Series RUE 280	430
Series SB 280	431
Series SD 200	432
Series SD 202	433
Series SD 240	434



MAIN APPLICATIONS

50 005 827



Series SG 240	435
Series SG 242	436
Series SG 280	438
Series SG 292	439
Series SL 200	441
Series SL 202	442
Series SL II 202	443
Series SR 240	445
Series SR 280	446
Series SR 292	447
Series SR 321	448
Series SR 322	449
Series SR 361	450
Series SR 362	451
Series SUE 240	452
Series SUE 242	453
Series SUE 272	454
Series UEH 270	505
Series UEL 242	506
Series UEL 272	507
Series UEL 292	508
Engine	513
MERCEDES-BENZ	POS
Axor 1835	467
Axor 1840	468
Axor 1843	469
Axor 2535	472
Axor 2540	473
Axor 2543	474
Citaro O 530	476
Citaro O 560	477
Citaro O 580	478
Conecto O 345	480
Tourismo O 350	494
Tourismo O 530	495
Travego O 580	496
O 305	501
O 307	502
O 345	517
O 403	522
O 405	524
O 407	526
O 408	527
O 415	528
O 500	529
O 550 Integro	530
Series 1825	801
Series 1836	807
Series 1842	810
Engine	992

50 005 828



MAN	POS
Series 13.192	29
Series 14.192	35
Series 14.272	41
Series 15.192	43
Series 16.192	49
Series 16.321	58
Series 19.192	82
Series 19.321	96

50 005 828



Series 19.331	99
Series 19.332	100
Series 19.361	103
Series 19.372	106
Series 19.422	110
Series 20.321	122
Series 22.321	134
Series 22.331	135
Series 22.332	136
Series 22.361	137
Series 22.362	138
Series 23.372	143
Series 24.331	163
Series 24.332	164
Series 24.361	168
Series 24.362	169
Series 24.372	171
Series 24.422	177
Series 25.372	183
Series 25.422	184
Series 26.322	199
Series 26.422	210
Series F 292	341
Series F 332	342
Series F 362	343
Series F 90	344
Series FR 292	378
Series FRH 292	379
Series FRH 362	381
Series H 332	384
Series H 362	385
Series HF 292	388
Series HF 332	389
Series HF 362	390
Series NG 232	392
Series NL 232	401
Series NL 233	402
Series NUE 233	410
Series R 292	415
Series RUE 240	429
Series RUE 280	430
Series SB 280	431
Series SD 200	432
Series SD 202	433
Series SD 240	434
Series SG 240	435
Series SG 242	436
Series SG 280	438
Series SG 292	439
Series SL 200	441
Series SL 202	442
Series SL II 202	443
Series SR 240	445
Series SR 280	446
Series SR 292	447
Series SR 321	448
Series SR 322	449
Series SR 361	450
Series SR 362	451
Series SUE 240	452
Series SUE 242	453
Series SUE 272	454
Series UEH 270	505
Series UEL 242	506
Series UEL 272	507
Series UEL 292	508
Engine	513
MERCEDES-BENZ	POS
Axor 1835	467
Axor 1840	468

50 005 828



Axor 1843	469
Axor 2535	472
Axor 2540	473
Axor 2543	474
Citaro O 530	476
Citaro O 560	477
Citaro O 580	478
Conecto O 345	480
Tourismo O 350	494
Tourismo O 530	495
Travego O 580	496
O 305	501
O 307	502
O 345	517
O 403	522
O 405	524
O 407	526
O 408	527
O 415	528
O 500	529
O 550 Integro	530
Series 1825	801
Series 1836	807
Series 1842	810
Engine	992











50 005 829



MERCEDES-BENZ	POS
O 302	498
Series 1418	732
Series 1519	748
Series 1520	749
Series 1521	750
Series 1620	758
Series 1621	759
Series 1624	761
Series 1819	797
Series 1820	798
Series 1921	817
Series 1923	819
Series 1924	820
Series 1929	825
Series 1930	826
Series 1932	827
Series 1933	828
Series 1934	829
Series 2024	838
Series 2219	852
Series 2220	853
Series 2223	855
Series 2224	856
Series 2624	906
Engine	992











MAIN APPLICATIONS

50 005 830 		50 005 831 		50 005 832 	
		Actros 2546	358	P 113	22
HANOMAG POS		Actros 2548	359	R 113	23
Series F 150	7	Actros 2631	365	T 113	24
MERCEDES-BENZ POS		Actros 2632	366	B 110	32
O 302	498	Actros 2635	367	CR 110	34
O 305	501	Actros 2636	368	L 110	35
Series 1113	698	Actros 2640	369	LB 110	36
Series 1216	709	Actros 2641	370	LBS 110	37
Series 1313	722	Actros 2643	371	LBT 110	38
Series 1317	725	Actros 2644	372	LS 110	39
Series 1413	729	Actros 2646	373	LT 110	40
Series 1417	731	Actros 2648	374	Engine	41
Series 1517	746	Actros 3231	380	50 005 833 	
Series 1519	748	Actros 3232	381		
Series 1617	755	Actros 3235	382	MAN POS	
Series 1621	759	Actros 3236	383	Series 11.168	13
Series 1817	796	Actros 3240	384	Series 12.168	20
Series 1819	797	Actros 3241	385	Series 13.168	28
Engine	992	Actros 3243	386	Series 13.192	29
50 005 831 		Actros 3244	387	Series 14.168	34
		Actros 3248	388	Series 15.192	43
MERCEDES-BENZ POS		Actros 3311	389	Series 15.200	44
Actros 1831	320	Actros 3331	391	Series 15.240	47
Actros 1832	321	Actros 3332	392	Series 16.168	48
Actros 1835	322	Actros 3335	393	Series 16.200	50
Actros 1836	323	Actros 3340	394	Series 16.240	53
Actros 1840	325	Actros 3341	395	Series 16.242	54
Actros 1841	326	Actros 3343	396	Series 16.256	55
Actros 1843	327	Actros 3344	396	Series 16.280	56
Actros 1844	328	Actros 3346	397	Series 16.320	57
Actros 1846	329	Actros 3348	398	Series 16.321	58
Actros 1848	330	Actros 4140	404	Series 17.240	64
Actros 2031	336	Actros 4141	405	Series 17.241	65
Actros 2032	337	Actros 4143	406	Series 18.241	71
Actros 2035	338	Actros 4144	407	Series 19.168	81
Actros 2036	339	Actros 4146	408	Series 19.200	83
Actros 2040	340	Actros 4148	409	Series 19.240	84
Actros 2041	341	Engine	992	Series 19.242	85
Actros 2043	342	50 005 832 		Series 19.256	86
Actros 2044	343			Series 19.262	87
Actros 2046	344	SCANIA POS		Series 19.280	89
Actros 2048	345	L 111	6	Series 19.281	90
Actros 2048	345	LB 111	5	Series 19.291	91
Actros 2531	349	LBS 111	3	Series 19.320	95
Actros 2532	350	LBT 111	1	Series 19.321	96
Actros 2535	351	LS 111	4	Series 19.330	98
Actros 2536	352	LT 111	2	Series 19.331	99
Actros 2540	354	BR 112	7	Series 19.360	102
Actros 2541	355	CR 112	8	Series 19.361	103
Actros 2543	356	F 112	9	Series 19.362	104
Actros 2544	357	G 112	10	Series 20.192	117
		K 112	11	Series 20.280	118
		P 112	12	Series 20.281	119
		R 112	13	Series 20.291	120
		S 112	14	Series 20.320	121
		T 112	15	Series 20.321	122
		BN 113	16	Series 20.331	123
		CN 113	17	Series 20.361	124
		F 113	18	Series 22.192	125
		K 113	19	Series 22.200	126
		L 113	20	Series 22.240	128
		N 113	21	Series 22.280	129

MAIN APPLICATIONS







MAIN APPLICATIONS

50 005 834 		50 005 835 		50 005 836 	
Series 4445	977	Series 1513	744	Series 1318	726
Series 4635	978	Series 1517	746	Series 1320	727
Series 4645	979	Series 1617	755	Series 1324	728
Series 4648	980	Series 1713	776	Series 1417	731
Series 4836	981	Series 1813	793	Series 1418	732
Series 4838	982	Engine	992	Series 1419	733
Series 4844	983	TOYOTA	POS	Series 1420	734
Series 4850	984	Bandeirante 3.8 D	21	Series 1424	736
Series 4853	985	50 005 836 		Series 1426	738
Series 4936	986			Series 1427	739
Series 5035	987			Series 1431	742
Series 5038	988			Series 1513	744
Series 5248	989			Series 1517	746
Series 5436	990			Series 1518	747
Series 6036	991			Series 1520	749
Engine	992			Series 1524	751
50 005 835 		MERCEDES-BENZ	POS	Series 1613	753
		O 301	497	Series 1617	755
		O 402	521	Series 1619	757
FORD	POS	MB-Trac 1300 turbo	547	Series 1620	758
Tractor 8070	128	MB-Trac 1400 turbo	548	Series 1717	777
HANOMAG	POS	MB-Trac 1500 turbo	549	Series 1720	780
Series F 45	2	MB-Trac 1600 turbo	550	Series 1722	781
Series F 46	3	U 1200	591	Series 1724	782
Series F 55	4	U 1250	592	Series 1813	793
MERCEDES-BENZ	POS	U 1300	593	Series 1816	795
O 302	498	U 1350	594	Series 1817	796
O 309 D 3.8	508	U 1400	595	Series 1820	798
O 321	513	U 1450	596	Series 1821	799
O 322	514	U 150	573	Series 1824	800
MB-Trac 1300 turbo	547	U 1500	597	Series 1827	802
Series 311	633	U 1550	598	Series 1920	816
Series 312	634	U 1600	599	Series 1921	817
Series 321	638	U 1650	600	Series 1924	820
Series 322	639	U 1700	601	Series 2020	837
Series 323	640	U 1750	602	Series 2024	838
Series 327	641	U 1800	603	Series 2219	852
Series 328	642	U 1850	604	Series 2220	853
Series 329	643	U 2100	605	Series 2222	854
Series 408 D 3.8	659	U 2150	606	Series 2320	867
Series 508 3.8	666	U 2400	607	Series 2420	870
Series 508 D 3.8	668	U 2450	608	Series 2517	886
Series 608	669	U 425	580	Series 2521	887
Series 709	676	U 435	582	Series 2524	889
Series 710	677	Series 817	688	Engine	992
Series 808	681	Series 911	689	50 005 837 	
Series 809	682	Series 917	693		
Series 810	683	Series 1017	696	HANOMAG	POS
Series 911	689	Series 1113	698	Series F 130	6
Series 1013	694	Series 1116	701	Series F 193	8
Series 1113	698	Series 1117	702	Series F 263	9
Series 1213	706	Series 1120	703	MERCEDES-BENZ	POS
Series 1313	722	Series 1121	704	Freightliner (USA)	484
Series 1317	725	Series 1124	705	Tourismo O 350	494
Series 1413	729	Series 1217	710	O 302	498
Series 1417	731	Series 1222	713	O 303	499
		Series 1224	714	O 304	500
		Series 1231	719	O 330	515
		Series 1313	722	O 340	516
		Series 1314	723	O 371	518
		Series 1316	724	O 374	519
		Series 1317	725		

MAIN APPLICATIONS

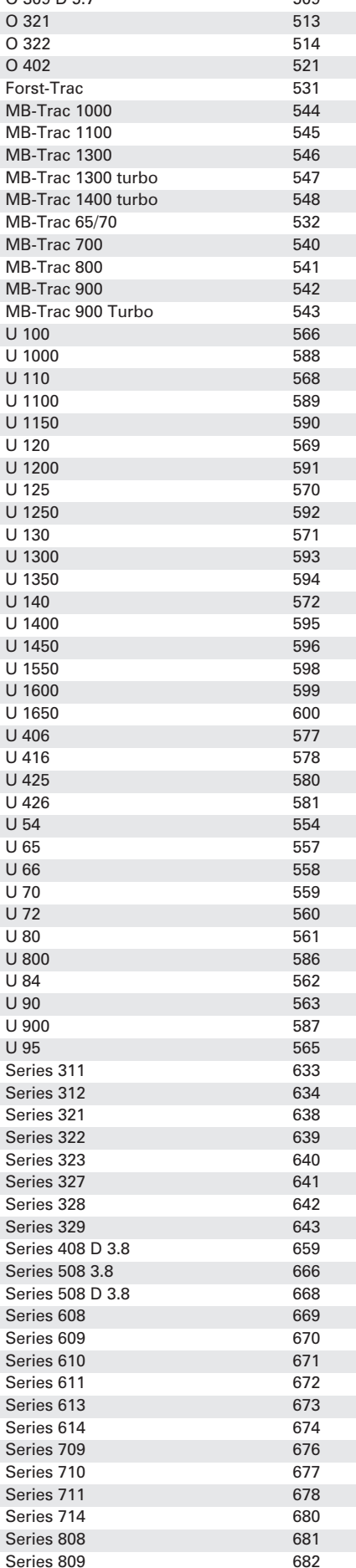

MAIN APPLICATIONS

50 005 840 		50 005 841 		50 005 843 	
					
FIAT / IVECO	POS	VOLVO	POS		
Series 175	203	F 12	127	O 309 D 5.7	509
Series 345	215	FL 10	134	O 321	513
Series 840	225	N 12	138	O 322	514
Series 920	227	NL 10	139	O 402	521
IHC-CASE (CNH)	POS	NL 12	140	Forst-Trac	531
Series 475	9			MB-Trac 1000	544
MASSEY-FERGUSON	POS			MB-Trac 1100	545
11	1			MB-Trac 1300	546
22	2			MB-Trac 1300 turbo	547
33	4			MB-Trac 1400 turbo	548
50	7			MB-Trac 65/70	532
60	9			MB-Trac 700	540
70	11			MB-Trac 800	541
85	12			MB-Trac 900	542
165	19			MB-Trac 900 Turbo	543
178	21			U 100	566
185	23			U 1000	588
186	24			U 110	568
188	27			U 1100	589
194	28			U 1150	590
220	29			U 120	569
230	30			U 1200	591
250	31			U 125	570
275	34			U 1250	592
285	35			U 130	571
290	36			U 1300	593
293	37			U 1350	594
294	38			U 140	572
300	39			U 1400	595
307	40			U 1450	596
310	41			U 1550	598
330	42			U 1600	599
350	43			U 1650	600
382	44			U 406	577
390	45			U 416	578
393	46			U 425	580
394	47			U 426	581
397	48			U 54	554
440	50			U 65	557
487	52			U 66	558
506	55			U 70	559
587	61			U 72	560
590	62			U 80	561
690	63			U 800	586
1080	64			U 84	562
3060	70			U 90	563
7000	75			U 900	587
8000	76			U 95	565
PERKINS	POS			Series 311	633
Engine	1			Series 312	634
				Series 321	638
				Series 322	639
				Series 323	640
				Series 327	641
				Series 328	642
				Series 329	643
				Series 408 D 3.8	659
				Series 508 3.8	666
				Series 508 D 3.8	668
				Series 608	669
				Series 609	670
				Series 610	671
				Series 611	672
				Series 613	673
				Series 614	674
				Series 709	676
				Series 710	677
				Series 711	678
				Series 714	680
				Series 808	681
				Series 809	682

MAIN APPLICATIONS



50 005 843



Series 810	683
Series 811	684
Series 813	686
Series 814	687
Series 911	689
Series 913	691
Series 914	692
Series 1013	694
Series 1014	695
Series 1017	696
Series 1113	698
Series 1114	699
Series 1213	706
Series 1214	707
Series 1217	710
Series 1313	722
Series 1314	723
Series 1317	725
Series 1413	729
Series 1414	730
Series 1417	731
Series 1513	744
Series 1514	745
Series 1517	746
Series 1613	753
Series 1614	754
Series 1617	755
Series 1713	776
Series 1813	793
Series 1814	794
Engine	992
TOYOTA	POS
Bandeirante 3.8 D	21

50 005 844



AUDI	POS
A2 1.4i 16V	2
SEAT	POS
Altea 1.4 SRE 16V	8
Arosa 1.0i	13
Arosa 1.4i	14
Arosa 1.4i 16V	15
Cordoba 1.0i 16V	20
Cordoba 1.4 SRE 16V	25
Cordoba 1.4i	23
Cordoba 1.4i 16V	24
Cordoba 1.6i	27
Ibiza 1.0i 16V	40
Ibiza 1.4 SRE 16V	46
Ibiza 1.4i	44
Ibiza 1.4i 16V	45
Ibiza 1.6i	48
Inca 1.4i	60
Inca 1.4i 16V	61
Inca 1.6i	62
Leon 1.4 SRE 16V	67
Leon 1.4i 16V	66

50 005 844



Leon 1.6i 16V	70
Toledo 1.4 SRE 16V	81
Toledo 1.4i 16V	80
Toledo 1.6i 16V	83
SKODA	POS
Fabia 1.4 FSI 16V	6
Fabia 1.4i 16V	5
Felicia 1.6i	12
Octavia 1.4 FSI 16V	15
Octavia 1.4i 16V	14
Octavia 1.6i	16
Roomster 1.4i 16V	26
VOLKSWAGEN	POS
Bora 1.4i 16V	1
Bora 1.6i 16V	3
Caddy 1.4 FSI 16V	16
Caddy 1.4i	14
Caddy 1.4i 16V	15
Caddy 1.6i	19
Golf III 1.4i	115
Golf III 1.6i	116
Golf IV 1.4i 16V	127
Golf IV 1.6i 16V	129
Golf V 1.4 FSI 16V	141
Golf V 1.4i 16V	140
Golf Plus 1.4 FSI 16V	150
Golf Plus 1.4i 16V	151
Lupo 1.0i	210
Lupo 1.4 FSI 16V	214
Lupo 1.4i 16V	213
Lupo 1.6i 16V	216
Polo 1.0i	270
Polo 1.4 FSI 16V	282
Polo 1.4i	280
Polo 1.4i 16V	281
Polo 1.6i	285
Polo 1.6i 16V	286
Vento 1.4i	383
Vento 1.6i	384

50 005 845



AUDI	POS
A6 2.0i 16V	33
Cabriolet 2.0i 16V	70
Coupé 2.0i	78
Coupé 2.0i 16V	79
80 2.0i 16V	110
100 2.0i 16V	130
VOLKSWAGEN	POS
Gol 2.0i 16V	91
Parati 2.0i 16V	232
Saveiro 2.0i 16V	333

50 005 846



RENAULT	POS
Clio II 1.4i 16V	15
Clio II 1.5 dCi	16
Clio II 1.6i 16V	18
Kangoo 1.5 dCi	56
Kangoo 1.6i 16V	58
Laguna I 1.6i 16V	62
Laguna II 1.6i 16V	72
Mégane 1.4i 16V	106
Mégane 1.6i 16V	108
Scénic 1.4i 16V	223
Scénic 1.6i 16V	225
Symbol 1.4i 16V	241
Thalia II 1.4i 16V	245
Thalia II 1.5 dCi	246

50 005 847



RENAULT	POS
Clio I 1.2	4
Clio I 1.2i	5
Clio I 1.4	6
Clio I 1.4i	7
Express 1.4i	46
R 19 1.2i	180
R 19 1.4i	182
Rapid 1.4i	214

50 005 848



OPEL	POS
Astra F 2.0i 16V	33
Astra G 2.0i 16V	41
Calibra 2.0i 16V	59
Omega B 2.0i 16V	173



MAIN APPLICATIONS

50 005 848	
Vectra B 1.8i 16V	225
Vectra B 2.0i 16V	227
Vectra B 2.2i 16V	230
Zafira A 2.0i 16V	245
VAUXHALL	POS
Astra F 2.0i 16V	29
Astra G 2.0i 16V	37
Calibra 2.0i 16V	58
Omega B 2.0i 16V	142
Vectra B 1.8i 16V	165
Vectra B 2.0i 16V	167
Vectra B 2.2i 16V	170
Zafira A 2.0i 16V	185

50 005 849	
DACIA	POS
Logan 1.5 dCi	1
Logan 1.6i 16V	2
Logan MCV 1.6i 16V	3
RENAULT	POS
Clio II 1.4i 16V	15
Clio II 1.5 dCi	16
Clio II 1.6i	17
Clio II 1.6i 16V	18
Clio III 1.4i 16V	23
Clio III 1.6i 16V	25
Kangoo 1.5 dCi	56
Kangoo 1.6i 16V	58
Laguna II 1.6i 16V	72
Mégane 1.4i 16V	106
Mégane 1.6i 16V	108
Mégane II 1.4i 16V	134
Mégane II 1.5 dCi	135
Mégane II 1.6i 16V	136
Modus 1.4i 16V	142
Modus 1.5 dCi	143
Modus 1.6i 16V	144
Scénic 1.4i 16V	223
Scénic 1.6i 16V	225
Scénic II 1.4i 16V	233
Scénic II 1.5 dCi	234
Scénic II 1.6i 16V	235
Symbol 1.4i 16V	241
Symbol 1.5 dCi	242
Symbol 1.6i	243
Thalia II 1.4i 16V	245
Thalia II 1.5 dCi	246
Thalia II 1.6i	247

50 005 850	
OPEL	POS
Astra F 1.6i	26
Astra F 1.8i	30
Astra F 1.8i 16V	31
Astra F 2.0i	32
Astra F 2.0i 16V	33
Calibra 2.0i	58
Calibra 2.0i 16V	59
Frontera A 2.0i	107
Frontera A 2.2i 16V	109
Kadett E 1.8	138
Kadett E 1.8i	139
Kadett E 2.0i	140
Omega A 1.8	163
Omega A 1.8i	164
Omega A 2.0i	165
Omega B 2.0i	172
Omega B 2.0i 16V	173
Vectra A 1.6i	214
Vectra A 1.8	217
Vectra A 1.8i	218
Vectra A 2.0i	219
Vectra A 2.0i 16V	220
Vectra B 1.6i	223
VAUXHALL	POS
Astra E 1.8	16
Astra E 1.8i	17
Astra E 2.0i	18
Astra F 1.6i	23
Astra F 1.8i	26
Astra F 1.8i 16V	27
Astra F 2.0i	28
Astra F 2.0i 16V	29
Calibra 2.0i	57
Calibra 2.0i 16V	58
Carlton III 1.8	63
Carlton III 1.8i	64
Carlton III 2.0i	65
Cavalier III 1.6i	84
Cavalier III 1.8	85
Cavalier III 1.8i	86
Cavalier III 2.0i	87
Cavalier III 2.0i 16V	88
Frontera A 2.0i	116
Frontera A 2.2i 16V	118
Omega B 2.0i	141
Omega B 2.0i 16V	142
Vectra B 1.6i	163

50 005 851	
OPEL	POS
Astra F 1.8i 16V	31
Astra F 2.0i 16V	33
Calibra 2.0i 16V	59
Omega B 2.0i 16V	173
Vectra B 1.8i 16V	225
Vectra B 2.0i	226
Vectra B 2.0i 16V	227
VAUXHALL	POS
Astra F 1.8i 16V	27
Astra F 2.0i 16V	29
Calibra 2.0i 16V	58
Omega B 2.0i 16V	142
Vectra B 1.8i 16V	165
Vectra B 2.0i	166
Vectra B 2.0i 16V	167

50 005 852	
PEUGEOT	POS
404 1.6	71
504 1.6	101

50 005 853	
CITROEN	POS
AX 1.4	5
AX 1.4i	7
AX 1.5 D	8
BX 1.4	16
BX 1.4i	17
C 15 1.4	40
C 15 1.4i	41
Saxo 1.5 D	70
Saxo 1.6i	71
Xsara 1.5 D	89
Xsara 1.6i	90
Xsara Picasso 1.6i	98
ZX 1.4	102
ZX 1.5 D	104
ZX 1.6i	105

MAIN APPLICATIONS



MAIN APPLICATIONS

50 005 853



PEUGEOT	POS
106 1.4	4
106 1.5 D	7
106 1.6i	8
205 1.4	15
205 1.4i	16
206 1.6i	27
306 1.6i	42
309 1.4	62
309 1.4i	63
405 1.4i	74

50 005 854



CITROEN	POS
Berlingo 1.8i	11
Evasion 1.8i	52
Evasion 2.0i 16V	54
Xantia 1.6i	74
Xantia 1.8i	75
Xantia 1.8i 16V	76
Xantia 2.0i	79
Xantia 2.0i 16V	80
XM 2.0i	84
Xsara 1.8i	91
Xsara 1.8i 16V	92
Xsara 2.0i 16V	96
ZX 1.6i	105
ZX 1.8i	106
ZX 1.8i 16V	107
ZX 2.0i	112
ZX 2.0i 16V	113
FIAT / IVECO	POS
Ulysse 1.8i	106
Ulysse 2.0i	110
Ulysse 2.0i 16V	111
LANCIA	POS
Zeta 2.0i 16V	20
PEUGEOT	POS
306 1.8i	43
306 1.8i 16V	44
306 2.0i	48
306 2.0i 16V	49
405 1.6i	76
405 1.8i	77
405 2.0i	83
405 2.0i 16 V	84
406 1.6i	86
406 1.8i	87
406 1.8i 16V	88
406 2.0i 16V	90
605 2.0i 16V	118
806 1.8i	127
806 2.0i	129
806 2.0i 16V	130
Expert 1.8i	152
Partner 1.8i	168

50 005 855



RENAULT	POS
R 4 0.85	145

50 005 856



RENAULT	POS
Clio I 1.1	3
Clio I 1.2i	5
Express 1.0	42
Express 1.1	43
Express 1.2i	44
Express 1.4	45
Express 1.4i	46
R 5 1.0	148
R 5 1.1	149
R 5 1.4	152
R 5 1.4 Turbo	153
R 5 1.4i	155
R 19 1.2	179
R 19 1.4	181
R 21 1.4	192
Rapid 1.1	210
Rapid 1.2	211
Rapid 1.2i	212
Rapid 1.4	213
Rapid 1.4i	214
Twingo 1.2i	258

50 005 857



RENAULT	POS
Espace I 2.0	26
Espace I 2.0i	27
Espace I 2.1 TD	28
Espace I 2.2i	29
Espace II 2.0i	30
Espace II 2.1 TD	31
Espace II 2.2i	32
R 21 2.0	196
R 21 2.0i	197
R 21 2.0i 12V	198
R 21 2.0i Turbo	199
R 21 2.1 D	200
R 21 2.1 TD	201
R 21 2.2i	202
R 25 2.0	203
R 25 2.0i	204
R 25 2.0i 12V	205
R 25 2.1 D	206
R 25 2.1 TD	207
R 25 2.2i	208
Trafic 2.0	252
Trafic 2.1 D	254
Trafic 2.2i	255

50 005 858



RENAULT	POS
Avantime 1.9 dTi	1
Clio I 1.9 D	11
Clio II 1.9 D	19
Clio II 1.9 DTi	20
Clio II 2.0i 16V	21
Espace III 1.9 dTi	33
Espace III 2.0i	34
Espace IV 2.0i 16V	39
Espace IV 2.0i Turbo 16V	40
Kangoo 1.9 D	59
Kangoo 1.9 dTi	60
Laguna I 1.9 dCi	65
Laguna I 1.9 dTi	66
Laguna II 1.9 dCi	74
Laguna II 2.0i 16V	75
Laguna II 2.0i Turbo 16V	76
Master 1.9 dTi	103
Mégane 1.9 D	110
Mégane 1.9 TD	113
Mégane 1.9 dCi	111



MAIN APPLICATIONS

50 005 858	
Mégane 1.9 dTi	112
Mégane 2.0i	114
Mégane 2.0i 16V	115
Mégane II 2.0i 16V	138
Mégane II 2.0i 16V Sport	140
Rapid 1.9 D	216
Scénic 1.9 D	227
Scénic 1.9 TD	228
Scénic 1.9 dCi	230
Scénic 1.9 dTi	229
Scénic II 2.0i 16V	237
Spider 2.0i 16V	239
Trafic 1.9 D	249
Trafic 1.9 dCi 100	251
Vel Satis 2.0i Turbo 16V	259

50 005 859



RENAULT		POS
Clio I 1.4i	7	
Clio II 1.4i	14	
Clio II 1.6i	17	
Express 1.4i	46	
Kangoo 1.4i	55	
Kangoo 1.6i	57	
Mégane 1.4i	105	
Mégane 1.6i	107	
Rapid 1.4i	214	
Scénic 1.4i	222	
Scénic 1.6i	224	
Symbol 1.4i	240	
Thalia II 1.4i	244	

50 005 860



CITROEN		POS
Jumper 2.5 D 12V	61	
Jumper 2.5 DI TD	63	
Jumper 2.5 TD 12V	62	

PEUGEOT		POS
Boxer 2.5 D	147	
Boxer 2.5 DI TD	149	
Boxer 2.5 TD	148	

50 005 861



RENAULT		POS
Avantime 2.0i Turbo 16V	2	
Espace III 2.0i 16V	35	
Espace IV 2.0i 16V	39	
Espace IV 2.0i Turbo 16V	40	
Laguna I 1.8i 16V	64	
Laguna I 2.0i 16V	68	
Laguna II 1.8i 16V	73	
Laguna II 2.0i 16V	75	
Laguna II 2.0i Turbo 16V	76	
Mégane 1.8i 16V	109	
Mégane 2.0i 16V	115	
Scénic 1.8i 16V	226	
Scénic 2.0i 16V	232	
Trafic 2.0i 16V	253	
Vel Satis 2.0i Turbo 16V	259	

50 005 862



RENAULT		POS
Avantime 2.0i Turbo 16V	2	
Espace III 2.0i 16V	35	
Espace IV 2.0i 16V	39	
Espace IV 2.0i Turbo 16V	40	
Laguna I 1.8i 16V	64	
Laguna I 2.0i 16V	68	
Laguna II 1.8i 16V	73	
Laguna II 2.0i 16V	75	
Laguna II 2.0i Turbo 16V	76	
Mégane 1.8i 16V	109	
Mégane 2.0i 16V	115	
Scénic 1.8i 16V	226	
Scénic 2.0i 16V	232	
Trafic 2.0i 16V	253	
Vel Satis 2.0i Turbo 16V	259	

50 005 863



CITROEN		POS
C 25 2.0	44	

50 005 863

PEUGEOT		POS
504 1.8	102	
504 2.0	103	
504 2.0i	104	
505 2.0	108	
505 2.0i	109	

50 005 864



RENAULT		POS
R 4 1.0	146	
R 4 1.1	147	

50 005 865



RENAULT		POS
Clio I 1.7	8	
Clio I 1.8i	9	
Clio I 1.8i 16V	10	
Clio I 1.9 D	11	
Espace III 2.0i	34	
Express 1.6 D	47	
Express 1.9 D	48	
Laguna I 1.8i	63	
Laguna I 2.0i	67	
Mégane 1.9 D	110	
Mégane 1.9 TD	113	
Mégane 1.9 dTi	112	
R 5 1.6 D	158	
R 5 1.7	159	
R 5 1.7i	160	
R 19 1.7	183	
R 19 1.7i	184	
R 19 1.8i	185	
R 19 1.8i 16V	186	
R 19 1.9 D	187	
R 19 1.9 TD	188	
R 21 1.7	193	
R 21 1.7i	194	
Rapid 1.6 D	215	
Rapid 1.9 D	216	
Scénic 1.9 TD	228	
Trafic 1.7	248	

MAIN APPLICATIONS



MAIN APPLICATIONS

50 005 866



AUDI	POS
A6 1.9 TDI	31
80 1.6 TD	101
80 1.9 D	106
80 1.9 TD	107
80 1.9 TDI	108

50 005 867



AUDI	POS
A4 1.9 TDI	18
A6 1.9 TDI	31
Cabriolet 1.9 TDI	68

VOLKSWAGEN	POS
Passat 1.9 TDI	250

50 005 868



SEAT	POS
Cordoba 1.3	22
Cordoba 1.4i	23
Ibiza 1.05i	41
Ibiza 1.3	43
Ibiza 1.4i	44

VOLKSWAGEN	POS
Golf II 1.05	103
Golf II 1.3	104
Golf II 1.3i	105

50 005 868

Golf III 1.4i	115
Jetta 1.05	158
Jetta 1.3	160
Jetta 1.3i	161
Polo 1.05	271
Polo 1.05i	272
Polo 1.3	276
Polo 1.3 D	279
Polo 1.3i	277
Polo 1.3i G40	278
Polo 1.4 D	283
Vento 1.4i	383

50 005 870



MAN	POS
Lion 's Regio	3
Series 16.370	59
Series 18.260	72
Series 18.310	75
Series 18.350	76
Series 18.360	77
Series 18.400	78
Series 18.410	79
Series 18.460	80
Series 19.273	88
Series 19.293	93
Series 19.314	94
Series 19.320	95
Series 19.323	97
Series 19.343	101
Series 19.364	105
Series 19.373	107
Series 19.403	108
Series 19.414	109
Series 19.423	111
Series 19.463	112
Series 19.464	113
Series 23.293	139
Series 23.314	140
Series 23.343	141
Series 23.364	142
Series 23.403	144
Series 23.414	145
Series 23.463	146
Series 23.464	147
Series 24.273	156
Series 24.293	159
Series 24.310	160
Series 24.314	161
Series 24.323	162
Series 24.343	165
Series 24.350	166
Series 24.360	167
Series 24.364	170
Series 24.373	172
Series 24.400	173
Series 24.403	174
Series 24.410	175
Series 24.414	176
Series 24.423	178
Series 24.460	179
Series 24.463	180

50 005 870

Series 24.464	181
Series 26.273	190
Series 26.293	195
Series 26.314	196
Series 26.323	200
Series 26.343	203
Series 26.364	206
Series 26.373	207
Series 26.403	208
Series 26.414	209
Series 26.423	211
Series 26.463	212
Series 26.464	213
Series 27.273	216
Series 27.293	217
Series 27.314	218
Series 27.323	219
Series 27.343	220
Series 27.364	221
Series 27.373	222
Series 27.403	223
Series 27.414	224
Series 27.423	225
Series 27.463	226
Series 27.464	227
Series 28.293	231
Series 28.314	232
Series 28.343	233
Series 28.364	234
Series 28.403	235
Series 28.414	236
Series 28.463	237
Series 28.464	238
Series 29.414	239
Series 29.464	240
Series 30.293	247
Series 30.314	248
Series 30.343	252
Series 30.364	254
Series 30.403	255
Series 30.414	256
Series 30.463	257
Series 30.464	258
Series 32.293	266
Series 32.314	267
Series 32.343	272
Series 32.364	275
Series 32.403	276
Series 32.414	277
Series 32.463	278
Series 32.464	279
Series 33.293	283
Series 33.323	285
Series 33.343	288
Series 33.364	290
Series 33.373	291
Series 33.403	292
Series 33.414	293
Series 33.423	294
Series 33.463	295
Series 33.464	296
Series 35.343	302
Series 35.364	303
Series 35.403	304
Series 35.414	305
Series 35.463	306
Series 35.464	307
Series 40.403	311
Series 40.414	312
Series 40.463	313
Series 40.464	314



MAIN APPLICATIONS

50 005 874



Series DX 250	29
Series M 192	66
Series M 230	67
Series M 256	70

FORD POS

Cargo 1317	114
Cargo 1517	115
Cargo 1617	116
Cargo 2817	117

TAM POS

150	2
-----	---

50 005 900



OPEL POS

Astra G 1.6i	35
Combo 1.6i	66
Corsa C 1.6i	98
Meriva 1.6i	154

VAUXHALL POS

Astra G 1.6i	31
Combo 1.6i	95
Corsa C 1.6i	110
Meriva 1.6i	124

50 005 901



ROVER POS

Defender 110 2.5 TDi	2
Defender 130 2.5 Tdi	4
Defender 90 2.5 TDi	1
Discovery 2.5 TDi	6
Landrover 90 2.5 TDi	7

50 005 902



HONDA POS

Accord 2.0 i 16V	8
Acura Integra R 2.0 i 16V	12

50 005 902



CRV 2.0 i 16V	14
Integra R 2.0 i 16V	31
Stepwgn 2.0 i 16V	39
Stream 2.0 i 16V	41

50 005 903



HYUNDAI POS

Avante 2.0i 16V	37
Coupé 1.6i 16V	6
Coupé 2.0i 16V	7
Elantra 1.6i 16V	49
Elantra 2.0i 16V	56
Lantra 1.6i 16V	50
Lantra 2.0i 16V	57
Tiburon 1.6i 16V	28
Tiburon 2.0i 16V	29
Tucson 2.0i 16V	34
Tuscani 2.0i 16V	30

KIA POS

Cerato 2.0i 16V	10
Sportage 2.0i 16V	9

50 005 904



TOYOTA POS

Celica 1.8i 16V	50
Corolla 1.8i 16V	68
Matrix 1.8i 16V	131

50 005 905



AUDI POS

A6 2.7i Turbo 30V	41
A6 Allroad 2.7i Turbo 30V	48
RS4 2.7i 30V	57
S4 2.7i 30V	61

50 005 908



MERCEDES-BENZ POS

C 180 (202)	7
C 200 Kompressor (202)	10
C 200 Kompressor (203)	11
C 230 Kompressor (203)	21
CLK 200 Kompressor (208)	35
CLK 200 Kompressor (209)	36
CLK 230 Kompressor (208)	37
E 200 Kompressor (210)	49
SLK 200 Kompressor (170)	124
SLK 230 Kompressor (170)	125

50 005 909



MERCEDES-BENZ POS

C 200 CDI (203)	14
C 220 CDI (203)	18
CLC 200 CDI (203)	32
CLC 220 CDI (203)	33
E 200 CDI (211)	53
E 220 CDI (211)	57
E 270 CDI (211)	68



MAIN APPLICATIONS

50 005 932



MERCEDES-BENZ POS

200 (115)	199
200 (123)	200
200 D (115)	203
200 D (123)	204
220 (115)	207
220 D (115)	209
220 D (123)	210
230 (123)	215
230 G (460)	219
230.4 (115)	224
230.6 (114)	225
240 D (115)	226
240 D (123)	227
240 D (USA) (115)	228
240 D 3.0 (115)	229
240 GD (460)	230
240 GD (461)	231
250 (114)	232
280 E (116)	250
280 GE (460)	253
280 GE (461)	254
280 S (108)	255
280 S (116)	256
280 SE (108)	258
280 SE (111)	259
280 SE (116)	260
280 SL (107)	264
300 D (115)	270
300 D (123)	271
300 D Turbo (123)	268
300 GD (460)	277
300 GD (461)	278
300 SD Turbo (USA) (126)	282
300 SE 2.8 (109)	285
350 SE 2.8 (116)	298
350 SL 2.8 (107)	300
450 SE 2.8 (116)	309
450 SL 2.8 (107)	311
MB 100 2.0 D	486
MB 90 2.0 D	485
O 309 2.3	505
O 309 D 2.2	506
O 309 D 2.4	507
MB-Trac 100	534
MB-Trac 90	533
U 404	576
U 421	579
U 600	584
Series 206 D 2.0	613
Series 206 D 2.2	614
Series 207 D 2.0	615
Series 207 D 2.4	616
Series 208 2.3	617
Series 210 2.3	620
Series 306 D 2.0	622
Series 306 D 2.2	623
Series 307 D 2.0	624
Series 307 D 2.4	626
Series 308 2.3	627

50 005 932

Series 308 D 2.4	629
Series 310 2.3	631
Series 406 D 2.2	647
Series 406 D 2.4	648
Series 407 D 2.2	652
Series 407 D 2.4	653
Series 408 2.3	657
Series 409 2.3	661
Series 410 2.3	663
Series 507 D 2.4	665
Engine	992

SEAT POS

132 2.0 D	2
2000 D	3

50 005 934



NISSAN POS

Kubistar 1.1i	20
---------------	----

RENAULT POS

Clio I 1.2i	5
Clio II 1.2i	13
Clio II 1.6i	17
Clio II 1.6i 16V	18
Clio III 1.2i 16V	22
Kangoo 1.2i	54
Kangoo 1.6i 16V	58
Mégane 1.6i 16V	108
Mégane Classic 1.6i 16V	119
Mégane Grandtour 1.6i 16V	128
Modus 1.2i 16V	141
Scénic 1.6i 16V	225
Twingo 1.2i	258

50005130-1



AUDI POS

A3 1.6i	5
A4 1.6i	14
A4 1.8i Turbo 20V	17
A4 2.0i 20V	19
A6 1.8i Turbo 20V	30
A6 2.0i 20V	34

SEAT POS

Cordoba 1.6i	27
Ibiza 1.6i	48
Leon 1.6i	68
Toledo 1.6i	82

SKODA POS

Octavia 1.6i	16
--------------	----

VOLKSWAGEN POS

Bora 1.6i	2
-----------	---

50005130-1

Golf III 1.6i	116
Golf IV 1.6i	128
New Beetle 1.6i	222
Passat 1.6	236
Passat 1.6i	237
Passat 1.8i Turbo 20V	245
Passat 2.0i 20V	253
Polo 1.6i	285

50005131-1



AUDI POS

A3 1.8i 20V	7
A3 1.8i Turbo 20V	8
A4 1.8i Turbo 20V	17
A6 1.8i Turbo 20V	30
S3 1.8i Turbo 20V	59
TT 1.8i Turbo 20V	92

SEAT POS

Alhambra 1.8i Turbo 20V	4
Alhambra 2.0i	6
Cordoba 1.8i Turbo 20V	31
Cordoba 2.0i	36
Ibiza 1.8i Cupra 20V	53
Ibiza 1.8i Turbo 20V	52
Ibiza 2.0i	58
Leon 1.8i 20V	71
Leon 1.8i Cupra R 20V	73
Leon 1.8i Turbo 20V	72
Toledo 1.8i 20V	87
Toledo 1.8i Turbo 20V	88

SKODA POS

Fabia 2.0i	11
Octavia 1.8i 20V	18
Octavia 1.8i Turbo 16V	19
Octavia 1.8i Turbo 20V	20
Octavia 2.0i	23
Superb 1.8i Turbo 20V	30
Superb 2.0i	32

VOLKSWAGEN POS

Bora 1.8i 20V	5
Bora 1.8i Turbo 20V	6
Bora 2.0i	9
Caddy 2.0i EcoFuel	27
Caddy Maxi 2.0 EcoFuel	30
California 2.0i	35
Gol 1.8i Turbo 16V	85
Golf IV 1.8i 20V	131
Golf IV 1.8i Turbo 20V	132
Golf IV 2.0 (Bi-Fuel)	136
Golf IV 2.0i	135
Jetta 1.6i 20V	167
Jetta 2.0i	178
Maxi 2.0i EcoFuel	220
New Beetle 1.8i T 20V	223
New Beetle 2.0i	225
Passat 1.8i Turbo 20V	245
Passat 2.0i	251
Polo 1.8i Turbo 20V	289

MAIN APPLICATIONS



50005131-1



Polo 2.0i	293
Polo Sedan 2.0i	301
Sharan 1.8i Turbo 20V	343
Sharan 2.0 Gas	346
Sharan 2.0i	345
Touran 2.0i EcoFuel	358
Transporter T5 2.0i	376



- DE** Programmergänzung

- EN** Additions to the range

- FR** Compléments de la gamme

- ES** Adiciones al programa

- RU** Дополнение к программе





NEW

NEW

ALFA ROMEO	FORD	MASSEY-FERGUSON	50 005 100
50 005 006 50 005 056	50 005 220 50 005 226 50 005 227	50 005 231 50 005 235	PERKINS
AUDI	50 005 013 50 005 119 50 005 120 50 005 123 50 005 174 50 005 215 50 005 216	50 005 245 50 005 246 50 005 250 50 005 252	50 005 231 50 005 232 50 005 233 50 005 234 50 005 235 50 005 236 50 005 237 50 005 239 50 005 240
50 005 001 50 005 008	HONDA	MAZDA	50 005 245 50 005 246 50 005 247 50 005 248 50 005 249 50 005 250 50 005 251 50 005 252
BMW	50 005 079 50 005 080 50 005 081 50 005 082 50 005 084 50 005 086 50 005 087 50 005 090 50 005 091 50 005 092 50 005 093 50 005 094	50 005 110 50 005 111 50 005 115 50 005 116 50 005 117 50 005 118 50 005 119 50 005 120 50 005 121 50 005 122 50 005 206	PEUGEOT
50 005 011	HYUNDAI	MERCEDES-BENZ	50 005 860
CHEVROLET	50 005 095 50 005 096 50 005 097 50 005 098 50 005 123 50 005 124 50 005 128	50 005 010 50 005 633 50 005 782 50 005 908 50 005 909	RENAULT
50 005 072 50 005 075 50 005 076	50 005 231 50 005 235	MINI (BMW)	50 005 253 50 005 254
CHRYSLER	50 005 245 50 005 246 50 005 252	50 005 044	50 005 027 50 005 040 50 005 170 50 005 171 50 005 934
50 005 128	IHC-CASE (CNH)	MITSUBISHI	RENAULT TRUCKS (RVI)
CITROEN	50 005 217 50 005 219	50 005 095 50 005 123 50 005 124 50 005 125 50 005 126 50 005 127 50 005 128 50 005 129 50 005 133 50 005 134	50 005 245 50 005 246 50 005 252
50 005 860	50 005 231 50 005 235	NISSAN	ROVER
CUMMINS	50 005 245 50 005 246 50 005 252	50 005 135 50 005 136 50 005 141 50 005 169 50 005 170 50 005 171 50 005 172 50 005 173 50 005 174 50 005 175 50 005 934	50 005 080 50 005 082 50 005 084 50 005 090 50 005 901
50 005 217 50 005 219	ISUZU	50 005 100 50 005 173	SAAB
50 005 241 50 005 242	JOHN DEERE	JOHN DEERE	50 005 056
DACIA	50 005 229 50 005 230	KIA	SEAT
50 005 170	KIA	50 005 096 50 005 097 50 005 110 50 005 111 50 005 124	50 005 008 50 005 061
DAEWOO	LANCIA	LANCIA	SKODA
50 005 072 50 005 073 50 005 074 50 005 075 50 005 076	50 005 056 50 005 057	OPEL	50 005 001 50 005 061
DAIHATSU	50 005 056 50 005 057	50 005 003 50 005 006 50 005 056 50 005 074	SUBARU
50 005 077 50 005 078 50 005 182 50 005 187 50 005 189 50 005 196			50 005 176 50 005 177 50 005 180
DEUTZ			
50 005 871 50 005 872			
FIAT / IVECO			
50 005 234 50 005 056 50 005 057 50 005 180 50 005 245 50 005 246 50 005 247 50 005 252			

For details see product program



NEW

SUZUKI



50 005 027
50 005 171
50 005 177
50 005 178
50 005 179
50 005 180

TAM



50 005 871

TOYOTA



50 005 182
50 005 183
50 005 184
50 005 186
50 005 187
50 005 188
50 005 189
50 005 192
50 005 193
50 005 194
50 005 196
50 005 197
50 005 198

VAUXHALL



50 005 003
50 005 006
50 005 056
50 005 074

VOLKSWAGEN



50 005 001
50 005 007
50 005 008
50 005 061

VOLVO



50 005 119
50 005 245
50 005 246
50 005 252
50 005 634

VOLVO-BM



50 005 217



50 005 245
50 005 246
50 005 252

NEW

For details see product program



NEW



NEW



DE Herstellerverzeichnis

EN List of manufacturers

FR Liste de constructeurs

ES Lista de fabricantes

RU Перечень производителей





	Page		Page
A		F	
AGRIA → RENAULT	920	FAHR → DEUTZ	282
ALFA ROMEO	172 → FORD	344
ALLIS-CHALMERS..... → CUMMINS	269 → MERCEDES-BENZ	523
ATLAS COPCO..... → PERKINS	884 → VOLKSWAGEN	1134
..... → SCANIA	999	FAUN → DEUTZ	282
AUDI	177 → FORD	344
AUSTIN (BLMC) → ROVER	986	FENDT → DEUTZ	282
AUTOBIANCHI	219 → MAN	418
AVIA → RENAULT TRUCKS (RVI)	981	FERGUSON → MASSEY-FERGUSON	499
B		FIAT / IVECO	300
BANTAN-E MAQ → MERCEDES-BENZ	523	FIATALLIS..... → MERCEDES-BENZ	523
BARBER GREENE → PERKINS	884	FORD	344
BERLIET → RENAULT TRUCKS (RVI)	981	FORDSON..... → FORD	344
BMW.....	221 → PERKINS	884
BOLINDER-MUNKTELL → VOLVO-BM	1269	G	
BUNGARTZ..... → DEUTZ	282	GAZ..... → PERKINS	884
BÜSSING..... → MAN	418	H	
C		HANOMAG.....	369
CASE..... → IHC-CASE (CNH)	394	HOLDEN..... → OPEL	835
..... → MERCEDES-BENZ	523 → VAUXHALL	1097
..... → SCANIA	999	HONDA.....	374
CBT..... → MERCEDES-BENZ	523	HOOS → MERCEDES-BENZ	523
..... → PERKINS	884	HUBERWABCO (DRESSER)..... → MERCEDES-BENZ	523
CHEVROLET.....	243 → SCANIA	999
CHRYSLER	246	HYSTER → PERKINS	884
CITROEN	248	HYUNDAI.....	384
CLAAS → DEUTZ	282	I	
..... → FORD	344	IHC-CASE (CNH)	394
..... → MERCEDES-BENZ	523 → MERCEDES-BENZ	523
..... → VOLKSWAGEN	1134 → PERKINS	884
CLARK MHC → MERCEDES-BENZ	523 → SCANIA	999
..... → PERKINS	884	IKARBUS BELGRAD → MAN	418
COMPAIR → PERKINS	884	INGERSOLL-RAND → PERKINS	884
CONTINENTAL..... → MASSEY-FERGUSON	499	ISUZU	398
CSEPEL..... → STEYR	1051	IVECO → FIAT / IVECO	300
CUMMINS	269	J	
D		JAGUAR	400
DACIA.....	271	JEEP..... → CHRYSLER	246
..... → RENAULT	920	JOHN DEERE	402
DAEWOO	273	K	
DAEWOO-SSANGYONG → SSANGYONG	1046	KHD..... → DEUTZ	282
DAIHATSU	278	KIA	409
DAIMLER-CHRYSLER → CHRYSLER	246	KOMATSU..... → MERCEDES-BENZ	523
..... → MERCEDES-BENZ	523 → SCANIA	999
DEERE..... → JOHN DEERE	402	KRANEKAR (DRESSER)..... → MERCEDES-BENZ	523
DETROIT DIESEL → MERCEDES-BENZ	523	KÄSSBOHRER → MAN	418
DEUTZ.....	282 → MERCEDES-BENZ	523



	Page		Page
L		S	
LADA	412	SAAB	992
LANCIA.....	414	SAVIEM	997
LAND ROVER..... → ROVER	986	SCANIA	999
M		SEAT.....	1005
MADAL	→ PERKINS 884	SHIGULI..... → LADA	412
.....	→ SCANIA 999	SKODA	1036
MAGIRUS-DEUTZ..... → DEUTZ	282	SOFIM..... → FIAT / IVECO	300
MALVES..... → MERCEDES-BENZ	523 → RENAULT	920
MAN	418	SSANGYONG.....	1046
MAN-BÜSSING	→ MAN 418	STEYR	1051
.....	→ OM 832 → MERCEDES-BENZ	523
MANNESMANN/DEMAG	→ SCANIA 999	SUBARU	1053
MASSEY-FERGUSON.....	499	SUZUKI.....	1056
.....	→ PERKINS 884	T	
MAZDA	514	TAM.....	1063
MERCEDES-BENZ.....	523	TEMA TERRA	→ MERCEDES-BENZ 523
MG	→ ROVER 986	→ PERKINS 884
MINI	→ ROVER 986	→ SCANIA 999
MINI (BMW)	807	TOYOTA	1065
MITSUBISHI	809	U	
MORRIS	→ ROVER 986	UNIC.....	→ FIAT / IVECO 300
N		V	
NEW HOLLAND..... → MERCEDES-BENZ	523	VAUXHALL.....	1097
NISSAN	822	VOLKSWAGEN	1134
O		VOLVO.....	1247
OM.....	832	VOLVO-BM.....	1269
.....	→ FIAT / IVECO 300	Z	
OPEL.....	835	ZETTELMAYER	→ DEUTZ 282
P			
PERKINS.....	884		
PEUGEOT	887		
R			
RABA..... → MAN	418		
REDFLAG..... → AUDI	177		
RENAULT	920		
RENAULT TRUCKS (RVI)	981		
ROMAN-DIESEL	→ MAN 418		
ROVER.....	986		
RVI..... → RENAULT TRUCKS (RVI)	981		



HERSTELLER / MANUFACTURERS / CONSTRUCTEURS /
FABRICANTES / ИЗГОТОВИТЕЛЕЙ



DE Produktprogramm

EN Product range

FR La gamme

ES Programa de productos

RU Производственный ассортимент





A

			Cyl	 mm	cm ³		Comp. Ratio ε	kW	PS	Pos
192 A5.000	D	(LA)	4	82 x 90,4	1910	4	18,45	103	140	4, 7, 18
192 B1.000	D	(LA)	4	82 x 90,4	1910	4	18,45	100	136	4, 7
8140.21.200	D	(A)	4	93 x 90	2445	2	18:1	68	92	21, 23, 25
8140.61.200	D	(AN)	4	93 x 90	2445	2	21:1	53	72	20, 22, 24
8144.61.200	D	(AN)	4	93 x 89,4	2429	2	21:1	53	72	22
839 A6.000	D	(LA)	5	82 x 90,4	2387	2	18:1	103	140	9, 15
841G.000	D	(LA)	5	82 x 90,4	2387	4	18,45:1	120-129	163-175	10, 16
934A4.000	B		4	86 x 94,6	1796	4	10,5:1	103	140	11
937 A4.000	D	(LA)	4	82 x 90,4	1910	4	18,45:1	93	126	4, 7
937 A5.000	D	(LA)	4	82 x 90,4	1910	4	18,45:1	110	150	5, 8, 13, 18
939 A2.000	D	(LA)	4	82 x 90,4	1910	4	17,5:1	110	150	13
939 A3.000	D	(LA)	5	82 x 90,4	2387	4	17:1	147	200	14, 17, 19
939 A6.000	B		4	86 x 80	1859	4	11,3:1	118	160	12
939 A9.000	D	(LA)	5	82 x 90,4	2387	4	17:1	154	210	14, 17, 19
AR 32302	D	(LA)	4	82 x 90,4	1910	2	18,45:1	76	103	1, 2, 6
AR 34202	D	(LA)	5	82 x 90,4	2387	2	18,45:1	100	136	15
AR 37101	D	(LA)	4	82 x 90,4	1910	2	18,45:1	77-85	105-115	3, 6

**145 1.9 JTD****1**

05.1998→12.2000

AR 32302

Reference

46432248
6081460946515970
60815559

46515972

59722248

**50 005 332****146 1.9 JTD****2**

05.1998→12.2000

AR 32302

Reference

46432248
6081460946515970
60815559

46515972

59722248

**50 005 332****147 1.9 JTD****3**

11.2000→05.2001

AR 37101

Reference

46432248
6081460946515970
60815559

46515972

59722248

**50 005 332****147 1.9 JTD 16V****4**

11.2000→

192 A5.000, 192 B1.000, 937 A4.000

Reference

46804051

**50 005 056**
NEW**147 1.9 JTDM 16V****5**

06.2003→

937 A5.000

Reference

46804051

**50 005 056**
NEW**156 1.9 JTD****6**

10.1997→12.2001

AR 32302, AR 37101

Reference

46432248
6081460946515970
60815559

46515972

59722248

**50 005 332****156 1.9 JTD 16V****7**

10.2002→10.2005

192 A5.000, 192 B1.000, 937 A4.000

Reference

46804051

**50 005 056**
NEW**156 1.9 JTDM 16V****8**

10.2003→

937 A5.000

Reference

46804051

**50 005 056**
NEW

**A****156 2.4 JTD****9**

09.2000→12.2001 839 A6.000
 Reference 46432248 46515970 46515972 59722248
 60814609 60815559

**50 005 332****156 2.4 JTDM 20V****10**

06.2003→12.2005 841G.000
 Reference 46804051

**50 005 056**
NEW**159 1.8i 16V****11**

06.2006→ 934A4.000
 Reference 71739779

**50 005 006**
NEW**159 1.9 JTS 16V****12**

06.2005→ 939 A6.000

**50 005 792****159 1.9 JTDM 16V****13**

→ 937 A5.000, 939 A2.000
 Reference 46804051

**50 005 056**
NEW**159 2.4 JTDM 20V****14**

09.2005→ 939 A3.000, 939 A9.000
 Reference 46804051

**50 005 056**
NEW**166 2.4 JTD****15**

10.1998→ 839 A6.000, AR 34202
 Reference 46432248 46515970 46515972 59722248
 60814609 60815559

**50 005 332****166 2.4 JTDM 20V****16**

06.2003→ 841G.000
 Reference 46804051

**50 005 056**
NEW

**Brera 2.4 JTDM 20V****17**

09.2005→
Reference 939 A3.000, 939 A9.000
46804051



50 005 056
NEW

GT 1.9 JTDM 16V**18**

09.2003→
Reference 192 A5.000, 937 A5.000
46804051



50 005 056
NEW

Spider 2.4 JTDM 20V**19**

→
Reference 939 A3.000, 939 A9.000
46804051



50 005 056
NEW

30 AR 8**20**

04.1978→12.1989 8140.61.200
Reference 4714636 4754850 4764761 7303009



50 005 321

30 AR 8 Turbo**21**

04.1985→12.1988 8140.21.200
Reference 4714636 4754850 4764761 7303009



50 005 321

35 AR 8**22**

04.1978→12.1989 8140.61.200, 8144.61.200
Reference 4714636 4754850 4764761 7303009



50 005 321

35 AR 8 Turbo**23**

04.1985→12.1988 8140.21.200
Reference 4714636 4754850 4764761 7303009



50 005 321

40 AR 8**24**

04.1978→12.1989 8140.61.200
Reference 4714636 4754850 4764761 7303009



50 005 321



A



40 AR 8 Turbo

25

04.1985→12.1988

8140.21.200

Reference

4714636

4754850





4764761

7303009



50 005 321

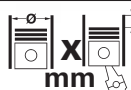





			Cyl	 X mm	cm ³		Comp. Ratio ε	kW	PS	Pos	A
1B	B	(A)	5	81 x 86,4	2226	2	7,8:1	147	200		143
1T	D	(LA)	5	81 x 95,5	2461	2	20:1	88	120		138
1Y	D	(AN)	4	79,5 x 95,5	1896	2	22,5:1	47	64		106
1Z	D	(LA)	4	79,5 x 95,5	1896	2	19,5:1	66	90	18, 31, 68, 108	
2B	B	(A)	5	81 x 86,4	2226	2	8,6:1	140	190		143
3A	B		4	82,5 x 92,8	1984	2	10,5:1	83	113		78, 109
3B	B	(A)	5	81 x 86,4	2226	4	8,75:1	162	220		58, 142
3D	D	(AN)	5	79,5 x 95,5	2370	2	23:1	60	82		137
4B	B		4	81 x 86,4	1781	2	9:1	66	90		127
6A	B		4	82,5 x 92,8	1984	4	10,8:1	101	137		78, 110
7A	B		5	82,5 x 86,4	2309	4	10,3:1	125	170		85, 124
AAD	B		4	82,5 x 92,8	1984	2	10,3:1	85	115		78, 109, 129
AAE	B		4	82,5 x 92,8	1984	2	9,2:1	74	100		32, 129
AAH	B		6	82,5 x 86,4	2771	2	10,3:1	128	174	26, 43, 50, 73, 87, 116, 140	
AAN	B	(A)	5	81 x 86,4	2226	5	9,3:1	169	230		35, 60, 62
AAR	B		5	82,5 x 86,4	2309	2	10:1	98	133		36, 136
AAS	D	(AN)	5	79,5 x 95,5	2370	2	23:1	60	82		137
AAT	D	(A)	5	81 x 95,5	2461	2	20:1	85	115		139
AAZ	D	(A)	4	79,5 x 95,5	1896	2	22,5:1	55	75		107
ABB	B		4	81 x 77,4	1595	2	10,3:1	75	102		99, 125
ABC	B		6	82,5 x 81	2598	2	10:1	110	150	25, 40, 72, 86, 115	
ABK	B		4	82,5 x 92,8	1984	2	10,3:1	85	115	32, 69, 78, 109, 129	
ABM	B		4	81 x 77,4	1595	2	9:1	52	71		99
ABP	D	(A)	5	81 x 95,5	2461	2	20:1	85	115		139
ABT	B		4	82,5 x 92,8	1984	2	8,9:1	66	90		109
ABY	B	(A)	5	81 x 86,4	2226	4	9,3:1	169	230	58, 83, 113	
ABZ	B		8	84,5 x 93	4172	4	10,8:1	220	300		55
ACE	B		4	82,5 x 92,8	1984	4	10,8:1	103	140	33, 70, 79, 110, 130	
ACK	B		6	82,5 x 86,4	2771	5	10,6:1	142	193	27, 44, 51	
ACZ	B		6	82,5 x 81	2598	2	10:1	102	139	25, 40, 72, 115	
ADA	B		4	81 x 77,4	1595	2	10,5:1	74	100		99
ADP	B		4	81 x 77,4	1595	2	10,3:1	74	101		14
ADR	B		4	81 x 86,4	1781	5		92	125	16, 29, 67	
ADW	B		4	82,5 x 92,8	1984	2	9,2:1	79	107	32, 109, 129	
AEB	B	(A)	4	81 x 86,4	1781	5	9,5:1	110	150		17, 30
AEC	B		8	84,5 x 93	4172	4	10,8:1	213	290		63
AEH	B		4	81 x 77,4	1595	2	10,3:1	74	101		5
AEJ	B		6	82,5 x 86,4	2771	2	10,3:1	120	163		42, 50
AEL	D	(LA)	5	81 x 95,5	2461	2	20:1	103	140		38
AEM	B		8	84,5 x 93	4172	4	10,8:1	180	245		55
AEW	B		8	84,5 x 82,4	3697	4	10,8:1	169	230		53
AFB	D	(A)	6	78,3 x 86,4	2496	4	19,5:1	110	150	23, 38, 49	
AFC	B		6	82,5 x 86,4	2771	2	10,3:1	128	174		42
AFF	D	(A)	4	79,5 x 95,5	1896	2	19,5:1	55	75		18
AFM	B		6	81 x 77,4	2393	5	10,5:1	110	150		22, 37
AFN	D	(LA)	4	79,5 x 95,5	1896	2	19,5:1	81	110		18, 31
AFY	B		4	81 x 86,4	1781	2		85	115		15, 28
AGA	B		6	81 x 77,4	2393	5	10,5:1	121	165		22, 37
AGB	B	(A)	6	81 x 86,4	2671	5	9,3:1	195	265		61
AGE	B		6	82,5 x 86,4	2771	5	10,6:1	132	180		44
AGH	B		8	84,5 x 93	4172	4	10,8:1	210	285		55
AGN	B		4	81 x 86,4	1781	5		92	125		7
AGR	D	(LA)	4	79,5 x 95,5	1896	2	19,5:1	66	90		9
AGU	B	(LA)	4	81 x 86,4	1781	5	9,5:1	110	150		8
AHC	B		8	84,5 x 93	4172	4	11,6:1	250	340		65
AHF	D	(LA)	4	79,5 x 95,5	1896	2	19,5:1	81	110		9
AHH	D	(A)	4	79,5 x 95,5	1896	2	19,5:1	66	90		18
AHK	B		8	84,5 x 93	4172	4	11,6:1	240	326		63
AHL	B		4	81 x 77,4	1595	2	10,3:1	74	101		14
AHU	D	(A)	4	79,5 x 95,5	1896	2	19,5:1	66	90	18, 31, 68	
AJG	B		6	81 x 77,4	2393	5	10,5:1	120	163		22, 37
AJK	B	(A)	6	81 x 86,4	2671	5	9,3:1	169	230		41
AJL	B	(A)	4	81 x 86,4	1781	5	9,5:1	132	180		17, 30
AJM	D	(A)	4	79,5 x 95,5	1896	2	19,5:1	85	115		18, 31
AJP	B		4	81 x 86,4	1781	2	10,3:1	92	125		28
AJQ	B	(LA)	4	81 x 86,4	1781	5	9,5:1	132	180		8, 92
AKC	B		8	84,5 x 82,4	3697	5	11:1	191	260		54
AKE	D	(LA)	6	78,3 x 86,4	2496	4	19,5:1	132	179		23, 38, 47, 49



A

			Cyl		mm	cm ³	Comp. Ratio ϵ	kW	PS	Pos
AKG	B		8	84,5 x 93	4172	4	10,8:1	220	299	55
AKH	B		8	84,5 x 93	4172	4	11,6:1	250	340	65
AKJ	B		8	84,5 x 82,4	3697	4	10,8:1	169	230	53
AKL	B		4	81 x 77,4	1595	2	10,2:1	74	101	5
AKN	D	(A)	6	78,3 x 86,4	2496	4	19,5:1	110	150	23, 38, 49
ALF	B		6	81 x 77,4	2393	5	10,5:1	121	165	22, 37
ALG	B		6	82,5 x 86,4	2771	5	10,6:1	142	193	27, 44, 51
ALH	D	(A)	4	79,5 x 95,5	1896	2	19,5:1	66	90	9
ALT	B		4	82,5 x 92,8	1984	5	10,3:1	96	131	19, 34
ALW	B		6	81 x 77,4	2393	5	10,5:1	100	134	37
ALZ	B		4	81 x 77,4	1595	2	10,3:1	75	102	14
AMB	B	(LA)	4	81 x 86,4	1781	5	9,3:1	125	170	17
AMF	D	(LA)	3	79,5 x 95,5	1422	2	19,5:1	55	75	3
AMK	B	(LA)	4	81 x 86,4	1781	5	9,5:1	154	210	59
AML	B		6	81 x 77,4	2393	5	10,5:1	121	165	22, 37
AMM	B		6	81 x 77,4	2393	5	10,5:1	120	163	22, 37
AMX	B		6	82,5 x 86,4	2771	5	10,6:1	142	193	27, 44, 51
ANA	B		4	81 x 77,4	1595	2	10,3:1	74	101	14
ANB	B	(A)	4	81 x 86,4	1781	5	9,5:1	110	150	17
ANK	B		8	84,5 x 93	4172	5	11:1	250	340	64
ANY	D	(LA)	3	76,5 x 86,4	1191	2	19,5:1	45	61	1
APC	B		6	81 x 77,4	2393	5	10,5:1	115	156	37
APF	B		4	81 x 77,4	1595	2	10,3:1	74	101	5
APG	B		4	81 x 86,4	1781	5	10,3:1	92	125	7
APP	B	(LA)	4	81 x 86,4	1781	5	9,5:1	132	180	8, 92
APR	B		6	82,5 x 86,4	2771	5	10,6:1	142	193	27, 44, 51
APS	B		6	81 x 77,4	2393	5	10,3:1	121	165	22, 37
APT	B		4	81 x 86,4	1781	5	10,3:1	92	125	16
APU	B	(A)	4	81 x 86,4	1781	5	9,5:1	110	150	17, 30
APX	B	(A)	4	81 x 86,4	1781	5	8,9:1	165	224	92
APY	B	(A)	4	81 x 86,4	1781	5	9,5:1	154	209	59
APZ	B		6	81 x 77,4	2393	5	10,5:1	120	163	22, 37
AQA	B	(A)	4	81 x 86,4	1781	5	9,5:1	110	150	8
AQD	B		6	82,5 x 86,4	2771	5	10,6:1	142	193	27, 44, 51
AQE	B		4	81 x 86,4	1781	5	10,3:1	92	125	29
AQF	B		8	84,5 x 93	4172	5	11:1	228	310	56
AQG	B		8	84,5 x 82,4	3697	5	11:1	191	260	54
AQH	B		8	84,5 x 93	4172	5	11:1	265	360	66
AQJ	B		8	84,5 x 93	4172	5	11:1	250	340	64
ARE	B	(LA)	6	81 x 86,4	2671	5	9,3:1	184	250	41, 48
ARG	B		4	81 x 86,4	1781	5	10,3:1	92	125	16
ARH	B		4	81 x 86,4	1781	5	10,3:1	92	125	29
ARJ	B		6	81 x 77,4	2393	5	10,5:1	121	165	22, 37
ARM	B		4	81 x 77,4	1595	2	10,3:1	74	101	14
ARS	B		8	84,5 x 93	4172	5	11:1	220	299	46
ARX	B	(A)	4	81 x 86,4	1781	5	9,5:1	110	150	8
ARY	B	(LA)	4	81 x 86,4	1781	5	9,5:1	132	180	8, 92
ARZ	B	(A)	4	81 x 86,4	1781	5	9,5:1	110	150	8
ASG	B		8	84,5 x 93	4172	5	11:1	220	299	46
ASJ	B	(LA)	6	81 x 86,4	2671	5	9,3:1	280	381	57
ASM	B		6	81 x 77,4	2393	5	10,5:1	100	136	37
ASN	B		6	82,5 x 92,8	2976	5	10,5:1	162	220	45, 52
ASV	D	(LA)	4	79,5 x 95,5	1896	2	19,5:1	81	110	9
ASZ	D	(LA)	4	79,5 x 95,5	1896	2	19:1	96	130	9
ATD	D	(LA)	4	79,5 x 95,5	1896	2	19:1	74	101	9
ATJ	D	(LA)	4	79,5 x 95,5	1896	2	18:1	85	115	18
ATL	D	(A)	3	79,5 x 95,5	1422	2	19,5:1	66	90	3
AUA	B		4	76,5 x 75,6	1390	4	10,5:1	55	75	2
AUM	B	(LA)	4	81 x 86,4	1781	5	9,5:1	110	150	8, 92
AUQ	B	(LA)	4	81 x 86,4	1781	5	9,5:1	132	180	8, 92
AUW	B		8	84,5 x 93	4172	5	11:1	228	310	56
AVB	D	(A)	4	79,5 x 95,5	1896	2	19:1	74	101	18
AVF	D	(LA)	4	79,5 x 95,5	1896	2	19:1	96	130	18, 31
AVG	D	(LA)	4	79,5 x 95,5	1896	2	19,5:1	81	110	18, 31
AVJ	B	(LA)	4	81 x 86,4	1781	5	9,3:1	110	150	17
AVP	B		8	84,5 x 93	4172	5	11:1	265	360	66
AVU	B		4	81 x 77,4	1595	2	10,3:1	75	102	5
AVV	B		4	81 x 86,4	1781	5	10,3:1	92	125	16
AWA	B		4	82,5 x 92,8	1984	5	11,5:1	110	150	20







			Cyl	 mm	cm ³		Comp. Ratio ε	kW	PS	Pos	A
AWT	B	(A)	4	81 x 86,4	1781	5	9,5:1	110	150	17, 30	
AWX	D	(A)	4	79,5 x 95,5	1896	2	19:1	96	130	18, 31	
AXR	D	(LA)	4	79,5 x 95,5	1896	2	19:1	74	101	9	
AXW	B		4	82,5 x 92,8	1984	4	11,5:1	110	150	10	
AYM	D	(LA)	6	78,3 x 86,4	2496	4	18,5:1	114	155	23, 38	
AZA	B	(A)	6	81 x 86,4	2671	5	9,3:1	169	230	41	
AZB	B	(A)	6	81 x 86,4	2671	5	9,3:1	195	265	61	
AZR	B	(A)	6	81 x 86,4	2671	5	9:1	280	381	57	
AZV	D	(LA)	4	81 x 95,5	1968	4	18:1	100	136	12	
BAD	B		4	76,5 x 86,9	1598	4	12:1	81	110	4	
BAG	B		4	76,5 x 86,9	1598	4	12:1	85	115	6	
BAM	B	(LA)	4	81 x 86,4	1781	5	9:1	165	225	59, 92	
BAU	D	(LA)	6	78,3 x 86,4	2496	4	18,5:1	132	179	24, 39, 47	
BBJ	B		6	82,5 x 92,8	2976	5	10,5:1	160	218	45, 52	
BBY	B		4	76,5 x 75,6	1390	4	10,5:1	55	75	2	
BCS	B		8	84,5 x 93	4172	5	11:1	265	360	66	
BDB	B		6	84 x 95,9	3189	4	11,3:1	184	250	13	
BDG	D	(LA)	6	78,3 x 86,4	2496	4	18,5:1	120	163	24, 39	
BDH	D	(LA)	6	78,3 x 86,4	2496	4	18,5:1	132	179	24, 39	
BDV	B		6	81 x 77,4	2393	5	10,5:1	125	170	22, 37	
BES	B	(LA)	6	81 x 86,4	2671	5	9,3:1	184	250	41, 48	
BEX	B	(LA)	4	81 x 86,4	1781	5	9,3:1	140	190	17	
BFB	B	(LA)	4	81 x 86,4	1781	5	9,3:1	120	163	17	
BFC	D	(LA)	6	78,3 x 86,4	2496	4	18,5:1	120	163	24, 39	
BFQ	B		4	81 x 77,4	1595	2	10,2:1	75	102	5	
BFV	B	(LA)	4	81 x 86,4	1781	5	9:1	180	245	92	
BGU	B		4	81 x 77,4	1595	2	10,5:1	75	102	5	
BHC	D	(A)	3	79,5 x 95,5	1422	2	19,5:1	55	75	3	
BHE	B		6	84 x 95,9	3189	4	11,3:1	184	250	93	
BKC	D	(LA)	4	79,5 x 95,5	1896	2	19:1	77	105	9	
BKD	D	(LA)	4	81 x 95,5	1968	4	18:1	103	140	12	
BKE	D	(LA)	4	79,5 x 95,5	1896	2	19:1	85	116	18	
BLF	B		4	76,5 x 86,9	1598	4	12:1	85	115	6	
BLP	B		4	76,5 x 86,9	1598	4	12:1	85	116	6	
BLR	B		4	82,5 x 92,8	1984	4	11,5:1	110	150	10	
BLS	D	(LA)	4	79,5 x 95,5	1896	2	19:1	77	105	9	
BLX	B		4	82,5 x 92,8	1984	4	11,5:1	110	150	10	
BLY	B		4	82,5 x 92,8	1984	4	11,5:1	110	150	10	
BMB	B		4	82,5 x 92,8	1984	4	11,5:1	110	150	10	
BMJ	B		6	84 x 95,9	3189	4	11,3:1	184	250	13	
BMM	D	(LA)	4	81 x 95,5	1968	2	18,5:1	103	140	11	
BPF	B		6	84 x 95,9	3189	4	11,3:1	184	250	93	
BPW	D	(LA)	4	81 x 95,5	1968	2	19:1	103	140	21	
BRB	D	(LA)	4	79,5 x 95,5	1896	2	19:1	85	116	18	
BSE	B		4	81 x 77,4	1595	2	10,3:1	75	102	5	
BSF	B		4	81 x 77,4	1595	2	10,3:1	75	102	5	
BUB	B		6	84 x 95,9	3189	4	11,3:1	184	250	13, 93	
BVP	B	(LA)	4	81 x 86,4	1781	5	9,5:1	120	163	92	
BVR	B	(LA)	4	81 x 86,4	1781	5	9,5:1	140	190	92	
BVY	B		4	82,5 x 92,8	1984	4	11,5:1	110	150	10	
BVZ	B		4	82,5 x 92,8	1984	4	11,5:1	110	150	10	
BXE	D	(LA)	4	79,5 x 95,5	1896	2	19:1	77	105	9	
CN	D	(AN)	5	76,5 x 86,4	1986	2	23:1	51	70	131, 149	
CR	D	(AN)	4	76,5 x 86,4	1588	2	23,5:1	40	54	100, 146	
CY	D	(A)	4	76,5 x 86,4	1588	2	23:1	51	70	101, 117	
DD	B		4	81 x 86,4	1781	2	8,8:1	55	75	75	
DE	D	(A)	5	76,5 x 86,4	1986	2	23:1	66	90	132, 150	
DR	B		4	81 x 86,4	1781	2	8,75:1	55	75	126	
DS	B		4	81 x 86,4	1781	2	9:1	66	90	75, 103, 126	
DT	B		4	81 x 77,4	1595	2	9:1	55	75	98	
DZ	B		4	81 x 86,4	1781	2	10:1	82	112	76, 104, 119	
EP	B		4	75 x 73,4	1297	2	9:1	44	60	96	
FS	B		4	79,5 x 80	1588	2	8,2:1	53	72	99	
FY	B		4	75 x 72	1272	2	8,2:1	40	54	88, 96, 144	
FZ	B		4	75 x 72	1272	2	8,2:1	44	60	96	
GV	B	(A)	5	79,5 x 86,4	2144	4	7:1	147	200	90	
HB	B		4	69,5 x 72	1093	2	8,2:1	37	50	94	
HC	B		4	69,5 x 72	1093	2	9,5:1	44	60	94	
HD	B		4	69,5 x 72	1093	2	8,2:1	38	52	94	



A

			Cyl		mm	cm ³	Comp. Ratio ϵ	kW	PS	Pos
HH	B		4	75 x 72	1272	2	8,2:1	44	60	88, 95, 144
HP	B		5	81 x 77,4	1994	2	10:1	85	115	78, 109, 120
HX	B		5	81 x 86,4	2226	2	10:1	101	137	134
HY	B		5	81 x 86,4	2226	2	9,3:1	100	136	82, 122
JK	D	(AN)	4	76,5 x 86,4	1588	2	23,5:1	40	54	100, 146
JL	B		5	81 x 77,4	1994	2	10:1	81	110	78, 109, 120
JN	B		4	81 x 86,4	1781	2	10:1	66	90	75, 103, 118, 147
JS	B		5	81 x 77,4	1994	2	10:1	85	115	78, 109, 120
JT	B		5	81 x 86,4	2226	2	8,5:1	89	121	82, 122, 148
JU	B		4	81 x 77,4	1595	2	9:1	55	75	98
JV	B		4	81 x 86,4	1781	2	9:1	66	90	75, 103
JW	B		4	81 x 86,4	1781	2	10:1	66	90	126
JY	B		5	79,5 x 86,4	2144	2	8,8:1	134	182	141
KE	B		5	79,5 x 86,4	2144	2	9,3:1	96	131	82
KF	B		5	79,5 x 86,4	2144	2	9,3:1	96	131	134
KG	B	(LA)	5	79,5 x 86,4	2144	2	8,5:1	134	182	143
KJ	B	(A)	5	79,5 x 86,4	2144	2	7:1	125	170	143
KK	B		5	79,5 x 86,4	2144	2	9,3:1	100	136	112
KL	B		5	79,5 x 86,4	2144	2	9,3:1	96	130	82, 112
KN	B		4	81 x 86,4	1781	2	10:1	66	90	126
KP	B		5	81 x 77,4	1994	2	10:1	85	115	129
KU	B		5	81 x 86,4	2226	2	10:1	101	137	134, 141
KV	B		5	81 x 86,4	2226	2	10:1	98	133	82, 122
KX	B		5	81 x 86,4	2226	2	8,5:1	88	120	82, 122, 148
KZ	B		5	81 x 86,4	2226	2	8,5:1	85	115	134, 151
MB	B	(A)	5	81 x 86,4	2226	5	8,6:1	147	200	91
MC	B	(LA)	5	81 x 86,4	2226	2	7,8:1	121	165	135, 143
MU	B		4	81 x 86,4	1781	2	10:1	82	112	104
NC	D	(LA)	5	76,5 x 86,4	1986	2	23:1	74	100	132
NE	B		4	81 x 86,4	1781	2	10:1	66	90	103
NF	B		5	82,5 x 86,4	2309	2	10:1	100	136	136, 152
NG	B		5	82,5 x 86,4	2309	2	10:1	100	136	71, 84, 114, 123
NM	B		5	81 x 77,4	1994	4	10,3:1	118	160	80, 121
NP	B		4	81 x 86,4	1781	2	10:1	66	90	126
PH	B		4	81 x 86,4	1781	2	9:1	66	90	127
PM	B		4	81 x 86,4	1781	2	9:1	66	90	104
PP	B		4	81 x 77,4	1595	2	9:1	51	70	98
PS	B		5	81 x 77,4	1994	2	10:1	85	115	120
PV	B		4	81 x 86,4	1781	2	10:1	81	110	76, 104
RA	D	(LA)	4	76,5 x 86,4	1588	2	23:1	59	80	101, 117
RN	B		4	81 x 77,4	1595	2	9:1	55	75	98
RR	B	(A)	5	81 x 86,4	2226	4	8,75:1	162	220	90
RS	B		4	81 x 86,4	1781	2	8,75:1	55	75	126
RT	B		5	81 x 77,4	1994	2	10:1	85	115	129
RU	B		4	81 x 86,4	1781	2	8,75:1	55	75	103
SA	B		4	81 x 77,4	1595	2	9:1	55	75	98
SB	D	(LA)	4	76,5 x 86,4	1588	2	23:1	59	80	101, 117
SD	B		4	82,5 x 86,4	1857	2	10,5:1	83	113	105
SF	B		4	81 x 86,4	1781	2	10:1	64	87	75, 76, 103
SH	B		4	81 x 86,4	1781	2	9:1	65	88	126, 127
SK	B		5	81 x 77,4	1994	2	10:1	85	115	78, 120
SL	B		5	81 x 77,4	1994	2	10:1	83	113	129
WB	B		5	79,5 x 86,4	2144	2	9,3:1	85	115	133
WC	B		5	79,5 x 86,4	2144	2	9,3:1	100	136	134, 141
WE	B		5	79,5 x 86,4	2144	2	8,2:1	79-85	107-115	81, 111, 134, 148, 151
WG	B		5	79,5 x 86,4	2144	2	9,3:1	100	136	134
WH	B		5	79,5 x 77,4	1921	2	10:1	74	100	128
WJ	B	(A)	5	79,5 x 86,4	2144	2	7:1	125	170	143
WK	B		5	79,5 x 86,4	2144	2	9,3:1	100	136	141
WN	B		5	79,5 x 77,4	1921	2	10:1	85	115	77, 105
WR	B	(LA)	5	79,5 x 86,4	2144	4	7:1	147	200	90
WS	B	(A)	5	79,5 x 86,4	2144	4	7:1	125	170	142
WT	B		4	79,5 x 86,4	1716	2	8,2:1	58	78	102
WU	B		5	79,5 x 86,4	2144	2	10:1	85	115	134
WV	B		4	79,5 x 80	1588	2	8,2:1	55	75	98
WX	B	(LA)	5	79,5 x 86,4	2144	4	7:1	119	162	90
WY	B		4	79,5 x 80	1588	2	8,2:1	55	75	98
WZ	B		4	79,5 x 80	1588	2	8,2:1	55	75	98
XX	B		4	79,5 x 80	1588	2	8,2:1	74	100	99

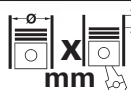

			Cyl	 X mm	cm ³		Comp. Ratio ε	kW	PS	Pos
YG	B		4	79,5 x 80	1588	2	8,2:1	61	83	89, 98, 145
YH	B		4	79,5 x 80	1588	2	8,2:1	61	83	89, 98, 145
YJ	B		4	76,5 x 80	1471	2	9,7:1	55	75	97
YK	B		4	79,5 x 80	1588	2	8,2:1	61	83	89, 98
YN	B		4	79,5 x 80	1588	2	8,2:1	55	75	74, 89, 98
YP	B		4	79,5 x 80	1588	2	8,2:1	63	85	98
YS	B		4	79,5 x 80	1588	2	9,5:1	81	110	99
YT	B		4	79,5 x 80	1588	2	8,2:1	51	70	98
YV	B		4	79,5 x 80	1588	2	8,2:1	63	85	125
YY	B		4	79,5 x 80	1588	2	8:1	51	70	98
YZ	B		4	79,5 x 80	1588	2	9,5:1	81	110	99
ZA	B		4	75 x 73,4	1297	2	8,5:1	40	55	96
ZB	B		4	76,5 x 80	1471	2	9,7:1	55	75	97
ZC	B		4	76,5 x 80	1471	2	9,7:1	63	85	97
ZF	B		4	75 x 73,4	1297	2	8,5:1	44	60	96



AUDI

A

**A2 1.2 TDI**

1

03.2001→08.2005 ANY
Reference 045 121 011B 045 121 011F 045 121 011H 045 121 011HX



50 005 556

A2 1.4i 16V

2

06.2000→08.2005 AUA, BBY
Reference 036 121 005 B 036 121 005 E 036 121 005 Q 036 121 005 QX
036 121 005 S 036 121 008K 036 121 008L 036 121 008LX



50 005 154

06.2000→08.2005 AUA, BBY
Reference 036 115 105 B 036 115 105 B 036 115 105 B 036 115 105 B
036 115 105 D 036 115 105 D 036 115 105 D 036 115 105 D



50 005 844

A2 1.4 TDI

3

06.2000→08.2005 AMF, ATL, BHC
Reference 045 121 011B 045 121 011F 045 121 011H 045 121 011HX
AMF: →8Z-2-070 000



50 005 556

A2 1.6 FSI 16V

4

05.2002→08.2005 BAD
Reference 036 121 005 F 036 121 005 P 036 121 008 G 036 121 008 GX



50 005 754

A3 1.6i

5

05.2003→
Reference BGU, BSE, BSF
06B 121 011 H 06B 121 011L 06B 121 011LX 06B 121 011M



50 005 775

09.1996→
Reference AEH, AKL, APF, AVU, BFQ, BGU, BSE, BSF
06A 115 105 06A 115 105 06A 115 105 06A 115 105
06A 115 105 B 06A 115 105 B 06A 115 105 B 06A 115 105 B
06A 115 105 C 06A 115 105 C 06A 115 105 C 06A 115 105 C
06A 115 105 D 06A 115 105 D 06A 115 105 D 06A 115 105 D



50 005 819

09.1996→06.2003 AEH, AKL, APF, AVU



50 005 130

A3 1.6 FSI 16V

6



08.2003→09.2007 BAG, BLF, BLP
Reference 03C 121 005 D 03C 121 005 K 03C 121 005 L





50 005 001

NEW





**A3 1.8i 20V****7**

09.1996→06.2003	AGN, APG					50 005 819	
Reference	06A 115 105 06A 115 105 B 06A 115 105 C 06A 115 105 D	06A 115 105 06A 115 105 B 06A 115 105 C 06A 115 105 D	06A 115 105 06A 115 105 B 06A 115 105 C 06A 115 105 D	06A 115 105 06A 115 105 B 06A 115 105 C 06A 115 105 D			
09.1996→06.2003	AGN, APG						50 005 131

A3 1.8i Turbo 20V**8**

12.1996→06.2003	AGU, AJQ, APP, AQA, ARX, ARY, ARZ, AUM, AUQ					50 005 819	
Reference	06A 115 105 06A 115 105 B 06A 115 105 C 06A 115 105 D	06A 115 105 06A 115 105 B 06A 115 105 C 06A 115 105 D	06A 115 105 06A 115 105 B 06A 115 105 C 06A 115 105 D	06A 115 105 06A 115 105 B 06A 115 105 C 06A 115 105 D			
12.1996→06.2003	AGU, AJQ, APP, AQA, ARY, ARZ, AUM, AUQ						50 005 131

A3 1.9 TDI**9**

09.1996→04.2002	AGR, AHF, ALH, ASV						50 005 132
Reference	038 121 011	038 121 011 A	038 121 011 AV	038 121 011AX			
06.2003→05.2009	BKC, BLS, BXE						50 005 556
Reference	045 121 011B	045 121 011F	045 121 011H	045 121 011HX			
05.2000→06.2003	ASZ, ATD, AXR						50 005 783
Reference	038 121 011 G F8L-3-000 001→						
09.1996→06.2003	AGR, AHF, ALH, ASV, ATD, AXR					50 005 819	
Reference	06A 115 105 06A 115 105 B 06A 115 105 C 06A 115 105 D	06A 115 105 06A 115 105 B 06A 115 105 C 06A 115 105 D	06A 115 105 06A 115 105 B 06A 115 105 C 06A 115 105 D	06A 115 105 06A 115 105 B 06A 115 105 C 06A 115 105 D			
05.2000→06.2003	ASZ, ATD, AXR						50 005 554
Reference	038 121 001 C 038 121 011J ATD, AXR: →8L-2-150 000	038 121 011 C 038 121 011K	038 121 011 D 038 121 011KX	038 121 011G			

A3 2.0 FSI 16V**10**

05.2003→06.2008	AXW, BLR, BLX, BLY, BMB, BVY, BVZ						50 005 775
Reference	06B 121 011 H	06B 121 011L	06B 121 011LX	06B 121 011M			



A

**A3 2.0 TDI****11**

06.2005→06.2008

BMM

Reference

038 121 011 G
→8P-6-131 500

50 005 783

A3 2.0 TDI 16V**12**

05.2003→06.2008

AZV, BKD

Reference

038 121 001 C 038 121 011 C 038 121 011 D 038 121 011 G
038 121 011 J 038 121 011 K 038 121 011 KX

50 005 554

A3 3.2i 24V**13**

07.2003→

BDB, BMJ, BUB

Reference

022 121 011

50 005 008

NEW

A4 1.6i**14**

11.1994→10.1996

ADP

Reference

050 121 010 050 121 010 A 050 121 010 C 050 121 010 CX
mit Gegengehäuse/with backhousing/avec demi-corps/con remate/c задним корпусом

50 005 156

10.1996→06.2008

AHL, ALZ, ANA, ARM

Reference

06A 115 105 06A 115 105 06A 115 105 06A 115 105
06A 115 105 B 06A 115 105 B 06A 115 105 B 06A 115 105 B
06A 115 105 C 06A 115 105 C 06A 115 105 C 06A 115 105 C
06A 115 105 D 06A 115 105 D 06A 115 105 D 06A 115 105 D
8D-X-200 001→

50 005 819

11.1994→10.1996

ADP

Reference

026 121 005 F 026 121 005 FV 026 121 005 FX 026 121 005 K
026 121 005 L
ohne Gegengehäuse/without backhousing/sans demi-corps/sin remate/без заднего корпуса

50 005 155

10.1996→06.2008

AHL, ALZ, ANA, ARM



50 005 130

A4 1.8i**15**

07.1995→09.2001

AFY

Reference

058 115 105 A 058 115 105 A 058 115 105 B 058 115 105 B
058 115 105 C 058 115 105 C

50 005 811

07.1995→09.2001

AFY

Reference

050 121 010 050 121 010 A 050 121 010 C 050 121 010 CX
mit Gegengehäuse/with backhousing/avec demi-corps/con remate/c задним корпусом

50 005 156

07.1995→09.2001

AFY

Reference

026 121 005 F 026 121 005 FV 026 121 005 FX 026 121 005 K
026 121 005 L
ohne Gegengehäuse/without backhousing/sans demi-corps/sin remate/без заднего корпуса

50 005 155

**A4 1.8i 20V****16**

11.1994→09.2001	ADR, APT, ARG, AVV						
Reference	058 115 105 A 058 115 105 C	058 115 105 A 058 115 105 C	058 115 105 B	058 115 105 B		50 005 811	
11.1994→04.1999	ADR						50 005 156
Reference	050 121 010	050 121 010 A	050 121 010 C	050 121 010 CX			
	mit Gegengehäuse/with backhousing/avec demi-corps/con remate/c задним корпусом						
11.1994→04.1999	ADR						50 005 155
Reference	026 121 005 F 026 121 005 L	026 121 005 FV	026 121 005 FX	026 121 005 K			
	ohne Gegengehäuse/without backhousing/sans demi-corps/sin remate/без заднего корпуса						

A4 1.8i Turbo 20V**17**

02.1995→09.2001	AEB, AJL, ANB, APU						
Reference	058 115 105 A 058 115 105 C	058 115 105 A 058 115 105 C	058 115 105 B	058 115 105 B		50 005 811	
02.1995→09.2001	AEB, AJL						50 005 156
Reference	050 121 010	050 121 010 A	050 121 010 C	050 121 010 CX			
	mit Gegengehäuse/with backhousing/avec demi-corps/con remate/c задним корпусом						
06.2000→	AMB, AVJ, AWT, BEX, BFB					50 005 819	
Reference	06A 115 105 06A 115 105 B 06A 115 105 C 06A 115 105 D	06A 115 105 06A 115 105 B 06A 115 105 C 06A 115 105 D	06A 115 105 06A 115 105 B 06A 115 105 C 06A 115 105 D	06A 115 105 06A 115 105 B 06A 115 105 C 06A 115 105 D			
	AWT: 8D-X-200 001→ AMB, AVJ, BEX: 8E-1-000 001→8E-5-400 000						
06.2000→06.2002	AVJ, AWT						50 005 131
02.1995→09.2001	AEB, AJL						50 005 155
Reference	026 121 005 F 026 121 005 L	026 121 005 FV	026 121 005 FX	026 121 005 K			
	ohne Gegengehäuse/without backhousing/sans demi-corps/sin remate/без заднего корпуса						
08.1998→09.2001	APU						50 005 130

A4 1.9 TDI**18**

01.1995→06.2000	1Z, AHU						
Reference	026 121 010 026 121 010 F 026 121 010 X 068 121 010 A	026 121 010 C 026 121 010 FV 037 121 010 068 121 010 AX	026 121 010 CV 026 121 010 FX 037 121 010 A	026 121 010 CX 026 121 010 V 037 121 010 AX			50 005 151
	mit Gegengehäuse/with backhousing/avec demi-corps/con remate/c задним корпусом						



A

01.1995→09.2001 Reference	1Z, AFF, AFN, AHH, AHU 028 121 004 028 121 004 V 028 121 004 X			50 005 158
01.1995→06.2000 Reference	1Z, AHU 026 121 005 A 026 121 005 C 026 121 005 E 026 121 005 G 026 121 005 H 037 121 005 B 037 121 005 C 068 121 005 A ohne Gegengehäuse/without backhousing/sans demi-corps/sin remate/без заднего корпуса			50 005 148
11.2000→06.2008 Reference	AVB, AVF, AWX, BKE, BRB 038 121 011 G BRB: →8E-6-177 000 / 8E-6-800 875 AVB, AVF, AWX, BKE: F8E-2-295 001→			50 005 783
08.1998→06.2008 Reference	AJM, ATJ, AVB, BKE, BRB 06A 115 105 06A 115 105 06A 115 105 06A 115 105 06A 115 105 B 06A 115 105 B 06A 115 105 B 06A 115 105 B 06A 115 105 C 06A 115 105 C 06A 115 105 C 06A 115 105 C 06A 115 105 D 06A 115 105 D 06A 115 105 D 06A 115 105 D AJM, ATJ: 8D-X-200 001→ AVB, BKE: 8E-1-000 001→8E-5-400 000 BKE, BRB: 8E-5-400 001→			50 005 819
01.1995→09.2001 Reference	1Z, AFF, AFN, AHH, AHU, AVG 028 115 105 M 028 115 105 M AFF, AFN, AHH, AHU, AVG: 01.1999→, 8D-X-200 001→ AFF, AFN, AHH, AHU: →12.1998			50 005 867
08.1998→12.2004 Reference	AJM, ATJ, AVB, AVF, AWX 038 121 001 C 038 121 011 C 038 121 011 D 038 121 011 G 038 121 011 J 038 121 011 K 038 121 011 K X			50 005 554
A4 2.0i 20V				19
12.2000→06.2008	ALT			50 005 130
A4 2.0 FSI 16V				20
07.2002→12.2004 Reference	AWA 06B 121 011 H 06B 121 011 L 06B 121 011 LX 06B 121 011 M 8E-1-000 001→8E-5-400 000			50 005 775
A4 2.0 TDI				21
11.2004→ Reference	BPW 038 121 011 G →8E-6-177 000 / 8E-6-800 875			50 005 783

**A4 2.4i 30V****22**

07.1995→12.2005	AFM, AGA, AJG, ALF, AML, AMM, APS, APZ, ARJ, BDV					50 005 167
Reference	078 121 004 H	078 121 004 HV	078 121 004 HX	078 121 004 J		
	078 121 004 JV	078 121 004 JX	078 121 004 Q	078 121 004 QX		

A4 2.5 TDI**23**

11.1997→05.2003	AFB, AKE, AKN, AYM					50 005 168
Reference	059 121 004 B	059 121 004 C	059 121 004 D	059 121 004 E		
	059 121 004 EX					

A4 2.5 TDI 24V**24**

07.2002→05.2006	BAU, BDG, BDH, BFC					50 005 168
Reference	059 121 004 B	059 121 004 C	059 121 004 D	059 121 004 E		
	059 121 004 EX					

A4 2.6i**25**

11.1994→07.1998	ABC, ACZ					50 005 167
Reference	078 121 004 H	078 121 004 HV	078 121 004 HX	078 121 004 J		
	078 121 004 JV	078 121 004 JX	078 121 004 Q	078 121 004 QX		

078 121 006
ACZ: ch 4A-S-026 715→

04.1995→07.1997	ACZ					50 005 166
Reference	078 121 004 B	078 121 004 BV	078 121 004 BX	078 121 004 C		
	078 121 004 CV	078 121 004 CX				

→ch. 4A-S-026 714

A4 2.8i 24V**26**

11.1994→07.1997	AAH					50 005 167
Reference	078 121 004 H	078 121 004 HV	078 121 004 HX	078 121 004 J		
	078 121 004 JV	078 121 004 JX	078 121 004 Q	078 121 004 QX		

A4 2.8i 30V**27**







































































03.1996→09.2001	ACK, ALG, AMX, APR, AQD					50 005 167
Reference	078 121 004 H	078 121 004 HV	078 121 004 HX	078 121 004 J		
	078 121 004 JV	078 121 004 JX	078 121 004 Q	078 121 004 QX		

03.1996→12.1998	ACK					50 005 166
Reference	078 121 004 B	078 121 004 BV	078 121 004 BX	078 121 004 C		
	078 121 004 CV	078 121 004 CX				

A6 1.8i**28**

05.1997→05.2000	AFY, AJP					50 005 156
Reference	050 121 010	050 121 010 A	050 121 010 C	050 121 010 CX		
	mit Gegengehäuse/with backhousing/avec demi-corps/con remate/c задним корпусом					

**AUDI****A**

						
12.1997→07.1999	AJP					
Reference	06A 115 105 06A 115 105 B 06A 115 105 C 06A 115 105 D	06A 115 105 06A 115 105 B 06A 115 105 C 06A 115 105 D	06A 115 105 06A 115 105 B 06A 115 105 C 06A 115 105 D	06A 115 105 06A 115 105 B 06A 115 105 C 06A 115 105 D		
						
05.1997→05.2000	AFY, AJP					
Reference	026 121 005 F 026 121 005 L	026 121 005 FV	026 121 005 FX	026 121 005 K		
	 ohne Gegengehäuse/without backhousing/sans demi-corps/sin remate/без заднего корпуса					
A6 1.8i 20V					29	
10.1995→10.1997	ADR					
Reference	058 115 105 A 058 115 105 C	058 115 105 A 058 115 105 C	058 115 105 B	058 115 105 B		
						
10.1995→10.1997	ADR					
Reference	050 121 010	050 121 010 A	050 121 010 C	050 121 010 CX		
	 mit Gegengehäuse/with backhousing/avec demi-corps/con remate/с задним корпусом					
01.1999→04.2001	AQE, ARH					
Reference	06A 115 105 06A 115 105 B 06A 115 105 C 06A 115 105 D	06A 115 105 06A 115 105 B 06A 115 105 C 06A 115 105 D	06A 115 105 06A 115 105 B 06A 115 105 C 06A 115 105 D	06A 115 105 06A 115 105 B 06A 115 105 C 06A 115 105 D		
						
10.1995→10.1997	ADR					
Reference	026 121 005 F 026 121 005 L	026 121 005 FV	026 121 005 FX	026 121 005 K		
	 ohne Gegengehäuse/without backhousing/sans demi-corps/sin remate/без заднего корпуса					
A6 1.8i Turbo 20V					30	
04.1997→10.2000	AEB, AJL					
Reference	050 121 010	050 121 010 A	050 121 010 C	050 121 010 CX		
	 mit Gegengehäuse/with backhousing/avec demi-corps/con remate/с задним корпусом					
05.2000→01.2005	AWT					
Reference	06A 115 105 06A 115 105 B 06A 115 105 C 06A 115 105 D	06A 115 105 06A 115 105 B 06A 115 105 C 06A 115 105 D	06A 115 105 06A 115 105 B 06A 115 105 C 06A 115 105 D	06A 115 105 06A 115 105 B 06A 115 105 C 06A 115 105 D		
						
05.2000→01.2005	AWT					
						
04.1997→10.2000	AEB, AJL					
Reference	026 121 005 F 026 121 005 L	026 121 005 FV	026 121 005 FX	026 121 005 K		
	 ohne Gegengehäuse/without backhousing/sans demi-corps/sin remate/без заднего корпуса					
11.1998→05.2001	APU					
						



A6 1.9 TDI

31

07.1994→10.1997	1Z, AHU						
Reference	026 121 010 026 121 010 F 026 121 010 X 068 121 010 A	026 121 010 C 026 121 010 FV 037 121 010 068 121 010 AX	026 121 010 CV 026 121 010 FX 037 121 010 A	026 121 010 CX 026 121 010 V 037 121 010 AX			50 005 151
	mit Gegengehäuse/with backhousing/avec demi-corps/con remate/c задним корпусом						
07.1996→04.2001	AFN, AHU						
Reference	028 121 004	028 121 004 V	028 121 004 X				50 005 158
07.1994→06.1996	1Z						
Reference	028 115 105 J	028 115 105 J	068 115 105 BL	068 115 105 BL			50 005 866
07.1994→10.1997	1Z, AHU						
Reference	026 121 005 A 026 121 005 H	026 121 005 C 037 121 005 B	026 121 005 E 037 121 005 C	026 121 005 G 068 121 005 A			50 005 148
	ohne Gegengehäuse/without backhousing/sans demi-corps/sin remate/без заднего корпуса						
06.2001→01.2005	AVF, AWX						
Reference	038 121 011 G F4B-2-125 001→						50 005 783
01.1998→04.2001	AJM						
Reference	06A 115 105 06A 115 105 B 06A 115 105 C 06A 115 105 D	06A 115 105 06A 115 105 B 06A 115 105 C 06A 115 105 D	06A 115 105 06A 115 105 B 06A 115 105 C 06A 115 105 D	06A 115 105 06A 115 105 B 06A 115 105 C 06A 115 105 D			50 005 819
07.1994→04.2001	1Z, AFN, AHU, AVG						
Reference	028 115 105 M	028 115 105 M					50 005 867
01.1998→01.2005	AJM, AVF, AWX						
Reference	038 121 001 C 038 121 011J	038 121 011 C 038 121 011K	038 121 011 D 038 121 011KX	038 121 011G			50 005 554

A6 2.0i













32

06.1994→10.1997	AAE, ABK, ADW						
Reference	026 121 010 026 121 010 F 026 121 010 X 068 121 010 A	026 121 010 C 026 121 010 FV 037 121 010 068 121 010 AX	026 121 010 CV 026 121 010 FX 037 121 010 A	026 121 010 CX 026 121 010 V 037 121 010 AX			50 005 151
	mit Gegengehäuse/with backhousing/avec demi-corps/con remate/c задним корпусом						
06.1994→10.1997	AAE, ABK, ADW						
Reference	026 121 005 A 026 121 005 H	026 121 005 C 037 121 005 B	026 121 005 E 037 121 005 C	026 121 005 G 068 121 005 A			50 005 148
	ohne Gegengehäuse/without backhousing/sans demi-corps/sin remate/без заднего корпуса						





















AUDI

A

					
06.1994→10.1997 Reference	AAE, ABK, ADW 026 115 105 A 026 115 105 A			50 005 822	
A6 2.0i 16V					33
06.1994→10.1997 Reference	ACE 026 121 010 026 121 010 C 026 121 010 CV 026 121 010 CX 026 121 010 F 026 121 010 FV 026 121 010 FX 026 121 010 V 026 121 010 X 037 121 010 037 121 010 A 037 121 010 AX 068 121 010 A 068 121 010 AX mit Gegengehäuse/with backhousing/avec demi-corps/con remate/c задним корпусом			50 005 151	
06.1994→10.1997 Reference	ACE 026 121 005 A 026 121 005 C 026 121 005 E 026 121 005 G 026 121 005 H 037 121 005 B 037 121 005 C 068 121 005 A ohne Gegengehäuse/without backhousing/sans demi-corps/sin remate/без заднего корпуса			50 005 148	
06.1994→10.1997 Reference	ACE 053 115 105 B 053 115 105 B 053 115 105 C 053 115 105 C			50 005 845	
A6 2.0i 20V					34
06.2001→01.2005	ALT			50 005 130	
A6 2.2i Turbo 25V					35
07.1996→07.1997 Reference	AAN 054 121 004 054 121 004 A 054 121 004 AV 054 121 004 AX			50 005 550	
A6 2.3i					36
06.1994→06.1996 Reference	AAR 054 121 004 054 121 004 A 054 121 004 AV 054 121 004 AX			50 005 550	
A6 2.4i 30V					37
07.1995→01.2005 Reference	AFM, AGA, AJG, ALF, ALW, AML, AMM, APC, APS, APZ, ARJ, ASM, BDV 078 121 004 H 078 121 004 HV 078 121 004 HX 078 121 004 J 078 121 004 JV 078 121 004 JX 078 121 004 Q 078 121 004 QX 078 121 006			50 005 167	
A6 2.5 TDI					38
10.1994→10.1997 Reference	AEL 074 121 004 B 074 121 005 N 074 121 005 NX 074 121 005M 074 121 005MX 20 Zähne/teeth/dientes/dents/зубьев			50 005 555	



							
10.1994→10.1997 Reference 	AEL 074 121 004 074 121 004 A 074 121 004 V 074 121 004 X 18 Zähne/teeth/dientes/dents/зубьев						50 005 551
04.1997→08.2003 Reference	AFB, AKE, AKN, AYM 059 121 004 B 059 121 004 C 059 121 004 D 059 121 004 E 059 121 004 EX						50 005 168
A6 2.5 TDI 24V							39
07.2002→08.2005 Reference	BAU, BDG, BDH, BFC 059 121 004 B 059 121 004 C 059 121 004 D 059 121 004 E 059 121 004 EX						50 005 168
A6 2.6i							40
06.1994→10.1997 Reference 	ABC, ACZ 078 121 004 H 078 121 004 HV 078 121 004 HX 078 121 004 J 078 121 004 JV 078 121 004 JX 078 121 004 Q 078 121 004 QX 078 121 006 ch 4A-S-026 715→						50 005 167
06.1994→10.1997 Reference 	ABC, ACZ 078 121 004 B 078 121 004 BV 078 121 004 BX 078 121 004 C 078 121 004 CV 078 121 004 CX →ch. 4A-S-026 714						50 005 166
A6 2.7i Turbo 30V							41
02.1999→08.2000 Reference	AJK 078 121 004 H 078 121 004 HV 078 121 004 HX 078 121 004 J 078 121 004 JV 078 121 004 JX 078 121 004 Q 078 121 004 QX 078 121 006						50 005 167
02.1999→08.2005 Reference 	AJK, ARE, AZA, BES 078 121 004 L 078 121 004 R 078 121 006 A AJK: 8D-X-200 001→						50 005 905
A6 2.8i							42
06.1994→10.1997 Reference 	AEJ, AFC 078 121 004 H 078 121 004 HV 078 121 004 HX 078 121 004 J 078 121 004 JV 078 121 004 JX 078 121 004 Q 078 121 004 QX 078 121 006 ch 4A-S-026 715→						50 005 167
06.1994→10.1997 Reference 	AEJ, AFC 078 121 004 B 078 121 004 BV 078 121 004 BX 078 121 004 C 078 121 004 CV 078 121 004 CX →ch. 4A-S-026 714						50 005 166



A

**A6 2.8i 24V****43**

06.1994→10.1997

AAH

Reference

078 121 004 H 078 121 004 HV 078 121 004 HX 078 121 004 J
 078 121 004 JV 078 121 004 JX 078 121 004 Q 078 121 004 QX
 078 121 006
 ch 4A-S-026 715→

**50 005 167**

06.1994→10.1997

AAH

Reference

078 121 004 B 078 121 004 BV 078 121 004 BX 078 121 004 C
 078 121 004 CV 078 121 004 CX
 →ch. 4A-S-026 714

**50 005 166****A6 2.8i 30V****44**

10.1995→05.2001

ACK, AGE, ALG, AMX, APR, AQD

Reference

078 121 004 H 078 121 004 HV 078 121 004 HX 078 121 004 J
 078 121 004 JV 078 121 004 JX 078 121 004 Q 078 121 004 QX
 078 121 006

**50 005 167**

10.1995→01.1999

ACK

Reference

078 121 004 B 078 121 004 BV 078 121 004 BX 078 121 004 C
 078 121 004 CV 078 121 004 CX

**50 005 166****A6 3.0i 30V****45**

06.2001→05.2006

ASN, BBJ

Reference

06C 121 004 C 06C 121 004 G 06C 121 004 H 06C 121 004 HX

**50 005 771****A6 4.2i 40V****46**

04.1999→01.2005

ARS, ASG

Reference

077 121 004 M 077 121 004 N

**50 005 777****A6 Allroad 2.5 TDI 24V****47**

11.1999→08.2005

AKE, BAU

Reference

059 121 004 B 059 121 004 C 059 121 004 D 059 121 004 E
 059 121 004 EX

**50 005 168****A6 Allroad 2.7i Turbo 30V****48**

05.2000→08.2005

ARE, BES

Reference

078 121 004 L 078 121 004 R 078 121 006 A

**50 005 905**

**A8 2.5 TDI****49**

06.1997→09.2002	AFB, AKE, AKN							
Reference	059 121 004 B 059 121 004 EX	059 121 004 C	059 121 004 D	059 121 004 E				50 005 168

A8 2.8i**50**

06.1994→03.1996	AAH, AEJ							
Reference	078 121 004 H 078 121 004 JV 078 121 006 ch 4D-S-000 497→	078 121 004 HV 078 121 004 JX	078 121 004 HX 078 121 004 Q	078 121 004 J 078 121 004 QX				50 005 167
06.1994→03.1996	AAH, AEJ							
Reference	078 121 004 B 078 121 004 CV →ch. 4D-S-000 496	078 121 004 BV 078 121 004 CX	078 121 004 BX	078 121 004 C				50 005 166

A8 2.8i 30V**51**

07.1995→09.2002	ACK, ALG, AMX, APR, AQD							
Reference	078 121 004 H 078 121 004 JV 078 121 006	078 121 004 HV 078 121 004 JX	078 121 004 HX 078 121 004 Q	078 121 004 J 078 121 004 QX				50 005 167
07.1995→12.1998	ACK							
Reference	078 121 004 B 078 121 004 CV	078 121 004 BV 078 121 004 CX	078 121 004 BX	078 121 004 C				50 005 166

A8 3.0i 30 V**52**

07.2003→05.2006	ASN, BBJ							
Reference	06C 121 004 C	06C 121 004 G	06C 121 004 H	06C 121 004 HX				50 005 771

A8 3.7i 32V**53**

07.1995→12.1998	AEW, AKJ							
Reference	077 121 004 F	077 121 004 FV	077 121 004 FX	077 121 004 H				50 005 181

A8 3.7i 40V**54**

10.1998→09.2002	AKC, AQG							
Reference	077 121 004 M 4D-X-005 001→	077 121 004 N						50 005 777

A8 4.2i 32V**55**

06.1994→05.1999	ABZ, AEM, AGH, AKG							
Reference	077 121 004 F	077 121 004 FV	077 121 004 FX	077 121 004 H				50 005 181



A

**A8 4.2i 40V****56**

10.1998→09.2002

AQF, AUW

Reference

077 121 004 M

077 121 004 N

4D-X-005 001→

**50 005 777****RS4 2.7i 30V****57**

06.2000→09.2001

ASJ, AZR

Reference

078 121 004 L

078 121 004 R

078 121 006 A

**50 005 905****S2 2.2i Turbo 20V****58**

09.1990→05.1995

3B, ABY

Reference

054 121 004

054 121 004 A

054 121 004 AV

054 121 004 AX

**50 005 550****S3 1.8i Turbo 20V****59**

11.1998→06.2003

AMK, APY, BAM

Reference

06A 115 105

06A 115 105

06A 115 105

06A 115 105

06A 115 105 B

06A 115 105 B

06A 115 105 B

06A 115 105 B

06A 115 105 C

06A 115 105 C

06A 115 105 C

06A 115 105 C

06A 115 105 D

06A 115 105 D

06A 115 105 D

06A 115 105 D

**50 005 819**

11.1998→06.2003

AMK, APY, BAM

**50 005 131****S4 2.2i Turbo 25V****60**

08.1991→07.1994

AAN

Reference

054 121 004

054 121 004 A

054 121 004 AV

054 121 004 AX

**50 005 550****S4 2.7i 30V****61**

10.1997→09.2001

AGB

Reference

078 121 004 H

078 121 004 HV

078 121 004 HX

078 121 004 J

078 121 004 JV

078 121 004 JX

078 121 004 Q

078 121 004 QX

078 121 006

**50 005 167**

10.1997→09.2001

AGB, AZB

Reference

078 121 004 L

078 121 004 R

078 121 006 A

8D-X-200 001→

**50 005 905**

**S6 2.2i Turbo 25V****62**

06.1994→07.1997

AAN

Reference

054 121 004

054 121 004 A

054 121 004 AV

054 121 004 AX



50 005 550

S6 4.2i 32V**63**

09.1994→10.1997

AEC, AHK

Reference

077 121 004 F

077 121 004 FV

077 121 004 FX

077 121 004 H



50 005 181

S6 4.2i 40V**64**

09.1999→01.2005

ANK, AQJ

Reference

077 121 004 M

077 121 004 N



50 005 777

S8 4.2i 32V**65**

09.1996→12.1998

AHC, AKH

Reference

077 121 004 F

077 121 004 FV

077 121 004 FX

077 121 004 H



50 005 181

S8 4.2i 40V**66**

05.1999→09.2002

AQH, AVP, BCS

Reference

077 121 004 M

077 121 004 N

4D-X-005 001→



50 005 777

Cabriolet 1.8i 20V**67**

04.1997→08.2000

ADR

Reference

058 115 105 A

058 115 105 A

058 115 105 B

058 115 105 B

058 115 105 C

058 115 105 C



50 005 811

04.1997→08.2000

ADR

Reference

050 121 010

050 121 010 A

050 121 010 C

050 121 010 CX

mit Gegengehäuse/with backhousing/avec demi-corps/con remate/c задним корпусом



50 005 156

04.1997→08.2000

ADR

Reference

026 121 005 F

026 121 005 FV

026 121 005 FX

026 121 005 K

026 121 005 L

ohne Gegengehäuse/without backhousing/sans demi-corps/sin remate/без заднего корпуса



50 005 155

Cabriolet 1.9 TDI**68**

07.1995→08.2000

1Z, AHU

Reference

026 121 010

026 121 010 C

026 121 010 CV

026 121 010 CX

026 121 010 F

026 121 010 FV

026 121 010 FX

026 121 010 V

026 121 010 X

037 121 010

037 121 010 A

037 121 010 AX

068 121 010 A













068 121 010 AX

mit Gegengehäuse/with backhousing/avec demi-corps/con remate/c задним корпусом



50 005 151

**AUDI****A**

				
07.1995→08.2000 Reference	1Z, AHU 026 121 005 A 026 121 005 C 026 121 005 E 026 121 005 G 026 121 005 H 037 121 005 B 037 121 005 C 068 121 005 A ohne Gegengehäuse/without backhousing/sans demi-corps/sin remate/без заднего корпуса			50 005 148
07.1995→08.2000 Reference	1Z, AHU 028 115 105 M 028 115 105 M		50 005 867	
Cabriolet 2.0i				69
01.1993→09.1998 Reference	ABK 026 121 010 026 121 010 C 026 121 010 CV 026 121 010 CX 026 121 010 F 026 121 010 FV 026 121 010 FX 026 121 010 V 026 121 010 X 037 121 010 037 121 010 A 037 121 010 AX 068 121 010 A 068 121 010 AX mit Gegengehäuse/with backhousing/avec demi-corps/con remate/с задним корпусом			50 005 151
01.1993→09.1998 Reference	ABK 026 121 005 A 026 121 005 C 026 121 005 E 026 121 005 G 026 121 005 H 037 121 005 B 037 121 005 C 068 121 005 A ohne Gegengehäuse/without backhousing/sans demi-corps/sin remate/без заднего корпуса			50 005 148
01.1993→09.1998 Reference	ABK 026 115 105 A 026 115 105 A		50 005 822	
Cabriolet 2.0i 16V				70
05.1995→07.1996 Reference	ACE 026 121 010 026 121 010 C 026 121 010 CV 026 121 010 CX 026 121 010 F 026 121 010 FV 026 121 010 FX 026 121 010 V 026 121 010 X 037 121 010 037 121 010 A 037 121 010 AX 068 121 010 A 068 121 010 AX mit Gegengehäuse/with backhousing/avec demi-corps/con remate/с задним корпусом			50 005 151
05.1995→07.1996 Reference	ACE 026 121 005 A 026 121 005 C 026 121 005 E 026 121 005 G 026 121 005 H 037 121 005 B 037 121 005 C 068 121 005 A ohne Gegengehäuse/without backhousing/sans demi-corps/sin remate/без заднего корпуса			50 005 148
05.1995→07.1996 Reference	ACE 053 115 105 B 053 115 105 B 053 115 105 C 053 115 105 C		50 005 845	
Cabriolet 2.3i				71
06.1991→07.1994 Reference	NG 054 121 004 054 121 004 A 054 121 004 AV 054 121 004 AX			50 005 550

**Cabriolet 2.6i**

72

01.1994→08.2000	ABC, ACZ						
Reference	078 121 004 H 078 121 004 JV 078 121 006	078 121 004 HV 078 121 004 JX	078 121 004 HX 078 121 004 Q	078 121 004 J 078 121 004 QX			50 005 167
	ABC: ch 8G-S-001 302→ ACZ: ch 8G-S-001 303→						
01.1994→08.2000	ABC, ACZ						
Reference	078 121 004 B 078 121 004 CV	078 121 004 BV 078 121 004 CX	078 121 004 BX	078 121 004 C			50 005 166
	→ch. 8G-S-001 302						

Cabriolet 2.8i

73

11.1992→08.2000	AAH						
Reference	078 121 004 H 078 121 004 JV 078 121 006	078 121 004 HV 078 121 004 JX	078 121 004 HX 078 121 004 Q	078 121 004 J 078 121 004 QX			50 005 167
	ch 8G-S-001 303→						
11.1992→08.2000	AAH						
Reference	078 121 004 B 078 121 004 CV	078 121 004 BV 078 121 004 CX	078 121 004 BX	078 121 004 C			50 005 166
	→ch. 8G-S-001 302						

Coupé 1.6

74

01.1981→07.1981	YN						
Reference	026 121 010 026 121 010 F 026 121 010 X 068 121 010 A	026 121 010 C 026 121 010 FV 037 121 010 068 121 010 AX	026 121 010 CV 026 121 010 FX 037 121 010 A	026 121 010 CX 026 121 010 V 037 121 010 AX			50 005 151
	mit Gegengehäuse/with backhousing/avec demi-corps/con remate/c задним корпусом						
01.1981→07.1981	YN						
Reference	026 115 105 049 115 105 H	026 115 105 049 115 105 H	026 115 105 B 056 115 105 A	026 115 105 B 056 115 105 A		50 005 813	
01.1981→07.1981	YN						
Reference	026 121 005 A 026 121 005 H	026 121 005 C 037 121 005 B	026 121 005 E 037 121 005 C	026 121 005 G 068 121 005 A			50 005 148
	ohne Gegengehäuse/without backhousing/sans demi-corps/sin remate/без заднего корпуса						

Coupé 1.8























75

08.1981→07.1988	DD, DS, JN, JV, SF						
Reference	026 121 010 026 121 010 F 026 121 010 X 068 121 010 A	026 121 010 C 026 121 010 FV 037 121 010 068 121 010 AX	026 121 010 CV 026 121 010 FX 037 121 010 A	026 121 010 CX 026 121 010 V 037 121 010 AX			50 005 151
	mit Gegengehäuse/with backhousing/avec demi-corps/con remate/c задним корпусом						
08.1981→07.1988	DD, DS, JN, JV, SF						
Reference	026 115 105 049 115 105 H	026 115 105 049 115 105 H	026 115 105 B 056 115 105 A	026 115 105 B 056 115 105 A		50 005 813	



AUDI

A

 08.1981→07.1988 Reference 	 DD, DS, JN, JV, SF 026 121 005 A 026 121 005 C 026 121 005 E 026 121 005 G 026 121 005 H 037 121 005 B 037 121 005 C 068 121 005 A ohne Gegengehäuse/without backhousing/sans demi-corps/sin remate/без заднего корпуса		 	50 005 148
Coupé 1.8i				76
02.1986→07.1991 Reference 	DZ, PV, SF 026 121 010 026 121 010 C 026 121 010 CV 026 121 010 CX 026 121 010 F 026 121 010 FV 026 121 010 FX 026 121 010 V 026 121 010 X 037 121 010 037 121 010 A 037 121 010 AX 068 121 010 A 068 121 010 AX mit Gegengehäuse/with backhousing/avec demi-corps/con remate/с задним корпусом			50 005 151
02.1986→07.1991 Reference 	DZ, PV, SF 026 115 105 026 115 105 026 115 105 B 026 115 105 B 049 115 105 H 049 115 105 H 056 115 105 A 056 115 105 A		50 005 813	
02.1986→07.1991 Reference 	DZ, PV, SF 026 121 005 A 026 121 005 C 026 121 005 E 026 121 005 G 026 121 005 H 037 121 005 B 037 121 005 C 068 121 005 A ohne Gegengehäuse/without backhousing/sans demi-corps/sin remate/без заднего корпуса			50 005 148
Coupé 1.9i				77
10.1980→07.1983 Reference 	WN 035 121 004 035 121 004 A 035 121 004 AV 035 121 004 AX 035 121 004 X 035 121 005 035 121 005 B 035 121 005 E			50 005 145
Coupé 2.0i				78
05.1989→12.1995 Reference 	3A, 6A, AAD, ABK 026 121 010 026 121 010 C 026 121 010 CV 026 121 010 CX 026 121 010 F 026 121 010 FV 026 121 010 FX 026 121 010 V 026 121 010 X 037 121 010 037 121 010 A 037 121 010 AX 068 121 010 A 068 121 010 AX mit Gegengehäuse/with backhousing/avec demi-corps/con remate/с задним корпусом			50 005 151
08.1983→07.1988 Reference 	HP, JL, JS, SK 035 121 004 035 121 004 A 035 121 004 AV 035 121 004 AX 035 121 004 X 035 121 005 035 121 005 B 035 121 005 E			50 005 145
05.1989→12.1995 Reference 	3A, 6A, AAD, ABK 026 121 005 A 026 121 005 C 026 121 005 E 026 121 005 G 026 121 005 H 037 121 005 B 037 121 005 C 068 121 005 A ohne Gegengehäuse/without backhousing/sans demi-corps/sin remate/без заднего корпуса			50 005 148
05.1989→12.1995 Reference 	3A, AAD, ABK 026 115 105 A 026 115 105 A		50 005 822	



01.1992→07.1992 Reference	6A 053 115 105 B	053 115 105 B	053 115 105 C	053 115 105 C		50 005 845	
Coupé 2.0i 16V							79
08.1992→12.1995 Reference	ACE 026 121 010 026 121 010 F 026 121 010 X 068 121 010 A	026 121 010 C 026 121 010 FV 037 121 010 068 121 010 AX	026 121 010 CV 026 121 010 FX 037 121 010 A	026 121 010 CX 026 121 010 V 037 121 010 AX		50 005 151	
	mit Gegengehäuse/with backhousing/avec demi-corps/con remate/c задним корпусом						
08.1992→12.1995 Reference	026 121 005 A 026 121 005 H	026 121 005 C 037 121 005 B	026 121 005 E 037 121 005 C	026 121 005 G 068 121 005 A		50 005 148	
	ohne Gegengehäuse/without backhousing/sans demi-corps/sin remate/без заднего корпуса						
08.1992→12.1995 Reference	053 115 105 B	053 115 105 B	053 115 105 C	053 115 105 C		50 005 845	
Coupé 2.0i 20V							80
11.1988→07.1991 Reference	NM 034 121 004 034 121 005 D →ch. 88-M-033 000	034 121 004 A	034 121 004 V	034 121 004 X		50 005 149	
11.1988→07.1991 Reference	NM 054 121 004 ch 88-M-033 001→	054 121 004 A	054 121 004 AV	054 121 004 AX		50 005 550	
Coupé 2.1i							81
04.1981→07.1982 Reference	WE 035 121 004 035 121 004 X	035 121 004 A 035 121 005	035 121 004 AV 035 121 005 B	035 121 004 AX 035 121 005 E		50 005 145	
Coupé 2.2i							82
08.1981→07.1991 Reference	HY, JT, KE, KL, KV, KX 035 121 004 035 121 004 X KV: →ch. 89-J-394 742	035 121 004 A 035 121 005	035 121 004 AV 035 121 005 B	035 121 004 AX 035 121 005 E		50 005 145	
08.1984→07.1991 Reference	KV 034 121 004 034 121 005 D ch 89-J-394 743→	034 121 004 A	034 121 004 V	034 121 004 X		50 005 149	



AUDI

A

**Coupé 2.2i Turbo 20V****83**

05.1995→12.1995

ABY

Reference

054 121 004

054 121 004 A

054 121 004 AV

054 121 004 AX



50 005 550

Coupé 2.3i**84**

08.1986→07.1994

NG

Reference

035 121 004

035 121 004 A

035 121 004 AV

035 121 004 AX

035 121 004 X

035 121 005

035 121 005 B

035 121 005 E

→07.1988



50 005 145

08.1986→07.1994

NG

Reference

034 121 004

034 121 004 A

034 121 004 V

034 121 004 X

034 121 005 D

08.1988→



50 005 149

Coupé 2.3i 20V**85**

11.1988→07.1991

7A

Reference

034 121 004

034 121 004 A

034 121 004 V

034 121 004 X

034 121 005 D

→ch. 88-M-033 000



50 005 149

11.1988→07.1991

7A

Reference

054 121 004

054 121 004 A

054 121 004 AV

054 121 004 AX

ch 88-M-033 001→



50 005 550

Coupé 2.6i**86**

08.1992→12.1995

ABC

Reference

078 121 004 H

078 121 004 HV

078 121 004 HX

078 121 004 J

078 121 004 JV

078 121 004 JX

078 121 004 Q

078 121 004 QX

078 121 006

ch 8B-S-000 545→



50 005 167

08.1992→12.1995

ABC

Reference

078 121 004 B

078 121 004 BV

078 121 004 BX

078 121 004 C

078 121 004 CV

078 121 004 CX

→ch. 8B-S-000 544



50 005 166

Coupé 2.8i**87**

08.1991→12.1995

AAH

Reference

078 121 004 H

078 121 004 HV

078 121 004 HX

078 121 004 J

078 121 004 JV

078 121 004 JX

078 121 004 Q

078 121 004 QX

078 121 006

ch 8B-S-000 545→



50 005 167

08.1991→12.1995

AAH

Reference

078 121 004 B

078 121 004 BV

078 121 004 BX

078 121 004 C

078 121 004 CV









078 121 004 CX

→ch. 8B-S-000 544



50 005 166



Fox 1.3					88
09.1978→1981	FY, HH				
Reference	052 121 004 052 121 005 A	052 121 004 V 052 121 005 AX	052 121 004 X 052 121 019	052 121 005	 50 005 142
Fox 1.6					89
09.1975→07.1981	YN				
Reference	026 121 010 026 121 010 F 026 121 010 X 068 121 010 A	026 121 010 C 026 121 010 FV 037 121 010 068 121 010 AX	026 121 010 CV 026 121 010 FX 037 121 010 A	026 121 010 CX 026 121 010 V 037 121 010 AX	 50 005 151
	mit Gegengehäuse/with backhousing/avec demi-corps/con remate/c задним корпусом 01.1982→12.1983				
09.1974→07.1981	YG, YH, YK, YN				
Reference	056 121 005 068 121 005 C	056 121 005 A 068 121 005 X	068 121 005	068 121 005 B	 50 005 140
	ohne Gegengehäuse/without backhousing/sans demi-corps/sin remate/без заднего корпуса YN: 01.1973→12.1981				
09.1975→07.1981	YN				
Reference	026 121 005 A 026 121 005 H	026 121 005 C 037 121 005 B	026 121 005 E 037 121 005 C	026 121 005 G 068 121 005 A	 50 005 148
	ohne Gegengehäuse/without backhousing/sans demi-corps/sin remate/без заднего корпуса 01.1982→12.1983				
09.1974→07.1981	YG, YH, YK, YN				
Reference	026 121 010 A 026 121 010 DX 056 121 013 A	026 121 010 AV 055 121 010 068 121 010	026 121 010 D 055 121 010 X	026 121 010 DV 056 121 011	 50 005 150
	mit Gegengehäuse/with backhousing/avec demi-corps/con remate/c задним корпусом YN: 01.1973→12.1981				
Quattro 2.2i Turbo 20V					90
07.1980→07.1989	GV, WR, WX				
Reference	035 121 004 035 121 004 X	035 121 004 A 035 121 005	035 121 004 AV 035 121 005 B	035 121 004 AX 035 121 005 E	 50 005 145
	→ch. 85-J-900 643				
07.1980→07.1991	GV, RR, WR, WX				
Reference	034 121 004 034 121 005 D	034 121 004 A	034 121 004 V	034 121 004 X	 50 005 149
	GV, WR, WX: ch 85-J-900 644→				
Quattro 2.2i Turbo 25V					91
08.1987→07.1988	MB				
Reference	035 121 004 035 121 004 X	035 121 004 A 035 121 005	035 121 004 AV 035 121 005 B	035 121 004 AX 035 121 005 E	 50 005 145
	→ch. 85-J-900 643				
08.1987→07.1988	MB				
Reference	034 121 004 034 121 005 D	034 121 004 A	034 121 004 V	034 121 004 X	 50 005 149
	ch 85-J-900 644→				



AUDI

A

**TT 1.8i Turbo 20V****92**

10.1998→06.2006 AJQ, APP, APX, ARY, AUM, AUQ, BAM, BFV, BVP, BVR

Reference	06A 115 105	06A 115 105	06A 115 105	06A 115 105
	06A 115 105 B	06A 115 105 B	06A 115 105 B	06A 115 105 B
	06A 115 105 C	06A 115 105 C	06A 115 105 C	06A 115 105 C
	06A 115 105 D	06A 115 105 D	06A 115 105 D	06A 115 105 D

**50 005 819**

10.1998→06.2006 AJQ, APP, APX, ARY, AUM, AUQ, BAM

**50 005 131****TT 3.2i 24V****93**

07.2003→ BHE, BPF, BUB

Reference 022 121 011

50 005 008**NEW****50 1.1****94**

08.1974→07.1978 HB, HC, HD

Reference	052 121 004	052 121 004 V	052 121 004 X	052 121 005
	052 121 005 A	052 121 005 AX	052 121 019	

**50 005 142****50 1.3****95**

08.1977→07.1978 HH

Reference	052 121 004	052 121 004 V	052 121 004 X	052 121 005
	052 121 005 A	052 121 005 AX	052 121 019	

**50 005 142****80 1.3****96**

08.1981→03.1987 EP

Reference	026 121 010	026 121 010 C	026 121 010 CV	026 121 010 CX
	026 121 010 F	026 121 010 FV	026 121 010 FX	026 121 010 V
	026 121 010 X	037 121 010	037 121 010 A	037 121 010 AX
	068 121 010 A	068 121 010 AX		

mit Gegengehäuse/with backhousing/avec demi-corps/con remate/c задним корпусом

**50 005 151**

05.1972→07.1978 ZA, ZF

Reference	056 121 005	056 121 005 A	068 121 005	068 121 005 B
	068 121 005 C	068 121 005 X		



ohne Gegengehäuse/without backhousing/sans demi-corps/sin remate/без заднего корпуса

**50 005 140**

08.1981→03.1987 EP

Reference	026 115 105	026 115 105	026 115 105 B	026 115 105 B
	049 115 105 H	049 115 105 H	056 115 105 A	056 115 105 A

**50 005 813**

08.1981→03.1987 EP

Reference	026 121 005 A	026 121 005 C	026 121 005 E	026 121 005 G
	026 121 005 H	037 121 005 B	037 121 005 C	068 121 005 A



ohne Gegengehäuse/without backhousing/sans demi-corps/sin remate/без заднего корпуса

**50 005 148**

08.1978→07.1981 FY, FZ

Reference	052 121 004	052 121 004 V	052 121 004 X	052 121 005
	052 121 005 A	052 121 005 AX	052 121 019	

**50 005 142**



05.1972→07.1978 Reference	ZA, ZF	026 121 010 A 026 121 010 DX 056 121 013 A	026 121 010 AV 055 121 010 068 121 010	026 121 010 D 055 121 010 X	026 121 010 DV 056 121 011	 50 005 150
	mit Gegengehäuse/with backhousing/avec demi-corps/con remate/c задним корпусом					
80 1.5					97	
05.1972→07.1976 Reference	YJ, ZB, ZC	056 121 005 068 121 005 C	056 121 005 A 068 121 005 X	068 121 005	068 121 005 B	 50 005 140
	ohne Gegengehäuse/without backhousing/sans demi-corps/sin remate/без заднего корпуса					
05.1972→07.1976 Reference	YJ, ZB, ZC	026 121 010 A 026 121 010 DX 056 121 013 A	026 121 010 AV 055 121 010 068 121 010	026 121 010 D 055 121 010 X	026 121 010 DV 056 121 011	 50 005 150
	mit Gegengehäuse/with backhousing/avec demi-corps/con remate/c задним корпусом					
80 1.6					98	
09.1975→12.1991 Reference	DT, JU, PP, RN, SA, WV, WY, YN, YP, YY	026 121 010 026 121 010 F 026 121 010 X 068 121 010 A	026 121 010 C 026 121 010 FV 037 121 010 068 121 010 AX	026 121 010 CV 026 121 010 FX 037 121 010 A	026 121 010 CX 026 121 010 V 037 121 010 AX	 50 005 151
	mit Gegengehäuse/with backhousing/avec demi-corps/con remate/c задним корпусом WY: 05.1981→ WV, YN, YP, YY: ch 81-B-149 001→					
09.1975→07.1983 Reference	WV, WY, WZ, YG, YH, YK, YN, YP, YT, YY	056 121 005 068 121 005 C	056 121 005 A 068 121 005 X	068 121 005	068 121 005 B	 50 005 140
	ohne Gegengehäuse/without backhousing/sans demi-corps/sin remate/без заднего корпуса WY: 01.1975→04.1981 WV, YN, YP, YY: →ch. 81-B-149 000					
09.1975→12.1991 Reference	DT, JU, PP, RN, SA, WV, WY, YP	026 115 105 049 115 105 H	026 115 105 049 115 105 H	026 115 105 B 056 115 105 A	026 115 105 B 056 115 105 A	 50 005 813
09.1975→12.1991 Reference	DT, JU, PP, RN, SA, WV, WY, YN, YP, YY	026 121 005 A 026 121 005 H	026 121 005 C 037 121 005 B	026 121 005 E 037 121 005 C	026 121 005 G 068 121 005 A	 50 005 148
	ohne Gegengehäuse/without backhousing/sans demi-corps/sin remate/без заднего корпуса WY: 05.1981→ WV, YN, YP, YY: ch 81-B-149 001→					
09.1975→07.1983 Reference	WV, WY, WZ, YG, YH, YK, YN, YP, YT, YY	026 121 010 A 026 121 010 DX 056 121 013 A	026 121 010 AV 055 121 010 068 121 010	026 121 010 D 055 121 010 X	026 121 010 DV 056 121 011	 50 005 150
	mit Gegengehäuse/with backhousing/avec demi-corps/con remate/c задним корпусом WY: →04.1981 WV, YN, YP, YY: →ch. 81-B-149 000					



















**AUDI****A****80 1.6i****99**

08.1978→07.1995	ABB, ABM, ADA, YZ					50 005 151
Reference	026 121 010 026 121 010 F 026 121 010 X 068 121 010 A	026 121 010 C 026 121 010 FV 037 121 010 068 121 010 AX	026 121 010 CV 026 121 010 FX 037 121 010 A	026 121 010 CX 026 121 010 V 037 121 010 AX		
	mit Gegengehäuse/with backhousing/avec demi-corps/con remate/с задним корпусом YZ: ch 81-B-149 001→					
09.1973→07.1982	FS, XX, YS, YZ					50 005 140
Reference	056 121 005 068 121 005 C	056 121 005 A 068 121 005 X	068 121 005	068 121 005 B		
	ohne Gegengehäuse/without backhousing/sans demi-corps/sin remate/без заднего корпуса YZ: →ch. 81-B-149 000					
09.1975→07.1995	ABB, ABM, ADA, YS, YZ					50 005 813
Reference	026 115 105 049 115 105 H	026 115 105 049 115 105 H	026 115 105 B 056 115 105 A	026 115 105 B 056 115 105 A		
08.1978→07.1995	ABB, ABM, ADA, YZ					50 005 148
Reference	026 121 005 A 026 121 005 H	026 121 005 C 037 121 005 B	026 121 005 E 037 121 005 C	026 121 005 G 068 121 005 A		
	ohne Gegengehäuse/without backhousing/sans demi-corps/sin remate/без заднего корпуса YZ: ch 81-B-149 001→					
09.1973→07.1982	FS, XX, YS, YZ					50 005 150
Reference	026 121 010 A 026 121 010 DX 056 121 013 A	026 121 010 AV 055 121 010 068 121 010	026 121 010 D 055 121 010 X	026 121 010 DV 056 121 011		
	mit Gegengehäuse/with backhousing/avec demi-corps/con remate/с задним корпусом YZ: →ch. 81-B-149 000					













80 1.6 D**100**

08.1980→07.1989	CR, JK					50 005 151
Reference	026 121 010 026 121 010 F 026 121 010 X 068 121 010 A	026 121 010 C 026 121 010 FV 037 121 010 068 121 010 AX	026 121 010 CV 026 121 010 FX 037 121 010 A	026 121 010 CX 026 121 010 V 037 121 010 AX		
	mit Gegengehäuse/with backhousing/avec demi-corps/con remate/с задним корпусом CR: ch 81-B-149 001→					
08.1980→07.1982	CR					50 005 140
Reference	056 121 005 068 121 005 C	056 121 005 A 068 121 005 X	068 121 005	068 121 005 B		
	ohne Gegengehäuse/without backhousing/sans demi-corps/sin remate/без заднего корпуса →ch. 81-B-149 000					
08.1980→07.1989	CR, JK					50 005 148
Reference	026 121 005 A 026 121 005 H	026 121 005 C 037 121 005 B	026 121 005 E 037 121 005 C	026 121 005 G 068 121 005 A		
	ohne Gegengehäuse/without backhousing/sans demi-corps/sin remate/без заднего корпуса CR: ch 81-B-149 001→					
08.1980→07.1982	CR					50 005 150
Reference	026 121 010 A 026 121 010 DX 056 121 013 A	026 121 010 AV 055 121 010 068 121 010	026 121 010 D 055 121 010 X	026 121 010 DV 056 121 011		
	mit Gegengehäuse/with backhousing/avec demi-corps/con remate/с задним корпусом →ch. 81-B-149 000					



						
08.1980→07.1989	CR, JK					
Reference	068 115 105 AC 068 115 105 AP 068 115 105 R	068 115 105 AC 068 115 105 AP 068 115 105 R	068 115 105 AD 068 115 105 N	068 115 105 AD 068 115 105 N		50 005 804
80 1.6 TD					101	
02.1982→12.1991	CY, RA, SB					
Reference	026 121 010 026 121 010 F 026 121 010 X 068 121 010 A	026 121 010 C 026 121 010 FV 037 121 010 068 121 010 AX	026 121 010 CV 026 121 010 FX 037 121 010 A	026 121 010 CX 026 121 010 V 037 121 010 AX		50 005 151
	mit Gegengehäuse/with backhousing/avec demi-corps/con remate/c задним корпусом CY: 08.1984→07.1986					
04.1988→12.1991	RA, SB					
Reference	028 115 105 J SB: 01.1990→ RA: 89-H-300 001→ SB: →12.1989, 89-H-300 001→	028 115 105 J	068 115 105 BL	068 115 105 BL		50 005 866
						
02.1982→12.1991	CY, RA, SB					
Reference	026 121 005 A 026 121 005 H	026 121 005 C 037 121 005 B	026 121 005 E 037 121 005 C	026 121 005 G 068 121 005 A		50 005 148
	ohne Gegengehäuse/without backhousing/sans demi-corps/sin remate/без заднего корпуса CY: 08.1984→07.1986					
02.1982→03.1987	CY					
Reference	068 115 105 AC 068 115 105 AP 068 115 105 R	068 115 105 AC 068 115 105 AP 068 115 105 R	068 115 105 AD 068 115 105 N	068 115 105 AD 068 115 105 N		50 005 804
80 1.7					102	
08.1980→07.1983	WT					
Reference	026 121 010 026 121 010 F 026 121 010 X 068 121 010 A	026 121 010 C 026 121 010 FV 037 121 010 068 121 010 AX	026 121 010 CV 026 121 010 FX 037 121 010 A	026 121 010 CX 026 121 010 V 037 121 010 AX		50 005 151
	mit Gegengehäuse/with backhousing/avec demi-corps/con remate/c задним корпусом ch 81-B-149 001→					
08.1980→07.1983	WT					
Reference	056 121 005 068 121 005 C	056 121 005 A 068 121 005 X	068 121 005	068 121 005 B		50 005 140
	ohne Gegengehäuse/without backhousing/sans demi-corps/sin remate/без заднего корпуса →ch. 81-B-149 000					
08.1980→07.1983	WT					
Reference	026 115 105 049 115 105 H	026 115 105 049 115 105 H	026 115 105 B 056 115 105 A	026 115 105 B 056 115 105 A		50 005 813
08.1980→07.1983	WT					
Reference	026 121 005 A 026 121 005 H	026 121 005 C 037 121 005 B	026 121 005 E 037 121 005 C	026 121 005 G 068 121 005 A		50 005 148
	ohne Gegengehäuse/without backhousing/sans demi-corps/sin remate/без заднего корпуса ch 81-B-149 001→					

**AUDI****A**

	 			
08.1980→07.1983 Reference	WT 026 121 010 A 026 121 010 AV 026 121 010 D 026 121 010 DV 026 121 010 DX 055 121 010 055 121 010 X 056 121 011 056 121 013 A 068 121 010 mit Gegengehäuse/with backhousing/avec demi-corps/con remate/c задним корпусом →ch. 81-B-149 000			50 005 150
80 1.8				103
01.1983→12.1991 Reference	DS, JN, JV, NE, RU, SF 026 121 010 026 121 010 C 026 121 010 CV 026 121 010 CX 026 121 010 F 026 121 010 FV 026 121 010 FX 026 121 010 V 026 121 010 X 037 121 010 037 121 010 A 037 121 010 AX 068 121 010 A 068 121 010 AX mit Gegengehäuse/with backhousing/avec demi-corps/con remate/c задним корпусом			50 005 151
01.1983→12.1991 Reference	DS, JN, JV, NE, RU, SF 026 115 105 026 115 105 026 115 105 B 026 115 105 B 049 115 105 H 049 115 105 H 056 115 105 A 056 115 105 A		50 005 813	
01.1983→12.1991 Reference	DS, JN, JV, NE, RU, SF 026 121 005 A 026 121 005 C 026 121 005 E 026 121 005 G 026 121 005 H 037 121 005 B 037 121 005 C 068 121 005 A ohne Gegengehäuse/without backhousing/sans demi-corps/sin remate/без заднего корпуса			50 005 148
80 1.8i				104
01.1983→12.1991 Reference	DZ, MU, PM, PV 026 121 010 026 121 010 C 026 121 010 CV 026 121 010 CX 026 121 010 F 026 121 010 FV 026 121 010 FX 026 121 010 V 026 121 010 X 037 121 010 037 121 010 A 037 121 010 AX 068 121 010 A 068 121 010 AX mit Gegengehäuse/with backhousing/avec demi-corps/con remate/c задним корпусом			50 005 151
01.1983→12.1991 Reference	DZ, MU, PM 026 115 105 026 115 105 026 115 105 B 026 115 105 B 049 115 105 H 049 115 105 H 056 115 105 A 056 115 105 A		50 005 813	
01.1983→12.1991 Reference	DZ, MU, PM, PV 026 121 005 A 026 121 005 C 026 121 005 E 026 121 005 G 026 121 005 H 037 121 005 B 037 121 005 C 068 121 005 A ohne Gegengehäuse/without backhousing/sans demi-corps/sin remate/без заднего корпуса			50 005 148
80 1.9i				105
09.1986→07.1988 Reference	SD 026 121 010 026 121 010 C 026 121 010 CV 026 121 010 CX 026 121 010 F 026 121 010 FV 026 121 010 FX 026 121 010 V 026 121 010 X 037 121 010 037 121 010 A 037 121 010 AX 068 121 010 A 068 121 010 AX mit Gegengehäuse/with backhousing/avec demi-corps/con remate/c задним корпусом			50 005 151
08.1981→07.1983 Reference	WN 035 121 004 035 121 004 A 035 121 004 AV 035 121 004 AX 035 121 004 X 035 121 005 035 121 005 B 035 121 005 E			50 005 145





















09.1986→07.1988	SD				
Reference	026 121 005 A 026 121 005 C 026 121 005 E 026 121 005 G 026 121 005 H 037 121 005 B 037 121 005 C 068 121 005 A				50 005 148
	ohne Gegengehäuse/without backhousing/sans demi-corps/sin remate/без заднего корпуса				
09.1986→07.1988	SD				
Reference	026 115 105 A 026 115 105 A				50 005 822
	89-H-300 001→				
80 1.9 D					106
08.1989→12.1991	1Y				
Reference	026 121 010 026 121 010 C 026 121 010 CV 026 121 010 CX 026 121 010 F 026 121 010 FV 026 121 010 FX 026 121 010 V 026 121 010 X 037 121 010 037 121 010 A 037 121 010 AX 068 121 010 A 068 121 010 AX				50 005 151
	mit Gegengehäuse/with backhousing/avec demi-corps/con remate/c задним корпусом				
08.1989→12.1991	1Y				
Reference	028 115 105 J 028 115 105 J 068 115 105 BL 068 115 105 BL				50 005 866
08.1989→12.1991	1Y				
Reference	026 121 005 A 026 121 005 C 026 121 005 E 026 121 005 G 026 121 005 H 037 121 005 B 037 121 005 C 068 121 005 A				50 005 148
	ohne Gegengehäuse/without backhousing/sans demi-corps/sin remate/без заднего корпуса				
80 1.9 TD					107
09.1991→07.1995	AAZ				
Reference	026 121 010 026 121 010 C 026 121 010 CV 026 121 010 CX 026 121 010 F 026 121 010 FV 026 121 010 FX 026 121 010 V 026 121 010 X 037 121 010 037 121 010 A 037 121 010 AX 068 121 010 A 068 121 010 AX				50 005 151
	mit Gegengehäuse/with backhousing/avec demi-corps/con remate/c задним корпусом				
09.1991→07.1995	AAZ				
Reference	028 115 105 J 028 115 105 J 068 115 105 BL 068 115 105 BL				50 005 866
	AAZ: 01.1994→ AAZ: →12.1993, 8C-N-000 001→8C-N-300 000				
09.1991→07.1995	AAZ				
Reference	026 121 005 A 026 121 005 C 026 121 005 E 026 121 005 G 026 121 005 H 037 121 005 B 037 121 005 C 068 121 005 A				50 005 148
	ohne Gegengehäuse/without backhousing/sans demi-corps/sin remate/без заднего корпуса				
80 1.9 TDI					108
09.1991→07.1995	1Z				
Reference	026 121 010 026 121 010 C 026 121 010 CV 026 121 010 CX 026 121 010 F 026 121 010 FV 026 121 010 FX 026 121 010 V 026 121 010 X 037 121 010 037 121 010 A 037 121 010 AX 068 121 010 A 068 121 010 AX				50 005 151
	mit Gegengehäuse/with backhousing/avec demi-corps/con remate/c задним корпусом				



AUDI

A

09.1991→07.1995 Reference 	1Z 028 115 105 J 028 115 105 J 068 115 105 BL 068 115 105 BL 1Z: 01.1994→ 1Z: →12.1993, 8C-N-000 001→8C-N-300 000		 50 005 866	
09.1991→07.1995 Reference 	1Z 026 121 005 A 026 121 005 C 026 121 005 E 026 121 005 G 026 121 005 H 037 121 005 B 037 121 005 C 068 121 005 A ohne Gegengehäuse/without backhousing/sans demi-corps/sin remate/без заднего корпуса		50 005 148	
80 2.0i				109
08.1988→07.1995 Reference 	3A, AAD, ABK, ABT, ADW 026 121 010 026 121 010 C 026 121 010 CV 026 121 010 CX 026 121 010 F 026 121 010 FV 026 121 010 FX 026 121 010 V 026 121 010 X 037 121 010 037 121 010 A 037 121 010 AX 068 121 010 A 068 121 010 AX mit Gegengehäuse/with backhousing/avec demi-corps/con remate/с задним корпусом		50 005 151	
08.1982→07.1984 Reference	HP, JL, JS 035 121 004 035 121 004 A 035 121 004 AV 035 121 004 AX 035 121 004 X 035 121 005 035 121 005 B 035 121 005 E		50 005 145	
08.1988→07.1995 Reference 	3A, AAD, ABK, ABT, ADW 026 121 005 A 026 121 005 C 026 121 005 E 026 121 005 G 026 121 005 H 037 121 005 B 037 121 005 C 068 121 005 A ohne Gegengehäuse/without backhousing/sans demi-corps/sin remate/без заднего корпуса		50 005 148	
08.1988→07.1995 Reference 	3A, AAD, ABK, ABT, ADW 026 115 105 A 026 115 105 A ABK, ABT: 01.1994→ 3A: 89-H-300 001→ ABK, ABT: →12.1993, 8C-N-000 001→8C-N-300 000		50 005 822	
80 2.0i 16V				110
03.1990→07.1995 Reference 	6A, ACE 026 121 010 026 121 010 C 026 121 010 CV 026 121 010 CX 026 121 010 F 026 121 010 FV 026 121 010 FX 026 121 010 V 026 121 010 X 037 121 010 037 121 010 A 037 121 010 AX 068 121 010 A 068 121 010 AX mit Gegengehäuse/with backhousing/avec demi-corps/con remate/с задним корпусом		50 005 151	
03.1990→07.1995 Reference 	6A, ACE 026 121 005 A 026 121 005 C 026 121 005 E 026 121 005 G 026 121 005 H 037 121 005 B 037 121 005 C 068 121 005 A ohne Gegengehäuse/without backhousing/sans demi-corps/sin remate/без заднего корпуса		50 005 148	
03.1990→07.1995 Reference 	6A, ACE 053 115 105 B 053 115 105 B 053 115 105 C 053 115 105 C ACE: 01.1994→ 6A: 8C-N-000 001→8C-N-300 000 ACE: →12.1993, 8C-N-000 001→8C-N-300 000		50 005 845	



80 2.1i					111
10.1980→07.1983	WE				
Reference	035 121 004 035 121 004 X	035 121 004 A 035 121 005	035 121 004 AV 035 121 005 B	035 121 004 AX 035 121 005 E	 50 005 145
80 2.2i					112
08.1982→07.1984	KK, KL				
Reference	035 121 004 035 121 004 X	035 121 004 A 035 121 005	035 121 004 AV 035 121 005 B	035 121 004 AX 035 121 005 E	 50 005 145
80 2.2i Turbo 20V					113
02.1993→07.1995	ABY				
Reference	054 121 004	054 121 004 A	054 121 004 AV	054 121 004 AX	 50 005 550
80 2.3i					114
09.1991→11.1994	NG				
Reference	035 121 004 035 121 004 X 	035 121 004 A 035 121 005	035 121 004 AV 035 121 005 B	035 121 004 AX 035 121 005 E	 50 005 145
		→ch. 89-J-394 742			
09.1991→11.1994	NG				
Reference	034 121 004 034 121 005 D 	034 121 004 A	034 121 004 V	034 121 004 X	 50 005 149
		ch 89-J-394 743→			
09.1991→11.1994	NG				
Reference	054 121 004 	054 121 004 A	054 121 004 AV	054 121 004 AX	 50 005 550
		→ch. 89-J-396 702			
80 2.6i					115
07.1992→07.1995	ABC, ACZ				
Reference	078 121 004 H 078 121 004 JV 078 121 006 	078 121 004 HV 078 121 004 JX	078 121 004 HX 078 121 004 Q	078 121 004 J 078 121 004 QX	 50 005 167
		ch 8C-S-025 821→			
07.1992→07.1995	ABC, ACZ				
Reference	078 121 004 B 078 121 004 CV 	078 121 004 BV 078 121 004 CX	078 121 004 BX	078 121 004 C	 50 005 166
		→ch. 8C-S-025 820			
80 2.8i					116
09.1991→07.1995	AAH				
Reference	078 121 004 H 078 121 004 JV 078 121 006 	078 121 004 HV 078 121 004 JX	078 121 004 HX 078 121 004 Q	078 121 004 J 078 121 004 QX	 50 005 167
		ch 8C-S-025 821→			

**AUDI****A**

09.1991→07.1995 Reference	AAH 078 121 004 B 078 121 004 BV 078 121 004 BX 078 121 004 C 078 121 004 CV 078 121 004 CX →ch. 8C-S-025 820			50 005 166
90 1.6 TD				117
08.1984→12.1991 Reference	CY, RA, SB 026 121 010 026 121 010 C 026 121 010 CV 026 121 010 CX 026 121 010 F 026 121 010 FV 026 121 010 FX 026 121 010 V 026 121 010 X 037 121 010 037 121 010 A 037 121 010 AX 068 121 010 A 068 121 010 AX mit Gegengehäuse/with backhousing/avec demi-corps/con remate/с задним корпусом			50 005 151
08.1984→12.1991 Reference	CY, RA, SB 026 121 005 A 026 121 005 C 026 121 005 E 026 121 005 G 026 121 005 H 037 121 005 B 037 121 005 C 068 121 005 A ohne Gegengehäuse/without backhousing/sans demi-corps/sin remate/без заднего корпуса			50 005 148
90 1.8				118
06.1984→03.1987 Reference	JN 026 121 010 026 121 010 C 026 121 010 CV 026 121 010 CX 026 121 010 F 026 121 010 FV 026 121 010 FX 026 121 010 V 026 121 010 X 037 121 010 037 121 010 A 037 121 010 AX 068 121 010 A 068 121 010 AX mit Gegengehäuse/with backhousing/avec demi-corps/con remate/с задним корпусом			50 005 151
06.1984→03.1987 Reference	JN 026 115 105 026 115 105 026 115 105 B 026 115 105 B 049 115 105 H 049 115 105 H 056 115 105 A 056 115 105 A		50 005 813	
06.1984→03.1987 Reference	JN 026 121 005 A 026 121 005 C 026 121 005 E 026 121 005 G 026 121 005 H 037 121 005 B 037 121 005 C 068 121 005 A ohne Gegengehäuse/without backhousing/sans demi-corps/sin remate/без заднего корпуса			50 005 148
90 1.8i				119
08.1989→12.1991 Reference	DZ 026 121 010 026 121 010 C 026 121 010 CV 026 121 010 CX 026 121 010 F 026 121 010 FV 026 121 010 FX 026 121 010 V 026 121 010 X 037 121 010 037 121 010 A 037 121 010 AX 068 121 010 A 068 121 010 AX mit Gegengehäuse/with backhousing/avec demi-corps/con remate/с задним корпусом			50 005 151
08.1989→12.1991 Reference	DZ 026 115 105 026 115 105 026 115 105 B 026 115 105 B 049 115 105 H 049 115 105 H 056 115 105 A 056 115 105 A		50 005 813	
08.1989→12.1991 Reference	DZ 026 121 005 A 026 121 005 C 026 121 005 E 026 121 005 G 026 121 005 H 037 121 005 B 037 121 005 C 068 121 005 A ohne Gegengehäuse/without backhousing/sans demi-corps/sin remate/без заднего корпуса			50 005 148



90 2.0i					120
10.1984→12.1991	HP, JL, JS, PS, SK				
Reference	035 121 004 035 121 004 A 035 121 004 AV 035 121 004 AX 035 121 004 X 035 121 005 035 121 005 B 035 121 005 E PS: →ch. 89-J-394 742				50 005 145
04.1987→12.1991	PS				
Reference	034 121 004 034 121 004 A 034 121 004 V 034 121 004 X 034 121 005 D ch 89-J-394743→				50 005 149
90 2.0i 20V					121
01.1988→12.1991	NM				
Reference	034 121 004 034 121 004 A 034 121 004 V 034 121 004 X 034 121 005 D →ch. 88-M-033 000				50 005 149
01.1988→12.1991	NM				
Reference	054 121 004 054 121 004 A 054 121 004 AV 054 121 004 AX ch 88-M-033 001→				50 005 550
90 2.2i					122
06.1984→12.1991	HY, JT, KV, KX				
Reference	035 121 004 035 121 004 A 035 121 004 AV 035 121 004 AX 035 121 004 X 035 121 005 035 121 005 B 035 121 005 E KV: →ch. 89-J-394 742				50 005 145
06.1984→12.1991	KV				
Reference	034 121 004 034 121 004 A 034 121 004 V 034 121 004 X 034 121 005 D ch 89-J-394 743→				50 005 149
90 2.3i					123
04.1987→12.1991	NG				
Reference	035 121 004 035 121 004 A 035 121 004 AV 035 121 004 AX 035 121 004 X 035 121 005 035 121 005 B 035 121 005 E →ch. 89-J-394 742				50 005 145
04.1987→12.1991	NG				
Reference	034 121 004 034 121 004 A 034 121 004 V 034 121 004 X 034 121 005 D ch 89-J-394 743→				50 005 149
04.1987→12.1991	NG				
Reference	054 121 004 054 121 004 A 054 121 004 AV 054 121 004 AX →ch. 89-J-396 702				50 005 550

**AUDI****A****90 2.3i 20V****124**

06.1988→12.1991

7A

Reference

034 121 004 034 121 004 A 034 121 004 V 034 121 004 X
034 121 005 D
→ch. 88-M-033 000**50 005 149**

06.1988→12.1991

7A

Reference

054 121 004 054 121 004 A 054 121 004 AV 054 121 004 AX
ch 88-M-033 001→**50 005 550****100 1.6i****125**

08.1976→07.1993

ABB, YV

Reference

026 121 010 026 121 010 C 026 121 010 CV 026 121 010 CX
026 121 010 F 026 121 010 FV 026 121 010 FX 026 121 010 V
026 121 010 X 037 121 010 037 121 010 A 037 121 010 AX
068 121 010 A 068 121 010 AXmit Gegengehäuse/with backhousing/avec demi-corps/con remate/c задним корпусом
YV: ch 43-B-070 001→**50 005 151**

08.1976→07.1982

YV

Reference

056 121 005 056 121 005 A 068 121 005 068 121 005 B
068 121 005 C 068 121 005 Xohne Gegengehäuse/without backhousing/sans demi-corps/sin remate/без заднего корпуса
→ch 43-B-070 000**50 005 140**

08.1976→07.1993

ABB, YV

Reference

026 115 105 026 115 105 026 115 105 B 026 115 105 B
049 115 105 H 049 115 105 H 056 115 105 A 056 115 105 A**50 005 813**

08.1976→07.1993

ABB, YV

Reference

026 121 005 A 026 121 005 C 026 121 005 E 026 121 005 G
026 121 005 H 037 121 005 B 037 121 005 C 068 121 005 Aohne Gegengehäuse/without backhousing/sans demi-corps/sin remate/без заднего корпуса
YV: ch 43-B-070 001→**50 005 148**

08.1976→07.1982

YV

Reference

026 121 010 A 026 121 010 AV 026 121 010 D 026 121 010 DV
026 121 010 DX 055 121 010 055 121 010 X 056 121 011
056 121 013 A 068 121 010mit Gegengehäuse/with backhousing/avec demi-corps/con remate/c задним корпусом
→ch. 43-B-070 000**50 005 150****100 1.8****126**

05.1982→12.1990

DR, DS, JW, KN, NP, RS, SH

Reference

026 121 010 026 121 010 C 026 121 010 CV 026 121 010 CX
026 121 010 F 026 121 010 FV 026 121 010 FX 026 121 010 V
026 121 010 X 037 121 010 037 121 010 A 037 121 010 AX
068 121 010 A 068 121 010 AX

mit Gegengehäuse/with backhousing/avec demi-corps/con remate/c задним корпусом

**50 005 151**

05.1982→12.1990

DR, DS, JW, NP, RS, SH

Reference

026 115 105 026 115 105 026 115 105 B 026 115 105 B
049 115 105 H 049 115 105 H 056 115 105 A 056 115 105 A**50 005 813**



05.1982→12.1990 Reference	DR, DS, JW, KN, NP, RS, SH 026 121 005 A 026 121 005 C 026 121 005 E 026 121 005 G 026 121 005 H 037 121 005 B 037 121 005 C 068 121 005 A ohne Gegengehäuse/without backhousing/sans demi-corps/sin remate/без заднего корпуса				50 005 148
100 1.8i					127
04.1985→12.1990 Reference	4B, PH, SH 026 121 010 026 121 010 C 026 121 010 CV 026 121 010 CX 026 121 010 F 026 121 010 FV 026 121 010 FX 026 121 010 V 026 121 010 X 037 121 010 037 121 010 A 037 121 010 AX 068 121 010 A 068 121 010 AX mit Gegengehäuse/with backhousing/avec demi-corps/con remate/c задним корпусом				50 005 151
04.1985→12.1990 Reference	4B, PH, SH 026 115 105 026 115 105 026 115 105 B 026 115 105 B 049 115 105 H 049 115 105 H 056 115 105 A 056 115 105 A				50 005 813
04.1985→12.1990 Reference	4B, PH, SH 026 121 005 A 026 121 005 C 026 121 005 E 026 121 005 G 026 121 005 H 037 121 005 B 037 121 005 C 068 121 005 A ohne Gegengehäuse/without backhousing/sans demi-corps/sin remate/без заднего корпуса				50 005 148
100 1.9i					128
08.1980→07.1984 Reference	WH 035 121 004 035 121 004 A 035 121 004 AV 035 121 004 AX 035 121 004 X 035 121 005 035 121 005 B 035 121 005 E →ch. 44-D-200 000				50 005 145
08.1980→07.1984 Reference	WH 034 121 004 034 121 004 A 034 121 004 V 034 121 004 X 034 121 005 D ch 44-D-200 001→				50 005 149
100 2.0i					129
12.1990→07.1994 Reference	AAD, AAE, ABK, ADW 026 121 010 026 121 010 C 026 121 010 CV 026 121 010 CX 026 121 010 F 026 121 010 FV 026 121 010 FX 026 121 010 V 026 121 010 X 037 121 010 037 121 010 A 037 121 010 AX 068 121 010 A 068 121 010 AX mit Gegengehäuse/with backhousing/avec demi-corps/con remate/c задним корпусом				50 005 151
08.1984→12.1990 Reference	KP, RT, SL 035 121 004 035 121 004 A 035 121 004 AV 035 121 004 AX 035 121 004 X 035 121 005 035 121 005 B 035 121 005 E RT: →010.235				50 005 145
12.1990→07.1994 Reference	AAD, AAE, ABK, ADW 026 121 005 A 026 121 005 C 026 121 005 E 026 121 005 G 026 121 005 H 037 121 005 B 037 121 005 C 068 121 005 A ohne Gegengehäuse/without backhousing/sans demi-corps/sin remate/без заднего корпуса				50 005 148

**AUDI****A**

01.1988→12.1990	RT					
Reference	034 121 004 034 121 005 D 010.236→	034 121 004 A	034 121 004 V	034 121 004 X		50 005 149
12.1990→07.1994	AAD, AAE, ABK, ADW					
Reference	026 115 105 A AAD: 01.1991→, 4A-M-000 001→ AAE, ABK: 01.1993→ AAE: →12.1992, 4A-M-000 001→	026 115 105 A				50 005 822
100 2.0i 16V						130
01.1992→07.1994	ACE					
Reference	026 121 010 026 121 010 F 026 121 010 X 068 121 010 A mit Gegengehäuse/with backhousing/avec demi-corps/con remate/с задним корпусом	026 121 010 C 026 121 010 FV 037 121 010	026 121 010 CV 026 121 010 FX 037 121 010 A	026 121 010 CX 026 121 010 V 037 121 010 AX		50 005 151
01.1992→07.1994	ACE					
Reference	026 121 005 A 026 121 005 H ohne Gegengehäuse/without backhousing/sans demi-corps/sin remate/без заднего корпуса	026 121 005 C 037 121 005 B	026 121 005 E 037 121 005 C	026 121 005 G 068 121 005 A		50 005 148
01.1992→07.1994	ACE					
Reference	053 115 105 B ACE: 01.1993→ ACE: →12.1992, 4A-M-000 001→	053 115 105 B	053 115 105 C	053 115 105 C		50 005 845
100 2.0 D						131
10.1978→07.1989	CN					
Reference	069 121 004	069 121 004 V	069 121 004 X	069 121 005 D		50 005 146
100 2.0 TDI						132
11.1981→12.1990	DE, NC					
Reference	069 121 004 NC: →ch. 44-L-100 000	069 121 004 V	069 121 004 X	069 121 005 D		50 005 146
03.1988→12.1990	NC					
Reference	046 121 004 ch 44-L-100 001→	046 121 004 V	046 121 004 X			50 005 553
100 2.2						133
04.1978→07.1984	WB					
Reference	035 121 004 035 121 004 X	035 121 004 A 035 121 005	035 121 004 AV 035 121 005 B	035 121 004 AX 035 121 005 E		50 005 145

**100 2.2i****134**

08.1976→12.1990	HX, KF, KU, KZ, WC, WE, WG, WU						
Reference	035 121 004 035 121 004 X KU: →077.115	035 121 004 A 035 121 005	035 121 004 AV 035 121 005 B	035 121 004 AX 035 121 005 E			50 005 145
							50 005 149
08.1984→12.1990	KU						
Reference	034 121 004 034 121 005 D 077.116→	034 121 004 A	034 121 004 V	034 121 004 X			50 005 149

100 2.2i Turbo**135**

03.1986→12.1990	MC						
Reference	035 121 004 035 121 004 X →039.050	035 121 004 A 035 121 005	035 121 004 AV 035 121 005 B	035 121 004 AX 035 121 005 E			50 005 145
							50 005 149
03.1986→12.1990	MC						
Reference	034 121 004 034 121 005 D 039.951→	034 121 004 A	034 121 004 V	034 121 004 X			50 005 149

100 2.3i**136**

08.1986→12.1990	NF						
Reference	035 121 004 035 121 004 X →063.968	035 121 004 A 035 121 005	035 121 004 AV 035 121 005 B	035 121 004 AX 035 121 005 E			50 005 145
							50 005 149
08.1986→12.1990	NF						
Reference	034 121 004 034 121 005 D 063.969→	034 121 004 A	034 121 004 V	034 121 004 X			50 005 149
12.1990→07.1994	AAR						
Reference	054 121 004	054 121 004 A	054 121 004 AV	054 121 004 AX			50 005 550

100 2.4 D**137**

08.1989→12.1990	3D						
Reference	069 121 004 →ch. 44-L-100 000	069 121 004 V	069 121 004 X	069 121 005 D			50 005 146
							50 005 553
08.1989→12.1990	3D						
Reference	046 121 004 ch 44-L-100 001→	046 121 004 V	046 121 004 X				50 005 553















**AUDI****A**

05.1991→07.1994 Reference	AAS 074 121 004 B 074 121 005MX 20 Zähne/teeth/dientes/dents/зубьев	074 121 005 N	074 121 005 NX	074 121 005M			50 005 555
05.1991→07.1994 Reference	AAS 074 121 004 18 Zähne/teeth/dientes/dents/зубьев	074 121 004 A	074 121 004 V	074 121 004 X			50 005 551
100 2.5 TD							138
01.1990→12.1990 Reference	1T 046 121 004	046 121 004 V	046 121 004 X				50 005 553
100 2.5 TDI							139
06.1991→07.1994 Reference	AAT, ABP 046 121 004 D	046 121 004 DV	046 121 004 DX				50 005 552
100 2.8i							140
12.1990→07.1994 Reference	AAH 078 121 004 B 078 121 004 CV	078 121 004 BV 078 121 004 CX	078 121 004 BX	078 121 004 C			50 005 166
200 2.2i							141
10.1979→01.1987 Reference	JY, KU, WC, WK 035 121 004 035 121 004 X	035 121 004 A 035 121 005	035 121 004 AV 035 121 005 B	035 121 004 AX 035 121 005 E			50 005 145
200 2.2i Turbo 20V							142
08.1980→11.1990 Reference	3B, WS 035 121 004 035 121 004 X 3B: →ch. 44-J-246 281	035 121 004 A 035 121 005	035 121 004 AV 035 121 005 B	035 121 004 AX 035 121 005 E			50 005 145
03.1989→11.1990 Reference	3B 034 121 004 034 121 005 D ch 44-J-246 282→	034 121 004 A	034 121 004 V	034 121 004 X			50 005 149
200 2.2i Turbo							143
10.1979→11.1990 Reference	2B, KG, KJ, MC, WJ 035 121 004 035 121 004 X 2B: →001.068 MC: →039.050	035 121 004 A 035 121 005	035 121 004 AV 035 121 005 B	035 121 004 AX 035 121 005 E			50 005 145







01.1985→11.1990 Reference 	1B, 2B, MC 034 121 004 034 121 005 D 2B: 001.069→ MC: 039.951→	034 121 004 A	034 121 004 V	034 121 004 X			50 005 149
4000 1.3							144
08.1978→1981 Reference	FY, HH 052 121 004 052 121 005 A	052 121 004 V 052 121 005 AX	052 121 004 X 052 121 019	052 121 005			50 005 142
4000 1.6							145
01.1975→07.1980 Reference 	YG, YH 056 121 005 068 121 005 C ohne Gegengehäuse/without backhousing/sans demi-corps/sin remate/без заднего корпуса	056 121 005 A 068 121 005 X	068 121 005	068 121 005 B			50 005 140
01.1975→07.1980 Reference 	YG, YH 026 121 010 A 026 121 010 DX 056 121 013 A mit Gegengehäuse/with backhousing/avec demi-corps/con remate/c задним корпусом	026 121 010 AV 055 121 010 068 121 010	026 121 010 D 055 121 010 X	026 121 010 DV 056 121 011			50 005 150
4000 1.6 D							146
03.1981→07.1984 Reference 	CR, JK 026 121 010 026 121 010 F 026 121 010 X 068 121 010 A mit Gegengehäuse/with backhousing/avec demi-corps/con remate/c задним корпусом CR: ch 81-E-088 001→	026 121 010 C 026 121 010 FV 037 121 010 068 121 010 AX	026 121 010 CV 026 121 010 FX 037 121 010 A	026 121 010 CX 026 121 010 V 037 121 010 AX			50 005 151
03.1981→07.1982 Reference 	CR 056 121 005 068 121 005 C ohne Gegengehäuse/without backhousing/sans demi-corps/sin remate/без заднего корпуса →ch. 81-E-088 000	056 121 005 A 068 121 005 X	068 121 005	068 121 005 B			50 005 140
03.1981→07.1984 Reference 	CR, JK 026 121 005 A 026 121 005 H ohne Gegengehäuse/without backhousing/sans demi-corps/sin remate/без заднего корпуса CR: ch 81-E-088 001→	026 121 005 C 037 121 005 B	026 121 005 E 037 121 005 C	026 121 005 G 068 121 005 A			50 005 148
03.1981→07.1982 Reference 	CR 026 121 010 A 026 121 010 DX 056 121 013 A mit Gegengehäuse/with backhousing/avec demi-corps/con remate/c задним корпусом →ch. 81-E-088 000	026 121 010 AV 055 121 010 068 121 010	026 121 010 D 055 121 010 X	026 121 010 DV 056 121 011			50 005 150
4000 1.8							147
09.1983→07.1985 Reference 	JN 026 121 010 026 121 010 F 026 121 010 X 068 121 010 A mit Gegengehäuse/with backhousing/avec demi-corps/con remate/c задним корпусом	026 121 010 C 026 121 010 FV 037 121 010 068 121 010 AX	026 121 010 CV 026 121 010 FX 037 121 010 A	026 121 010 CX 026 121 010 V 037 121 010 AX			50 005 151

**AUDI****A**

				
09.1983→07.1985	JN			
Reference	026 121 005 A 026 121 005 H	026 121 005 C 037 121 005 B	026 121 005 E 037 121 005 C	026 121 005 G 068 121 005 A
	ohne Gegengehäuse/without backhousing/sans demi-corps/sin remate/без заднего корпуса			
4000 2.2i				148
06.1977→07.1987	JT, KX, WE			
Reference	035 121 004 035 121 004 X	035 121 004 A 035 121 005	035 121 004 AV 035 121 005 B	035 121 004 AX 035 121 005 E
				
5000 2.0 D				149
10.1978→02.1982	CN			
Reference	069 121 004	069 121 004 V	069 121 004 X	069 121 005 D
				
5000 2.0 TDI				150
03.1982→07.1985	DE			
Reference	069 121 004	069 121 004 V	069 121 004 X	069 121 005 D
				
5000 2.2i				151
06.1977→09.1986	KZ, WE			
Reference	035 121 004 035 121 004 X	035 121 004 A 035 121 005	035 121 004 AV 035 121 005 B	035 121 004 AX 035 121 005 E
				
5000 2.3i				152
08.1986→05.1988	NF			
Reference	035 121 004 035 121 004 X →063.968	035 121 004 A 035 121 005	035 121 004 AV 035 121 005 B	035 121 004 AX 035 121 005 E
				
08.1986→05.1988	NF			
Reference	034 121 004 034 121 005 D 063.969→	034 121 004 A	034 121 004 V	034 121 004 X
				
				50 005 149

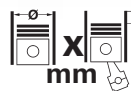

			Cyl	 mm	cm ³		Comp. Ratio ε	kW	PS	Pos
156 C.046	B		4	70 x 72	1108	2		37-40	50-55	1



A



Y 10 1.1 i.e. fire

1





07.1989→12.1995

156 C.046



50 005 303

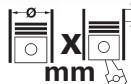





			Cyl		cm ³		Comp. Ratio ε	kW	PS	Pos
116	B		4	84 x 71	1573	2	8,6	61-63	83-85	16, 17
M57 D30 (135 kW)	D	(LA)	6	84 x 88	2926	4	18:1	135-142	184-193	110, 118, 130
M10 B15	B		4	82 x 71	1499	2	8,2:1	55	75	8
M10 B16	B		4	84 x 71	1573	2	8,3:1	66	90	32
M10 B16 N	B		4	84 x 71	1573	2	8:1	55	75	15
M10 B16 V	B		4	84 x 71	1573	2	9,5:1	55	75	31
M10 B18	B		4	89 x 71	1767	2		66	90	9, 12, 18, 23, 34
M10 B18 K	B		4	89 x 71	1767	2		75-77	102-105	35, 63, 65, 67
M10 B18 LE	B		4	89 x 71	1767	2	8,2:1	75	102	62
M10 B18 LE	B		4	89 x 71	1767	2	9,5:1	77	105	51
M10 B18 LU	B		4	89 x 71	1767	2	9:1	75	102	66
M10 B18 S	B		4	89 x 71	1767	2	9,5:1	66	90	33, 50
M10 B18 V	B		4	89 x 71	1767	2	9,5:1	66	90	61
M10 B20 (74 kW)	B		4	89 x 80	1990	2	8,5:1	74	100	13, 20, 21, 25
M10 B20 (85 kW)	B		4	89 x 80	1990	2		85	115	11, 22, 24
M10 B20 (88 kW)	B		4	89 x 80	1990	2	9,3:1	88	120	10, 19
M10 B20 (92 kW)	B		4	89 x 80	1990	2	9,3:1	92	125	36
M20 B20 L	B		6	80 x 66	1991	2		92	125	68, 69
M20 B20 LE	B		6	80 x 66	1991	2	9,8:1	95	129	52, 68
M20 B20 M1.Z7	B		6	80 x 66	1991	2	8,8:1	95	129	68, 81
M20 B20 MO.E8	B		6	80 x 66	1991	2	9,4:1	95	129	81
M20 B20 V	B		6	80 x 66	1991	2	9,2:1	90	122	26, 37
M20 B23 K	B		6	80 x 76,8	2316	2	9,5:1	105	143	38
M20 B23 L	B		6	80 x 76,8	2316	2	9,8:1	110	150	70
M20 B23 LE	B		6	80 x 76,8	2316	2	9,8:1	102	109	71
M20 B25 M.E	B		6	84 x 75	2494	2	9,4:1	125	170	74
M20 B25 M.E/8	B		6	84 x 75	2494	2	9,4:1	125	170	84
M20 B25 M1.Z7	B		6	84 x 75	2494	2	8,8:1	125	170	74, 84, 143
M20 B27 MEE	B		6	84 x 81	2693	2		92	125	56
M20B 20 K	B		6	80 x 66	1991	2	9,8:1	92	125	52, 68
M21 D24 W	D	(AN)	6	80 x 81	2443	2	22:1	60-63	82-86	53, 72
M21 D24 WA	D	(A)	6	80 x 81	2443	2	22:1	85	115	54, 73, 83
M30 B25 L	B		6	86 x 71,6	2494	2	9,6:1	110	150	55
M30 B25 V	B		6	86 x 71,6	2494	2	9:1	107-110	146-150	1, 14, 27
M30 B28 L	B		6	86 x 80	2788	2		126	171	29, 40, 46, 57
M30 B28 V	B		6	86 x 80	2788	2	9:1	125	170	2, 3, 28, 39
M30 B30	B		6	89 x 80	2986	2		131-147	178-200	4, 5, 6, 29, 30
M30 B30 M.E7	B		6	89 x 80	2986	2	9/9,2:1	138-145	188-197	76
M30 B30 V	B		6	89 x 80	2986	2		132-136	180-185	41, 47
M30 B32 L	B		6	89 x 86	3210	2	9/9,3:1	145-147	197-200	7, 42, 43, 48
M30 B32 LA	B	(LA)	6	89 x 86	3210	2	7/7,5:1	185	252	45
M30 B32 M	B		6	89 x 86	3210	2	10:1	145	197	42
M30 B34 M.45	B		6	92 x 86	3430	2	8:1	136-141	185-192	58
M30 B34 ME	B		6	92 x 86	3430	2	10:1	150-160	204-218	59
M30 B35 L	B		6	93,4 x 84	3453	2	9,3:1	160	218	44, 49
M30 B35 M.E	B		6	92 x 86	3430	2	9,2:1	160-162	218-220	49, 58, 77
M30 B35 M.E7	B		6	92 x 86	3430	2	9/9,2:1	155	211	49, 77, 89
M40 B16	B		4	84 x 72	1596	2	9:1	73-75	100-102	91
M40 B16 ME.8	B		4	84 x 72	1596	2	9:1	73-75	100-102	60
M40 B18 M.E	B		4	84 x 81	1796	2	8,8:1	83-85	113-115	63, 79
M41 B17	D	(LA)	4	80 x 82,8	1665	2	22:1	66	90	96
M42 B18	B		4	84 x 81	1796	4	10:1	100	136	64, 94
M43 B16	G		4	84 x 72	1596	2	9,7:1	75-77	102-105	92, 121
M43 B18 Gas	G		4	84 x 81	1796	2	9,7:1	85	115	80, 97
M43 B19 TU OL	B		4	85 x 83,5	1895	2	9,7:1	87	118	104, 125
M43 B19 TU UL	B		4	85 x 83,5	1895	2	9,7:1	77	105	93, 124
M44 B19	B		4	85 x 83,5	1895	4	10:1	103	140	95, 105
M47 D20TU OL	D	(LA)	4	84 x 88	1951	4	19:1	110	150	128
M50 B20	B		6	80 x 66	1991	4	10,5:1	110	150	82, 98
M50 B20 TU	B		6	80 x 66	1991	4	11:1	110	150	98
M50 B25 M	B		6	84 x 75	2494	4	10:1	141	192	85
M50 B25 TU	B		6	84 x 75	2494	4	10,5:1	141	192	85, 100
M51 D25 OL	D	(LA)	6	80 x 82,8	2497	2	22:1	105	143	87, 102
M51 D25 TU OL	D	(LA)	6	80 x 82,8	2497	2	22:1	105	143	108, 116
M51 D25 TU UL	D	(A)	6	80 x 82,8	2497	2	22:1	85	115	101
M51 D25 UL	D	(A)	6	80 x 82,8	2497	2	22:1	85	115	86, 101, 115
M52 B20	B		6	80 x 66	1991	4	11:1	110	150	82, 98, 106, 113, 127
M52 B25	B		6	84 x 75	2494	4	10,5:1	125	170	99, 114
M52 B28 GG	B		6	84 x 84	2793	4	10,2:1	142	193	103, 107, 109, 117









B















B

			Cyl	 mm	cm ³		Comp. Ratio ε	kW	PS	Pos
M52 B28 TU	B		6	84 x 84	2793	4	10,2:1	142	193	107, 109, 117, 129
M60 B30	B		8	84 x 67,6	2997	4	10,5:1	155-160	211-218	76, 88
M60 B40	B		8	89 x 80	3982	4	10:1	210	286	78, 90
M62 B35	B		8	84 x 78,9	3498	4	10:1	173	235	111, 119
M62 B35 TU	B		8	84 x 78,9	3498	4	10:1	175-180	238-245	111, 119
M62 B44	B		8	92 x 82,7	4398	4	10:1	210	286	75, 112, 120
M62 B44 TU	B		8	92 x 82,7	4398	4	10:1	210	286	112, 120, 131
N42 B18	B		4	84 x 81	1796	4	10,25:1	85	116	123
N42 B20	B		4	84 x 90	1995	4	10:1	105	143	126
N42 B20A	B		4	84 x 90	1995	4	9:1	105	143	126
N45 B16	B		4	84 x 72	1596	4	10,25:1	85	116	122, 134, 137, 142
N46 B20	B		4	84 x 90	1995	4	10,2:1	105	143	126
N46 B20 OL	B		4	84 x 90	1995	4	10,5:1	95-110	129-150	132, 133, 136, 139, 141
N46 B20 UL	B		4	84 x 90	1995	4	10,5:1	95	129	135, 138, 140











2500 (E3)					1	
10.1968→04.1977	M30 B25 V					50 005 000
Reference	11 51 1 251 230	11 51 1 253 143	11 51 1 263 934	11 51 1 266 094		
	11 51 1 266 096	11 51 1 705 236	11 51 1 705 273	11 51 1 707 414		
	11 51 9 070 757					
2800 (E3)					2	
10.1968→07.1975	M30 B28 V					50 005 000
Reference	11 51 1 251 230	11 51 1 253 143	11 51 1 263 934	11 51 1 266 094		
	11 51 1 266 096	11 51 1 705 236	11 51 1 705 273	11 51 1 707 414		
	11 51 9 070 757					
2.8 (E3)					3	
02.1975→04.1977	M30 B28 V					50 005 000
Reference	11 51 1 251 230	11 51 1 253 143	11 51 1 263 934	11 51 1 266 094		
	11 51 1 266 096	11 51 1 705 236	11 51 1 705 273	11 51 1 707 414		
	11 51 9 070 757					
3.0 CSi (E3)					4	
07.1971→03.1976	M30 B30					50 005 000
Reference	11 51 1 251 230	11 51 1 253 143	11 51 1 263 934	11 51 1 266 094		
	11 51 1 266 096	11 51 1 705 236	11 51 1 705 273	11 51 1 707 414		
	11 51 9 070 757					
3.0 Si (E3)					5	
07.1971→04.1977	M30 B30					50 005 000
Reference	11 51 1 251 230	11 51 1 253 143	11 51 1 263 934	11 51 1 266 094		
	11 51 1 266 096	11 51 1 705 236	11 51 1 705 273	11 51 1 707 414		
	11 51 9 070 757					
3.0i Bavaria (E3) (USA)					6	
1975 → 1978	M30 B30					50 005 000
Reference	11 51 1 251 230	11 51 1 253 143	11 51 1 263 934	11 51 1 266 094		
	11 51 1 266 096	11 51 1 705 236	11 51 1 705 273	11 51 1 707 414		
	11 51 9 070 757					
3.3 Li (E3)					7	
01.1974→09.1976	M30 B32 L					50 005 000
Reference	11 51 1 251 230	11 51 1 253 143	11 51 1 263 934	11 51 1 266 094		
	11 51 1 266 096	11 51 1 705 236	11 51 1 705 273	11 51 1 707 414		
	11 51 9 070 757					
1500 (E6)					8	
09.1963→07.1966	M10 B15					50 005 002
Reference	11 51 0 686 001	11 51 0 686 801	11 51 0 686 901	11 51 1 256 600		
	11 51 9 056 401					
1800 (E6)					9	
05.1971→07.1975	M10 B18					50 005 009
Reference	11 51 1 274 583	11 51 1 274 584	11 51 1 286 355	11 51 1 286 358		
	11 51 1 286 388	11 51 1 721 477	11 51 9 070 755			

**B**

							
05.1971→07.1975 Reference	M10 B18 11 51 0 686 001 11 51 9 056 401	11 51 0 686 801	11 51 0 686 901	11 51 1 256 600			50 005 002
05.1971→07.1975 Reference	M10 B18 11 51 0 786 821 11 51 1 259 660	11 51 1 258 701	11 51 1 258 932	11 51 1 258 933			50 005 019
2002 ti (E6)							10
06.1968→04.1972 Reference	M10 B20 (88 kW) 11 51 0 686 001 11 51 9 056 401	11 51 0 686 801	11 51 0 686 901	11 51 1 256 600			50 005 002
2002 tii (E6) (USA)							11
1972 → 1977 Reference	M10 B20 (85 kW) 11 51 0 786 821 11 51 1 259 660	11 51 1 258 701	11 51 1 258 932	11 51 1 258 933			50 005 019
2000 1.8 (E9)							12
01.1970→11.1972 Reference	M10 B18 11 51 1 274 583 11 51 1 286 388	11 51 1 274 584 11 51 1 721 477	11 51 1 286 355 11 51 9 070 755	11 51 1 286 358			50 005 009
01.1970→11.1972 Reference	M10 B18 11 51 0 686 001 11 51 9 056 401	11 51 0 686 801	11 51 0 686 901	11 51 1 256 600			50 005 002
01.1970→11.1972 Reference	M10 B18 11 51 0 786 821 11 51 1 259 660	11 51 1 258 701	11 51 1 258 932	11 51 1 258 933			50 005 019
2000 (E9)							13
10.1965→07.1972 Reference	M10 B20 (74 kW) 11 51 0 686 001 11 51 9 056 401	11 51 0 686 801	11 51 0 686 901	11 51 1 256 600			50 005 002
2.5 CS (E9)							14
09.1974→03.1976 Reference	M30 B25 V 11 51 1 251 230 11 51 1 266 096 11 51 9 070 757	11 51 1 253 143 11 51 1 705 236	11 51 1 263 934 11 51 1 705 273	11 51 1 266 094 11 51 1 707 414			50 005 000



1502 (E10)							15
01.1975→08.1977	M10 B16 N						
Reference	11 51 0 686 001 11 51 9 056 401	11 51 0 686 801	11 51 0 686 901	11 51 1 256 600			50 005 002
1600 (E10)							16
08.1963→07.1975	116						
Reference	11 51 0 686 001 11 51 9 056 401	11 51 0 686 801	11 51 0 686 901	11 51 1 256 600			50 005 002
1602 (E10)							17
04.1971→07.1975	116						
Reference	11 51 0 686 001 11 51 9 056 401	11 51 0 686 801	11 51 0 686 901	11 51 1 256 600			50 005 002
1802 (E10)							18
05.1971→07.1975	M10 B18						
Reference	11 51 1 274 583 11 51 1 286 388	11 51 1 274 584 11 51 1 721 477	11 51 1 286 355 11 51 9 070 755	11 51 1 286 358			50 005 009
05.1971→07.1975	M10 B18						
Reference	11 51 0 686 001 11 51 9 056 401	11 51 0 686 801	11 51 0 686 901	11 51 1 256 600			50 005 002
05.1971→07.1975	M10 B18						
Reference	11 51 0 786 821 11 51 1 259 660	11 51 1 258 701	11 51 1 258 932	11 51 1 258 933			50 005 019
2000 ti (E10)							19
01.1966→07.1972	M10 B20 (88 kW)						
Reference	11 51 0 686 001 11 51 9 056 401	11 51 0 686 801	11 51 0 686 901	11 51 1 256 600			50 005 002
2002 (E10)							20
02.1968→07.1975	M10 B20 (74 kW)						
Reference	11 51 0 686 001 11 51 9 056 401	11 51 0 686 801	11 51 0 686 901	11 51 1 256 600			50 005 002

**B****2002 (E10) (USA)****21**

1972 → 1974 M10 B20 (74 kW)
 Reference 11 51 0 686 001 11 51 0 686 801 11 51 0 686 901 11 51 1 256 600
 11 51 9 056 401

**50 005 002****2002 tii (E10) (USA)****22**

1972 → 1977 M10 B20 (85 kW)
 Reference 11 51 0 786 821 11 51 1 258 701 11 51 1 258 932 11 51 1 258 933
 11 51 1 259 660

**50 005 019****518 1.8 (E12)****23**

07.1974→07.1981 M10 B18
 Reference 11 51 1 274 583 11 51 1 274 584 11 51 1 286 355 11 51 1 286 358
 11 51 1 286 388 11 51 1 721 477 11 51 9 070 755

**50 005 009**

07.1974→07.1981 M10 B18
 Reference 11 51 0 686 001 11 51 0 686 801 11 51 0 686 901 11 51 1 256 600
 11 51 9 056 401

**50 005 002**

07.1974→07.1981 M10 B18
 Reference 11 51 0 786 821 11 51 1 258 701 11 51 1 258 932 11 51 1 258 933
 11 51 1 259 660

**50 005 019****520 2.0 (E12)****24**

05.1971→12.1979 M10 B20 (85 kW)
 Reference 11 51 0 786 821 11 51 1 258 701 11 51 1 258 932 11 51 1 258 933
 11 51 1 259 660

**50 005 019****520 2.0 (E12) (USA)****25**









1972 → 1974 M10 B20 (74 kW)
 Reference 11 51 0 686 001 11 51 0 686 801 11 51 0 686 901 11 51 1 256 600
 11 51 9 056 401

**50 005 002****520/6 2.0 (E12)****26**

09.1977→05.1981 M20 B20 V
 Reference 11 51 1 267 187 11 51 1 267 583 11 51 9 071 560

**50 005 020**

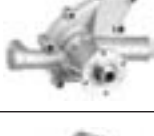

525 2.5 (E12)					27
09.1976→05.1981	M30 B25 V				
Reference	11 51 1 251 230 11 51 1 266 096 11 51 9 070 757	11 51 1 253 143 11 51 1 705 236	11 51 1 263 934 11 51 1 705 273	11 51 1 266 094 11 51 1 707 414	 50 005 000
528 2.8 (E12)					28
01.1975→08.1977	M30 B28 V				
Reference	11 51 1 251 230 11 51 1 266 096 11 51 9 070 757	11 51 1 253 143 11 51 1 705 236	11 51 1 263 934 11 51 1 705 273	11 51 1 266 094 11 51 1 707 414	 50 005 000
528i (E12) (USA)					29
04.1977→05.1981	M30 B28 L				
Reference	11 51 1 271 436 11 51 1 707 190 11 51 1 720 883 11 51 9 070 761	11 51 1 272 613 11 51 1 707 191 11 51 1 720 892	11 51 1 286 417 11 51 1 707 192 11 51 1 720 893	11 51 1 287 367 11 51 1 707 193 11 51 9 070 760	 50 005 004
04.1977→05.1981	M30 B30				
Reference	11 51 1 251 230 11 51 1 266 096 11 51 9 070 757	11 51 1 253 143 11 51 1 705 236	11 51 1 263 934 11 51 1 705 273	11 51 1 266 094 11 51 1 707 414	 50 005 000
530 3.0i (E12) (USA)					30
1975 → 1978	M30 B30				
Reference	11 51 1 251 230 11 51 1 266 096 11 51 9 070 757	11 51 1 253 143 11 51 1 705 236	11 51 1 263 934 11 51 1 705 273	11 51 1 266 094 11 51 1 707 414	 50 005 000
315 1.6 (E21)					31
03.1981→12.1983	M10 B16 V				
Reference	11 51 0 786 821 11 51 1 259 660	11 51 1 258 701	11 51 1 258 932	11 51 1 258 933	 50 005 019
316 1.6 (E21)					32
08.1975→09.1980	M10 B16				
Reference	11 51 0 786 821 11 51 1 259 660	11 51 1 258 701	11 51 1 258 932	11 51 1 258 933	 50 005 019
316 1.8 (E21)					33
09.1980→12.1983	M10 B18 S				
Reference	11 51 1 274 583 11 51 1 286 388	11 51 1 274 584 11 51 1 721 477	11 51 1 286 355 11 51 9 070 755	11 51 1 286 358	 50 005 009
09.1980→12.1983	M10 B18 S				
Reference	11 51 0 786 821 11 51 1 259 660 ch 7050000→	11 51 1 258 701	11 51 1 258 932	11 51 1 258 933	 50 005 019

**B****318 1.8 (E21)****34**

08.1975→12.1980 M10 B18
 Reference 11 51 1 274 583 11 51 1 274 584 11 51 1 286 355 11 51 1 286 358
 11 51 1 286 388 11 51 1 721 477 11 51 9 070 755

**50 005 009**

08.1975→12.1980 M10 B18
 Reference 11 51 0 686 001 11 51 0 686 801 11 51 0 686 901 11 51 1 256 600
 11 51 9 056 401

**50 005 002**

08.1975→12.1980 M10 B18
 Reference 11 51 0 786 821 11 51 1 258 701 11 51 1 258 932 11 51 1 258 933
 11 51 1 259 660

**50 005 019****318 1.8i (E21)****35**

11.1979→12.1983 M10 B18 K
 Reference 11 51 1 274 583 11 51 1 274 584 11 51 1 286 355 11 51 1 286 358
 11 51 1 286 388 11 51 1 721 477 11 51 9 070 755

**50 005 009**

11.1979→12.1983 M10 B18 K
 Reference 11 51 0 786 821 11 51 1 258 701 11 51 1 258 932 11 51 1 258 933
 11 51 1 259 660

**50 005 019****320 2.0i (E21)****36**

06.1975→12.1978 M10 B20 (92 kW)
 Reference 11 51 0 786 821 11 51 1 258 701 11 51 1 258 932 11 51 1 258 933
 11 51 1 259 660

**50 005 019****320/6 2.0 (E21)****37**

08.1977→12.1982 M20 B20 V
 Reference 11 51 1 271 435 11 51 1 272 616 11 51 1 706 564 11 51 1 706 588
 11 51 1 706 624 11 51 1 711 492 11 51 9 058 996 11 51 9 071 562

**50 005 018**

08.1977→12.1982 M20 B20 V
 Reference 11 51 1 267 187 11 51 1 267 583 11 51 9 071 560

**50 005 020****323 2.3i (E21)****38**

01.1978→09.1982 M20 B23 K
 Reference 11 51 1 271 435 11 51 1 272 616 11 51 1 706 564 11 51 1 706 588
 11 51 1 706 624 11 51 1 711 492 11 51 9 058 996 11 51 9 071 562

**50 005 018**

01.1978→09.1982 M20 B23 K
 Reference 11 51 1 267 187 11 51 1 267 583 11 51 9 071 560
 →01.1981

**50 005 020**



728 2.8 (E23)					39	
05.1977→06.1986	M30 B28 V					50 005 000
Reference	11 51 1 251 230	11 51 1 253 143	11 51 1 263 934	11 51 1 266 094		
	11 51 1 266 096	11 51 1 705 236	11 51 1 705 273	11 51 1 707 414		
	11 51 9 070 757					
728 2.8i (E23)					40	
09.1977→05.1986	M30 B28 L					50 005 004
Reference	11 51 1 271 436	11 51 1 272 613	11 51 1 286 417	11 51 1 287 367		
	11 51 1 707 190	11 51 1 707 191	11 51 1 707 192	11 51 1 707 193		
	11 51 1 720 883	11 51 1 720 892	11 51 1 720 893	11 51 9 070 760		
	11 51 9 070 761					
730 3.0 (E23)					41	
05.1977→08.1979	M30 B30 V					50 005 000
Reference	11 51 1 251 230	11 51 1 253 143	11 51 1 263 934	11 51 1 266 094		
	11 51 1 266 096	11 51 1 705 236	11 51 1 705 273	11 51 1 707 414		
	11 51 9 070 757					
732 3.2i (E23)					42	
09.1979→08.1986	M30 B32 L, M30 B32 M					50 005 004
Reference	11 51 1 271 436	11 51 1 272 613	11 51 1 286 417	11 51 1 287 367		
	11 51 1 707 190	11 51 1 707 191	11 51 1 707 192	11 51 1 707 193		
	11 51 1 720 883	11 51 1 720 892	11 51 1 720 893	11 51 9 070 760		
	11 51 9 070 761					
733 3.2i (E23)					43	
05.1977→06.1986	M30 B32 L					50 005 000
Reference	11 51 1 251 230	11 51 1 253 143	11 51 1 263 934	11 51 1 266 094		
	11 51 1 266 096	11 51 1 705 236	11 51 1 705 273	11 51 1 707 414		
	11 51 9 070 757					
	→07.1979					
735i (E23)					44	
09.1979→08.1986	M30 B35 L					50 005 004
Reference	11 51 1 271 436	11 51 1 272 613	11 51 1 286 417	11 51 1 287 367		
	11 51 1 707 190	11 51 1 707 191	11 51 1 707 192	11 51 1 707 193		
	11 51 1 720 883	11 51 1 720 892	11 51 1 720 893	11 51 9 070 760		
	11 51 9 070 761					
745i turbo (E23)					45	
09.1979→04.1983	M30 B32 LA					50 005 004
Reference	11 51 1 271 436	11 51 1 272 613	11 51 1 286 417	11 51 1 287 367		
	11 51 1 707 190	11 51 1 707 191	11 51 1 707 192	11 51 1 707 193		
	11 51 1 720 883	11 51 1 720 892	11 51 1 720 893	11 51 9 070 760		
	11 51 9 070 761					
628 CSi (E24)					46	
09.1979→12.1987	M30 B28 L					50 005 004
Reference	11 51 1 271 436	11 51 1 272 613	11 51 1 286 417	11 51 1 287 367		
	11 51 1 707 190	11 51 1 707 191	11 51 1 707 192	11 51 1 707 193		
	11 51 1 720 883	11 51 1 720 892	11 51 1 720 893	11 51 9 070 760		
	11 51 9 070 761					
630 CS (E24)					47	
04.1976→08.1979	M30 B30 V					50 005 000
Reference	11 51 1 251 230	11 51 1 253 143	11 51 1 263 934	11 51 1 266 094		
	11 51 1 266 096	11 51 1 705 236	11 51 1 705 273	11 51 1 707 414		
	11 51 9 070 757					

**B****633 CSi (E24)****48**

04.1976→12.1987

M30 B32 L

Reference

11 51 1 271 436	11 51 1 272 613	11 51 1 286 417	11 51 1 287 367
11 51 1 707 190	11 51 1 707 191	11 51 1 707 192	11 51 1 707 193
11 51 1 720 883	11 51 1 720 892	11 51 1 720 893	11 51 9 070 760
11 51 9 070 761			

**50 005 004**

08.1979→

04.1976→12.1987

M30 B32 L

Reference

11 51 1 251 230	11 51 1 253 143	11 51 1 263 934	11 51 1 266 094
11 51 1 266 096	11 51 1 705 236	11 51 1 705 273	11 51 1 707 414
11 51 9 070 757			

**50 005 000**

→07.1979

635 CSi (E24)**49**

03.1982→04.1989

M30 B35 L, M30 B35 M.E, M30 B35 M.E7

Reference

11 51 1 271 436	11 51 1 272 613	11 51 1 286 417	11 51 1 287 367
11 51 1 707 190	11 51 1 707 191	11 51 1 707 192	11 51 1 707 193
11 51 1 720 883	11 51 1 720 892	11 51 1 720 893	11 51 9 070 760
11 51 9 070 761			

**50 005 004****518 1.8 (E28)****50**

06.1981→08.1984

M10 B18 S

Reference

11 51 1 274 583	11 51 1 274 584	11 51 1 286 355	11 51 1 286 358
11 51 1 286 388	11 51 1 721 477	11 51 9 070 755	

**50 005 009**

06.1981→08.1984

M10 B18 S

Reference

11 51 0 786 821	11 51 1 258 701	11 51 1 258 932	11 51 1 258 933
11 51 1 259 660			

**50 005 019****518 1.8i (E28)****51**

06.1981→12.1987

M10 B18 LE

Reference

11 51 1 274 583	11 51 1 274 584	11 51 1 286 355	11 51 1 286 358
11 51 1 286 388	11 51 1 721 477	11 51 9 070 755	

**50 005 009****520 2.0i (E28)****52**

06.1981→12.1987

M20 B20 LE, M20B 20 K

Reference

11 51 1 271 435	11 51 1 272 616	11 51 1 706 564	11 51 1 706 588
11 51 1 706 624	11 51 1 711 492	11 51 9 058 996	11 51 9 071 562

M20 B20 LE: →08.1987

**50 005 018**

12.1986→12.1987

M20 B20 LE

Reference

11 51 1 519 836	11 51 1 719 836	11 51 1 720 609	11 51 9 070 758
11 51 9 070 759			

09.1987→

**50 005 510****524d 2.4 (E28)****53**

09.1986→12.1987









M21 D24 W

Reference

11 51 1 284 247	11 51 1 285 510	11 51 1 287 580	11 51 2 241 641
11 51 2 242 675	11 51 9 070 765		











**50 005 512**















524dt 2.4 (E28)					54	
09.1983→12.1987	M21 D24 WA					50 005 511
Reference	11 51 2 242 176	11 51 2 242 677	11 51 9 071 564			
09.1983→12.1987	M21 D24 WA					50 005 512
Reference	11 51 1 284 247 11 51 2 242 675	11 51 1 285 510 11 51 9 070 765	11 51 1 287 580	11 51 2 241 641		
525 2.5i (E28)					55	
06.1981→12.1987	M30 B25 L					50 005 004
Reference	11 51 1 271 436	11 51 1 272 613	11 51 1 286 417	11 51 1 287 367		
	11 51 1 707 190	11 51 1 707 191	11 51 1 707 192	11 51 1 707 193		
	11 51 1 720 883	11 51 1 720 892	11 51 1 720 893	11 51 9 070 760		
	11 51 9 070 761					
525e 2.7i (E28)					56	
03.1983→12.1987	M20 B27 MEE					50 005 018
Reference	11 51 1 271 435	11 51 1 272 616	11 51 1 706 564	11 51 1 706 588		
	11 51 1 706 624	11 51 1 711 492	11 51 9 058 996	11 51 9 071 562		
528 2.8i (E28)					57	
06.1981→12.1987	M30 B28 L					50 005 004
Reference	11 51 1 271 436	11 51 1 272 613	11 51 1 286 417	11 51 1 287 367		
	11 51 1 707 190	11 51 1 707 191	11 51 1 707 192	11 51 1 707 193		
	11 51 1 720 883	11 51 1 720 892	11 51 1 720 893	11 51 9 070 760		
	11 51 9 070 761					
535 3.4i (E28)					58	
03.1985→12.1987	M30 B34 M.45, M30 B35 M.E					50 005 004
Reference	11 51 1 271 436	11 51 1 272 613	11 51 1 286 417	11 51 1 287 367		
	11 51 1 707 190	11 51 1 707 191	11 51 1 707 192	11 51 1 707 193		
	11 51 1 720 883	11 51 1 720 892	11 51 1 720 893	11 51 9 070 760		
	11 51 9 070 761					
M 535 3.4i (E28)					59	
09.1984→12.1987	M30 B34 ME					50 005 004
Reference	11 51 1 271 436	11 51 1 272 613	11 51 1 286 417	11 51 1 287 367		
	11 51 1 707 190	11 51 1 707 191	11 51 1 707 192	11 51 1 707 193		
	11 51 1 720 883	11 51 1 720 892	11 51 1 720 893	11 51 9 070 760		
	11 51 9 070 761					
316 1.6i (E30)					60	
09.1988→12.1991	M40 B16 ME.8					50 005 005
Reference	11 51 1 715 292	11 51 1 721 337	11 51 9 070 763			
316 1.8 (E30)					61	
09.1982→12.1988	M10 B18 V					50 005 009
Reference	11 51 1 274 583	11 51 1 274 584	11 51 1 286 355	11 51 1 286 358		
	11 51 1 286 388	11 51 1 721 477	11 51 9 070 755			



B

316 1.8i (E30)					62			
08.1987→12.1988	M10 B18 LE							
Reference	11 51 1 274 583 11 51 1 286 388	11 51 1 274 584 11 51 1 721 477	11 51 1 286 355 11 51 9 070 755	11 51 1 286 358				50 005 009
318 1.8i (E30)					63			
07.1982→12.1987	M10 B18 K							
Reference	11 51 1 274 583 11 51 1 286 388	11 51 1 274 584 11 51 1 721 477	11 51 1 286 355 11 51 9 070 755	11 51 1 286 358				50 005 009
09.1987→04.1994	M40 B18 M.E							
Reference	11 51 0 007 039	11 51 1 727 123	11 51 1 734 269					50 005 514
07.1982→12.1987	M10 B18 K							
Reference	11 51 0 786 821 11 51 1 259 660	11 51 1 258 701	11 51 1 258 932	11 51 1 258 933				50 005 019
318 1.8i 16V (E30)					64			
09.1989→12.1991	M42 B18							
Reference	11 51 0 393 338 11 51 1 734 602	11 51 1 721 872	11 51 1 727 468	11 51 1 734 595				50 005 515
320 1.8i (E30) (AUS/J/S/USA)					65			
11.1979→12.1983	M10 B18 K							
Reference	11 51 1 274 583 11 51 1 286 388	11 51 1 274 584 11 51 1 721 477	11 51 1 286 355 11 51 9 070 755	11 51 1 286 358				50 005 009
11.1979→12.1983	M10 B18 K							
Reference	11 51 0 786 821 11 51 1 259 660	11 51 1 258 701	11 51 1 258 932	11 51 1 258 933				50 005 019
320 1.8i (E30) (J/USA)					66			
10.1983→1986	M10 B18 LU							
Reference	11 51 1 271 435 11 51 1 706 624	11 51 1 272 616 11 51 1 711 492	11 51 1 706 564 11 51 9 058 996	11 51 1 706 588 11 51 9 071 562				50 005 018
10.1983→1986	M10 B18 LU							
Reference	11 51 1 519 836 11 51 9 070 759	11 51 1 719 836	11 51 1 720 609	11 51 9 070 758				50 005 510
320 1.8i (E30) (USA)					67			
1980 → 09.1983	M10 B18 K							
Reference	11 51 1 274 583 11 51 1 286 388	11 51 1 274 584 11 51 1 721 477	11 51 1 286 355 11 51 9 070 755	11 51 1 286 358				50 005 009



							
1980 → 09.1983 Reference	M10 B18 K 11 51 0 786 821 11 51 1 259 660	11 51 1 258 701	11 51 1 258 932	11 51 1 258 933			50 005 019
320 2.0i (E30)							68
09.1977→06.1991 Reference	M20 B20 L, M20 B20 LE, M20B 20 K 11 51 1 271 435 11 51 1 272 616 11 51 1 706 564 11 51 1 706 588 11 51 1 706 624 11 51 1 711 492 11 51 9 058 996 11 51 9 071 562 M20 B20 LE: →08.1987						50 005 018
12.1985→06.1991 Reference	M20 B20 LE, M20 B20 M1.Z7 11 51 1 519 836 11 51 1 719 836 11 51 1 720 609 11 51 9 070 758 11 51 9 070 759 M20 B20 LE: 09.1987→						50 005 510
320 2.0i (E30) (AUS/CH/S)							69
09.1982→1987 Reference	M20 B20 L 11 51 1 271 435 11 51 1 272 616 11 51 1 706 564 11 51 1 706 588 11 51 1 706 624 11 51 1 711 492 11 51 9 058 996 11 51 9 071 562						50 005 018
323 2.3i (E30)							70
09.1983→08.1986 Reference	M20 B23 L 11 51 1 271 435 11 51 1 272 616 11 51 1 706 564 11 51 1 706 588 11 51 1 706 624 11 51 1 711 492 11 51 9 058 996 11 51 9 071 562						50 005 018
323 2.3i (E30) (CH)							71
09.1982→12.1986 Reference	M20 B23 LE 11 51 1 271 435 11 51 1 272 616 11 51 1 706 564 11 51 1 706 588 11 51 1 706 624 11 51 1 711 492 11 51 9 058 996 11 51 9 071 562						50 005 018
324d 2.4 (E30)							72
09.1985→12.1990 Reference	M21 D24 W 11 51 1 284 247 11 51 1 285 510 11 51 1 287 580 11 51 2 241 641 11 51 2 242 675 11 51 9 070 765						50 005 512
324dt 2.4 (E30)							73
10.1987→12.1990 Reference	M21 D24 WA 11 51 2 242 176 11 51 2 242 677 11 51 9 071 564						50 005 511
10.1987→12.1990 Reference	M21 D24 WA 11 51 1 284 247 11 51 1 285 510 11 51 1 287 580 11 51 2 241 641 11 51 2 242 675 11 51 9 070 765						50 005 512

B

**B****325 2.5i (E30)****74**

09.1985→06.1991	M20 B25 M.E				
Reference	11 51 1 271 435	11 51 1 272 616	11 51 1 706 564	11 51 1 706 588	
	11 51 1 706 624	11 51 1 711 492	11 51 9 058 996	11 51 9 071 562	

**50 005 018**

09.1987→06.1991	M20 B25 M1.Z7				
Reference	11 51 1 519 836	11 51 1 719 836	11 51 1 720 609	11 51 9 070 758	
	11 51 9 070 759				

**50 005 510****840 Ci 32V (E31)****75**

01.1995→04.1998	M62 B44				
Reference	11 51 0 393 340	11 51 1 742 647			
	→09.1998				

**50 005 519**

01.1995→04.1998	M62 B44				
Reference	11 51 1 713 266				
	10.1998→				

**50 005 778****730 3.0i (E32)****76**

12.1986→08.1988	M30 B30 M.E7				
Reference	11 51 1 271 436	11 51 1 272 613	11 51 1 286 417	11 51 1 287 367	
	11 51 1 707 190	11 51 1 707 191	11 51 1 707 192	11 51 1 707 193	
	11 51 1 720 883	11 51 1 720 892	11 51 1 720 893	11 51 9 070 760	
	11 51 9 070 761				

**50 005 004**

09.1991→10.1994	M60 B30				
Reference	11 51 0 007 042	11 51 1 704 600	11 51 1 731 680	11 51 1 736 146	
	11 51 1 741 001	11 51 1 742 498			

**50 005 517****735 3.5i (E32)****77**

06.1986→03.1994	M30 B35 M.E, M30 B35 M.E7				
Reference	11 51 1 271 436	11 51 1 272 613	11 51 1 286 417	11 51 1 287 367	
	11 51 1 707 190	11 51 1 707 191	11 51 1 707 192	11 51 1 707 193	
	11 51 1 720 883	11 51 1 720 892	11 51 1 720 893	11 51 9 070 760	
	11 51 9 070 761				

**50 005 004****740 4.0i 32V (E32)****78**

07.1993→05.1994	M60 B40				
Reference	11 51 0 007 042	11 51 1 704 600	11 51 1 731 680	11 51 1 736 146	
	11 51 1 741 001	11 51 1 742 498			

**50 005 517****518 1.8i (E34)****79**









09.1989→05.1995	M40 B18 M.E				
Reference	11 51 0 007 039	11 51 1 727 123	11 51 1 734 269		
	09.1991→05.1994				

**50 005 514**

09.1989→05.1995	M40 B18 M.E				
Reference	11 51 1 715 292	11 51 1 721 337	11 51 9 070 763		
	→08.1991				

**50 005 005**











**B**

518g 1.8i (E34)					80	
09.1990→06.1996	M43 B18 Gas					50 005 515
Reference	11 51 0 393 338 11 51 1 734 602	11 51 1 721 872	11 51 1 727 468	11 51 1 734 595		
520 2.0i (E34)					81	
12.1986→09.1990	M20 B20 M1.Z7, M20 B20 MO.E8					50 005 510
Reference	11 51 1 519 836 11 51 9 070 759	11 51 1 719 836	11 51 1 720 609	11 51 9 070 758		
520 2.0i 24V (E34)					82	
09.1991→12.1996	M50 B20, M52 B20					50 005 513
Reference	11 51 1 433 712 11 51 1 730 414 11 51 7 504 040	11 51 1 433 828 11 51 1 740 241 11 51 7 527 799	11 51 1 437 648 11 51 1 744 243 11 51 7 527 910	11 51 1 722 536 11 51 7 503 884		
524td 2.4 (E34)					83	
11.1987→09.1991	M21 D24 WA					50 005 511
Reference	11 51 2 242 176	11 51 2 242 677	11 51 9 071 564			
11.1987→09.1991	M21 D24 WA					50 005 512
Reference	11 51 1 284 247 11 51 2 242 675	11 51 1 285 510 11 51 9 070 765	11 51 1 287 580	11 51 2 241 641		
525 2.5i (E34)					84	
09.1987→01.1990	M20 B25 M.E/8, M20 B25 M1.Z7					50 005 510
Reference	11 51 1 519 836 11 51 9 070 759	11 51 1 719 836	11 51 1 720 609	11 51 9 070 758		
525 2.5i 24V (E34)					85	
01.1989→06.1996	M50 B25 M, M50 B25 TU					50 005 513
Reference	11 51 1 433 712 11 51 1 730 414 11 51 7 504 040	11 51 1 433 828 11 51 1 740 241 11 51 7 527 799	11 51 1 437 648 11 51 1 744 243 11 51 7 527 910	11 51 1 722 536 11 51 7 503 884		
525td 2.5 (E34)					86	
12.1992→06.1996	M51 D25 UL					50 005 516
Reference	11 51 2 243 003 11 51 9 069 529	11 51 2 244 333	11 51 2 245 687	11 51 9 068 606		
525tds 2.5 (E34)					87	
09.1991→06.1996	M51 D25 OL					50 005 516
Reference	11 51 2 243 003 11 51 9 069 529	11 51 2 244 333	11 51 2 245 687	11 51 9 068 606		

**BMW****B**

530 3.0i V8 (E34)							88
05.1992→06.1996	M60 B30						
Reference	11 51 0 007 042 11 51 1 741 001	11 51 1 704 600 11 51 1 742 498	11 51 1 731 680	11 51 1 736 146			50 005 517
535 3.5i (E34)							89
11.1987→01.1992	M30 B35 M.E7						
Reference	11 51 1 271 436 11 51 1 707 190 11 51 1 720 883 11 51 9 070 761	11 51 1 272 613 11 51 1 707 191 11 51 1 720 892	11 51 1 286 417 11 51 1 707 192 11 51 1 720 893	11 51 1 287 367 11 51 1 707 193 11 51 9 070 760			50 005 004
540 4.0i 32V (E34)							90
03.1992→06.1996	M60 B40						
Reference	11 51 0 007 042 11 51 1 741 001	11 51 1 704 600 11 51 1 742 498	11 51 1 731 680	11 51 1 736 146			50 005 517
316 1.6i (E36)							91
09.1990→01.1994	M40 B16						
Reference	11 51 0 007 039	11 51 1 727 123	11 51 1 734 269				50 005 514
316g 1.6i (E36)							92
08.1993→08.2000	M43 B16						
Reference	11 51 0 393 338 11 51 1 734 602	11 51 1 721 872	11 51 1 727 468	11 51 1 734 595			50 005 515
316 1.9i (E36)							93
09.1998→2001	M43 B19 TU UL						
Reference	11 51 0 393 338 11 51 1 734 602	11 51 1 721 872	11 51 1 727 468	11 51 1 734 595			50 005 515
318 1.8i 16V (E36)							94
04.1989→12.1996	M42 B18						
Reference	11 51 0 393 338 11 51 1 734 602	11 51 1 721 872	11 51 1 727 468	11 51 1 734 595			50 005 515
318 1.9i 16V (E36)							95
09.1996→09.2000	M44 B19						
Reference	11 51 0 393 338 11 51 1 734 602	11 51 1 721 872	11 51 1 727 468	11 51 1 734 595			50 005 515
318tds 1.7 (E36)							96
09.1994→02.1998	M41 B17						
Reference	11 51 2 243 003 11 51 9 069 529	11 51 2 244 333	11 51 2 245 687	11 51 9 068 606			50 005 516



318g 1.8i (E36)								97
09.1993→04.1999	M43 B18 Gas							
Reference	11 51 0 393 338 11 51 1 734 602	11 51 1 721 872	11 51 1 727 468	11 51 1 734 595				50 005 515
320 2.0i 24V (E36)								98
04.1990→03.1998	M50 B20, M50 B20 TU, M52 B20							
Reference	11 51 1 433 712 11 51 1 730 414 11 51 7 504 040	11 51 1 433 828 11 51 1 740 241 11 51 7 527 799	11 51 1 437 648 11 51 1 744 243 11 51 7 527 910	11 51 1 722 536 11 51 7 503 884				50 005 513
323 2.3i 24V (E36)								99
05.1995→09.2000	M52 B25							
Reference	11 51 1 433 712 11 51 1 730 414 11 51 7 504 040	11 51 1 433 828 11 51 1 740 241 11 51 7 527 799	11 51 1 437 648 11 51 1 744 243 11 51 7 527 910	11 51 1 722 536 11 51 7 503 884				50 005 513
325 2.5i 24V (E36)								100
09.1992→05.1995	M50 B25 TU							
Reference	11 51 1 433 712 11 51 1 730 414 11 51 7 504 040	11 51 1 433 828 11 51 1 740 241 11 51 7 527 799	11 51 1 437 648 11 51 1 744 243 11 51 7 527 910	11 51 1 722 536 11 51 7 503 884				50 005 513
325td 2.5 (E36)								101
06.1991→02.1998	M51 D25 TU UL, M51 D25 UL							
Reference	11 51 2 243 003 11 51 9 069 529	11 51 2 244 333	11 51 2 245 687	11 51 9 068 606				50 005 516
325tds 2.5 (E36)								102
06.1993→02.1998	M51 D25 OL							
Reference	11 51 2 243 003 11 51 9 069 529	11 51 2 244 333	11 51 2 245 687	11 51 9 068 606				50 005 516
328 2.8i 24V (E36)								103
09.1994→10.1999	M52 B28 GG							
Reference	11 51 1 433 712 11 51 1 730 414 11 51 7 504 040	11 51 1 433 828 11 51 1 740 241 11 51 7 527 799	11 51 1 437 648 11 51 1 744 243 11 51 7 527 910	11 51 1 722 536 11 51 7 503 884				50 005 513
Z3 1.9i (E36/7)								104
09.1998→09.2002	M43 B19 TU OL							
Reference	11 51 0 393 338 11 51 1 734 602	11 51 1 721 872	11 51 1 727 468	11 51 1 734 595				50 005 515
Z3 1.9i 16V (E36/7)								105
09.1995→09.1999	M44 B19							
Reference	11 51 0 393 338 11 51 1 734 602	11 51 1 721 872	11 51 1 727 468	11 51 1 734 595				50 005 515
Z3 2.0i 24V (E36/7)								106
04.1999→12.2000	M52 B20							
Reference	11 51 1 433 712 11 51 1 730 414 11 51 7 504 040	11 51 1 433 828 11 51 1 740 241 11 51 7 527 799	11 51 1 437 648 11 51 1 744 243 11 51 7 527 910	11 51 1 722 536 11 51 7 503 884				50 005 513

**B****Z3 2.8i 24V (E36/7)****107**

09.1996→09.2000	M52 B28 GG, M52 B28 TU					50 005 513
Reference	11 51 1 433 712	11 51 1 433 828	11 51 1 437 648	11 51 1 722 536		
	11 51 1 730 414	11 51 1 740 241	11 51 1 744 243	11 51 7 503 884		
	11 51 7 504 040	11 51 7 527 799	11 51 7 527 910			

**725tds 2.5 (E38)****108**

03.1996→02.2000	M51 D25 TU OL					50 005 516
Reference	11 51 2 243 003	11 51 2 244 333	11 51 2 245 687	11 51 9 068 606		
	11 51 9 069 529					

**728 2.8i 24V (E38)****109**

05.1995→10.2001	M52 B28 GG, M52 B28 TU					50 005 513
Reference	11 51 1 433 712	11 51 1 433 828	11 51 1 437 648	11 51 1 722 536		
	11 51 1 730 414	11 51 1 740 241	11 51 1 744 243	11 51 7 503 884		
	11 51 7 504 040	11 51 7 527 799	11 51 7 527 910			

**730d 3.0 24V (E38)****110**

09.1998→07.2001	M57 D30 (135 kW)		50 005 785
Reference	11 51 7 786 192		
	→09.1999		



09.1998→07.2001	M57 D30 (135 kW)		50 005 786
Reference	11 51 2 354 055		
	10.1999→		

**735 3.5i 32V (E38)****111**

03.1996→09.2001	M62 B35, M62 B35 TU			50 005 519
Reference	11 51 0 393 340	11 51 1 742 647		
	→09.1998			



03.1996→09.2001	M62 B35, M62 B35 TU			50 005 778
Reference	11 51 1 713 266			
	10.1998→			

**740 4.0i 32V (E38)****112**













03.1996→10.2001	M62 B44, M62 B44 TU			50 005 519
Reference	11 51 0 393 340	11 51 1 742 647		
	→09.1998			



03.1996→10.2001	M62 B44, M62 B44 TU			50 005 778
Reference	11 51 1 713 266			
	10.1998→			





					
520 2.0i 24V (E39)					113
01.1996→09.2000	M52 B20				
Reference	11 51 1 433 712	11 51 1 433 828	11 51 1 437 648	11 51 1 722 536	
	11 51 1 730 414	11 51 1 740 241	11 51 1 744 243	11 51 7 503 884	
	11 51 7 504 040	11 51 7 527 799	11 51 7 527 910		
523 2.5i 24V (E39)					114
09.1995→09.2000	M52 B25				
Reference	11 51 1 433 712	11 51 1 433 828	11 51 1 437 648	11 51 1 722 536	
	11 51 1 730 414	11 51 1 740 241	11 51 1 744 243	11 51 7 503 884	
	11 51 7 504 040	11 51 7 527 799	11 51 7 527 910		
525td 2.5 (E39)					115
01.1996→09.2000	M51 D25 UL				
Reference	11 51 2 243 003	11 51 2 244 333	11 51 2 245 687	11 51 9 068 606	
	11 51 9 069 529				
525tds 2.5 (E39)					116
01.1996→02.2000	M51 D25 TU OL				
Reference	11 51 2 243 003	11 51 2 244 333	11 51 2 245 687	11 51 9 068 606	
	11 51 9 069 529				
528 2.8i 24V (E39)					117
09.1995→09.2000	M52 B28 GG, M52 B28 TU				
Reference	11 51 1 433 712	11 51 1 433 828	11 51 1 437 648	11 51 1 722 536	
	11 51 1 730 414	11 51 1 740 241	11 51 1 744 243	11 51 7 503 884	
	11 51 7 504 040	11 51 7 527 799	11 51 7 527 910		
530d 3.0 24V (E39)					118
09.1998→05.2004	M57 D30 (135 kW)				
Reference	11 51 7 786 192				
	→09.1999				
09.1998→05.2004	M57 D30 (135 kW)				
Reference	11 51 2 354 055				
	10.1999→				
535 3.5i 32V (E39)					119
06.1996→2000	M62 B35, M62 B35 TU				
Reference	11 51 0 393 340	11 51 1 742 647			
	→09.1998				
06.1996→2000	M62 B35, M62 B35 TU				
Reference	11 51 1 713 266				
	10.1998→				

B

**B****540 4.4i 32V (E39)****120**

01.1996→04.2004 M62 B44, M62 B44 TU
 Reference 11 51 0 393 340 11 51 1 742 647
 →09.1998

**50 005 519**

01.1996→04.2004 M62 B44, M62 B44 TU
 Reference 11 51 1 713 266
 10.1998→

**50 005 778****316g 1.6i (E46)****121**

11.1998→08.2001 M43 B16
 Reference 11 51 0 393 338 11 51 1 721 872 11 51 1 727 468 11 51 1 734 595
 11 51 1 734 602

**50 005 515****316 1.6i 16V (E46)****122**

03.2004→03.2005 N45 B16
 Reference 11 51 7 511 220 11 51 7 511 221

**50 005 011**
NEW**316 1.8i 16V (E46)****123**

04.2001→03.2004 N42 B18
 Reference 11 51 7 511 220 11 51 7 511 221

**50 005 011**
NEW**316 1.9i (E46)****124**

04.1998→2001 M43 B19 TU UL
 Reference 11 51 0 393 338 11 51 1 721 872 11 51 1 727 468 11 51 1 734 595
 11 51 1 734 602

**50 005 515****318 1.9i (E46)****125**

04.1998→09.2001 M43 B19 TU OL
 Reference 11 51 0 393 338 11 51 1 721 872 11 51 1 727 468 11 51 1 734 595
 11 51 1 734 602

**50 005 515****318 2.0i 16V (E46)****126**









09.2001→03.2005 N42 B20, N42 B20A, N46 B20
 Reference 11 51 7 511 220 11 51 7 511 221

**50 005 011**
NEW**320 2.0i 24V (E46)****127**

03.1998→09.2001 M52 B20
 Reference 11 51 1 433 712 11 51 1 433 828 11 51 1 437 648 11 51 1 722 536
 11 51 1 730 414 11 51 1 740 241 11 51 1 744 243 11 51 7 503 884
 11 51 7 504 040 11 51 7 527 799 11 51 7 527 910









**50 005 513**

**B**





320d 16V (E46)					128	
09.2001→02.2005	M47 D20TU OL					50 005 784
Reference	11 51 7 788 305	11 51 7 791 834				
328 2.8i 24V (E46)					129	
04.1998→09.2000	M52 B28 TU					50 005 513
Reference	11 51 1 433 712	11 51 1 433 828	11 51 1 437 648	11 51 1 722 536		
	11 51 1 730 414	11 51 1 740 241	11 51 1 744 243	11 51 7 503 884		
	11 51 7 504 040	11 51 7 527 799	11 51 7 527 910			
330d 3.0 24V (E46)					130	
09.1999→02.2003	M57 D30 (135 kW)					50 005 785
Reference	11 51 7 786 192					
X5 4.4i 32V (E53)					131	
03.1999→09.2006	M62 B44 TU					50 005 778
Reference	11 51 1 713 266					
X3 2.0i 16V (E83)					132	
09.2005→	N46 B20 OL					50 005 011 <small>NEW</small>
Reference	11 51 7 511 220	11 51 7 511 221				
Z4 2.0i (E85)					133	
04.2005→	N46 B20 OL					50 005 011 <small>NEW</small>
Reference	11 51 7 511 220	11 51 7 511 221				
116 1.6i 16V (E87)					134	
09.2004→03.2007	N45 B16					50 005 011 <small>NEW</small>
Reference	11 51 7 511 220	11 51 7 511 221				
118 2.0i 16V (E87)					135	
12.2004→03.2007	N46 B20 UL					50 005 011 <small>NEW</small>
Reference	11 51 7 511 220	11 51 7 511 221				



B

120 2.0i 16V (E87) 136									
09.2004→03.2007	N46 B20 OL								
Reference	11 51 7 511 220	11 51 7 511 221						50 005 011	NEW
316 1.6i 16V (E90) 137									
09.2004→03.2007	N45 B16								
Reference	11 51 7 511 220	11 51 7 511 221						50 005 011	NEW
318 2.0i 16V (E90) 138									
09.2005→03.2007	N46 B20 UL								
Reference	11 51 7 511 220	11 51 7 511 221						50 005 011	NEW
320 2.0i 16V (E90) 139									
03.2005→03.2007	N46 B20 OL								
Reference	11 51 7 511 220	11 51 7 511 221						50 005 011	NEW
318 2.0i 16V (E91) 140									
09.2005→03.2007	N46 B20 UL								
Reference	11 51 7 511 220	11 51 7 511 221						50 005 011	NEW
320 2.0i 16V (E91) 141									
09.2005→03.2007	N46 B20 OL								
Reference	11 51 7 511 220	11 51 7 511 221						50 005 011	NEW
316 1.6i 16V (E92) 142									
09.2004→03.2007	N45 B16								
Reference	11 51 7 511 220	11 51 7 511 221						50 005 011	NEW
Z1 2.5i 143									
07.1988→06.1991	M20 B25 M1.Z7								
Reference	11 51 1 519 836	11 51 1 719 836	11 51 1 720 609	11 51 9 070 758				50 005 510	
	11 51 9 070 759								



			Cyl	 mm	cm ³	 Comp. Ratio ε	kW	PS	Pos
A16DMS	B		4	79 x 81,5	1598	4 9,5:1	77-80	105-109	5, 9, 11, 13, 14, 15
B12S1	B		4	68,5 x 78	1148	2 9,3:1	53	72	2, 6
F14D3 (69 kW)	B		4	77,9 x 73,4	1399	4 9,5:1	69-70	94-95	4, 8, 10, 12
F14S3	B		4	77,9 x 73,4	1399	2 9,5:1	61	83	3, 7
Z 22 SE	B		4	86 x 94,6	2198	4 10:1	108	147	1

C



Astra G 2.2i 16V

1

09.2002→

Z 22 SE



50 005 792

Aveo 1.2i

2

02.2006→

B12S1



50 005 075

NEW

Aveo 1.4i

3

02.2006→

F14S3



50 005 072

NEW

Aveo 1.4i 16V

4

02.2006→

F14D3 (69 kW)



50 005 076

NEW

Aveo 1.6i 16V

5

09.2005→

A16DMS



50 005 076

NEW

Kalos 1.2i

6

02.2005→

B12S1



50 005 075

NEW

Kalos 1.4i

7

02.2005→

F14S3



50 005 072

NEW

Kalos 1.4i 16V

8

02.2005→

F14D3 (69 kW)



50 005 076

NEW

C

**Kalos 1.6i 16V****9**

02.2005→

A16DMS

**50 005 076**
NEW**C****Lacetti 1.4i 16V****10**

02.2005→

F14D3 (69 kW)

**50 005 076**
NEW**Lacetti 1.6i 16V****11**

02.2005→

A16DMS

**50 005 076**
NEW**Nubira 1.4i 16V****12**

02.2005→

F14D3 (69 kW)

**50 005 076**
NEW**Nubira 1.6i 16V****13**

02.2005→

A16DMS

**50 005 076**
NEW**Rezzo 1.6i 16V****14**

02.2005→

A16DMS

**50 005 076**
NEW**Tacuma 1.6i 16V****15**





02.2005→

A16DMS

**50 005 076**
NEW



C

			Cyl	 mm	cm ³		Comp. Ratio ε	kW	PS	Pos
6G72 (104 kW)	B		6	91,1 x 76	2972	2	8,9:1	104	141	5
J5R 800	B		4	88 x 82	1995	2	9,2:1	62	85	3
J8S 800	D	(AN)	4	86 x 89	2068	2	21,5:1	44	60	4
J8S 890	D	(A)	4	86 x 89	2068	2	21,5:1	64	87	1
M 112.955	B		6	89,9 x 84	3199	3	10:1	160	218	2



Cherokee 2.1 TD

1

01.1988→08.1995 J8S 890
Reference 77 01 461 336

**50 005 323****C**

Crossfire 3.2i

2

07.2003→ M 112.955
Reference 112 200 02 01 112 200 04 01 112 200 11 01 112 200 14 01

**50 005 457**

07.2003→ M 112.955
Reference 112 200 05 01 112 200 10 01 112 200 12 01 112 200 15 01

**50 005 456**

Jeep CJ-7 2.0

3

10.1983→12.1986 J5R 800
Reference 77 01 461 336

**50 005 323**

Jeep CJ-7 2.1 D

4

01.1988→12.1998 J8S 800
Reference 77 01 461 336

**50 005 323**

Voyager I 3.0

5





01.1988→03.1995 6G72 (104 kW)

50 005 128
NEW



			Cyl		mm	cm ³	Comp. Ratio	€	kW	PS	Pos
108 C	B		4	70 x 62	954	2	9,3:1	30-32	41-44		38
109 K	B		4	72 x 69	1116	2	9,7:1	34-36	46-49		39
109 LA	B		4	72 x 69	1124	2	9,7:1	42	57		15
150 D	B		4	75 x 77	1361	2	9,3:1	44	60		40
159 A	B		4	83 x 88	1905	2	9,3:1	77	105		24
161 A	D	(AN)	4	80 x 88	1769	2	23:1	44	60		20, 42, 73, 93, 108
162	D	(AN)	4	83 x 88	1905	2	23,5:1	47-48	64-65		25
170 A	B		4	88 x 81	1971	2	8:1	57-60	77-82		44
170 B	B		4	88 x 81	1971	2	8:1	57-58	77-79		44
170 C	B		4	88 x 81	1971	2	8:1	57-63	77-86		44
170 D	B		4	88 x 81	1971	2	8:1	57	77		44
171 A	B		4	83 x 73	1580	2	9,5:1	66	90		18
171 B	B		4	83 x 73	1580	2	9,5:1	66	90		18, 44
171 C	B		4	83 x 73	1580	2	9,5:1	66-68	90-92		18
171 D	B		4	83 x 73	1580	2	9,2:1	64	87		18
171 Z	B		4	83 x 73	1580	2	9,5:1	66-69	90-94		18
180 A	B		4	83 x 73	1580	2	9,8:1	76	103		72
180 Z	B		4	83 x 73	1580	2	9,8:1	76	103		19
A8A	D	(LA)	4	80 x 88	1769	2	22,5:1	66	90		21
A9A	D	(AN)	4	80 x 88	1769	2	23:1	44	60		12, 93
AJZ	D	(A)	4	80 x 88	1769	2	22,5:1	66	90		21
B1AA	B		4	83 x 73	1580	2	9,5:1	58-59	79-80		18
B1E	B		4	83 x 73	1580	2	8,95:1	53	72		18
BAY	B		4	83 x 73	1580	2	8,95:1	54	73		19
BAZ	B		4	83 x 73	1580	2	8,95:1	54	73		19
BDY	B		4	83 x 73	1580	2	8,95:1	66	90		19, 105
BDZ	B		4	83 x 73	1580	2	9,2:1	65-66	88-90		19
BFZ	B		4	83 x 73	1580	2	9,25:1	65-66	88-90		74, 105
C1A	B		4	70 x 62	954	2	9,4:1	32-34	44-46		1, 38
CDY	B		4	70 x 62	954	2	9,4:1	33-37	45-50		67
CDZ	B		4	70 x 62	954	2	9,4:1	37	50		67
CRD 93 L	D	(AN)	4	93 x 92	2499	2	22,25:1	54-55	73-75		45
CRD 93 LS	D	(A)	4	93 x 92	2499	2	22,5:1	70	95		46
D2A	B		4	83 x 88	1905	2	8,4:1	75	102		24
D2C	B		4	83 x 88	1905	2	8,4:1	70	95		24
D2E	B		4	83 x 88	1905	2	9,9,3:1	78-79	106-107		24
D6A	B		4	83 x 88	1905	2	9,3:1	89-92	121-125		22
D6C	B		4	83 x 88	1905	4	9,7:1	116	158		23
D8A	D	(LA)	4	83 x 88	1905	2	21,8:1	66-68	90-92		95, 111
D8B	D	(LA)	4	83 x 88	1905	2	21,8:1	66-68	90-92		78
D9A	D	(AN)	4	83 x 88	1905	2	23,5:1	47	64		25
D9B	D	(AN)	4	83 x 88	1905	2	23:1	51	69		13, 25, 64, 77, 110
DDZ	B		4	83 x 88	1905	2	9,2:1	80	109		22
DFW	B		4	83 x 88	1905	4	9,7:1	108	147		23
DFZ	B		4	83 x 88	1905	2	9,3:1	75-77	102-105		22
DHV	D	(LA)	4	83 x 88	1905	2	21,8:1	66-68	90-92		95
DHW	D	(LA)	4	83 x 88	1905	2	21,8:1	55	75		78, 95
DHX	D	(LA)	4	83 x 88	1905	2	21,8:1	66-68	90-92		78
DHY	D	(LA)	4	83 x 88	1905	2	21,8:1	66-68	90-92		78, 95, 111
DJY	D	(AN)	4	83 x 88	1905	2	23,5:1	50-52	68-71		13, 94
DJZ	D	(AN)	4	83 x 88	1905	2	23,5:1	47-48	64-65		25, 77, 110
DKZ	B		4	83 x 88	1905	2	9,25:1	88-90	120-122		22, 109
E1 A	B		4	72 x 69	1124	2	9,4:1	40-41	54-56		39
H1A	B		4	72 x 69	1124	2	9,4:1	40-44	54-60		2, 15, 39, 100
H1B	B		4	72 x 69	1124	2	9,2:1	40-44	54-60		2, 100
HAZ	B		4	72 x 69	1124	2	9,2:1	40	54		2
HDY	B		4	72 x 69	1124	2	9,2:1	44	60		68, 101
HDZ	B		4	72 x 69	1124	2	9,4:1	40-44	54-60		3, 68, 101
HFX	B		4	72 x 69	1124	2	9,7/ 10,5:1	44	60		9, 26, 28, 68
K1A	B		4	75 x 77	1361	2	9,3:1	47	64		5
K1B	B		4	75 x 77	1361	2	9,3:1	44	60		5
K1F	B		4	75 x 77	1361	2	9,3:1	49	67		5, 16
K1G	B		4	75 x 77	1361	2	9,3:1	49-55	67-75		5, 16, 40
K1H	B		4	75 x 77	1361	2	9,3:1	49-51	67-69		16, 40
K2A	B		4	75 x 77	1361	2	9,3:1	62-65	84-88		5
K2B	B		4	75 x 77	1361	2	9,3:1	62-65	84-88		5
K2D	B		4	75 x 77	1361	2	9,3:1	55	75		5, 17, 40, 102
K3A	B		4	75 x 77	1361	2	9,3:1	44-46	60-63		40

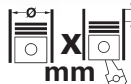



			Cyl	 mm	cm ³		Comp. Ratio ε	kW	PS	Pos
K5A	B		4	75 x 77	1361	2	9,3:1	51-55	69-75	102
K6B	B		4	75 x 77	1361	2	9,9:1	74	100	7
K9A	D	(AN)	4	75 x 77	1361	2	22:1	39	53	6
KAY	B		4	75 x 77	1361	2	9,3:1	44	60	5
KAZ	B		4	75 x 77	1361	2	9,3:1	44-55	60-75	16, 40
KDY	B		4	75 x 77	1361	2	9,3:1	55-58	75-79	7, 17, 41, 103
KDZ	B		4	75 x 77	1361	2	9,3:1	55	75	7, 17, 103
KFU	B		4	75 x 77	1361	4	10,2:1	65	88	27, 29, 31
KFV	B		4	75 x 77	1361	2	10,2:1	54	73	30
KFX	B		4	75 x 77	1361	2	10,2:1	54-55	73-75	10, 69, 88
KFY	B		4	75 x 77	1361	2	9,3:1	66	90	7
KFZ	B		4	75 x 77	1361	2	9,3:1	69-70	94-95	7
L6A	B		4	83 x 81,4	1761	2	9,3:1	70-76	95-103	75, 91, 106
LFW	B		4	83 x 81,4	1761	2	9,25:1	72	98	52
LFX	B		4	83 x 81,4	1761	2	10,4:1	66	90	11, 75, 91
LFY	B		4	83 x 81,4	1761	4	10,4:1	82	112	76, 92, 107
LFZ	B		4	83 x 81,4	1761	2	9,25:1	74-76	101-103	52, 75, 91, 106
M 23/622	B		4	93,5 x 85,5	2347	2	8,75:1	92-96	125-130	47
M 25/648	D	(A)	4	93 x 92	2499	2	21,25:1	88	120	51
M 25/659	B		4	93 x 92	2499	2	8,75:1	101	138	48
M 25/660	D	(AN)	4	93 x 92	2499	2	22,25:1	54-55	73-75	50
M 25/662	B	(A)	4	93 x 92	2499	2	7,75:1	122	166	49
M4A	B		4	75 x 73,2	1294	2	9,6:1	69-70	94-95	4
NFZ	B		4	78,5 x 82	1587	2	10,2:1	66	90	71, 90, 98, 105
P8C	D	(LA)	4	85 x 92	2088	3	21,5:1	80-81	109-110	57, 82, 87
P9A	D	(AN)	4	86 x 92	2138	3	22,5:1	60-61	82-83	87
PJZ	D	(AN)	4	86 x 92	2138	3	22,5:1	60-61	82-83	86
R2A	B		4	86 x 86	1998	2	8,8:1	84-85	114-116	83
R5B	B		4	86 x 86	1998	2	8,8:1	79	107	59
R6A	B		4	86 x 86	1998	2	9,5:1	94	130	84
R6D	B		4	86 x 86	1998	2	8,8:1	89-92	121-125	79, 112
RDZ	B		4	86 x 86	1998	2	8,8:1	79-81	108-110	84
RFK	B		4	85 x 88	1997	4	11,1	130	177	32
RFT	B		4	86 x 86	1998	4	10,4:1	110-114	150-155	80, 113
RFU	B		4	86 x 86	1998	2	9,5:1	89-90	121-123	53
RFV	B		4	86 x 86	1998	4	10,4:1	97-100	132-136	54, 80, 96
RFX	B		4	86 x 86	1998	2	9,5:1	90	122	79, 112
RFY	B		4	86 x 86	1998	4	10,4:1	110-114	150-155	80, 113
RGY	B	(A)	4	86 x 86	1998	2	8,5:1	104-107	141-145	85
RHR	D	(LA)	4	85 x 88	1997	4	18:1	100	136	14, 33, 34, 36, 37, 58, 66
RHV	D	(LA)	4	85 x 88	1997	2	18:1	63-68	86-92	60
RHW	D	(LA)	4	85 x 88	1997	4	18:1	80-81	109-110	37, 56, 66
RHX	D	(LA)	4	85 x 88	1997	2	17,6:1	80	109	65
RHZ	D	(LA)	4	85 x 88	1997	2	17,6:1	80-81	109-110	35, 55, 60, 65, 81, 97, 99
T8A	D	(LA)	4	92 x 92	2446	3	22:1	76	103	62
T9A	D	(AN)	4	92 x 92	2446	3	22:1	63	86	61
THX	D	(LA)	4	92 x 92	2446	2	22:1	79	107	63
THZ	D	(LA)	4	92 x 92	2446	3	22:1	76	103	62
TU 3M/Z	B		4	75 x 77	1361	2	9,3:1	55	75	103
VJX	D	(AN)	4	77 x 82	1527	2	23:1	37-42	50-57	70
VJY	D	(AN)	4	77 x 82	1527	2	23:1	40-42	54-57	8, 70, 89, 104
VJZ	D	(AN)	4	77 x 82	1527	2	23:1	42-43	57-58	8, 70, 89, 104
WJC	D	(AN)	4	82,2 x 88	1868	2	23:1	52	71	13
WJY	D	(AN)	4	82,2 x 88	1868	2	23:1	44-52	60-71	13, 43
WJZ	D	(AN)	4	82,2 x 88	1868	2	23:1	51	69	13, 64, 94
XU 52C (65 kW)	B		4	83 x 73	1581	2	9,2:1	65-68	88-92	19
XU 5M	B		4	83 x 73	1581	2	9,3:1	65	88	105

C

**AX 1.0****1**

10.1986→06.1992	C1A							
Reference	1201 E3 9617376980	1207 18	1207 23	9451001263				50 005 310

AX 1.1**2**

10.1986→05.1992	H1A, H1B, HAZ							
Reference	1001 50 H1A, H1B: →12.1991	1001 50				50 005 820		
10.1986→05.1992	H1A, H1B, HAZ							
Reference	1201 E3 9617376980	1207 18	1207 23	9451001263				50 005 310





AX 1.1i**3**

10.1989→05.1992	HDZ							
Reference	1001 50 →12.1991	1001 50				50 005 820		

AX 1.3**4**

04.1987→01.1991	M4A							
Reference	1201 E3 9617376980	1207 18	1207 23	9451001263				50 005 310

AX 1.4**5**

















04.1988→08.1993	K1G, K2D							
Reference	1001 69	1001 69				50 005 853		
10.1986→08.1993	K1A, K1B, K1F, K1G, K2A, K2B, K2D, KAY							
Reference	1001 50 K1F, K1G, K2A, K2B, K2D: →12.1991	1001 50				50 005 820		
10.1986→12.1992	K1A, K1B, K1G, K2B							
Reference	1201 E3 9617376980	1207 18	1207 23	9451001263				50 005 310
10.1987→08.1993	K1G, K2A, K2D							
Reference	1201 58 9608564280 K2A: 5278→	1201 E4	1201 E6	1207 25				50 005 339

AX 1.4 D**6**

09.1988→06.1992	K9A							
Reference	1001 50 →12.1991	1001 50				50 005 820		

C



							
09.1988→06.1992 Reference	K9A 1201 E3 9617376980	1207 18	1207 23	9451001263			50 005 310
AX 1.4i							7
06.1990→12.1996 Reference	KDY 1001 69	1001 69				50 005 853	
06.1988→12.1996 Reference 	K6B, KDY, KDZ, KFY, KFZ 1001 50 →12.1991	1001 50				50 005 820	
06.1990→12.1996 Reference	KDY, KFY 1201 E3 9617376980	1207 18	1207 23	9451001263			50 005 310
AX 1.5 D							8
08.1994→12.1997 Reference	VJY, VJZ 1001 69	1001 69				50 005 853	
Berlingo 1.1i							9
06.2000→ Reference 	HFX 1001 50 →ORGA 09687	1001 50				50 005 820	
06.2000→ Reference	HFX 1201 E3 9617376980	1207 18	1207 23	9451001263			50 005 310
Berlingo 1.4i							10
07.1996→11.2002 Reference 	KFX 1001 50 →ORGA 09687	1001 50				50 005 820	
Berlingo 1.8i							11
03.1997→11.2002 Reference	LFX 1001 77	1001 77				50 005 854	
Berlingo 1.8 D							12
07.1996→11.2002 Reference	A9A 1001 56	1001 56				50 005 815	

C



09.1988→09.1993 Reference 	K2D, KDY, KDZ 1001 50 1001 50 →12.1991, ORGA 04193→			50 005 820
06.1990→09.1993 Reference	KDY 1201 E3 1207 18 1207 23 9451001263 9617376980			50 005 310
09.1991→06.1993 Reference	K2D 1201 58 1201 E4 1201 E6 1207 25 9608564280			50 005 339
BX 1.6				18
10.1982→12.1994 Reference	171 A, 171 B, 171 C, 171 D, B1E 1001 56 1001 56			50 005 815
10.1982→12.1994 Reference 	171 A, 171 B, 171 C, 171 D, 171 Z, B1AA 1201 39 1201 63 91511136 9401201390 95641148 95655207 95656566 171 A, 171 B, 171 C, 171 D, 171 Z: →ch PR5409			50 005 307
BX 1.6i				19
03.1986→12.1994 Reference	180 Z, BAY, BAZ, BDY, BDZ, XU 52C (65 kW) 1001 56 1001 56			50 005 815
03.1986→02.1993 Reference	180 Z 1201 39 1201 63 91511136 9401201390 95641148 95655207 95656566			50 005 307
BX 1.8 D				20
07.1985→09.1993 Reference 	161 A 1201 48 1201 51 1201 60 1201 62 9401201480 95641149 95643824 95655209 95655210 95656568 95656569 3584→			50 005 320
07.1985→09.1993 Reference	161 A 1001 56 1001 56			50 005 815
07.1985→09.1993 Reference 	161 A 1201 39 1201 63 91511136 9401201390 95641148 95655207 95656566 →ch PR3583			50 005 307

C

**BX 1.8 TD****21**

02.1988→12.1994

A8A, AJZ

Reference

1201 48
9401201480
956552101201 51
95641149
956565681201 60
95643824
956565691201 62
95655209**50 005 320****BX 1.9i****22**

03.1986→12.1994

D6A, DDZ, DFZ, DKZ

Reference

1001 56

1001 56

**50 005 815**

07.1986→03.1993

D6A, DKZ

Reference

1201 39
95641148
→ch PR54091201 63
9565520791511136
95656566

9401201390

**50 005 307****BX 1.9i 16V****23**

07.1987→12.1992

D6C

Reference

1201 50
95656567

1201 61

95625017

95655208

**50 005 319**

07.1987→03.1993

D6C, DFW

Reference

1001 56

1001 56

**50 005 815**

03.1988→03.1993

DFW

Reference

1201 39
95641148
→ch PR54091201 63
9565520791511136
95656566

9401201390

**50 005 307****BX 1.9****24**

07.1986→11.1989

159 A, D2A, D2C

Reference

1001 56

1001 56

**50 005 815**

09.1986→09.1993

D2C, D2E

Reference

1201 39
95641148
→ch PR54091201 63
9565520791511136
95656566

9401201390

**50 005 307****BX 1.9 D****25**

09.1983→12.1994

162, D9B, DJZ

Reference

1201 48
9401201480
95655210
162, DJZ: 3584→
D9B: →35841201 51
95641149
956565681201 60
95643824
956565691201 62
95655209**50 005 320**

09.1983→12.1994

162, D9A, D9B

Reference

1001 56

1001 56

**50 005 815**



09.1983→12.1987 Reference 	162 1201 39 95641148 →ch PR3583	1201 63 95655207	91511136 95656566	9401201390			50 005 307
C2 1.1i							26
09.2003→ Reference	HFX 1201 E3 9617376980	1207 18	1207 23	9451001263			50 005 310
C2 1.4i 16V							27
12.2005→ Reference	KFU 1201 G2						50 005 766
C3 1.1i							28
01.2002→ Reference	HFX 1201 E3 9617376980	1207 18	1207 23	9451001263			50 005 310
C3 1.4i 16V							29
10.2003→ Reference	KFU 1201 G2						50 005 766
C3 Plurial 1.4i							30
05.2003→ Reference 	KFV 1001 50 →ORGA 09687	1001 50				50 005 820	
C4 1.4i 16V							31
11.2004→ Reference	KFU 1201 G2						50 005 766
C4 2.0i 16V							32
11.2004→ Reference	RFK 1201 E7	1201 F5	1201 G5				50 005 765

C

**CITROEN****C4 2.0 HDi 16V****33**11.2004→
ReferenceRHR
1201E8

50 005 779

C4 Picasso 2.0 HDi 16V**34**10.2006→
ReferenceRHR
1201E8

50 005 779

C5 2.0 HDi**35**03.2001→09.2004
ReferenceRHZ
1201 C4

50 005 329

C5 2.0 HDi 16V**36**09.2004→
ReferenceRHR
1201E8

50 005 779

C8 2.0 HDi 16V**37**07.2006→
ReferenceRHR
1201E8

50 005 779

06.2002→
ReferenceRHW
1201 C4

50 005 329





C 15 1.0**38**11.1986→12.1997
Reference108 C, C1A
1001 50 1001 50
→12.1991, ORGA 04222→

50 005 820







07.1988→12.1997
ReferenceC1A
1201 E3 1207 18 1207 23 9451001263
9617376980
ch PR4196→

50 005 310





**C 15 1.1****39**

10.1984→12.1996	109 K, E1 A, H1A						50 005 820	
Reference	1001 50	1001 50						
	H1A: →12.1991, ORGA 04222→ 109 K, E1 A: ORGA 04222→							
07.1988→12.1996	H1A							50 005 310
Reference	1201 E3	1207 18	1207 23	9451001263				
	9617376980 ch PR4196→							



C**C 15 1.4****40**

07.1987→12.1996	K1G, K2D						50 005 853	
Reference	1001 69	1001 69						
07.1986→12.1996	150 D, K1G, K2D, K3A, KAZ						50 005 820	
Reference	1001 50	1001 50						
	K1G, K2D, K3A, KAZ: →12.1991, ORGA 04222→ 150 D: ORGA 04222→							
07.1987→12.1996	K1G, K1H							50 005 310
Reference	1201 E3	1207 18	1207 23	9451001263				
	9617376980 ch PR4196→							
07.1987→12.1996	K1G, K2D							50 005 339
Reference	1201 58	1201 E4	1201 E6	1207 25				
	9608564280							

C 15 1.4i**41**

01.1992→12.1996	KDY						50 005 853	
Reference	1001 69	1001 69						
01.1992→12.1996	KDY						50 005 820	
Reference	1001 50	1001 50						
	→12.1991, ORGA 04222→							
01.1992→12.1996	KDY							50 005 310
Reference	1201 E3	1207 18	1207 23	9451001263				
	9617376980							

C 15 1.8 D**42**

07.1986→12.1997	161 A							50 005 320
Reference	1201 48	1201 51	1201 60	1201 62				
	9401201480	95641149	95643824	95655209				
	95655210	95656568	95656569					
	3584→							



07.1986→12.1997 Reference	161 A 1001 56	1001 56					50 005 815
07.1986→12.1997 Reference	161 A 1201 39 95641148 →ch PR3583	1201 63 95655207	91511136 95656566	9401201390			50 005 307
C 15 1.9 D							43
12.2000→12.2005 Reference	WJY 1001 91	1001 91					50 005 826
C 25 2.0							44
09.1981→03.1994 Reference	171 B 1201 39 95641148 →ch PR5409	1201 63 95655207	91511136 95656566	9401201390			50 005 307
09.1981→03.1994 Reference	170 A, 170 B, 170 C, 170 D 1001 30	1001 30	1001 40	1001 40			50 005 863
C 25 2.5 D							45
07.1981→03.1994 Reference	CRD 93 L 1201 36	75530147					50 005 306
C 25 2.5 TD							46
08.1987→03.1994 Reference	CRD 93 LS 1201 36	75530147					50 005 306
CX 2.4i							47
06.1977→06.1983 Reference	M 23/622 1201 36	75530147					50 005 306
CX 2.5i							48
07.1983→12.1992 Reference	M 25/659 1201 36	75530147					50 005 306

**CX 2.5i Turbo****49**

06.1984→12.1987

M 25/662

Reference

1201 36

75530147



50 005 306

C**CX 2.5 D****50**

07.1982→12.1992

M 25/660

Reference

1201 36

75530147



50 005 306

CX 2.5 TD**51**

04.1983→12.1986

M 25/648

Reference

1201 36

75530147



50 005 306

Evasion 1.8i**52**

09.1996→07.2002

LFW

Reference

1201 50
95656567

1201 61

95625017

95655208



50 005 319

09.1996→07.2002

LFW, LFZ

Reference

1001 77

1001 77



50 005 854

Evasion 2.0i**53**

06.1994→07.2002

RFU

Reference

1201 52
1201 A41201 65
956509551201 67
95666768

1201 91



50 005 313

Evasion 2.0i 16V**54**

05.1998→04.2000

RFV

Reference

1001 77

1001 77



50 005 854

Evasion 2.0 HDi**55**

01.1999→07.2002

RHZ

Reference

1001 92

1001 92



50 005 824

01.1999→07.2002

RHZ

Reference

1201 C4



50 005 329

**Evasion 2.0 HDi 16V****56**01.1999→07.2002
ReferenceRHW
1001 92 1001 92**50 005 824**01.1999→07.2002
ReferenceRHW
1201 C4**50 005 329****Evasion 2.1 TD 12V****57**04.1996→07.2002
ReferenceP8C
1201 54 1201 55 1201 A7 1201 C6
1336 L5 96047088**50 005 322****Grand C4 Picasso 2.0 HDi 16V****58**→
ReferenceRHR
1201E8**50 005 779****Jumper 2.0****59**02.1994→02.2002
ReferenceR5B
1201 52 1201 65 1201 67 1201 91
1201 A4 95650955 95666768**50 005 313****Jumper 2.0 HDi****60**09.1998→
ReferenceRHV, RHZ
1201 C4**50 005 329****Jumper 2.5 D 12V****61**02.1994→02.2002
ReferenceT9A
1001 84**50 005 860**
NEW**Jumper 2.5 TD 12V****62**02.1994→02.2002
ReferenceT8A, THZ
1001 84**50 005 860**
NEW**C**

**Jumper 2.5 DI TD****63**10.1996→02.2002
ReferenceTHX
1001 8450 005 860
NEW**C****Jumpy 1.9 D****64**10.1995→
ReferenceD9B
1001 56 1001 56

50 005 815

10.1998→
ReferenceWJZ
1001 91 1001 91

50 005 826

Jumpy 2.0 HDi**65**10.1999→
ReferenceRHX, RHZ
1201 C4

50 005 329

Jumpy 2.0 HDi 16V**66**01.2007→
ReferenceRHR
1201E8

50 005 779

10.1999→
ReferenceRHW
1201 C4

50 005 329

Saxo 1.0i**67**02.1996→09.2003
ReferenceCDY, CDZ
1001 50 1001 50
→ORGA 09687

50 005 820

Saxo 1.1i**68**02.1996→09.2003
ReferenceHDY, HDZ, HFX
1001 50 1001 50
→ORGA 09687

50 005 820

02.1996→09.2003
ReferenceHDY, HDZ, HFX
1201 E3 1207 18 1207 23 9451001263
9617376980

50 005 310

**Saxo 1.4i****69**

02.1996→09.2003

KFX

Reference

1001 50

1001 50

→ORGA 09687

**50 005 820**

02.1996→09.2003

KFX

Reference

1201 E3

1207 18

1207 23

9451001263

9617376980

**50 005 310****Saxo 1.5 D****70**

07.1996→09.2003

VJX, VJY, VJZ

Reference

1001 69

1001 69

**50 005 853****Saxo 1.6i****71**

02.1996→09.2003

NFZ

Reference

1001 69

1001 69

**50 005 853****Visa 1.6i****72**

01.1985→06.1986

180 A

Reference

1201 48

1201 51

1201 60

1201 62

9401201480

95641149

95643824

95655209

95655210

95656568

95656569

3584→

**50 005 320**

01.1985→06.1986

180 A

Reference

1201 39

1201 63

91511136

9401201390

95641148

95655207

95656566

→ch PR3583

**50 005 307****Visa 1.8 D****73**

04.1984→03.1991

161 A

Reference

1201 48

1201 51

1201 60

1201 62

9401201480

95641149

95643824

95655209

95655210

95656568

95656569

3584→

**50 005 320**

04.1984→03.1991

161 A

Reference

1201 39

1201 63

91511136

9401201390

95641148

95655207

95656566

→ch PR3583

**50 005 307****Xantia 1.6i****74**

03.1993→12.2001

BFZ

Reference

1001 77

1001 77

**50 005 854**

**Xantia 1.8i****75**

03.1993→12.2001

L6A, LFX, LFZ

Reference

1001 77

1001 77



50 005 854

C**Xantia 1.8i 16V****76**

06.1995→12.2001

LFY

Reference

1001 77

1001 77

→ORGA 08133



50 005 854

Xantia 1.9 D**77**

07.1993→01.1998

D9B, DJZ

Reference

1001 56

1001 56



50 005 815

Xantia 1.9 TD**78**

07.1993→12.2001

D8B, DHW, DHX, DHY

Reference

1001 68

1001 68

DHW: ORGA 08120→



50 005 825

10.1994→01.1998

DHY

Reference

1201 48

1201 51

1201 60

1201 62

9401201480

95641149

95643824

95655209

95655210

95656568

95656569

→6264



50 005 320

10.1994→01.1998

DHY

Reference

1201 52

1201 65

1201 67

1201 91

1201 A4

95650955

95666768

6265→



50 005 313

09.1996→12.2001

DHW

Reference

1001 56

1001 56

→08119



50 005 815

Xantia 2.0i**79**

03.1993→12.2001

R6D, RFX

Reference

1001 77

1001 77



50 005 854

03.1993→01.1998

R6D

Reference

1201 52

1201 65

1201 67

1201 91

1201 A4

95650955

95666768



50 005 313

Xantia 2.0i 16V**80**

03.1993→12.1998

RFT, RFV, RFY

Reference













1001 77

1001 77





50 005 854

**C**

							
03.1993→12.1998 Reference	RFT, RFY 1201 52 1201 A4 →10.1995	1201 65 95650955	1201 67 95666768	1201 91			50 005 313
Xantia 2.0 HDi							81
10.1998→12.2001 Reference	RHZ 1201 C4						50 005 329
Xantia 2.1 TD 12V							82
05.1995→12.2001 Reference	P8C 1201 54 1336 L5	1201 55 96047088	1201 A7	1201 C6			50 005 322
XM 2.0							83
05.1989→06.1994 Reference	R2A 1201 52 1201 A4	1201 65 95650955	1201 67 95666768	1201 91			50 005 313
XM 2.0i							84
05.1989→10.2000 Reference	R6A 1001 77	1001 77				50 005 854	
05.1989→06.1994 Reference	RDZ 1201 52 1201 A4	1201 65 95650955	1201 67 95666768	1201 91			50 005 313
XM 2.0i Turbo							85
09.1992→09.1995 Reference	RGY 1201 52 1201 A4	1201 65 95650955	1201 67 95666768	1201 91			50 005 313
XM 2.1 D 12V							86
05.1989→12.1996 Reference	PJZ 1201 52 1201 A4	1201 65 95650955	1201 67 95666768	1201 91			50 005 313

**XM 2.1 TD 12V****87**

07.1994→10.2000	P8C								
Reference	1201 54 1336 L5	1201 55 96047088	1201 A7	1201 C6					50 005 322
05.1989→12.1996	P9A								
Reference	1201 52 1201 A4	1201 65 95650955	1201 67 95666768	1201 91					50 005 313

C**Xsara 1.4i****88**

07.1997→08.2000	KFX								
Reference	1001 50 →ORGA 09687	1001 50							50 005 820

Xsara 1.5 D**89**

07.1997→08.2000	VJY, VJZ								
Reference	1001 69	1001 69							50 005 853

Xsara 1.6i**90**

07.1997→08.2000	NFZ								
Reference	1001 69	1001 69							50 005 853

Xsara 1.8i**91**

07.1997→08.2000	L6A, LFX, LFZ								
Reference	1001 77	1001 77							50 005 854

Xsara 1.8i 16V**92**

07.1997→12.2000	LFY								
Reference	1001 77 →ORGA 08133	1001 77							50 005 854

Xsara 1.8 D**93**

07.1997→08.2000	161 A, A9A								
Reference	1001 56	1001 56							50 005 815

Xsara 1.9 D**94**

07.1997→08.2000	DJY								
Reference	1001 56	1001 56							50 005 815
04.1998→08.2000	WJZ								
Reference	1001 91	1001 91							50 005 826

**Xsara 1.9 TD****95**

07.1997→08.2000 D8A, DHV, DHW, DHY
 Reference 1001 68 1001 68
 DHV, DHW: ORGA 08120→



50 005 825

01.1998→08.2000 DHV
 Reference 1001 56 1001 56
 →08119



50 005 815

Xsara 2.0i 16V**96**

07.1997→08.2000 RFV
 Reference 1001 77 1001 77



50 005 854

Xsara 2.0 HDi**97**

09.2000→ RHZ
 Reference 1201 C4



50 005 329

Xsara Picasso 1.6i**98**

01.2000→ NFZ
 Reference 1001 69 1001 69



50 005 853

Xsara Picasso 2.0 HDi**99**

12.1999→ RHZ
 Reference 1201 C4



50 005 329

ZX 1.1**100**

03.1991→08.1996 H1A, H1B
 Reference 1001 50 1001 50
 →12.1991



50 005 820

03.1991→08.1996 H1A, H1B
 Reference 1201 E3 1207 18 1207 23 9451001263
 9617376980



50 005 310

ZX 1.1i**101**

10.1991→06.1997 HDZ
 Reference 1001 50 1001 50
 →12.1991



50 005 820

10.1991→06.1997 HDY, HDZ
 Reference 1201 E3 1207 18 1207 23 9451001263
 9617376980





50 005 310

**ZX 1.4****102**

09.1993→12.1995 Reference	K5A 1001 69	1001 69				50 005 853	
03.1991→08.1993 Reference	K2D 1201 58 9608564280	1201 E4	1201 E6	1207 25			50 005 339







C**ZX 1.4i****103**

03.1991→06.1997 Reference 	KDY, KDZ 1001 50 →12.1991	1001 50				50 005 820	
03.1991→08.1992 Reference	KDY, TU 3M/Z 1201 E3 9617376980	1207 18	1207 23	9451001263			50 005 310

ZX 1.5 D**104**

09.1996→10.1997 Reference	VJY, VJZ 1001 69	1001 69				50 005 853	
------------------------------	---------------------	---------	--	--	---	------------	--

ZX 1.6i**105**

03.1991→12.1994 Reference 	XU 5M 1201 50 95656567 5410→	1201 61	95625017	95655208			50 005 319
02.1996→10.1997 Reference	NFZ 1001 69	1001 69				50 005 853	
07.1993→10.1997 Reference	BFZ 1001 77	1001 77				50 005 854	
03.1991→12.1994 Reference	BDY 1001 56	1001 56				50 005 815	
03.1991→12.1994 Reference 	XU 5M 1201 39 95641148 →ch PR5409	1201 63 95655207	91511136 95656566	9401201390			50 005 307

**ZX 1.8i****106**07.1992→10.1997
ReferenceL6A, LFZ
1001 77 1001 77

50 005 854

ZX 1.8i 16V**107**01.1996→02.1998
ReferenceLFY
1001 77 1001 77

50 005 854

ZX 1.8 D**108**03.1991→10.1997
Reference161 A
1001 56 1001 56

50 005 815

ZX 1.9i**109**03.1991→10.1997
ReferenceDKZ
1001 56 1001 56

50 005 815

ZX 1.9 D**110**03.1991→10.1997
ReferenceD9B, DJZ
1001 56 1001 56

50 005 815

ZX 1.9 TD**111**07.1992→10.1997
ReferenceD8A, DHY
1001 68 1001 68

50 005 825

ZX 2.0i**112**07.1992→10.1997
ReferenceR6D, RFX
1001 77 1001 77

50 005 854

07.1993→10.1997
ReferenceR6D
1201 52 1201 65 1201 67 1201 91
1201 A4 95650955 95666768





50 005 313

ZX 2.0i 16V**113**07.1992→10.1997
ReferenceRFT, RFY
1001 77 1001 77

50 005 854

C

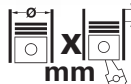

			Cyl	 mm	cm ³		Comp. Ratio ε	kW	PS	Pos
4BT 3.9	D	(A)	4	102 x 120	3900	2	17,5:1	60-82	82-111	1
6B 5.9 C	D	(AN)	6	102 x 120	5880	2	17,5:1	86-132	115-177	1
6BT 5.9	D	(A)	6	102 x 120	5880	2	17:1	86-132	115-177	1
6BTA 5.9	D	(LA)	6	102 x 120	5880	2	17,5:1	86-132	115-177	1
6C 8.3	D	(AN)	6	114 x 135	8270	2	17,5:1	127-274	172-372	1
6CT 8.3	D	(A)	6	114 x 135	8270	2	17,3:1	127-274	172-372	1
6CTA 8.3	D	(LA)	6	114 x 135	8270	2	16,5:1	127-274	172-372	1
6CTAA 8.3	D	(LA)	6	114 x 135	8270	2	17,5:1	127-274	172-372	1





C







Engine

1

C

→ Reference	4BT 3.9, 6BT 5.9 3802081			50 005 242 <small>NEW</small>
→ Reference	6B 5.9 C, 6BT 5.9, 6BTA 5.9 3930337		50 005 217 <small>NEW</small>	
→ Reference	6C 8.3, 6CT 8.3, 6CTA 8.3, 6CTAA 8.3 3802278		50 005 219 <small>NEW</small>	
→ Reference	6CT 8.3, 6CTA 8.3 3960342			50 005 241 <small>NEW</small>

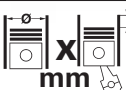

			Cyl	 X mm	cm ³		Comp. Ratio ε	kW	PS	Pos
K4M 690	B		4	79,5 x 80,5	1598	4	9,8:1	77	104	2, 3
K4M 710	B		4	79,5 x 80,5	1598	4	10:1	79	107	2
K9K 790	D	(LA)	4	76 x 80,5	1461	2	18,3:1	48	65	1

D



Logan 1.5 dCi

1

06.2005→

K9K 790

Reference

82 00 227 686

→02.2006



50 005 849

D

Logan 1.6i 16V

2

12.2005→

K4M 690

Reference

82 00 227 686

→09.2006



50 005 849

02.2006→

K4M 710

50 005 170

NEW

Logan MCV 1.6i 16V

3

01.2006→

K4M 690

Reference





82 00 227 686

→09.2006



50 005 849

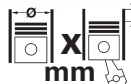

			Cyl		cm ³		Comp. Ratio ε	kW	PS	Pos
30 NE	B		6	95 x 69,8	2969	2	9,4:1	130-135	177-184	6
A14SMS	B		4	76,5 x 73,4	1349	2	9,5:1	55	75	13
A15MF	B		4	76,5 x 81,5	1498	2	9,5:1	51-55	70-75	1, 20, 25
A15SMS	B		4	76,5 x 81,5	1498	4	9,2:1	63-66	86-90	2, 3, 14, 21, 26
A16DMS	B		4	79 x 81,5	1598	4	9,5:1	77-80	105-109	10, 12, 15, 23, 27, 29
B12S1	B		4	68,5 x 78	1148	2	9,3:1	53	72	7
C 18 LE	B		4	84,8 x 79,5	1796	2	8,8:1	66-70	90-95	4
C 20 LZ	B		4	86 x 86	1998	2	8,8:1	74	101	5
C 30 NE	B		6	95 x 69,8	2969	2	9,2:1	130	177	6
F8C	B		3	68,5 x 72	796	2	9,3:1	30	41	30
F14D3 (69 kW)	B		4	77,9 x 73,4	1399	4	9,5:1	69-70	94-95	9, 11, 22
F14S3	B		4	77,9 x 73,4	1399	2	9,5:1	61	83	8
G15MF (55 kW)	B		4	76,5 x 81,5	1498	2	8,6:1	55	75	20
X 20 SED	B		4	86 x 86	1998	4	9,5:1	100-109	136-148	16, 17, 18, 19, 24, 28

D

**DAEWOO****Cielo 1.5i****1**09.1997→
ReferenceA15MF
94013802 96351284 96351971 96352649**50 005 073**
NEW**Cielo 1.5i 16V****2**08.1994→
ReferenceA15SMS
96350799 96352648**50 005 072**
NEW**Espero 1.5i 16V****3**12.1994→12.1999
ReferenceA15SMS
96350799 96352648**50 005 072**
NEW**Espero 1.8i****4**

01.1995→10.1999

C 18 LE

**50 005 049****Espero 2.0i****5**

09.1991→10.1993

C 20 LZ

**50 005 049****Imperial 3.0i****6**

02.1989→08.1993

30 NE, C 30 NE

**50 005 740****Kalos 1.2i****7**04.2003→01.2005
ReferenceB12S1
96518977 96563958**50 005 075**
NEW**Kalos 1.4i****8**09.2003→01.2005
ReferenceF14S3
96350799 96352648**50 005 072**
NEW**D**

**Kalos 1.4i 16V****9**

09.2002→01.2005 F14D3 (69 kW)
 Reference 96182871 96352650



50 005 076
 NEW

D**Kalos 1.6i 16V****10**

08.2002→01.2005 A16DMS
 Reference 96182871 96352650



50 005 076
 NEW

Lacetti 1.4i 16V**11**

03.2004→01.2005 F14D3 (69 kW)
 Reference 96182871 96352650



50 005 076
 NEW

Lacetti 1.6i 16V**12**

03.2004→01.2005 A16DMS
 Reference 96182871 96352650



50 005 076
 NEW

Lanos 1.4i**13**

04.1997→09.2003 A14SMS
 Reference 96350799 96352648



50 005 072
 NEW

Lanos 1.5i 16V**14**

11.1996→09.2003 A15SMS
 Reference 96350799 96352648



50 005 072
 NEW

Lanos 1.6i 16V**15**

04.1997→09.2003 A16DMS
 Reference 94013802 96351284 96351971 96352649



50 005 073
 NEW

04.1997→09.2003 A16DMS
 Reference 96182871 96352650



50 005 076
 NEW

**DAEWOO****Leganza 2.0i 16V****16**

03.1997→12.2002 X 20 SED

Reference 24409355 90444359 92065969

**50 005 074**
NEW**Magnus 2.0i 16V****17**

1999 → X 20 SED

Reference 24409355 90444359 92065969

**50 005 074**
NEW**New Brougham 2.0i 16V****18**

01.1996→02.1997 X 20 SED

Reference 24409355 90444359 92065969

**50 005 074**
NEW**New Prince 2.0i 16V****19**

04.1996→02.1997 X 20 SED

Reference 24409355 90444359 92065969

**50 005 074**
NEW**Nexia 1.5i****20**

02.1995→08.1997 A15MF

Reference 94013802 96351284 96351971 96352649

**50 005 073**
NEW

12.1994→10.1996 G15MF (55 kW)

Reference 96 351 969

**50 005 059****Nexia 1.5i 16V****21**

11.1994→10.1996 A15SMS

Reference 96350799 96352648

**50 005 072**
NEW**Nubira 1.4i 16V****22**

03.2004→01.2005 F14D3 (69 kW)

Reference 96182871 96352650

**50 005 076**
NEW**D**

**Nubira 1.6i 16V****23**

09.1997→01.2005

A16DMS

Reference

96182871

96352650



50 005 076

NEW

Nubira 2.0i 16V**24**

09.1997→06.2003

X 20 SED

Reference

24409355

90444359

92065969



50 005 074

NEW

Racer 1.5i**25**

1997 →

A15MF

Reference

94013802

96351284

96351971

96352649



50 005 073

NEW

Racer 1.5i 16V**26**

11.1994→

A15SMS

Reference

96350799

96352648



50 005 072

NEW

Rezzo 1.6i 16V**27**

09.2000→01.2005

A16DMS

Reference

96182871

96352650



50 005 076

NEW

Super Saloon 2.0i 16V**28**

1997 →

X 20 SED

Reference

24409355

90444359

92065969



50 005 074

NEW

Tacuma 1.6i 16V**29**

09.2000→01.2005

A16DMS

Reference

96182871

96352650



50 005 076

NEW

Tico 0.8**30**

06.1991→01.2005

F8C

Reference

96518977





96563958



50 005 075

NEW

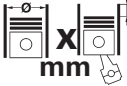

			Cyl	 mm	cm ³		Comp. Ratio ε	kW	PS	Pos
2AZ-FE (112 kW)	B		4	88,5 x 96	2362	4	9,6:1	112-125	152-170	1
2C	D	(AN)	4	86 x 85	1974	2	23:1	53-54	72-73	9
3S-FE (89 kW)	B		4	86 x 86	1998	4	9,3:1	85-96	116-130	10
4K	B		4	75 x 73	1290	2	9:1	44-48	60-65	8
4K-C	B		4	75 x 73	1290	2	9:1	43	58	8
CB 22	B		3	76 x 73	993	2	9,5:1	38-44	52-60	4
HCEJ	B		4	76 x 71,4	1295	4	9,5:1	61-69	83-94	5, 15, 19
HDCF	B		4	76 x 87,6	1589	4	9,5:1	63-71	86-97	2, 11
HDE	B		4	76 x 87,6	1589	4	9,5:1	70-77	95-105	3, 7, 12
HEE	B		4	76 x 82,6	1499	4	9,5:1	66-71	90-97	6, 13, 16
HEEG	B		4	76 x 82,6	1499	4	9,5:1	66-71	90-97	6, 13, 16
HPEP	B		4	76 x 87,6	1589	4	9,5:1	67	91	14, 17
K3VE2	B		4	72 x 79,7	1298	4	11:1	75	102	18
K3VET	B	(LA)	4	72 x 79,7	1298	4	8,5:1	95	129	20

D

**DAIHATSU****Altis 2.4i 16V****1**

10.2001→

2AZ-FE (112 kW)



50 005 799

Applause 1.6 16V**2**

06.1989→07.1997

HDCF

Reference

16100-87109

16100-87183

16100-87185



50 005 078

NEW

Applause 1.6i 16V**3**

06.1989→07.1997

HDE

Reference

16100-87108

16100-87182

16100-87184



50 005 077

NEW

Charade 1.0**4**

02.1981→03.1987

CB 22

Reference

16100-87108

16100-87182

16100-87184



50 005 077

NEW

Charade 1.3i 16V**5**

01.1988→

HCEJ

Reference

16100-87108

16100-87182

16100-87184



50 005 077

NEW

Charade 1.5i 16V**6**

06.1994→

HEE, HEEG

Reference

16100-87108

16100-87182

16100-87184



50 005 077

NEW

Charade 1.6i 16V**7**

01.1993→09.2000

HDE

Reference

16100-87108

16100-87182

16100-87184



50 005 077

NEW

Charmant 1.3**8**

11.1981→07.1987

4K, 4K-C



50 005 196

NEW

**Delta 2.0 D****9**

08.1993→

2C

**50 005 182****NEW****Delta 2.0i 16V****10**

1999 →

3S-FE (89 kW)

**50 005 187****NEW****Feroza 1.6 16V****11**

10.1988→12.1998

HDCF

Reference

16100-87109

16100-87183

16100-87185

**50 005 078****NEW****Feroza 1.6i 16V****12**

10.1988→11.2000

HDE

Reference

16100-87109

16100-87183

16100-87185

**50 005 078****NEW****Grand Move 1.5 i 16V****13**

08.1996→

HEE, HEEG

Reference

16100-87108

16100-87182

16100-87184

**50 005 077****NEW****Grand Move 1.6 i 16V****14**

05.1998→

HPEP

Reference

16100-87108

16100-87182

16100-87184

**50 005 077****NEW****Hijet 1.3 i 16V****15**

05.1998→

HCEJ

Reference

16100-87108

16100-87182

16100-87184

**50 005 077****NEW****Pyzar 1.5 i 16V****16**

10.1996→

HEE, HEEG

Reference

16100-87108

16100-87182

16100-87184

**50 005 077****NEW****D**



Pyzar 1.6 i 16V

1710.1998→
ReferenceHPEP
16100-87108 16100-87182 16100-87184**50 005 077**
NEW**D**

Sirion 1.3 i 16V

18

08.2000→

K3VE2

**50 005 189**
NEW

Terios 1.3 i 16V

1903.1997→05.2000
ReferenceHCEJ
16100-87108 16100-87182 16100-87184**50 005 077**
NEW

YRV 1.3 i 16V Turbo





20

08.2000→

K3VET

**50 005 189**
NEW



			Cyl	 mm	cm ³		Comp. Ratio ϵ	kW	PS	Pos
BF 4 L 913	D	(A)	4	102 x 125	4086	2	15,5/17:1	55-81	75-111	2, 3, 5, 6, 7, 8, 11, 12, 40, 42, 43, 44, 54, 56, 131
BF 6 L 413 F	D	(A)	6	125 x 130	9572	2	16,5:1	143-177	195-241	28, 131
BF 6 L 413 FR	D	(A)	6	125 x 130	9572	2	16,5:1	142-177	193-240	28, 29, 131
BF 6 L 413 FRW	D	(A)	6	125 x 130	9572	2		141	192	131
BF 6 L 413 FW	D	(A)	6	125 x 130	9572	2	16,5:1	112-121	152-165	131
BF 6 L 513 RC	D	(LA)	6	125 x 130	9572	2	15,8:1	180-217	245-295	131
BF 6 L 913	D	(A)	6	102 x 125	6128	2	15,5:1	70-140	95-191	20, 25, 26, 27, 28, 50, 51, 52, 61, 64, 102, 103, 105, 108, 109, 120
BF 8 L 413 F	D	(A)	8	125 x 130	12763	2	16,5:1	190-235	259-320	131
BF 8 L 413 FW	D	(A)	8	125 x 130	12763	2				131
BF 10 L 413 F	D	(A)	10	125 x 130	15953	2	16,5:1	206-294	280-400	76, 131
BF 10 L 413 FW	D	(A)	10	125 x 130	15953	2	16,5:1	188-200	256-275	131
BF 12 L 413 F	D	(A)	12	125 x 130	19144	2	16,5:1	286-353	389-480	131
BF 12 L 413 FW	D	(A)	12	125 x 130	19144	2	16,5:1	228-287	310-390	131
F 3 L 912 D	D	(AN)	3	100 x 120	2826	2	17:1	26-44	35-60	15, 23, 30, 31, 32, 36, 37, 40, 41, 45, 46, 59, 63, 69, 71, 73, 74, 75, 77, 78, 79, 80, 81, 82, 83, 84, 85, 88, 90, 92, 95, 116, 131
F 3 L 912 W	D	(AN)	3	100 x 120	2826	2	19:1	25-37	34-50	131
F 3 L 913 G	D	(AN)	3	102 x 125	3064	2	18:1	36	49	14
F 4 L 912 D	D	(AN)	4	100 x 120	3770	2		19-59	20-80	10, 16, 17, 33, 34, 35, 36, 37, 38, 39, 57, 58, 59, 65, 82, 84, 85, 86, 87, 88, 89, 91, 92, 95, 99, 101, 104, 107, 111, 114, 117, 118, 119, 122, 124, 131
F 4 L 912 W	D	(AN)	4	100 x 120	3770	2	19:1	38-49	52-67	131
F 5 L 912 D	D	(AN)	5	100 x 120	4712	2	17:1	40-78	54-106	18, 53, 55, 89, 93, 94, 100, 110, 117, 125, 131
F 5 L 912 W	D	(AN)	5	100 x 120	4712	2	19:1	48-61	65-83	131
F 6 L 413 F	D	(AN)	6	125 x 130	9572	2	18:1	104-188	141-256	66, 67, 70, 131
F 6 L 413 FR	D	(AN)	6	125 x 130	9572	2	18:1	112-141	153-192	131
F 6 L 413 FRW	D	(AN)	6	125 x 130	9572	2	13,5:1	102	139	131
F 6 L 413 FW	D	(AN)	6	125 x 130	9572	2	18:1	96-121	130-165	131
F 6 L 413 R	D	(AN)	6	120 x 130	8822	2	18:1	100-135	136-183	131
F 6 L 513	D	(AN)	6	128 x 130	10038	2	16,7:1	122-141	166-192	131
F 6 L 912 D	D	(AN)	6	100 x 120	5655	2		42-92	57-125	1, 4, 9, 13, 19, 24, 47, 48, 49, 60, 62, 91, 96, 97, 98, 100, 102, 110, 112, 113, 115, 121, 123, 125, 126, 127, 128, 129, 130, 131
F 6 L 912 W	D	(AN)	6	100 x 120	5655	2	19:1	57-74	77-100	131
F 8 L 413 F	D	(AN)	8	125 x 130	12763	2	18:1	147-188	200-255	21, 67, 68, 70, 72, 106, 131
F 8 L 413 FW	D	(AN)	8	125 x 130	12763	2	18:1	129-136	176-185	131
F 10 L 413 F	D	(AN)	10	125 x 130	15953	2	18:1	173-235	235-320	22, 76, 131
F 10 L 413 FW	D	(AN)	10	125 x 130	15953	2	18:1	161-202	219-275	131
F 12 L 413 F	D	(AN)	12	125 x 130	19144	2	18:1	224-282	305-383	131
F 12 L 413 FW	D	(AN)	12	125 x 130	19144	2	18:1	193-243	263-330	131

**Actor 5510****1**06.1999→
ReferenceF 6 L 912 D
0213 0385

0423 0653

0423 1309



50 005 367

AgroPrima 4.51**2**10.1991→1996
ReferenceBF 4 L 913
0213 0385

0423 0653

0423 1309



50 005 367

AgroPrima 4.56**3**1991 → 1995
ReferenceBF 4 L 913
0213 0385

0423 0653

0423 1309



50 005 367

AgroPrima 6.06**4**1991 → 1996
ReferenceF 6 L 912 D
0213 0385

0423 0653

0423 1309



50 005 367

AgroStar 4.61**5**01.1989→12.1999
ReferenceBF 4 L 913
0213 0385

0423 0653

0423 1309



50 005 367

AgroStar 4.68**6**01.1993→12.1999
ReferenceBF 4 L 913
0213 0385

0423 0653

0423 1309



50 005 367

AgroStar 4.71**7**01.1989→12.1999
ReferenceBF 4 L 913
0213 0385

0423 0653

0423 1309



50 005 367

AgroStar 4.78**8**01.1993→12.1999
ReferenceBF 4 L 913
0213 0385

0423 0653

0423 1309



50 005 367

AgroStar 6.11**9**01.1989→12.1999
ReferenceF 6 L 912 D
0213 0385

0423 0653





0423 1309



50 005 367



D

AgroXtra DX 4.07				10	
1991 → 09.1996 Reference	F 4 L 912 D 0213 0440				50 005 366
AgroXtra DX 4.47				11	
1993 → 1996 Reference	BF 4 L 913 0213 0385 0423 0653 0423 1309				50 005 367
AgroXtra DX 4.57				12	
03.1990→1996 Reference	BF 4 L 913 0213 0385 0423 0653 0423 1309				50 005 367
AgroXtra DX 6.07				13	
1990 → 1996 Reference	F 6 L 912 D 0213 0385 0423 0653 0423 1309				50 005 367
Gabelstapler / Forklift				14	
1992 → Reference	F 3 L 913 G 0213 0440				50 005 366
Intrac 2002				15	
01.1973→12.1976 Reference	F 3 L 912 D 0213 0440				50 005 366
Intrac 2003				16	
09.1974→1979 Reference	F 4 L 912 D 0213 0440				50 005 366
Intrac 2004				17	
05.1978→12.1988 Reference	F 4 L 912 D 0213 0440				50 005 366
Intrac 2005				18	
1973 → 1975 Reference	F 5 L 912 D 0213 0385 0423 0653 0423 1309				50 005 367

**Intrac 6.05****19**

01.1988→ Reference	F 6 L 912 D 0213 0385	0423 0653	0423 1309		50 005 367	
-----------------------	--------------------------	-----------	-----------	---	------------	--

Intrac 6.60**20**

01.1988→06.1994 Reference	BF 6 L 913 0223 7923 0423 0787	0415 2881 0423 1142	0415 4885 0423 1306	0415 9966		50 005 369
------------------------------	--------------------------------------	------------------------	------------------------	-----------	---	------------

Serie SF 3008**21**

10.1977→12.1982 Reference	F 8 L 413 F 0241 6767	0414 3644				50 005 368
------------------------------	--------------------------	-----------	--	--	---	------------

Serie SF 4010**22**

→ Reference	F 10 L 413 F 0241 6768	0414 3645				50 005 873
----------------	---------------------------	-----------	--	--	--	------------

Series D 4206**23**

1973 → Reference	F 3 L 912 D 0213 0440					50 005 366
---------------------	--------------------------	--	--	--	---	------------

Series DX 110**24**

05.1978→10.1985 Reference	F 6 L 912 D 0213 0385	0423 0653	0423 1309			50 005 367
------------------------------	--------------------------	-----------	-----------	--	---	------------









Series DX 140**25**

05.1978→10.1985 Reference	BF 6 L 913 0223 7923 0423 0787	0415 2881 0423 1142	0415 4885 0423 1306	0415 9966		50 005 369
------------------------------	--------------------------------------	------------------------	------------------------	-----------	---	------------

Series DX 145**26**

07.1980→10.1985 Reference	BF 6 L 913 0223 7923 0423 0787	0415 2881 0423 1142	0415 4885 0423 1306	0415 9966		50 005 369
------------------------------	--------------------------------------	------------------------	------------------------	-----------	---	------------

**D**

Series DX 160						27	
05.1978→10.1985	BF 6 L 913						50 005 369
Reference	0223 7923 0423 0787	0415 2881 0423 1142	0415 4885 0423 1306	0415 9966			
Series DX 230						28	
01.1979→10.1985	BF 6 L 413 F, BF 6 L 413 FR						50 005 874
Reference	0414 3509						
05.1978→01.1986	BF 6 L 913						50 005 369
Reference	0223 7923 0423 0787	0415 2881 0423 1142	0415 4885 0423 1306	0415 9966			
Series DX 250						29	
01.1982→10.1985	BF 6 L 413 FR						50 005 874
Reference	0414 3509						
Series DX 3.10						30	
06.1986→	F 3 L 912 D						50 005 366
Reference	0213 0440						
Series DX 3.30						31	
06.1986→	F 3 L 912 D						50 005 366
Reference	0213 0440						
Series DX 3.50						32	
06.1986→	F 3 L 912 D						50 005 366
Reference	0213 0440						
Series DX 3.60						33	
06.1986→	F 4 L 912 D						50 005 366
Reference	0213 0440						

**Series DX 3.65****34**05.1986→
Reference F 4 L 912 D
0213 0440

50 005 366

Series DX 3.70**35**06.1986→
Reference F 4 L 912 D
0213 0440

50 005 366

Series DX 3.80**36**04.1986→
Reference F 3 L 912 D, F 4 L 912 D
0213 0440

50 005 366

Series DX 3.90**37**04.1986→
Reference F 3 L 912 D, F 4 L 912 D
0213 0440

50 005 366

Series DX 4.10**38**06.1986→
Reference F 4 L 912 D
0213 0440

50 005 366

Series DX 4.17**39**04.1986→
Reference F 4 L 912 D
0213 0440

50 005 366

Series DX 4.30**40**06.1986→
Reference F 3 L 912 D
0213 0440

50 005 366

06.1986→
Reference BF 4 L 913
0213 0385 0423 0653 0423 1309









50 005 367

Series DX 4.31**41**01.1991→
Reference F 3 L 912 D
0213 0440

50 005 366

D

**D**

Series DX 4.50						50 005 367	42
05.1986→	BF 4 L 913						
Reference	0213 0385	0423 0653	0423 1309				
Series DX 4.57						50 005 367	43
04.1986→	BF 4 L 913						
Reference	0213 0385	0423 0653	0423 1309				
Series DX 4.70						50 005 367	44
01.1982→	BF 4 L 913						
Reference	0213 0385	0423 0653	0423 1309				
Series DX 50						50 005 366	45
05.1978→10.1985	F 3 L 912 D						
Reference	0213 0440						
Series DX 55						50 005 366	46
05.1978→12.1987	F 3 L 912 D						
Reference	0213 0440						
Series DX 6.05						50 005 367	47
06.1986→	F 6 L 912 D						
Reference	0213 0385	0423 0653	0423 1309				
Series DX 6.06						50 005 367	48
05.1986→	F 6 L 912 D						
Reference	0213 0385	0423 0653	0423 1309				
Series DX 6.10						50 005 367	49
06.1986→	F 6 L 912 D						
Reference	0213 0385	0423 0653	0423 1309				
Series DX 6.50						50 005 369	50
06.1986→	BF 6 L 913						
Reference	0223 7923 0423 0787	0415 2881 0423 1142	0415 4885 0423 1306	0415 9966			

**Series DX 6.60****51**

10.1988→	BF 6 L 913						50 005 369	
Reference	0223 7923 0423 0787	0415 2881 0423 1142	0415 4885 0423 1306	0415 9966				

Series DX 7.10**52**

06.1986→	BF 6 L 913						50 005 369	
Reference	0223 7923 0423 0787	0415 2881 0423 1142	0415 4885 0423 1306	0415 9966				

Series DX 85**53**

05.1978→10.1985	F 5 L 912 D						50 005 367	
Reference	0213 0385	0423 0653	0423 1309					

Series DX 86**54**

01.1982→10.1985	BF 4 L 913						50 005 367	
Reference	0213 0385	0423 0653	0423 1309					

Series DX 90**55**

05.1978→10.1985	F 5 L 912 D						50 005 367	
Reference	0213 0385	0423 0653	0423 1309					

Series DX 92**56**

01.1982→10.1985	BF 4 L 913						50 005 367	
Reference	0213 0385	0423 0653	0423 1309					

Series M 66**57**

01.1969→08.1974	F 4 L 912 D						50 005 366	
Reference	0213 0440							

Series M 80**58**

06.1969→08.1975	F 4 L 912 D						50 005 366	
Reference	0213 0440							

Series M 88**59**

→	F 3 L 912 D, F 4 L 912 D						50 005 366	
Reference	0213 0440							

**DEUTZ****Series M 110****60**

01.1968→09.1976

F 6 L 912 D

Reference

0213 0385

0423 0653

0423 1309



50 005 367

Series M 168**61**

01.1975→10.1982

BF 6 L 913

Reference

0223 7923

0415 2881

0415 4885

0415 9966

0423 0787

0423 1142

0423 1306



50 005 369

Series M 120**62**

10.1969→09.1979

F 6 L 912 D

Reference

0213 0385

0423 0653

0423 1309



50 005 367

AgroCompact 3.30**63**

01.1987→

F 3 L 912 D

Reference

0213 0440



50 005 366

Series M 160**64**

09.1973→12.1982

BF 6 L 913

Reference

0223 7923

0415 2881

0415 4885

0415 9966

0423 0787

0423 1142

0423 1306



50 005 369

AgroCompact 3.70**65**

01.1987→

F 4 L 912 D

Reference

0213 0440



50 005 366

Series M 192**66**

01.1979→12.1982

F 6 L 413 F

Reference

0414 3509



50 005 874

Series M 230**67**

10.1977→04.1980

F 6 L 413 F

Reference

0414 3509



50 005 874

10.1977→04.1980

F 8 L 413 F

Reference

0241 6767

0414 3644



50 005 368

D

**Series M 2000****68**

08.1979→12.1981

F 8 L 413 F

Reference

0241 6767

0414 3644



50 005 368

Series D 4006**69**

01.1968→10.1984

F 3 L 912 D

Reference

0213 0440



50 005 366

Series M 256**70**

05.1978→07.1983

F 6 L 413 F

Reference

0414 3509



50 005 874

03.1977→07.1983

F 8 L 413 F

Reference

0241 6767

0414 3644



50 005 368

Series D 4007**71**

01.1968→10.1984

F 3 L 912 D

Reference

0213 0440



50 005 366

Series M 260**72**

10.1977→10.1982

F 8 L 413 F

Reference

0241 6767

0414 3644



50 005 368

Series D 4505**73**

→

F 3 L 912 D

Reference

0213 0440



50 005 366

Series D 4506**74**

01.1968→10.1984

F 3 L 912 D

Reference

0213 0440



50 005 366

Series D 4507**75**

07.1980→07.1981

F 3 L 912 D

Reference

0213 0440



50 005 366

D

**DEUTZ****Series M 320****76**05.1978→08.1983 BF 10 L 413 F, F 10 L 413 F
Reference 0241 6768 0414 3645

50 005 873

D**Series D 4807****77**07.1980→07.1981 F 3 L 912 D
Reference 0213 0440

50 005 366

Series M 600**78**09.1974→12.1987 F 3 L 912 D
Reference 0213 0440

50 005 366

Series D 5006**79**01.1968→08.1974 F 3 L 912 D
Reference 0213 0440

50 005 366

Series M 660**80**09.1974→12.1987 F 3 L 912 D
Reference 0213 0440

50 005 366

Series D 5206**81**09.1974→06.1980 F 3 L 912 D
Reference 0213 0440

50 005 366

Series M 750**82**→ F 3 L 912 D, F 4 L 912 D
Reference 0213 0440

50 005 366

Series D 5207**83**07.1980→07.1981 F 3 L 912 D
Reference 0213 0440

50 005 366

**Series M 770****84**→
ReferenceF 3 L 912 D, F 4 L 912 D
0213 0440

50 005 366

D**Series D 5506****85**01.1968→11.1981
ReferenceF 3 L 912 D, F 4 L 912 D
0213 0440

50 005 366

Series M 900**86**09.1974→12.1987
ReferenceF 4 L 912 D
0213 0440

50 005 366

Series M 922**87**09.1974→12.1987
ReferenceF 4 L 912 D
0213 0440

50 005 366

Series D 6006**88**01.1968→11.1981
ReferenceF 3 L 912 D, F 4 L 912 D
0213 0440

50 005 366

Series M 980**89**09.1974→12.1987
ReferenceF 4 L 912 D
0213 0440

50 005 366

01.1981→
ReferenceF 5 L 912 D
0213 0385 0423 0653 0423 1309

50 005 367

Series D 6007**90**01.1978→12.1986
ReferenceF 3 L 912 D
0213 0440

50 005 366

Series M 1000**91**→
ReferenceF 4 L 912 D
0213 0440

50 005 366



01.1968→12.1980 Reference	F 6 L 912 D 0213 0385 0423 0653 0423 1309		50 005 367
------------------------------	--	---	------------

D

Series D 6206

92

01.1968→11.1981 Reference	F 3 L 912 D, F 4 L 912 D 0213 0440		50 005 366
------------------------------	---------------------------------------	---	------------

Series M 1002

93

05.1976→12.1981 Reference	F 5 L 912 D 0213 0385 0423 0653 0423 1309		50 005 367
------------------------------	--	---	------------

Series M 1080

94

01.1981→ Reference	F 5 L 912 D 0213 0385 0423 0653 0423 1309		50 005 367
-----------------------	--	--	------------

Series D 6207

95

01.1978→12.1986 Reference	F 3 L 912 D, F 4 L 912 D 0213 0440		50 005 366
------------------------------	---------------------------------------	---	------------

Series M 1102

96

01.1968→12.1980 Reference	F 6 L 912 D 0213 0385 0423 0653 0423 1309		50 005 367
------------------------------	--	---	------------

Series M 1200

97

01.1968→12.1980 Reference	F 6 L 912 D 0213 0385 0423 0653 0423 1309		50 005 367
------------------------------	--	---	------------

Series M 1250

98

→ Reference	F 6 L 912 D 0213 0385 0423 0653 0423 1309		50 005 367
----------------	--	---	------------

Series D 6507

99

07.1982→10.1984 Reference	F 4 L 912 D 0213 0440		50 005 366
------------------------------	--------------------------	---	------------

**Series M 1202****100**

01.1968→ Reference	F 5 L 912 D, F 6 L 912 D 0213 0385 0423 0653 0423 1309		50 005 367
-----------------------	---	---	------------

Series D 6806**101**

09.1974→06.1980 Reference	F 4 L 912 D 0213 0440		50 005 366
------------------------------	--------------------------	---	------------

Series M 1300**102**

→ Reference	F 6 L 912 D 0213 0385 0423 0653 0423 1309		50 005 367
01.1974→04.1976 Reference	BF 6 L 913 0223 7923 0415 2881 0415 4885 0415 9966 0423 0787 0423 1142 0423 1306		50 005 369

Series M 1302**103**

05.1976→12.1979 Reference	BF 6 L 913 0223 7923 0415 2881 0415 4885 0415 9966 0423 0787 0423 1142 0423 1306		50 005 369
------------------------------	---	---	------------

Series D 6807**104**

07.1980→ Reference	F 4 L 912 D 0213 0440		50 005 366
-----------------------	--------------------------	---	------------

Series M 1322**105**

01.1980→12.1987 Reference	BF 6 L 913 0223 7923 0415 2881 0415 4885 0415 9966 0423 0787 0423 1142 0423 1306		50 005 369
------------------------------	---	---	------------

Series M 1620**106**

01.1980→12.1987 Reference	F 8 L 413 F 0241 6767 0414 3644		50 005 368
------------------------------	---	---	------------

Series D 6907**107**

01.1978→12.1986 Reference	F 4 L 912 D 0213 0440		50 005 366
------------------------------	--------------------------	---	------------

**Series M 2685****108**

01.1980→12.1987 BF 6 L 913
 Reference 0223 7923 0415 2881 0415 4885 0415 9966
 0423 0787 0423 1142 0423 1306

**50 005 369****Series M 2780****109**

01.1981→12.1987 BF 6 L 913
 Reference 0223 7923 0415 2881 0415 4885 0415 9966
 0423 0787 0423 1142 0423 1306

**50 005 369****Series M 2385****110**

01.1982→ F 5 L 912 D, F 6 L 912 D
 Reference 0213 0385 0423 0653 0423 1309

**50 005 367****Series D 7006****111**

05.1970→08.1974 F 4 L 912 D
 Reference 0213 0440

**50 005 366****Series M 2480****112**

01.1979→12.1987 F 6 L 912 D
 Reference 0213 0385 0423 0653 0423 1309

**50 005 367****Series M 2580****113**

→ F 6 L 912 D
 Reference 0213 0385 0423 0653 0423 1309

**50 005 367****Series D 7007****114**

06.1986→ F 4 L 912 D
 Reference 0213 0440

**50 005 366****Series M 2680****115**



→ F 6 L 912 D
 Reference 0213 0385 0423 0653 0423 1309

**50 005 367****Series M 3330****116**

01.1992→ F 3 L 912 D
 Reference 0213 0440

**50 005 366****D**

**Series M 3360****117**

03.1987→ Reference	F 4 L 912 D 0213 0440			50 005 366	
03.1987→ Reference	F 5 L 912 D 0213 0385 0423 0653 0423 1309			50 005 367	

D**Series M 3370****118**

→ Reference	F 4 L 912 D 0213 0440			50 005 366	
----------------	--------------------------	--	---	------------	--

Series D 7206**119**

09.1974→06.1980 Reference	F 4 L 912 D 0213 0440			50 005 366	
------------------------------	--------------------------	--	--	------------	--

Series M 3610**120**

03.1987→ Reference	BF 6 L 913 0223 7923 0415 2881 0415 4885 0415 9966 0423 0787 0423 1142 0423 1306			50 005 369	
-----------------------	---	--	---	------------	--

Series M 4030**121**

→ Reference	F 6 L 912 D 0213 0385 0423 0653 0423 1309			50 005 367	
----------------	--	--	---	------------	--

Series D 7207**122**

07.1980→ Reference	F 4 L 912 D 0213 0440			50 005 366	
-----------------------	--------------------------	--	---	------------	--

Series D 7506**123**









1973 → Reference	F 6 L 912 D 0213 0385 0423 0653 0423 1309			50 005 367	
---------------------	--	--	---	------------	--

Series D 7807**124**

01.1978→12.1986 Reference	F 4 L 912 D 0213 0440			50 005 366	
------------------------------	--------------------------	--	---	------------	--



D

Series D 8006					125	
01.1968→12.1981	F 5 L 912 D, F 6 L 912 D					
Reference	0213 0385 0423 0653 0423 1309			50 005 367		
Series D 9006					126	
05.1970→02.1978	F 6 L 912 D					
Reference	0213 0385 0423 0653 0423 1309			50 005 367		
Series D 9009					127	
05.1970→02.1978	F 6 L 912 D					
Reference	0213 0385 0423 0653 0423 1309			50 005 367		
Series D 10006					128	
05.1970→02.1978	F 6 L 912 D					
Reference	0213 0385 0423 0653 0423 1309			50 005 367		
Series D 13006					129	
01.1968→12.1981	F 6 L 912 D					
Reference	0213 0385 0423 0653 0423 1309			50 005 367		
Series D 16006					130	
01.1968→12.1981	F 6 L 912 D					
Reference	0213 0385 0423 0653 0423 1309			50 005 367		
Engine					131	
11.1967→	F 3 L 912 D, F 3 L 912 W, F 4 L 912 D, F 4 L 912 W					
Reference	0213 0440			50 005 366		
06.1971→	BF 6 L 413 F, BF 6 L 413 FR, BF 6 L 413 FRW, BF 6 L 413 FW, F 6 L 413 F, F 6 L 413 FR, F 6 L 413 FRW, F 6 L 413 FW					
Reference	0414 3509			50 005 874		
11.1967→	BF 4 L 913, F 5 L 912 D, F 5 L 912 W, F 6 L 912 D, F 6 L 912 W					
Reference	0213 0385 0423 0653 0423 1309			50 005 367		







07.1973→12.1975 Reference	F 6 L 413 R 0214 4036 0214 4037		50 005 871 NEW	
01.1985→ Reference	BF 6 L 513 RC, F 6 L 513 0414 3184		50 005 872 NEW	
1975 → Reference	BF 8 L 413 F, BF 8 L 413 FW, F 8 L 413 F, F 8 L 413 FW 0241 6767 0414 3644		50 005 368	
1975 → Reference	BF 10 L 413 F, BF 10 L 413 FW, BF 12 L 413 F, BF 12 L 413 FW, F 10 L 413 F, F 10 L 413 FW, F 12 L 413 F, F 12 L 413 FW 0241 6768 0414 3645		50 005 873	

D





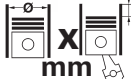

			Cyl		mm	cm ³	Comp. Ratio	ε	kW	PS	Pos
4.203	D	(AN)	4	91,48 x 126,9	3335	2	17,4:1	44	60	233, 234	
903.	B		4	65 x 67	896	2	7,5:1	33	45	57	
1.0L FIRE 8V	B		4	70 x 64,9	999	2	9,5:1	41-49	55-65	69, 95	
100 GL.0N.0	B		4	65 x 68	903	2	9:1	33	45	1, 57, 74, 226	
100 GL.9C.0	B		4	65 x 68	903	2	9:1	33	45	57	
100 GL.9N.0	B		4	65 x 68	903	2	9:1	33	45	1, 57, 74, 114	
1170 A1.000	B	(A)	4	65 x 67,7	899	2	8,8:1	29-31	40-42	12	
1170 A1.046	B		4	65 x 67,7	899	2	8,8:1	29	40	12	
128 AS.000	B		4	86,4 x 63,9	1499	2	9,2:1	63	85	122	
138 A1.000	B		4	86,4 x 55,5	1301	2	9,1:1	48	65	87, 88	
138 A3.1A.0	B		4	86,4 x 55,5	1301	2	9,6:1	48	65	85, 87, 88	
138 B.000	B		4	80 x 55,5	1116	2	9,2:1	40	54	86, 100, 117	
146 A.000	B		4	65 x 68	903	2	9:1	33	45	74, 114	
146 A.048	B		4	65 x 68	903	2	9:1	33	45	74, 114	
146 A1.000	B		4	65 x 68	903	2	9,7:1	33	45	114	
146 C5.000	B		4	80,5 x 67,4	1372	2	9,2:1	50	67	55	
146 C6.000	B		4	86,4 x 67,4	1581	2	9,5:1	69	94	56	
146 D5.000	B		4	80,5 x 67,4	1372	2	9,2:1	49	67	58	
146 D6.000	B		4	86,4 x 67,4	1581	2	9,2:1	55	75	59	
149 B4.000	D	(AN)	4	82,6 x 79,2	1698	2	20:1	42	57	105	
156 A2.000	B		4	70 x 64,9	999	2	9,5:1	32-37	44-50	76, 115	
156 A2.048	B		4	70 x 64,9	999	2	9,9,2:1	32	44	76, 116	
156 A2.100	B		4	70 x 64,9	999	2	9:1	32	44	76, 116	
156 A2.146	B		4	70 x 64,9	999	2	9,5:1	33	45	76, 77	
156 A2.246	B		4	70 x 64,9	999	2	9,5:1	33	45	76, 77, 116, 120	
156 A4.000	B		4	65 x 58	769	2	9,4:1	25	34	73	
156 A4.048	B		4	65 x 58	769	2	9,4:1	25	34	73	
156 C.046	B		4	70 x 72	1108	2		37-40	50-55	78, 104, 119	
159 A2.000	B		4	80,5 x 67,4	1372	2	9,2:1	52-56	71-76	101	
160 A1.046	B		4	80,5 x 67,4	1372	2	9,2:1	51	70	102	
160 A3.000	B		4	70 x 72	1108	2	9,6:1	37-41	51-56	103, 118, 121	
170 A1.000	B		4	65 x 67,7	899	2	8,8:1	29	40	12, 75	
170 A1.046	B		4	65 x 67,7	899	2	8,8:1	29	40	12, 75	
171 B	B		4	83 x 73	1580	2	9,5:1	66	90	50	
176 A6.000	B		4	70 x 72	1108	2	9,6:1	40	54	81	
176 A7.000	B		4	70,8 x 78,9	1242	2	9,6:1	44	60	82	
176 A8.000	B		4	70,8 x 78,9	1242	2	9,8:1	55	75	71, 82	
176 B2.000	B		4	70 x 72	1108	2	9,6:1	40	54	13, 78, 81, 94	
176 B9.000	B		4	70,8 x 78,9	1242	4	10,2:1	59-63	80-86	32, 83	
182 A4.000	B		4	86,4 x 67,4	1581	4	10,15:1	76	103	6, 9, 33, 64, 67	
182 A6.000	B		4	86,4 x 67,4	1581	4	10,15:1	66-76	90-103	4, 6, 9	
182 B2.000	B		4	70,8 x 78,9	1242	4	10,2:1	60	82	3, 5, 8, 62	
182 B4.000	D	(LA)	4	82 x 90,4	1910	2	18,45:1	77	105	7, 10, 65, 66, 68	
185 A6.000	D	(LA)	5	82 x 90,4	2387	2	18,45:1	96	131	63	
188 A5.000	B		4	70,8 x 78,9	1242	4	10,2:1	59-63	80-86	2, 5, 8, 60, 72, 80, 83, 96, 97	
188 A9.000	D	(LA)	4	69,6 x 82	1251	4	18:1	51	69	34, 61, 70, 79, 84	
192 A3.000	D	(LA)	4	82 x 90,4	1910	4	18,45:1	59	80	99	
192 A5.000	D	(LA)	4	82 x 90,4	1910	4	18,45	103	140	99	
194A1.000	B		4	86 x 94,6	2198	4	10:1	108	147	15	
4.236	D	(AN)	4	98,48 x 126,8	3864	2	16:1	48-60	59-80	193, 196, 203, 217, 223, 224, 230, 242, 243	
4.248	D	(AN)	4	101,054 x 126,8	4064	2	16:1	53-66	72-90	203, 215, 225, 227	
8035.04.359	D	(AN)	3	103 x 110	2749	2	17:1	38	52	235, 236, 237	
8040.05.230	D	(AN)	4	104 x 115	3908	2	17:1	65	88	185, 186	
8040.25.000	D	(A)	4	104 x 115	3908	2	17:1	74-85	101-115	188, 190	
8040.25.200	D	(A)	4	104 x 115	3908	2	17:1	85	115	188	
8040.25.220	D	(A)	4	104 x 115	3908	2	17:1	85	115	191	
8040.25.230	D	(A)	4	104 x 115	3908	2	17:1	65-74	88-101	185, 187	
8040.25.400	D	(A)	4	104 x 115	3908	2	17,7:1	85	115	124, 126, 128	
8040.25.420	D	(A)	4	104 x 115	3908	2	17,7:1	85	115	191	
8040.25.600	D	(A)	4	104 x 115	3908	2	16,5:1	74	101	187, 188	
8040.45.4000	D	(LA)	4	104 x 115	3908	2	17,7:1	100	136	123, 124, 125, 127, 128, 129, 131	
8040.45.4010	D	(LA)	4	104 x 115	3908	2	17,7:1	100	136	125, 127, 129	
8040.45.4020	D	(LA)	4	104 x 115	3908	2	17,7:1	100	136	125, 127, 129	
8040.45.4030	D	(LA)	4	104 x 115	3908	2	17,7:1	100	136	125, 127, 129	
8040.45.4035	D	(LA)	4	104 x 115	3908	2	17,7:1	100	136	125, 127, 129	
8040.45.4090	D	(LA)	4	104 x 115	3908	2	17,7:1	100	136	125, 127, 129	



			Cyl	 X mm	cm ³		Comp. Ratio ε	kW	PS	Pos
8040.45.410	D	(LA)	4	104 x 115	3908	2	17:1	100	136	125, 127, 129
8040.45.4180	D	(LA)	4	104 x 115	3908	2	17:1	100	136	129
8040.45.4300	D	(LA)	4	104 x 115	3908	2	17,7:1	100	136	129
8040.45.4305	D	(LA)	4	104 x 115	3908	2	17,7:1	100	136	129
8040.45.4380	D	(LA)	4	104 x 115	3908	2	17,7:1	100	136	129
8040.45.4800	D	(LA)	4	104 x 115	3908	2	17,7:1	100	136	125, 127, 129
8040.45.5200	D	(LA)	4	104 x 115	3908	2	18:1	100	136	125, 127, 129
8040.45.5281	D	(LA)	4	104 x 115	3908	2	18:1	100	136	125, 127, 129
8040.45D.5100	D	(LA)	4	104 x 115	3908	2	18:1	85	115	129
8040.45D.5103	D	(LA)	4	104 x 115	3908	2	18:1	85	115	129
8040.45X.4180	D	(LA)	4	104 x 115	3908	2		100	136	125, 127, 129
8045.04.359	D	(AN)	4	103 x 110	3666	2	17:1	55	75	237, 238, 239
8040.45.4381	D	(LA)	4	104 x 115	3908	2	17,7:1	100	136	129
8055.05.250	D	(AN)	5	104 x 115	4885	2	17:1	72	98	240, 241
8060.02.000	D	(AN)	6	100 x 110	5184	2	17:1	90	122	189, 192, 194, 196, 198, 210, 211, 218, 219, 220, 221, 222, 228, 229
8060.04.051	D	(AN)	6	103 x 110	5499	2	17:1	96	130	212
8060.04.052	D	(AN)	6	103 x 110	5499	2	17:1	92	125	213
8060.04.669	D	(AN)	6	103 x 110	5499	2	17:1	102	139	195
8060.04.689	D	(AN)	6	103 x 110	5499	2	17:1	99-102	135-139	197
8060.05.200	D	(AN)	6	104 x 115	5863	2	17:1	99-102	135-137	199, 201
8060.24.601	D	(A)	6	103 x 110	5499	2	17:1	124	169	200, 202
8060.25.000	D	(LA)	6	104 x 115	5863	2	16,5:1	130	177	133
8060.25.400	D	(A)	6	104 x 115	5863	2	17,7:1	130	177	133, 139, 142, 145, 152, 157
8060.25.420	D	(A)	6	104 x 115	5863	2	17,7:1	130	177	133, 139, 142, 145, 152, 157
8060.25R.4200	D	(LA)	6	104 x 115	5863	2	17,7:1	105	143	130, 132, 135, 138, 141, 144
8060.25R.4280	D	(LA)	6	104 x 115	5863	2	17,7:1	105	143	141, 144, 149
8060.25R.4300	D	(LA)	6	104 x 115	5863	2	17,7:1	105	143	130, 132, 135, 138, 141, 144
8060.25V.4000	D	(LA)	6	104 x 115	5863	2	17,7:1	130	177	133, 136, 139, 147, 152
8060.25V.4080	D	(LA)	6	104 x 115	5863	2	17,7:1	130	177	142, 145, 148, 150
8060.25V.4800	D	(LA)	6	104 x 115	5863	2	17,7:1	130	177	133, 139, 147, 152
8060.45.4700	D	(LA)	6	104 x 115	5863	2	17:1	152	207	134, 137, 140, 154
8060.45.4708	D	(LA)	6	104 x 115	5863	2	17:1	152	207	134, 137, 140, 154
8060.45.6090	D	(LA)	6	104 x 115	5863	2	18:1	167	227	143, 146, 151
8060.45B.5100	D	(LA)	6	104 x 115	5863	2	18:1	130-152	177-207	133, 139, 142, 145, 150, 152
8060.45B.5186	D	(LA)	6	104 x 115	5863	2	18:1	130	177	133, 139
8060.45K.6090	D	(LA)	6	104 x 115	5863	2	18:1	167	227	143, 146, 148, 151, 155
8060.45K.6096	D	(LA)	6	104 x 115	5863	2	18:1	167	227	143, 146, 148, 151, 155
8060.45R.5000	D	(LA)	6	104 x 115	5863	2	18:1	105	143	141
8060.45R.5046	D	(LA)	6	104 x 115	5863	2	18:1	105	143	141
8060.45S.6700	D	(LA)	6	104 x 115	5863	2	17:1	167	227	148, 153, 155, 156
8060.45S.6800	D	(LA)	6	104 x 115	5863	2	17:1	167	227	143, 151, 155
8060.45S.7200	D	(LA)	6	104 x 115	5863	2	18:1	167	227	143, 146, 151
8060.45S.7215	D	(LA)	6	104 x 115	5863	2	18:1	167	227	143, 146, 151
8060.45X.4180	D	(LA)	6	104 x 115	5863	2	17:1	152	207	134, 140, 154
8210.42.151	D	(LA)	6	137 x 156	13798	2	16,5:1	277	377	244, 247, 248
8140.21.200	D	(A)	4	93 x 90	2445	2	18:1	68	92	24, 27, 29, 46
8140.21.214	D	(A)	4	93 x 90	2445	2	18:1	77	105	29
8140.40.3710	D	(LA)	4	93 x 92	2499	2	19:1	52	71	22, 23, 25, 26, 30, 31, 46
8140.43.3700	D	(LA)	4	94,4 x 100	2798	2	18,5:1	85	115	25, 26, 28, 30, 31, 39, 40, 47, 49, 53, 251
8140.43.3731	D	(LA)	4	94,4 x 100	2798	2	18,5:1	90	122	25, 26, 28, 30, 31, 47
8140.47.2700	D	(LA)	4	93 x 92	2499	2	18,5:1	85	116	25, 26, 28, 30, 31
8140.47.2721	D	(LA)	4	93 x 92	2499	2	18,5:1	85	116	28, 30, 31
8140.47.2785	D	(LA)	4	93 x 92	2499	2	18,5:1	85	116	25, 26, 28, 30, 31
8140.47.3700	D	(LA)	4	93 x 92	2499	2	18,5:1	85	115	25, 28, 30, 31, 38, 46, 52, 251
8140.47.3731	D	(LA)	4	93 x 92	2499	2	18,5:1	85	116	25, 28, 30, 31, 38, 46, 52
8140.61.200	D	(AN)	4	93 x 90	2445	2	21:1	53	72	18, 20, 21, 183, 207, 226, 231
8140.61.204	D	(AN)	4	93 x 90	2445	2	21:1	53	72	17
8140.61.230	D	(AN)	4	93 x 90	2445	2	21:1	53	72	18
8140.61.300	D	(AN)	4	93 x 90	2445	2	21:1	53	72	18, 19, 21, 42, 207, 226

F

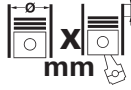

			Cyl		cm ³		Comp. Ratio ε	kW	PS	Pos
8140.67.2500	D	(AN)	4	93 x 92	2499	2	22:1	55	75	45
8210.42.009	D	(LA)	6	137 x 156	13798	2	15:1	265	360	168, 173, 175, 214
8210.42.061	D	(LA)	6	137 x 156	13798	2	16,5:1	277	377	205
8210.42.073	D	(LA)	6	137 x 156	13798	2	16,5:1	277	377	205
8210.42.115	D	(LA)	6	137 x 156	13798	2	15:1	265	360	206, 208, 246
8210.42.152	D	(LA)	6	137 x 156	13798	2	16,5:1	277	377	245, 246, 247, 250
8210.42.154	D	(LA)	6	137 x 156	13798	2	16,5:1	277	377	245, 247
8210.42.155	D	(LA)	6	137 x 156	13798	2	16,5:1	277	377	208, 209, 250
8210.42.161	D	(LA)	6	137 x 156	13798	2	16,5:1	277	377	247
8210.42.162	D	(LA)	6	137 x 156	13798	2	16,5:1	277	377	247
8210.42.171	D	(LA)	6	137 x 156	13798	2	16,5:1	277	377	247
8210.42.172	D	(LA)	6	137 x 156	13798	2	16,5:1	277	377	245, 246, 247, 250
8210.42.173	D	(LA)	6	137 x 156	13798	2	16,5:1	277	377	204, 247
8210.42.175	D	(LA)	6	137 x 156	13798	2	16,5:1	277	377	248, 249, 250
8210.42.182	D	(LA)	6	137 x 156	13798	2	16,5:1	277	377	205
8210.42.191	D	(LA)	6	137 x 156	13798	2	16,5:1	277	377	205
8210.42K.3000	D	(LA)	6	137 x 156	13798	2	16;5:1	272	370	171, 173, 176, 178, 180, 182
8210.42K.300	D	(LA)	6	137 x 156	13798	2	16,5:1	272	370	168, 171, 173, 176, 178, 182
8210.42K.379	D	(LA)	6	137 x 156	13798	2	16,5:1	272	370	168, 171, 173, 178
8210.42K.3790	D	(LA)	6	137 x 156	13798	2	16,5:1	272	370	171, 173, 176, 178, 180, 182
8210.42L.400	D	(LA)	6	137 x 156	13798	2	16,5:1	309	420	158, 159, 160, 161, 162, 163, 164, 165, 166, 167, 169, 170, 172, 174, 177, 179, 181, 182
8210.42L.499	D	(LA)	6	137 x 156	13798	2	16,5:1	309	420	158, 167, 169, 170, 172, 174, 177, 179, 181, 182
8210.42L.4000	D	(LA)	6	137 x 156	13798	2	16,5:1	309	420	167, 169, 170, 172, 174, 177, 179, 181, 182
8210.42L.4990	D	(LA)	6	137 x 156	13798	2	16,5:1	309	420	167, 169, 170, 172, 174, 177, 179, 181, 182
937 A4.000	D	(LA)	4	82 x 90,4	1910	4	18,45:1	93	126	98
937 A5.000	D	(LA)	4	82 x 90,4	1910	4	18,45:1	110	150	11, 99
939 A2.000	D	(LA)	4	82 x 90,4	1910	4	17,5:1	110	150	11, 14, 99
939 A3.000	D	(LA)	5	82 x 90,4	2387	4	17:1	147	200	16
D 3.152	D	(AN)	3	91,48 x 126,9	2503	2		35	47	184, 216, 232
D9B	D	(AN)	4	83 x 88	1905	2	23:1	51	69	90
DJ5 T	D	(LA)	4	92 x 92	2446	3	22:1	76	104	54
DK5 ATE	D	(LA)	4	92 x 92	2446	3	22:1	94-96	128-130	54
DW10 ATED4	D	(LA)	4	85 x 88	1997	4	17,6:1	79-80	107-109	109
DW10 BTED4	D	(LA)	4	85 x 88	1997	4	17,6:1	100	136	92, 109
DW12 TED4	D	(LA)	4	85 x 96	2179	4	17,6:1	94-100	128-136	113
DW8	D	(AN)	4	82,2 x 88	1868	2	23:1	51	69	90
LFW	B		4	83 x 81,4	1761	2	9,25:1	72	98	106
M16A (79 kW)	B		4	78 x 83	1586	4	10,5:1	79	107	93
P8C	D	(LA)	4	85 x 92	2088	3	21,5:1	80-81	109-110	112
R5B	B		4	86 x 86	1998	2	8,8:1	79	107	35, 43
RFU	B		4	86 x 86	1998	2	9,5:1	89-90	121-123	110
RFV	B		4	86 x 86	1998	4	10,4:1	97-100	132-136	111
RFW	B		4	86 x 86	1998	2	9,5:1	80	109	35, 43, 110
RGU	B		4	86 x 86	1998	2	9,5:1	89	121	110
RHT	D	(LA)	4	85 x 88	1997	4	17,3:1	80-81	109-110	109
RHV	D	(LA)	4	85 x 88	1997	2	18:1	63-68	86-92	36, 44, 48
RHW	D	(LA)	4	85 x 88	1997	4	18:1	80-81	109-110	109
RHX	D	(LA)	4	85 x 88	1997	2	17,6:1	80	109	91
RHZ	D	(LA)	4	85 x 88	1997	2	17,6:1	80-81	109-110	91, 108
U25/651	D	(AN)	4	93 x 92	2499	2	22,25:1	54-55	73-75	37, 45, 51
U25/661	D	(AN)	4	93 x 92	2499	2	22,25:1	54-55	73-75	37, 45, 51
WJY	D	(AN)	4	82,2 x 88	1868	2	23:1	44-52	60-71	90
WJZ	D	(AN)	4	82,2 x 88	1868	2	23:1	51	69	90
XU 10 2C	B		4	86 x 86	1998	2	8,8:1	79-85	107-115	41
XU 7JP	B		4	83 x 81,4	1762	2	9,25:1	73-76	99-103	89, 106
XUD 11ATE	D	(LA)	4	85 x 92	2088	3	21,5:1	80	109	112
XUD 9A	D	(AN)	4	83 x 88	1905	2	23:1	47-52	64-71	90
XUD 9TF	D	(LA)	4	83 x 88	1905	2	21,8:1	68	92	107

**127 0.9****1**06.1971→05.1983
06.1971→05.1983100 GL.0N.0
100 GL.9N.0

Reference

4227634

4284907

46514517



50 005 816

Albea 1.2i 16V**2**01.2002→
Reference188 A5.000
46520401

55184081

50 005 057
NEW**F****Barchetta 1.2i 16V****3**12.1998→
Reference182 B2.000
46520401

55184081

50 005 057
NEW**Barchetta 1.6i 16V****4**10.1995→
Reference182 A6.000
46400058

46444355



50 005 780

Brava 1.2i 16V**5**11.1998→09.2001
08.2000→09.2001
Reference182 B2.000
188 A5.000
46520401

55184081

50 005 057
NEW**Brava 1.6i 16V****6**10.1995→09.2001
10.1995→10.1998
Reference182 A4.000
182 A6.000
46400058

46444355



50 005 780

Brava 1.9 JTD**7**11.1998→09.2001
Reference182 B4.000
46432248
6081460946515970
60815559

46515972

59722248



50 005 332

Bravo 1.2i 16V**8**11.1998→09.2001
08.2000→09.2001
Reference182 B2.000
188 A5.000
46520401

55184081

50 005 057
NEW

**Bravo 1.6i 16V****9**10.1995→09.2001 182 A4.000
10.1995→10.1998 182 A6.000

Reference 46400058 46444355



50 005 780

Bravo 1.9 JTD**10**

11.1998→09.2001 182 B4.000

Reference 46432248 46515970 46515972 59722248
60814609 60815559

50 005 332

Bravo 1.9 JTD 16V**11**02.2007→ 937 A5.000
03.2007→ 939 A2.000

Reference 46804051

50 005 056
NEW**Cinquecento 900i****12**07.1991→07.1998 1170 A1.000
07.1991→07.1998 1170 A1.046
07.1991→07.1998 170 A1.000
10.1991→07.1998 170 A1.046

Reference 4227634 4284907 46514517



50 005 816

Cinquecento 1.1i**13**

10.1994→07.1998 176 B2.000

Reference 46423351 46531183 5973713 7640163
7691820 7715242
→9042882

50 005 303

Croma 1.9 JTD 16V**14**

06.2005→ 939 A2.000

Reference 46804051

50 005 056
NEW**Croma 2.2i 16V****15**

07.2005→ 194A1.000



50 005 792

Croma 2.4 JTD 20V**16**

06.2005→ 939 A3.000

Reference 46804051

50 005 056
NEW

F



Daily 2.5 28.8

17

04.1978→07.1982	8140.61	204						
Reference	4714636	4754850	4764761	7303009				50 005 321

Daily 2.5 30.8

18

04.1978→06.1989	8140.61	200, 230, 300						
Reference	4714636	4754850	4764761	7303009				50 005 321

F

Daily 2.5 32.8

19

04.1978→1985	8140.61	300						
Reference	4714636	4754850	4764761	7303009				50 005 321

Daily 2.5 35.8

20

04.1978→06.1989	8140.61	200						
Reference	4714636	4754850	4764761	7303009				50 005 321

Daily 2.5 40.8

21

04.1978→06.1989	8140.61	200, 300						
Reference	4714636	4754850	4764761	7303009				50 005 321

Daily-Turbo 30.8

22

	8140.40	3710						
Reference	99438900							50 005 621

Daily-Turbo 35.8

23

	8140.40	3710						
Reference	99438900							50 005 621

Daily-Turbo 35.10

24

02.1985→06.1986	8140.21	200						
Reference	4714636	4754850	4764761	7303009				50 005 321

**Daily-Turbo 35.12****25**

03.1994→	8140.40	3710
05.1996→05.1999	8140.43	3700, 3731
10.1990→04.1996	8140.47	2700, 2785, 3700, 3731
Reference	99438900	



50 005 621

Daily-Turbo 40.12**26**

03.1994→	8140.40	3710
05.1996→05.1999	8140.43	3700, 3731
10.1990→04.1996	8140.47	2700, 2785
Reference	99438900	



50 005 621

Daily-Turbo 45.10**27**

02.1985→06.1989	8140.21	200
Reference	4714636	4754850 4764761 7303009



50 005 321

Daily-Turbo 45.12**28**

05.1996→05.1999	8140.43	3700, 3731
06.1990→04.1996	8140.47	2700, 2721, 2785, 3700, 3731
Reference	99438900	



50 005 621

Daily-Turbo 49.10**29**

02.1985→06.1989	8140.21	200, 214
Reference	4714636	4754850 4764761 7303009



50 005 321

Daily-Turbo 49.12**30**

03.1994→	8140.40	3710
05.1996→05.1999	8140.43	3700, 3731
06.1990→04.1996	8140.47	2700, 2721, 2785, 3700, 3731
Reference	99438900	



50 005 621

Daily-Turbo 59.12**31**

03.1994→	8140.40	3710
05.1996→05.1999	8140.43	3700, 3731
05.1991→04.1996	8140.47	2700, 2721, 2785, 3700, 3731
Reference	99438900	



50 005 621

Doblò 1.2i 16V**32**

Reference	176 B9.000	46520401	55184081
-----------	------------	----------	----------

50 005 057
NEW**Doblò 1.6i 16V****33**

03.2001→	182 A4.000
Reference	46400058 46444355



50 005 780

F

**Dobló 1.3 JTD 16V****34**

05.2004→
Reference 188 A9.000
46819138



50 005 760

Ducato 10 2.0**35**

03.1994→03.2002 R5B
03.1994→03.2002 RFW
Reference 9565095580 9566945688



50 005 313

F**Ducato 10 2.0 JTD****36**

10.2001→
Reference RHV
9569147388



50 005 329

Ducato 10 2.5 D**37**

1983 → 1993 U25/651
1983 → 1993 U25/661
Reference 5548541



50 005 306

Ducato 10 2.5 D Turbo**38**

03.1994→03.1998 8140.47 3700, 3731
Reference 99438900



50 005 621

Ducato 10 2.8 D Turbo**39**

10.1997→03.2002 8140.43 3700
Reference 99438900



50 005 621

Ducato 11 2.8 D Turbo**40**

10.2002→
Reference 8140.43 3700
99438900



50 005 621

Ducato 12 2.0**41**

07.1990→02.1994 XU 10 2C
Reference 9565095580 9566945688



50 005 313

Ducato 13 2.4 D**42**

04.1978→1985 8140.61 300
Reference 4714636 4754850 4764761 7303009



50 005 321



Ducato 14 2.0

43

 03.1994→03.2002
 03.1994→03.2002

 R5B
 RFW

Reference

9565095580

9566945688

50 005 313

Ducato 14 2.0 JTD

44

10.2001→

RHV

Reference

9569147388

50 005 329

Ducato 14 2.5 D

45

01.1986→03.1994

8140.67 2500

Reference

4714636

4754850

4764761

7303009

50 005 321

 1983 → 1993
 1983 → 1993

 U25/651
 U25/661

Reference

5548541

50 005 306

Ducato 14 2.5 D Turbo

46

01.1989→02.1994

8140.21 200

Reference

4714636

4754850

4764761

7303009

50 005 321

 03.1994→
 03.1994→03.1998

 8140.40 3710
 8140.47 3700, 3731

Reference

99438900

50 005 621

Ducato 14 2.8 D Turbo

47

05.1996→03.2002

8140.43 3700, 3731

Reference

99438900

50 005 621

Ducato 15 2.0 JTD

48

04.2002→

RHV

Reference

9569147388

50 005 329

Ducato 15 2.8 D Turbo

49

10.2002→

8140.43 3700

Reference

99438900

50 005 621
F



Ducato 18 2.0				50
07.1982→12.1993 	171 B →ch PR5409			50 005 307
Ducato 18 2.5 D				51
1983 → 1993 1983 → 1993 Reference	U25/651 U25/661 5548541			50 005 306
Ducato 18 2.5 D Turbo				52
03.1994→03.1998 Reference	8140.47 3700, 3731 99438900			50 005 621
Ducato 18 2.8 D Turbo				53
10.1997→03.2002 Reference	8140.43 3700 99438900			50 005 621
Ducato 2.5 D Turbo				54
07.1994→ 1993 → 	DJ5 T DK5 ATE DK5 ATE: →05.1996			50 005 330
07.1994→ 1993 → 	DJ5 T DK5 ATE DK5 ATE: 06.1996→			50 005 331
Elba 1.4i				55
09.1993→ Reference 	146 C5.000 46437911 7752928 9.470.269→			50 005 334
Elba 1.6i				56
09.1993→ Reference 	146 C6.000 46437911 7752928 9.470.269→			50 005 334
Fiorino 0.9				57
10.1977→03.1981 10.1977→03.1981 10.1977→03.1981 10.1977→03.1981 Reference	100 GL.0N.0 100 GL.9C.0 100 GL.9N.0 903. 4227634 4284907 46514517			50 005 816

F



Fiorino 1.4i

58

06.1995→12.2001 146 D5.000

Reference 46437911 7752928
9.470.269→



50 005 334

Fiorino 1.6i

59

06.1995→12.2001 146 D6.000

Reference 46437911 7752928
9.470.269→



50 005 334

F

Idea 1.2i 16V

60

01.2004→10.2005 188 A5.000

Reference 46520401 55184081



50 005 057
NEW

Idea 1.3 JTD 16V

61

01.2004→ 188 A9.000

Reference 46819138



50 005 760

Marea 1.2i 16V

62

03.1999→09.2002 182 B2.000

Reference 46520401 55184081



50 005 057
NEW

Marea 2.4 JTD

63

03.1999→09.2002 185 A6.000

Reference 46432248 46515970 46515972 59722248
60814609 60815559



50 005 332

Marea 1.6i 16V

64

10.1996→ 182 A4.000

Reference 46400058 46444355



50 005 780

Marea 1.9 JTD

65

03.1999→09.2002 182 B4.000

Reference 46432248 46515970 46515972 59722248
60814609 60815559



50 005 332

**Marengo 1.9 JTD****66**

03.1999→09.2002

182 B4.000

Reference

46432248
6081460946515970
60815559

46515972

59722248



50 005 332

Multipla 1.6i 16V**67**

10.1998→

182 A4.000

Reference

46400058

46444355



50 005 780

F**Multipla 1.9 JTD****68**

01.1999→03.2002

182 B4.000

Reference

46432248
6081460946515970
60815559

46515972

59722248



50 005 332

Palio 1.0i**69**

Reference

1.0L FIRE 8V

46520401

55184081



50 005 057

NEW

Palio 1.3 JTD**70**

07.2003→

188 A9.000

Reference

46819138



50 005 760

Palio 1.2i**71**

09.1997→

176 A8.000

Reference

46423351
7691820
→904288246531183
7715242

5973713

7640163



50 005 303

Palio 1.2i 16V**72**

10.2001→

188 A5.000

Reference

46520401

55184081



50 005 057

NEW

Panda I 750**73**

01.1986→12.1992

156 A4.000

01.1986→12.1992

156 A4.048

Reference

46423351
769182046531183
7715242

5973713

7640163



50 005 303



Panda I 900					74		
01.1983→12.1985	100 GL.0N.0					50 005 816	
03.1980→12.1985	100 GL.9N.0						
09.1982→12.1985	146 A.000						
01.1986→03.1992	146 A.048						
Reference	4227634	4284907	46514517				
Panda I 900i					75		
04.1992→09.2003	170 A1.000					50 005 816	
04.1992→09.2003	170 A1.046						
Reference	4227634	4284907	46514517				
Panda I 1.0					76		
01.1986→03.1997	156 A2.000					50 005 303	
01.1986→03.1997	156 A2.048						
01.1986→03.1997	156 A2.100						
01.1986→03.1997	156 A2.146						
01.1986→03.1997	156 A2.246						
Reference	46423351 7691820	46531183 7715242	5973713	7640163			
Panda I 1.0i					77		
10.1987→05.1991	156 A2.146					50 005 303	
01.1986→04.1992	156 A2.246						
Reference	46423351 7691820	46531183 7715242	5973713	7640163			
Panda I 1.1i					78		
01.1985→03.1997	156 C.046					50 005 303	
01.1995→09.2003	176 B2.000						
Reference	46423351 7691820	46531183 7715242	5973713	7640163			
	176 B2.000: →9042882						
Panda II 1.3 JTD 16V					79		
09.2003→	188 A9.000					50 005 760	
Reference	46819138						
Petra 1.2i 16V					80		
03.2003→	188 A5.000					50 005 057 NEW	
Reference	46520401	55184081					
Punto 1.1i					81		
08.1993→08.1999	176 A6.000					50 005 303	
01.1995→08.1999	176 B2.000						
Reference	46423351 7691820	46531183 7715242	5973713	7640163			
	→9042882						

F

**Punto 1.2i****82**08.1993→04.1997
08.1993→08.1999176 A7.000
176 A8.000

Reference

46423351
7691820
→904288246531183
7715242

5973713

7640163

**50 005 303****Punto 1.2i 16V****83**05.1997→
07.1999→176 B9.000
188 A5.000

Reference

46520401

55184081

**50 005 057**

NEW

F**Punto 1.3 JTD 16V****84**

07.2003→

188 A9.000

Reference

46819138

**50 005 760****Regata 70 1.3****85**

09.1983→08.1989

138 A3.1A.0

Reference

4227634

4284907

46514517

**50 005 816****Ritmo 60 1.1****86**

02.1983→12.1987

138 B.000

Reference

4227634

4284907

46514517

**50 005 816****Ritmo 65 1.3****87**

07.1978→09.1982

138 A1.000

07.1978→09.1982

138 A3.1A.0

Reference

4227634

4284907

46514517

**50 005 816****Ritmo 70 1.3****88**

10.1982→04.1985

138 A1.000

10.1982→04.1985

138 A3.1A.0

Reference

4227634

4284907

46514517

**50 005 816****Scudo 1.8i****89**

10.1995→

XU 7JP

Reference

9565656788

**50 005 319**

**Scudo 1.9 D****90**

10.1995→05.2000 Reference	XUD 9A 9565095580	9566945688			50 005 313
10.1995→05.2000 09.1998→ 06.1998→ 06.1998→ 10.1995→05.2000 Reference	D9B DW8 WJY WJZ XUD 9A 9562409187			50 005 815	
09.1998→ Reference	DW8 9569147388				50 005 329

Scudo 2.0 JTD**91**

10.1999→ 10.1999→ Reference	RHX RHZ 9569342587	9569342587		50 005 824	
10.1999→ 10.1999→ Reference	RHX RHZ 9569147388				50 005 329

Scudo 2.0 JTD 140 16V**92**

01.2007→ Reference	DW10 BTED4 9463623088				50 005 779
01.2007→ Reference	DW10 BTED4 9569342587	9569342587		50 005 824	

Sedici 1.6i 16V**93**







03.2006→ Reference	M16A (79 kW) 71742124				50 005 180 <small>NEW</small>
-----------------------	--------------------------	--	--	--	----------------------------------

Seicento 1.1i**94**

03.1998→ Reference	176 B2.000 46423351 7691820 →9042882	46531183 7715242	5973713	7640163		50 005 303
-----------------------	---	---------------------	---------	---------	--	------------

F



Siena 1.0					95
Reference	1.0L FIRE 8V 46520401	55184081			50 005 057 NEW
Siena 1.2i 16V					96
10.2001→ Reference	188 A5.000 46520401	55184081			50 005 057 NEW
Stilo 1.2i 16V					97
10.2001→12.2003 Reference	188 A5.000 46520401	55184081			50 005 057 NEW
Stilo 1.9 JTD					98
10.2001→09.2007 Reference	937 A4.000 46804051				50 005 056 NEW
Stilo 1.9 JTD 16V					99
01.2004→09.2007 09.2005→ 2006 → 09.2007 Reference	192 A5.000 937 A5.000 939 A2.000 46804051				50 005 056 NEW
10.2001→09.2007 Reference	192 A3.000 46432248 60814609	46515970 60815559	46515972	59722248	50 005 332
Strada 1.1					100
02.1983→1985 Reference	138 B.000 4227634	4284907	46514517		50 005 816
Tempra 1.4					101
02.1990→12.1996 Reference	159 A2.000 46437911 9.336.693→	7752928			50 005 334

F

**Tempra 1.4i****102**

03.1992→12.1996 160 A1.046

Reference 46437911 7752928
9.336.693→

50 005 334

Tipo 1.1**103**

07.1987→03.1993 160 A3.000

Reference 46423351 46531183 5973713 7640163
7691820 7715242

50 005 303

F

Tipo 1.1i**104**

10.1994→10.1995 156 C.046

Reference 46423351 46531183 5973713 7640163
7691820 7715242

50 005 303

Tipo 1.7 D**105**

07.1987→10.1995 149 B4.000

Reference 7555039



50 005 324

Ulysse 1.8i**106**05.1996→
10.1995→Reference LFW
XU 7JP
9565656788

50 005 319

10.1995→

Reference XU 7JP
9567205088 9567205088

50 005 854

Ulysse 1.9 TD**107**

05.1995→07.1997 XUD 9TF

Reference 9565095580 9566945688



50 005 313

Ulysse 2.0 JTD**108**

07.1999→09.2002 RHZ

Reference 9569342587 9569342587

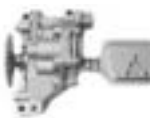

50 005 824









07.1999→09.2002 RHZ

Reference 9569147388



50 005 329



Ulysse 2.0 JTD 16V					109
07.2006→ Reference	DW10 BTED4 9463623088				50 005 779
09.2002→ 07.2006→ 09.2002→ 11.2000→ Reference	DW10 ATED4 DW10 BTED4 RHT RHW 9569342587 9569342587			50 005 824	
09.2002→ 11.2000→ Reference	DW10 ATED4 RHW 9569147388				50 005 329
Ulysse 2.0i					110
03.1994→ Reference	RFW 9567205088 9567205088			50 005 854	
09.1994→05.2000 03.1994→ Reference	RFU RGU 9565095580 9566945688				50 005 313
Ulysse 2.0i 16V					111
05.1998→02.2000 Reference	RFV 9567205088 9567205088			50 005 854	
Ulysse 2.1 TD 12V					112
05.1996→10.1999 03.1996→ Reference	P8C XUD 11ATE 9604708880 9629110980				50 005 322
Ulysse 2.2 JTD 16V					113
09.2002→05.2003 Reference	DW12 TED4 9463623088				50 005 779
Uno 45 0.9					114
01.1983→09.1992 01.1983→09.1992 09.1989→03.1994 01.1983→05.1985 Reference	100 GL.9N.0 146 A.000 146 A.048 146 A1.000 4227634 4284907 46514517			50 005 816	

F

**Uno 45 1.0****115**

03.1985→01.1988

156 A2.000

Reference

46423351
769182046531183
7715242

5973713

7640163



50 005 303

Uno 45 1.0i**116**

09.1989→09.1992

156 A2.048

03.1989→03.1994

156 A2.100

06.1992→03.1994

156 A2.246

Reference

46423351
769182046531183
7715242

5973713

7640163



50 005 303

Uno 55 1.1**117**

01.1983→03.1985

138 B.000

Reference

4227634

4284907

46514517



50 005 816

Uno 60 1.1**118**

09.1989→12.2000

160 A3.000

Reference

46423351
769182046531183
7715242

5973713

7640163



50 005 303

Uno 60 1.1i**119**

09.1989→09.1993

156 C.046

Reference

46423351
769182046531183
7715242

5973713

7640163



50 005 303

Uno Mondo 1.0i**120**

01.1996→

156 A2.246

Reference

46423351
769182046531183
7715242

5973713

7640163



50 005 303

Uno Mondo 1.1**121**

01.1998→

160 A3.000

Reference

46423351
769182046531183
7715242

5973713

7640163



50 005 303

X 1/9 1.5**122**

10.1978→10.1988

128 AS.000

Reference

4227634

4284907

46514517



50 005 816

F

**60 E10 EuroCargo****123**01.1991→05.1996 8040.45 4000
Reference 98415831

50 005 604

60 E12 EuroCargo**124**1986 →1991 8040.25 400
01.1991→05.1996 8040.45 4000
Reference 98415831

50 005 604

60 E14 EuroCargo**125**Reference 8040.45 4000, 4010, 4020, 4030, 4035, 4090, 410, 4800, 5200, 5281, X.4180
98415831

50 005 604

65 E12 EuroCargo**126**1986 →1991 8040.25 400
Reference 98415831

50 005 604

65 E14 EuroCargo**127**Reference 8040.45 4000, 4010, 4020, 4030, 4035, 4090, 410, 4800, 5200, 5281, X.4180
98415831

50 005 604

75 E12 EuroCargo**128**1986 →1991 8040.25 400
01.1991→12.1992 8040.45 4000
Reference 98415831

50 005 604

75 E14 EuroCargo**129**Reference 8040.45 4000, 4010, 4020, 4030, 4035, 4090, 410, 4180, 4300, 4305, 4380, 4381, 4800, 5200, 5281, D.5100, D.5103, X.4180
98415831

50 005 604

75 E15 EuroCargo**130**01.1991→ 8060.25 R.4200, R.4300
Reference 98415831

50 005 604

80 E14 EuroCargo**131**01.1996→ 8040.45 4000
Reference 98415831

50 005 604

80 E15 EuroCargo**132**01.1991→08.2000 8060.25 R.4200, R.4300
Reference 98415831

50 005 604

F

**80 E18 EuroCargo****133**

1986 → 8060.25 000, 400, 420, V.4000, V.4800
 1996 → 8060.45 B.5100, B.5186
 Reference 98415831



50 005 604

80 E21 EuroCargo**134**

01.1991 → 8060.45 4700, 4708, X.4180
 Reference 98415831



50 005 604

95 E15 EuroCargo**135**

01.1991 → 12.2000 8060.25 R.4200, R.4300
 Reference 98415831



50 005 604

95 E18 EuroCargo**136**

01.1990 → 8060.25 V.4000
 Reference 98415831



50 005 604

95 E21 EuroCargo**137**

01.1991 → 12.2000 8060.45 4700, 4708
 Reference 98415831



50 005 604

100 E15 EuroCargo**138**

01.1991 → 08.2000 8060.25 R.4200, R.4300
 Reference 98415831



50 005 604

100 E18 EuroCargo**139**

1986 → 11.2000 8060.25 400, 420, V.4000, V.4800
 1996 → 8060.45 B.5100, B.5186
 Reference 98415831



50 005 604

100 E21 EuroCargo**140**

01.1991 → 8060.45 4700, 4708, X.4180
 Reference 98415831



50 005 604

120 E15 EuroCargo**141**

01.1991 → 8060.25 R.4200, R.4280, R.4300
 1996 → 8060.45 R.5000, R.5046
 Reference 98415831



50 005 604

120 E18 EuroCargo**142**

1986 → 07.2000 8060.25 400, 420, V.4080
 1996 → 8060.45 B.5100
 Reference 98415831



50 005 604

F

**120 E23 EuroCargo****143**

10.1991→ 8060.45 6090, K.6090, K.6096, S.6800, S.7200, S.7215
 Reference 4838676



50 005 606

130 E15 EuroCargo**144**

02.1992→07.2000 8060.25 R.4200, R.4280, R.4300
 Reference 98415831



50 005 604

130 E18 EuroCargo**145**

1986→07.2000 8060.25 400, 420, V.4080
 1996→ 8060.45 B.5100
 Reference 98415831



50 005 604

130 E23 EuroCargo**146**

04.1992→ 8060.45 6090, K.6090, K.6096, S.7200, S.7215
 Reference 4838676



50 005 606

135 E18 EuroCargo**147**

11.1991→07.2000 8060.25 V.4000, V.4800
 Reference 98415831



50 005 604

135 E23 EuroCargo**148**

04.1992→ 8060.45 K.6090, K.6096, S.6700
 Reference 4838676



50 005 606

11.1991→ 8060.25 V.4080
 Reference 98415831



50 005 604

150 E15 EuroCargo**149**

12.1991→07.2000 8060.25 R.4280
 Reference 98415831



50 005 604

150 E18 EuroCargo**150**

09.1991→07.2000 8060.25 V.4080
 1996→ 8060.45 B.5100
 Reference 98415831



50 005 604

**150 E23 EuroCargo****151**

10.1991→ 8060.45 6090, K.6090, K.6096, S.6800, S.7200, S.7215
 Reference 4838676



50 005 606

170 E18 EuroCargo**152**

1986 → 8060.25 400, 420, V.4000, V.4800
 1996 → 8060.45 B.5100
 Reference 98415831



50 005 604

170 E23 EuroCargo**153**

01.1994→07.2000 8060.45 S.6700
 Reference 4838676



50 005 606

180 E21 EuroCargo**154**

04.1992→ 8060.45 4700, 4708, X.4180
 Reference 98415831



50 005 604

260 E23 EuroCargo**155**

12.1991→ 8060.45 K.6090, K.6096, S.6700, S.6800
 Reference 4838676



50 005 606

280 E23 EuroCargo**156**

12.1991→11.2000 8060.45 S.6700
 Reference 4838676



50 005 606

315 E18 EuroCargo**157**

1986 →1991 8060.25 400, 420
 Reference 98415831



50 005 604

190 E42 EuroStar**158**

04.1992→ 8210.42 L.400, L.499
 Reference 98447660
 Durchmesser 65 mm, Zähnezahl 19
 diameter 65 mm, gear z=19
 Diamètre 65 mm, Nombre de dents 19
 Diámetro 65 mm, Número des dientes 19
 Диаметр 65 мм, число зубьев 19
 8210.42L.400: →01.1995



50 005 609

04.1992→ 8210.42 L.400, L.499
 Reference 98447661
 8210.42L.400: →01.1995



50 005 610

**240 E42 EuroStar****159**

04.1992→ Reference 	8210.42 L.400 98447660 Durchmesser 65 mm, Zähnezahl 19 diameter 65 mm, gear z=19 Diamètre 65 mm, Nombre de dents 19 Diámetro 65 mm, Número de dientes 19 Диаметр 65 мм, число зубьев 19 →01.1995			50 005 609
04.1992→ Reference 	8210.42 L.400 98447661 →01.1995			50 005 610

F**260 E42 EuroStar****160**

04.1992→ Reference 	8210.42 L.400 98447660 Durchmesser 65 mm, Zähnezahl 19 diameter 65 mm, gear z=19 Diamètre 65 mm, Nombre de dents 19 Diámetro 65 mm, Número de dientes 19 Диаметр 65 мм, число зубьев 19 →01.1995			50 005 609
04.1992→ Reference 	8210.42 L.400 98447661 →01.1995			50 005 610

400 E42 EuroStar**161**

04.1992→ Reference 	8210.42 L.400 98447660 Durchmesser 65 mm, Zähnezahl 19 diameter 65 mm, gear z=19 Diamètre 65 mm, Nombre de dents 19 Diámetro 65 mm, Número de dientes 19 Диаметр 65 мм, число зубьев 19 →01.1995			50 005 609
04.1992→ Reference 	8210.42 L.400 98447661 →01.1995			50 005 610



440 E42 EuroStar**162**

04.1992→ Reference 	8210.42 L.400 98447660 Durchmesser 65 mm, Zähnezahl 19 diameter 65 mm, gear z=19 Diamètre 65 mm, Nombre de dents 19 Diámetro 65 mm, Número de dientes 19 Диаметр 65 мм, число зубьев 19 →01.1995			50 005 609
04.1992→ Reference 	8210.42 L.400 98447661 →01.1995			50 005 610





**180 E42 EuroTech****163**

04.1992→07.2000	8210.42	L.400			
Reference	98447660				
	Durchmesser 65 mm, Zähnezahl 19 diameter 65 mm, gear z=19 Diamètre 65 mm, Nombre de dents 19 Diámetro 65 mm, Número de dientes 19 Диаметр 65 мм, число зубьев 19 →01.1995				50 005 609
04.1992→07.2000	8210.42	L.400			
Reference	98447661				
	→01.1995				50 005 610

240 E42 EuroTech**164**

04.1992→	8210.42	L.400			
Reference	98447660				
	Durchmesser 65 mm, Zähnezahl 19 diameter 65 mm, gear z=19 Diamètre 65 mm, Nombre de dents 19 Diámetro 65 mm, Número de dientes 19 Диаметр 65 мм, число зубьев 19 →01.1995				50 005 609
04.1992→	8210.42	L.400			
Reference	98447661				
	→01.1995				50 005 610

260 E42 EuroTech**165**

04.1992→	8210.42	L.400			
Reference	98447660				
	Durchmesser 65 mm, Zähnezahl 19 diameter 65 mm, gear z=19 Diamètre 65 mm, Nombre de dents 19 Diámetro 65 mm, Número de dientes 19 Диаметр 65 мм, число зубьев 19 →01.1995				50 005 609
04.1992→	8210.42	L.400			
Reference	98447661				
	→01.1995				50 005 610

440 E42 EuroTech**166**

04.1992→	8210.42	L.400			
Reference	98447660				
	Durchmesser 65 mm, Zähnezahl 19 diameter 65 mm, gear z=19 Diamètre 65 mm, Nombre de dents 19 Diámetro 65 mm, Número de dientes 19 Диаметр 65 мм, число зубьев 19 →01.1995				50 005 609
04.1992→	8210.42	L.400			
Reference	98447661				
	→01.1995				50 005 610

**180 E42 EuroTrakker****167**

04.1992→ Reference 	8210.42 L.400, L.4000, L.499, L.4990 98447660 Durchmesser 65 mm, Zähnezahl 19 diameter 65 mm, gear z=19 Diamètre 65 mm, Nombre de dents 19 Diámetro 65 mm, Número de dientes 19 Диаметр 65 мм, число зубьев 19 8210.42L.400: →01.1995			50 005 609
04.1992→ Reference 	8210.42 L.400, L.4000, L.499, L.4990 98447661 8210.42L.400: →01.1995			50 005 610

F**190 E37 EuroTrakker****168**

04.1993→ Reference 	8210.42 009, K.300, K.379 98447660 Durchmesser 65 mm, Zähnezahl 19 diameter 65 mm, gear z=19 Diamètre 65 mm, Nombre de dents 19 Diámetro 65 mm, Número de dientes 19 Диаметр 65 мм, число зубьев 19			50 005 609
04.1993→ Reference	8210.42 009, K.300, K.379 98447661			50 005 610



190 E42 EuroTrakker**169**

04.1992→ Reference 	8210.42 L.400, L.4000, L.499, L.4990 98447660 Durchmesser 65 mm, Zähnezahl 19 diameter 65 mm, gear z=19 Diamètre 65 mm, Nombre de dents 19 Diámetro 65 mm, Número de dientes 19 Диаметр 65 мм, число зубьев 19 8210.42L.400: →01.1995			50 005 609
04.1992→ Reference 	8210.42 L.400, L.4000, L.499, L.4990 98447661 8210.42L.400: →01.1995			50 005 610

240 E42 EuroTrakker**170**

04.1992→ Reference 	8210.42 L.400, L.4000, L.499, L.4990 98447660 Durchmesser 65 mm, Zähnezahl 19 diameter 65 mm, gear z=19 Diamètre 65 mm, Nombre de dents 19 Diámetro 65 mm, Número de dientes 19 Диаметр 65 мм, число зубьев 19 8210.42L.400: →01.1995			50 005 609
04.1992→ Reference 	8210.42 L.400, L.4000, L.499, L.4990 98447661 8210.42L.400: →01.1995			50 005 610



**260 E37 EuroTrakker****171**

12.1994→ Reference	8210.42 98447660	K.300, K.3000, K.379, K.3790			50 005 609
	Durchmesser 65 mm, Zähnezahl 19 diameter 65 mm, gear z=19 Diamètre 65 mm, Nombre de dents 19 Diámetro 65 mm, Número des dientes 19 Диаметр 65 мм, число зубьев 19				
12.1994→ Reference	8210.42 98447661	K.300, K.3000, K.379, K.3790			50 005 610



260 E42 EuroTrakker**172**

06.1992→ Reference	8210.42 98447660	L.400, L.4000, L.499, L.4990			50 005 609
	Durchmesser 65 mm, Zähnezahl 19 diameter 65 mm, gear z=19 Diamètre 65 mm, Nombre de dents 19 Diámetro 65 mm, Número des dientes 19 Диаметр 65 мм, число зубьев 19 8210.42L.400: →01.1995				
06.1992→ Reference	8210.42 98447661	L.400, L.4000, L.499, L.4990			50 005 610
	8210.42L.400: →01.1995				



340 E37 EuroTrakker**173**

Reference	8210.42 98447660	009, K.300, K.3000, K.379, K.3790			50 005 609
	Durchmesser 65 mm, Zähnezahl 19 diameter 65 mm, gear z=19 Diamètre 65 mm, Nombre de dents 19 Diámetro 65 mm, Número des dientes 19 Диаметр 65 мм, число зубьев 19				
Reference	8210.42 98447661	009, K.300, K.3000, K.379, K.3790			50 005 610



340 E42 EuroTrakker**174**

04.1993→ Reference	8210.42 98447660	L.400, L.4000, L.499, L.4990			50 005 609
	Durchmesser 65 mm, Zähnezahl 19 diameter 65 mm, gear z=19 Diamètre 65 mm, Nombre de dents 19 Diámetro 65 mm, Número des dientes 19 Диаметр 65 мм, число зубьев 19 8210.42L.400: →01.1995				
04.1993→ Reference	8210.42 98447661	L.400, L.4000, L.499, L.4990			50 005 610
	8210.42L.400: →01.1995				



**380 E37 EuroTrakker****175**

Reference	8210.42 009 98447660			50 005 609
	Durchmesser 65 mm, Zähnezahl 19 diameter 65 mm, gear z=19 Diamètre 65 mm, Nombre de dents 19 Diámetro 65 mm, Número des dientes 19 Диаметр 65 мм, число зубьев 19			
Reference	8210.42 009 98447661			50 005 610



F**400 E37 EuroTrakker****176**

07.1994→	8210.42 K.300, K.3000, K.3790			50 005 609
Reference	98447660			
	Durchmesser 65 mm, Zähnezahl 19 diameter 65 mm, gear z=19 Diamètre 65 mm, Nombre de dents 19 Diámetro 65 mm, Número des dientes 19 Диаметр 65 мм, число зубьев 19			
07.1994→	8210.42 K.300, K.3000, K.3790			50 005 610
Reference	98447661			

400 E42 EuroTrakker**177**

04.1992→	8210.42 L.400, L.4000, L.499, L.4990			50 005 609
Reference	98447660			
	Durchmesser 65 mm, Zähnezahl 19 diameter 65 mm, gear z=19 Diamètre 65 mm, Nombre de dents 19 Diámetro 65 mm, Número des dientes 19 Диаметр 65 мм, число зубьев 19 8210.42L.400: →01.1995			
04.1992→	8210.42 L.400, L.4000, L.499, L.4990			50 005 610
Reference	98447661 8210.42L.400: →01.1995			

410 E37 EuroTrakker**178**

04.1992→	8210.42 K.300, K.3000, K.379, K.3790			50 005 609
Reference	98447660			
	Durchmesser 65 mm, Zähnezahl 19 diameter 65 mm, gear z=19 Diamètre 65 mm, Nombre de dents 19 Diámetro 65 mm, Número des dientes 19 Диаметр 65 мм, число зубьев 19			
04.1992→	8210.42 K.300, K.3000, K.379, K.3790			50 005 610
Reference	98447661			

**410 E42 EuroTrakker****179**

04.1992→ 8210.42 L.400, L.4000, L.499, L.4990

Reference

98447660



Durchmesser 65 mm, Zähnezahl 19
 diameter 65 mm, gear z=19
 Diamètre 65 mm, Nombre de dents 19
 Diámetro 65 mm, Número de dientes 19
 Диаметр 65 мм, число зубьев 19
 8210.42L.400: →01.1995



50 005 609

04.1992→ 8210.42 L.400, L.4000, L.499, L.4990

Reference

98447661



8210.42L.400: →01.1995



50 005 610

F

440 E37 EuroTrakker**180**

01.1998→ 8210.42 K.3000, K.3790

Reference

98447660



Durchmesser 65 mm, Zähnezahl 19
 diameter 65 mm, gear z=19
 Diamètre 65 mm, Nombre de dents 19
 Diámetro 65 mm, Número de dientes 19
 Диаметр 65 мм, число зубьев 19



50 005 609

01.1998→ 8210.42 K.3000, K.3790

Reference

98447661



50 005 610

440 E42 EuroTrakker**181**

06.1992→ 8210.42 L.400, L.4000, L.499, L.4990

Reference

98447660



Durchmesser 65 mm, Zähnezahl 19
 diameter 65 mm, gear z=19
 Diamètre 65 mm, Nombre de dents 19
 Diámetro 65 mm, Número de dientes 19
 Диаметр 65 мм, число зубьев 19
 8210.42L.400: →01.1995



50 005 609

06.1992→ 8210.42 L.400, L.4000, L.499, L.4990

Reference

98447661



8210.42L.400: →01.1995



50 005 610

720 E42 EuroTrakker**182**

09.1993→ 8210.42 K.300, K.3000, K.3790, L.400, L.4000, L.499, L.4990

Reference

98447660



Durchmesser 65 mm, Zähnezahl 19
 diameter 65 mm, gear z=19
 Diamètre 65 mm, Nombre de dents 19
 Diámetro 65 mm, Número de dientes 19
 Диаметр 65 мм, число зубьев 19
 8210.42L.400: →01.1995



50 005 609

09.1993→ 8210.42 K.300, K.3000, K.3790, L.400, L.4000, L.499, L.4990

Reference

98447661



8210.42L.400: →01.1995



50 005 610



**Series 40****183**

10.1985→05.1989	8140.61	200						
Reference	4714636	4754850	4764761	7303009				50 005 321

Series 48**184**

01.1988→	D 3.152						50 005 234 NEW	
----------	---------	--	--	--	--	---	-------------------	--

F**Series 50-9****185**

01.1987→06.1991	8040.05	230						50 005 624
Reference	4813370							
02.1990→06.1991	8040.25	230						50 005 605
Reference	98497115							
	Gewinde M16 x 1,5 thread M16 x 1,5 Filet M16 x 1,5 Rosca M16 x 1,5 Резьба M16 x 1,5							
02.1990→06.1991	8040.25	230						50 005 623
Reference	98403019							

Series 60-9**186**

01.1987→12.1992	8040.05	230						50 005 624
Reference	4813370							

Series 60-11**187**

1986 →	8040.25	230, 600						50 005 605
Reference	98497115							
	Gewinde M16 x 1,5 thread M16 x 1,5 Filet M16 x 1,5 Rosca M16 x 1,5 Резьба M16 x 1,5							
1986 →	8040.25	230, 600						50 005 623
Reference	98403019							

**Series 65-12****188**

1986 → Reference	8040.25 000, 200, 600 98497115 Gewinde M16 x 1,5 thread M16 x 1,5 Filet M16 x 1,5 Rosca M16 x 1,5 Резьба M16 x 1,5			50 005 605
1986 → Reference	8040.25 000, 200, 600 98403019			50 005 623

Series 75**189**

09.1972→02.1982 Reference	8060.02 000 93191101			50 005 620
------------------------------	-------------------------	--	--	------------

Series 75-12**190**

01.1987→ Reference	8040.25 000 98497115 Gewinde M16 x 1,5 thread M16 x 1,5 Filet M16 x 1,5 Rosca M16 x 1,5 Резьба M16 x 1,5			50 005 605
01.1987→ Reference	8040.25 000 98403019			50 005 623

Series 79-12**191**

1986 →12.1992 Reference	8040.25 220, 420 98497115 Gewinde M16 x 1,5 thread M16 x 1,5 Filet M16 x 1,5 Rosca M16 x 1,5 Резьба M16 x 1,5			50 005 605
1986 →12.1992 Reference	8040.25 220, 420 98403019			50 005 623

Series 80**192**

09.1972→02.1982 Reference	8060.02 000 93191101			50 005 620
------------------------------	-------------------------	--	--	------------

F



Series 84

193

01.1969→12.1975	4.236			50 005 246 NEW
01.1969→12.1975	4.236 mit Riemenscheibe with pulley avec poulie con polea с Ремснный шкив			50 005 245 NEW
01.1969→12.1975	4.236			50 005 252 NEW

Series 90

194

09.1972→02.1982	8060.02 000			50 005 620
Reference	93191101			

Series 95-14

195













07.1983→10.1985	8060.04 669			50 005 605
Reference	98497115 Gewinde M16 x 1,5 thread M16 x 1,5 Filet M16 x 1,5 Rosca M16 x 1,5 Резьба M16 x 1,5			
07.1983→10.1985	8060.04 669			50 005 623
Reference	98403019			

Series 100

196

01.1969→12.1975	4.236			50 005 246 NEW
01.1969→12.1975	4.236 mit Riemenscheibe with pulley avec poulie con polea с Ремснный шкив			50 005 245 NEW



				
01.1969→12.1975	4.236			50 005 252 NEW
09.1972→12.1981 Reference	8060.02 000 93191101			50 005 620
Series 109-14				197
06.1983→12.1985 Reference	8060.04 689 98497115 Gewinde M16 x 1,5 thread M16 x 1,5 Filet M16 x 1,5 Rosca M16 x 1,5 Резьба M16 x 1,5			50 005 605
06.1983→12.1985 Reference	8060.04 689 98403019			50 005 623
Series 110				198
09.1972→10.1982 Reference	8060.02 000 93191101			50 005 620
Series 115-14				199
11.1985→12.1991 Reference	8060.05 200 98497115 Gewinde M16 x 1,5 thread M16 x 1,5 Filet M16 x 1,5 Rosca M16 x 1,5 Резьба M16 x 1,5			50 005 605
11.1985→12.1991 Reference	8060.05 200 98403019			50 005 623
Series 115-17				200
09.1983→12.1985 Reference	8060.24 601 98497115 Gewinde M16 x 1,5 thread M16 x 1,5 Filet M16 x 1,5 Rosca M16 x 1,5 Резьба M16 x 1,5			50 005 605
09.1983→12.1985 Reference	8060.24 601 98403019			50 005 623



Series 135-14

201

11.1985→12.1991	8060.05	200						50 005 605
Reference	98497115							
	Gewinde M16 x 1,5 thread M16 x 1,5 Filet M16 x 1,5 Rosca M16 x 1,5 Резьба M16 x 1,5							
11.1985→12.1991	8060.05	200						50 005 623
Reference	98403019							

F



Series 135-17

202

09.1983→12.1985	8060.24	601						50 005 605
Reference	98497115							
	Gewinde M16 x 1,5 thread M16 x 1,5 Filet M16 x 1,5 Rosca M16 x 1,5 Резьба M16 x 1,5							
09.1983→12.1985	8060.24	601						50 005 623
Reference	98403019							

Series 175

203













01.1973→	4.236							50 005 246 <small>NEW</small>
01.1973→	4.236							50 005 245 <small>NEW</small>
	mit Riemenscheibe with pulley avec poulie con polea с Ремснный шкив							
01.1973→	4.236							50 005 252 <small>NEW</small>
01.1973→	4.248						50 005 840	

Series 190

204









07.1990→	8210.42	173						50 005 607
Reference	99458099							



					
07.1990→ Reference	8210.42 99458098	173			50 005 608
Series 190-36					
07.1990→ Reference	8210.42 99458099	061, 073, 182, 191			50 005 607
07.1990→ Reference	8210.42 99458098	061, 073, 182, 191			50 005 608
Series 220					
07.1987→06.1990 Reference	8210.42 99458099	115			50 005 607
07.1987→06.1990 Reference	8210.42 99458098	115			50 005 608
Series 238					
04.1978→1985 Reference	8140.61 4714636	200, 300 4754850	4764761	7303009	
Series 240					
07.1987→ Reference	8210.42 99458099	115, 155			50 005 607
07.1987→ Reference	8210.42 99458098	115, 155			50 005 608

F



Series 260					209
07.1990→12.1999 Reference	8210.42 99458099	155			50 005 607
07.1990→12.1999 Reference	8210.42 99458098	155			50 005 608
Series 300					210
09.1972→02.1982 Reference	8060.02 93191101	000			50 005 620
Series 314					211
09.1972→02.1982 Reference	8060.02 93191101	000			50 005 620
Series 315					212
05.1978→02.1986 Reference	8060.04 93191101	051			50 005 620
Series 316					213
01.1980→ Reference	8060.04 93191101	052			50 005 620
Series 330					214
10.1991→ Reference	8210.42 98447660	009			50 005 609
	Durchmesser 65 mm, Zähnezahl 19 diameter 65 mm, gear z=19 Diamètre 65 mm, Nombre de dents 19 Diámetro 65 mm, Número de dientes 19 Диаметр 65 мм, число зубьев 19				
10.1991→ Reference	8210.42 98447661	009			50 005 610

F



Series 345

215

01.1972→

4.248



50 005 840

Series 520

216

01.1984→

D 3.152



50 005 234

NEW

F

Series 600

217

01.1980→

4.236



50 005 246

NEW

01.1980→



4.236
mit Riemenscheibe
with pulley
avec poulie
con polea
с Ремсннй шкив



50 005 245

NEW

01.1980→

4.236



50 005 252

NEW

Series 645

218

02.1972→02.1982

8060.02 000

Reference

93191101



50 005 620

Series 650

219

09.1972→02.1982

8060.02 000

Reference

93191101



50 005 620

Series 655

220

09.1972→02.1982

8060.02 000

Reference

93191101



50 005 620

**Series 662****221**

09.1972→02.1982

8060.02 000

Reference

93191101



50 005 620

Series 672**222**

09.1972→02.1982

8060.02 000

Reference

93191101



50 005 620

F**Series 700****223**

01.1980→

4.236

50 005 246
NEW

01.1980→

4.236
mit Riemenscheibe
with pulley
avec poulie
con polea
с Ремснный шкив50 005 245
NEW

01.1980→

4.236

50 005 252
NEW**Series 820****224**

01.1984→

4.236

50 005 246
NEW

01.1984→

4.236
mit Riemenscheibe
with pulley
avec poulie
con polea
с Ремснный шкив50 005 245
NEW

01.1984→

4.236

50 005 252
NEW**Series 840****225**

01.1972→

4.248



50 005 840

**Series 900****226**

04.1978→1985

8140.61

200, 300

Reference

4714636

4754850

4764761

7303009



50 005 321

03.1971→1985

100 GL.ON.0

Reference

4227634

4284907

46514517



50 005 816

F

Series 920**227**

01.1984→

4.248



50 005 840

Series 980**228**

09.1972→02.1982

8060.02

000

Reference

93191101



50 005 620

Series 1000**229**

09.1972→02.1982

8060.02

000

Reference

93191101



50 005 620

Series 3300**230**

4.236

50 005 246
NEW4.236
mit Riemenscheibe
with pulley
avec poulie
con polea
с Ремсннй шкив50 005 245
NEW

4.236

50 005 252
NEW**Series A 40-8****231**

10.1985→05.1989

8140.61

200

Reference

4714636

4754850









4764761

7303009



50 005 321



Series AC 160					232
01.1971→12.1975	D 3.152			50 005 234 NEW	
Series ACF 110					233
01.1971→12.1972	4.203			50 005 247 NEW	F
01.1971→12.1972	4.203			50 005 252 NEW	
Series ACP 40 / 50					234
01.1973→	4.203			50 005 247 NEW	
01.1973→	4.203			50 005 252 NEW	
Series DI 20					235
01.1980→02.1986	8035.04 359			50 005 620	
Reference	93191101				
Series DI 25					236
01.1980→02.1986	8035.04 359			50 005 620	
Reference	93191101				
Series DI 30					237
01.1980→02.1986	8035.04 359			50 005 620	
07.1981→05.1985	8045.04 359				
Reference	93191101				

**Series DI 35****238**07.1981→05.1985 8045.04 359
Reference 93191101

50 005 620

Series DI 40**239**07.1981→05.1985 8045.04 359
Reference 93191101

50 005 620

Series DI 70**240**10.1985→ 8055.05 250
Reference 93191101

50 005 620

Series DI 80**241**10.1985→ 8055.05 250
Reference 93191101

50 005 620

Series M 100**242**

01.1969→12.1975 4.236

50 005 246
NEW01.1969→12.1975 4.236
 mit Riemenscheibe
with pulley
avec poulie
con polea
с Ремснный шкив50 005 245
NEW

01.1969→12.1975 4.236

50 005 252
NEW**Series M 84****243**

01.1969→12.1975 4.236

50 005 246
NEW

F



01.1969→12.1975 	4.236 mit Riemenscheibe with pulley avec poulie con polea с Ремснный шкив			50 005 245 NEW
01.1969→12.1975	4.236			50 005 252 NEW
190 TurboStar				244
07.1990→1992 Reference	8210.42 151 99458099			50 005 607
07.1990→1992 Reference	8210.42 151 99458098			50 005 608
240 TurboStar				245
07.1990→ Reference	8210.42 152, 154, 172 99458099			50 005 607
07.1990→ Reference	8210.42 152, 154, 172 99458098			50 005 608
260 TurboStar				246
07.1988→12.2000 Reference	8210.42 115, 152, 172 99458099			50 005 607
07.1988→12.2000 Reference	8210.42 115, 152, 172 99458098			50 005 608

F



190 TurboTech

247

07.1990→
Reference 8210.42 151, 152, 154, 161, 162, 171, 172, 173
99458099



50 005 607

07.1990→
Reference 8210.42 151, 152, 154, 161, 162, 171, 172, 173
99458098



50 005 608

F

240 TurboTech

248

07.1990→
Reference 8210.42 151, 175
99458099



50 005 607

07.1990→
Reference 8210.42 151, 175
99458098



50 005 608

260 TurboTech

249

07.1990→12.1999
Reference 8210.42 175
99458099



50 005 607

07.1990→12.1999
Reference 8210.42 175
99458098



50 005 608

220 TurboTech

250

07.1990→
Reference 8210.42 152, 155, 172, 175
99458099



50 005 607

07.1990→
Reference 8210.42 152, 155, 172, 175
99458098



50 005 608



Engine

251

09.1995→ 8140.43 3700
08.1994→ 8140.47 3700
Reference 99438900







50 005 621

F





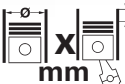

			Cyl		mm	cm ³	Comp. Ratio	€	kW	PS	Pos
1Z	D	(LA)	4	79,5 x 95,5	1896	2	19,5:1	66	90	53	
2504 E	D	(AN)	3	106,698 x 106,7	2870	2	16,5:1	35	47	119, 120, 121, 122, 129	
4AB	D	(AN)	4	93,67 x 90,5	2496	2		50	68	109	
4BA	D	(AN)	4	93,67 x 90,5	2496	2		50	68	109	
4BB	D	(AN)	4	93,67 x 90,5	2496	2	19,5:1	50	68	109	
4BB	D	(AN)	4	93,67 x 90,5	2496	2	20,5:1	52	71	109	
4BC	D	(A)	4	93,67 x 90,5	2496	2	20,6:1	52	71	111	
4CA (50 kW)	D	(AN)	4	93,67 x 90,5	2496	2	19,5:1	50	68	109	
4CA (52 kW)	D	(AN)	4	93,67 x 90,5	2496	2	20,5:1	52	71	109, 118	
4CC	D	(AN)	4	93,67 x 90,5	2496	2	20,6:1	52	71	111	
4D55T	D	(A)	4	91,1 x 90	2346	2	21:1	62-70	84-95	1	
4DA	D	(A)	4	93,67 x 90,5	2496	2	20,6:1	59	80	111	
4EA	D	(A)	4	93,67 x 90,5	2496	2	18,3:1	74	100	110	
4FA	D	(AN)	4	93,67 x 90,5	2496	2	20,6:1	51	69	111	
4FB	D	(AN)	4	93,67 x 90,5	2496	2	20,6:1	51	70	111	
4FC	D	(AN)	4	93,67 x 90,5	2496	2	20,6:1	52	70	111	
4FD	D	(AN)	4	93,67 x 90,5	2496	2	20,6:1	51	69	111	
4GA	D	(AN)	4	93,67 x 90,5	2496	2	20,6:1	63	85	101, 111	
4GB	D	(AN)	4	93,67 x 90,5	2496	2	20,6:1	63	85	101, 111	
4GC	D	(AN)	4	93,67 x 90,5	2496	2	20,6:1	63	85	101, 111	
4HA	D	(AN)	4	93,67 x 90,5	2496	2	20,6:1	56	76	100, 111	
4HB	D	(AN)	4	93,67 x 90,5	2496	2	20,6:1	56	76	100, 111	
4HC	D	(AN)	4	93,67 x 90,5	2496	2	20,6:1	56	76	111	
A9JA	B		4	74 x 75,5	1297	2	10,2:1	51	70	26, 64	
A9JB	B		4	74 x 75,5	1297	2	10,2:1	51	70	26, 64	
AAA	B		6	81 x 90,3	2792	2	10:1	120-128	163-174	55	
AFN	D	(LA)	4	79,5 x 95,5	1896	2	19,5:1	81	110	53	
AHU	D	(A)	4	79,5 x 95,5	1896	2	19,5:1	66	90	53	
ALDA	B		4	84,8 x 88	1988	4	10,2:1	127	173	42	
AMY	B		6	81 x 90,3	2792	2	10:1	128	174	55	
ANU	D	(LA)	4	79,5 x 95,5	1896	2	19,5:1	66	90	53	
AODA	B		4	87,5 x 83,1	1999	4	10,8:1	107	145	41	
AODB	B		4	87,5 x 83,1	1999	4	10,8:1	107	145	41	
ASZ	D	(LA)	4	79,5 x 95,5	1896	2	19:1	96	130	53	
AUY	D	(LA)	4	79,5 x 95,5	1896	2	18:1	85	115	53	
AYL	B		6	81 x 90,3	2792	4	10,5:1	150	204	56	
B	B		4	87,68 x 66	1593	2	8:1	48	65	103	
BAA	B		4	74 x 75,5	1297	2	10,2	44	60	64	
BAJA	B		4	74 x 75,5	1297	2	10,2	44	60	26	
BHDA	D	(LA)	4	82,5 x 82	1753	2	19,4:1	55	75	39	
BHDB	D	(LA)	4	82,5 x 82	1753	2	19,4:1	55	75	39	
BHPA	D	(LA)	4	82,5 x 82	1753	4	19,4:1	55	75	113	
BSD 333 H	D	(AN)	3	111,778 x 111,8	3294	2	15,3:1	38	52	123	
BSD 444	D	(AN)	4	111,778 x 111,9	4392	2	16,3:1	60	82	124, 125	
BSD 444 T	D	(A)	4	111,778 x 111,9	4392	2	15,6:1	68	92	124, 125, 126, 127	
BTB	D	(LA)	4	79,5 x 95,5	1896	2	19:1	110	150	53	
C (55 kW)	B		4	90,83 x 77	1993	2	8:1	57	77	104	
C9DA	D	(LA)	4	82,5 x 82	1753	2	19,4:1	67	91	39	
C9DB	D	(LA)	4	82,5 x 82	1753	2	19,4:1	67	91	39	
C9DC	D	(LA)	4	82,5 x 82	1753	2	19,4:1	67	91	39	
CFBA	B		4	83 x 83,1	1798	4	11,3:1	96	130	68	
CGBA	B		4	83 x 83,1	1798	4	10,8:1	81	110	67	
CGBB	B		4	83 x 83,1	1798	4	10,8:1	81	110	67	
CHBA	B		4	83 x 83,1	1798	4	10,8:1	92	125	67	
CHBB	B		4	83 x 83,1	1798	4	10,8:1	88-93	120-126	45, 67	
CJBA	B		4	87,5 x 83,1	1999	4	10,8:1	107	145	69	
CJBB	B		4	87,5 x 83,1	1999	4	10,8:1	107	145	47, 69, 95	
CSDA	B		4	83 x 83,1	1798	4	10,8:1	88	120	45	
CSDB	B		4	83 x 83,1	1798	4	10,8:1	88	120	45	
D2FA	D	(LA)	4	89,9 x 94,6	2402	4	19:1	66	90	108	
D4FA	D	(LA)	4	89,9 x 94,6	2402	4	19:1	88	120	108	
D5BA	D	(LA)	4	86 x 86	1998	4	19:1	63-66	85-90	70	
D6BA	D	(LA)	4	86 x 86	1998	4	18,5:1	85	116	71	
DHA	B		4	71,9 x 76,5	1242	4	10:1	55	75	24	
DHB	B		4	71,9 x 76,5	1242	4	10:1	55	75	24	
DHC	B		4	71,9 x 76,5	1242	4	10:1	55	75	24	
DHD	B		4	71,9 x 76,5	1242	4	10:1	55	75	24	
DHE	B		4	71,9 x 76,5	1242	4	10:1	55	75	24	
DHF	B		4	71,9 x 76,5	1242	4	10:1	55	75	24	



			Cyl	 mm	cm ³		Comp. Ratio ε	kW	PS	Pos
DHG	B		4	71,9 x 76,5	1242	4	10:1	55	75	24
DOFA	D	(LA)	4	89,9 x 94,6	2402	2	18,5:1	85-92	116-125	106
EDBA	B		4	84,8 x 88	1988	4	10:1	96	131	6
EDBB	B		4	84,8 x 88	1988	4	10:1	96	131	6
EDBC	B		4	84,8 x 88	1988	4	10:1	96	131	6
EDBD	B		4	84,8 x 88	1988	4	10:1	96	131	6
EDDB	B		4	84,8 x 88	1988	4	10:1	96	131	41
EDDC	B		4	84,8 x 88	1988	4	10:1	96	131	41
EDDD	B		4	84,8 x 88	1988	4	10:1	96	131	41
EDDF	B		4	84,8 x 88	1988	4	10:1	96	131	41
EYDB	B		4	80,8 x 88	1805	4	10:1	85	116	38
EYDC	B		4	80,6 x 88	1796	4	10:1	85	116	38
EYDD	B		4	80,6 x 88	1796	4	10:1	85	116	38
EYDE	B		4	80,6 x 88	1796	4	10:1	85	116	38
EYDF	B		4	80,6 x 88	1796	4	10:1	85	116	38
EYPA	B	(LA)	4	80,6 x 88	1796	4	10:1	81-85	110-116	102, 112
F 6 L 413 F	D	(AN)	6	125 x 130	9572	2	18:1	104-188	141-256	114, 115, 116, 117
F4B	B		4	77,25 x 74,3	1392	2	8,5:1	54-55	73-75	12
F4FA	D	(LA)	4	89,9 x 94,6	2402	4	19:1	55	75	108
F6A	B		4	77,25 x 74,3	1392	2	8,5:1	52	71	28
F6B	B		4	77,25 x 74,3	1392	2	8,5:1	54	73	12, 76
F6C	B		4	77,25 x 74,3	1392	2	8,5:1	52	71	27
F6D	B		4	77,25 x 74,3	1392	2	9,5:1	54	73	12, 76
F6E	B		4	77,25 x 74,3	1392	2	8,5:1	52	71	28
F6F	B		4	77,25 x 74,3	1392	2	8,5:1	52	71	12, 76
F6G	B		4	77,25 x 74,3	1392	2	8,5:1	52	71	12, 76
F9DA	D	(LA)	4	82,5 x 82	1753	2	18,5:1	85	116	40
F9DB	D	(LA)	4	82,5 x 82	1753	2	18,5:1	85	116	40
FHA	B		4	76 x 76,5	1388	4	10,3:1	66	92	29
FHD	B		4	76 x 76,5	1388	4	10,3:1	66	90	82
FHE	B		4	76 x 76,5	1388	4	10,3:1	66	90	29
FHF	B		4	76 x 76,5	1388	4	10,3:1	66	90	82
FUA	B		4	77,25 x 74,3	1392	2	9,5:1	55	75	11, 75
FUAA	B		4	77,25 x 74,3	1392	2	9,5:1	55	75	11
FUB	B		4	77,25 x 74,3	1392	2	9,5:1	55	75	27
FUBA	B		4	77,25 x 74,3	1392	2	9,5:1	51	69	27
FUC	B		4	77,25 x 74,3	1392	2	8,5:1	54	73	11, 75
FUD	B		4	77,25 x 74,3	1392	2	9,5:1	55	75	27
FUF	B		4	77,25 x 74,3	1392	2	9,5:1	55	75	27
FUH	B		4	77,25 x 74,3	1392	2	8,5:1	54	73	12, 76
FUJA	B		4	71,9 x 76,5	1242	4	10:1	55	75	24, 49
FUJB	B		4	71,9 x 76,5	1242	4	10:1	55	75	24, 49
FXDA	B		4	76 x 76,5	1388	4	11:1	55	75	35
FXDB	B		4	76 x 76,5	1388	4	11:1	55-59	75-80	35
FXDC	B		4	76 x 76,5	1388	4	11:1	55-59	75-80	35
FXDD	B		4	76 x 76,5	1388	4	11:1	55-59	75-80	35
FXJA	B		4	76 x 76,5	1388	4	11:1	59	80	29, 50
FXJB	B		4	76 x 76,5	1388	4	11:1	58	80	29, 50
FYDA	B		4	79 x 81,4	1596	4	11:1	74-76	101-103	31, 36, 44, 83
FYDB	B		4	79 x 81,4	1596	4	11:1	74	101	36
FYDC	B		4	79 x 81,4	1596	4	11:1	74	101	36
FYDD	B		4	79 x 81,4	1596	4	11:1	74	101	36
FYJA	B		4	79 x 81,4	1596	4	11:1	74	101	31, 51
G6A	B		4	68,7 x 75,5	1119	2	8,8:1	36-37	49-50	23
G6DA	D	(LA)	4	85 x 88	1997	4	18:1	96-103	130-140	43, 48, 54, 96
GLA	B		4	74 x 65	1117	2	9:1	39	53	22
GLB	B		4	74 x 65	1117	2	9,5:1	40	54	8
GLC	B		4	74 x 65	1117	2	9,5:1	37	50	22
GLW	B		4	74 x 65	1117	2	9:1	40	55	22
GPA	B		4	74 x 65	1117	2	9,5:1	43	58	8
GSE	B		4	74 x 65	1117	2	9:1	37	50	8
GSF	B		4	74 x 65	1117	2	9,5:1	37	50	22
GSG	B		4	74 x 65	1117	2	9,5:1	37	50	8
GUD	B		4	68,7 x 75,5	1119	2	9,5:1	40	55	22
GUE	B		4	68,7 x 75,5	1119	2	9,5:1	40	55	22
H9FA	D	(LA)	4	89,9 x 94,6	2402	4	18:1	101	137	107
H9FB	D	(LA)	4	89,9 x 94,6	2402	4	18:1	103	140	107
HCPA	D	(LA)	4	82,5 x 82	1753	4	18,5:1	66	90	113
HHJA	D	(LA)	4	75 x 88,3	1560	4	18:1	66	90	33, 52



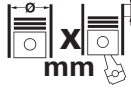

F



			Cyl	 mm	cm ³		Comp. Ratio ε	kW	PS	Pos
HHJB	D	(LA)	4	75 x 88,3	1560	4	18:1	66	90	33, 52
HWDA	B	(LA)	4	79 x 81,4	1596	4	11:1	74	101	36, 44
HXDA	B		4	79 x 81,4	1596	4	11:1	85	115	37, 44
J3E	B		4	80,985 x 63	1298	2	9,2:1	49	66	25
J4B	B		4	74 x 75,5	1299	2	8,8:1	44-46	60-63	10
J4C	B		4	74 x 75,5	1299	2	9,5	44	60	26
J4D	B		4	74 x 75,5	1299	2	9,5:1	44	60	64
J4J	B		4	74 x 75,5	1299	2	9,5:1	44	60	26
J4K	B		4	74 x 75,5	1299	2	9,5:1	44	60	64
J4L	B		4	74 x 75,5	1299	2	9,5:1	44	60	26
J4M	B		4	74 x 75,5	1299	2	9,5:1	44	60	64
J4N	B		4	74 x 75,5	1299	2	9,5:1	44	60	64
J4P	B		4	74 x 75,5	1299	2	9,5:1	44	60	64
J4Q	B		4	74 x 75,5	1299	2	9,5:1	44	60	26
J4R	B		4	74 x 75,5	1299	2	9,5:1	44	60	26
J4S	B		4	74 x 75,5	1299	2	9,5:1	44	60	64
J4T	B		4	74 x 75,5	1299	2	9,5:1	44	60	26
J6A	B		4	74 x 75,5	1299	2	8,8:1	44-46	60-63	74
JBA	B		4	74 x 75,5	1299	2	9,3:1	44-46	60-63	9
JBB	B		4	74 x 75,5	1299	2	9,3:1	44-46	60-63	9, 73
JCC	B		4	79 x 66	1294	2	8/8,2:1	43	58	97
JJA	B		4	74 x 75,5	1299	2	9,5:1	37	50	26
JJB	B		4	74 x 75,5	1299	2	9,5:1	37	50	64
JJC	B		4	74 x 75,5	1299	2	9,5:1	37	50	26
JJD	B		4	74 x 75,5	1299	2	9,5:1	36	49	64
JJE	B		4	74 x 75,5	1299	2	9,5:1	36	49	26
JJF	B		4	74 x 75,5	1299	2	9,5:1	36	49	64
JJG	B		4	74 x 75,5	1299	2	9,5:1	36	49	64
JJH	B		4	74 x 75,5	1299	2	9,5:1	36	49	64
JJJ	B		4	74 x 75,5	1299	2	9,5:1	37	50	26
JJK	B		4	74 x 75,5	1299	2	9,5:1	37	50	26
JJL	B		4	74 x 75,5	1299	2	9,5:1	36	49	64
JJM	B		4	74 x 75,5	1299	2	9,5:1	37	50	26
JLA	B		4	74 x 75,5	1299	2	9,3:1	44	60	9, 73
JLB	B		4	74 x 75,5	1299	2	9,3:1	44	60	9, 73
JPA	B		4	80 x 64,5	1297	2	9,5:1	51	69	9, 73
JPC	B		4	80 x 64,5	1297	2	9,5:1	51	69	25
JXFA	D	(LA)	4	89,9 x 94,6	2402	4	18:1	85	115	107
KKDA	D	(LA)	4	82,5 x 82	1753	2	18,5:1	85	115	40, 46
L1E	B		4	76 x 88	1597	4	10,3:1	65-66	88-90	16, 79
L1F	B		4	76 x 88	1597	4	10,3:1	66	90	66
L1J	B		4	76 x 88	1597	4	10,3:1	65	88	66
L1L	B		4	76 x 88	1597	4	10,3:1	70	95	66
L1N	B		4	76 x 88	1597	4	10,3:1	65-70	88-95	66
L1Q	B		4	76 x 88	1597	4	10,3:1	65-70	88-95	66
L1T	B		4	76 x 88	1597	4	11:1	76	103	31
L1V	B		4	76 x 88	1597	4	11:1	76	103	31
L3E	B		4	80,985 x 77,6	1599	2	9:1	62	84	30
L4B	B		4	80 x 79,5	1598	2	8,5:1	66	90	14, 78
LAC	B		4	87,68 x 66	1593	2	8/8,2:1	50-53	68-72	103
LAD	B		4	87,68 x 66	1593	2	8,2:1	50-52	68-70	98
LAT	B		4	87,68 x 66	1593	2	8:1	46	63	103
LCBB	B		6	82,4 x 79,5	2544	4	9,7:1	125	170	7
LCBC	B		6	82,4 x 79,5	2544	4	9,7:1	125	170	7
LCBE	B		6	82,4 x 79,5	2544	4	9,7:1	125	170	7
LCJ	B		4	87,68 x 66	1593	2	8,2:1	54	73	98
LCN	B		4	87,68 x 66	1593	2	9,2:1	54	73	2
LCS	B		4	81,3 x 77	1598	2	9,5:1	55	75	89
LJB	B		4	80 x 79,5	1599	2	9,75:1	75	102	14, 78
LJF	B		4	80 x 79,5	1599	2	9,75:1	77	105	14, 78
LNB	B	(LA)	4	80 x 79,5	1597	2	8,2:1	97	132	15
LP1	B		4	80 x 79,5	1599	2	9,5:1	58	79	13, 77
LPA	B		4	80 x 79,5	1599	2	9,5:1	58	79	13, 77
LR2	B		4	80 x 79,5	1599	2	9,5:1	77	105	14
LRB	B		4	80 x 79,5	1599	2	9,5:1	77	105	14, 78
LSD	B		4	81,3 x 77	1598	2	9,5:1	51-55	69-75	89
LSE	B		4	81,3 x 77	1598	2	9,5:1	55	75	89
LSF	B		4	81,3 x 77	1598	2	9,5:1	53	72	89
LTA	D	(AN)	4	80 x 80	1608	2	21,5:1	40	54	17, 80

F



			Cyl	 X mm	cm ³		Comp. Ratio ε	kW	PS	Pos
LTB	D	(AN)	4	80 x 80	1608	2	21,5:1	40	54	32
LTC	D	(AN)	4	80 x 80	1608	2	21,5:1	40	54	17, 80
LUA	B		4	80 x 79,5	1599	2	9,5:1	71	97	13
LUB	B		4	80 x 79,5	1599	2	9,5:1	71	97	30
LUD	B		4	80 x 79,5	1599	2	9,5:1	70	95	13, 30
M7JA	B		4	71,9 x 76,5	1242	4	10:1	51	70	24
M7JB	B		4	71,9 x 76,5	1242	4	10:1	51	70	24
MHA	B		4	80 x 83,5	1679	4	10,3:1	92	125	84
MHB	B		4	80 x 83,5	1679	4	10,3:1	92	125	84
N4A	B		4	90,83 x 77	1993	2	9,2:1	85	115	92
N4I	B		4	90,83 x 77	1993	2	9,2:1	85	115	92
N4JB	B		4	87,5 x 83,1	1999	4	10,8:1	107	145	21
N6T	B		4	90,83 x 77	1993	2	8,6:1	57-60	77-82	105
N7BA	D	(LA)	4	86 x 86	1998	4	18,2:1	96	131	71
N9E	B		4	86 x 86	1998	2	10,3:1	85	115	105
N9F	B		4	86 x 86	1998	2	10,3:1	85	115	58, 86
NAT	B		4	90,83 x 77	1993	2	8:1	57	77	104
NAV	B		4	90,83 x 77	1993	2	8:1	55	75	104
NAW	B		4	90,83 x 77	1993	2	8:1	56	76	105
NAX	B		4	90,83 x 77	1993	2	8:1	56	76	105
NBA	B		4	90,83 x 77	1993	2	8,5:1	66	90	105
NCA	B		4	90,83 x 77	1993	2	8,5:1	72	98	105
NEK	B		4	90,83 x 77	1993	2	9,2:1	77	105	57
NEN	B		4	90,83 x 77	1993	2	9,2:1	74	101	3
NEP	B		4	90,83 x 77	1993	2	9,2:1	74	101	57
NER	B		4	90,83 x 77	1993	2	9,2:1	74	100	85, 99
NRA	B		4	90,83 x 77	1993	2	9,2:1	85	115	58, 86
NRI	B		4	90,83 x 77	1993	2	9,2:1	85	115	86
NSD	B		4	86 x 86	1998	2	9,8:1	85	115	86
NWP	B		6	84 x 60,1	1999	2	8,75:1	66	90	57
NX	B		6	84 x 60,1	1999	2	8,75:1	48	65	3, 118
NYR	B		6	84 x 60,1	1999	2	8,75:1	66	90	99
NYT	B		6	84 x 60,1	1998	2	9:1	66	90	91
OM 352.937	D	(A)	6	97 x 128	5675	2	16:1	110	150	128
PHFA	D	(LA)	4	89,9 x 94,6	2402	4	18:1	74	100	107
PR3	B		6	93 x 68,5	2792	2	9,2:1	105-107	143-145	88
PR4	B		6	93 x 68,5	2792	2	9,2:1	105-107	143-145	88
PR5	B		6	93 x 68,5	2792	2	9,2:1	105-107	143-145	94
PR6	B		6	93 x 68,5	2792	2	9,2:1	105-107	143-145	94
PR7	B		6	93 x 68,5	2792	2	9,2:1	105-107	143-145	94
PR8	B		6	93 x 68,5	2792	2	9,2:1	105-107	143-145	94
PRC	B		6	93 x 68,5	2792	2	9,2:1	111	150	63
PRD	B		6	93 x 68,5	2792	2	9,2:1	108	147	63
PRE	B		6	93 x 68,5	2792	2	9,2:1	110	150	63, 88
PRG	B		6	93 x 68,5	2792	2	9,2:1	110	150	94
PRI	B		6	93 x 68,5	2792	2	9,2:1	109-111	148-151	94
PRT	B		6	93 x 68,5	2792	2	9,2:1	110	150	94
PYA	B		6	93 x 68,5	2792	2	9,2:1	99	135	62
PYU	B		6	93 x 68,5	2792	2	9,2:1	97	132	62
QQDA	B		4	83 x 83,1	1798	4	10,8:1	92	125	45
QQDB	B		4	83 x 83,1	1798	4	10,8:1	92	125	45
REB	B		4	86,2 x 77	1796	2	9,5:1	66	90	90
RED	B		4	86,2 x 77	1796	2	9,5:1	66	90	90
REF	B		4	86,2 x 77	1796	2	9,5:1	59	80	90
RKB	B		4	80,6 x 88	1796	4	10:1	85	115	67
RKF	B		4	80,6 x 88	1796	4	10:1	85	115	67
RKH	B		4	80,6 x 88	1796	4	10:1	85	115	67
RKJ	B		4	80,6 x 88	1796	4	10:1	85	115	67
RKK	B		4	80,6 x 88	1796	4	10:1	82-85	112-115	67
RRN	B		6	93 x 68,5	2792	2	9,2:1	118	160	5
RTA	D	(AN)	4	82,5 x 82	1753	2	21,5:1	44	60	18, 81
RTB	D	(AN)	4	82,5 x 82	1753	2	21,5:1	44	60	18, 81
RTC	D	(AN)	4	82,5 x 82	1753	2	21,5:1	44	60	34
RTD	D	(AN)	4	82,5 x 82	1753	2	21,5:1	44	60	34
RTE	D	(AN)	4	82,5 x 82	1753	2	21,5:1	44	60	18, 81
RTF	D	(AN)	4	82,5 x 82	1753	2	21,5:1	44	60	18, 81
RTH	D	(AN)	4	82,5 x 82	1753	2	21,5:1	44	60	18, 81
RTN	D	(A)	4	82,5 x 82	1753	2	19,4:1	55	75	20
RTP	D	(A)	4	82,5 x 82	1753	2	19,4:1	55	75	20

F



			Cyl	mm	cm ³		Comp. Ratio ε	kW	PS	Pos
RTQ	D	(A)	4	82,5 x 82	1753	2	19,4:1	55	75	20
SEA	B		6	82,4 x 79,5	2544	4	9,7:1	125	170	72
SFB	D	(LA)	4	94 x 90	2498	2	21:1	68	92	61, 87
SGA	B		6	81,6 x 79,5	2495	4	9,7:1	151	205	7, 72
TD27T	D	(A)	4	96 x 92	2664	2	21,9:1	74	101	65
TKA	B		4	74 x 55,7	957	2	8,3:1	29	40	19
TKB	B		4	74 x 55,7	957	2	8,5:1	33	45	19
TKW	B		4	74 x 55,7	957	2	8,3:1	29	40	19
TLA	B		4	74 x 55,7	957	2	9:1	33	45	19
TLB	B		4	68,7 x 67,5	1001	2	9,5:1	33	45	19
XD 3P	D	(AN)	4	94 x 90	2498	2	23:1	51-58	70-79	60
XD 3T	D	(LA)	4	94 x 90	2498	2	21:1	66-70	90-95	87
YYE	B		6	90 x 60,1	2294	2	8,75:1	79	107	4
YYH	B		6	90 x 60,1	2294	2	8,75:1	79	107	59
YYT	B		6	90 x 60,1	2294	2	9:1	84	114	93

F

**FORD****Bronco 2.3 TD****1**

1985 →

4D55T

**50 005 123****NEW****Capri 1.6****2**

01.1978→04.1987

LCN

Reference

5 004 995 5 006 043 5 009 286 6 065 711
 A 790 X 8591 ALA A 790 X 8591 ANA A 790 X 8591 RLA A 840 X 8591 BAA
 EPW 50 EPW 68 EPW 69

automatischer Lüfter/automatic fan/ventilateur automatique/ventilador automático/
 автоматический вентилятор

**50 005 063****F**

01.1978→04.1987

LCN

Reference

5 006 046 5 009 287 5 010 878 5 011 863
 A 820 X 8591 BA A 830 X 8591 KA EPW 51

automatischer Lüfter/automatic fan/ventilateur automatique/ventilador automático/
 автоматический вентилятор
 Servolenkung/power steering/direction assistée/dirección asistada/Рулевое
 управление с усилителем

**50 005 721****Capri 2.0****3**

01.1978→04.1987

NEN

Reference

5 004 995 5 006 043 5 009 286 6 065 711
 A 790 X 8591 ALA A 790 X 8591 ANA A 790 X 8591 RLA A 840 X 8591 BAA
 EPW 50 EPW 68 EPW 69

automatischer Lüfter/automatic fan/ventilateur automatique/ventilador automático/
 автоматический вентилятор

**50 005 063**

01.1978→04.1987

NEN

Reference

5 006 046 5 009 287 5 010 878 5 011 863
 A 820 X 8591 BA A 830 X 8591 KA EPW 51

automatischer Lüfter/automatic fan/ventilateur automatique/ventilador automático/
 автоматический вентилятор
 Servolenkung/power steering/direction assistée/dirección asistada/Рулевое
 управление с усилителем

**50 005 721**

04.1976→12.1977

NX

Reference

1 527 289 5 005 194 5 007 749 5 007 852
 6 043 065 6 049 790 A 790 X 8591 HCA A 810 X 8591 FA
 A 810 X 8591 HA EPW 56 EPW 58 EPW 981

automatischer Lüfter/automatic fan/ventilateur automatique/ventilador automático/
 автоматический вентилятор

**50 005 062****Capri 2.3****4**

01.1974→05.1979

YYE

Reference

1 527 289 5 005 194 5 007 749 5 007 852
 6 043 065 6 049 790 A 790 X 8591 HCA A 810 X 8591 FA
 A 810 X 8591 HA EPW 56 EPW 58 EPW 981

automatischer Lüfter/automatic fan/ventilateur automatique/ventilador automático/
 автоматический вентилятор

**50 005 062****Capri 2.8i****5**

01.1981→04.1987

RRN

Reference

1 527 289 5 005 194 5 007 749 5 007 852
 6 043 065 6 049 790 A 790 X 8591 HCA A 810 X 8591 FA
 A 810 X 8591 HA EPW 56 EPW 58 EPW 981

automatischer Lüfter/automatic fan/ventilateur automatique/ventilador automático/
 автоматический вентилятор

**50 005 062**

**FORD****Cougar 2.0i 16V****6**

06.1998→12.2000

EDBA, EDBB, EDBC, EDBD

Reference

1053879	1094596	1114354	1130582
1227902	1317038	1320876	19BBX8591FA
978M8501NH	988M8501TJ	988X8591F1D	988X8591FC

**50 005 215****NEW****Cougar 2.5i 24V****7**

08.1998→04.2002

LCBB, LCBC, LCBE, SGA

Reference

3 006 897	3 667 653	3 715 703	3 800 766
4 096 620	4 356 532	4 448 290	7 269 023

**50 005 774****F****Escort 1.1****8**

01.1986→07.1988

GSG

Reference

5 020 437	5 025 908	5 026 783	88 BX 8591 AA
92 BX 8591 BA	EPW 71		

**50 005 068**

08.1980→12.1985

GLB, GPA, GSE

Reference

5 005 197	5 024 603	6 039 328	6 050 034
6 050 907	A 790 X 8591 HFA	D 8 RZ 8501 A	EPW 985

**50 005 064****Escort 1.3****9**

01.1986→07.1990

JBA, JBB, JLA, JLB

Reference

5 020 437	5 025 908	5 026 783	88 BX 8591 AA
92 BX 8591 BA	EPW 71		



08.1988→

**50 005 068**

01.1986→07.1990

JBA, JBB, JLA, JLB

Reference

5 005 197	5 024 603	6 039 328	6 050 034
6 050 907	A 790 X 8591 HFA	D 8 RZ 8501 A	EPW 985



JBA, JLA, JLB: →07.1988

**50 005 064**

09.1980→12.1985

JPA

Reference

5 008 470	5 018 437	A 810 X 8591 SA	EPW 33
-----------	-----------	-----------------	--------

**50 005 065****Escort 1.3i****10**

08.1990→09.2001

J4B

Reference

5 020 437	5 025 908	5 026 783	88 BX 8591 AA
92 BX 8591 BA	EPW 71		

**50 005 068****Escort 1.4****11**

01.1986→07.1990

FUA, FUAA, FUC

Reference

5 013 320	5 020 651	A 840 X 8591 BCA	EPW 70
-----------	-----------	------------------	--------

**50 005 530**



Escort 1.4i

12

01.1987→09.2001	F4B, F6B, F6D, F6F, F6G, FUH							
Reference	5 013 320	5 020 651	A 840 X 8591 BCA	EPW 70				50 005 530

Escort 1.6

13

01.1986→07.1990	LUD							
Reference	5 013 320	5 020 651	A 840 X 8591 BCA	EPW 70				50 005 530
	01.1986→							
09.1980→07.1990	LP1, LPA, LUA, LUD							
Reference	5 008 470	5 018 437	A 810 X 8591 SA	EPW 33				50 005 065
	LUD: →12.1985							

Escort 1.6i

14

08.1985→09.1992	L4B, LJB, LJF, LR2, LRB							
Reference	5 013 320	5 020 651	A 840 X 8591 BCA	EPW 70				50 005 530

Escort 1.6i Turbo

15

01.1986→07.1990	LNB							
Reference	5 013 320	5 020 651	A 840 X 8591 BCA	EPW 70				50 005 530

Escort 1.6i 16V

16

09.1992→09.2001	L1E							
Reference	1053879	1094596	1114354	1130582				50 005 215
	1227902	1317038	1320876	19BBX8591FA				NEW
	978M8501NH	988M8501TJ	988X8591F1D	988X8591FC				

Escort 1.6 D

17

04.1984→12.1988	LTA, LTC							
Reference	5 011 013	5 012 322	5 023 817	A 830 X 8591 TA				50 005 720
	A 840 X 8591 JA	EPW 61	EPW 65					

Escort 1.8 D

18

01.1989→09.2001	RTA, RTB, RTE, RTF, RTH							
Reference	1 020 988	1 023 645	5 020 242	88 FX 8591 AA				50 005 725
	88 FX 8591 AB	96 FX 8591 AA	EPW 40	EPW 82				

Fiesta 1.0

19

03.1989→12.1996	TLB							
Reference	5 020 437	5 025 908	5 026 783	88 BX 8591 AA				50 005 068
	92 BX 8591 BA	EPW 71						
	→04.1991							

**FORD**

05.1976→02.1989 Reference	TKA, TKB, TKW, TLA 5 005 197 6 050 907	5 024 603 A 790 X 8591 HFA	6 039 328 D 8 RZ 8501 A	6 050 034 EPW 985			50 005 064
Fiesta 1.8 TDI							20
02.2000→12.2002 Reference	RTN, RTP, RTQ 1079085 XS4J8591DB	1104115	1131878	XS4J8591AC			50 005 216 <small>NEW</small>
Fiesta 2.0i 16V							21
11.2004→ Reference	N4JB 1 119 276 1S7 G8501 AL	1 142 005 1S7 G8501 AN	1 142 427	1S7 G8501 AK			50 005 751
Fiesta 1.1							22
03.1989→12.1996 Reference	GUD, GUE 5 020 437 92 BX 8591 BA →04.1991	5 025 908 EPW 71	5 026 783	88 BX 8591 AA			50 005 068
05.1976→02.1989 Reference	GLA, GLC, GLW, GSF 5 005 197 6 050 907	5 024 603 A 790 X 8591 HFA	6 039 328 D 8 RZ 8501 A	6 050 034 EPW 985			50 005 064
Fiesta 1.1i							23
03.1989→12.1996 Reference	G6A 5 020 437 92 BX 8591 BA →04.1991	5 025 908 EPW 71	5 026 783	88 BX 8591 AA			50 005 068
Fiesta 1.25i 16V							24
11.1995→ Reference	DHA, DHB, DHC, DHD, DHE, DHF, DHG, FUJA, FUJB, M7JA, M7JB 1007714 1350461	1020538 1376162	1132607 96MX8591AA	1326374			50 005 119 <small>NEW</small>
Fiesta 1.3							25
09.1983→01.1987 Reference	JPC 5 013 320 02.1986→	5 020 651	A 840 X 8591 BCA	EPW 70			50 005 530
08.1977→08.1983 Reference	J3E 5 005 197 6 050 907	5 024 603 A 790 X 8591 HFA	6 039 328 D 8 RZ 8501 A	6 050 034 EPW 985			50 005 064

F



09.1983→01.1987 Reference 	JPC 5 008 470 →01.1986	5 018 437	A 810 X 8591 SA	EPW 33			50 005 065
Fiesta 1.3i							26
11.2001→ Reference	A9JA, A9JB, BAJA 1 089 795	1 229 571	256 G 8591 AA	X56 E 8501 AD			50 005 787
09.1995→12.2002 Reference	J4C, J4J, J4L, J4Q, J4R, J4T, JJA, JJC, JJE, JJJ, JJK, JJM 1020567	1109341	96BX8591A2B	96BX8591AA			50 005 120 NEW
Fiesta 1.4							27
09.1983→12.1996 Reference	F6C, FUB, FUBA, FUD, FUF 5 013 320	5 020 651	A 840 X 8591 BCA	EPW 70			50 005 530
Fiesta 1.4i							28
10.1986→12.1996 Reference	F6A, F6E 5 013 320	5 020 651	A 840 X 8591 BCA	EPW 70			50 005 530
Fiesta 1.4i 16V							29
01.1995→ Reference	FHA, FHE, FXJA, FXJB 1007714 1350461	1020538 1376162	1132607 96MX8591AA	1326374			50 005 119 NEW
Fiesta 1.6							30
03.1984→02.1989 Reference 	LUB, LUD 5 013 320 01.1986→	5 020 651	A 840 X 8591 BCA	EPW 70			50 005 530
08.1981→08.1983 Reference	L3E 5 005 197 6 050 907	5 024 603 A 790 X 8591 HFA	6 039 328 D 8 RZ 8501 A	6 050 034 EPW 985			50 005 064
03.1984→02.1989 Reference 	LUB, LUD 5 008 470 →12.1985	5 018 437	A 810 X 8591 SA	EPW 33			50 005 065
Fiesta 1.6i 16V							31
09.1999→ Reference	FYDA, FYJA, L1T, L1V 1007714 1350461	1020538 1376162	1132607 96MX8591AA	1326374			50 005 119 NEW

F

**FORD****Fiesta 1.6 D****32**

04.1984→02.1989

LTB

Reference

5 011 013
A 840 X 8591 JA5 012 322
EPW 615 023 817
EPW 65

A 830 X 8591 TA

**50 005 720****Fiesta 1.6 TDCi 16V****33**

11.2004→

HHJA, HHJB

Reference

1 313 842

1 351 130

1 364 681

3 M5 Q 8591 BB

**50 005 762****Fiesta 1.8 D****34**

03.1989→12.1996

RTC, RTD

Reference

1 020 988
88 FX 8591 AB1 023 645
96 FX 8591 AA5 020 242
EPW 4088 FX 8591 AA
EPW 82**50 005 725****Focus 1.4i 16V****35**

08.1998→05.2005

FXDA, FXDB, FXDC, FXDD

Reference

1007714
13504611020538
13761621132607
96MX8591AA

1326374

50 005 119
NEW**Focus 1.6i 16V****36**

08.1998→

FYDA, FYDB, FYDC, FYDD, HWDA

Reference

1007714
13504611020538
13761621132607
96MX8591AA

1326374

50 005 119
NEW**Focus 1.6 TI-VCT 16V****37**

11.2004→

HXDA

Reference

1007714
13504611020538
13761621132607
96MX8591AA

1326374

50 005 119
NEW**Focus 1.8i 16V****38**

08.1998→05.2005

EYDB, EYDC, EYDD, EYDE, EYDF

Reference

1053879
1227902
978M8501NH1094596
1317038
988M8501TJ1114354
1320876
988X8591F1D1130582
19BBX8591FA
988X8591FC**50 005 215**
NEW**Focus 1.8 DI****39**

01.1999→05.2005

BHDA, BHDB, C9DA, C9DB, C9DC

Reference

1079085
XS4J8591DB

1104115

1131878

XS4J8591AC

**50 005 216**
NEW**Focus 1.8 TDCi****40**

05.2001→

F9DA, F9DB, KKDA

Reference

1079085
XS4J8591DB

1104115

1131878

XS4J8591AC

**50 005 216**
NEW**F**



Focus 2.0i 16V

41

08.1998→05.2005	EDDB, EDDC, EDDD, EDDF						50 005 215 <small>NEW</small>
Reference	1053879 1227902 978M8501NH	1094596 1317038 988M8501TJ	1114354 1320876 988X8591F1D	1130582 19BBX8591FA 988X8591FC			
11.2004→	AODA, AODB						50 005 751
Reference	1 119 276 1S7 G8501 AL	1 142 005 1S7 G8501 AN	1 142 427	1S7 G8501 AK			

F

Focus ST 170 2.0i 16V

42

02.2002→05.2005	ALDA						50 005 215 <small>NEW</small>
Reference	1053879 1227902 978M8501NH	1094596 1317038 988M8501TJ	1114354 1320876 988X8591F1D	1130582 19BBX8591FA 988X8591FC			

Focus 2.0 TDCi 16V

43

11.2004→	G6DA						50 005 779
Reference	1 232 499						

Focus C-Max 1.6i 16V

44

03.2003→	FYDA, HWDA, HXDA						50 005 119 <small>NEW</small>
Reference	1007714 1350461	1020538 1376162	1132607 96MX8591AA	1326374			

Focus C-Max 1.8i 16V

45

06.2003→	CHBB, CSDA, CSDB, QQDA, QQDB						50 005 751
Reference	1 119 276 1S7 G8501 AL	1 142 005 1S7 G8501 AN	1 142 427	1S7 G8501 AK			

Focus C-Max 1.8 TDCi

46

04.2005→	KKDA						50 005 216 <small>NEW</small>
Reference	1079085 XS4J8591DB	1104115	1131878	XS4J8591AC			

Focus C-Max 2.0i 16V

47

04.2004→	CJBB						50 005 751
Reference	1 119 276 1S7 G8501 AL	1 142 005 1S7 G8501 AN	1 142 427	1S7 G8501 AK			

Focus C-Max 2.0 TDCi 16V

48

06.2003→	G6DA						50 005 779
Reference	1 232 499						

**FORD****Fusion 1.25i 16V****49**

03.2005→

FUJA, FUJB

Reference

1007714
13504611020538
13761621132607
96MX8591AA

1326374

50 005 119
NEW**Fusion 1.4i 16V****50**

10.2002→

FXJA, FXJB

Reference

1007714
13504611020538
13761621132607
96MX8591AA

1326374

50 005 119
NEW**Fusion 1.6i 16V****51**

10.2002→

FYJA

Reference

1007714
13504611020538
13761621132607
96MX8591AA

1326374

50 005 119
NEW**Fusion 1.6 TDCi 16V****52**

11.2004→

HHJA, HHJB

Reference

1 313 842

1 351 130

1 364 681

3 M5 Q 8591 BB

**50 005 762****Galaxy 1.9 TDI****53**

02.1995→03.2000

1Z, AFN, AHU

Reference

1 031 369

1 031 879

mit Gegengehäuse/with backhousing/avec demi-corps/con remate/c задним корпусом

**50 005 151**

02.1995→03.2000

1Z, AFN, AHU

Reference

95 VW 8503 AA

ohne Gegengehäuse/without backhousing/sans demi-corps/sin remate/без заднего корпуса

**50 005 148**

01.2005→

BTB

**50 005 556**

04.2000→

ANU

**50 005 783**

02.1995→03.2000

1Z, AFN, AHU

Reference

1669841

95VW-6600-BA

**50 005 806**

04.2000→

ANU, AUY

Reference

1100687

1124931

XM21-6600-AA

XM21-6600-BA

**50 005 819**

04.2000→

ASZ, AUY

Reference

1 100 635

**50 005 554****F**

**FORD****Galaxy 2.0 TDCi 16V****54**

05.2006→ Reference	G6DA 1 232 499				50 005 779
-----------------------	-------------------	--	---	--	------------

Galaxy VR6 2.8i**55**

02.1995→03.2000 Reference	AAA, AMY 1 001 889 1 059 843 1 213 357				50 005 165
------------------------------	---	--	---	--	------------

F**Galaxy 2.8i VR6 24V****56**

04.2000→02.2006 Reference	AYL 1 001 889 1 059 843 1 213 357				50 005 165
------------------------------	--	--	---	--	------------

Granada 2.0**57**

08.1981→08.1985 Reference	NEK, NEP 5 004 995 5 006 043 5 009 286 6 065 711 A 790 X 8591 ALA A 790 X 8591 ANA A 790 X 8591 RLA A 840 X 8591 BAA EPW 50 EPW 68 EPW 69 automatischer Lüfter/automatic fan/ventilateur automatique/ventilador automático/ автоматический вентилятор				50 005 063
------------------------------	--	--	---	--	------------

08.1981→08.1985 Reference	NEK, NEP 5 006 046 5 009 287 5 010 878 5 011 863 A 820 X 8591 BA A 830 X 8591 KA EPW 51 automatischer Lüfter/automatic fan/ventilateur automatique/ventilador automático/ автоматический вентилятор Servolenkung/power steering/direction assistée/dirección asistada/Рулевое управление с усилителем				50 005 721
------------------------------	--	--	---	--	------------

01.1972→08.1985 Reference	NWP 1 527 289 5 005 194 5 007 749 5 007 852 6 043 065 6 049 790 A 790 X 8591 HCA A 810 X 8591 FA A 810 X 8591 HA EPW 56 EPW 58 EPW 981 automatischer Lüfter/automatic fan/ventilateur automatique/ventilador automático/ автоматический вентилятор →01.1979				50 005 062
------------------------------	--	--	---	--	------------

Granada 2.0i**58**

04.1985→12.1994 Reference	N9F, NRA 1438157 71HM-6600-AA			50 005 821	
------------------------------	---------------------------------------	--	---	------------	--

Granada 2.3**59**

01.1976→06.1979 Reference	YYH 1 527 289 5 005 194 5 007 749 5 007 852 6 043 065 6 049 790 A 790 X 8591 HCA A 810 X 8591 FA A 810 X 8591 HA EPW 56 EPW 58 EPW 981 automatischer Lüfter/automatic fan/ventilateur automatique/ventilador automático/ автоматический вентилятор				50 005 062
------------------------------	--	--	---	--	------------

**FORD****Granada 2.5 D****60**

08.1982→08.1985

XD 3P

Reference

5 009 823
EPW 45

5 024 638

83 EF 8501 AA

89 EX 8591 AA



50 005 314

Granada 2.5 TD**61**

06.1988→12.1994

SFB

Reference

5 019 394

88 GX 8591 AA



50 005 304

Granada 2.8**62**

08.1977→08.1985

PYA, PYU

Reference

1 527 289

5 005 194

5 007 749

5 007 852

6 043 065

6 049 790

A 790 X 8591 HCA

A 810 X 8591 FA

A 810 X 8591 HA

EPW 56

EPW 58

EPW 981

automatischer Lüfter/automatic fan/ventilateur automatique/ventilador automático/
автоматический вентилятор
→01.1979

50 005 062

Granada 2.8i**63**

04.1985→08.1987

PRE

Reference

5 011 846
EPW 64

5 026 076

92 TX 8591 DA

A 830 X 8591 CTA



50 005 067

08.1977→08.1985

PRC, PRD

Reference

1 527 289

5 005 194

5 007 749

5 007 852

6 043 065

6 049 790

A 790 X 8591 HCA

A 810 X 8591 FA

A 810 X 8591 HA

EPW 56

EPW 58

EPW 981

automatischer Lüfter/automatic fan/ventilateur automatique/ventilador automático/
автоматический вентилятор

50 005 062

KA 1.3i**64**

10.2002→

A9JA, A9JB

Reference

1 089 795

1 229 571

256 G 8591 AA

X56 E 8501 AD



50 005 787

09.1996→

BAA, J4D, J4K, J4M, J4N, J4P, J4S, JJB, JJD, JJF, JJG, JJH, JJJ

Reference

1020567

1109341

96BX8591A2B

96BX8591AA



50 005 120

NEW

Maverick 2.7 TD**65**

06.1993→08.1996

TD27T



50 005 174

NEW

Mondeo 1.6i 16V**66**

01.1993→09.2000

L1F, L1J, L1L, L1N, L1Q

Reference

1053879

1094596

1114354

1130582

1227902

1317038

1320876

19BBX8591FA

978M8501NH

988M8501TJ

988X8591F1D

988X8591FC



50 005 215

NEW

F



Mondeo 1.8i 16V

67

01.1993→09.2000	RKB, RKF, RKH, RKJ, RKK						50 005 215 <small>NEW</small>
Reference	1053879 1227902 978M8501NH	1094596 1317038 988M8501TJ	1114354 1320876 988X8591F1D	1130582 19BBX8591FA 988X8591FC			

10.2000→	CGBA, CGBB, CHBA, CHBB						50 005 751
Reference	1 119 276 1S7 G8501 AL	1 142 005 1S7 G8501 AN	1 142 427	1S7 G8501 AK			

Mondeo 1.8 SCi 16V

68

06.2003→	CFBA						50 005 751
Reference	1 119 276 1S7 G8501 AL	1 142 005 1S7 G8501 AN	1 142 427	1S7 G8501 AK			

Mondeo 2.0i 16V

69

10.2000→	CJBA, CJBB						50 005 751
Reference	1 119 276 1S7 G8501 AL	1 142 005 1S7 G8501 AN	1 142 427	1S7 G8501 AK			

Mondeo 2.0 DI 16V

70

10.2000→	D5BA						50 005 752
Reference	1116996	1143851	XS7Q8K500AE				

Mondeo 2.0 TDCI 16V

71

10.2000→	D6BA, N7BA						50 005 752
Reference	1116996	1143851	XS7Q8K500AE				

Mondeo 2.5i 24V

72

08.1994→09.2000	SEA, SGA						50 005 774
Reference	3 006 897 4 096 620	3 667 653 4 356 532	3 715 703 4 448 290	3 800 766 7 269 023			













Orion 1.3

73

10.1987→07.1990	JLB						50 005 068
Reference	5 020 437 92 BX 8591 BA 08.1988→	5 025 908 EPW 71	5 026 783	88 BX 8591 AA			

04.1986→07.1990	JBB, JLA, JLB						50 005 064
Reference	5 005 197 6 050 907 JLA, JLB: →07.1988	5 024 603 A 790 X 8591 HFA	6 039 328 D 8 RZ 8501 A	6 050 034 EPW 985			

**FORD**

							
09.1983→03.1986 Reference	JPA 5 008 470	5 018 437	A 810 X 8591 SA	EPW 33			50 005 065
Orion 1.3i							74
05.1991→12.1993 Reference	J6A 5 020 437 92 BX 8591 BA	5 025 908 EPW 71	5 026 783	88 BX 8591 AA			50 005 068
Orion 1.4							75
03.1986→07.1990 Reference	FUA, FUC 5 013 320	5 020 651	A 840 X 8591 BCA	EPW 70			50 005 530
Orion 1.4i							76
10.1987→12.1993 Reference	F6B, F6D, F6F, F6G, FUH 5 013 320	5 020 651	A 840 X 8591 BCA	EPW 70			50 005 530
Orion 1.6							77
09.1983→03.1986 Reference	LP1, LPA 5 008 470	5 018 437	A 810 X 8591 SA	EPW 33			50 005 065
Orion 1.6i							78
04.1986→09.1992 Reference	L4B, LJB, LJF, LRB 5 013 320	5 020 651	A 840 X 8591 BCA	EPW 70			50 005 530
Orion 1.6i 16V							79
09.1992→12.1993 Reference	L1E 1053879 1227902 978M8501NH	1094596 1317038 988M8501TJ	1114354 1320876 988X8591F1D	1130582 19BBX8591FA 988X8591FC			50 005 215 <small>NEW</small>
Orion 1.6 D							80
04.1984→01.1989 Reference	LTA, LTC 5 011 013 A 840 X 8591 JA	5 012 322 EPW 61	5 023 817 EPW 65	A 830 X 8591 TA			50 005 720
Orion 1.8 D							81
01.1989→12.1993 Reference	RTA, RTB, RTE, RTF, RTH 1 020 988 88 FX 8591 AB	1 023 645 96 FX 8591 AA	5 020 242 EPW 40	88 FX 8591 AA EPW 82			50 005 725
Puma 1.4i 16V							82
01.1998→11.2000 Reference	FHD, FHF 1007714 1350461	1020538 1376162	1132607 96MX8591AA	1326374			50 005 119 <small>NEW</small>

F

**FORD****Sierra 1.8****90**

10.1984→05.1988

REB, RED, REF

Reference

5 004 995 5 006 043 5 009 286 6 065 711
 A 790 X 8591 ALA A 790 X 8591 ANA A 790 X 8591 RLA A 840 X 8591 BAA
 EPW 50 EPW 68 EPW 69



automatischer Lüfter/automatic fan/ventilateur automatique/ventilador automático/
 автоматический вентилятор

**50 005 063**

10.1984→05.1988

REB, RED, REF

Reference

5 006 046 5 009 287 5 010 878 5 011 863
 A 820 X 8591 BA A 830 X 8591 KA EPW 51



automatischer Lüfter/automatic fan/ventilateur automatique/ventilador automático/
 автоматический вентилятор
 Servolenkung/power steering/direction assistée/dirección asistada/Рулевое
 управление с усилителем

**50 005 721****Sierra 2.0****91**

08.1982→10.1984

NYT

Reference

5 011 846 5 026 076 92 TX 8591 DA A 830 X 8591 CTA
 EPW 64
 10.1984→

**50 005 067****Sierra 2.0i****92**

01.1987→02.1993

N4A, N4I

Reference

5 004 995 5 006 043 5 009 286 6 065 711
 A 790 X 8591 ALA A 790 X 8591 ANA A 790 X 8591 RLA A 840 X 8591 BAA
 EPW 50 EPW 68 EPW 69



automatischer Lüfter/automatic fan/ventilateur automatique/ventilador automático/
 автоматический вентилятор

**50 005 063**

01.1987→02.1993

N4A, N4I

Reference

5 006 046 5 009 287 5 010 878 5 011 863
 A 820 X 8591 BA A 830 X 8591 KA EPW 51



automatischer Lüfter/automatic fan/ventilateur automatique/ventilador automático/
 автоматический вентилятор
 Servolenkung/power steering/direction assistée/dirección asistada/Рулевое
 управление с усилителем

**50 005 721****Sierra 2.3****93**

08.1982→12.1986

YYT

Reference

5 011 846 5 026 076 92 TX 8591 DA A 830 X 8591 CTA
 EPW 64
 10.1984→

**50 005 067**

08.1982→12.1986

YYT

Reference

1438157 71HM-6600-AA

**50 005 821****Sierra 2.8i****94**

08.1982→12.1988

PRG, PRT

Reference

5 011 846 5 026 076 92 TX 8591 DA A 830 X 8591 CTA
 EPW 64

**50 005 067**

08.1982→12.1988

PR5, PR6, PR7, PR8, PRI

Reference

1 527 289 5 005 194 5 007 749 5 007 852
 6 043 065 6 049 790 A 790 X 8591 HCA A 810 X 8591 FA
 A 810 X 8591 HA EPW 56 EPW 58 EPW 981



automatischer Lüfter/automatic fan/ventilateur automatique/ventilador automático/
 автоматический вентилятор

**50 005 062**

**FORD****S-Max 2.0i 16V****95**

03.2006→	CJBB							
Reference	1 119 276 1S7 G8501 AL	1 142 005 1S7 G8501 AN	1 142 427	1S7 G8501 AK				50 005 751

S-Max 2.0 TDCii 16V**96**

03.2006→	G6DA							
Reference	1 232 499							50 005 779

Taurus 1.3**97**

12.1975→08.1982	JCC							
Reference	5 004 995 A 790 X 8591 ALA EPW 50	5 006 043 A 790 X 8591 ANA EPW 68	5 009 286 A 790 X 8591 RLA EPW 69	6 065 711 A 840 X 8591 BAA				50 005 063
	automatischer Lüfter/automatic fan/ventilateur automatique/ventilador automático/ автоматический вентилятор							

12.1975→08.1982	JCC							
Reference	5 006 046 A 820 X 8591 BA	5 009 287 A 830 X 8591 KA	5 010 878 EPW 51	5 011 863				50 005 721
	automatischer Lüfter/automatic fan/ventilateur automatique/ventilador automático/ автоматический вентилятор Servolenkung/power steering/direction assistée/dirección asistada/Рулевое управление с усилителем							

Taurus 1.6**98**

10.1970→08.1982	LAD, LCJ							
Reference	5 004 995 A 790 X 8591 ALA EPW 50	5 006 043 A 790 X 8591 ANA EPW 68	5 009 286 A 790 X 8591 RLA EPW 69	6 065 711 A 840 X 8591 BAA				50 005 063
	automatischer Lüfter/automatic fan/ventilateur automatique/ventilador automático/ автоматический вентилятор 07.1979→							

10.1970→08.1982	LAD, LCJ							
Reference	5 006 046 A 820 X 8591 BA	5 009 287 A 830 X 8591 KA	5 010 878 EPW 51	5 011 863				50 005 721
	automatischer Lüfter/automatic fan/ventilateur automatique/ventilador automático/ автоматический вентилятор Servolenkung/power steering/direction assistée/dirección asistada/Рулевое управление с усилителем 07.1979→							

Taurus 2.0**99**

09.1978→08.1982	NER							
Reference	5 004 995 A 790 X 8591 ALA EPW 50	5 006 043 A 790 X 8591 ANA EPW 68	5 009 286 A 790 X 8591 RLA EPW 69	6 065 711 A 840 X 8591 BAA				50 005 063
	automatischer Lüfter/automatic fan/ventilateur automatique/ventilador automático/ автоматический вентилятор							

09.1978→08.1982	NER							
Reference	5 006 046 A 820 X 8591 BA	5 009 287 A 830 X 8591 KA	5 010 878 EPW 51	5 011 863				50 005 721
	automatischer Lüfter/automatic fan/ventilateur automatique/ventilador automático/ автоматический вентилятор Servolenkung/power steering/direction assistée/dirección asistada/Рулевое управление с усилителем							

**FORD**

12.1975→08.1982	NYR						
Reference	1 527 289 6 043 065 A 810 X 8591 HA	5 005 194 6 049 790 EPW 56	5 007 749 A 790 X 8591 HCA EPW 58	5 007 852 A 810 X 8591 FA EPW 981			50 005 062
	automatischer Lüfter/automatic fan/ventilateur automatique/ventilador automático/автоматический вентилятор						
Tourneo 2.5 D							100
08.1994→12.2000	4HA, 4HB						
Reference	5 012 773 A 840 X 8591 ATA	5 024 545 EPW 20	914 FX 8591 AA EPW 38	A 840 X 8591 AA			50 005 727
Tourneo 2.5 TDi							101
08.1994→08.2000	4GA, 4GB, 4GC						
Reference	5 012 773 A 840 X 8591 ATA	5 024 545 EPW 20	914 FX 8591 AA EPW 38	A 840 X 8591 AA			50 005 727
Tourneo Connect 1.8i 16V							102
05.2002→	EYPA						
Reference	1053879 1227902 978M8501NH	1094596 1317038 988M8501TJ	1114354 1320876 988X8591F1D	1130582 19BBX8591FA 988X8591FC			50 005 215 NEW
Transit 1.6							103
11.1985→09.1991	LAC, LAT						
Reference	1438157	71HM-6600-AA				50 005 821	
04.1978→09.1991	B, LAC, LAT						
Reference	5 004 995 A 790 X 8591 ALA EPW 50	5 006 043 A 790 X 8591 ANA EPW 68	5 009 286 A 790 X 8591 RLA EPW 69	6 065 711 A 840 X 8591 BAA			50 005 063
	automatischer Lüfter/automatic fan/ventilateur automatique/ventilador automático/автоматический вентилятор						
Transit 2.0							104
11.1985→07.1991	NAT, NAV						
Reference	1438157	71HM-6600-AA				50 005 821	
04.1978→12.1985	C (55 kW)						
Reference	5 004 995 A 790 X 8591 ALA EPW 50	5 006 043 A 790 X 8591 ANA EPW 68	5 009 286 A 790 X 8591 RLA EPW 69	6 065 711 A 840 X 8591 BAA			50 005 063
	automatischer Lüfter/automatic fan/ventilateur automatique/ventilador automático/автоматический вентилятор						
Transit 2.0i							105
01.1986→	N6T, N9E, NAW, NAX, NBA, NCA						
Reference	1438157	71HM-6600-AA				50 005 821	

F



Transit 2.4 TDDi

106

01.2000→	DOFA						
Reference	1096556 1308453	1136393 1385824	1146965 1385827	1308452			50 005 013 NEW

Transit 2.4 TDCi 16V

107

03.2004→	H9FA, H9FB, JXFA, PHFA						
Reference	1096556 1308453	1136393 1385824	1146965 1385827	1308452			50 005 013 NEW

F

Transit 2.4 DI 16V

108

01.2000→	D2FA, D4FA, F4FA						
Reference	1096556 1308453	1136393 1385824	1146965 1385827	1308452			50 005 013 NEW

Transit 2.5 D

109

11.1985→09.1991	4AB, 4BA, 4BB, 4CA (50 kW), 4CA (52 kW)						
Reference	5 012 773 A 840 X 8591 ATA	5 024 545 EPW 20	914 FX 8591 AA EPW 38	A 840 X 8591 AA			50 005 727



Transit 2.5 TD

110

08.1991→07.1994	4EA						
Reference	5 012 773 A 840 X 8591 ATA	5 024 545 EPW 20	914 FX 8591 AA EPW 38	A 840 X 8591 AA			50 005 727

Transit 2.5 DI

111

08.1991→08.2000	4BC, 4CC, 4DA, 4FA, 4FB, 4FC, 4FD, 4GA, 4GB, 4GC, 4HA, 4HB, 4HC						
Reference	6610572	924F-6600-AB				50 005 839	
08.1991→08.2000	4DA, 4GA, 4GB, 4GC, 4HA, 4HB						
Reference	5 012 773 A 840 X 8591 ATA	5 024 545 EPW 20	914 FX 8591 AA EPW 38	A 840 X 8591 AA			50 005 727

Transit Connect 1.8i 16V

112

05.2002→	EYPA						
Reference	1053879 1227902 978M8501NH	1094596 1317038 988M8501TJ	1114354 1320876 988X8591F1D	1130582 19BBX8591FA 988X8591FC			50 005 215 NEW

**FORD****Transit Connect 1.8 TDCi****113**

05.2002→	BHPA, HCPA						50 005 216 NEW
Reference	1079085 XS4J8591DB	1104115	1131878	XS4J8591AC			

Cargo 1317**114**

04.1982→	F 6 L 413 F						50 005 874
----------	-------------	--	--	--	---	--	-------------------

Cargo 1517**115**

04.1982→	F 6 L 413 F						50 005 874
----------	-------------	--	--	--	---	--	-------------------



Cargo 1617**116**

04.1982→12.1999	F 6 L 413 F						50 005 874
-----------------	-------------	--	--	--	---	--	-------------------

Cargo 2817**117**

04.1982→	F 6 L 413 F						50 005 874
----------	-------------	--	--	--	---	--	-------------------

A 0407**118**









11.1988→	4CA (52 kW)						50 005 727
Reference	5 012 773 A 840 X 8591 ATA	5 024 545 EPW 20	914 FX 8591 AA EPW 38	A 840 X 8591 AA			
01.1986→09.1992	NX						50 005 062
Reference	1 527 289 6 043 065 A 810 X 8591 HA	5 005 194 6 049 790 EPW 56	5 007 749 A 790 X 8591 HCA EPW 58	5 007 852 A 810 X 8591 FA EPW 981			
	automatischer Lüfter/automatic fan/ventilateur automatique/ventilador automático/ автоматический вентилятор						

Tractor 333**119**

1965 →	2504 E						50 005 842
Reference	D5NN-6600-D	E1NN-6600-DC					

F



Tractor 353				120
1965 → Reference	2504 E D5NN-6600-D E1NN-6600-DC		50 005 842	
Tractor 3000				121
1965 → Reference	2504 E D5NN-6600-D E1NN-6600-DC		50 005 842	
Tractor 3600				122
1965 → 1981 Reference	2504 E D5NN-6600-D E1NN-6600-DC		50 005 842	
Tractor 4610				123
1981 → Reference	BSD 333 H 81868537		50 005 227 NEW	
Tractor 6610				124
09.1981 → Reference	BSD 444 EINN6600DC		50 005 226 NEW	
09.1981 → Reference	BSD 444, BSD 444 T EINN6600CC		50 005 220 NEW	
Tractor 6710				125
09.1981 → Reference	BSD 444 EINN6600DC		50 005 226 NEW	
09.1981 → Reference	BSD 444, BSD 444 T EINN6600CC		50 005 220 NEW	

F

**FORD****Tractor 7610****126**09.1991 →
ReferenceBSD 444 T
EINN6600CC**50 005 220**
NEW**Tractor 7710****127**09.1981 →
ReferenceBSD 444 T
EINN6600CC**50 005 220**
NEW**F****Tractor 8070****128**

11.1986 →

OM 352.937

**50 005 843**

11.1986 →

OM 352.937





**50 005 835**

11.1986 →

OM 352.937

**50 005 617****Super-Dexta****129**1965 →
Reference2504 E
D5NN-6600-D E1NN-6600-DC**50 005 842**

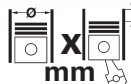

			Cyl	 mm	cm ³		Comp. Ratio ε	kW	PS	Pos
M 115.922	B		4	87 x 92,4	2197	2	9:1	63	86	2
M 115.933	B		4	87 x 92,4	2197	2	9:1	62	85	2
M 115.934	B		4	87 x 92,4	2197	2	9:1	55	75	2
M 115.935	B		4	87 x 92,4	2197	2	9:1	55	75	2
OM 314.915	D	(AN)	4	97 x 128	3780	2	17:1	63	85	2, 3, 4
OM 352.917	D	(AN)	6	97 x 128	5675	2	17:1	93	126	2
OM 353.916	D	(AN)	6	97 x 128	5675	2	17:1	81	110	6
OM 353.917	D	(AN)	6	97 x 128	5675	2	17:1	96	130	5, 6
OM 360.966	D	(AN)	6	115 x 140	8725	2	16,8:1	141	192	7
OM 360.967	D	(AN)	6	115 x 140	8725	2	16,8:1	127	172	7
OM 403.917	D	(AN)	10	125 x 130	15960	2	17,2:1	236	320	6, 8, 9
OM 403.919	D	(AN)	10	125 x 130	15960	2	17,2:1	236	320	6, 8, 9
OM 403.930	D	(AN)	10	125 x 130	15960	2	17,2:1	236	320	6, 8, 9
OM 615.936	D	(AN)	4	87 x 92,4	2197	2	21:1	37	50	1



Series F 20

1

01.1972→ Reference 	OM 615.936 110 200 01 20 Lager/bearing/coussinet/cojinete/подшипник: 36 mm			50 005 032
01.1972→ Reference 	OM 615.936 110 200 01 20 110 200 09 20 110 200 17 20 115 200 00 20 115 200 15 20 115 200 18 20 121 200 09 20 Lager/bearing/coussinet/cojinete/подшипник: 40 mm			50 005 035

Series F 45

2

1971 → 08.1973 Reference 	M 115.922, M 115.933, M 115.934, M 115.935 110 200 00 20 110 200 02 20 110 200 08 20 110 200 10 20 110 200 20 20 121 200 08 20			50 005 034
1971 → 02.1974 Reference 	OM 314.915, OM 352.917 314 180 10 01 352 180 24 01 352 180 63 01 352 180 70 01 364 180 01 01 OM 314.915: 020056→			50 005 843
1971 → 02.1974 Reference 	OM 314.915, OM 352.917 314 180 05 01 314 180 10 01 352 180 63 01 OM 314.915: →020055			50 005 835
1971 → 1974 Reference	OM 352.917 353 200 36 01 353 200 37 01			50 005 617

Series F 46

3

03.1971→02.1974 Reference 	OM 314.915 314 180 10 01 352 180 24 01 352 180 63 01 352 180 70 01 364 180 01 01 020056→			50 005 843
03.1971→02.1974 Reference 	OM 314.915 314 180 05 01 314 180 10 01 352 180 63 01 →020055			50 005 835



















Series F 55

4

03.1971→02.1974 Reference 	OM 314.915 314 180 10 01 352 180 24 01 352 180 63 01 352 180 70 01 364 180 01 01 020056→			50 005 843
----------------------------------	--	--	--	-------------------

H



				
03.1971→02.1974 Reference 	OM 314.915 314 180 05 01 →020055	314 180 10 01 352 180 63 01		50 005 835
Series F 110				5
1971 → 1974 Reference	OM 353.917 353 200 56 01			50 005 618
1971 → 1974 Reference 	OM 353.917 314 180 10 01 364 180 01 01 067374→	352 180 24 01 352 180 63 01 352 180 70 01		50 005 843
Series F 130				6
1971 → 1974 Reference	OM 353.916, OM 353.917 353 200 56 01			50 005 618
1971 → 1974 Reference 	OM 353.916, OM 353.917 314 180 10 01 364 180 01 01 OM 353.917: 067374→	352 180 24 01 352 180 63 01 352 180 70 01		50 005 843
04.1972→1974 Reference 	OM 403.917, OM 403.919, OM 403.930 403 180 33 01 121800→	423 180 01 01 423 180 05 01		50 005 834
04.1972→1974 Reference 	OM 403.917, OM 403.919, OM 403.930 401 180 00 01 →121799	401 180 01 01 403 180 06 01 403 180 17 01		50 005 837
04.1972→1974 Reference	OM 403.917, OM 403.919, OM 403.930 403 200 76 01 403 200 77 01			50 005 615
04.1972→1974 Reference	OM 403.917, OM 403.919, OM 403.930 403 200 27 01 403 200 49 01	403 200 32 01 403 200 34 01 403 200 35 01 403 200 70 01		50 005 207
04.1972→1974 Reference	OM 403.917, OM 403.919, OM 403.930 403 200 44 01 403 200 51 01	403 200 71 01		50 005 210

H



Series F 150

7

06.1971→04.1974 OM 360.966, OM 360.967
 Reference 360 180 06 01 360 180 07 01 360 180 15 01 360 180 18 01
 360 180 20 01 360 180 24 01 360 180 26 01

**50 005 830**

Series F 193

8

04.1972→1974 OM 403.917, OM 403.919, OM 403.930
 Reference 403 180 33 01 423 180 01 01 423 180 05 01
 121800→

**50 005 834**

04.1972→1974 OM 403.917, OM 403.919, OM 403.930
 Reference 401 180 00 01 401 180 01 01 403 180 06 01 403 180 17 01
 →121799

**50 005 837**

04.1972→1974 OM 403.917, OM 403.919, OM 403.930
 Reference 403 200 76 01 403 200 77 01

**50 005 615**

04.1972→1974 OM 403.917, OM 403.919, OM 403.930
 Reference 403 200 27 01 403 200 32 01 403 200 34 01 403 200 35 01
 403 200 49 01 403 200 70 01

**50 005 207**

04.1972→1974 OM 403.917, OM 403.919, OM 403.930
 Reference 403 200 44 01 403 200 51 01 403 200 71 01

**50 005 210**

Series F 263

9

04.1972→1974 OM 403.917, OM 403.919, OM 403.930
 Reference 403 180 33 01 423 180 01 01 423 180 05 01
 121800→

**50 005 834**

04.1972→1974 OM 403.917, OM 403.919, OM 403.930
 Reference 401 180 00 01 401 180 01 01 403 180 06 01 403 180 17 01
 →121799

**50 005 837**

04.1972→1974 OM 403.917, OM 403.919, OM 403.930
 Reference 403 200 76 01 403 200 77 01

**50 005 615**

04.1972→1974 OM 403.917, OM 403.919, OM 403.930
 Reference 403 200 27 01 403 200 32 01 403 200 34 01 403 200 35 01
 403 200 49 01 403 200 70 01

**50 005 207****H**



04.1972→1974
Reference

OM 403.917, OM 403.919, OM 403.930
403 200 44 01 403 200 51 01 403 200 71 01







50 005 210

H



			Cyl		mm	cm ³	Comp. Ratio	ε	kW	PS	Pos
20 T2N	D	(LA)	4	84,45 x 88,9	1994	2	19,5:1	77	105	6, 21	
A16A1	B		4	80 x 79,5	1598	3	9,1:1	66	90	1, 42	
A18A1	B		4	80 x 91	1829	3	9,1:1	74	100	3	
A20A1	B		4	82,7 x 91	1955	3	9,1:1	75-78	102-106	5	
A20A2	B		4	82,7 x 91	1955	3	9,1:1	75-78	101-106	5	
A20A3	B		4	82,7 x 91	1955	3	9,1:1	75	101	7	
A20A4	B		4	82,7 x 91	1955	3	9,4:1	90	122	7	
B16A1	B		4	81 x 77,4	1595	4	10,2:1	110	150	15, 19	
B16A2	B		4	81 x 77,4	1595	2	10,2:1	118	160	15, 19	
B18C4	B		4	81 x 87,2	1797	4	10:1	124	169	20	
B20B3	B		4	84 x 89	1973	4	9,2:1	94-96	128-131	14	
B20Z1	B		4	85 x 88	1997	4	9,6:1	108	147	14	
D13B1	B		4	75 x 76	1343	4	9:1	55	75	16	
D13B2	B		4	75 x 76	1343	4	9:1	55	75	16	
D13B7	B		4	75 x 76	1343	2	9,1:1	67	91	33	
D14A1	B		4	75 x 79	1396	4	9,3:1	66	90	17, 22	
D14A2	B		4	75 x 79	1396	4	9,2:1	66	90	17, 25	
D14A3	B		4	75 x 79	1396	4	9,1:1	55	75	17, 25	
D14A5	B		4	75 x 79	1396	4	9,1:1	55	75	17, 25	
D14A7	B		4	75 x 79	1396	4	9,1:1	55	75	17, 25	
D14A8	B		4	75 x 79	1396	4	9,2:1	66	90	17, 25	
D15B2	B		4	75 x 84,5	1493	4	9,2:1	66	90	18, 23	
D15Z1	B		4	75 x 84,5	1493	4	9,3:1	66	90	18	
D15Z3	B		4	75 x 84,5	1493	4	9,3:1	66	90	18	
D15Z6	B		4	75 x 84,5	1493	4	9,6:1	84	114	18, 26	
D15Z8	B		4	75 x 84,5	1493	4	9,6:1	84	114	18, 26	
D16A6	B		4	75 x 90	1590	4	9,1:1	80	109	15, 19	
D16A7	B		4	75 x 90	1590	4	9,5:1	96	130	19	
D16A8	B		4	75 x 90	1590	4	9,5:1	90-96	122-131	19, 24	
D16A9	B		4	75 x 90	1590	4	9,5:1	91-96	124-131	19	
D16B2	B		4	75 x 90	1590	4	9,1:1	82-85	111-116	19	
D16B6	B		4	75 x 90	1590	4	9,6:1	85	116	2	
D16V1	B		4	75 x 90	1590	4	10,4:1	81	110	19	
D16W1	B		4	75 x 90	1590	4	9,6:1	77	105	30	
D16W5	B		4	75 x 90	1590	4	9,6:1	92	125	30	
D16Y2	B		4	75 x 90	1590	4	9,2:1	93	126	15, 19	
D16Y3	B		4	75 x 90	1590	4	9,1:1	83	113	19	
D16Y5	B		4	75 x 90	1590	4	9,1:1	84	114	19, 27	
D16Y6	B		4	75 x 90	1590	4	9,1:1	81-83	110-113	19	
D16Y7	B		4	75 x 90	1590	4	9,4:1	77	105	19	
D16Y8	B		4	75 x 90	1590	4	9,2:1	92	125	19	
D16Z1	B		4	75 x 90	1590	4	9,1:1	81	110	24	
D16Z2 (81 kW)	B		4	75 x 90	1590	4	9,1:1	81-85	110-116	19, 24	
D16Z5	B		4	75 x 90	1590	4	9,2:1	91	124	15	
D16Z6	B		4	75 x 90	1590	4	9,2:1	92	125	19	
D16Z9	B		4	75 x 90	1590	4	9,2:1	92	125	19	
D17A2	B		4	75 x 94,4	1668	4	9,9:1	92	125	28, 40	
F18A3	B		4	85 x 81,5	1850	4	8,9:1	85	115	4	
F18B	B		4	85 x 81,5	1850	4	9,3:1	103	140	4	
F18B2	B		4	85 x 81,5	1850	4	10:1	100	136	4	
F20A2	B		4	85 x 88	1997	4	8,9:1	81	110	8, 13, 43	
F20A4	B		4	85 x 88	1997	4	9,5:1	98	133	8, 13, 35	
F20A6	B		4	85 x 88	1997	4	8,9:1	66	90	8	
F20A7	B		4	85 x 88	1997	4	9,5:1	98	133	8	
F20B3	B		4	85 x 88	1997	4	9,5:1	98	133	8	
F20B6	B		4	85 x 88	1997	4	9,5:1	108	147	8	
F20Z1	B		4	85 x 88	1997	4	9/9,5:1	96	131	8	
F20Z2	B		4	85 x 88	1997	4	9:1	85	115	8	
F20Z3	B		4	85 x 88	1997	4	9/9,5:1	100	136	8	
F22A3	B		4	85 x 95	2156	4	9,8:1	108-110	147-150	9	
F22A7	B		4	85 x 95	2156	4	9,8:1	110	150	9	
F22A8	B		4	85 x 95	2156	4	9,8:1	108	147	9	
F22B5	B		4	85 x 95	2156	4	9,8:1	110	150	9	
F22Z2	B		4	85 x 95	2156	4	8,8:1	110	150	9	
F23A	B		4	86 x 97	2254	4	9,5:1	110	150	34	
F23A7	B		4	86 x 97	2254	4	9,8:1	110-118	150-160	10, 38	
H22A2	B		4	87 x 90,7	2156	4	10,6:1	136	185	36	
H22A5	B		4	87 x 90,7	2156	4	10:1	136	185	36	
H22A7	B		4	87 x 90,7	2156	4	11:1	156-162	212-220	9	

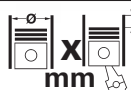

			Cyl		cm ³		Comp. Ratio ε	kW	PS	Pos
H23A2	B		4	87 x 95	2259	4	9,8:1	116	158	37
H23A3	B		4	87 x 95	2259	4	9,8:1	116-121	158-165	10
K20A1 (114 kW)	B		4	86 x 86	1998	4	9,8:1	114-118	155-160	8, 12, 14, 31, 39, 41
L12A1	B		4	73 x 74,3	1243	2	10,8:1	57	78	29, 32
ZCE	B		4	75 x 90	1590	4	9,3:1	74	100	11

H



HONDA

**Accord 1.6 12V****1**

11.1985→12.1989 A16A1
 Reference 19200-PH1-000 19200-PH1-020 19200-PH1-305 19200-PH1-505



50 005 079
 NEW

Accord 1.6 i 16V**2**

10.1998→02.2003 D16B6
 Reference 19200-P2A-004 19200-P2A-A01 19200-P2A-A02 19200-P2A-A03
 19200-PDF-E01



50 005 087
 NEW

H**Accord 1.8 12V****3**

06.1985→09.1989 A18A1
 Reference 19200-PH1-000 19200-PH1-020 19200-PH1-305 19200-PH1-505



50 005 079
 NEW

Accord 1.8 i 16V**4**

10.1998→ F18B2
 Reference 19200-PDA-E01

50 005 081
 NEW

09.1993→ F18A3, F18B
 Reference 19200-POA-003 19200-POA-032 19200-POB-A01 19200-PT0-003
 19200-PT0-013



50 005 080
 NEW

Accord 2.0 12V**5**

11.1985→12.1989 A20A1, A20A2
 Reference 19200-PH1-000 19200-PH1-020 19200-PH1-305 19200-PH1-505



50 005 079
 NEW

Accord 2.0 TDi**6**

09.1995→02.2003 20 T2N
 Reference 19200-P5T-G00



50 005 082
 NEW

Accord 2.0 i 12V**7**

11.1985→12.1989 A20A3, A20A4
 Reference 19200-PH1-000 19200-PH1-020 19200-PH1-305 19200-PH1-505















50 005 079
 NEW

Accord 2.0 i 16V**8**

10.1998→02.2003 F20B6
 Reference 19200-PDA-E01

50 005 081
 NEW



				
09.2002→ Reference	K20A1 (114 kW) 19200-PNA-003 19200-PNL-E01 19200-RBB-003 19200-RBB-013			50 005 902
01.1990→ Reference	F20A2, F20A4, F20A6, F20A7, F20B3, F20Z1, F20Z2, F20Z3 19200-POA-003 19200-POA-032 19200-POB-A01 19200-PT0-003 19200-PT0-013			50 005 080 <small>NEW</small>
Accord 2.2 i 16V				9
01.1999→02.2003 Reference	H22A7 19200-P13-000 19200-P13-003 19200-P13-013			50 005 091 <small>NEW</small>
01.1990→ Reference	F22A3, F22A7, F22A8, F22B5, F22Z2 19200-POA-003 19200-POA-032 19200-POB-A01 19200-PT0-003 19200-PT0-013			50 005 080 <small>NEW</small>
Accord 2.3 i 16V				10
03.1993→09.1995 Reference	H23A3 19200-P14-A00			50 005 090 <small>NEW</small>
02.1998→ Reference	F23A7 19200-POA-003 19200-POA-032 19200-POB-A01 19200-PT0-003 19200-PT0-013			50 005 080 <small>NEW</small>
Acura Integra 1.6 i 16V				11
11.1985→05.1989 Reference	ZCE 19200-P01-003 19200-P01-004 19200-P1J-E02 19200-PM3-003 19200-PM3-004 19200-PM3-013			50 005 084 <small>NEW</small>
Acura Integra R 2.0 i 16V				12
08.2001→ Reference	K20A1 (114 kW) 19200-PNA-003 19200-PNL-E01 19200-RBB-003 19200-RBB-013			50 005 902

H



HONDA





Ascot 2.0 i 16V

13

09.1989→	F20A2, F20A4							50 005 080 <small>NEW</small>
Reference	19200-POA-003 19200-PT0-013	19200-POA-032	19200-POB-A01	19200-PT0-003				



CRV 2.0 i 16V

14

10.1995→	B20B3, B20Z1							50 005 788
Reference	19200 P75 003							
10.2002→	K20A1 (114 kW)							50 005 902
Reference	19200-PNA-003	19200-PNL-E01	19200-RBB-003	19200-RBB-013				

CRX 1.6 i 16V

15

10.1987→02.1992	B16A1, D16A6, D16Z5							50 005 084 <small>NEW</small>
Reference	19200-P01-003 19200-PM3-004	19200-P01-004 19200-PM3-013	19200-P1J-E02	19200-PM3-003				
03.1992→	B16A2, D16Y2							50 005 094 <small>NEW</small>
Reference	19200-P08-003	19200-P08-004	19200-P08-A01	19200-P10-A02				



Civic 1.3 16V

16

10.1987→09.1991	D13B1, D13B2							50 005 084 <small>NEW</small>
Reference	19200-P01-003 19200-PM3-004	19200-P01-004 19200-PM3-013	19200-P1J-E02	19200-PM3-003				

Civic 1.4 i 16V

17





10.1995→	D14A3, D14A7, D14A8							50 005 087 <small>NEW</small>
Reference	19200-P2A-004 19200-PDF-E01	19200-P2A-A01	19200-P2A-A02	19200-P2A-A03				
10.1987→01.1997	D14A1, D14A2, D14A5							50 005 084 <small>NEW</small>
Reference	19200-P01-003 19200-PM3-004	19200-P01-004 19200-PM3-013	19200-P1J-E02	19200-PM3-003				

H



Civic 1.5 i 16V

18

10.1995→02.2001 Reference	D15Z6, D15Z8 19200-P2A-004 19200-PDF-E01	19200-P2A-A01	19200-P2A-A02	19200-P2A-A03		50 005 087 NEW
10.1988→09.1995 Reference	D15B2 19200-P01-003 19200-PM3-004	19200-P01-004 19200-PM3-013	19200-P1J-E02	19200-PM3-003		50 005 084 NEW
10.1988→01.1997 Reference	D15B2, D15Z3 19200-P08-003	19200-P08-004	19200-P08-A01	19200-P10-A02		50 005 094 NEW
10.1991→02.2001 Reference	D15Z1, D15Z8 19200-P1G-E02	19200-P7A-003				50 005 086 NEW

H

Civic 1.6 i 16V

19

01.1994→02.2001 Reference	D16B2, D16Y5, D16Y6, D16Y7, D16Y8, D16Z9 19200-P2A-004 19200-PDF-E01	19200-P2A-A01	19200-P2A-A02	19200-P2A-A03		50 005 087 NEW
03.1997→02.2001 Reference	D16B2 19200-P72-A01					50 005 092 NEW
09.1987→01.1997 Reference	B16A1, D16A6, D16A7, D16A8, D16A9, D16Y3, D16Z2 (81 kW), D16Z6 19200-P01-003 19200-PM3-004	19200-P01-004 19200-PM3-013	19200-P1J-E02	19200-PM3-003		50 005 084 NEW
10.1991→02.2001 Reference	B16A2, D16Y2, D16Z6, D16Z9 19200-P08-003	19200-P08-004	19200-P08-A01	19200-P10-A02		50 005 094 NEW
02.2001→ Reference	D16V1 19200 PLM A01					50 005 789



HONDA



Civic 1.8 i 16V

2003.1997→
ReferenceB18C4
19200-P72-A01**50 005 092**
NEW

Civic 2.0 TDi

2103.1997→02.2001
Reference20 T2N
19200-P5T-G00**50 005 082**
NEW**H**

Concerto 1.4 i 16V

2208.1989→03.1995
ReferenceD14A1
19200-P01-003 19200-P01-004 19200-P1J-E02 19200-PM3-003
19200-PM3-004 19200-PM3-013**50 005 084**
NEW

Concerto 1.5 i 16V

2308.1989→03.1995
ReferenceD15B2
19200-P01-003 19200-P01-004 19200-P1J-E02 19200-PM3-003
19200-PM3-004 19200-PM3-013**50 005 084**
NEW08.1989→03.1995
ReferenceD15B2
19200-P08-003 19200-P08-004 19200-P08-A01 19200-P10-A02**50 005 094**
NEW



Concerto 1.6 i 16V

2408.1989→03.1995
ReferenceD16A8, D16Z1, D16Z2 (81 kW)
19200-P01-003 19200-P01-004 19200-P1J-E02 19200-PM3-003
19200-PM3-004 19200-PM3-013**50 005 084**
NEW

Domani 1.4 i 16V

2510.1995→
ReferenceD14A3, D14A7, D14A8
19200-P2A-004 19200-P2A-A01 19200-P2A-A02 19200-P2A-A03
19200-PDF-E01**50 005 087**
NEW09.1994→12.1996
ReferenceD14A2, D14A5
19200-P01-003 19200-P01-004 19200-P1J-E02 19200-PM3-003
19200-PM3-004 19200-PM3-013**50 005 084**
NEW

**Domani 1.5 i 16V****26**

10.1995→ Reference	D15Z6, D15Z8 19200-P2A-004 19200-PDF-E01	19200-P2A-A01	19200-P2A-A02	19200-P2A-A03		50 005 087 NEW
01.1997→ Reference	D15Z8 19200-P1G-E02	19200-P7A-003				50 005 086 NEW

Domani 1.6 i 16V**27**

10.1995→ Reference	D16Y5 19200-P2A-004 19200-PDF-E01	19200-P2A-A01	19200-P2A-A02	19200-P2A-A03		50 005 087 NEW
-----------------------	---	---------------	---------------	---------------	---	--------------------------

FR-V 1.7i 16V**28**

03.2005→ Reference	D17A2 19200 PLM A01					50 005 789
-----------------------	------------------------	--	--	--	--	-------------------

Fit 1.2 i**29**

01.2002→ Reference	L12A1 19200-PWA-003					50 005 093 NEW
-----------------------	------------------------	--	--	--	---	--------------------------

HR-V 1.6 i 16V**30**

12.1998→ Reference	D16W1, D16W5 19200-P2A-004 19200-PDF-E01	19200-P2A-A01	19200-P2A-A02	19200-P2A-A03		50 005 087 NEW
-----------------------	--	---------------	---------------	---------------	---	--------------------------

Integra R 2.0 i 16V**31**

08.2001→ Reference	K20A1 (114 kW) 19200-PNA-003	19200-PNL-E01	19200-RBB-003	19200-RBB-013		50 005 902
-----------------------	---------------------------------	---------------	---------------	---------------	---	-------------------

Jazz 1.2 i**32**

03.2002→ Reference	L12A1 19200-PWA-003					50 005 093 NEW
-----------------------	------------------------	--	--	--	---	--------------------------

**HONDA****Logo 1.3 i****33**

02.1999→03.2002

D13B7

Reference

19200-P1G-E02

19200-P7A-003

**50 005 086****NEW****Odyssey 2.3 i 16V****34**

09.1997→

F23A

Reference

19200-POA-003
19200-PT0-013

19200-POA-032

19200-POB-A01

19200-PT0-003

**50 005 080****NEW****H****Prelude 2.0 i 16V****35**

02.1992→12.1999

F20A4

Reference

19200-POA-003
19200-PT0-013

19200-POA-032

19200-POB-A01

19200-PT0-003

**50 005 080****NEW****Prelude 2.2 i 16V****36**

02.1993→

H22A2, H22A5

Reference

19200-P13-000

19200-P13-003

19200-P13-013

**50 005 091****NEW****Prelude 2.3 i 16V****37**

02.1992→09.1996

H23A2

Reference

19200-P14-A00

**50 005 090****NEW****Shuttle 2.3 i 16V****38**

01.1998→05.2001

F23A7

Reference

19200-POA-003
19200-PT0-013

19200-POA-032

19200-POB-A01

19200-PT0-003

**50 005 080****NEW****Stepwgn 2.0 i 16V****39**

2001 →

K20A1 (114 kW)

Reference

19200-PNA-003

19200-PNL-E01

19200-RBB-003

19200-RBB-013

**50 005 902****Stream 1.7 i 16V****40**

05.2001→

D17A2

Reference

19200-PLM A01

**50 005 789**



Stream 2.0 i 16V

41

05.2001→

K20A1 (114 kW)

Reference

19200-PNA-003 19200-PNL-E01 19200-RBB-003 19200-RBB-013

**50 005 902**

Vigor 1.6 12V

42

11.1985→12.1989

A16A1

Reference

19200-PH1-000 19200-PH1-020 19200-PH1-305 19200-PH1-505

**50 005 079****NEW**

Vigor 2.0 i 16V

43**H**

09.1989→09.1993

F20A2

Reference

19200-POA-003 19200-POA-032 19200-POB-A01 19200-PT0-003
19200-PT0-013**50 005 080****NEW**



			Cyl		mm	cm ³	Comp. Ratio	ε	kW	PS	Pos
4G15 (62 kW)	B		4	75,5 x 82	1468	2	9,4:1		62-66	84-90	22
D3EA	D	(LA)	3	83 x 92	1493	2	17,7:1		60	82	4, 13, 16, 17, 52, 53
D4BA	D	(A)	4	91,1 x 95	2477	2	21:1		54-59	73-80	8, 9, 15
D4BF-E	D	(A)	4	91,1 x 95	2477	2	21:1		59	80	8, 15, 27, 41
D4BH	D	(A)	4	91,1 x 95	2477	2	21:1		69-78	94-106	8, 9, 32
D4BX	D	(AN)	4	91,1 x 95	2477	2	21:1		55-59	75-80	8, 15
D4EA (83 kW)	D	(LA)	4	83 x 92	1991	4	17,7:1		83	112	40, 42, 43, 46, 58, 59
G15B	B		4	75,5 x 82	1468	2	9,5:1		51-57	70-77	21
G4DG (44 kW)	B		4	71 x 82	1299	2	9,7:1		44-47	60-64	19
G4DJ (53 kW)	B		4	75,5 x 82	1468	2	9,4:1		53	72	21, 24, 33
G4DJ (57 kW)	B		4	75,5 x 82	1468	2	9,4:1		57	77	31, 33
G4DJ (62 kW)	B		4	75,5 x 82	1468	2	9,4:1		62-63	84-86	22, 38, 39
G4EA	B		4	71,5 x 83,5	1341	3	9,5:1		62	84	3, 36
G4EB (66 kW)	B		4	75,5 x 83,5	1495	3	10:1		66	90	45
G4ED-G (77 kW)	B		4	75,5 x 87	1594	4	10:1		77-79	105-107	5, 6, 14, 18, 49, 54, 55
G4EE	B		4	75,5 x 78,1	1399	4	10:1		71	97	12
G4EH (44 kW)	B		4	71,5 x 83,5	1341	3	9,5:1		44-51	60-70	36
G4EH (60 kW)	B		4	71,5 x 83,5	1341	3	9,5:1		60-63	82-85	11, 20, 35, 36
G4EK (65 kW)	B		4	75,5 x 83,5	1495	3	10:1		65-68	88-92	44, 45, 47, 48
G4EK-TC	B	(A)	4	75,5 x 83,5	1495	2	7,5:1		85	116	23, 25
G4GC	B		4	82 x 93,5	1975	4	10:1		104	141	56, 57
G4GF (102 kW)	B		4	82 x 93,5	1975	4	10,3:1		102	139	7, 29, 56, 57
G4GF (105 kW)	B		4	82 x 93,5	1975	4	10,1:1		102-105	139-143	7, 29, 30, 34, 37
G4GR	B		4	77,4 x 85	1599	4	9,7		84	114	6, 28, 49, 50
G4HC	B		4	66 x 73	999	3	9,5:1		40	54	1, 26
G4HD (43 kW)	B		4	67 x 77	1086	3	10:1		43	59	2
G6AT (104 kW)	B		6	91,1 x 76	2972	2	8,9:1		104-107	141-146	10, 51, 60, 61

H

**Atos 1.0i 12V****1**

12.1997→06.2001	G4HC							
Reference	25100-02500	25100-02501	25100-02502	25100-02555				50 005 098 <small>NEW</small>

Atos 1.1i 12V**2**

10.2003→	G4HD (43 kW)							
Reference	25100-02500	25100-02501	25100-02502	25100-02555				50 005 098 <small>NEW</small>

Click 1.3i 12V**3**

03.2002→	G4EA							
Reference	25100-22010 25100-24040	25100-22012 25100-24060	25100-22650	25100-24030				50 005 095 <small>NEW</small>

Click 1.5 CRDi 12V**4**

03.2002→	D3EA							
Reference	25100-27000							50 005 096 <small>NEW</small>

Click 1.6i 16V**5**

03.2002→	G4ED-G (77 kW)							
Reference	25100-26900	25100-26901	25100-26902					50 005 097 <small>NEW</small>

Coupé 1.6i 16V**6**



05.1996→09.2001	G4GR							
Reference	25100-23001	25100-23002	25100-23010	25100-23020				50 005 903

02.2003→	G4ED-G (77 kW)							
Reference	25100-26900	25100-26901	25100-26902					50 005 097 <small>NEW</small>



Coupé 2.0i 16V**7**

05.1996→07.2003	G4GF (102 kW), G4GF (105 kW)							
Reference	25100-23001	25100-23002	25100-23010	25100-23020				50 005 903

**Galopper I 2.5 TD****8**

02.1991→08.1994 Reference	D4BA, D4BX 25100-42000				50 005 123 NEW
02.1991→01.1997 Reference	D4BF-E, D4BH 25100-42540 25100-42541				50 005 124 NEW

Galopper II 2.5 TD**9**

02.1997→08.2001 Reference	D4BA 25100-42000				50 005 123 NEW
02.1997→09.2002 Reference	D4BH 25100-42540 25100-42541				50 005 124 NEW

Galopper II 3.0i**10**

02.1997→08.2001 Reference	G6AT (104 kW) 25100-35010 25100-35020 25100-35030 25100-35050 25100-36010				50 005 128 NEW
------------------------------	--	--	--	--	--------------------------

Getz 1.3i 12V**11**

03.2002→ Reference	G4EH (60 kW) 25100-22010 25100-22012 25100-22650 25100-24030 25100-24040 25100-24060				50 005 095 NEW
-----------------------	--	--	---	--	--------------------------

Getz 1.4i 16V**12**

10.2005→ Reference	G4EE 25100-26900 25100-26901 25100-26902				50 005 097 NEW
-----------------------	---	--	---	--	--------------------------

Getz 1.5 CRDi 12V**13**



03.2003→ Reference	D3EA 25100-27000				50 005 096 NEW
-----------------------	---------------------	--	---	--	--------------------------

H

**Getz 1.6i 16V****14**

09.2002→ Reference	G4ED-G (77 kW) 25100-26900 25100-26901 25100-26902			50 005 097 NEW
-----------------------	---	---	--	--------------------------

H100 2.5 TD**15**

02.1993→12.1994 Reference	D4BA, D4BX 25100-42000			50 005 123 NEW
06.1997→ Reference	D4BF-E 25100-42540 25100-42541			50 005 124 NEW

Lavita 1.5 CRDi 12V**16**

→ Reference	D3EA 25100-27000			50 005 096 NEW
----------------	---------------------	---	--	--------------------------

Matrix 1.5 CRDi 12V**17**

08.2001→ Reference	D3EA 25100-27000			50 005 096 NEW
-----------------------	---------------------	---	--	--------------------------

Matrix 1.6i 16V**18**

08.2001→ Reference	G4ED-G (77 kW) 25100-26900 25100-26901 25100-26902			50 005 097 NEW
-----------------------	---	---	--	--------------------------

Pony 1.3**19**

04.1989→07.1994 Reference	G4DG (44 kW) 25100-22010 25100-22012 25100-22650 25100-24030 25100-24040 25100-24060			50 005 095 NEW
------------------------------	--	---	--	--------------------------

Pony 1.3i 12V**20**

07.1994→07.1999 Reference	G4EH (60 kW) 25100-22010 25100-22012 25100-22650 25100-24030 25100-24040 25100-24060			50 005 095 NEW
------------------------------	--	---	--	--------------------------

**Pony 1.5****21**

10.1985→	G15B, G4DJ (53 kW)					50 005 095 <small>NEW</small>
Reference	25100-22010 25100-24040	25100-22012 25100-24060	25100-22650	25100-24030		

Pony 1.5i**22**

04.1989→	4G15 (62 kW), G4DJ (62 kW)					50 005 095 <small>NEW</small>
Reference	25100-22010 25100-24040	25100-22012 25100-24060	25100-22650	25100-24030		

H**Pony 1.5i Turbo****23**

10.1992→	G4EK-TC					50 005 095 <small>NEW</small>
Reference	25100-22010 25100-24040	25100-22012 25100-24060	25100-22650	25100-24030		

S-Coupé 1.5**24**

02.1990→06.1992	G4DJ (53 kW)					50 005 095 <small>NEW</small>
Reference	25100-22010 25100-24040	25100-22012 25100-24060	25100-22650	25100-24030		

S-Coupé 1.5i Turbo**25**

07.1992→04.1995	G4EK-TC					50 005 095 <small>NEW</small>
Reference	25100-22010 25100-24040	25100-22012 25100-24060	25100-22650	25100-24030		

Santro 1.0i 12V**26**

09.1998→02.2002	G4HC					50 005 098 <small>NEW</small>
Reference	25100-02500	25100-02501	25100-02502	25100-02555		

Satellite 2.5 TD**27**

10.1997→	D4BF-E					50 005 124 <small>NEW</small>
Reference	25100-42540	25100-42541				

Tiburon 1.6i 16V**28**

03.1996→	G4GR					50 005 903
Reference	25100-23001	25100-23002	25100-23010	25100-23020		

**Tiburon 2.0i 16V****29**

03.1996→ Reference	G4GF (102 kW), G4GF (105 kW) 25100-23001 25100-23002 25100-23010 25100-23020			50 005 903
-----------------------	--	---	--	------------

Tuscani 2.0i 16V**30**

→ Reference	G4GF (105 kW) 25100-23001 25100-23002 25100-23010 25100-23020			50 005 903
----------------	---	---	--	------------

Elantra 1.5**31**

10.1990→04.1995 Reference	G4DJ (57 kW) 25100-22010 25100-22012 25100-22650 25100-24030 25100-24040 25100-24060			50 005 095 <small>NEW</small>
------------------------------	--	---	--	----------------------------------

H**H1 2.5 TD****32**

03.2002→ Reference	D4BH 25100-42540 25100-42541			50 005 124 <small>NEW</small>
-----------------------	------------------------------------	--	--	----------------------------------

Lantra 1.5**33**

10.1990→04.1995 Reference	G4DJ (53 kW), G4DJ (57 kW) 25100-22010 25100-22012 25100-22650 25100-24030 25100-24040 25100-24060			50 005 095 <small>NEW</small>
------------------------------	--	---	--	----------------------------------

Tucson 2.0i 16V**34**

08.2004→ Reference	G4GF (105 kW) 25100-23001 25100-23002 25100-23010 25100-23020			50 005 903
-----------------------	---	---	--	------------

Verna 1.3i 12V**35**

09.1999→ Reference	G4EH (60 kW) 25100-22010 25100-22012 25100-22650 25100-24030 25100-24040 25100-24060			50 005 095 <small>NEW</small>
-----------------------	--	---	--	----------------------------------

Accent 1.3i 12V**36**

07.1994→ Reference	G4EA, G4EH (44 kW), G4EH (60 kW) 25100-22010 25100-22012 25100-22650 25100-24030 25100-24040 25100-24060			50 005 095 <small>NEW</small>
-----------------------	--	---	--	----------------------------------

**Avante 2.0i 16V****37**

→

G4GF (105 kW)

Reference

25100-23001 25100-23002 25100-23010 25100-23020



50 005 903

Elantra 1.5i**38**

10.1990→04.1995

G4DJ (62 kW)

Reference

25100-22010 25100-22012 25100-22650 25100-24030
25100-24040 25100-24060

50 005 095

NEW

H**Lantra 1.5i****39**

10.1990→04.1995

G4DJ (62 kW)

Reference

25100-22010 25100-22012 25100-22650 25100-24030
25100-24040 25100-24060

50 005 095

NEW

Santa Fe 2.0 CRDi 16V**40**

02.2001→

D4EA (83 kW)

Reference

25100-27000



50 005 096

NEW

Starex 2.5 TD**41**

10.1997→

D4BF-E

Reference

25100-42540 25100-42541



50 005 124

NEW

Trajt 2.0 CRDi 16V**42**

02.2000→

D4EA (83 kW)

Reference

25100-27000



50 005 096

NEW

Tucson 2.0 CRDi 16V**43**

09.2004→

D4EA (83 kW)

Reference

25100-27000



50 005 096

NEW

Verna 1.5i 12V**44**

09.1999→

G4EK (65 kW)

Reference

25100-22010 25100-22012 25100-22650 25100-24030
25100-24040 25100-24060

50 005 095

NEW

**Accent 1.5i 12V****45**

07.1994→	G4EB (66 kW), G4EK (65 kW)					50 005 095 <small>NEW</small>
Reference	25100-22010 25100-24040	25100-22012 25100-24060	25100-22650	25100-24030		

Avante 2.0 CRDi 16V**46**

2003 →	D4EA (83 kW)					50 005 096 <small>NEW</small>
Reference	25100-27000					

Elantra 1.5i 12V**47**

07.1996→09.2000	G4EK (65 kW)					50 005 095 <small>NEW</small>
Reference	25100-22010 25100-24040	25100-22012 25100-24060	25100-22650	25100-24030		

Lantra 1.5i 12V**48**

07.1996→09.2000	G4EK (65 kW)					50 005 095 <small>NEW</small>
Reference	25100-22010 25100-24040	25100-22012 25100-24060	25100-22650	25100-24030		

Elantra 1.6i 16V**49**

05.1995→09.2000	G4GR					50 005 903
Reference	25100-23001	25100-23002	25100-23010	25100-23020		

06.2000→	G4ED-G (77 kW)					50 005 097 <small>NEW</small>
Reference	25100-26900	25100-26901	25100-26902			

Lantra 1.6i 16V**50**

05.1995→09.2000	G4GR					50 005 903
Reference	25100-23001	25100-23002	25100-23010	25100-23020		

Sonata I 3.0i V6**51**

09.1989→06.1993	G6AT (104 kW)					50 005 128 <small>NEW</small>
Reference	25100-35010 25100-36010	25100-35020	25100-35030	25100-35050		



Verna 1.5 CRDi 12V

52

2002 →
Reference D3EA
25100-27000



50 005 096
NEW

Accent 1.5 CRDi 12V

53

01.2002 →
Reference D3EA
25100-27000



50 005 096
NEW

H

Verna 1.6i 16V

54

2003 →
Reference G4ED-G (77 kW)
25100-26900 25100-26901 25100-26902



50 005 097
NEW

Accent 1.6i 16V

55

08.1999 →
Reference G4ED-G (77 kW)
25100-26900 25100-26901 25100-26902



50 005 097
NEW

Elantra 2.0i 16V

56

06.2000 →
Reference G4GC, G4GF (102 kW)
25100-23001 25100-23002 25100-23010 25100-23020



50 005 903

Lantra 2.0i 16V

57

08.1996 →
Reference G4GC, G4GF (102 kW)
25100-23001 25100-23002 25100-23010 25100-23020



50 005 903

Elantra 2.0 CRDi 16V

58

01.2001 →
Reference D4EA (83 kW)
25100-27000



50 005 096
NEW

Lantra 2.0 CRDi 16V

59

09.2000 →
Reference D4EA (83 kW)
25100-27000



50 005 096
NEW



Sonata II 3.0i

60

07.1993→04.1996

G6AT (104 kW)

Reference

25100-35010 25100-35020 25100-35030 25100-35050
25100-36010

50 005 128
NEW

Sonata III 3.0i

61

05.1996→06.1998

G6AT (104 kW)





Reference

25100-35010 25100-35020 25100-35030 25100-35050
25100-36010

50 005 128
NEW

H

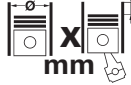

			Cyl	 mm	cm ³		Comp. Ratio ε	kW	PS	Pos
6.354	D	(AN)	6	98,48 x 126,8	5794	2	16:1	69-82	94-112	3, 4, 12
4.212	D	(AN)	4	98,48 x 114	3475	2	15,5:1	44-47	60-64	9
4.236	D	(AN)	4	98,48 x 126,8	3864	2	16:1	48-60	59-80	1, 2, 11
F 4 L 912 D	D	(AN)	4	100 x 120	3770	2		19-59	20-80	5, 6
F 6 L 912 D	D	(AN)	6	100 x 120	5655	2		42-92	57-125	7, 8
OM 942.967	D	(LA)	8	130 x 150	15928	4	17,25:1	370-380	503-516	10

I



IHC-CASE (CNH)



Series 1210

1

01.1972→12.1974

4.236

**50 005 246**
NEW

01.1972→12.1974

4.236

mit Riemenscheibe
with pulley
avec poulie
con polea
с Ремснный шкив**50 005 245**
NEW

01.1972→12.1974

4.236

**50 005 252**
NEW

Series 1310

2

01.1972→12.1974

4.236

**50 005 246**
NEW

01.1972→12.1974

4.236

mit Riemenscheibe
with pulley
avec poulie
con polea
с Ремснный шкив**50 005 245**
NEW

01.1972→12.1974

4.236

**50 005 252**
NEW

Series 1700

3

01.1971→

6.354

**50 005 231**
NEW

Series 1820

4

01.1975→

6.354

**50 005 231**
NEW











IHC-CASE (CNH)





				
Series 3944 5				
01.1973→12.1986	F 4 L 912 D		50 005 366	
Series 3945 6				
01.1973→12.1986	F 4 L 912 D		50 005 366	
Series 3960 7				
07.1973→12.1986	F 6 L 912 D		50 005 367	
Series 3961 8				
07.1973→12.1986	F 6 L 912 D		50 005 367	
Series 475 9				
01.1975→	4.212		50 005 235 <small>NEW</small>	
01.1975→	4.212		50 005 840	
Series 600 10				
1996 →	OM 942.967			50 005 619
1996 →	OM 942.967		50 005 838	
Series 660 11				
01.1972→	4.236			50 005 246 <small>NEW</small>



IHC-CASE (CNH)

				
01.1972→ 	4.236 mit Riemenscheibe with pulley avec poulie con polea с Ремснный шкив			50 005 245 NEW
01.1972→	4.236			50 005 252 NEW
Series H 65 B/C				12
01.1969→12.1986	6.354		50 005 231 NEW	



			Cyl	 mm	cm ³		Comp. Ratio ε	kW	PS	Pos
4JB1-T	D	(A)	4	93 x 102	2771	2	18,2:1	64-74	87-100	1, 4
4JB1-TC	D	(LA)	4	93 x 102	2771	2	17,5:1	78-85	108-115	2, 5
TD27	D	(AN)	4	96 x 92	2664	2	21,8:1	62-73	85-99	3

I



Bighorn 2.8 TD

1

08.1987→11.1991

4JB1-T

Reference

89414-3412
89441-94612

89431-02510
89446-11730

89437-68410
89701-85601

89437-68440



50 005 100
NEW

Bighorn 2.8 TDI

2

10.1988→12.1992

4JB1-TC

Reference

89414-3412
89441-94612

89431-02510
89446-11730

89437-68410
89701-85601

89437-68440



50 005 100
NEW

Fargo 2.7 D

3

08.1995→

TD27



50 005 173
NEW

Trooper 2.8 TD

4

10.1987→12.1992

4JB1-T

Reference

89414-3412
89441-94612

89431-02510
89446-11730

89437-68410
89701-85601

89437-68440



50 005 100
NEW

Trooper 2.8 TDI

5

10.1988→12.1992

4JB1-TC

Reference

89414-3412
89441-94612

89431-02510
89446-11730





89437-68410
89701-85601

89437-68440



50 005 100
NEW



			Cyl	 mm	cm ³		Comp. Ratio ε	kW	PS	Pos
R4-X404	D	(LA)	4	86 x 86	1998	4	18,2:1	96	131	1

J



X-Type 2.0 d 16V

1

09.2003→





R4-X404



50 005 752

J



			Cyl		cm ³		Comp. Ratio ε	kW	PS	Pos
3.164 DL-01	D	(AN)	3	102 x 110	2696	2	16,7:1	41	56	17, 20
3.164 DL-03	D	(AN)	3	102 x 110	2696	2	16,7:1	26-38	35-51	8, 10, 16, 25, 41
3.164 DL-04	D	(AN)	3	102 x 110	2696	2		34	46	13, 14, 26
3.164 DL-12	D	(AN)	3	102 x 110	2696	2				2
3.164 DL-13	D	(AN)	3	102 x 110	2696	2		38	52	18, 21
3.164 DL-14	D	(AN)	3	102 x 110	2696	2		26	35	8
3.164 DL-15	D	(AN)	3	102 x 110	2696	2		30	41	11
3.164 DZ-02	D	(AN)	3	102 x 110	2696	2		38	52	3
3.179 DL-01	D	(AN)	3	106,5 x 110	2938	2	16,8:1	41	56	19, 22
3.179 DL-03	D	(AN)	3	106,5 x 110	2938	2		39	53	1
3.179 DL-04	D	(AN)	3	106,5 x 110	2938	2		28	38	9
3.179 DL-05	D	(AN)	3	106,5 x 110	2938	2		32	44	12
3.179 DL-06	D	(AN)	3	106,5 x 110	2938	2		34	46	15
3.179 DL-07	D	(AN)	3	106,5 x 110	2938	2	17,4:1	37	50	42
4.039 D	D	(AN)	4	106,5 x 110	3920	2	17,8:1	60	80	42
4.039 DRT	D	(AN)	4	106,5 x 110	3920	2	17,8:1	48	65	36
4.039 T	D	(A)	4	106,5 x 110	3920	2	17,8:1	82	110	42
4.045 D	D	(AN)	4	106,5 x 127	4525	2	17,8:1	55-63	75-85	37, 40
4.239 A	D	(LA)	4	106,5 x 110	3920	2	17,8:1	87	117	42
4.239 DL-01	D	(AN)	4	106,5 x 110	3920	2	16:1	46-55	63-75	27
4.239 DL-03	D	(AN)	4	106,5 x 110	3920	2	16:1	46-55	62-75	23
4.239 DL-04	D	(AN)	4	106,5 x 110	3920	2		51	69	4, 24, 26
4.239 TL	D	(A)	4	106,5 x 110	3920	2	17,8:1	67	91	28
4.239 TL-02	D	(A)	4	106,5 x 110	3920	2	17,8:1	60	82	28
6.059 D	D	(AN)	6	106,5 x 110	5878	2	17,8:1	89	120	42
6.059 T	D	(A)	6	106,5 x 110	5878	2	17,8:1	123	165	42
6.059 TL	D	(A)	6	106,5 x 110	5878	2	17,8:1	89	120	41
6.329 DL-01	D	(AN)	6	102 x 110	5395	2	16,7:1	66	90	32
6.329 DL-03	D	(A)	6	102 x 110	5380	2	16,2:1	63-68	86-92	29, 30, 33, 34, 35, 38, 41
6.329 DL-11	D	(A)	6	102 x 110	5380	2		66	90	33
6.329 DZ-01	D	(AN)	6	102 x 110	5395	2				7
6.329 DZ-02	D	(AN)	6	102 x 110	5395	2				5, 6, 7
6.329 DZ-07	D	(AN)	6	102 x 110	5395	2				5
6.359 D-02	D	(AN)	6	106,5 x 110	5878	2	16:1	66	90	31
6.359 DL-01	D	(AN)	6	106,5 x 110	5878	2		66	90	31
6.359 DL-02	D	(AN)	6	106,5 x 110	5878	2	16,8:1	71	97	42
6.359 DL-03	D	(AN)	6	106,5 x 110	5878	2	16,8:1	71	97	35
6.359 DL-04	D	(AN)	6	106,5 x 110	5878	2		74	101	35
6.359 DL-06	D	(AN)	6	106,5 x 110	5878	2		68	92	31
6.359 T	D	(A)	6	106,5 x 110	5878	2	17,8:1	82-102	112-139	39

J

**Series JD 310****1**03.1974→02.1992 3.179 DL-03
Reference RE35685**50 005 229**
NEW**Series JD 350****2**04.1974→07.1975 3.164 DL-12
Reference RE35685**50 005 229**
NEW**Series MD 925****3**11.1974→09.1978 3.164 DZ-02
Reference RE35685**50 005 229**
NEW**Series MD 932****4**10.1979→10.1983 4.239 DL-04
Reference RE35685**50 005 229**
NEW**Series MD 950****5**08.1972→07.1975 6.329 DZ-02, 6.329 DZ-07
Reference RE35685**50 005 229**
NEW**Series MD 955****6**06.1975→10.1983 6.329 DZ-02
Reference RE35685**50 005 229**
NEW**Series MD 960****7**08.1972→08.1975 6.329 DZ-01, 6.329 DZ-02
Reference RE35685**50 005 229**
NEW**Series 830****8**08.1975→08.1979 3.164 DL-03, 3.164 DL-14
Reference RE35685**50 005 229**
NEW**J**

**Series 840****9**

09.1979→10.1986 3.179 DL-04
Reference RE35685



50 005 229
NEW

Series 890**10**

1967 → 3.164 DL-03
Reference RE35685



50 005 229
NEW

Series 930**11**

08.1975→08.1979 3.164 DL-15
Reference RE35685



50 005 229
NEW

Series 940**12**

09.1979→10.1986 3.179 DL-05
Reference RE35685



50 005 229
NEW

Series 1020**13**

04.1971→07.1975 3.164 DL-04
Reference RE35685



50 005 229
NEW

Series 1030**14**

08.1975→08.1979 3.164 DL-04
Reference RE35685



50 005 229
NEW

Series 1040**15**

09.1979→10.1986 3.179 DL-06
Reference RE35685



50 005 229
NEW

Series 1050 C**16**

1967 → 3.164 DL-03
Reference RE35685



50 005 229
NEW

J

**Series 1120****17**

04.1971→07.1975 3.164 DL-01
Reference RE35685



50 005 229
NEW

Series 1130**18**

08.1975→08.1979 3.164 DL-13
Reference RE35685



50 005 229
NEW

Series 1140**19**

09.1979→10.1986 3.179 DL-01
Reference RE35685



50 005 229
NEW

Series 1520**20**

1968 → 1973 3.164 DL-01
Reference RE35685



50 005 229
NEW

Series 1530**21**

07.1972→07.1975 3.164 DL-13
Reference RE35685



50 005 229
NEW

Series 1630**22**

08.1975→08.1979 3.179 DL-01
Reference RE35685



50 005 229
NEW

Series 1640**23**

09.1979→10.1986 4.239 DL-03
Reference RE35685



50 005 229
NEW

Series 1840**24**









09.1979→10.1986 4.239 DL-04
Reference RE35685



50 005 229
NEW

J











Series 2020		25	
1967 → Reference	3.164 DL-03 RE35685		50 005 229 NEW
Series 2040		26	
08.1975→10.1986 Reference	3.164 DL-04, 4.239 DL-04 RE35685		50 005 229 NEW
Series 2130		27	
09.1972→08.1979 Reference	4.239 DL-01 RE35685		50 005 229 NEW
Series 2140		28	
09.1979→10.1986 Reference	4.239 TL, 4.239 TL-02 RE35685		50 005 229 NEW
Series 2840		29	
1973 → Reference	6.329 DL-03 RE35685		50 005 229 NEW
Series 3030		30	
1973 → Reference	6.329 DL-03 RE35685		50 005 229 NEW
Series 3040		31	
1975 → Reference	6.359 D-02 AR79463		50 005 230 NEW
09.1979→10.1986 Reference	6.359 DL-01, 6.359 DL-06 RE35685		50 005 229 NEW

J





**Series 3120****32**1968 → 1973
Reference6.329 DL-01
RE3568550 005 229
NEW**Series 3130****33**1973 →
Reference6.329 DL-03, 6.329 DL-11
RE3568550 005 229
NEW**Series 3135****34**1973 →
Reference6.329 DL-03
RE3568550 005 229
NEW**Series 3140****35**09.1979→10.1986
Reference6.329 DL-03, 6.359 DL-03, 6.359 DL-04
RE3568550 005 229
NEW**Series 3210****36**01.1998→
Reference4.039 DRT
RE3568550 005 229
NEW**Series 3310****37**01.1998→
Reference4.045 D
AR7946350 005 230
NEW**Series 4030****38**1973 →
Reference6.329 DL-03
RE3568550 005 229
NEW**Series 4040****39**→
Reference6.359 T
AR7946350 005 230
NEW**J**



				
→ Reference	6.359 T RE35685		50 005 229 NEW	
Series 6100				40
1992 → Reference	4.045 D AR79463		50 005 230 NEW	
Series 6600				41
→ Reference	3.164 DL-03, 6.059 TL, 6.329 DL-03 RE35685		50 005 229 NEW	
Engine				42
→ Reference	4.239 A AR79463		50 005 230 NEW	
→ Reference	3.179 DL-07, 4.039 D, 4.039 T, 6.059 D, 6.059 T, 6.359 DL-02 RE35685		50 005 229 NEW	

J



			Cyl	 X mm	cm ³		Comp. Ratio ε	kW	PS	Pos
B1 (38 kW)	B		4	68 x 78,4	1138	2	9,7:1	38-41	52-56	4
B3 (54 kW)	B		4	71 x 83,6	1324	4	9,4:1	54	73	1, 5
B6 (60 kW)	B		4	78 x 83,6	1598	2	9,3:1	60	81	6
D4BH	D	(A)	4	91,1 x 95	2477	2	21:1	69-78	94-106	3
D4CB	D	(LA)	4	91 x 96	2497	4	19,3:1	103	140	7
D4EA (83 kW)	D	(LA)	4	83 x 92	1991	4	17,7:1	83	112	2, 11, 12
G4GD	B		4	76,5 x 87	1599	4	10:1	77	105	8
G4GF (105 kW)	B		4	82 x 93,5	1975	4	10,1:1	102-105	139-143	9, 10
NB7 (94 kW)	B		4	86 x 86	1998	4	9,2:1	94	128	9

K

**KIA****Avella 1.3i 16V****1**

03.1994→

B3 (54 kW)

**50 005 111**
NEW**Carens 2.0 CRD 16V****2**

04.2002→

D4EA (83 kW)

**50 005 096**
NEW**Pregio 2.5 TD****3**

08.2001→

D4BH

**50 005 124**
NEW**K****Pride 1.1****4**

01.1990→

B1 (38 kW)

**50 005 111**
NEW**Pride 1.3i 16V****5**

05.1994→

B3 (54 kW)

**50 005 111**
NEW**Sephia 1.6i****6**

01.1993→

B6 (60 kW)

**50 005 111**
NEW**Sorento 2.5 CRDi 16V****7**

07.2002→

D4CB

Reference

251004A000

M251004A000

**50 005 790****Cerato 1.6i 16V****8**

04.2004→

G4GD

**50 005 097**
NEW

**Sportage 2.0i 16V**

9

08.1993→
ReferenceNB7 (94 kW)
OFE3N-15-010E50 005 110
NEW

09.2004→

G4GF (105 kW)



50 005 903

Cerato 2.0i 16V

10

01.2003→

G4GF (105 kW)



50 005 903

Cerato 2.0 CRD 16V

11

01.2003→

D4EA (83 kW)

50 005 096
NEW

K

Sportage 2.0 CRDi 16V





12

09.2004→

D4EA (83 kW)

50 005 096
NEW

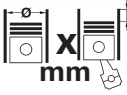

			Cyl	 mm	cm ³		Comp. Ratio ε	kW	PS	Pos
C 20 XE	B		4	86 x 86	1998	4	10,5:1	110	150	1
DW10 TD	D	(LA)	4	85 x 88	1997	2	17,6:1	66	90	2
TUD 5	D	(AN)	4	77 x 82	1527	2	23:1	40-42	54-57	3

L



110 2.0 i 16V

1

01.1996→

C 20 XE
14142840→



50 005 734

01.1996→

C 20 XE
→14142839



50 005 737

2123 2.0 TD

2

→

DW10 TD



50 005 329

Samara 1.5 D

3

01.1995→





TUD 5



50 005 339

L

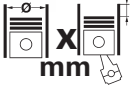

			Cyl	 mm	cm ³		Comp. Ratio ε	kW	PS	Pos
156 A2.000	B		4	70 x 64,9	999	2	9,5:1	32-37	44-50	13
156 A2.100	B		4	70 x 64,9	999	2	9:1	32	44	13
156 A2.146	B		4	70 x 64,9	999	2	9,5:1	33	45	14
156 A2.246	B		4	70 x 64,9	999	2	9,5:1	33	45	14
156 A2.256	B		4	70 x 64,9	999	2	9,5:1	33	45	14
156 C.046	B		4	70 x 72	1108	2		37-40	50-55	15
176 B2.000	B		4	70 x 72	1108	2	9,6:1	40	54	10
176 B9.000	B		4	70,8 x 78,9	1242	4	10,2:1	59-63	80-86	12
182 A4.000	B		4	86,4 x 67,4	1581	4	10,15:1	76	103	1, 2, 4
182 A6.000	B		4	86,4 x 67,4	1581	4	10,15:1	66-76	90-103	2
188 A5.000	B		4	70,8 x 78,9	1242	4	10,2:1	59-63	80-86	12, 16
188 A9.000	D	(LA)	4	69,6 x 82	1251	4	18:1	51	69	7, 17
840 A3.000	B		4	70,8 x 78,9	1242	2	9,8:1	44	60	11
838 A3.000	D	(LA)	5	82 x 90,4	2397	2	21:1	91	124	3
838 A7.000	D	(LA)	5	82 x 90,4	2397	2	21:1	91	125	3
839 A6.000	D	(LA)	5	82 x 90,4	2387	2	18:1	103	140	6
841G.000	D	(LA)	5	82 x 90,4	2387	4	18,45:1	120-129	163-175	9
AR 32302	D	(LA)	4	82 x 90,4	1910	2	18,45:1	76	103	5
AR 37101	D	(LA)	4	82 x 90,4	1910	2	18,45:1	77-85	105-115	5
DW10 BTED4	D	(LA)	4	85 x 88	1997	4	17,6:1	100	136	8
P8C	D	(LA)	4	85 x 92	2088	3	21,5:1	80-81	109-110	21
RFV	B		4	86 x 86	1998	4	10,4:1	97-100	132-136	20
RHM	D	(LA)	4	85 x 88	1997	4	17,6:1	80-81	109-110	8
RHR	D	(LA)	4	85 x 88	1997	4	18:1	100	136	8
RHT	D	(LA)	4	85 x 88	1997	4	17,3:1	80-81	109-110	8
RHW	D	(LA)	4	85 x 88	1997	4	18:1	80-81	109-110	8, 19
RHZ	D	(LA)	4	85 x 88	1997	2	17,6:1	80-81	109-110	18

L

**Dedra 1.6i 16V****1**

04.1998→10.1999

182 A4.000

Reference

46400058

46444355



50 005 780

Delta 1.6i 16V**2**

01.1996→12.1999

182 A4.000, 182 A6.000

Reference

46400058

46444355



50 005 780

Kappa 2.4 TD**3**

11.1994→03.1998

838 A3.000, 838 A7.000

Reference

46432248

46515970

46515972

59722248

60814609

60815559

0727391→



50 005 332

Lybra 1.6i 16V**4**

10.1999→09.2000

182 A4.000

Reference

46400058

46444355



50 005 780

Lybra 1.9 JTD**5**

10.1999→06.2001

AR 32302, AR 37101

Reference

46432248

46515970

46515972

59722248

60814609

60815559



50 005 332

Lybra 2.4 JTD**6**

01.2001→

839 A6.000

Reference

46432248

46515970

46515972

59722248

60814609

60815559



50 005 332

Musa 1.3 JTD 16V**7**

10.2004→

188 A9.000

Reference

46819138



50 005 760

Phedra 2.0 JTD 16V**8**

07.2006→

DW10 BTED4, RHR

Reference

9463623088



50 005 779



09.2002→ Reference	DW10 BTED4, RHM, RHR, RHT, RHW 9569342587 9569342587		50 005 824	
09.2002→05.2003 Reference	RHW 9569147388			50 005 329
Thesis 2.4 JTD 20V				9
06.2003→ Reference	841G.000 46804051			50 005 056 <small>NEW</small>
Y 1.1i				10
04.1997→06.2000 Reference	176 B2.000 46423351 46531183 5973713 7640163 7691820 7715242 →9042882			50 005 303
Y 1.2i				11
01.1996→06.2000 Reference	840 A3.000 46423351 46531183 5973713 7640163 7691820 7715242 →9042882			50 005 303
Y 1.2i 16V				12
04.1997→06.2003 Reference	176 B9.000, 188 A5.000 46520401 55184081			50 005 057 <small>NEW</small>
Y 10 1.0				13
03.1985→02.1992 Reference	156 A2.000, 156 A2.100 46423351 46531183 5973713 7640163 7691820 7715242			50 005 303
Y 10 1.0i				14
10.1987→02.1992 Reference	156 A2.146, 156 A2.246, 156 A2.256 46423351 46531183 5973713 7640163 7691820 7715242			50 005 303

L

**Y 10 1.1i****15**

07.1989→12.1995

156 C.046

Reference

46423351

46531183

5973713

7640163

7691820

7715242



50 005 303

Ypsilon 1.2i 16V**16**

06.2003→

188 A5.000

Reference

46520401

55184081



50 005 057

NEW

Ypsilon 1.3 JTD 16V**17**

06.2003→

188 A9.000

Reference

46819138



50 005 760

Zeta 2.0 JTD**18**

06.1999→10.2000

RHZ

Reference

9569342587

9569342587



50 005 824

06.1999→10.2000

RHZ

Reference

9569147388



50 005 329

Zeta 2.0 JTD 16V**19**

10.2000→06.2002

RHW

Reference

9569147388



50 005 329

Zeta 2.0i 16V**20**

06.1999→10.2000

RFV

Reference

9567205088

9567205088



50 005 854

Zeta 2.1 TD 12V**21**

05.1996→06.1999

P8C

Reference

9604708880

9629110980







50 005 322



			Cyl		mm	cm ³	Comp. Ratio ϵ	kW	PS	Pos
D 0824 LF 01	D	(LA)	4	108 x 125	4580	2	16,5:1	114	155	5, 9, 18, 32
D 0824 LF 02	D	(LA)	4	108 x 125	4580	2	16,5:1	118	160	19, 33
D 0826 LF 01	D	(LA)	6	108 x 125	6871	2	16,5:1	140	190	21, 35, 60, 67, 148
D 0826 LF 02	D	(LA)	6	108 x 125	6871	2	16,5:1	169	230	25, 39, 63, 70, 151, 513
D 0826 LF 04	D	(LA)	6	108 x 125	6871	2	16,5:1	198	270	27, 41, 66, 74, 155, 513
D 0826 LF 05	D	(LA)	6	108 x 125	6871	2	16,5:1	140	190	15, 21, 35, 60, 67, 148
D 0826 LF 06	D	(A)	6	108 x 125	6871	2	16,5:1	169	230	25, 39, 63, 70, 151, 513
D 0826 LF 07	D	(LA)	6	108 x 125	6871	2	16,5:1	140	190	15, 21, 35, 60, 67, 148
D 0826 LF 08	D	(LA)	6	108 x 125	6871	2	16,5:1	169	230	17, 25, 39, 63, 70, 151
D 0826 LF 09	D	(LA)	6	108 x 125	6871	2	16,5:1	169	230	513
D 0826 LF 11	D	(LA)	6	108 x 125	6871	2	18:1	162	220	23, 37, 62, 68, 150, 513
D 0826 LF 13	D	(LA)	6	108 x 125	6871	2	16,5:1	191	260	26, 40, 73, 154
D 0826 LF/217	D	(LA)	6	108 x 125	6871	2	18:1	160	217	39, 63, 151
D 0826 LFG 01	D	(LA)	6	108 x 125	6871	2	17:1	140	190	10, 70, 513
D 0826 LFG 02	D	(LA)	6	108 x 125	6871	2	16,5:1	140	190	10
D 0826 LFG 06	D	(LA)	6	108 x 125	6871	2	16,5:1	169	230	10, 70
D 0826 LFL 03	D	(LA)	6	108 x 125	6871	2	16,5:1	162	220	6, 7, 8, 11, 12, 24, 38, 46, 69
D 0826 LOH	D	(LA)	6	108 x 120	6596	2	17:1	169	230	30, 31, 409
D 0826 LOH 01	D	(LA)	6	108 x 125	6871	2	16,5:1	140	190	395, 408, 444
D 0826 LOH 02	D	(LA)	6	108 x 125	6871	2	16,5:1	140	190	2, 14, 513
D 0826 LOH 03	D	(LA)	6	108 x 125	6871	2	17:1	169	230	16, 22
D 0826 LOH 04	D	(LA)	6	108 x 125	6871	2	17:1	169	230	513
D 0826 LOH 05	D	(LA)	6	108 x 125	6871	2	17:1	160	218	1
D 0826 LOH 06	D	(LA)	6	108 x 125	6871	2	16,5:1	140	190	2, 4, 14, 340
D 0826 LOH 07	D	(LA)	6	108 x 125	6871	2	17:1	169	230	513
D 0826 LOH 08	D	(LA)	6	108 x 125	6871	2	17:1	198	269	513
D 2530 MF	D	(AN)	10	125 x 130	15945	2	17:1	156-235	212-320	57, 95, 98, 121, 133, 197, 249, 268, 308, 309
D 2530 MTXF	D	(A)	10	125 x 130	15945	2	17:1	265-294	360-400	102, 310
D 2530 MXF	D	(AN)	10	125 x 130	15945	2	17:1	235	320	57, 95, 121, 133, 197, 249, 268, 308
D 2530 MXFR	D	(AN)	10	125 x 130	15945	2	17:1	235	320	57, 95, 121, 133, 197, 249, 268, 308
D 2538 M	D	(AN)	8	125 x 130	12763	2	17:1	188	256	55, 86, 188, 243
D 2538 MF	D	(AN)	8	125 x 130	12763	2	17:1	188	256	55, 86, 188, 243
D 2538 MT	D	(A)	8	125 x 130	12763	2	17:1	178-235	242-320	57, 95, 197, 249
D 2555 M	D	(AN)	5	125 x 150	9199	2	17:1	124	168	13, 20, 28, 34, 48, 81
D 2555 MX	D	(AN)	5	125 x 150	9199	2	17:1	141	192	29, 43, 117
D 2556 M	D	(AN)	6	125 x 150	11045	2	17:1	147	200	44, 50, 83
D 2556 MF	D	(AN)	6	125 x 150	11045	2	17:1	141-147	192-200	29, 44, 50, 83, 125, 126, 241
D 2556 MX	D	(AN)	6	125 x 150	11045	2	17:1	177	241	47, 53, 84, 186, 242
D 2556 MXF	D	(AN)	6	125 x 150	11045	2	17:1	172-177	232-241	47, 52, 53, 84, 128, 186, 241, 242, 260
D 2565 M	D	(AN)	5	125 x 155	9510	2	17:1	124-141	168-192	13, 29, 35, 42, 43, 48, 49, 81, 117, 125
D 2565 MF	D	(AN)	5	125 x 155	9510	2	17:1	124-141	168-192	13, 20, 28, 29, 34, 35, 42, 43, 48, 49, 81, 82, 117, 125, 148
D 2565 MFR	D	(AN)	5	125 x 155	9510	2	17:1	141	192	29, 35, 43, 49, 125
D 2565 MR	D	(AN)	5	125 x 155	9510	2	17:1	141	192	29, 35, 43, 49, 125
D 2565 MUL	D	(AN)	5	125 x 155	9510	2	17:1	141	192	29, 35, 43, 49, 82
D 2566 M	D	(AN)	6	125 x 155	11407	2	17:1	125-177	170-240	47, 53, 64, 65, 71, 84, 128, 186, 242, 259, 260
D 2566 MF	D	(AN)	6	125 x 155	11407	2	17:1	162-177	220-240	36, 45, 47, 51, 52, 53, 61, 64, 84, 127, 128, 149, 152, 186, 241, 242, 260
D 2566 MFR	D	(AN)	6	125 x 155	11407	2	17:1	177	240	47, 53, 64, 84, 128, 152, 186, 242, 260
D 2566 MK	D	(LA)	6	125 x 155	11407	2	17:1	206-235	280-320	90, 96, 119, 130, 192, 198, 263, 269
D 2566 MKF	D	(LA)	6	125 x 155	11407	2	17:1	206-235	280-320	58, 90, 96, 119, 122, 130, 134, 192, 198, 245, 250, 263, 269, 284, 331
D 2566 MKUL	D	(LA)	6	125 x 155	11407	2	17:1	206-235	280-320	58, 96, 122, 134, 513
D 2566 MT	D	(A)	6	125 x 155	11407	2	17:1	206	280	89, 191, 262
D 2566 MTF	D	(A)	6	125 x 155	11407	2	17:1	206	280	56, 89, 118, 129, 191, 230, 244, 308
D 2566 MTFG	D	(A)	6	125 x 155	11407	2	17:1	206	280	118



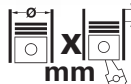

M



			Cyl		mm	cm ³		Comp. Ratio ε	kW	PS	Pos
D 2566 MTUH	D	(LA)	6	125 x 155	11407	2	17:1	206-235	280-320	430, 431, 435, 438, 446, 448, 452	
D 2566 MUH	D	(AN)	6	125 x 155	11407	2		129-177	175-240	432, 434, 435, 436, 441, 445, 452, 453	
D 2566 MXF	D	(AN)	6	125 x 155	11407	2		177	241	47, 53, 84, 186, 242, 260	
D 2566 UH	D	(AN)	6	125 x 155	11407	2	17:1	147-150	200-210	433, 441, 443, 452	
D 2840 L	D	(LA)	10	128 x 142	18273	2	17:1	329-467	447-635	513	
D 2840 LF 01	D	(LA)	10	128 x 142	18273	2	17,1:1	368	500	115, 182, 185, 214, 228, 297, 315	
D 2840 LF 04	D	(LA)	10	128 x 142	18273	2	15,9:1	368	500	115, 185, 214, 228, 297, 315	
D 2840 LF 06	D	(LA)	10	128 x 142	18273	2	16:1	368	500	115, 214, 228, 297, 315	
D 2840 LF 20	D	(LA)	10	128 x 142	18273	2	17:1	441-443	600-603	116, 215, 229, 298, 316, 327, 338	
D 2840 LF/500	D	(LA)	10	128 x 142	18273	2	15,9:1	368	500	114, 115, 182, 214	
D 2865 LF	D	(LA)	5	128 x 155	9972	2	15,5:1	198	269	87, 154, 189, 261, 281, 299, 317	
D 2865 LF 21	D	(LA)	5	128 x 155	9972	2	17:1	250	340	101, 141, 165, 203, 220, 233, 252, 272, 288, 302, 320	
D 2865 LF 22	D	(LA)	5	128 x 155	9972	2	16:1	198	270	88, 156, 190, 216	
D 2865 LF 23	D	(LA)	5	128 x 155	9972	2	16:1	235	320	95, 97, 162, 200, 219, 285	
D 2865 LF 24	D	(LA)	5	128 x 155	9972	2	18:1	213	290	93, 139, 159, 195, 217, 231, 247, 266, 283	
D 2865 LU 01	D	(LA)	5	128 x 155	9972	2	17:1	198	270	41	
D 2865 LU 03	D	(LA)	5	128 x 155	9972	2	16:1	235	320	199	
D 2865 LUH 02	D	(LA)	5	128 x 155	9972	2		198	270	454, 507	
D 2865 LUH 03	D	(LA)	5	128 x 155	9972	2		235	320	513	
D 2865 LUH 05	D	(LA)	5	128 x 155	9972	2		198	270	507	
D 2866 F	D	(AN)	6	128 x 155	11967	2	17,5:1	185	252	54, 85, 153, 187, 280	
D 2866 KF	D	(LA)	6	128 x 155	11967	2	15:1	274	373	104, 124, 137, 138, 169, 205, 289, 344	
D 2866 KFZ	D	(LA)	6	128 x 155	11967	2	15:1	243-265	330-360	103, 168, 204, 253, 273, 274, 321	
D 2866 KUH	D	(LA)	6	128 x 155	11967	2	15:1	265	360	343, 381, 385, 390, 450, 451	
D 2866 KUL	D	(LA)	6	128 x 155	11967	2	15:1	243-265	330-360	103, 137, 138, 168, 169, 344, 450	
D 2866 LF	D	(LA)	6	128 x 155	11967	2	15:1	213-260	290-353	92, 100, 132, 136, 158, 164, 194, 202, 265, 271, 282, 287, 318, 319, 330, 333	
D 2866 LF 20	D	(LA)	6	128 x 155	11967	2	17:1	294	400	108, 144, 174, 208, 223, 235, 255, 276, 292, 304, 311, 323, 334	
D 2866 LF 21	D	(LA)	6	128 x 155	11967	2	16:1	272	370	107, 172, 207, 222, 291	
D 2866 LF 22	D	(LA)	6	128 x 155	11967	2	16:1	309	420	111, 178, 211, 225, 294	
D 2866 LF 23	D	(LA)	6	128 x 155	11967	4	19:1	228	310	161, 196, 345, 349, 353, 360, 367, 480	
D 2866 LF 24	D	(LA)	6	128 x 155	11967	4	19:1	265	360	346, 350, 354, 357, 361, 364, 368, 371, 493	
D 2866 LF 25	D	(LA)	6	128 x 155	11967	4	19:1	301	410	347, 351, 355, 358, 362, 365, 369, 372, 374, 376, 502, 513	
D 2866 LF 26	D	(LA)	6	128 x 155	11967	4	19:1	228	310	460, 470, 475, 480, 481, 489	
D 2866 LF 27	D	(LA)	6	128 x 155	11967	4	19:1	265	360	254, 461, 466, 471, 476, 482, 485, 490, 493, 494, 499	
D 2866 LF 28	D	(LA)	6	128 x 155	11967	4	19:1	301	410	462, 467, 472, 477, 483, 486, 491, 495, 497, 500, 502, 513	
D 2866 LF 29	D	(LA)	6	128 x 155	11967	2		294	400	513	
D 2866 LF 30	D	(LA)	6	128 x 155	11967	2	17:1	301	410	513	
D 2866 LF 31	D	(LA)	6	128 x 155	11967	4	17:1	301	410	109, 145, 176, 209, 224, 236, 239, 256, 277, 293, 305, 312, 324, 328, 335, 502, 513	
D 2866 LF 32	D	(LA)	6	128 x 155	11967	4	19:1	301	410	502	
D 2866 LF 34	D	(LA)	6	128 x 155	11967	2	17:1	228	310	94, 140, 161, 196, 218, 232, 248, 267, 480, 513	



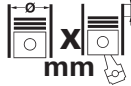

M



			Cyl		cm ³		Comp. Ratio ε	kW	PS	Pos
D 2866 LF 35	D	(LA)	6	128 x 155	11967	2	17:1	265	360	105, 142, 170, 206, 221, 234, 252, 254, 275, 290, 303, 322, 493, 513
D 2866 LF 36	D	(LA)	6	128 x 155	11967	4	17:1	228	310	480, 513
D 2866 LF 37	D	(LA)	6	128 x 155	11967	4	19:1	265	360	493, 513
D 2866 LF 39	D	(LA)	6	128 x 155	11967	4	19:1	265	360	513
D 2866 LF 40	D	(LA)	6	128 x 155	11967	4		301	409	513
D 2866 LF 41	D	(LA)	6	128 x 155	11967	4		301	409	513
D 2866 LF 43	D	(LA)	6	128 x 155	11967	4		265	360	513
D 2866 LFZ/290	D	(LA)	6	128 x 155	11967	2	15:1	213	290	91, 120, 131, 157, 193, 246, 264, 300
D 2866 LFZ/330	D	(LA)	6	128 x 155	11967	2	15:1	243	330	99, 123, 135, 163, 201, 251, 270, 286, 301, 332
D 2866 LFZR	D	(LA)	6	128 x 155	11967	4	15:1	213-243	290-330	513
D 2866 LOH 20	D	(LA)	6	128 x 155	11967	2	16:1	309	420	383
D 2866 LOH 21	D	(LA)	6	128 x 155	11967	2	16:1	309	420	383
D 2866 LOH 22	D	(LA)	6	128 x 155	11967	2	16:1	272	370	59
D 2866 LOH 23	D	(LA)	6	128 x 155	11967	2	16:1	294	400	78, 173, 382, 420, 421
D 2866 LOH 24	D	(LA)	6	128 x 155	11967	2	16:1	230	313	75
D 2866 LOH 25	D	(LA)	6	128 x 155	11967	2	16:1	228	310	75, 160
D 2866 LOH 26	D	(LA)	6	128 x 155	11967	2	16:1	257	350	76, 166, 380, 382, 418, 419
D 2866 LOH 27	D	(LA)	6	128 x 155	11967	4	17,1:1	228	310	75, 160
D 2866 LOH 28	D	(LA)	6	128 x 155	11967	4	17,1:1	265	360	77, 167
D 2866 LOH 29	D	(LA)	6	128 x 155	11967	4	18:1	301	410	79, 175
D 2866 LOH 30	D	(LA)	6	128 x 155	11967	4	18:1	294	400	513
D 2866 LOH 31	D	(LA)	6	128 x 155	11967	2	18:1	191	260	72
D 2866 LOH 34	D	(LA)	6	128 x 155	11967	4	18:1	301	410	386, 422, 425
D 2866 LOH 35	D	(LA)	6	128 x 155	11967	4	18:1	191	260	72
D 2866 LU	D	(LA)	6	128 x 155	11967	2	15:1	243	330	135
D 2866 LU 01	D	(LA)	6	128 x 155	11967	2	15:1	272	370	143, 183
D 2866 LU 03	D	(LA)	6	128 x 155	11967	2	16:1	272	370	106, 171
D 2866 LU 04	D	(LA)	6	128 x 155	11967	2	16:1	309	420	110, 177, 184, 210
D 2866 LUH	D	(LA)	6	128 x 155	11967	2	17:1	243	330	342, 384, 389, 449
D 2866 LUH 20	D	(LA)	6	128 x 155	11967	2	18:1	228	310	391, 427, 509
D 2866 LUH 21	D	(LA)	6	128 x 155	11967	2	16:1	257	330	380, 399, 400, 406, 412, 413, 417, 428, 510
D 2866 LUH 22	D	(LA)	6	128 x 155	11967	2	16:1	191	260	72, 339, 393, 394, 403, 404, 411
D 2866 LUH 23	D	(LA)	6	128 x 155	11967	4	18:1	191	260	72, 394, 404, 411, 437
D 2866 LUH 24	D	(LA)	6	128 x 155	11967	4	18:1	228	310	75, 397, 405, 412, 437, 440, 455, 509
D 2866 LUH 25	D	(LA)	6	128 x 155	11967	4	18:1	265	360	398, 400, 407, 414, 456, 457, 511, 512
D 2866 LUH 26	D	(LA)	6	128 x 155	11967	2	16:1	228	310	75, 396, 397, 405, 412, 416, 455, 509
D 2866 LUH 27	D	(LA)	6	128 x 155	11967	4	19:1	191	260	513
D 2866 LUH 28	D	(LA)	6	128 x 155	11967	4	19:1	228	310	3
D 2866 LUH 30	D	(LA)	6	128 x 155	11967	4	16:1	301	410	421
D 2866 LUL/330	D	(LA)	6	128 x 155	11967	2	15:1	243	330	99, 100, 136, 163, 164
D 2866 LXUH	D	(LA)	6	128 x 155	11967	2	15:1	272	370	505
D 2866 TUH	D	(A)	6	128 x 155	11967	2	15:1	213	290	341, 378, 379, 388, 415, 435, 436, 439, 447, 452
D 2866 TUH 01	D	(LA)	6	128 x 155	11967	2	15:1	222	302	508
D 2866 UH	D	(AN)	6	128 x 155	11967	2	17,5:1	180	245	429, 435, 436, 441, 443, 452, 453, 506
D 2866 UM	D	(AN)	6	128 x 155	11967	2	17,5:1	152	207	513
D 2876 LF 01	D	(LA)	6	128 x 166	12817	4	17:1	338	460	513
D 2876 LF 02	D	(LA)	6	128 x 166	12816	2	17:1	320-338	435-460	112, 146, 180, 212, 226, 237, 257, 278, 295, 296, 306, 313, 325, 336, 337
D 2876 LF 03	D	(LA)	6	128 x 166	12816	4	17:1	320-338	435-460	348, 352, 356, 359, 363, 366, 370, 373, 375, 377, 503
D 2876 LF 04	D	(LA)	6	128 x 166	12816	4	17:1	338	460	458, 463, 468, 473, 478, 484, 487, 492, 496, 501, 503
D 2876 LF 05	D	(LA)	6	128 x 166	12816	4	17:1	375	510	459, 464, 469, 474, 479, 488, 504

M

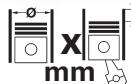

			Cyl		cm ³		Comp. Ratio ε	kW	PS	Pos
D 2876 LF 06	D	(LA)	6	128 x 166	12816	4	17:1	321-338	436-460	113, 147, 181, 213, 227, 238, 240, 258, 279, 296, 307, 314, 326, 329, 337
D 2876 LF 07	D	(LA)	6	128 x 166	12816	4	17:1	338	460	463, 465, 473, 487, 498, 501, 503
D 2876 LF 08	D	(LA)	6	128 x 166	12816	4	17:1	301	409	513
D 2876 LF 09	D	(LA)	6	128 x 166	12816	4	17:1	338	460	513
D 2876 LF 10	D	(LA)	6	128 x 166	12816	4	17:1	338	460	513
D 2876 LF 11	D	(LA)	6	128 x 166	12816	4	17:1	338	460	513
D 2876 LF 14	D	(LA)	6	128 x 166	12816	4	18:1	338	460	513
D 2876 LF 17	D	(LA)	6	128 x 166	12816	4	18:1	390	530	513
D 2876 LF 20	D	(LA)	6	128 x 166	12816	4	17:1			513
D 2876 LOH 01	D	(LA)	6	128 x 166	12816	2		338	460	179, 423, 513
D 2876 LOH 02	D	(LA)	6	128 x 166	12816	2	17:1	338	460	77, 80, 179, 513
D 2876 LOH 03	D	(LA)	6	128 x 166	12816	4	17:1	338	460	387, 424, 426
D 2876 LOH 05	D	(LA)	6	128 x 166	12816	2	17:1	301	409	175
D 2876 LUH 01	D	(LA)	6	128 x 166	12816	2		294	400	513
D 2876 LUH 02	D	(LA)	6	128 x 166	12816	2		316	430	513
E 2866 DUH 01	G	(AN)	6	128 x 155	11967	2	11:1	170	231	392, 401, 443
E 2866 DUH 02	G	(AN)	6	128 x 155	11967	2	11:1	170	231	402, 410, 442



MAN



Alé

1

01.1999→01.2000

D 0826 LOH 05

Reference

51.06500.6495



Flügelrad Durchmesser 135 mm
impeller diameter 135 mm
roue à ailettes 135 mm
roueda con paletas 135 mm
Лопастное колесо диаметр 135 мм



50 005 630

01.1999→01.2000

D 0826 LOH 05

Reference

51.06500.6476



Flügelrad Durchmesser 125 mm
impeller diameter 125 mm
roue à ailettes 125 mm
roueda con paletas 135 mm
Лопастное колесо диаметр 125 мм



50 005 631

Arena 8.5

2

04.1992→

D 0826 LOH 02, LOH 06

Reference

51.06500.6495



Flügelrad Durchmesser 135 mm
impeller diameter 135 mm
roue à ailettes 135 mm
roueda con paletas 135 mm
Лопастное колесо диаметр 135 мм



50 005 630

04.1992→

D 0826 LOH 02, LOH 06

Reference

51.06500.6476



Flügelrad Durchmesser 125 mm
impeller diameter 125 mm
roue à ailettes 125 mm
roueda con paletas 135 mm
Лопастное колесо диаметр 125 мм



50 005 631

Lion's Regio

3

08.1999→

D 2866 LUH 28

Reference

51.05100.6250 51.05100.6252 51.05100.6260 51.05100.6262



50 005 870

Midi Beta

4

03.1993→09.1995

D 0826 LOH 06

Reference

51.06500.6495



Flügelrad Durchmesser 135 mm
impeller diameter 135 mm
roue à ailettes 135 mm
roueda con paletas 135 mm
Лопастное колесо диаметр 135 мм



50 005 630

03.1993→09.1995

D 0826 LOH 06

Reference

51.06500.6476



Flügelrad Durchmesser 125 mm
impeller diameter 125 mm
roue à ailettes 125 mm
roueda con paletas 135 mm
Лопастное колесо диаметр 125 мм



50 005 631

Series 7.153

5

05.1994→06.1996

D 0824 LF 01

Reference

51.06500.6476



Flügelrad Durchmesser 125 mm
impeller diameter 125 mm
roue à ailettes 125 mm
roueda con paletas 135 mm
Лопастное колесо диаметр 125 мм



50 005 631

M

**Series 8.220****6**

04.1995→02.2001

D 0826 LFL 03

Reference

51.06500.6476



Flügelrad Durchmesser 125 mm
 impeller diameter 125 mm
 roue à ailettes 125 mm
 roueda con paletas 135 mm
 Лопастное колесо диаметр 125 мм



50 005 631

Series 8.224**7**

05.1994→09.2001

D 0826 LFL 03

Reference

51.06500.6476



Flügelrad Durchmesser 125 mm
 impeller diameter 125 mm
 roue à ailettes 125 mm
 roueda con paletas 135 mm
 Лопастное колесо диаметр 125 мм



50 005 631

Series 9.224**8**

05.1994→09.2001

D 0826 LFL 03

Reference

51.06500.6476



Flügelrad Durchmesser 125 mm
 impeller diameter 125 mm
 roue à ailettes 125 mm
 roueda con paletas 135 mm
 Лопастное колесо диаметр 125 мм



50 005 631

Series 10.153**9**

10.1993→06.1996

D 0824 LF 01

Reference

51.06500.6476



Flügelrad Durchmesser 125 mm
 impeller diameter 125 mm
 roue à ailettes 125 mm
 roueda con paletas 135 mm
 Лопастное колесо диаметр 125 мм



50 005 631

Series 10.190**10**

06.1990→03.1996

D 0826 LFG 01, LFG 02, LFG 06

Reference

51.06500.6476



Flügelrad Durchmesser 125 mm
 impeller diameter 125 mm
 roue à ailettes 125 mm
 roueda con paletas 135 mm
 Лопастное колесо диаметр 125 мм



50 005 631

Series 10.220**11**

02.1995→02.2001

D 0826 LFL 03

Reference

51.06500.6476



Flügelrad Durchmesser 125 mm
 impeller diameter 125 mm
 roue à ailettes 125 mm
 roueda con paletas 135 mm
 Лопастное колесо диаметр 125 мм



50 005 631

Series 10.224**12**

05.1994→09.2001

D 0826 LFL 03

Reference

51.06500.6476



Flügelrad Durchmesser 125 mm
 impeller diameter 125 mm
 roue à ailettes 125 mm
 roueda con paletas 135 mm
 Лопастное колесо диаметр 125 мм



50 005 631

Series 11.168**13**

01.1974→1981

D 2555 M





















Reference

51.05100.6249 51.05100.6250



50 005 833























				
10.1976→1985 Reference 	D 2565 M, MF 51.06500.6282 51.06500.6387 51.06500.9282 51.06500.9387 413 5021→			50 005 210
Series 11.190				14
04.1992→09.1996 Reference 	D 0826 LOH 02, LOH 06 51.06500.6495 Flügelrad Durchmesser 135 mm impeller diameter 135 mm roue à ailettes 135 mm roueda con paletas 135 mm Лопастное колесо диаметр 135 мм			50 005 630
04.1992→09.1996 Reference 	D 0826 LOH 02, LOH 06 51.06500.6476 Flügelrad Durchmesser 125 mm impeller diameter 125 mm roue à ailettes 125 mm roueda con paletas 135 mm Лопастное колесо диаметр 125 мм			50 005 631
Series 11.192				15
10.1992→06.1996 Reference 	D 0826 LF 05, LF 07 51.06500.6495 Flügelrad Durchmesser 135 mm impeller diameter 135 mm roue à ailettes 135 mm roueda con paletas 135 mm Лопастное колесо диаметр 135 мм			50 005 630
10.1992→06.1996 Reference 	D 0826 LF 05, LF 07 51.06500.6476 Flügelrad Durchmesser 125 mm impeller diameter 125 mm roue à ailettes 125 mm roueda con paletas 135 mm Лопастное колесо диаметр 125 мм			50 005 631
Series 11.230				16
04.1993→09.1996 Reference 	D 0826 LOH 03 51.06500.6495 Flügelrad Durchmesser 135 mm impeller diameter 135 mm roue à ailettes 135 mm roueda con paletas 135 mm Лопастное колесо диаметр 135 мм			50 005 630
04.1993→09.1996 Reference 	D 0826 LOH 03 51.06500.6476 Flügelrad Durchmesser 125 mm impeller diameter 125 mm roue à ailettes 125 mm roueda con paletas 135 mm Лопастное колесо диаметр 125 мм			50 005 631
Series 11.232				17
05.1994→06.1996 Reference 	D 0826 LF 08 51.06500.6495 Flügelrad Durchmesser 135 mm impeller diameter 135 mm roue à ailettes 135 mm roueda con paletas 135 mm Лопастное колесо диаметр 135 мм			50 005 630



05.1994→06.1996 Reference 	D 0826 LF 08 51.06500.6476 Flügelrad Durchmesser 125 mm impeller diameter 125 mm roue à ailettes 125 mm roueda con paletas 135 mm Лопастное колесо диаметр 125 мм				50 005 631
Series 12.152					18
05.1994→06.1996 Reference 	D 0824 LF 01 51.06500.6476 Flügelrad Durchmesser 125 mm impeller diameter 125 mm roue à ailettes 125 mm roueda con paletas 135 mm Лопастное колесо диаметр 125 мм				50 005 631
Series 12.162					19
08.1995→06.1996 Reference 	D 0824 LF 02 51.06500.6476 Flügelrad Durchmesser 125 mm impeller diameter 125 mm roue à ailettes 125 mm roueda con paletas 135 mm Лопастное колесо диаметр 125 мм				50 005 631
Series 12.168					20
01.1974→1981 Reference	D 2555 M 51.05100.6249 51.05100.6250			50 005 833	
10.1976→12.1984 Reference 	D 2565 MF 51.06500.6282 51.06500.6387 51.06500.9282 51.06500.9387 413 5021→				50 005 210
Series 12.192					21
07.1990→06.1996 Reference 	D 0826 LF 01, LF 05, LF 07 51.06500.6495 Flügelrad Durchmesser 135 mm impeller diameter 135 mm roue à ailettes 135 mm roueda con paletas 135 mm Лопастное колесо диаметр 135 мм				50 005 630
07.1990→06.1996 Reference 	D 0826 LF 01, LF 05, LF 07 51.06500.6476 Flügelrad Durchmesser 125 mm impeller diameter 125 mm roue à ailettes 125 mm roueda con paletas 135 mm Лопастное колесо диаметр 125 мм				50 005 631
Series 12.220					22
04.1999→ Reference 	D 0826 LOH 03 51.06500.6495 Flügelrad Durchmesser 135 mm impeller diameter 135 mm roue à ailettes 135 mm roueda con paletas 135 mm Лопастное колесо диаметр 135 мм				50 005 630

M



				
04.1999→ Reference 	D 0826 LOH 03 51.06500.6476 Flügelrad Durchmesser 125 mm impeller diameter 125 mm roue à ailettes 125 mm roueda con paletas 135 mm Лопастное колесо диаметр 125 мм			50 005 631
Series 12.222				23
05.1994→06.1996 Reference 	D 0826 LF 11 51.06500.6495 Flügelrad Durchmesser 135 mm impeller diameter 135 mm roue à ailettes 135 mm roueda con paletas 135 mm Лопастное колесо диаметр 135 мм			50 005 630
05.1994→06.1996 Reference 	D 0826 LF 11 51.06500.6476 Flügelrad Durchmesser 125 mm impeller diameter 125 mm roue à ailettes 125 mm roueda con paletas 135 mm Лопастное колесо диаметр 125 мм			50 005 631
Series 12.224				24
08.1995→03.1997 Reference 	D 0826 LFL 03 51.06500.6476 Flügelrad Durchmesser 125 mm impeller diameter 125 mm roue à ailettes 125 mm roueda con paletas 135 mm Лопастное колесо диаметр 125 мм			50 005 631
Series 12.232				25
08.1988→06.1996 Reference 	D 0826 LF 02, LF 06, LF 08 51.06500.6495 Flügelrad Durchmesser 135 mm impeller diameter 135 mm roue à ailettes 135 mm roueda con paletas 135 mm Лопастное колесо диаметр 135 мм			50 005 630
08.1988→06.1996 Reference 	D 0826 LF 02, LF 06, LF 08 51.06500.6476 Flügelrad Durchmesser 125 mm impeller diameter 125 mm roue à ailettes 125 mm roueda con paletas 135 mm Лопастное колесо диаметр 125 мм			50 005 631
Series 12.262				26
08.1995→06.1996 Reference 	D 0826 LF 13 51.06500.6495 Flügelrad Durchmesser 135 mm impeller diameter 135 mm roue à ailettes 135 mm roueda con paletas 135 mm Лопастное колесо диаметр 135 мм			50 005 630
08.1995→06.1996 Reference 	D 0826 LF 13 51.06500.6476 Flügelrad Durchmesser 125 mm impeller diameter 125 mm roue à ailettes 125 mm roueda con paletas 135 mm Лопастное колесо диаметр 125 мм			50 005 631





Series 12.272

27

06.1993→06.1996	D 0826 LF 04								
Reference	51.06500.6495								50 005 630
	Flügelrad Durchmesser 135 mm impeller diameter 135 mm roue à ailettes 135 mm roueda con paletas 135 mm Лопастное колесо диаметр 135 мм								
06.1993→06.1996	D 0826 LF 04								
Reference	51.06500.6476								50 005 631
	Flügelrad Durchmesser 125 mm impeller diameter 125 mm roue à ailettes 125 mm roueda con paletas 125 mm Лопастное колесо диаметр 125 мм								

Series 13.168

28

10.1973→03.1977	D 2555 M								
Reference	51.05100.6249 51.05100.6250							50 005 833	
12.1976→12.1984	D 2565 MF								
Reference	51.06500.6282 51.06500.6387 51.06500.9282 51.06500.9387 413 5021→								50 005 210



Series 13.192

29

1978 →1984	D 2565 MUL								
Reference	51.05100.6135							50 005 828	
	ohne Antriebsrad, without impeller, sans roue motrice, sin rueda motriz, без ведущего колеса								
05.1974→12.1974 05.1974→12.1976	D 2555 MX D 2556 MF								
Reference	51.05100.6249 51.05100.6250							50 005 833	
1978 →1984	D 2565 MUL								
Reference	51.05100.6134 51.05100.6155							50 005 827	
	mit Antriebsrad, with impeller, avec roue motrice, con rueda motriz, с приводным колесом								
1976 →12.1984	D 2565 M, MF, MFR, MR								
Reference	51.06500.6282 51.06500.6387 51.06500.9282 51.06500.9387 413 5021→								50 005 210

Series 13.220

30

11.1995→07.1998	D 0826 LOH								
Reference	51.06500.6495								50 005 630
	Flügelrad Durchmesser 135 mm impeller diameter 135 mm roue à ailettes 135 mm roueda con paletas 135 mm Лопастное колесо диаметр 135 мм								
11.1995→07.1998	D 0826 LOH								
Reference	51.06500.6476								50 005 631
	Flügelrad Durchmesser 125 mm impeller diameter 125 mm roue à ailettes 125 mm roueda con paletas 125 mm Лопастное колесо диаметр 125 мм								

**MAN****Series 13.230****31**

11.1995→09.2001	D 0826 LOH				
Reference	51.06500.6495				
	Flügelrad Durchmesser 135 mm impeller diameter 135 mm roue à ailettes 135 mm roueda con paletas 135 mm Лопастное колесо диаметр 135 мм				50 005 630
11.1995→09.2001	D 0826 LOH				
Reference	51.06500.6476				
	Flügelrad Durchmesser 125 mm impeller diameter 125 mm roue à ailettes 125 mm roueda con paletas 135 mm Лопастное колесо диаметр 125 мм				50 005 631

Series 14.152**32**

05.1994→06.1996	D 0824 LF 01				
Reference	51.06500.6476				
	Flügelrad Durchmesser 125 mm impeller diameter 125 mm roue à ailettes 125 mm roueda con paletas 135 mm Лопастное колесо диаметр 125 мм				50 005 631

Series 14.162**33**

08.1995→06.1996	D 0824 LF 02				
Reference	51.06500.6476				
	Flügelrad Durchmesser 125 mm impeller diameter 125 mm roue à ailettes 125 mm roueda con paletas 135 mm Лопастное колесо диаметр 125 мм				50 005 631

Series 14.168**34**

01.1974→1981	D 2555 M				
Reference	51.05100.6249 51.05100.6250				
				50 005 833	
12.1976→12.1984	D 2565 MF				
Reference	51.06500.6282 51.06500.6387 51.06500.9282 51.06500.9387 413 5021→				
					50 005 210

Series 14.192**35**

07.1990→06.1996	D 0826 LF 01, LF 05, LF 07				
Reference	51.06500.6495				
	Flügelrad Durchmesser 135 mm impeller diameter 135 mm roue à ailettes 135 mm roueda con paletas 135 mm Лопастное колесо диаметр 135 мм				50 005 630
06.1975→07.1989	D 2565 MUL				
Reference	51.05100.6135				
	ohne Antriebsrad, without impeller, sans roue motrice, sin rueda motriz, без ведущего колеса			50 005 828	
07.1990→06.1996	D 0826 LF 01, LF 05, LF 07				
Reference	51.06500.6476				
	Flügelrad Durchmesser 125 mm impeller diameter 125 mm roue à ailettes 125 mm roueda con paletas 135 mm Лопастное колесо диаметр 125 мм				50 005 631

























M























06.1975→07.1989 Reference 	D 2565 MUL 51.05100.6134 51.05100.6155 mit Antriebsrad, with impeller, avec roue motrice, con rueda motriz, с приводным колесом		50 005 827		
06.1975→07.1989 Reference 	D 2565 M, MF, MFR, MR 51.06500.6282 51.06500.6387 51.06500.9282 51.06500.9387 413 5021→				50 005 210
Series 14.220					36
10.1983→02.1989 Reference 	D 2566 MF 51.06500.6222 51.06500.6228 51.06500.9228 →409 1059				50 005 207
10.1983→02.1989 Reference 	D 2566 MF 51.06500.6282 51.06500.6387 51.06500.9282 51.06500.9387 409 1060→				50 005 210
Series 14.222					37
05.1994→06.1996 Reference 	D 0826 LF 11 51.06500.6495 Flügelrad Durchmesser 135 mm impeller diameter 135 mm roue à ailettes 135 mm roueda con paletas 135 mm Лопастное колесо диаметр 135 мм				50 005 630
05.1994→06.1996 Reference 	D 0826 LF 11 51.06500.6476 Flügelrad Durchmesser 125 mm impeller diameter 125 mm roue à ailettes 125 mm roueda con paletas 135 mm Лопастное колесо диаметр 125 мм				50 005 631
Series 14.224					38
08.1995→03.1997 Reference 	D 0826 LFL 03 51.06500.6476 Flügelrad Durchmesser 125 mm impeller diameter 125 mm roue à ailettes 125 mm roueda con paletas 135 mm Лопастное колесо диаметр 125 мм				50 005 631
Series 14.232					39
08.1988→06.1996 Reference 	D 0826 LF 02, LF 06, LF 08, LF/217 51.06500.6495 Flügelrad Durchmesser 135 mm impeller diameter 135 mm roue à ailettes 135 mm roueda con paletas 135 mm Лопастное колесо диаметр 135 мм				50 005 630
08.1988→06.1996 Reference 	D 0826 LF 02, LF 06, LF 08, LF/217 51.06500.6476 Flügelrad Durchmesser 125 mm impeller diameter 125 mm roue à ailettes 125 mm roueda con paletas 135 mm Лопастное колесо диаметр 125 мм				50 005 631



MAN























							
Series 14.262							40
08.1995→06.1996	D 0826 LF 13						
Reference	51.06500.6495						50 005 630
	Flügelrad Durchmesser 135 mm impeller diameter 135 mm roue à ailettes 135 mm roueda con paletas 135 mm Лопастное колесо диаметр 135 мм						
08.1995→06.1996	D 0826 LF 13						
Reference	51.06500.6476						50 005 631
	Flügelrad Durchmesser 125 mm impeller diameter 125 mm roue à ailettes 125 mm roueda con paletas 135 mm Лопастное колесо диаметр 125 мм						
Series 14.272							41
06.1993→06.1996	D 0826 LF 04						
Reference	51.06500.6495						50 005 630
	Flügelrad Durchmesser 135 mm impeller diameter 135 mm roue à ailettes 135 mm roueda con paletas 135 mm Лопастное колесо диаметр 135 мм						
05.1990→10.1993	D 2865 LU 01					50 005 828	
Reference	51.05100.6135						
	ohne Antriebsrad, without impeller, sans roue motrice, sin rueda motriz, без ведущего колеса						
06.1993→06.1996	D 0826 LF 04						50 005 631
Reference	51.06500.6476						
	Flügelrad Durchmesser 125 mm impeller diameter 125 mm roue à ailettes 125 mm roueda con paletas 135 mm Лопастное колесо диаметр 125 мм						
05.1990→10.1993	D 2865 LU 01					50 005 827	
Reference	51.05100.6134 51.05100.6155						
	mit Antriebsrad, with impeller, avec roue motrice, con rueda motriz, с приводным колесом						
Series 15.168							42
12.1976→02.1985	D 2565 M, MF						
Reference	51.06500.6282 51.06500.6387 51.06500.9282 51.06500.9387 413 5021→						50 005 210
							
Series 15.192							43
1978→1984	D 2565 MUL					50 005 828	
Reference	51.05100.6135						
	ohne Antriebsrad, without impeller, sans roue motrice, sin rueda motriz, без ведущего колеса						
10.1973→04.1977	D 2555 MX					50 005 833	
Reference	51.05100.6249 51.05100.6250						
							
1978→1984	D 2565 MUL					50 005 827	
Reference	51.05100.6134 51.05100.6155						
	mit Antriebsrad, with impeller, avec roue motrice, con rueda motriz, с приводным колесом						



						
1976 →02.1985 Reference 	D 2565 51.06500.6282 413 5021 →	M, MF, MFR, MR 51.06500.6387	51.06500.9282	51.06500.9387		50 005 210
Series 15.200						44
09.1973 →04.1978 Reference	D 2556 51.05100.6249	M, MF 51.05100.6250				50 005 833
09.1973 →04.1978 Reference	D 2556 51.06500.6222	M 51.06500.6228	51.06500.9228			50 005 207
Series 15.220						45
10.1983 →02.1989 Reference 	D 2566 51.06500.6222 →409 1059	MF 51.06500.6228	51.06500.9228			50 005 207
10.1983 →02.1989 Reference 	D 2566 51.06500.6282 409 1060 →	MF 51.06500.6387	51.06500.9282	51.06500.9387		50 005 210
Series 15.224						46
08.1995 →03.1997 Reference 	D 0826 51.06500.6476 Flügelrad Durchmesser 125 mm impeller diameter 125 mm roue à ailettes 125 mm roueda con paletas 135 mm Лопастное колесо диаметр 125 мм	LFL 03				50 005 631
Series 15.240						47
10.1976 →08.1988 Reference	D 2566 51.05100.6249	M, MXF 51.05100.6250				50 005 833
09.1973 →04.1978 10.1976 →08.1988 Reference 	D 2556 51.06500.6222	MX, MXF M, MF, MFR 51.06500.6228	51.06500.9228			50 005 207
10.1976 →08.1988 Reference 	D 2566 51.06500.6282 409 1060 →	M, MF, MFR 51.06500.6387	51.06500.9282	51.06500.9387		50 005 210
Series 16.168						48
01.1974 →02.1977 Reference	D 2555 51.05100.6249	M 51.05100.6250				50 005 833

M

**MAN**

				
12.1976→12.1986 Reference 	D 2565 M, MF 51.06500.6282 51.06500.6387 51.06500.9282 51.06500.9387 413 5021→			50 005 210
Series 16.192				49
1978→1984 Reference 	D 2565 MUL 51.05100.6135 ohne Antriebsrad, without impeller, sans roue motrice, sin rueda motriz, без ведущего колеса		50 005 828	
1978→1984 Reference 	D 2565 MUL 51.05100.6134 51.05100.6155 mit Antriebsrad, with impeller, avec roue motrice, con rueda motriz, с приводным колесом		50 005 827	
1976→12.1986 Reference 	D 2565 M, MF, MFR, MR 51.06500.6282 51.06500.6387 51.06500.9282 51.06500.9387 413 5021→			50 005 210
Series 16.200				50
09.1973→03.1977 Reference	D 2566 M, MF 51.05100.6249 51.05100.6250		50 005 833	
09.1973→02.1977 Reference	D 2566 M 51.06500.6222 51.06500.6228 51.06500.9228			50 005 207
Series 16.220				51
10.1983→11.1986 Reference 	D 2566 MF 51.06500.6222 51.06500.6228 51.06500.9228 →409 1059			50 005 207
10.1983→11.1986 Reference 	D 2566 MF 51.06500.6282 51.06500.6387 51.06500.9282 51.06500.9387 409 1060→			50 005 210
Series 16.232				52
01.1974→02.1978 03.1978→01.1983 Reference 	D 2566 MXF D 2566 MF 51.06500.6222 51.06500.6228 51.06500.9228 D 2566 MF: →409 1059			50 005 207
03.1978→01.1983 Reference 	D 2566 MF 51.06500.6282 51.06500.6387 51.06500.9282 51.06500.9387 409 1060→			50 005 210

M



Series 16.240

53

10.1976→11.1986 Reference	D 2566 51.05100.6249	M, MXF 51.05100.6250		50 005 833	
------------------------------	-------------------------	-------------------------	--	------------	--

09.1973→02.1977 10.1976→06.1989 Reference	D 2556 51.06500.6222	MX, MXF M, MF, MFR 51.06500.6228 51.06500.9228			50 005 207
	D 2566 M, D 2566 MF, D 2566 MFR: →409 1059				

10.1976→06.1989 Reference	D 2566 51.06500.6282	M, MF, MFR 51.06500.6387 51.06500.9282 51.06500.9387			50 005 210
	409 1060→				

Series 16.242

54

01.1988→02.1989 Reference	D 2866 51.05100.6249	F 51.05100.6250		50 005 833	
------------------------------	-------------------------	--------------------	--	------------	--

Series 16.256

55

08.1972→10.1977 Reference	D 2538 51.05100.6249	M, MF 51.05100.6250		50 005 833	
------------------------------	-------------------------	------------------------	--	------------	--

08.1972→10.1977 Reference	D 2538 51.06500.6222	M, MF 51.06500.6228 51.06500.9228			50 005 207
	200 1001→358 1000				

08.1972→10.1977 Reference	D 2538 51.06500.6282	M, MF 51.06500.6387 51.06500.9282 51.06500.9387			50 005 210
	358 1001→				

Series 16.280

56

01.1977→12.1986 Reference	D 2566 51.05100.6249	MTF 51.05100.6250		50 005 833	
------------------------------	-------------------------	----------------------	--	------------	--

01.1977→12.1986 Reference	D 2566 51.06500.6222	MTF 51.06500.6228 51.06500.9228			50 005 207
	→364 4048				

01.1977→12.1986 Reference	D 2566 51.06500.6282	MTF 51.06500.6387 51.06500.9282 51.06500.9387			50 005 210
	364 4049→				

M

**MAN****Series 16.320****57**

07.1972→10.1981 02.1973→10.1977 Reference	D 2530 MF D 2538 MT 51.05100.6249 51.05100.6250		50 005 833
07.1972→10.1981 Reference 	D 2530 MXF, MXFR 51.06500.6222 51.06500.6228 51.06500.9228 →335 8072		50 005 207
07.1972→10.1981 Reference 	D 2530 MXF, MXFR 51.06500.6282 51.06500.6387 51.06500.9282 51.06500.9387 335 8073→		50 005 210

Series 16.321**58**

06.1979→11.1985 Reference 	D 2566 MKUL 51.05100.6135 ohne Antriebsrad, without impeller, sans roue motrice, sin rueda motriz, без ведущего колеса		50 005 828
01.1980→11.1985 Reference	D 2566 MKF 51.05100.6249 51.05100.6250		50 005 833
06.1979→11.1985 Reference 	D 2566 MKUL 51.05100.6134 51.05100.6155 mit Antriebsrad, with impeller, avec roue motrice, con rueda motriz, с приводным колесом		50 005 827
06.1979→11.1985 Reference	D 2566 MKF, MKUL 51.06500.6282 51.06500.6387 51.06500.9282 51.06500.9387		50 005 210

Series 16.370**59**

11.1995→06.1997 Reference	D 2866 LOH 22 51.05100.6250 51.05100.6252 51.05100.6260 51.05100.6262		50 005 870
------------------------------	--	--	------------

Series 17.192**60**

07.1990→06.1996 Reference 	D 0826 LF 01, LF 05, LF 07 51.06500.6495 Flügelrad Durchmesser 135 mm impeller diameter 135 mm roue à ailettes 135 mm roueda con paletas 135 mm Лопастное колесо диаметр 135 мм		50 005 630
07.1990→06.1996 Reference 	D 0826 LF 01, LF 05, LF 07 51.06500.6476 Flügelrad Durchmesser 125 mm impeller diameter 125 mm roue à ailettes 125 mm roueda con paletas 135 mm Лопастное колесо диаметр 125 мм		50 005 631



Series 17.220

61

11.1986→07.1989	D 2566 MF						
Reference	51.06500.6222 51.06500.6228 51.06500.9228						50 005 207
	→409 1059						

11.1986→07.1989	D 2566 MF						
Reference	51.06500.6282 51.06500.6387 51.06500.9282 51.06500.9387						50 005 210
	409 1060→						

Series 17.222

62

05.1994→06.1996	D 0826 LF 11						
Reference	51.06500.6495						50 005 630
	Flügelrad Durchmesser 135 mm impeller diameter 135 mm roue à ailettes 135 mm roueda con paletas 135 mm Лопастное колесо диаметр 135 мм						

05.1994→06.1996	D 0826 LF 11						
Reference	51.06500.6476						50 005 631
	Flügelrad Durchmesser 125 mm impeller diameter 125 mm roue à ailettes 125 mm roueda con paletas 135 mm Лопастное колесо диаметр 125 мм						

Series 17.232

63

M

08.1988→06.1996	D 0826 LF 02, LF 06, LF 08, LF/217						
Reference	51.06500.6495						50 005 630
	Flügelrad Durchmesser 135 mm impeller diameter 135 mm roue à ailettes 135 mm roueda con paletas 135 mm Лопастное колесо диаметр 135 мм						

08.1988→06.1996	D 0826 LF 02, LF 06, LF 08, LF/217						
Reference	51.06500.6476						50 005 631
	Flügelrad Durchmesser 125 mm impeller diameter 125 mm roue à ailettes 125 mm roueda con paletas 135 mm Лопастное колесо диаметр 125 мм						

Series 17.240



64

11.1986→05.1990	D 2566 M					50 005 833	
Reference	51.05100.6249 51.05100.6250						

10.1976→05.1990	D 2566 M, MF, MFR						
Reference	51.06500.6222 51.06500.6228 51.06500.9228						50 005 207
	→409 1059						

10.1976→05.1990	D 2566 M, MF, MFR						
Reference	51.06500.6282 51.06500.6387 51.06500.9282 51.06500.9387						50 005 210
	409 1060→						



**MAN****Series 17.241****65**

05.1990→06.1991	D 2566	M			50 005 833	
Reference	51.05100.6249	51.05100.6250				
05.1990→06.1991	D 2566	M				50 005 207
Reference	51.06500.6222	51.06500.6228	51.06500.9228			
	→409 1059					
05.1990→06.1991	D 2566	M				50 005 210
Reference	51.06500.6282	51.06500.6387	51.06500.9282			
	409 1060→					



Series 17.272**66**

10.1992→05.1995	D 0826	LF 04				50 005 630
Reference	51.06500.6495					
	Flügelrad Durchmesser 135 mm					
	impeller diameter 135 mm					
	roue à ailettes 135 mm					
	roueda con paletas 135 mm					
	Лопастное колесо диаметр 135 мм					
10.1992→05.1995	D 0826	LF 04				50 005 631
Reference	51.06500.6476					
	Flügelrad Durchmesser 125 mm					
	impeller diameter 125 mm					
	roue à ailettes 125 mm					
	roueda con paletas 135 mm					
	Лопастное колесо диаметр 125 мм					

M**Series 18.192****67**

09.1990→06.1996	D 0826	LF 01, LF 05, LF 07				50 005 630
Reference	51.06500.6495					
	Flügelrad Durchmesser 135 mm					
	impeller diameter 135 mm					
	roue à ailettes 135 mm					
	roueda con paletas 135 mm					
	Лопастное колесо диаметр 135 мм					
09.1990→06.1996	D 0826	LF 01, LF 05, LF 07				50 005 631
Reference	51.06500.6476					
	Flügelrad Durchmesser 125 mm					
	impeller diameter 125 mm					
	roue à ailettes 125 mm					
	roueda con paletas 135 mm					
	Лопастное колесо диаметр 125 мм					

Series 18.222**68**

05.1994→06.1996	D 0826	LF 11				50 005 630
Reference	51.06500.6495					
	Flügelrad Durchmesser 135 mm					
	impeller diameter 135 mm					
	roue à ailettes 135 mm					
	roueda con paletas 135 mm					
	Лопастное колесо диаметр 135 мм					
05.1994→06.1996	D 0826	LF 11				50 005 631
Reference	51.06500.6476					
	Flügelrad Durchmesser 125 mm					
	impeller diameter 125 mm					
	roue à ailettes 125 mm					
	roueda con paletas 135 mm					
	Лопастное колесо диаметр 125 мм					

**Series 18.224****69**

08.1995→09.2001	D 0826 LFL 03								
Reference	51.06500.6476								
	Flügelrad Durchmesser 125 mm impeller diameter 125 mm roue à ailettes 125 mm roueda con paletas 135 mm Лопастное колесо диаметр 125 мм								50 005 631

Series 18.232**70**

09.1990→06.1996	D 0826 LF 02, LF 06, LF 08								
Reference	51.06500.6495								
	Flügelrad Durchmesser 135 mm impeller diameter 135 mm roue à ailettes 135 mm roueda con paletas 135 mm Лопастное колесо диаметр 135 мм								50 005 630
09.1990→	D 0826 LF 02, LF 06, LF 08, LFG 01, LFG 06								
Reference	51.06500.6476								
	Flügelrad Durchmesser 125 mm impeller diameter 125 mm roue à ailettes 125 mm roueda con paletas 135 mm Лопастное колесо диаметр 125 мм								50 005 631

Series 18.241**71**

09.1990→10.1993	D 2566 M								
Reference	51.05100.6249 51.05100.6250								50 005 833
09.1990→10.1993	D 2566 M								
Reference	51.06500.6222 51.06500.6228 51.06500.9228 →409 1059								50 005 207
09.1990→10.1993	D 2566 M								
Reference	51.06500.6282 51.06500.6387 51.06500.9282 51.06500.9387 409 1060→								50 005 210

Series 18.260**72**

















09.1996→	D 2866 LOH 31, LOH 35, LUH 22, LUH 23								
Reference	51.05100.6250 51.05100.6252 51.05100.6260 51.05100.6262								50 005 870

Series 18.262**73**

08.1995→06.1996	D 0826 LF 13								
Reference	51.06500.6495								
	Flügelrad Durchmesser 135 mm impeller diameter 135 mm roue à ailettes 135 mm roueda con paletas 135 mm Лопастное колесо диаметр 135 мм								50 005 630
08.1995→06.1996	D 0826 LF 13								
Reference	51.06500.6476								
	Flügelrad Durchmesser 125 mm impeller diameter 125 mm roue à ailettes 125 mm roueda con paletas 135 mm Лопастное колесо диаметр 125 мм								50 005 631



MAN

				
Series 18.272				74
06.1993→06.1996 Reference 	D 0826 LF 04 51.06500.6495 Flügelrad Durchmesser 135 mm impeller diameter 135 mm roue à ailettes 135 mm roueda con paletas 135 mm Лопастное колесо диаметр 135 мм			50 005 630
06.1993→06.1996 Reference 	D 0826 LF 04 51.06500.6476 Flügelrad Durchmesser 125 mm impeller diameter 125 mm roue à ailettes 125 mm roueda con paletas 135 mm Лопастное колесо диаметр 125 мм			50 005 631
Series 18.310				75
03.1995→ Reference	D 2866 LOH 24, LOH 25, LOH 27, LUH 24, LUH 26 51.05100.6250 51.05100.6252 51.05100.6260 51.05100.6262		50 005 870	
Series 18.350				76
09.1996→09.2001 Reference	D 2866 LOH 26 51.05100.6250 51.05100.6252 51.05100.6260 51.05100.6262		50 005 870	
Series 18.360				77
01.2001→ 01.1999→ Reference	D 2866 LOH 28 D 2876 LOH 02 51.05100.6250 51.05100.6252 51.05100.6260 51.05100.6262		50 005 870	
Series 18.400				78
01.2001→09.2001 Reference	D 2866 LOH 23 51.05100.6250 51.05100.6252 51.05100.6260 51.05100.6262		50 005 870	
Series 18.410				79
09.2002→ Reference	D 2866 LOH 29 51.05100.6250 51.05100.6252 51.05100.6260 51.05100.6262		50 005 870	
Series 18.460				80
01.2001→ Reference	D 2876 LOH 02 51.05100.6250 51.05100.6252 51.05100.6260 51.05100.6262		50 005 870	
Series 19.168				81
01.1974→02.1977 Reference	D 2555 M 51.05100.6249 51.05100.6250		50 005 833	
10.1976→12.1986 Reference 	D 2565 M, MF 51.06500.6282 51.06500.6387 51.06500.9282 51.06500.9387 413 5021→			50 005 210

M



Series 19.192

82

1978 →1984 Reference 	D 2565 MUL 51.05100.6135 ohne Antriebsrad, without impeller, sans roue motrice, sin rueda motriz, без ведущего колеса		50 005 828	
1978 →1984 Reference 	D 2565 MUL 51.05100.6134 51.05100.6155 mit Antriebsrad, with impeller, avec roue motrice, con rueda motriz, с приводным колесом		50 005 827	
04.1977→12.1986 Reference 	D 2565 MF 51.06500.6282 51.06500.6387 51.06500.9282 51.06500.9387 413 5021→			50 005 210

Series 19.200

83

09.1973→1981 Reference	D 2566 M, MF 51.05100.6249 51.05100.6250		50 005 833	
09.1973→1981 Reference	D 2566 M 51.06500.6222 51.06500.6228 51.06500.9228			50 005 207

Series 19.240

84

10.1976→01.1988 Reference	D 2566 M, MXF 51.05100.6249 51.05100.6250		50 005 833	
09.1973→05.1977 10.1976→02.1989 Reference 	D 2556 MX, MXF D 2566 M, MF, MFR 51.06500.6222 51.06500.6228 51.06500.9228 D 2566 M, D 2566 MF, D 2566 MFR: →409 1059			50 005 207
10.1976→02.1989 Reference 	D 2566 M, MF, MFR 51.06500.6282 51.06500.6387 51.06500.9282 51.06500.9387 409 1060→			50 005 210

Series 19.242

85



















01.1988→02.1989 Reference	D 2866 F 51.05100.6249 51.05100.6250		50 005 833	
------------------------------	---	--	------------	--

Series 19.256

86



















08.1972→10.1977 Reference	D 2538 M, MF 51.05100.6249 51.05100.6250		50 005 833	
08.1972→10.1977 Reference 	D 2538 M, MF 51.06500.6222 51.06500.6228 51.06500.9228 200 1001→358 1000			50 005 207

**MAN**

						
08.1972→10.1977 Reference 	D 2538 M, MF 51.06500.6282 51.06500.6387 51.06500.9282 51.06500.9387 358 1001→					50 005 210
Series 19.262						87
01.1988→02.1990 Reference	D 2865 LF 51.06500.6479					50 005 613
01.1988→02.1990 Reference	D 2865 LF 51.05100.6249 51.05100.6250					50 005 833
01.1988→02.1990 Reference	D 2865 LF 51.06500.6492					50 005 614
Series 19.273						88
01.1994→03.1997 Reference	D 2865 LF 22 51.05100.6250 51.05100.6252 51.05100.6260 51.05100.6262					50 005 870
Series 19.280						89
11.1976→11.1984 Reference	D 2566 MT, MTF 51.05100.6249 51.05100.6250					50 005 833
11.1976→11.1984 Reference 	D 2566 MT, MTF 51.06500.6222 51.06500.6228 51.06500.9228 →364 4048					50 005 207
11.1976→11.1984 Reference 	D 2566 MT, MTF 51.06500.6282 51.06500.6387 51.06500.9282 51.06500.9387 364 4049→					50 005 210
Series 19.281						90
01.1980→01.1988 Reference	D 2566 MK, MKF 51.05100.6249 51.05100.6250					50 005 833
01.1980→01.1988 Reference	D 2566 MK, MKF 51.06500.6282 51.06500.6387 51.06500.9282 51.06500.9387					50 005 210
Series 19.291						91
09.1985→08.1988 Reference	D 2866 LFZ/290 51.05100.6249 51.05100.6250					50 005 833

M





















				
Series 19.292				92
07.1986→02.1990 Reference	D 2866 LF 51.06500.6479			50 005 613
07.1986→02.1990 Reference	D 2866 LF 51.06500.6492			50 005 614
Series 19.293				93
04.1995→09.2001 Reference	D 2865 LF 24 51.05100.6250 51.05100.6252 51.05100.6260 51.05100.6262			50 005 870
Series 19.314				94
06.1998→12.2001 Reference	D 2866 LF 34 51.05100.6250 51.05100.6252 51.05100.6260 51.05100.6262			50 005 870
Series 19.320				95
01.1994→12.1995 Reference	D 2865 LF 23 51.05100.6250 51.05100.6252 51.05100.6260 51.05100.6262			50 005 870
07.1972→10.1981 02.1973→10.1977 Reference	D 2530 MF D 2538 MT 51.05100.6249 51.05100.6250			50 005 833
07.1972→10.1981 Reference 	D 2530 MXF, MXFR 51.06500.6222 51.06500.6228 51.06500.9228 →335 8072			50 005 207
07.1972→10.1981 Reference 	D 2530 MXF, MXFR 51.06500.6282 51.06500.6387 51.06500.9282 51.06500.9387 335 8073→			50 005 210
Series 19.321				96
01.1979→01.1988 Reference 	D 2566 MKUL 51.05100.6135 ohne Antriebsrad, without impeller, sans roue motrice, sin rueda motriz, без ведущего колеса			50 005 828
01.1979→01.1988 Reference	D 2566 MK, MKF 51.05100.6249 51.05100.6250			50 005 833
01.1979→01.1988 Reference 	D 2566 MKUL 51.05100.6134 51.05100.6155 mit Antriebsrad, with impeller, avec roue motrice, con rueda motriz, с приводным колесом			50 005 827

M



MAN

						
01.1979→01.1988 Reference	D 2566 51.06500.6282	MK, MKF, MKUL 51.06500.6387	51.06500.9282	51.06500.9387		50 005 210
Series 19.323						97
01.1994→12.1995 Reference	D 2865 51.05100.6250	LF 23 51.05100.6252	51.05100.6260	51.05100.6262		50 005 870
Series 19.330						98
01.1975→04.1983 Reference	D 2530 51.05100.6249	MF 51.05100.6250				50 005 833
Series 19.331						99
08.1986→07.1989 Reference 	D 2866 51.05100.6135	LUL/330 ohne Antriebsrad, without impeller, sans roue motrice, sin rueda motriz, без ведущего колеса				50 005 828
09.1985→08.1988 Reference	D 2866 51.05100.6249	LFZ/330 51.05100.6250				50 005 833
08.1986→07.1989 Reference 	D 2866 51.05100.6134	LUL/330 51.05100.6155 mit Antriebsrad, with impeller, avec roue motrice, con rueda motriz, с приводным колесом				50 005 827
Series 19.332						100
07.1986→02.1990 Reference	D 2866 51.06500.6479	LF				50 005 613
07.1986→02.1990 Reference 	D 2866 51.05100.6135	LUL/330 ohne Antriebsrad, without impeller, sans roue motrice, sin rueda motriz, без ведущего колеса				50 005 828
07.1986→02.1990 Reference 	D 2866 51.05100.6134	LUL/330 51.05100.6155 mit Antriebsrad, with impeller, avec roue motrice, con rueda motriz, с приводным колесом				50 005 827
07.1986→02.1990 Reference	D 2866 51.06500.6492	LF				50 005 614
Series 19.343						101
01.1994→09.2001 Reference	D 2865 51.05100.6250	LF 21 51.05100.6252	51.05100.6260	51.05100.6262		50 005 870

M



Series 19.360 102				
05.1978→12.1982 Reference	D 2530 MTXF 51.05100.6249 51.05100.6250		50 005 833	
Series 19.361 103				
09.1983→07.1989 Reference	D 2866 KUL 51.05100.6135 ohne Antriebsrad, without impeller, sans roue motrice, sin rueda motriz, без ведущего колеса		50 005 828	
09.1983→08.1988 Reference	D 2866 KFZ 51.05100.6249 51.05100.6250		50 005 833	
09.1983→07.1989 Reference	D 2866 KUL 51.05100.6134 51.05100.6155 mit Antriebsrad, with impeller, avec roue motrice, con rueda motriz, с приводным колесом		50 005 827	
Series 19.362 104				
07.1986→02.1990 Reference	D 2866 KF 51.05100.6249 51.05100.6250		50 005 833	
Series 19.364 105				
06.1998→12.2001 Reference	D 2866 LF 35 51.05100.6250 51.05100.6252 51.05100.6260 51.05100.6262		50 005 870	M
Series 19.372 106				
1991 →1994 Reference	D 2866 LU 03 51.05100.6135 ohne Antriebsrad, without impeller, sans roue motrice, sin rueda motriz, без ведущего колеса		50 005 828	
1991 →1994 Reference	D 2866 LU 03 51.05100.6134 51.05100.6155 mit Antriebsrad, with impeller, avec roue motrice, con rueda motriz, с приводным колесом		50 005 827	
Series 19.373 107				
01.1994→12.1995 Reference	D 2866 LF 21 51.05100.6250 51.05100.6252 51.05100.6260 51.05100.6262		50 005 870	
Series 19.403 108				
01.1994→12.2001 Reference	D 2866 LF 20 51.05100.6250 51.05100.6252 51.05100.6260 51.05100.6262		50 005 870	
Series 19.414 109				
06.1998→12.2001 Reference	D 2866 LF 31 51.05100.6250 51.05100.6252 51.05100.6260 51.05100.6262		50 005 870	



MAN

Series 19.422								110		
1992 → Reference	D 2866 LU 04 51.05100.6135 ohne Antriebsrad, without impeller, sans roue motrice, sin rueda motriz, без ведущего колеса						50 005 828			
1992 → Reference	D 2866 LU 04 51.05100.6134 51.05100.6155 mit Antriebsrad, with impeller, avec roue motrice, con rueda motriz, с приводным колесом						50 005 827			
Series 19.423								111		
01.1994→12.1995 Reference	D 2866 LF 22 51.05100.6250 51.05100.6252 51.05100.6260 51.05100.6262						50 005 870			
Series 19.463								112		
01.1994→12.2001 Reference	D 2876 LF 02 51.05100.6250 51.05100.6252 51.05100.6260 51.05100.6262						50 005 870			
Series 19.464								113		
06.1998→09.2001 Reference	D 2876 LF 06 51.05100.6250 51.05100.6252 51.05100.6260 51.05100.6262						50 005 870			
Series 19.500								114		
05.1987→02.1990 Reference	D 2840 LF/500 51.06500.6426						50 005 612			
Series 19.502								115		
05.1987→06.1996 Reference	D 2840 LF 01, LF 04, LF 06, LF/500 51.06500.6426						50 005 612			
Series 19.603								116		
07.1995→08.2001 Reference	D 2840 LF 20 51.06500.6426						50 005 612			
Series 20.192								117		
09.1975→04.1977 Reference	D 2555 MX 51.05100.6249 51.05100.6250						50 005 833			
04.1977→12.1986 Reference	D 2565 M, MF 51.06500.6282 51.06500.6387 51.06500.9282 51.06500.9387 413 5021→						50 005 210			

M

**Series 20.280****118**

11.1977→06.1990 Reference	D 2566 MTF, MTFG 51.05100.6249 51.05100.6250		50 005 833	
11.1977→06.1990 Reference 	D 2566 MTF, MTFG 51.06500.6222 51.06500.6228 51.06500.9228 →364 4048			50 005 207
11.1977→06.1990 Reference 	D 2566 MTF, MTFG 51.06500.6282 51.06500.6387 51.06500.9282 51.06500.9387 364 4049→			50 005 210

Series 20.281**119**

04.1980→11.1985 Reference	D 2566 MK, MKF 51.05100.6249 51.05100.6250		50 005 833	
04.1980→11.1985 Reference	D 2566 MK, MKF 51.06500.6282 51.06500.6387 51.06500.9282 51.06500.9387			50 005 210

Series 20.291**120**

09.1985→11.1986 Reference	D 2866 LFZ/290 51.05100.6249 51.05100.6250		50 005 833	
------------------------------	---	--	------------	--





















Series 20.320**121**

01.1973→12.1976 Reference	D 2530 MF 51.05100.6249 51.05100.6250		50 005 833	
07.1972→10.1981 Reference 	D 2530 MXF, MXFR 51.06500.6222 51.06500.6228 51.06500.9228 →335 8072			50 005 207
07.1972→10.1981 Reference 	D 2530 MXF, MXFR 51.06500.6282 51.06500.6387 51.06500.9282 51.06500.9387 335 8073→			50 005 210

Series 20.321**122**

















01.1979→08.1989 Reference 	D 2566 MKUL 51.05100.6135 ohne Antriebsrad, without impeller, sans roue motrice, sin rueda motriz, без ведущего колеса		50 005 828	
04.1980→11.1985 Reference	D 2566 MKF 51.05100.6249 51.05100.6250		50 005 833	







































				
01.1979→08.1989 Reference 	D 2566 MKUL 51.05100.6134 51.05100.6155 mit Antriebsrad, with impeller, avec roue motrice, con rueda motriz, с приводным колесом		50 005 827	
01.1979→08.1989 Reference	D 2566 MKF, MKUL 51.06500.6282 51.06500.6387 51.06500.9282 51.06500.9387			50 005 210
Series 20.331				123
09.1985→11.1986 Reference	D 2866 LFZ/330 51.05100.6249 51.05100.6250		50 005 833	
Series 20.361				124
09.1983→11.1986 Reference	D 2866 KF 51.05100.6249 51.05100.6250		50 005 833	
Series 22.192				125
10.1972→12.1973 Reference	D 2556 MF 51.05100.6249 51.05100.6250		50 005 833	
1976 →09.1990 Reference 	D 2565 M, MF, MFR, MR 51.06500.6282 51.06500.6387 51.06500.9282 51.06500.9387 413 5021→			50 005 210
Series 22.200				126
10.1974→03.1978 Reference	D 2556 MF 51.05100.6249 51.05100.6250		50 005 833	
Series 22.220				127
10.1983→11.1986 Reference 	D 2566 MF 51.06500.6222 51.06500.6228 51.06500.9228 →409 1059			50 005 207
10.1983→11.1986 Reference 	D 2566 MF 51.06500.6282 51.06500.6387 51.06500.9282 51.06500.9387 409 1060→			50 005 210
Series 22.240				128
06.1977→12.1988 Reference	D 2566 M 51.05100.6249 51.05100.6250		50 005 833	
09.1973→10.1976 10.1976→12.1988 Reference 	D 2556 MXF D 2566 M, MF, MFR 51.06500.6222 51.06500.6228 51.06500.9228 D 2566 M, D 2566 MF, D 2566 MFR: →409 1059			50 005 207

M



						
10.1976→12.1988 Reference 	D 2566 51.06500.6282 409 1060→	M, MF, MFR 51.06500.6387	51.06500.9282	51.06500.9387		50 005 210
Series 22.280						129
01.1977→12.1980 Reference	D 2566 51.05100.6249	MTF 51.05100.6250				50 005 833
01.1977→12.1980 Reference 	D 2566 51.06500.6222 →364 4048	MTF 51.06500.6228	51.06500.9228			50 005 207
01.1977→12.1980 Reference 	D 2566 51.06500.6282 364 4049→	MTF 51.06500.6387	51.06500.9282	51.06500.9387		50 005 210
Series 22.281						130
01.1980→01.1988 Reference	D 2566 51.05100.6249	MK, MKF 51.05100.6250				50 005 833
01.1980→01.1988 Reference	D 2566 51.06500.6282	MK, MKF 51.06500.6387	51.06500.9282	51.06500.9387		50 005 210
Series 22.291						131
09.1985→11.1986 Reference	D 2866 51.05100.6249	LFZ/290 51.05100.6250				50 005 833
Series 22.292						132
07.1986→10.1986 Reference	D 2866 51.06500.6479	LF				50 005 613
07.1986→10.1986 Reference	D 2866 51.06500.6492	LF				50 005 614
Series 22.320						133
01.1973→12.1980 Reference	D 2530 51.05100.6249	MF 51.05100.6250				50 005 833

**MAN**

				
07.1972→10.1981 Reference 	D 2530 Reference 	MXF, MXFR 51.06500.6222 51.06500.6228 51.06500.9228 →335 8072		50 005 207
07.1972→10.1981 Reference 	D 2530 Reference 	MXF, MXFR 51.06500.6282 51.06500.6387 51.06500.9282 51.06500.9387 335 8073→		50 005 210
Series 22.321				134
06.1979→11.1985 Reference 	D 2566 Reference 	MKUL 51.05100.6135 ohne Antriebsrad, without impeller, sans roue motrice, sin rueda motriz, без ведущего колеса		50 005 828
04.1980→11.1985 Reference 	D 2566 Reference 	MKF 51.05100.6249 51.05100.6250		50 005 833
06.1979→11.1985 Reference 	D 2566 Reference 	MKUL 51.05100.6134 51.05100.6155 mit Antriebsrad, with impeller, avec roue motrice, con rueda motriz, с приводным колесом		50 005 827
06.1979→11.1985 Reference 	D 2566 Reference 	MKF, MKUL 51.06500.6282 51.06500.6387 51.06500.9282 51.06500.9387		50 005 210
Series 22.331				135
09.1985→11.1986 Reference 	D 2866 Reference 	LU 51.05100.6135 ohne Antriebsrad, without impeller, sans roue motrice, sin rueda motriz, без ведущего колеса		50 005 828
09.1985→11.1986 Reference 	D 2866 Reference 	LFZ/330 51.05100.6249 51.05100.6250		50 005 833
09.1985→11.1986 Reference 	D 2866 Reference 	LU 51.05100.6134 51.05100.6155 mit Antriebsrad, with impeller, avec roue motrice, con rueda motriz, с приводным колесом		50 005 827
Series 22.332				136
07.1986→10.1986 Reference 	D 2866 Reference 	LF 51.06500.6479		50 005 613
07.1986→10.1986 Reference 	D 2866 Reference 	LUL/330 51.05100.6135 ohne Antriebsrad, without impeller, sans roue motrice, sin rueda motriz, без ведущего колеса		50 005 828

M



07.1986→10.1986 Reference 	D 2866 LUL/330 51.05100.6134 51.05100.6155 mit Antriebsrad, with impeller, avec roue motrice, con rueda motriz, с приводным колесом			50 005 827	
07.1986→10.1986 Reference	D 2866 LF 51.06500.6492				50 005 614
Series 22.361					137
09.1983→11.1986 Reference 	D 2866 KUL 51.05100.6135 ohne Antriebsrad, without impeller, sans roue motrice, sin rueda motriz, без ведущего колеса			50 005 828	
09.1983→11.1986 Reference	D 2866 KF 51.05100.6249 51.05100.6250			50 005 833	
09.1983→11.1986 Reference 	D 2866 KUL 51.05100.6134 51.05100.6155 mit Antriebsrad, with impeller, avec roue motrice, con rueda motriz, с приводным колесом			50 005 827	
Series 22.362					138
07.1986→10.1986 Reference 	D 2866 KUL 51.05100.6135 ohne Antriebsrad, without impeller, sans roue motrice, sin rueda motriz, без ведущего колеса			50 005 828	
07.1986→10.1986 Reference	D 2866 KF 51.05100.6249 51.05100.6250			50 005 833	
07.1986→10.1986 Reference 	D 2866 KUL 51.05100.6134 51.05100.6155 mit Antriebsrad, with impeller, avec roue motrice, con rueda motriz, с приводным колесом			50 005 827	
Series 23.293					139
04.1995→01.2000 Reference	D 2865 LF 24 51.05100.6250 51.05100.6252 51.05100.6260 51.05100.6262			50 005 870	
Series 23.314					140
07.1999→ Reference	D 2866 LF 34 51.05100.6250 51.05100.6252 51.05100.6260 51.05100.6262			50 005 870	
Series 23.343					141
01.1994→01.2000 Reference	D 2865 LF 21 51.05100.6250 51.05100.6252 51.05100.6260 51.05100.6262			50 005 870	
Series 23.364					142
07.1999→ Reference	D 2866 LF 35 51.05100.6250 51.05100.6252 51.05100.6260 51.05100.6262			50 005 870	

**MAN****Series 23.372****143**

10.1990→ Reference	D 2866 LU 01 51.05100.6135 ohne Antriebsrad, without impeller, sans roue motrice, sin rueda motriz, без ведущего колеса		50 005 828	
10.1990→ Reference	D 2866 LU 01 51.05100.6134 51.05100.6155 mit Antriebsrad, with impeller, avec roue motrice, con rueda motriz, с приводным колесом		50 005 827	

Series 23.403**144**

01.1994→ Reference	D 2866 LF 20 51.05100.6250 51.05100.6252 51.05100.6260 51.05100.6262		50 005 870	
-----------------------	---	--	------------	--

Series 23.414**145**

07.1999→ Reference	D 2866 LF 31 51.05100.6250 51.05100.6252 51.05100.6260 51.05100.6262		50 005 870	
-----------------------	---	--	------------	--

Series 23.463**146**

01.1994→ Reference	D 2876 LF 02 51.05100.6250 51.05100.6252 51.05100.6260 51.05100.6262		50 005 870	
-----------------------	---	--	------------	--

Series 23.464**147**

09.1998→ Reference	D 2876 LF 06 51.05100.6250 51.05100.6252 51.05100.6260 51.05100.6262		50 005 870	
-----------------------	---	--	------------	--

Series 24.192**148**

07.1989→06.1996 Reference	D 0826 LF 01, LF 05, LF 07 51.06500.6495 Flügelrad Durchmesser 135 mm impeller diameter 135 mm roue à ailettes 135 mm roueda con paletas 135 mm Лопастное колесо диаметр 135 мм			50 005 630
07.1989→06.1996 Reference	D 0826 LF 01, LF 05, LF 07 51.06500.6476 Flügelrad Durchmesser 125 mm impeller diameter 125 mm roue à ailettes 125 mm roueda con paletas 135 mm Лопастное колесо диаметр 125 мм			50 005 631
11.1986→12.1987 Reference	D 2565 MF 51.06500.6282 51.06500.6387 51.06500.9282 51.06500.9387 413 5021→			50 005 210

Series 24.220**149**

11.1986→08.1988 Reference	D 2566 MF 51.06500.6222 51.06500.6228 51.06500.9228 →409 1059			50 005 207
------------------------------	---	--	--	------------

















M



11.1986→08.1988	D 2566 MF	Reference	51.06500.6282	51.06500.6387	51.06500.9282	51.06500.9387	50 005 210
			409 1060→				
Series 24.222							150
05.1994→06.1996	D 0826 LF 11	Reference	51.06500.6495				50 005 630
			Flügelrad Durchmesser 135 mm impeller diameter 135 mm roue à ailettes 135 mm roueda con paletas 135 mm Лопастное колесо диаметр 135 мм				
05.1994→06.1996	D 0826 LF 11	Reference	51.06500.6476				50 005 631
			Flügelrad Durchmesser 125 mm impeller diameter 125 mm roue à ailettes 125 mm roueda con paletas 135 mm Лопастное колесо диаметр 125 мм				
Series 24.232							151
07.1989→06.1996	D 0826 LF 02, LF 06, LF 08, LF/217	Reference	51.06500.6495				50 005 630
			Flügelrad Durchmesser 135 mm impeller diameter 135 mm roue à ailettes 135 mm roueda con paletas 135 mm Лопастное колесо диаметр 135 мм				
07.1989→06.1996	D 0826 LF 02, LF 06, LF 08, LF/217	Reference	51.06500.6476				50 005 631
			Flügelrad Durchmesser 125 mm impeller diameter 125 mm roue à ailettes 125 mm roueda con paletas 135 mm Лопастное колесо диаметр 125 мм				
Series 24.240							152
10.1976→08.1988	D 2566 MF, MFR	Reference	51.06500.6222	51.06500.6228	51.06500.9228		50 005 207
			→409 1059				
10.1976→08.1988	D 2566 MF, MFR	Reference	51.06500.6282	51.06500.6387	51.06500.9282	51.06500.9387	50 005 210
			409 1060→				
Series 24.242							153
01.1988→02.1990	D 2866 F	Reference	51.05100.6249	51.05100.6250			50 005 833
Series 24.262							154
08.1995→06.1996	D 0826 LF 13	Reference	51.06500.6495				50 005 630
			Flügelrad Durchmesser 135 mm impeller diameter 135 mm roue à ailettes 135 mm roueda con paletas 135 mm Лопастное колесо диаметр 135 мм				

















MAN

				
01.1988→02.1990 Reference	D 2865 LF 51.06500.6479			50 005 613
08.1995→06.1996 Reference 	D 0826 LF 13 51.06500.6476 Flügelrad Durchmesser 125 mm impeller diameter 125 mm roue à ailettes 125 mm roueda con paletas 135 mm Лопастное колесо диаметр 125 мм			50 005 631
01.1988→02.1990 Reference	D 2865 LF 51.05100.6249 51.05100.6250			50 005 833
01.1988→02.1990 Reference	D 2865 LF 51.06500.6492			50 005 614
Series 24.272				155
06.1993→06.1996 Reference 	D 0826 LF 04 51.06500.6495 Flügelrad Durchmesser 135 mm impeller diameter 135 mm roue à ailettes 135 mm roueda con paletas 135 mm Лопастное колесо диаметр 135 мм			50 005 630
06.1993→06.1996 Reference 	D 0826 LF 04 51.06500.6476 Flügelrad Durchmesser 125 mm impeller diameter 125 mm roue à ailettes 125 mm roueda con paletas 135 mm Лопастное колесо диаметр 125 мм			50 005 631
Series 24.273				156
01.1994→12.1995 Reference	D 2865 LF 22 51.05100.6250 51.05100.6252 51.05100.6260 51.05100.6262			50 005 870
Series 24.291				157
11.1986→08.1988 Reference	D 2866 LFZ/290 51.05100.6249 51.05100.6250			50 005 833
Series 24.292				158
10.1986→02.1990 Reference	D 2866 LF 51.06500.6479			50 005 613
10.1986→02.1990 Reference	D 2866 LF 51.06500.6492			50 005 614

M



















				
Series 24.293				159
01.1994→01.2000 Reference	D 2865 LF 24 51.05100.6250 51.05100.6252 51.05100.6260 51.05100.6262		50 005 870	
Series 24.310				160
07.1998→09.2002 Reference	D 2866 LOH 25, LOH 27 51.05100.6250 51.05100.6252 51.05100.6260 51.05100.6262		50 005 870	
Series 24.314				161
07.1999→08.2002 Reference	D 2866 LF 23, LF 34 51.05100.6250 51.05100.6252 51.05100.6260 51.05100.6262		50 005 870	
Series 24.323				162
01.1994→12.1995 Reference	D 2865 LF 23 51.05100.6250 51.05100.6252 51.05100.6260 51.05100.6262		50 005 870	
Series 24.331				163
11.1986→07.1989 Reference	D 2866 LUL/330 51.05100.6135 ohne Antriebsrad, without impeller, sans roue motrice, sin rueda motriz, без ведущего колеса		50 005 828	
11.1986→08.1988 Reference	D 2866 LFZ/330 51.05100.6249 51.05100.6250		50 005 833	
11.1986→07.1989 Reference	D 2866 LUL/330 51.05100.6134 51.05100.6155 mit Antriebsrad, with impeller, avec roue motrice, con rueda motriz, с приводным колесом		50 005 827	
Series 24.332				164
10.1986→02.1990 Reference	D 2866 LF 51.06500.6479			50 005 613
10.1986→02.1990 Reference	D 2866 LUL/330 51.05100.6135 ohne Antriebsrad, without impeller, sans roue motrice, sin rueda motriz, без ведущего колеса		50 005 828	
10.1986→02.1990 Reference	D 2866 LUL/330 51.05100.6134 51.05100.6155 mit Antriebsrad, with impeller, avec roue motrice, con rueda motriz, с приводным колесом		50 005 827	
10.1986→02.1990 Reference	D 2866 LF 51.06500.6492			50 005 614

M

















MAN

				
Series 24.343				165
01.1994→01.2000 Reference	D 2865 LF 21 51.05100.6250 51.05100.6252 51.05100.6260 51.05100.6262		50 005 870	
Series 24.350				166
07.1998→09.2001 Reference	D 2866 LOH 26 51.05100.6250 51.05100.6252 51.05100.6260 51.05100.6262		50 005 870	
Series 24.360				167
09.2002→ Reference	D 2866 LOH 28 51.05100.6250 51.05100.6252 51.05100.6260 51.05100.6262		50 005 870	
Series 24.361				168
11.1986→07.1989 Reference	D 2866 KUL 51.05100.6135 ohne Antriebsrad, without impeller, sans roue motrice, sin rueda motriz, без ведущего колеса		50 005 828	
11.1986→09.1987 Reference	D 2866 KFZ 51.05100.6249 51.05100.6250		50 005 833	
11.1986→07.1989 Reference	D 2866 KUL 51.05100.6134 51.05100.6155 mit Antriebsrad, with impeller, avec roue motrice, con rueda motriz, с приводным колесом		50 005 827	
Series 24.362				169
10.1986→02.1990 Reference	D 2866 KUL 51.05100.6135 ohne Antriebsrad, without impeller, sans roue motrice, sin rueda motriz, без ведущего колеса		50 005 828	
10.1986→02.1990 Reference	D 2866 KF 51.05100.6249 51.05100.6250		50 005 833	
10.1986→02.1990 Reference	D 2866 KUL 51.05100.6134 51.05100.6155 mit Antriebsrad, with impeller, avec roue motrice, con rueda motriz, с приводным колесом		50 005 827	
Series 24.364				170
07.1999→09.2001 Reference	D 2866 LF 35 51.05100.6250 51.05100.6252 51.05100.6260 51.05100.6262		50 005 870	
Series 24.372				171
1991 →1994 Reference	D 2866 LU 03 51.05100.6135 ohne Antriebsrad, without impeller, sans roue motrice, sin rueda motriz, без ведущего колеса		50 005 828	
1991 →1994 Reference	D 2866 LU 03 51.05100.6134 51.05100.6155 mit Antriebsrad, with impeller, avec roue motrice, con rueda motriz, с приводным колесом		50 005 827	

M



							
Series 24.373				172			
01.1994→12.1995 Reference	D 2866 51.05100.6250	LF 21 51.05100.6252	51.05100.6260	51.05100.6262		50 005 870	
Series 24.400				173			
07.1998→09.2001 Reference	D 2866 51.05100.6250	LOH 23 51.05100.6252	51.05100.6260	51.05100.6262		50 005 870	
Series 24.403				174			
01.1994→09.2001 Reference	D 2866 51.05100.6250	LF 20 51.05100.6252	51.05100.6260	51.05100.6262		50 005 870	
Series 24.410				175			
09.2002→ 07.1998→09.2001 Reference	D 2866 51.05100.6250	LOH 29 51.05100.6252	LOH 05 51.05100.6260	51.05100.6262		50 005 870	
Series 24.414				176			
07.1999→12.2001 Reference	D 2866 51.05100.6250	LF 31 51.05100.6252	51.05100.6260	51.05100.6262		50 005 870	
Series 24.422				177			
1992 →1994 Reference	D 2866 51.05100.6135	LU 04				50 005 828	
	ohne Antriebsrad, without impeller, sans roue motrice, sin rueda motriz, без ведущего колеса						
1992 →1994 Reference	D 2866 51.05100.6134	LU 04 51.05100.6155				50 005 827	
	mit Antriebsrad, with impeller, avec roue motrice, con rueda motriz, с приводным колесом						
Series 24.423				178			
01.1994→12.1995 Reference	D 2866 51.05100.6250	LF 22 51.05100.6252	51.05100.6260	51.05100.6262		50 005 870	
Series 24.460				179			
11.1999→ Reference	D 2876 51.05100.6250	LOH 01, LOH 02 51.05100.6252	51.05100.6260	51.05100.6262		50 005 870	
Series 24.463				180			
01.1994→ Reference	D 2876 51.05100.6250	LF 02 51.05100.6252	51.05100.6260	51.05100.6262		50 005 870	
Series 24.464				181			
07.1999→09.2001 Reference	D 2876 51.05100.6250	LF 06 51.05100.6252	51.05100.6260	51.05100.6262		50 005 870	

M

**MAN****Series 24.502****182**

05.1987→12.1990 D 2840 LF 01, LF/500
Reference 51.06500.6426

**50 005 612****Series 25.372****183**

10.1990→ D 2866 LU 01
Reference 51.05100.6135
ohne Antriebsrad, without impeller, sans roue motrice, sin rueda motriz, без ведущего колеса

**50 005 828**

10.1990→ D 2866 LU 01
Reference 51.05100.6134 51.05100.6155
mit Antriebsrad, with impeller, avec roue motrice, con rueda motriz, с приводным колесом

**50 005 827****Series 25.422****184**

1992→ D 2866 LU 04
Reference 51.05100.6135
ohne Antriebsrad, without impeller, sans roue motrice, sin rueda motriz, без ведущего колеса

**50 005 828**

1992→ D 2866 LU 04
Reference 51.05100.6134 51.05100.6155
mit Antriebsrad, with impeller, avec roue motrice, con rueda motriz, с приводным колесом

**50 005 827****M****Series 25.502****185**

09.1990→12.1992 D 2840 LF 01, LF 04
Reference 51.06500.6426

**50 005 612****Series 26.240****186**

10.1976→08.1988 D 2566 M, MXF
Reference 51.05100.6249 51.05100.6250

**50 005 833**

09.1973→07.1977 D 2556 MX, MXF
10.1976→08.1988 D 2566 M, MF, MFR
Reference 51.06500.6222 51.06500.6228 51.06500.9228
D 2566 M, D 2566 MF, D 2566 MFR: →409 1059

**50 005 207**

10.1976→08.1988 D 2566 M, MF, MFR
Reference 51.06500.6282 51.06500.6387 51.06500.9282 51.06500.9387
409 1060→

**50 005 210****Series 26.242****187**

01.1988→07.1989 D 2866 F
Reference 51.05100.6249 51.05100.6250

**50 005 833**

**Series 26.256****188**

08.1972→12.1974 Reference	D 2538 M, MF 51.05100.6249 51.05100.6250		50 005 833	
08.1972→12.1974 Reference 	D 2538 M, MF 51.06500.6222 51.06500.6228 51.06500.9228 200 1001→358 1000			50 005 207
08.1972→12.1974 Reference 	D 2538 M, MF 51.06500.6282 51.06500.6387 51.06500.9282 51.06500.9387 358 1001→			50 005 210

Series 26.262**189**

01.1988→02.1990 Reference	D 2865 LF 51.06500.6479			50 005 613
01.1988→02.1990 Reference	D 2865 LF 51.05100.6249 51.05100.6250		50 005 833	
01.1988→02.1990 Reference	D 2865 LF 51.06500.6492			50 005 614















M**Series 26.273****190**

01.1994→12.1995 Reference	D 2865 LF 22 51.05100.6250 51.05100.6252 51.05100.6260 51.05100.6262		50 005 870	
------------------------------	---	--	------------	--

Series 26.280**191**

















11.1976→12.1981 Reference	D 2566 MT, MTF 51.05100.6249 51.05100.6250		50 005 833	
11.1976→12.1981 Reference 	D 2566 MT, MTF 51.06500.6222 51.06500.6228 51.06500.9228 →364 4048			50 005 207
11.1976→12.1981 Reference 	D 2566 MT, MTF 51.06500.6282 51.06500.6387 51.06500.9282 51.06500.9387 364 4049→			50 005 210



					
Series 26.281					192
02.1980→01.1988 Reference	D 2566 51.05100.6249	MK, MKF 51.05100.6250		50 005 833	
02.1980→01.1988 Reference	D 2566 51.06500.6282	MK, MKF 51.06500.6387 51.06500.9282 51.06500.9387		50 005 210	
Series 26.291					193
09.1985→02.1989 Reference	D 2866 51.05100.6249	LFZ/290 51.05100.6250		50 005 833	
Series 26.292					194
09.1987→02.1990 Reference	D 2866 51.06500.6479	LF		50 005 613	
09.1987→02.1990 Reference	D 2866 51.06500.6492	LF		50 005 614	
Series 26.293					195
04.1995→09.2001 Reference	D 2865 51.05100.6250	LF 24 51.05100.6252 51.05100.6260 51.05100.6262		50 005 870	
Series 26.314					196
07.1999→06.2002 Reference	D 2866 51.05100.6250	LF 23, LF 34 51.05100.6252 51.05100.6260 51.05100.6262		50 005 870	
Series 26.320					197
07.1972→01.1986 03.1973→10.1977 Reference	D 2530 51.05100.6249	MF MT 51.05100.6250		50 005 833	
07.1972→01.1986 Reference	D 2530 51.06500.6222 →335 8072	MXF, MXFR 51.06500.6228 51.06500.9228		50 005 207	
07.1972→01.1986 Reference	D 2530 51.06500.6282 335 8073→	MXF, MXFR 51.06500.6387 51.06500.9282 51.06500.9387		50 005 210	

















M



				
Series 26.321 198				
02.1980→01.1988 Reference	D 2566 MK, MKF 51.05100.6249 51.05100.6250		50 005 833	
02.1980→01.1988 Reference	D 2566 MK, MKF 51.06500.6282 51.06500.6387 51.06500.9282 51.06500.9387			50 005 210
Series 26.322 199				
1991 → Reference 	D 2865 LU 03 51.05100.6135 ohne Antriebsrad, without impeller, sans roue motrice, sin rueda motriz, без ведущего колеса		50 005 828	
1991 → Reference 	D 2865 LU 03 51.05100.6134 51.05100.6155 mit Antriebsrad, with impeller, avec roue motrice, con rueda motriz, с приводным колесом		50 005 827	
Series 26.323 200				
01.1994→12.1995 Reference	D 2865 LF 23 51.05100.6250 51.05100.6252 51.05100.6260 51.05100.6262		50 005 870	
Series 26.331 201				
09.1985→02.1989 Reference	D 2866 LFZ/330 51.05100.6249 51.05100.6250		50 005 833	
Series 26.332 202				
09.1987→02.1990 Reference	D 2866 LF 51.06500.6479			50 005 613
09.1987→02.1990 Reference	D 2866 LF 51.06500.6492			50 005 614
Series 26.343 203				
01.1994→09.2001 Reference	D 2865 LF 21 51.05100.6250 51.05100.6252 51.05100.6260 51.05100.6262		50 005 870	
Series 26.361 204				
04.1983→02.1989 Reference	D 2866 KFZ 51.05100.6249 51.05100.6250		50 005 833	
Series 26.362 205				
09.1987→02.1990 Reference	D 2866 KF 51.05100.6249 51.05100.6250		50 005 833	













MAN

				
Series 26.364				206
07.1999→09.2001 Reference	D 2866 LF 35 51.05100.6250 51.05100.6252 51.05100.6260 51.05100.6262		50 005 870	
Series 26.373				207
01.1994→12.1995 Reference	D 2866 LF 21 51.05100.6250 51.05100.6252 51.05100.6260 51.05100.6262		50 005 870	
Series 26.403				208
01.1994→09.2001 Reference	D 2866 LF 20 51.05100.6250 51.05100.6252 51.05100.6260 51.05100.6262		50 005 870	
Series 26.414				209
09.1998→06.2002 Reference	D 2866 LF 31 51.05100.6250 51.05100.6252 51.05100.6260 51.05100.6262		50 005 870	
Series 26.422				210
1992 → Reference 	D 2866 LU 04 51.05100.6135 ohne Antriebsrad, without impeller, sans roue motrice, sin rueda motriz, без ведущего колеса		50 005 828	
1992 → Reference 	D 2866 LU 04 51.05100.6134 51.05100.6155 mit Antriebsrad, with impeller, avec roue motrice, con rueda motriz, с приводным колесом		50 005 827	
Series 26.423				211
01.1994→12.1995 Reference	D 2866 LF 22 51.05100.6250 51.05100.6252 51.05100.6260 51.05100.6262		50 005 870	
Series 26.463				212
01.1994→09.2001 Reference	D 2876 LF 02 51.05100.6250 51.05100.6252 51.05100.6260 51.05100.6262		50 005 870	
Series 26.464				213
07.1999→06.2002 Reference	D 2876 LF 06 51.05100.6250 51.05100.6252 51.05100.6260 51.05100.6262		50 005 870	
Series 26.502				214
05.1987→06.1996 Reference	D 2840 LF 01, LF 04, LF 06, LF/500 51.06500.6426		50 005 612	
Series 26.603				215
03.1996→08.2001 Reference	D 2840 LF 20 51.06500.6426		50 005 612	















M



				
Series 27.273 216				
01.1994→12.1995 Reference	D 2865 LF 22 51.05100.6250 51.05100.6252 51.05100.6260 51.05100.6262		50 005 870	
Series 27.293 217				
04.1995→01.2000 Reference	D 2865 LF 24 51.05100.6250 51.05100.6252 51.05100.6260 51.05100.6262		50 005 870	
Series 27.314 218				
07.1999→09.2001 Reference	D 2866 LF 34 51.05100.6250 51.05100.6252 51.05100.6260 51.05100.6262		50 005 870	
Series 27.323 219				
01.1994→12.1995 Reference	D 2865 LF 23 51.05100.6250 51.05100.6252 51.05100.6260 51.05100.6262		50 005 870	
Series 27.343 220				
01.1994→01.2000 Reference	D 2865 LF 21 51.05100.6250 51.05100.6252 51.05100.6260 51.05100.6262		50 005 870	
Series 27.364 221				
07.1999→09.2001 Reference	D 2866 LF 35 51.05100.6250 51.05100.6252 51.05100.6260 51.05100.6262		50 005 870	
Series 27.373 222				
01.1994→12.1995 Reference	D 2866 LF 21 51.05100.6250 51.05100.6252 51.05100.6260 51.05100.6262		50 005 870	
Series 27.403 223				
01.1994→09.2001 Reference	D 2866 LF 20 51.05100.6250 51.05100.6252 51.05100.6260 51.05100.6262		50 005 870	
Series 27.414 224				
07.1999→12.2001 Reference	D 2866 LF 31 51.05100.6250 51.05100.6252 51.05100.6260 51.05100.6262		50 005 870	
Series 27.423 225				
01.1994→12.1995 Reference	D 2866 LF 22 51.05100.6250 51.05100.6252 51.05100.6260 51.05100.6262		50 005 870	
Series 27.463 226				
01.1994→09.2001 Reference	D 2876 LF 02 51.05100.6250 51.05100.6252 51.05100.6260 51.05100.6262		50 005 870	















M

**MAN**

				
Series 27.464 227				
07.1999→09.2001 Reference	D 2876 LF 06 51.05100.6250 51.05100.6252 51.05100.6260 51.05100.6262		50 005 870	
Series 27.502 228				
01.1993→06.1996 Reference	D 2840 LF 01, LF 04, LF 06 51.06500.6426			50 005 612
Series 27.603 229				
03.1996→08.2001 Reference	D 2840 LF 20 51.06500.6426			50 005 612
Series 28.280 230				
11.1976→12.1981 Reference	D 2566 MTF 51.05100.6249 51.05100.6250		50 005 833	
11.1976→12.1981 Reference	D 2566 MTF 51.06500.6222 51.06500.6228 51.06500.9228 →364 4048			50 005 207
11.1976→12.1981 Reference	D 2566 MTF 51.06500.6282 51.06500.6387 51.06500.9282 51.06500.9387 364 4049→			50 005 210
Series 28.293 231				
09.1996→09.2001 Reference	D 2865 LF 24 51.05100.6250 51.05100.6252 51.05100.6260 51.05100.6262		50 005 870	
Series 28.314 232				
07.1999→ Reference	D 2866 LF 34 51.05100.6250 51.05100.6252 51.05100.6260 51.05100.6262		50 005 870	
Series 28.343 233				
09.1996→09.2001 Reference	D 2865 LF 21 51.05100.6250 51.05100.6252 51.05100.6260 51.05100.6262		50 005 870	
Series 28.364 234				
07.1999→09.2001 Reference	D 2866 LF 35 51.05100.6250 51.05100.6252 51.05100.6260 51.05100.6262		50 005 870	























M



				
Series 28.403				235
09.1996→09.2001 Reference	D 2866 51.05100.6250	LF 20 51.05100.6252	51.05100.6260	51.05100.6262
				50 005 870
Series 28.414				236
07.1999→12.2001 Reference	D 2866 51.05100.6250	LF 31 51.05100.6252	51.05100.6260	51.05100.6262
				50 005 870
Series 28.463				237
09.1996→09.2001 Reference	D 2876 51.05100.6250	LF 02 51.05100.6252	51.05100.6260	51.05100.6262
				50 005 870
Series 28.464				238
07.1999→09.2001 Reference	D 2876 51.05100.6250	LF 06 51.05100.6252	51.05100.6260	51.05100.6262
				50 005 870
Series 29.414				239
07.1999→ Reference	D 2866 51.05100.6250	LF 31 51.05100.6252	51.05100.6260	51.05100.6262
				50 005 870
Series 29.464				240
07.1999→ Reference	D 2876 51.05100.6250	LF 06 51.05100.6252	51.05100.6260	51.05100.6262
				50 005 870
Series 30.232				241
09.1981→06.1983 Reference	D 2556 51.05100.6249	MF 51.05100.6250		
				50 005 833
01.1974→02.1978 03.1978→08.1981 Reference	D 2556 51.06500.6222	MXF MF 51.06500.6228	51.06500.9228	
		D 2566 MF: →409 1059		50 005 207
03.1978→08.1981 Reference	D 2566 51.06500.6282	MF 51.06500.6387	51.06500.9282	51.06500.9387
		409 1060→		50 005 210
Series 30.240				242
10.1976→01.1988 Reference	D 2566 51.05100.6249	M, MXF 51.05100.6250		
				50 005 833
09.1973→07.1977 10.1976→01.1988 Reference	D 2556 51.06500.6222	MX, MXF M, MF, MFR 51.06500.6228	51.06500.9228	
		D 2566 M, D 2566 MF, D 2566 MFR: →409 1059		50 005 207

















M

**MAN**

						
10.1976→01.1988 Reference 	D 2566 51.06500.6282 409 1060→	M, MF, MFR 51.06500.6387	51.06500.9282	51.06500.9387		50 005 210
Series 30.256						243
08.1972→12.1974 Reference 	D 2538 51.05100.6249	M, MF 51.05100.6250				50 005 833
08.1972→12.1974 Reference 	D 2538 51.06500.6222 200 1001→358 1000	M, MF 51.06500.6228	51.06500.9228			50 005 207
08.1972→12.1974 Reference 	D 2538 51.06500.6282 358 1001→	M, MF 51.06500.6387	51.06500.9282	51.06500.9387		50 005 210
Series 30.280						244
11.1976→12.1981 Reference 	D 2566 51.05100.6249	MTF 51.05100.6250				50 005 833
11.1976→12.1981 Reference 	D 2566 51.06500.6222 →364 4048	MTF 51.06500.6228	51.06500.9228			50 005 207
11.1976→12.1981 Reference 	D 2566 51.06500.6282 364 4049→	MTF 51.06500.6387	51.06500.9282	51.06500.9387		50 005 210
Series 30.281						245
06.1980→11.1985 Reference	D 2566 51.05100.6249	MKF 51.05100.6250				50 005 833
06.1980→11.1985 Reference	D 2566 51.06500.6282	MKF 51.06500.6387	51.06500.9282	51.06500.9387		50 005 210
Series 30.291						246
09.1985→11.1986 Reference	D 2866 51.05100.6249	LFZ/290 51.05100.6250				50 005 833
Series 30.293						247
03.1997→09.2001 Reference	D 2865 51.05100.6250	LF 24 51.05100.6252	51.05100.6260	51.05100.6262		50 005 870



















M



				
Series 30.314				248
06.1998→09.2001 Reference	D 2866 LF 34 51.05100.6250 51.05100.6252 51.05100.6260 51.05100.6262		50 005 870	
Series 30.320				249
07.1972→10.1981 03.1973→10.1977 Reference	D 2530 MF D 2538 MT 51.05100.6249 51.05100.6250		50 005 833	
07.1972→10.1981 Reference 	D 2530 MXF, MXFR 51.06500.6222 51.06500.6228 51.06500.9228 →335 8072			50 005 207
07.1972→10.1981 Reference 	D 2530 MXF, MXFR 51.06500.6282 51.06500.6387 51.06500.9282 51.06500.9387 335 8073→			50 005 210
Series 30.321				250
06.1980→11.1985 Reference	D 2566 MKF 51.05100.6249 51.05100.6250		50 005 833	
06.1980→11.1985 Reference	D 2566 MKF 51.06500.6282 51.06500.6387 51.06500.9282 51.06500.9387			50 005 210
Series 30.331				251
09.1985→11.1986 Reference	D 2866 LFZ/330 51.05100.6249 51.05100.6250		50 005 833	
Series 30.343				252
03.1997→09.2001 03.1997→ Reference	D 2865 LF 21 D 2866 LF 35 51.05100.6250 51.05100.6252 51.05100.6260 51.05100.6262		50 005 870	
Series 30.361				253
09.1985→11.1986 Reference	D 2866 KFZ 51.05100.6249 51.05100.6250		50 005 833	
Series 30.364				254
06.1998→ Reference	D 2866 LF 27, LF 35 51.05100.6250 51.05100.6252 51.05100.6260 51.05100.6262		50 005 870	
Series 30.403				255
03.1997→09.2001 Reference	D 2866 LF 20 51.05100.6250 51.05100.6252 51.05100.6260 51.05100.6262		50 005 870	

















M



				
Series 30.414				256
06.1998→12.2001 Reference	D 2866 LF 31 51.05100.6250 51.05100.6252 51.05100.6260 51.05100.6262		50 005 870	
Series 30.463				257
03.1997→09.2001 Reference	D 2876 LF 02 51.05100.6250 51.05100.6252 51.05100.6260 51.05100.6262		50 005 870	
Series 30.464				258
06.1998→09.2001 Reference	D 2876 LF 06 51.05100.6250 51.05100.6252 51.05100.6260 51.05100.6262		50 005 870	
Series 32.232				259
06.1976→06.1983 Reference	D 2566 M 51.05100.6249 51.05100.6250		50 005 833	
06.1976→06.1983 Reference 	D 2566 M 51.06500.6222 51.06500.6228 51.06500.9228 →409 1059			50 005 207
06.1976→06.1983 Reference 	D 2566 M 51.06500.6282 51.06500.6387 51.06500.9282 51.06500.9387 409 1060→			50 005 210
Series 32.240				260
10.1976→08.1988 Reference	D 2566 M, MXF 51.05100.6249 51.05100.6250		50 005 833	
03.1973→12.1974 10.1976→08.1988 Reference 	D 2556 MXF D 2566 M, MF, MFR 51.06500.6222 51.06500.6228 51.06500.9228 D 2566 M, D 2566 MF, D 2566 MFR: →409 1059			50 005 207
10.1976→08.1988 Reference 	D 2566 M, MF, MFR 51.06500.6282 51.06500.6387 51.06500.9282 51.06500.9387 409 1060→			50 005 210
Series 32.262				261
02.1989→02.1990 Reference	D 2865 LF 51.06500.6479			50 005 613
02.1989→02.1990 Reference	D 2865 LF 51.05100.6249 51.05100.6250		50 005 833	

M



				
02.1989→02.1990 Reference	D 2865 LF 51.06500.6492			50 005 614
Series 32.280				262
11.1977→12.1981 Reference	D 2566 MT 51.05100.6249 51.05100.6250			50 005 833
11.1977→12.1981 Reference 	D 2566 MT 51.06500.6222 51.06500.6228 51.06500.9228 →364 4048			50 005 207
11.1977→12.1981 Reference 	D 2566 MT 51.06500.6282 51.06500.6387 51.06500.9282 51.06500.9387 364 4049→			50 005 210
Series 32.281				263
02.1980→01.1988 Reference	D 2566 MK, MKF 51.05100.6249 51.05100.6250			50 005 833
02.1980→01.1988 Reference	D 2566 MK, MKF 51.06500.6282 51.06500.6387 51.06500.9282 51.06500.9387			50 005 210
Series 32.291				264
09.1985→08.1988 Reference	D 2866 LFZ/290 51.05100.6249 51.05100.6250			50 005 833
Series 32.292				265
03.1988→02.1990 Reference	D 2866 LF 51.06500.6479			50 005 613
03.1988→02.1990 Reference	D 2866 LF 51.06500.6492			50 005 614
Series 32.293				266
08.1995→09.2001 Reference	D 2865 LF 24 51.05100.6250 51.05100.6252 51.05100.6260 51.05100.6262			50 005 870















M



Series 32.314				267
07.1999→09.2001 Reference	D 2866 LF 34 51.05100.6250 51.05100.6252 51.05100.6260 51.05100.6262		50 005 870	
Series 32.320				268
01.1973→12.1981 Reference	D 2530 MF 51.05100.6249 51.05100.6250		50 005 833	
07.1972→12.1981 Reference 	D 2530 MXF, MXFR 51.06500.6222 51.06500.6228 51.06500.9228 →335 8072			50 005 207
07.1972→12.1981 Reference 	D 2530 MXF, MXFR 51.06500.6282 51.06500.6387 51.06500.9282 51.06500.9387 335 8073→			50 005 210
Series 32.321				269
02.1980→01.1988 Reference	D 2566 MK, MKF 51.05100.6249 51.05100.6250		50 005 833	
02.1980→01.1988 Reference	D 2566 MK, MKF 51.06500.6282 51.06500.6387 51.06500.9282 51.06500.9387			50 005 210
Series 32.331				270
09.1985→08.1988 Reference	D 2866 LFZ/330 51.05100.6249 51.05100.6250		50 005 833	
Series 32.332				271
03.1988→02.1990 Reference	D 2866 LF 51.06500.6479			50 005 613
03.1988→02.1990 Reference	D 2866 LF 51.06500.6492			50 005 614
Series 32.343				272
08.1995→09.2001 Reference	D 2865 LF 21 51.05100.6250 51.05100.6252 51.05100.6260 51.05100.6262		50 005 870	

M



				
Series 32.361 273				
09.1983→08.1988 Reference	D 2866 KFZ 51.05100.6249 51.05100.6250		50 005 833	
Series 32.362 274				
11.1986→02.1990 Reference	D 2866 KFZ 51.05100.6249 51.05100.6250		50 005 833	
Series 32.364 275				
09.1998→09.2001 Reference	D 2866 LF 35 51.05100.6250 51.05100.6252 51.05100.6260 51.05100.6262		50 005 870	
Series 32.403 276				
08.1995→09.2001 Reference	D 2866 LF 20 51.05100.6250 51.05100.6252 51.05100.6260 51.05100.6262		50 005 870	
Series 32.414 277				
09.1998→12.2001 Reference	D 2866 LF 31 51.05100.6250 51.05100.6252 51.05100.6260 51.05100.6262		50 005 870	
Series 32.463 278				
08.1995→09.2001 Reference	D 2876 LF 02 51.05100.6250 51.05100.6252 51.05100.6260 51.05100.6262		50 005 870	
Series 32.464 279				
09.1998→09.2001 Reference	D 2876 LF 06 51.05100.6250 51.05100.6252 51.05100.6260 51.05100.6262		50 005 870	
Series 33.242 280				
01.1988→08.1988 Reference	D 2866 F 51.05100.6249 51.05100.6250		50 005 833	
Series 33.262 281				
01.1988→02.1990 Reference	D 2865 LF 51.06500.6479			50 005 613
01.1988→02.1990 Reference	D 2865 LF 51.05100.6249 51.05100.6250		50 005 833	
01.1988→02.1990 Reference	D 2865 LF 51.06500.6492			50 005 614

**MAN****Series 33.292****282**09.1987→02.1990
ReferenceD 2866 LF
51.06500.6479

50 005 613

09.1987→02.1990
ReferenceD 2866 LF
51.06500.6492

50 005 614

Series 33.293**283**09.1996→
ReferenceD 2865 LF 24
51.05100.6250 51.05100.6252 51.05100.6260 51.05100.6262

50 005 870

Series 33.321**284**12.1980→11.1985
ReferenceD 2566 MKF
51.05100.6249 51.05100.6250

50 005 833

12.1980→11.1985
ReferenceD 2566 MKF
51.06500.6282 51.06500.6387 51.06500.9282 51.06500.9387

50 005 210

M**Series 33.323****285**01.1994→12.1995
ReferenceD 2865 LF 23
51.05100.6250 51.05100.6252 51.05100.6260 51.05100.6262

50 005 870

Series 33.331**286**09.1985→02.1990
ReferenceD 2866 LFZ/330
51.05100.6249 51.05100.6250

50 005 833

Series 33.332**287**09.1987→02.1990
ReferenceD 2866 LF
51.06500.6479

50 005 613















09.1987→02.1990
ReferenceD 2866 LF
51.06500.6492

50 005 614

Series 33.343**288**01.1994→09.2001
ReferenceD 2865 LF 21
51.05100.6250 51.05100.6252 51.05100.6260 51.05100.6262

50 005 870



				
Series 33.362				289
09.1987→02.1990 Reference	D 2866 KF 51.05100.6249 51.05100.6250		50 005 833	
Series 33.364				290
10.1997→09.2001 Reference	D 2866 LF 35 51.05100.6250 51.05100.6252 51.05100.6260 51.05100.6262		50 005 870	
Series 33.373				291
01.1994→12.1995 Reference	D 2866 LF 21 51.05100.6250 51.05100.6252 51.05100.6260 51.05100.6262		50 005 870	
Series 33.403				292
01.1994→09.2001 Reference	D 2866 LF 20 51.05100.6250 51.05100.6252 51.05100.6260 51.05100.6262		50 005 870	
Series 33.414				293
10.1997→12.2001 Reference	D 2866 LF 31 51.05100.6250 51.05100.6252 51.05100.6260 51.05100.6262		50 005 870	
Series 33.423				294
01.1994→12.1995 Reference	D 2866 LF 22 51.05100.6250 51.05100.6252 51.05100.6260 51.05100.6262		50 005 870	
Series 33.463				295
01.1994→09.2001 Reference	D 2876 LF 02 51.05100.6250 51.05100.6252 51.05100.6260 51.05100.6262		50 005 870	
Series 33.464				296
10.1997→09.2001 Reference	D 2876 LF 02, LF 06 51.05100.6250 51.05100.6252 51.05100.6260 51.05100.6262		50 005 870	
Series 33.502				297
09.1991→06.1996 Reference	D 2840 LF 01, LF 04, LF 06 51.06500.6426			50 005 612
Series 33.603				298
03.1996→08.2001 Reference	D 2840 LF 20 51.06500.6426			50 005 612

M

**MAN****Series 35.262****299**

02.1989→02.1990 Reference	D 2865 LF 51.06500.6479				50 005 613
------------------------------	----------------------------	--	---	--	------------

02.1989→02.1990 Reference	D 2865 LF 51.05100.6249 51.05100.6250			50 005 833	
------------------------------	--	--	---	------------	--

02.1989→02.1990 Reference	D 2865 LF 51.06500.6492				50 005 614
------------------------------	----------------------------	--	---	--	------------

Series 35.292**300**

10.1988→04.1995 Reference	D 2866 LFZ/290 51.05100.6249 51.05100.6250			50 005 833	
------------------------------	---	--	---	------------	--

Series 35.332**301**

10.1986→04.1995 Reference	D 2866 LFZ/330 51.05100.6249 51.05100.6250			50 005 833	
------------------------------	---	--	---	------------	--

Series 35.343**302**

08.1995→09.2001 Reference	D 2865 LF 21 51.05100.6250 51.05100.6252 51.05100.6260 51.05100.6262			50 005 870	
------------------------------	---	--	---	------------	--

Series 35.364**303**

06.1998→09.2001 Reference	D 2866 LF 35 51.05100.6250 51.05100.6252 51.05100.6260 51.05100.6262			50 005 870	
------------------------------	---	--	---	------------	--

Series 35.403**304**

08.1995→09.2001 Reference	D 2866 LF 20 51.05100.6250 51.05100.6252 51.05100.6260 51.05100.6262			50 005 870	
------------------------------	---	--	---	------------	--

Series 35.414**305**

06.1998→12.2001 Reference	D 2866 LF 31 51.05100.6250 51.05100.6252 51.05100.6260 51.05100.6262			50 005 870	
------------------------------	---	--	---	------------	--

Series 35.463**306**

08.1995→ Reference	D 2876 LF 02 51.05100.6250 51.05100.6252 51.05100.6260 51.05100.6262			50 005 870	
-----------------------	---	--	---	------------	--

Series 35.464**307**

06.1998→09.2001 Reference	D 2876 LF 06 51.05100.6250 51.05100.6252 51.05100.6260 51.05100.6262			50 005 870	
------------------------------	---	--	---	------------	--

M



Series 38.320

308

05.1976→01.1983
05.1976→01.1983
Reference

D 2530 MF
D 2566 MTF
51.05100.6249 51.05100.6250



50 005 833

07.1972→01.1983
05.1976→01.1983
Reference

D 2530 MXF, MXFR
D 2566 MTF
51.06500.6222 51.06500.6228 51.06500.9228
D 2530 MXF, D 2530 MXFR: →335 8072
D 2566 MTF: →364 4048



50 005 207

07.1972→01.1983
05.1976→01.1983
Reference

D 2530 MXF, MXFR
D 2566 MTF
51.06500.6282 51.06500.6387 51.06500.9282 51.06500.9387
D 2530 MXF, D 2530 MXFR: 335 8073→
D 2566 MTF: 364 4049→



50 005 210

Series 40.320

309

05.1976→01.1983
Reference

D 2530 MF
51.05100.6249 51.05100.6250



50 005 833

Series 40.400

310

06.1979→12.1982
Reference

D 2530 MTXF
51.05100.6249 51.05100.6250



50 005 833

Series 40.403

311

02.1997→
Reference

D 2866 LF 20
51.05100.6250 51.05100.6252 51.05100.6260 51.05100.6262



50 005 870

Series 40.414

312

12.1997→12.2001
Reference

D 2866 LF 31
51.05100.6250 51.05100.6252 51.05100.6260 51.05100.6262



50 005 870

Series 40.463

313

08.1995→
Reference

D 2876 LF 02
51.05100.6250 51.05100.6252 51.05100.6260 51.05100.6262



50 005 870

Series 40.464

314

12.1997→09.2001
Reference

D 2876 LF 06
51.05100.6250 51.05100.6252 51.05100.6260 51.05100.6262



50 005 870

Series 40.502

315

02.1990→06.1996
Reference

D 2840 LF 01, LF 04, LF 06
51.06500.6426



50 005 612

M



MAN



Series 40.603

316

09.1997→ Reference	D 2840 LF 20 51.06500.6426			50 005 612
-----------------------	-------------------------------	--	--	------------

Series 41.262

317

07.1989→02.1990 Reference	D 2865 LF 51.06500.6479			50 005 613
07.1989→02.1990 Reference	D 2865 LF 51.05100.6249 51.05100.6250		50 005 833	
07.1989→02.1990 Reference	D 2865 LF 51.06500.6492			50 005 614

Series 41.292

318

10.1988→02.1990 Reference	D 2866 LF 51.06500.6479			50 005 613
10.1988→02.1990 Reference	D 2866 LF 51.06500.6492			50 005 614

Series 41.332

319

10.1988→02.1990 Reference	D 2866 LF 51.06500.6479			50 005 613
10.1988→02.1990 Reference	D 2866 LF 51.06500.6492			50 005 614

Series 41.343

320

08.1995→09.2001 Reference	D 2865 LF 21 51.05100.6250 51.05100.6252 51.05100.6260 51.05100.6262		50 005 870	
------------------------------	---	--	------------	--















Series 41.361

321

01.1985→09.1990 Reference	D 2866 KFZ 51.05100.6249 51.05100.6250		50 005 833	
------------------------------	---	--	------------	--

M



				
Series 41.364 322				
06.1998→09.2001 Reference	D 2866 LF 35 51.05100.6250 51.05100.6252 51.05100.6260 51.05100.6262		50 005 870	
Series 41.403 323				
08.1995→09.2001 Reference	D 2866 LF 20 51.05100.6250 51.05100.6252 51.05100.6260 51.05100.6262		50 005 870	
Series 41.414 324				
06.1998→12.2001 Reference	D 2866 LF 31 51.05100.6250 51.05100.6252 51.05100.6260 51.05100.6262		50 005 870	
Series 41.463 325				
08.1995→ Reference	D 2876 LF 02 51.05100.6250 51.05100.6252 51.05100.6260 51.05100.6262		50 005 870	
Series 41.464 326				
06.1998→09.2001 Reference	D 2876 LF 06 51.05100.6250 51.05100.6252 51.05100.6260 51.05100.6262		50 005 870	
Series 41.603 327				
09.1997→ Reference	D 2840 LF 20 51.06500.6426			50 005 612
Series 42.414 328				
06.1998→08.2001 Reference	D 2866 LF 31 51.05100.6250 51.05100.6252 51.05100.6260 51.05100.6262		50 005 870	
Series 42.464 329				
06.1998→08.2001 Reference	D 2876 LF 06 51.05100.6250 51.05100.6252 51.05100.6260 51.05100.6262		50 005 870	
Series 48.292 330				
07.1989→02.1990 Reference	D 2866 LF 51.06500.6479			50 005 613
07.1989→02.1990 Reference	D 2866 LF 51.06500.6492			50 005 614

M



MAN



Series 48.321

331

04.1983→11.1985
Reference

D 2566 MKF
51.05100.6249 51.05100.6250



50 005 833

04.1983→11.1985
Reference

D 2566 MKF
51.06500.6282 51.06500.6387 51.06500.9282 51.06500.9387



50 005 210

Series 48.331

332

09.1985→06.1990
Reference

D 2866 LFZ/330
51.05100.6249 51.05100.6250



50 005 833

Series 48.332

333

07.1989→02.1990
Reference

D 2866 LF
51.06500.6479



50 005 613

07.1989→02.1990
Reference

D 2866 LF
51.06500.6492



50 005 614

Series 50.403

334

06.1998→
Reference

D 2866 LF 20
51.05100.6250 51.05100.6252 51.05100.6260 51.05100.6262



50 005 870

Series 50.414

335

06.1998→09.2001
Reference

D 2866 LF 31
51.05100.6250 51.05100.6252 51.05100.6260 51.05100.6262



50 005 870

Series 50.463

336

06.1997→
Reference

D 2876 LF 02
51.05100.6250 51.05100.6252 51.05100.6260 51.05100.6262



50 005 870

Series 50.464

337

06.1997→
Reference

D 2876 LF 02, LF 06
51.05100.6250 51.05100.6252 51.05100.6260 51.05100.6262



50 005 870

Series 50.603

338

09.1997→
Reference

D 2840 LF 20
51.06500.6426



50 005 612

M



Series EL 262									339
07.1998→09.2001	D 2866	LUH 22							
Reference	51.05100.6250	51.05100.6252	51.05100.6260	51.05100.6262		50 005 870			
Series EM 192									340
10.1993→06.1997	D 0826	LOH 06							
Reference	51.06500.6495								50 005 630
	Flügelrad Durchmesser 135 mm impeller diameter 135 mm roue à ailettes 135 mm roueda con paletas 135 mm Лопастное колесо диаметр 135 мм								
10.1993→06.1997	D 0826	LOH 06							
Reference	51.06500.6476								50 005 631
	Flügelrad Durchmesser 125 mm impeller diameter 125 mm roue à ailettes 125 mm roueda con paletas 125 mm Лопастное колесо диаметр 125 мм								
Series F 292									341
03.1986→04.1994	D 2866	TUH							
Reference	51.06500.6408								50 005 205
03.1986→04.1994	D 2866	TUH							
Reference	51.05100.6135					50 005 828			
	ohne Antriebsrad, without impeller, sans roue motrice, sin rueda motriz, без ведущего колеса								
03.1986→04.1994	D 2866	TUH							
Reference	51.05100.6134	51.05100.6155				50 005 827			
	mit Antriebsrad, with impeller, avec roue motrice, con rueda motriz, с приводным колесом								
Series F 332									342
09.1985→04.1994	D 2866	LUH							
Reference	51.05100.6135					50 005 828			
	ohne Antriebsrad, without impeller, sans roue motrice, sin rueda motriz, без ведущего колеса								
09.1985→04.1994	D 2866	LUH							
Reference	51.05100.6134	51.05100.6155				50 005 827			
	mit Antriebsrad, with impeller, avec roue motrice, con rueda motriz, с приводным колесом								
Series F 362									343
05.1985→04.1994	D 2866	KUH							
Reference	51.05100.6135					50 005 828			
	ohne Antriebsrad, without impeller, sans roue motrice, sin rueda motriz, без ведущего колеса								
05.1985→04.1994	D 2866	KUH							
Reference	51.05100.6134	51.05100.6155				50 005 827			
	mit Antriebsrad, with impeller, avec roue motrice, con rueda motriz, с приводным колесом								
Series F 90									344
07.1986→01.1991	D 2866	KUL							
Reference	51.05100.6135					50 005 828			
	ohne Antriebsrad, without impeller, sans roue motrice, sin rueda motriz, без ведущего колеса								



						
07.1986→12.1987 Reference	D 2866 KF 51.05100.6249 51.05100.6250					50 005 833
07.1986→01.1991 Reference	D 2866 KUL 51.05100.6134 51.05100.6155 mit Antriebsrad, with impeller, avec roue motrice, con rueda motriz, с приводным колесом					50 005 827
Series FE 19.310						345
09.2002→06.2003 Reference	D 2866 LF 23 51.05100.6250 51.05100.6252 51.05100.6260 51.05100.6262					50 005 870
Series FE 19.360						346
09.2002→06.2003 Reference	D 2866 LF 24 51.05100.6250 51.05100.6252 51.05100.6260 51.05100.6262					50 005 870
Series FE 19.410						347
09.2002→10.2003 Reference	D 2866 LF 25 51.05100.6250 51.05100.6252 51.05100.6260 51.05100.6262					50 005 870
Series FE 19.460						348
09.2001→06.2003 Reference	D 2876 LF 03 51.05100.6250 51.05100.6252 51.05100.6260 51.05100.6262					50 005 870
Series FE 26.310						349
09.2002→06.2003 Reference	D 2866 LF 23 51.05100.6250 51.05100.6252 51.05100.6260 51.05100.6262					50 005 870
Series FE 26.360						350
09.2002→10.2003 Reference	D 2866 LF 24 51.05100.6250 51.05100.6252 51.05100.6260 51.05100.6262					50 005 870
Series FE 26.410						351
09.2002→10.2003 Reference	D 2866 LF 25 51.05100.6250 51.05100.6252 51.05100.6260 51.05100.6262					50 005 870
Series FE 26.460						352
09.2002→10.2003 Reference	D 2876 LF 03 51.05100.6250 51.05100.6252 51.05100.6260 51.05100.6262					50 005 870
Series FE 28.310						353
09.2002→12.2003 Reference	D 2866 LF 23 51.05100.6250 51.05100.6252 51.05100.6260 51.05100.6262					50 005 870

**Series FE 28.360****354**

09.2002→11.2003 D 2866 LF 24
 Reference 51.05100.6250 51.05100.6252 51.05100.6260 51.05100.6262



50 005 870

Series FE 28.410**355**

09.2002→11.2003 D 2866 LF 25
 Reference 51.05100.6250 51.05100.6252 51.05100.6260 51.05100.6262



50 005 870

Series FE 28.460**356**

09.2002→11.2003 D 2876 LF 03
 Reference 51.05100.6250 51.05100.6252 51.05100.6260 51.05100.6262



50 005 870

Series FE 30.360**357**

09.2002→06.2003 D 2866 LF 24
 Reference 51.05100.6250 51.05100.6252 51.05100.6260 51.05100.6262



50 005 870

Series FE 30.410**358**

09.2002→06.2003 D 2866 LF 25
 Reference 51.05100.6250 51.05100.6252 51.05100.6260 51.05100.6262



50 005 870

Series FE 30.460**359**

09.2002→06.2003 D 2876 LF 03
 Reference 51.05100.6250 51.05100.6252 51.05100.6260 51.05100.6262



50 005 870

M**Series FE 310****360**

07.1999→08.2002 D 2866 LF 23
 Reference 51.05100.6250 51.05100.6252 51.05100.6260 51.05100.6262



50 005 870

Series FE 32.360**361**

09.2002→10.2003 D 2866 LF 24
 Reference 51.05100.6250 51.05100.6252 51.05100.6260 51.05100.6262



50 005 870

Series FE 32.410**362**

09.2002→10.2003 D 2866 LF 25
 Reference 51.05100.6250 51.05100.6252 51.05100.6260 51.05100.6262



50 005 870

Series FE 32.460**363**

08.2002→10.2003 D 2876 LF 03
 Reference 51.05100.6250 51.05100.6252 51.05100.6260 51.05100.6262



50 005 870

Series FE 33.360**364**

09.2002→06.2003 D 2866 LF 24
 Reference 51.05100.6250 51.05100.6252 51.05100.6260 51.05100.6262



50 005 870



MAN



Series FE 33.410					365	
09.2002→06.2003	D 2866	LF 25				50 005 870
Reference	51.05100.6250	51.05100.6252	51.05100.6260	51.05100.6262		
Series FE 33.460					366	
08.2002→06.2003	D 2876	LF 03				50 005 870
Reference	51.05100.6250	51.05100.6252	51.05100.6260	51.05100.6262		
Series FE 35.310					367	
09.2002→09.2003	D 2866	LF 23				50 005 870
Reference	51.05100.6250	51.05100.6252	51.05100.6260	51.05100.6262		
Series FE 35.360					368	
08.2002→09.2003	D 2866	LF 24				50 005 870
Reference	51.05100.6250	51.05100.6252	51.05100.6260	51.05100.6262		
Series FE 35.410					369	
09.2002→10.2003	D 2866	LF 25				50 005 870
Reference	51.05100.6250	51.05100.6252	51.05100.6260	51.05100.6262		
Series FE 35.460					370	
09.2002→10.2003	D 2876	LF 03				50 005 870
Reference	51.05100.6250	51.05100.6252	51.05100.6260	51.05100.6262		
Series FE 360					371	
01.2000→09.2002	D 2866	LF 24				50 005 870
Reference	51.05100.6250	51.05100.6252	51.05100.6260	51.05100.6262		
Series FE 41.410					372	
09.2002→09.2003	D 2866	LF 25				50 005 870
Reference	51.05100.6250	51.05100.6252	51.05100.6260	51.05100.6262		
Series FE 41.460					373	
09.2002→09.2003	D 2876	LF 03				50 005 870
Reference	51.05100.6250	51.05100.6252	51.05100.6260	51.05100.6262		
Series FE 410					374	
07.1999→09.2002	D 2866	LF 25				50 005 870
Reference	51.05100.6250	51.05100.6252	51.05100.6260	51.05100.6262		
Series FE 460					375	
01.2000→09.2002	D 2876	LF 03				50 005 870
Reference	51.05100.6250	51.05100.6252	51.05100.6260	51.05100.6262		















M



Series FE 50.410									376
09.2002→09.2003	D 2866	LF 25							
Reference	51.05100.6250	51.05100.6252	51.05100.6260	51.05100.6262		50 005 870			
Series FE 50.460									377
09.2002→09.2003	D 2876	LF 03							
Reference	51.05100.6250	51.05100.6252	51.05100.6260	51.05100.6262		50 005 870			
Series FR 292									378
04.1985→12.1994	D 2866	TUH							
Reference	51.06500.6408								50 005 205
04.1985→12.1994	D 2866	TUH							
Reference	51.05100.6135	ohne Antriebsrad, without impeller, sans roue motrice, sin rueda motriz, без ведущего колеса				50 005 828			
04.1985→12.1994	D 2866	TUH							
Reference	51.05100.6134	51.05100.6155				50 005 827			
		mit Antriebsrad, with impeller, avec roue motrice, con rueda motriz, с приводным колесом							
Series FRH 292									379
03.1986→04.1992	D 2866	TUH							
Reference	51.06500.6408								50 005 205
03.1986→04.1992	D 2866	TUH							
Reference	51.05100.6135	ohne Antriebsrad, without impeller, sans roue motrice, sin rueda motriz, без ведущего колеса				50 005 828			
03.1986→04.1992	D 2866	TUH							
Reference	51.05100.6134	51.05100.6155				50 005 827			
		mit Antriebsrad, with impeller, avec roue motrice, con rueda motriz, с приводным колесом							
Series FRH 352									380
09.1995→09.2001	D 2866	LOH 26, LUH 21							
Reference	51.05100.6250	51.05100.6252	51.05100.6260	51.05100.6262		50 005 870			
Series FRH 362									381
05.1985→12.1992	D 2866	KUH							
Reference	51.05100.6135	ohne Antriebsrad, without impeller, sans roue motrice, sin rueda motriz, без ведущего колеса				50 005 828			
05.1985→12.1992	D 2866	KUH							
Reference	51.05100.6134	51.05100.6155				50 005 827			
		mit Antriebsrad, with impeller, avec roue motrice, con rueda motriz, с приводным колесом							





MAN



							
Series FRH 402				382			
09.1995→09.2001 Reference	D 2866 51.05100.6250	LOH 23, LOH 26 51.05100.6252	51.05100.6260	51.05100.6262		50 005 870	
Series FRH 422				383			
01.1993→09.1996 Reference	D 2866 51.05100.6250	LOH 20, LOH 21 51.05100.6252	51.05100.6260	51.05100.6262		50 005 870	
Series H 332				384			
03.1985→07.1993 Reference	D 2866 51.05100.6135	LUH ohne Antriebsrad, without impeller, sans roue motrice, sin rueda motriz, без ведущего колеса				50 005 828	
03.1985→07.1993 Reference	D 2866 51.05100.6134	LUH 51.05100.6155 mit Antriebsrad, with impeller, avec roue motrice, con rueda motriz, с приводным колесом				50 005 827	
Series H 362				385			
04.1985→07.1993 Reference	D 2866 51.05100.6135	KUH ohne Antriebsrad, without impeller, sans roue motrice, sin rueda motriz, без ведущего колеса				50 005 828	
04.1985→07.1993 Reference	D 2866 51.05100.6134	KUH 51.05100.6155 mit Antriebsrad, with impeller, avec roue motrice, con rueda motriz, с приводным колесом				50 005 827	
Series RHS 414				386			
10.2001→ Reference	D 2866 51.05100.6250	LOH 34 51.05100.6252	51.05100.6260	51.05100.6262		50 005 870	
Series RHS 464				387			
10.2001→ Reference	D 2876 51.05100.6250	LOH 03 51.05100.6252	51.05100.6260	51.05100.6262		50 005 870	
Series HF 292				388			
03.1986→04.1994 Reference	D 2866 51.06500.6408	TUH					50 005 205
03.1986→04.1994 Reference	D 2866 51.05100.6135	TUH ohne Antriebsrad, without impeller, sans roue motrice, sin rueda motriz, без ведущего колеса				50 005 828	
03.1986→04.1994 Reference	D 2866 51.05100.6134	TUH 51.05100.6155 mit Antriebsrad, with impeller, avec roue motrice, con rueda motriz, с приводным колесом				50 005 827	

M

**Series HF 332****389**

09.1985→04.1994	D 2866 LUH				
Reference	51.05100.6135				50 005 828
	ohne Antriebsrad, without impeller, sans roue motrice, sin rueda motriz, без ведущего колеса				
09.1985→04.1994	D 2866 LUH				
Reference	51.05100.6134 51.05100.6155				50 005 827
	mit Antriebsrad, with impeller, avec roue motrice, con rueda motriz, с приводным колесом				



Series HF 362**390**

06.1985→07.1993	D 2866 KUH				
Reference	51.05100.6135				50 005 828
	ohne Antriebsrad, without impeller, sans roue motrice, sin rueda motriz, без ведущего колеса				
06.1985→07.1993	D 2866 KUH				
Reference	51.05100.6134 51.05100.6155				50 005 827
	mit Antriebsrad, with impeller, avec roue motrice, con rueda motriz, с приводным колесом				

Series L 313**391**

09.1996→	D 2866 LUH 20				
Reference	51.05100.6250 51.05100.6252 51.05100.6260 51.05100.6262				50 005 870

Series NG 232**392**

01.1995→06.1999	E 2866 DUH 01				
Reference	51.05100.6135				50 005 828
	ohne Antriebsrad, without impeller, sans roue motrice, sin rueda motriz, без ведущего колеса				
01.1995→06.1999	E 2866 DUH 01				
Reference	51.05100.6134 51.05100.6155				50 005 827
	mit Antriebsrad, with impeller, avec roue motrice, con rueda motriz, с приводным колесом				

Series NG 262**393**

07.1998→11.1999	D 2866 LUH 22				
Reference	51.05100.6250 51.05100.6252 51.05100.6260 51.05100.6262				50 005 870

Series NG 263**394**

07.1998→	D 2866 LUH 22, LUH 23				
Reference	51.05100.6250 51.05100.6252 51.05100.6260 51.05100.6262				50 005 870

Series NG 272**395**

08.1992→09.1995	D 0826 LOH 01				
Reference	51.06500.6495				50 005 630
	Flügelrad Durchmesser 135 mm impeller diameter 135 mm roue à ailettes 135 mm roueda con paletas 135 mm Лопастное колесо диаметр 135 мм				
08.1992→09.1995	D 0826 LOH 01				
Reference	51.06500.6476				50 005 631
	Flügelrad Durchmesser 125 mm impeller diameter 125 mm roue à ailettes 125 mm roueda con paletas 125 mm Лопастное колесо диаметр 125 мм				



MAN

Series NG 312								396		
07.1998→11.1999	D 2866	LUH 26				50 005 870				
Reference	51.05100.6250	51.05100.6252	51.05100.6260	51.05100.6262						
Series NG 313								397		
07.1998→	D 2866	LUH 24, LUH 26				50 005 870				
Reference	51.05100.6250	51.05100.6252	51.05100.6260	51.05100.6262						
Series NG 333								398		
01.2001→	D 2866	LUH 25				50 005 870				
Reference	51.05100.6250	51.05100.6252	51.05100.6260	51.05100.6262						
Series NG 353								399		
01.2001→12.2001	D 2866	LUH 21				50 005 870				
Reference	51.05100.6250	51.05100.6252	51.05100.6260	51.05100.6262						
Series NG 363								400		
01.2001→	D 2866	LUH 21, LUH 25				50 005 870				
Reference	51.05100.6250	51.05100.6252	51.05100.6260	51.05100.6262						
M	Series NL 232								401	
	03.1993→07.1999	E 2866	DUH 01				50 005 828			
	Reference	51.05100.6135	ohne Antriebsrad, without impeller, sans roue motrice, sin rueda motriz, без ведущего колеса							
03.1993→07.1999	E 2866	DUH 01				50 005 827				
Reference	51.05100.6134	51.05100.6155	mit Antriebsrad, with impeller, avec roue motrice, con rueda motriz, с приводным колесом							
Series NL 233								402		
07.1998→12.2001	E 2866	DUH 02				50 005 828				
Reference	51.05100.6135	ohne Antriebsrad, without impeller, sans roue motrice, sin rueda motriz, без ведущего колеса								
07.1998→12.2001	E 2866	DUH 02				50 005 827				
Reference	51.05100.6134	51.05100.6155	mit Antriebsrad, with impeller, avec roue motrice, con rueda motriz, с приводным колесом							
Series NL 262								403		
07.1998→11.1999	D 2866	LUH 22				50 005 870				
Reference	51.05100.6250	51.05100.6252	51.05100.6260	51.05100.6262						
Series NL 263								404		
07.1998→	D 2866	LUH 22, LUH 23				50 005 870				
Reference	51.05100.6250	51.05100.6252	51.05100.6260	51.05100.6262						



Series NL 313							405		
07.1998→ Reference	D 2866 51.05100.6250	LUH 24, LUH 26 51.05100.6252	51.05100.6260	51.05100.6262		50 005 870			
Series NL 353							406		
08.1998→12.2001 Reference	D 2866 51.05100.6250	LUH 21 51.05100.6252	51.05100.6260	51.05100.6262		50 005 870			
Series NL 363							407		
01.2001→ Reference	D 2866 51.05100.6250	LUH 25 51.05100.6252	51.05100.6260	51.05100.6262		50 005 870			
Series NM 192							408		
10.1993→03.1997 Reference	D 0826 51.06500.6495	LOH 01					50 005 630		
	Flügelrad Durchmesser 135 mm impeller diameter 135 mm roue à ailettes 135 mm roueda con paletas 135 mm Лопастное колесо диаметр 135 мм								
10.1993→03.1997 Reference	D 0826 51.06500.6476	LOH 01					50 005 631		
	Flügelrad Durchmesser 125 mm impeller diameter 125 mm roue à ailettes 125 mm roueda con paletas 135 mm Лопастное колесо диаметр 125 мм								
Series NM 223							409		
09.2000→ Reference	D 0826 51.06500.6495	LOH					50 005 630		
	Flügelrad Durchmesser 135 mm impeller diameter 135 mm roue à ailettes 135 mm roueda con paletas 135 mm Лопастное колесо диаметр 135 мм								
09.2000→ Reference	D 0826 51.06500.6476	LOH					50 005 631		
	Flügelrad Durchmesser 125 mm impeller diameter 125 mm roue à ailettes 125 mm roueda con paletas 135 mm Лопастное колесо диаметр 125 мм								
Series NUE 233							410		
07.1998→ Reference	E 2866 51.05100.6135	DUH 02				50 005 828			
	ohne Antriebsrad, without impeller, sans roue motrice, sin rueda motriz, без ведущего колеса								
07.1998→ Reference	E 2866 51.05100.6134	DUH 02	51.05100.6155				50 005 827		
	mit Antriebsrad, with impeller, avec roue motrice, con rueda motriz, с приводным колесом								
Series NUE 263							411		
07.1998→ Reference	D 2866 51.05100.6250	LUH 22, LUH 23 51.05100.6252	51.05100.6260	51.05100.6262		50 005 870			

**MAN****Series NUE 313****412**

02.1998→
Reference D 2866 LUH 21, LUH 24, LUH 26
51.05100.6250 51.05100.6252 51.05100.6260 51.05100.6262

**50 005 870****Series NUE 353****413**

02.1998→12.2001
Reference D 2866 LUH 21
51.05100.6250 51.05100.6252 51.05100.6260 51.05100.6262

**50 005 870****Series NUE 363****414**

01.2001→
Reference D 2866 LUH 25
51.05100.6250 51.05100.6252 51.05100.6260 51.05100.6262

**50 005 870****Series R 292****415**

03.1986→04.1992
Reference D 2866 TUH
51.06500.6408

**50 005 205**

03.1986→04.1992
Reference D 2866 TUH
51.05100.6135
ohne Antriebsrad, without impeller, sans roue motrice, sin rueda motriz, без ведущего колеса

**50 005 828**

03.1986→04.1992
Reference D 2866 TUH
51.05100.6134 51.05100.6155
mit Antriebsrad, with impeller, avec roue motrice, con rueda motriz, с приводным колесом

**50 005 827****Series R 313****416**

07.1998→12.2001
Reference D 2866 LUH 26
51.05100.6250 51.05100.6252 51.05100.6260 51.05100.6262

**50 005 870****Series R 353****417**

07.1998→
Reference D 2866 LUH 21
51.05100.6250 51.05100.6252 51.05100.6260 51.05100.6262

**50 005 870****Series RH 352****418**

07.1998→09.2001
Reference D 2866 LOH 26
51.05100.6250 51.05100.6252 51.05100.6260 51.05100.6262

**50 005 870****Series RH 353****419**















09.1998→09.2001
Reference D 2866 LOH 26
51.05100.6250 51.05100.6252 51.05100.6260 51.05100.6262

**50 005 870****Series RH 402****420**

07.1998→09.2001
Reference D 2866 LOH 23
51.05100.6250 51.05100.6252 51.05100.6260 51.05100.6262



























**50 005 870****M**



				
Series RH 403 421				
09.1998→ Reference	D 2866 LOH 23, LUH 30 51.05100.6250 51.05100.6252 51.05100.6260 51.05100.6262		50 005 870	
Series RH 414 422				
09.2001→ Reference	D 2866 LOH 34 51.05100.6250 51.05100.6252 51.05100.6260 51.05100.6262		50 005 870	
Series RH 463 423				
06.1999→09.2001 Reference	D 2876 LOH 01 51.05100.6250 51.05100.6252 51.05100.6260 51.05100.6262		50 005 870	
Series RH 464 424				
09.2002→ Reference	D 2876 LOH 03 51.05100.6250 51.05100.6252 51.05100.6260 51.05100.6262		50 005 870	
Series RHC 414 425				
09.2002→ Reference	D 2866 LOH 34 51.05100.6250 51.05100.6252 51.05100.6260 51.05100.6262		50 005 870	
Series RHC 464 426				
09.2002→ Reference	D 2876 LOH 03 51.05100.6250 51.05100.6252 51.05100.6260 51.05100.6262		50 005 870	
Series RN 313 427				
09.1996→03.1998 Reference	D 2866 LUH 20 51.05100.6250 51.05100.6252 51.05100.6260 51.05100.6262		50 005 870	
Series RN 353 428				
06.1997→03.1998 Reference	D 2866 LUH 21 51.05100.6250 51.05100.6252 51.05100.6260 51.05100.6262		50 005 870	
Series RUE 240 429				
01.1980→12.1988 Reference	D 2866 UH 51.05100.6135 ohne Antriebsrad, without impeller, sans roue motrice, sin rueda motriz, без ведущего колеса		50 005 828	
01.1980→12.1988 Reference	D 2866 UH 51.05100.6134 51.05100.6155 mit Antriebsrad, with impeller, avec roue motrice, con rueda motriz, с приводным колесом		50 005 827	
Series RUE 280 430				
01.1980→12.1988 Reference	D 2566 MTUH 51.05100.6135 ohne Antriebsrad, without impeller, sans roue motrice, sin rueda motriz, без ведущего колеса		50 005 828	



MAN

				
01.1980→12.1988 Reference 	D 2566 MTUH 51.05100.6134 51.05100.6155 mit Antriebsrad, with impeller, avec roue motrice, con rueda motriz, с приводным колесом		50 005 827	
Series SB 280				431
05.1980→11.1986 Reference 	D 2566 MTUH 51.05100.6135 ohne Antriebsrad, without impeller, sans roue motrice, sin rueda motriz, без ведущего колеса		50 005 828	
05.1980→11.1986 Reference 	D 2566 MTUH 51.05100.6134 51.05100.6155 mit Antriebsrad, with impeller, avec roue motrice, con rueda motriz, с приводным колесом		50 005 827	
Series SD 200				432
10.1975→12.1986 Reference 	D 2566 MUH 51.05100.6135 ohne Antriebsrad, without impeller, sans roue motrice, sin rueda motriz, без ведущего колеса		50 005 828	
10.1975→12.1986 Reference 	D 2566 MUH 51.05100.6134 51.05100.6155 mit Antriebsrad, with impeller, avec roue motrice, con rueda motriz, с приводным колесом		50 005 827	
Series SD 202				433
10.1985→04.1994 Reference 	D 2566 UH 51.05100.6135 ohne Antriebsrad, without impeller, sans roue motrice, sin rueda motriz, без ведущего колеса		50 005 828	
10.1985→04.1994 Reference 	D 2566 UH 51.05100.6134 51.05100.6155 mit Antriebsrad, with impeller, avec roue motrice, con rueda motriz, с приводным колесом		50 005 827	
Series SD 240				434
10.1975→04.1980 Reference 	D 2566 MUH 51.05100.6135 ohne Antriebsrad, without impeller, sans roue motrice, sin rueda motriz, без ведущего колеса		50 005 828	
10.1975→04.1980 Reference 	D 2566 MUH 51.05100.6134 51.05100.6155 mit Antriebsrad, with impeller, avec roue motrice, con rueda motriz, с приводным колесом		50 005 827	
Series SG 240				435
01.1986→12.1986 Reference	D 2866 TUH 51.06500.6408			50 005 205
05.1980→01.1986 01.1986→12.1986 Reference 	D 2566 MTUH, MUH D 2866 TUH, UH 51.05100.6135 ohne Antriebsrad, without impeller, sans roue motrice, sin rueda motriz, без ведущего колеса		50 005 828	
05.1980→01.1986 01.1986→12.1986 Reference 	D 2566 MTUH, MUH D 2866 TUH, UH 51.05100.6134 51.05100.6155 mit Antriebsrad, with impeller, avec roue motrice, con rueda motriz, с приводным колесом		50 005 827	

M



Series SG 242

436

09.1985→04.1994 Reference	D 2866 TUH 51.06500.6408				50 005 205
11.1984→09.1985 09.1985→04.1994 Reference	D 2566 MUH D 2866 TUH, UH 51.05100.6135 ohne Antriebsrad, without impeller, sans roue motrice, sin rueda motriz, без ведущего колеса			50 005 828	
11.1984→09.1985 09.1985→04.1994 Reference	D 2566 MUH D 2866 TUH, UH 51.05100.6134 51.05100.6155 mit Antriebsrad, with impeller, avec roue motrice, con rueda motriz, с приводным колесом			50 005 827	

Series SG 263

437

06.2003→ Reference	D 2866 LUH 23, LUH 24 51.05100.6250 51.05100.6252 51.05100.6260 51.05100.6262			50 005 870	
-----------------------	--	--	--	------------	--

Series SG 280

438

05.1980→11.1986 Reference	D 2566 MTUH 51.05100.6135 ohne Antriebsrad, without impeller, sans roue motrice, sin rueda motriz, без ведущего колеса			50 005 828	
05.1980→11.1986 Reference	D 2566 MTUH 51.05100.6134 51.05100.6155 mit Antriebsrad, with impeller, avec roue motrice, con rueda motriz, с приводным колесом			50 005 827	

Series SG 292

439

11.1984→09.1989 Reference	D 2866 TUH 51.06500.6408				50 005 205
11.1984→09.1989 Reference	D 2866 TUH 51.05100.6135 ohne Antriebsrad, without impeller, sans roue motrice, sin rueda motriz, без ведущего колеса			50 005 828	
11.1984→09.1989 Reference	D 2866 TUH 51.05100.6134 51.05100.6155 mit Antriebsrad, with impeller, avec roue motrice, con rueda motriz, с приводным колесом			50 005 827	

Series SG 313

440

























06.2004→ Reference	D 2866 LUH 24 51.05100.6250 51.05100.6252 51.05100.6260 51.05100.6262			50 005 870	
-----------------------	--	--	--	------------	--

Series SL 200

441



























10.1975→04.1987 01.1986→04.1987 Reference	D 2566 MUH, UH D 2866 UH 51.05100.6135 ohne Antriebsrad, without impeller, sans roue motrice, sin rueda motriz, без ведущего колеса			50 005 828	
---	--	--	--	------------	--

**MAN**

				
10.1975→04.1987 01.1986→04.1987 Reference 	D 2566 MUH, UH D 2866 UH 51.05100.6134 51.05100.6155 mit Antriebsrad, with impeller, avec roue motrice, con rueda motriz, с приводным колесом			50 005 827
Series SL 202				442
04.1996→01.1998 Reference 	E 2866 DUH 02 51.05100.6135 ohne Antriebsrad, without impeller, sans roue motrice, sin rueda motriz, без ведущего колеса			50 005 828
04.1996→01.1998 Reference 	E 2866 DUH 02 51.05100.6134 51.05100.6155 mit Antriebsrad, with impeller, avec roue motrice, con rueda motriz, с приводным колесом			50 005 827
Series SL II 202				443
06.1984→04.1993 06.1984→04.1994 01.1992→01.1998 Reference 	D 2566 UH D 2866 UH E 2866 DUH 01 51.05100.6135 ohne Antriebsrad, without impeller, sans roue motrice, sin rueda motriz, без ведущего колеса			50 005 828
06.1984→04.1993 06.1984→04.1994 01.1992→01.1998 Reference 	D 2566 UH D 2866 UH E 2866 DUH 01 51.05100.6134 51.05100.6155 mit Antriebsrad, with impeller, avec roue motrice, con rueda motriz, с приводным колесом			50 005 827
Series SM 192				444
04.1992→02.1995 Reference 	D 0826 LOH 01 51.06500.6495 Flügelrad Durchmesser 135 mm impeller diameter 135 mm roue à ailettes 135 mm roueda con paletas 135 mm Лопастное колесо диаметр 135 мм			50 005 630
04.1992→02.1995 Reference 	D 0826 LOH 01 51.06500.6476 Flügelrad Durchmesser 125 mm impeller diameter 125 mm roue à ailettes 125 mm roueda con paletas 135 mm Лопастное колесо диаметр 125 мм			50 005 631
Series SR 240				445
10.1975→06.1983 Reference 	D 2566 MUH 51.05100.6135 ohne Antriebsrad, without impeller, sans roue motrice, sin rueda motriz, без ведущего колеса			50 005 828
10.1975→06.1983 Reference 	D 2566 MUH 51.05100.6134 51.05100.6155 mit Antriebsrad, with impeller, avec roue motrice, con rueda motriz, с приводным колесом			50 005 827
Series SR 280				446
01.1977→11.1986 Reference 	D 2566 MTUH 51.05100.6135 ohne Antriebsrad, without impeller, sans roue motrice, sin rueda motriz, без ведущего колеса			50 005 828

M



				
01.1977→11.1986 Reference 	D 2566 MTUH 51.05100.6134 51.05100.6155 mit Antriebsrad, with impeller, avec roue motrice, con rueda motriz, с приводным колесом		50 005 827	
Series SR 292				447
05.1985→12.1985 Reference	D 2866 TUH 51.06500.6408			50 005 205
05.1985→12.1985 Reference 	D 2866 TUH 51.05100.6135 ohne Antriebsrad, without impeller, sans roue motrice, sin rueda motriz, без ведущего колеса		50 005 828	
05.1985→12.1985 Reference 	D 2866 TUH 51.05100.6134 51.05100.6155 mit Antriebsrad, with impeller, avec roue motrice, con rueda motriz, с приводным колесом		50 005 827	
Series SR 321				448
05.1980→06.1983 Reference 	D 2566 MTUH 51.05100.6135 ohne Antriebsrad, without impeller, sans roue motrice, sin rueda motriz, без ведущего колеса		50 005 828	
05.1980→06.1983 Reference 	D 2566 MTUH 51.05100.6134 51.05100.6155 mit Antriebsrad, with impeller, avec roue motrice, con rueda motriz, с приводным колесом		50 005 827	
Series SR 322				449
09.1985→04.1994 Reference 	D 2866 LUH 51.05100.6135 ohne Antriebsrad, without impeller, sans roue motrice, sin rueda motriz, без ведущего колеса		50 005 828	
09.1985→04.1994 Reference 	D 2866 LUH 51.05100.6134 51.05100.6155 mit Antriebsrad, with impeller, avec roue motrice, con rueda motriz, с приводным колесом		50 005 827	
Series SR 361				450
06.1984→01.1991 Reference 	D 2866 KUH, KUL 51.05100.6135 ohne Antriebsrad, without impeller, sans roue motrice, sin rueda motriz, без ведущего колеса		50 005 828	
06.1984→01.1991 Reference 	D 2866 KUH, KUL 51.05100.6134 51.05100.6155 mit Antriebsrad, with impeller, avec roue motrice, con rueda motriz, с приводным колесом		50 005 827	
Series SR 362				451
09.1985→12.1985 Reference 	D 2866 KUH 51.05100.6135 ohne Antriebsrad, without impeller, sans roue motrice, sin rueda motriz, без ведущего колеса		50 005 828	
09.1985→12.1985 Reference 	D 2866 KUH 51.05100.6134 51.05100.6155 mit Antriebsrad, with impeller, avec roue motrice, con rueda motriz, с приводным колесом		50 005 827	



MAN



Series SUE 240

452

01.1986→09.1989 Reference	D 2866 TUH 51.06500.6408			50 005 205
10.1975→09.1989 01.1986→09.1989 Reference	D 2566 MTUH, MUH, UH D 2866 TUH, UH 51.05100.6135 ohne Antriebsrad, without impeller, sans roue motrice, sin rueda motriz, без ведущего колеса			50 005 828
10.1975→09.1989 01.1986→09.1989 Reference	D 2566 MTUH, MUH, UH D 2866 TUH, UH 51.05100.6134 51.05100.6155 mit Antriebsrad, with impeller, avec roue motrice, con rueda motriz, с приводным колесом			50 005 827

Series SUE 242

453

11.1984→09.1985 01.1987→04.1993 Reference	D 2566 MUH D 2866 UH 51.05100.6135 ohne Antriebsrad, without impeller, sans roue motrice, sin rueda motriz, без ведущего колеса			50 005 828
11.1984→09.1985 01.1987→04.1993 Reference	D 2566 MUH D 2866 UH 51.05100.6134 51.05100.6155 mit Antriebsrad, with impeller, avec roue motrice, con rueda motriz, с приводным колесом			50 005 827

Series SUE 272

454

04.1993→05.1995 Reference	D 2865 LUH 02 51.05100.6135 ohne Antriebsrad, without impeller, sans roue motrice, sin rueda motriz, без ведущего колеса			50 005 828
04.1993→05.1995 Reference	D 2865 LUH 02 51.05100.6134 51.05100.6155 mit Antriebsrad, with impeller, avec roue motrice, con rueda motriz, с приводным колесом			50 005 827

Series SUE 313

455

11.1999→ Reference	D 2866 LUH 24, LUH 26 51.05100.6250 51.05100.6252 51.05100.6260 51.05100.6262			50 005 870
-----------------------	--	--	--	------------

Series SUE 363

456

06.2004→ Reference	D 2866 LUH 25 51.05100.6250 51.05100.6252 51.05100.6260 51.05100.6262			50 005 870
-----------------------	--	--	--	------------

Series SUE 383

457

06.2004→ Reference	D 2866 LUH 25 51.05100.6250 51.05100.6252 51.05100.6260 51.05100.6262			50 005 870
-----------------------	--	--	--	------------

Series TG 460

458

03.1999→08.2002 Reference	D 2876 LF 04 51.05100.6250 51.05100.6252 51.05100.6260 51.05100.6262			50 005 870
------------------------------	---	--	--	------------



Series TG 510					459	
03.1999→08.2002	D 2876	LF 05				50 005 870
Reference	51.05100.6250	51.05100.6252	51.05100.6260	51.05100.6262		
Series TGA 18.310					460	
09.2002→12.2005	D 2866	LF 26				50 005 870
Reference	51.05100.6250	51.05100.6252	51.05100.6260	51.05100.6262		
Series TGA 18.360					461	
09.2002→12.2005	D 2866	LF 27				50 005 870
Reference	51.05100.6250	51.05100.6252	51.05100.6260	51.05100.6262		
Series TGA 18.410					462	
09.2002→12.2005	D 2866	LF 28				50 005 870
Reference	51.05100.6250	51.05100.6252	51.05100.6260	51.05100.6262		
Series TGA 18.460					463	
04.2000→	D 2876	LF 04, LF 07				50 005 870
Reference	51.05100.6250	51.05100.6252	51.05100.6260	51.05100.6262		
Series TGA 18.510					464	
09.2002→06.2003	D 2876	LF 05				50 005 870
Reference	51.05100.6250	51.05100.6252	51.05100.6260	51.05100.6262		
Series TGA 19.460					465	
04.2000→	D 2876	LF 07				50 005 870
Reference	51.05100.6250	51.05100.6252	51.05100.6260	51.05100.6262		
Series TGA 24.360					466	
11.2002→05.2004	D 2866	LF 27				50 005 870
Reference	51.05100.6250	51.05100.6252	51.05100.6260	51.05100.6262		
Series TGA 24.410					467	
11.2002→05.2004	D 2866	LF 28				50 005 870
Reference	51.05100.6250	51.05100.6252	51.05100.6260	51.05100.6262		
Series TGA 24.460					468	
11.2002→05.2004	D 2876	LF 04				50 005 870
Reference	51.05100.6250	51.05100.6252	51.05100.6260	51.05100.6262		
Series TGA 24.510					469	
11.2002→06.2003	D 2876	LF 05				50 005 870
Reference	51.05100.6250	51.05100.6252	51.05100.6260	51.05100.6262		

M

**MAN****Series TGA 26.310****470**

02.2000→06.2004 D 2866 LF 26
 Reference 51.05100.6250 51.05100.6252 51.05100.6260 51.05100.6262



50 005 870

Series TGA 26.360**471**

09.2002→06.2004 D 2866 LF 27
 Reference 51.05100.6250 51.05100.6252 51.05100.6260 51.05100.6262



50 005 870

Series TGA 26.410**472**

09.2002→06.2004 D 2866 LF 28
 Reference 51.05100.6250 51.05100.6252 51.05100.6260 51.05100.6262



50 005 870

Series TGA 26.460**473**

04.2000→ D 2876 LF 04, LF 07
 Reference 51.05100.6250 51.05100.6252 51.05100.6260 51.05100.6262



50 005 870

Series TGA 26.510**474**

09.2002→06.2003 D 2876 LF 05
 Reference 51.05100.6250 51.05100.6252 51.05100.6260 51.05100.6262



50 005 870

M**Series TGA 28.310****475**

09.2002→05.2004 D 2866 LF 26
 Reference 51.05100.6250 51.05100.6252 51.05100.6260 51.05100.6262



50 005 870

Series TGA 28.360**476**

09.2002→ D 2866 LF 27
 Reference 51.05100.6250 51.05100.6252 51.05100.6260 51.05100.6262



50 005 870

Series TGA 28.410**477**

09.2002→06.2005 D 2866 LF 28
 Reference 51.05100.6250 51.05100.6252 51.05100.6260 51.05100.6262



50 005 870

Series TGA 28.460**478**

09.2002→05.2004 D 2876 LF 04
 Reference 51.05100.6250 51.05100.6252 51.05100.6260 51.05100.6262



50 005 870

Series TGA 28.510**479**

09.2002→06.2003 D 2876 LF 05
 Reference 51.05100.6250 51.05100.6252 51.05100.6260 51.05100.6262



50 005 870

Series TGA 310**480**

02.2000→ D 2866 LF 23, LF 26, LF 34, LF 36
 Reference 51.05100.6250 51.05100.6252 51.05100.6260 51.05100.6262



50 005 870

**Series TGA 32.310****481**

06.2002→05.2004	D 2866	LF 26			
Reference	51.05100.6250	51.05100.6252	51.05100.6260	51.05100.6262	



50 005 870

Series TGA 32.360**482**

09.2002→06.2005	D 2866	LF 27			
Reference	51.05100.6250	51.05100.6252	51.05100.6260	51.05100.6262	



50 005 870

Series TGA 32.410**483**

09.2002→06.2005	D 2866	LF 28			
Reference	51.05100.6250	51.05100.6252	51.05100.6260	51.05100.6262	



50 005 870

Series TGA 32.460**484**

09.2002→06.2005	D 2876	LF 04			
Reference	51.05100.6250	51.05100.6252	51.05100.6260	51.05100.6262	



50 005 870

Series TGA 33.360**485**

09.2002→05.2004	D 2866	LF 27			
Reference	51.05100.6250	51.05100.6252	51.05100.6260	51.05100.6262	



50 005 870

Series TGA 33.410**486**

09.2002→05.2004	D 2866	LF 28			
Reference	51.05100.6250	51.05100.6252	51.05100.6260	51.05100.6262	



50 005 870

M**Series TGA 33.460****487**

09.2002→	D 2876	LF 04, LF 07			
Reference	51.05100.6250	51.05100.6252	51.05100.6260	51.05100.6262	



50 005 870

Series TGA 33.510**488**

09.2002→06.2003	D 2876	LF 05			
Reference	51.05100.6250	51.05100.6252	51.05100.6260	51.05100.6262	



50 005 870

Series TGA 35.310**489**

06.2003→06.2005	D 2866	LF 26			
Reference	51.05100.6250	51.05100.6252	51.05100.6260	51.05100.6262	



50 005 870

Series TGA 35.360**490**

09.2002→12.2005	D 2866	LF 27			
Reference	51.05100.6250	51.05100.6252	51.05100.6260	51.05100.6262	



50 005 870

Series TGA 35.410**491**

06.2003→12.2005	D 2866	LF 28			
Reference	51.05100.6250	51.05100.6252	51.05100.6260	51.05100.6262	



50 005 870

**MAN**

Series TGA 35.460					492	
06.2003→12.2005	D 2876	LF 04				50 005 870
Reference	51.05100.6250	51.05100.6252	51.05100.6260	51.05100.6262		
Series TGA 360					493	
02.2000→	D 2866	LF 24, LF 27, LF 35, LF 37				50 005 870
Reference	51.05100.6250	51.05100.6252	51.05100.6260	51.05100.6262		
Series TGA 37.360					494	
05.2004→12.2005	D 2866	LF 27				50 005 870
Reference	51.05100.6250	51.05100.6252	51.05100.6260	51.05100.6262		
Series TGA 37.410					495	
05.2004→12.2005	D 2866	LF 28				50 005 870
Reference	51.05100.6250	51.05100.6252	51.05100.6260	51.05100.6262		
Series TGA 37.460					496	
05.2004→06.2005	D 2876	LF 04				50 005 870
Reference	51.05100.6250	51.05100.6252	51.05100.6260	51.05100.6262		
Series TGA 40.410					497	
05.2004→12.2005	D 2866	LF 28				50 005 870
Reference	51.05100.6250	51.05100.6252	51.05100.6260	51.05100.6262		
Series TGA 40.460					498	
04.2004→	D 2876	LF 07				50 005 870
Reference	51.05100.6250	51.05100.6252	51.05100.6260	51.05100.6262		
Series TGA 41.360					499	
09.2002→12.2005	D 2866	LF 27				50 005 870
Reference	51.05100.6250	51.05100.6252	51.05100.6260	51.05100.6262		
Series TGA 41.410					500	
09.2002→05.2004	D 2866	LF 28				50 005 870
Reference	51.05100.6250	51.05100.6252	51.05100.6260	51.05100.6262		
Series TGA 41.460					501	
09.2002→	D 2876	LF 04, LF 07				50 005 870
Reference	51.05100.6250	51.05100.6252	51.05100.6260	51.05100.6262		
Series TGA 410					502	
02.2000→	D 2866	LF 25, LF 28, LF 31, LF 32				50 005 870
Reference	51.05100.6250	51.05100.6252	51.05100.6260	51.05100.6262		

M



Series TGA 460									503
02.2000→ Reference	D 2876	LF 03, LF 04, LF 07					50 005 870		
	51.05100.6250	51.05100.6252	51.05100.6260	51.05100.6262					
Series TGA 510									504
02.2000→08.2002 Reference	D 2876	LF 05					50 005 870		
	51.05100.6250	51.05100.6252	51.05100.6260	51.05100.6262					
Series UEH 270									505
09.1983→ Reference	D 2866	LXUH					50 005 828		
	51.05100.6135	ohne Antriebsrad, without impeller, sans roue motrice, sin rueda motriz, без ведущего колеса							
09.1983→ Reference	D 2866	LXUH					50 005 827		
	51.05100.6134	51.05100.6155	mit Antriebsrad, with impeller, avec roue motrice, con rueda motriz, с приводным колесом						
Series UEL 242									506
09.1989→03.1993 Reference	D 2866	UH					50 005 828		
	51.05100.6135	ohne Antriebsrad, without impeller, sans roue motrice, sin rueda motriz, без ведущего колеса							
09.1989→03.1993 Reference	D 2866	UH					50 005 827		
	51.05100.6134	51.05100.6155	mit Antriebsrad, with impeller, avec roue motrice, con rueda motriz, с приводным колесом						
Series UEL 272									507
02.1990→03.1997 Reference	D 2865	LUH 02, LUH 05					50 005 828		
	51.05100.6135	ohne Antriebsrad, without impeller, sans roue motrice, sin rueda motriz, без ведущего колеса							
02.1990→03.1997 Reference	D 2865	LUH 02, LUH 05					50 005 827		
	51.05100.6134	51.05100.6155	mit Antriebsrad, with impeller, avec roue motrice, con rueda motriz, с приводным колесом						
Series UEL 292									508
09.1989→03.1993 Reference	D 2866	TUH 01					50 005 828		
	51.05100.6135	ohne Antriebsrad, without impeller, sans roue motrice, sin rueda motriz, без ведущего колеса							
09.1989→03.1993 Reference	D 2866	TUH 01					50 005 827		
	51.05100.6134	51.05100.6155	mit Antriebsrad, with impeller, avec roue motrice, con rueda motriz, с приводным колесом						
Series UEL 313									509
09.1996→ Reference	D 2866	LUH 20, LUH 24, LUH 26					50 005 870		
	51.05100.6250	51.05100.6252	51.05100.6260	51.05100.6262					
Series UEL 353									510
06.1997→12.2001 Reference	D 2866	LUH 21					50 005 870		
	51.05100.6250	51.05100.6252	51.05100.6260	51.05100.6262					



Series UEL 363

511

01.2001→	D 2866	LUH 25		
Reference	51.05100.6250	51.05100.6252	51.05100.6260	51.05100.6262



50 005 870

Series UEL 364

512

06.2004→	D 2866	LUH 25		
Reference	51.05100.6250	51.05100.6252	51.05100.6260	51.05100.6262



50 005 870

Engine

513

	D 2866	LF 25, LF 28, LF 29, LF 30, LF 31, LF 34, LF 35, LF 36, LF 37, LF 39, LF 40, LF 41, LF 43, LOH 30, LUH 27		
	D 2876	LF 01, LF 08, LF 09, LF 10, LF 11, LF 14, LF 17, LF 20, LOH 01, LOH 02, LUH 01, LUH 02		
Reference	51.05100.6250	51.05100.6252	51.05100.6260	51.05100.6262



50 005 870

	D 0826	LF 02, LF 04, LF 06, LF 09, LF 11, LOH 02, LOH 04, LOH 07, LOH 08		
Reference	51.06500.6495			



50 005 630

1983→1987	D 2866	UM		
Reference	51.06500.6408			



50 005 205

1991→1997	D 2840	L		
Reference	51.06500.6426			



50 005 612

01.1979→1991	D 2566	MKUL		
1991→	D 2865	LUH 03		
Reference	51.05100.6135			



50 005 828

	D 0826	LF 02, LF 04, LF 06, LF 09, LF 11, LFG 01, LOH 02, LOH 04, LOH 07, LOH 08		
Reference	51.06500.6476			



50 005 631

	D 2866	LFZR		
Reference	51.05100.6249	51.05100.6250		



50 005 833

01.1979→1991	D 2566	MKUL		
1991→	D 2865	LUH 03		
Reference	51.05100.6134	51.05100.6155		



50 005 827





01.1979→1991	D 2566	MKUL		
Reference	51.06500.6282	51.06500.6387	51.06500.9282	51.06500.9387



50 005 210

M

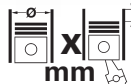

			Cyl	 mm	cm ³		Comp. Ratio ε	kW	PS	Pos
6.354	D	(AN)	6	98,48 x 126,8	5794	2	16:1	69-82	94-112	5, 6, 15, 18, 26, 49, 51, 53, 54, 56, 57, 58, 59, 65, 66, 67, 68, 69, 73, 74
4.212	D	(AN)	4	98,48 x 114	3475	2	15,5:1	44-47	60-64	7, 19, 24, 75
A 4.212	D	(AN)	4	98,48 x 114	3475	2	15,1:1	44	60	3, 19, 71, 72
4.236	D	(AN)	4	98,48 x 126,8	3864	2	16:1	48-60	59-80	7, 8, 13, 14, 16, 17, 19, 20, 22, 25, 32, 33, 34, 52, 60, 64
4.248	D	(AN)	4	101,054 x 126,8	4064	2	16:1	53-66	72-90	1, 2, 4, 7, 9, 11, 12, 21, 23, 24, 27, 28, 29, 30, 31, 34, 35, 36, 37, 38, 39, 40, 41, 42, 43, 44, 45, 46, 47, 48, 50, 52, 55, 61, 62, 63, 70, 76
A 4.192	D	(AN)	4	88,925 x 126,8	3150	2	16,5:1	36-40	50-55	10

M



MASSEY-FERGUSON

















11		1		
1969 → 04.1982	4.248		50 005 840	
22		2		
07.1972→12.1978	4.248		50 005 840	
30		3		
01.1969→	A 4.212		50 005 235 <small>NEW</small>	
33		4		
01.1979→12.1989	4.248		50 005 840	
44		5		
01.1969→12.1977	6.354		50 005 231 <small>NEW</small>	
45		6		
01.1969→12.1974	6.354		50 005 231 <small>NEW</small>	
50		7		
01.1973→	4.212		50 005 235 <small>NEW</small>	
01.1970→12.1980	4.236		50 005 246 <small>NEW</small>	

M



MASSEY-FERGUSON

				
01.1970→12.1980 	4.236 mit Riemenscheibe with pulley avec poulie con polea с Ремснный шкив			50 005 245 NEW
01.1970→12.1980	4.236			50 005 252 NEW
01.1970→	4.212, 4.248		50 005 840	
50 H				8
01.1984→	4.236			50 005 246 NEW
01.1984→ 	4.236 mit Riemenscheibe with pulley avec poulie con polea с Ремснный шкив			50 005 245 NEW
01.1984→	4.236			50 005 252 NEW
60				9
01.1972→12.1978	4.248		50 005 840	
65				10
01.1969→12.1971	A 4.192			50 005 250 NEW
70				11
01.1973→12.1978	4.248		50 005 840	

M



MASSEY-FERGUSON

**85****12**

01.1974→12.1975

4.248



50 005 840

86**13**

→

4.236

50 005 246
NEW

→

4.236
mit Riemenscheibe
with pulley
avec poulie
con polea
с Ремснный шкив50 005 245
NEW

→

4.236

50 005 252
NEW**M****87****14**

→

4.236

50 005 246
NEW

→

4.236
mit Riemenscheibe
with pulley
avec poulie
con polea
с Ремснный шкив50 005 245
NEW

→

4.236

50 005 252
NEW**87-6****15**

→











6.354

50 005 231
NEW



MASSEY-FERGUSON



95		16		
→	4.236			50 005 246 NEW
→ 	4.236 mit Riemenscheibe with pulley avec poulie con polea с Ремснный шкив			50 005 245 NEW
→	4.236			50 005 252 NEW
99		17		
→	4.236			50 005 246 NEW
→ 	4.236 mit Riemenscheibe with pulley avec poulie con polea с Ремснный шкив			50 005 245 NEW
→	4.236			50 005 252 NEW
102		18		
01.1972→12.1977	6.354		50 005 231 NEW	
165		19		
01.1964→	4.212, A 4.212		50 005 235 NEW	

M

















MASSEY-FERGUSON

01.1976→12.1979	4.236			50 005 246 NEW
01.1976→12.1979 	4.236 mit Riemenscheibe with pulley avec poulie con polea с Ремснный шкив			50 005 245 NEW
01.1976→12.1979	4.236			50 005 252 NEW
1974 →	4.212, 4.236		50 005 840	
168				20
→	4.236			50 005 246 NEW
→ 	4.236 mit Riemenscheibe with pulley avec poulie con polea с Ремснный шкив			50 005 245 NEW
→	4.236			50 005 252 NEW
178				21
01.1970→04.1982	4.248		50 005 840	
180				22
→	4.236			50 005 246 NEW

M











MASSEY-FERGUSON

				
→ 	4.236 mit Riemenscheibe with pulley avec poulie con polea с Ремснный шкив			50 005 245 NEW
→	4.236			50 005 252 NEW
185				23
01.1972→04.1982	4.248		50 005 840	
186				24
1969 →	4.212		50 005 235 NEW	
1969 →	4.212, 4.248		50 005 840	M
187				25
→	4.236			50 005 246 NEW
→ 	4.236 mit Riemenscheibe with pulley avec poulie con polea с Ремснный шкив			50 005 245 NEW
→	4.236			50 005 252 NEW
187-6				26
→	6.354		50 005 231 NEW	



MASSEY-FERGUSON

















188		27		
01.1971→04.1982	4.248		50 005 840	
194		28		
→	4.248		50 005 840	
220		29		
01.1972→04.1982	4.248		50 005 840	
230		30		
01.1972→04.1982	4.248		50 005 840	
250		31		
01.1973→12.1977	4.248		50 005 840	
265		32		
→	4.236			50 005 246 NEW
→	4.236 mit Riemenscheibe with pulley avec poulie con polea с Ремсннй шкив			50 005 245 NEW
→	4.236			50 005 252 NEW
270		33		
→	4.236			50 005 246 NEW

M



MASSEY-FERGUSON









				
→ 	4.236 mit Riemenscheibe with pulley avec poulie con polea с Ремснный шкив			50 005 245 NEW
→	4.236			50 005 252 NEW
275				34
→	4.236			50 005 246 NEW
→ 	4.236 mit Riemenscheibe with pulley avec poulie con polea с Ремснный шкив			50 005 245 NEW
→	4.236			50 005 252 NEW
01.1975→12.1988	4.248		50 005 840	
285				35
01.1971→12.1982	4.248		50 005 840	
290				36
01.1976→	4.248		50 005 840	
293				37
01.1975→	4.248		50 005 840	

M



MASSEY-FERGUSON













294		38	
01.1975→12.1987	4.248		50 005 840
300		39	
01.1971→	4.248		50 005 840
307		40	
1969 → 04.1982	4.248		50 005 840
310		41	
01.1972→	4.248		50 005 840
330		42	
01.1973→12.1977	4.248		50 005 840
350		43	
01.1972→12.1976	4.248		50 005 840
382		44	
1993 →	4.248		50 005 840
390		45	
01.1986→12.1997	4.248		50 005 840
393		46	
1989 →	4.248		50 005 840

M



MASSEY-FERGUSON



394				47	
1988 →	4.248		50 005 840		
397				48	
1989 →	4.248		50 005 840		
400				49	
01.1971→12.1987	6.354		50 005 231 NEW		
440				50	
→	4.248		50 005 840		
450				51	
01.1973→12.1987	6.354		50 005 231 NEW		
487				52	
1965 →	4.236			50 005 246 NEW	
1965 → 	4.236 mit Riemenscheibe with pulley avec poulie con polea с Ремснный шкив			50 005 245 NEW	
1965 →	4.236			50 005 252 NEW	
1969 → 04.1982	4.248		50 005 840		

M



MASSEY-FERGUSON

















500		53		
01.1969→12.1973	6.354		50 005 231 <small>NEW</small>	
500-7		54		
01.1969→12.1988	6.354		50 005 231 <small>NEW</small>	
506		55		
1969 → 04.1982	4.248		50 005 840	
510		56		
01.1968→12.1988	6.354		50 005 231 <small>NEW</small>	
515		57		
01.1969→12.1988	6.354		50 005 231 <small>NEW</small>	
520		58		
01.1971→12.1974	6.354		50 005 231 <small>NEW</small>	
542		59		
01.1970→12.1978	6.354		50 005 231 <small>NEW</small>	
575		60		
→	4.236		50 005 246 <small>NEW</small>	

M



MASSEY-FERGUSON

				
→ 	4.236 mit Riemenscheibe with pulley avec poulie con polea с Ремснный шкив			50 005 245 <small>NEW</small>
→	4.236			50 005 252 <small>NEW</small>
587				61
01.1981 →	4.248		50 005 840	
590				62
→	4.248		50 005 840	
690				63
01.1982 →	4.248		50 005 840	
1080				64
1965 →	4.236			50 005 246 <small>NEW</small>
1965 → 	4.236 mit Riemenscheibe with pulley avec poulie con polea с Ремснный шкив			50 005 245 <small>NEW</small>
1965 →	4.236			50 005 252 <small>NEW</small>
1965 →	4.236		50 005 840	



MASSEY-FERGUSON



1095		65	
01.1973→12.1974	6.354		50 005 231 <small>NEW</small>
1098		66	
01.1975→12.1976	6.354		50 005 231 <small>NEW</small>
1100		67	
01.1964→12.1972	6.354		50 005 231 <small>NEW</small>
1105		68	
01.1972→12.1976	6.354		50 005 231 <small>NEW</small>
1200		69	
→	6.354		50 005 231 <small>NEW</small>
3060		70	
01.1987→	4.248		50 005 840
3303		71	
01.1969→12.1970	A 4.212		50 005 235 <small>NEW</small>
3305		72	
01.1969→12.1970	A 4.212		50 005 235 <small>NEW</small>

M



MASSEY-FERGUSON



3366

73

01.1971 →

6.354



50 005 231

NEW

4488

74

01.1973 → 12.1977

6.354



50 005 231

NEW

7000

75

1969 →

4.212



50 005 235

NEW

1969 →

4.212



50 005 840

8000

76

1969 → 04.1982

4.248



50 005 840







M



			Cyl		mm	cm ³	Comp. Ratio	ε	kW	PS	Pos
B1 (38 kW)	B		4	68 x 78,4	1138	2	9,7:1	38-41	52-56		1
B3 (49 kW)	B		4	71 x 83,6	1324	2	9,4:1	49-50	67-68		26
B3 (40 kW)	B		4	71 x 83,6	1324	4	9,4:1	40	54		4
B3 (54 kW)	B		4	71 x 83,6	1324	4	9,4:1	54	73		4, 21, 27
B3 (56 kW)	B		4	71 x 83,6	1324	4	9,4:1	56	76		4, 21, 27
B3-ME (54 kW)	B		4	71 x 83,6	1324	4	9,4:1	54	73		13, 27
B6 (79 kW)	B		4	78 x 83,6	1598	4	9:1	79	107		16
B64F	B		4	78 x 83,6	1598	4	9,4:1	85	116		17
B6ZE	B		4	78 x 83,6	1598	4	9,4:1	78-88	106-120		17, 28
BP (122 kW)	B	(LA)	4	83 x 85	1840	2	8,2:1	122	166		31
BP (136 kW)	B	(LA)	4	83 x 85	1840	4	8,2:1	136-139	185-189		34
BP (94 kW)	B		4	83 x 85	1840	4	9:1	94-96	128-130		32
BP-ZE	B		4	83 x 85	1840	4	9:1	84	114		32
BP52	B		4	83 x 85	1840	4	8,9:1	76-78	103-106		32
BPF1	B		4	83 x 85	1840	4	9:1	96-99	130-135		32
CHBB	B		4	83 x 83,1	1798	4	10,8:1	88-93	120-126		18, 36, 37
DHA	B		4	71,9 x 76,5	1242	4	10:1	55	75		2
DHF	B		4	71,9 x 76,5	1242	4	10:1	55	75		2
DHG	B		4	71,9 x 76,5	1242	4	10:1	55	75		2
DV4 TD	D	(LA)	4	73,7 x 82	1398	2	17,9:1	40-50	54-68		7
DV6 TED4	D	(LA)	4	75 x 88,3	1560	4	17,6:1	80	109		49
F2	B		4	86 x 94	2184	3	8,6:1	85	116		62
F6	B		4	81 x 77	1587	2	8,6:1	60	81		38, 40
F8E	B		4	86 x 77	1789	2	8,6:1	70-74	95-100		12, 20, 29, 46, 52
FE (103 kW)	B		4	86 x 86	1998	4		103-109	140-148		60
FE (66 kW)	B		4	86 x 86	1998	2	8,6:1	66	90		59
FE (88 kW)	B		4	86 x 86	1998	2	8,6:1	88	120		59
FE4	B		4	86 x 86	1998	2	8,6:1	75	102		39, 55, 56
FEJL	B		4	86 x 86	1998	2		70	95		14
FS	B		4	83 x 92	1991	4	9:1	85	116		11, 47, 60
FS7G	B		4	83 x 92	1991	4	9,7:1	96	130		41, 48
FUJA	B		4	71,9 x 76,5	1242	4	10:1	55	75		6
FXJA	B		4	76 x 76,5	1388	4	11:1	59	80		8, 35
FYDA	B		4	79 x 81,4	1596	4	11:1	74-76	101-103		9, 45
J4D	B		4	74 x 75,5	1299	2	9,5:1	44	60		3
JJA	B		4	74 x 75,5	1299	2	9,5:1	37	50		3
JJB	B		4	74 x 75,5	1299	2	9,5:1	37	50		3
KF1 (103 kW)	B		6	78 x 69,6	1995	4	9,5:1	103-108	140-147		42
KF1 (105 kW)	B		6	78 x 69,6	1995	4	10:1	105-107	143-145		15, 22, 23
KJ-ZEM	B	(A)	6	80,3 x 74,2	2255	4	10:1	155-162	211-220		19, 24, 33
KL	B		6	85,5 x 74,2	2556	4	9,2:1	121-125	165-170		25, 57, 63
L3C1	B		4	87,5 x 94	2261	4	10,6:1	122	166		54
RF (66 kW)	D	(A)	4	86 x 86	1998	2	18,8:1	66	90		43
RF4F	D	(A)	4	86 x 86	1998	4	18,8:1	74	101		44, 53, 61
RF5C (89 kW)	D	(LA)	4	86 x 86	1998	4	18,4:1	89	121		10
RF7J	D	(LA)	4	86 x 86	1998	4	16,7:1	105	143		50, 51, 58
RTE	D	(AN)	4	82,5 x 82	1753	2	21,5:1	44	60		5
RTF	D	(AN)	4	82,5 x 82	1753	2	21,5:1	44	60		5
Z5-DE	B		4	75,3 x 83,5	1489	4	9,4:1	65-71	88-97		30

M



121 1.1					1
10.1987→10.1990	B1 (38 kW)				
Reference	8AB3-15-010 8AD2-15-010A KKY01-15-010	8AB3-15-010A B3C7-15-010	8AB4-15-010A B630-15-010	8AB7-15-010 B630-15-010A	 50 005 111 NEW
121 1.25i 16V					2
01.1996→	DHA, DHF, DHG				
Reference	1E05-15-010	1E06-15-010			50 005 119 NEW
121 1.3i					3
01.1996→01.2002	J4D, JJA, JJB				
Reference	1E04-15-010				 50 005 120 NEW
121 1.3i 16V					4
11.1990→12.1995	B3 (40 kW), B3 (54 kW), B3 (56 kW)				
Reference	8AB3-15-010 8AD2-15-010A KKY01-15-010	8AB3-15-010A B3C7-15-010	8AB4-15-010A B630-15-010	8AB7-15-010 B630-15-010A	 50 005 111 NEW
121 1.8 D					5
01.1996→01.2002	RTE, RTF				
					 50 005 725
2 1.2i 16V					6
02.2003→	FUJA				
Reference	1E05-15-010	1E06-15-010			50 005 119 NEW
2 1.4 CDi					7
02.2003→	DV4 TD				
Reference	Y401-15-010				 50 005 758
2 1.4i 16V					8
03.2003→	FXJA				
Reference	1E05-15-010	1E06-15-010			50 005 119 NEW
2 1.6i 16V					9
02.2003→	FYDA				
Reference	1E05-15-010	1E06-15-010			50 005 119 NEW
6 2.0 CD 16V					10
06.2002→	RF5C (89 kW)				
Reference	RF2A-15-100A	RF2A-15-100B	RF2A-15-100C	RF5C-15-010A	 50 005 122 NEW

M

**MAZDA****Anfini 2.0i 16V****11**10.1991→
ReferenceFS
8AG9-15-010 FS01-15-010F**50 005 117**
NEW**Bongo 1.8****12**12.1983→
ReferenceF8E
8AH2-15-010 8AH2-15-010A 8AH2-15-010B 8AK1-15-010
FEMJ-15-100**50 005 116**
NEW**Demio 1.3i 16V****13**05.1998→
ReferenceB3-ME (54 kW)
8AB3-15-010 8AB3-15-010A 8AB4-15-010A 8AB7-15-010
8AD2-15-010A B3C7-15-010 B630-15-010 B630-15-010A
KKY01-15-010**50 005 111**
NEW**E 2000i****14**08.1991→
ReferenceFEJL
8AH2-15-010 8AH2-15-010A 8AH2-15-010B 8AK1-15-010
FEMJ-15-100**50 005 116**
NEW**M****Lantis 2.0i 24V****15**08.1993→
ReferenceKF1 (105 kW)
8AK2-15-010 KL47-15-010C**50 005 118**
NEW**MX-3 1.6i 16V****16**11.1993→02.1998
ReferenceB6 (79 kW)
8AB3-15-010 8AB3-15-010A 8AB4-15-010A 8AB7-15-010
8AD2-15-010A B3C7-15-010 B630-15-010 B630-15-010A
KKY01-15-010**50 005 111**
NEW**MX-5 1.6i 16V****17**02.1989→
ReferenceB6ZE
8ABB-15-010 8ABB-15-010A B6BF-15-010F B6BFE-15-010A
B6BFE-15-010B**50 005 115**
NEW09.1989→08.1993
ReferenceB64F
8AB8-15-010 B660-15-010B B660-15-010C**50 005 121**
NEW

**MX-5 1.8i 16V****18**03.2005→
ReferenceCHBB
LF01-15-100

50 005 751

Millenia 2.3i Turbo 16V**19**09.1993→
ReferenceKJ-ZEM
8AK2-15-010 KL47-15-010C50 005 118
NEW**Persona 1.8****20**10.1988→02.1990
ReferenceF8E
8AH2-15-010 8AH2-15-010A 8AH2-15-010B 8AK1-15-010
FEMJ-15-10050 005 116
NEW**Revue 1.3i 16V****21**09.1990→
ReferenceB3 (54 kW), B3 (56 kW)
8AB3-15-010 8AB3-15-010A 8AB4-15-010A 8AB7-15-010
8AD2-15-010A B3C7-15-010 B630-15-010 B630-15-010A
KKY01-15-01050 005 111
NEW**Xedos 6 2.0i 24V****22**01.1992→04.1996
ReferenceKF1 (105 kW)
8AK2-15-010 KL47-15-010C
CH0114351→50 005 118
NEW**Xedos 9 2.0i 24V****23**09.1993→07.2000
ReferenceKF1 (105 kW)
8AK2-15-010 KL47-15-010C
CH0131581→50 005 118
NEW**Xedos 9 2.3i Turbo 24V****24**12.1994→07.2000
ReferenceKJ-ZEM
8AK2-15-010 KL47-15-010C50 005 118
NEW**Xedos 9 2.5i 24V****25**07.1993→07.1998
ReferenceKL
8AK2-15-010 KL47-15-010C
CH010067→50 005 118
NEW**M**

**MAZDA****323 1.3****26**

02.1987→

B3 (49 kW)

Reference

8AB3-15-010
8AD2-15-010A
KKY01-15-0108AB3-15-010A
B3C7-15-0108AB4-15-010A
B630-15-0108AB7-15-010
B630-15-010A**50 005 111**
NEW**323 1.3i 16V****27**

01.1991→

B3 (54 kW), B3 (56 kW), B3-ME (54 kW)

Reference

8AB3-15-010
8AD2-15-010A
KKY01-15-0108AB3-15-010A
B3C7-15-0108AB4-15-010A
B630-15-0108AB7-15-010
B630-15-010A**50 005 111**
NEW**Eunos Roadster 1.6i 16V****28**

02.1989→

B6ZE

Reference

8ABB-15-010
B6BFE-15-010B

8ABB-15-010A

B6BF-15-010F

B6BFE-15-010A

**50 005 115**
NEW**Eunos 1.8****29**

10.1989→02.1992

F8E

Reference

8AH2-15-010
FEMJ-15-100

8AH2-15-010A

8AH2-15-010B

8AK1-15-010

**50 005 116**
NEW**M****323 1.5i 16V****30**

05.1994→04.1998

Z5-DE

Reference

8ABB-15-010
B6BFE-15-010B

8ABB-15-010A

B6BF-15-010F

B6BFE-15-010A

**50 005 115**
NEW**323 1.8i Turbo****31**

09.1990→07.1994

BP (122 kW)

Reference

8AB8-15-010

B660-15-010B

B660-15-010C

**50 005 121**
NEW**323 1.8i 16V****32**

02.1989→

BP (94 kW), BP-ZE, BP52, BPF1

Reference

8AB8-15-010

B660-15-010B

B660-15-010C

**50 005 121**
NEW**Eunos 800 2.3i Turbo 24V****33**

09.1993→

KJ-ZEM

Reference

8AK2-15-010

KL47-15-010C

**50 005 118**
NEW

**323 1.8i 16V Turbo****34**

01.1992→05.1994

BP (136 kW)

Reference

8AB8-15-010

B660-15-010B

B660-15-010C



50 005 121

NEW

3 1.4i 16V**35**

02.2003→

FXJA

Reference

ZJ01-15-010A

ZJ01-15-010B



50 005 206

NEW

5 1.8i 16V**36**

06.2005→

CHBB

Reference

LF01-15-100



50 005 751

6 1.8i 16V**37**

02.2002→

CHBB

Reference

LF01-15-100



50 005 751

626 1.6**38**

11.1982→06.1987

F6

Reference

8AH2-15-010
FEMJ-15-100

8AH2-15-010A

8AH2-15-010B

8AK1-15-010



50 005 116

NEW

929 2.0**39**

10.1983→09.1986

FE4

Reference

8AH2-15-010
FEMJ-15-100

8AH2-15-010A

8AH2-15-010B

8AK1-15-010



50 005 116

NEW

Capella 1.6**40**

09.1982→03.1987

F6

Reference

8AH2-15-010
FEMJ-15-100

8AH2-15-010A

8AH2-15-010B

8AK1-15-010



50 005 116

NEW

323 2.0i 16V**41**

01.2001→05.2004

FS7G

Reference

8AG9-15-010

FS01-15-010F



50 005 117

NEW

**MAZDA****323 2.0i 24V****42**

05.1994→09.1996

KF1 (103 kW)

Reference

8AK2-15-010

KL47-15-010C

CH0100058→

**50 005 118****NEW****323 2.0 TD****43**

07.1998→01.2001

RF (66 kW)

Reference

RF2A-15-100A

RF2A-15-100B

RF2A-15-100C

RF5C-15-010A

**50 005 122****NEW****323 2.0 TDi 16V****44**

01.2001→05.2004

RF4F

Reference

RF2A-15-100A

RF2A-15-100B

RF2A-15-100C

RF5C-15-010A

**50 005 122****NEW****3 1.6i 16V****45**

11.2003→

FYDA

Reference

ZJ01-15-010A

ZJ01-15-010B

**50 005 206****NEW****626 1.8****46**

11.1982→

F8E

Reference

8AH2-15-010
FEMJ-15-100

8AH2-15-010A

8AH2-15-010B

8AK1-15-010

**50 005 116****NEW****MX-6 2.0i 16V****47**

07.1991→06.1997

FS

Reference

8AG9-15-010

FS01-15-010F

**50 005 117****NEW****Premacy 2.0i 16V****48**

11.2001→

FS7G

Reference

8AG9-15-010

FS01-15-010F

**50 005 117****NEW****3 1.6 CDi 16V****49**

06.2004→

DV6 TED4

Reference

Y601-15-010A

**50 005 762****M**

**5 2.0 CD HP 16V****50**

03.2005→ Reference	RF7J RF2A-15-100A	RF2A-15-100B	RF2A-15-100C	RF5C-15-010A			50 005 122 NEW
-----------------------	----------------------	--------------	--------------	--------------	---	--	--------------------------

6 2.0 CD HP 16V**51**

06.2005→ Reference	RF7J RF2A-15-100A	RF2A-15-100B	RF2A-15-100C	RF5C-15-010A			50 005 122 NEW
-----------------------	----------------------	--------------	--------------	--------------	---	--	--------------------------

Capella 1.8**52**

09.1982→ Reference	F8E 8AH2-15-010 FEMJ-15-100	8AH2-15-010A	8AH2-15-010B	8AK1-15-010			50 005 116 NEW
-----------------------	-----------------------------------	--------------	--------------	-------------	---	--	--------------------------

Premacy 2.0 TDi 16V**53**

07.2000→ Reference	RF4F RF2A-15-100A	RF2A-15-100B	RF2A-15-100C	RF5C-15-010A			50 005 122 NEW
-----------------------	----------------------	--------------	--------------	--------------	---	--	--------------------------

6 2.3i 16V**54**

02.2002→ Reference	L3C1 LF01-15-100						50 005 751
-----------------------	---------------------	--	--	--	---	--	------------

626 2.0**55**

07.1985→03.1992 Reference	FE4 8AH2-15-010 FEMJ-15-100	8AH2-15-010A	8AH2-15-010B	8AK1-15-010			50 005 116 NEW
------------------------------	-----------------------------------	--------------	--------------	-------------	---	--	--------------------------

Capella 2.0**56**

05.1985→ Reference	FE4 8AH2-15-010 FEMJ-15-100	8AH2-15-010A	8AH2-15-010B	8AK1-15-010			50 005 116 NEW
-----------------------	-----------------------------------	--------------	--------------	-------------	---	--	--------------------------

MX-6 2.5i 24V**57**

07.1991→06.1997 Reference 	KL 8AK2-15-010 CH0102488→	KL47-15-010C					50 005 118 NEW
---	---------------------------------	--------------	--	--	---	--	--------------------------

**MAZDA****3 2.0 CD HP 16V****58**

12.2005→

RF7J

Reference

RF2A-15-100A

RF2A-15-100B

RF2A-15-100C

RF5C-15-010A

**50 005 122****NEW****626 2.0i****59**

07.1985→07.1991

FE (66 kW), FE (88 kW)

Reference

8AH2-15-010
FEMJ-15-100

8AH2-15-010A

8AH2-15-010B

8AK1-15-010

**50 005 116****NEW****626 2.0i 16V****60**

08.1991→03.1997

FS

Reference

8AG9-15-010

FS01-15-010F

**50 005 117****NEW**

06.1987→08.1991

FE (103 kW)

Reference

8AG2-15-010
8AG2-15-100B8AG2-15-010A
8AG2-15-100C

8AG2-15-010B

8AG2-15-010C

**50 005 110****NEW****M****626 2.0 TDi 16V****61**

09.1999→07.2002

RF4F

Reference

RF2A-15-100A

RF2A-15-100B

RF2A-15-100C

RF5C-15-010A

**50 005 122****NEW****626 2.2i 12V****62**

11.1987→07.1991

F2

Reference

8AH2-15-010
FEMJ-15-100

8AH2-15-010A

8AH2-15-010B

8AK1-15-010

**50 005 116****NEW****626 2.5i 24V****63**

09.1991→03.1997

KL



Reference

8AK2-15-010
CH0130030→

KL47-15-010C

**50 005 118****NEW**

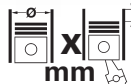

			Cyl		mm	cm ³	Comp. Ratio	ε	kW	PS	Pos
M 102.910	B		4	89 x 72,2		1797	2	9:1	80	109	191
M 102.919 (POR)	B		4	89 x 72,2		1797	2	9:1	77	105	191
M 102.920	B		4	89 x 80,3		1997	2		80	109	200
M 102.921	B		4	89 x 80,3		1997	2		66	90	185
M 102.922	B		4	89 x 80,3		1997	2		72	98	201
M 102.924	B		4	89 x 80,3		1997	2		72	98	185
M 102.938	B		4	89 x 80,3		1997	2		63	86	185
M 102.939	B		4	89 x 80,3		1997	2		74	100	200
M 102.942	B		4	95,5 x 80,3		2299	2		70	95	617, 620, 627, 631, 663
M 102.943	B		4	95,5 x 80,3		2299	2		70	95	505, 657, 661, 663
M 102.959	B		4	95,5 x 80,3		2299	2		70	95	505
M 102.961	B		4	89 x 80,3		1997	2		90	122	192
M 102.962	B		4	89 x 80,3		1997	2		83-90	113-122	192
M 102.963	B		4	89 x 80,3		1997	2	9,1:1	87	118	206
M 102.980	B		4	95,5 x 80,3		2299	2		100	136	216
M 102.981	B		4	95,5 x 80,3		2299	2		92	125	221, 222
M 102.982	B		4	95,5 x 80,3		2299	2		94-100	128-136	217
M 102.983	B		4	95,5 x 80,3		2299	4		125	170	194
M 102.985	B		4	95,5 x 80,3		2299	2		97-100	132-136	193
M 102.990	B		4	95,5 x 87,2		2498	4	9,7:1	145	197	195
M 102.991	B		4	97,3 x 82,8		2463	2	9,7:1	150	204	196
M 102.992	B		4	97,3 x 82,8		2463	2	9,7:1	173	235	196
M 102.998	B		4	95,5 x 80,3		2299	2	8:1	92	125	221, 222
M 103.940	B		6	82,9 x 80,3		2599	2		115	156	245, 274
M 103.941	B		6	82,9 x 80,3		2599	2		115	156	246
M 103.942	B		6	82,9 x 80,3		2599	2		115	156	197
M 103.943	B		6	82,9 x 80,3		2599	2		115	156	245
M 103.980	B		6	88,5 x 80,3		2962	2		130	177	273
M 103.981	B		6	88,5 x 80,3		2962	2		130	177	284
M 103.982	B		6	88,5 x 80,3		2962	2	9,2:1	132	180	292
M 103.983	B		6	88,5 x 80,3		2962	2		130	177	273
M 103.984	B		6	88,5 x 80,3		2962	2	9,2:1	140	190	293
M 103.985	B		6	88,5 x 80,3		2962	2		130	177	72, 273
M 103.987	B		6	88,5 x 80,3		2962	2	9,2:1	126	171	88, 280
M 104.900	B		6	81 x 90,3		2792	2	10:1	128	174	158
M 104.941	B		6	89,9 x 73,5		2799	4	10:1	142	193	27
M 104.942	B		6	89,9 x 73,5		2799	4	10:1	142	193	69, 70, 252, 286, 287
M 104.943	B		6	89,9 x 73,5		2799	4	10:1	150	204	118
M 104.944	B		6	89,9 x 73,5		2799	4	10:1	142	193	103, 288
M 104.945	B		6	89,9 x 73,5		2799	4	10:1	142	193	70
M 104.980	B		6	88,5 x 80,2		2960	4	10:1	170	231	273, 276
M 104.981	B		6	88,5 x 80,2		2960	4	10:1	170	231	294
M 104.990	B		6	89,9 x 84		3199	4	10:1	170	231	107, 289
M 104.991	B		6	89,9 x 84		3199	4	10:1	170	231	119
M 104.992	B		6	89,9 x 84		3199	4	10:1	162	220	77, 275, 295
M 104.994	B		6	89,9 x 84		3199	4	10:1	170	231	105, 107
M 104.995	B		6	89,9 x 84		3199	4	10:1	170	231	78, 91
M 104.996	B		6	89,9 x 84		3199	4	9,2:1	155	211	92
M 108.920	B		6	82 x 78,8		2496	2	9:1	96	130	242
M 108.924	B		6	82 x 78,8		2496	2	8:1	85	115	242
M 110.921	B		6	86 x 78,8		2746	2	8,7:1	118	160	247
M 110.922	B		6	86 x 78,8		2746	2	8,7:1	115	156	256
M 110.923	B		6	86 x 78,8		2746	2	8,7:1	115	156	248
M 110.924	B		6	86 x 78,8		2746	2	8,7:1	115	156	257
M 110.926	B		6	86 x 78,8		2746	2	8,7:1	115	156	257
M 110.931	B		6	86 x 78,8		2746	2	8:1	107	145	247
M 110.932	B		6	86 x 78,8		2746	2	8:1	105	143	256
M 110.981	B		6	86 x 78,8		2746	2	8,7:1	136	185	249
M 110.982	B		6	86 x 78,8		2746	2	8,7:1	136	185	264
M 110.983	B		6	86 x 78,8		2746	2	8:1	136	185	250
M 110.984	B		6	86 x 78,8		2746	2	8,7:1	136	185	251
M 110.985	B		6	86 x 78,8		2746	2	8,7:1	136	185	260
M 110.986	B		6	86 x 78,8		2746	2	8,7:1	130-136	177-185	264, 300, 311
M 110.987	B		6	86 x 78,8		2746	2	9:1	136	185	261, 302, 316
M 110.988	B		6	86 x 78,8		2746	2	9:1	136	185	251
M 110.989	B		6	86 x 78,8		2746	2	9:1	136	185	261, 302, 316
M 110.990	B		6	86 x 78,8		2746	2	9:1	136	185	264, 300, 311
M 110.991	B		6	86 x 78,8		2746	2	8:1	125	170	218, 235, 249
M 110.992	B		6	86 x 78,8		2746	2	8:1	125	170	264, 300, 311





M



			Cyl		mm	cm ³	Comp. Ratio ϵ	kW	PS	Pos
M 110.993	B		6	86 x 78,8	2746	2	8:1	108	147	260, 298, 309
M 110.994	B		6	86 x 78,8	2746	2	8:1	115	156	253, 254
M 111.920	B		4	85,3 x 78,7	1799	4		86	117	7
M 111.921	B		4	85,3 x 78,7	1799	4	8,8:1	90	122	7
M 111.940	B		4	89,9 x 78,7	1998	4		100	136	47, 206
M 111.941	B		4	89,9 x 78,7	1998	4		100	136	9
M 111.942	B		4	89,9 x 78,7	1998	4		100	136	48
M 111.943	B	(A)	4	89,9 x 78,7	1998	4	8,5:1	135-141	184-192	124
M 111.944	B	(A)	4	89,9 x 78,7	1998	4	8,5 :1	132-141	180-192	10, 35
M 111.945	B		4	89,9 x 78,7	1998	4		100	136	9, 34
M 111.946	B		4	89,9 x 78,7	1998	4		100	136	123
M 111.947	B		4	89,9 x 78,7	1998	4	10:1	137	186	49
M 111.948	B		4	89,9 x 78,7	1998	4	9,6:1	100	136	153, 176, 183
M 111.950	B		4	89,9 x 78,7	1998	4	9,6:1	95	129	153, 176
M 111.951	B		4	89,9 x 78,7	1998	4		95	129	8
M 111.952	B		4	89,9 x 78,7	1998	4	10,6:1	95	129	7
M 111.955	B	(K)	4	89,9 x 78,7	1998	4	9,5:1	120	163	11
M 111.956	B	(K)	4	89,9 x 78,7	1998	4	9,5:1	120	163	10, 35
M 111.957	B	(K)	4	89,9 x 78,7	1998	4	9,5:1	120	163	49
M 111.958	B	(K)	4	89,9 x 78,7	1998	4	9,5:1	120	163	124
M 111.960	B		4	89,9 x 86,6	2199	4	9,8:1	110	150	54, 211
M 111.961	B		4	89,9 x 86,6	2199	4	9,8:1	110	150	15
M 111.970	B		4	90,9 x 88,4	2295	4		103-110	140-150	58
M 111.973 (JPN)	B	(K)	4	90,9 x 88,4	2295	4	8,8:1	142	193	125
M 111.974	B		4	90,9 x 88,4	2295	4		110	150	19
M 111.975	B	(K)	4	90,9 x 88,4	2295	4	8,8:1	142	193	20, 37
M 111.977	B		4	90,9 x 88,4	2295	4	10,4:1	110	150	96
M 111.978	B		4	90,9 x 88,4	2295	4	8,8:1	105	143	156, 177, 184
M 111.979	B		4	90,9 x 88,4	2295	4	8,8:1	105	143	132, 140, 149, 183
M 111.980	B		4	90,9 x 88,4	2295	4	8,8:1	105	143	156, 177, 184
M 111.981	B	(K)	4	90,9 x 88,4	2295	4	9:1	145	197	21
M 111.982	B	(K)	4	90,9 x 88,4	2295	4	9:1	145	197	37
M 111.983	B	(K)	4	90,9 x 88,4	2295	4	9:1	145	197	125
M 112.910	B		6	83,2 x 73,5	2398	3	10:1	120-125	163-170	22
M 112.911	B		6	83,2 x 73,5	2398	3	9,8:1	120-125	163-170	59
M 112.912	B		6	89,9 x 68,2	2597	3	10,5:1	130	177	23, 38, 60
M 112.913	B		6	83,2 x 73,5	2398	3	10:1	125	170	62
M 112.914	B		6	89,9 x 68,2	2597	3	10,5:1	125	170	61
M 112.915	B		6	83,2 x 73,5	2398	3	10:1	130	177	22
M 112.916	B		6	89,9 x 68,2	2597	3	10,5:1	125	170	23
M 112.920	B		6	89,9 x 73,5	2799	3	10:1	145	197	27
M 112.921	B		6	89,9 x 73,5	2799	3	9,8:1	150	204	70
M 112.922	B		6	89,9 x 73,5	2799	3	9,8:1	150	204	104
M 112.923	B		6	89,9 x 73,5	2799	3	10,1:1	150	204	118
M 112.940	B		6	89,9 x 84	3199	3	10:1	160	218	40
M 112.941	B		6	89,9 x 84	3199	3	10:1	165	224	78
M 112.942	B		6	89,9 x 84	3199	3	10:1	160	218	98
M 112.943	B		6	89,9 x 84	3199	3	10,1:1	165	224	119
M 112.944	B		6	89,9 x 84	3199	3	10:1	165-170	224-231	108
M 112.945	B		6	89,9 x 84	3199	3	9,2/10:1	158	215	92
M 112.946	B		6	89,9 x 84	3199	3	10:1	160	218	28
M 112.947	B		6	89,9 x 84	3199	3	10:1	160	218	126
M 112.949	B		6	89,9 x 84	3199	3	10:1	165	224	79
M 112.953	B		6	89,9 x 84	3199	3	10:1	160	218	28
M 112.955	B		6	89,9 x 84	3199	3	10:1	160	218	41
M 112.970	B		6	97 x 84	3724	3	10:1	172	234	99
M 112.972	B		6	97 x 84	3724	3	10:1	180	245	109, 111
M 112.973	B		6	97 x 84	3724	3	10,1:1	180	245	120
M 112.975	B		6	97 x 84	3724	3	10,1:1	180	245	109
M 113.940	B		8	89,9 x 84	4266	3	10:1	205	279	83
M 113.941	B		8	89,9 x 84	4266	3	10:1	205	279	113
M 113.942	B		8	89,9 x 84	4266	3	10:1	200	272	100
M 113.943	B		8	89,9 x 84	4266	3	10:1	205	279	42
M 113.944 AMG	B		8	89,9 x 84	4266	3	10:1	225	306	29
M 113.948	B		8	89,9 x 84	4266	3	10:1	205	279	113
M 113.960	B		8	97 x 84	4966	3	10:1	225	306	30, 116
M 113.961	B		8	97 x 84	4966	3	10,1:1	218	296	121
M 113.962	B		8	97 x 84	4966	3	10:1	218-225	296-306	94
M 113.963	B		8	97 x 84	4966	3	10,1:1	225	306	122



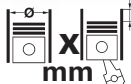

M



			Cyl	 mm	cm ³		Comp. Ratio ε	kW	PS	Pos
M 113.965	B		8	97 x 84	4966	3	10:1	215	292	101
M 113.966	B		8	97 x 84	4966	3	10:1	225	306	116
M 113.967	B		8	97 x 84	4966	3	10:1	225	306	46, 85
M 113.968	B		8	97 x 84	4966	3	10:1	225	306	43
M 113.980 AMG	B		8	97 x 92	5439	3	10,5:1	260-265	354-360	86
M 113.981 AMG	B		8	97 x 92	5439	3	10,5:1	255	347	102
M 113.982 AMG	B		8	97 x 92	5439	3	10,5:1	255-260	347-354	95
M 113.984 AMG	B		8	97 x 92	5439	3	10,5:1	255	347	44
M 113.986 AMG	B		8	97 x 92	5439	3	10,5:1	265	360	31, 117
M 113.987 AMG	B		8	97 x 92	5439	3	11:1	270	367	45
M 114.920	B		6	82 x 78,8	2496	2	9:1	96	130	232
M 114.923	B		6	82 x 78,8	2496	2	9:1	85	115	232
M 114.980	B		6	82 x 78,8	2496	2	9,5:1	110	150	236
M 114.981	B		6	82 x 78,8	2496	2	9,5:1	110	150	236
M 115.920	B		4	87 x 92,4	2197	2	9:1	77	105	207
M 115.921	B		4	87 x 92,4	2197	2	9:1	62	85	504, 656, 660, 662
M 115.923	B		4	87 x 83,6	1988	2	9:1	70	95	199
M 115.924	B		4	87 x 92,4	2197	2	9:1	66	90	207
M 115.926	B		4	87 x 83,6	1988	2	9:1	62	85	199
M 115.928	B		4	87 x 92,4	2197	2	9:1	55	75	504, 656, 660, 662
M 115.938	B		4	87 x 83,6	1988	2	9:1	70	95	200
M 115.939	B		4	87 x 83,6	1988	2	9:1	62	84	200
M 115.951	B		4	93,75 x 83,6	2307	2	9:1	81	110	224, 992
M 115.952	B		4	93,75 x 83,6	2307	2	8:1	66	90	505, 657, 661, 663
M 115.954	B		4	93,75 x 83,6	2307	2	9:1	80	109	215, 224, 992
M 115.955	B		4	93,75 x 83,6	2307	2	8:1	62	84	617, 620
M 115.971	B		4	93,75 x 83,6	2307	2	8:1	66	90	657, 661, 663
M 115.972	B		4	93,75 x 83,6	2307	2	8:1	62	84	617, 620, 627, 631
M 115.973	B		4	93,75 x 83,6	2307	2	8:1	66	90	219
M 115.974	B		4	93,75 x 83,6	2307	2	8:1	66	90	220
M 116.960	B		8	92 x 71,8	3818	2	9:1	160	218	303
M 116.961	B		8	92 x 71,8	3818	2	9:1	160	218	301
M 116.962	B		8	88 x 78,9	3818	2	9,4:1	150	204	303
M 116.963	B		8	88 x 78,9	3818	2	9,4:1	150	204	301
M 116.964	B		8	92 x 78,9	4196	2	9:1	160	218	307
M 116.965	B		8	92 x 78,9	4196	2	9:1	165	224	306
M 116.980	B		8	92 x 65,8	3499	2	9,5:1	147	200	262, 263
M 116.981	B		8	92 x 65,8	3499	2	9,5:1	147	200	290
M 116.982	B		8	92 x 65,8	3499	2	9,5:1	147	200	299
M 116.983	B		8	92 x 65,8	3499	2	9,5:1	147	200	297
M 116.984	B		8	92 x 65,8	3499	2	9:1	143-147	195-200	299
M 116.985	B		8	92 x 65,8	3499	2	9,5:1	143-151	194-205	297
M 116.990	B		8	92 x 65,8	3499	2	9:1	132	180	262
M 116.991	B		8	92 x 65,8	3499	2	9,5:1	147	200	290
M 116.992	B		8	92 x 65,8	3499	2	9:1	132	180	299
M 116.993	B		8	92 x 65,8	3499	2	9:1	132	180	297
M 117.962	B		8	96,5 x 85	4973	2	9,2:1	170	232	317
M 117.963	B		8	96,5 x 85	4973	2	9,2:1	170	232	314
M 117.964	B		8	96,5 x 85	4973	2	9,2:1	180	245	317
M 117.965	B		8	96,5 x 85	4973	2	9:1	170	231	94, 313, 314
M 117.968	B		8	96,5 x 94,8	5547	2	9:1	205	279	319
M 117.981	B		8	92 x 85	4520	2	8,8:1	160	218	291
M 117.982	B		8	92 x 85	4520	2	8,8:1	143	195	310
M 117.983	B		8	92 x 85	4520	2	8,8:1	143	195	308
M 117.985	B		8	92 x 85	4520	2	8,8:1	160	218	310
M 117.986	B		8	92 x 85	4520	2	8,8:1	165	224	308
M 117.992	B		8	92 x 85	4520	2	8:1	140	190	310
M 117.993	B		8	92 x 85	4520	2	8:1	140	190	308
M 119.960	B		8	96,5 x 85	4973	4	10:1	240	336	318
M 119.970	B		8	96,5 x 85	4973	4	10:1	235-240	320-326	115, 315
M 119.971	B		8	92 x 78,9	4196	4	10:1	205-210	280-286	112, 305
M 119.972	B		8	96,5 x 85	4973	4	10:1	235-240	320-326	318
M 119.974	B		8	96,5 x 85	4973	4	10:1	235-240	320-326	84, 312
M 119.975	B		8	92 x 78,9	4196	4	10:1	205	280	81, 304
M 119.980	B		8	96,5 x 85	4973	4	10:1	235	320	115
M 119.981	B		8	92 x 78,9	4196	4	11:1	205	279	112
M 119.982	B		8	96,5 x 85	4973	4	10:1	235	320	114, 121
M 119.985	B		8	92 x 78,9	4196	4	11:1	205	280	82
M 121.922	B		4	85 x 83,6	1897	2	8,5:1	48	65	511, 635, 649, 654



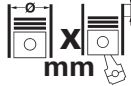

M



			Cyl	 X mm	cm ³		Comp. Ratio ε	kW	PS	Pos
M 121.924	B		4	85 x 83,6	1897	2	8,8:1	59	80	186
M 121.926	B		4	85 x 83,6	1897	2	8,8:1	50	68	511, 635, 649, 654
M 121.929	B		4	85 x 83,6	1897	2	8,8:1	59	80	511, 635, 649, 654
M 121.940	B		4	87 x 83,6	1988	2	9:1	70	95	198
M 121.941	B		4	87 x 83,6	1988	2	9:1	59	80	512, 636, 650, 655
M 121.942	B		4	87 x 83,6	1988	2	9:1	50	68	512, 636, 650, 655
M 121.943	B		4	87 x 83,6	1988	2	9:1	59	80	503, 645, 655
M 123.920	B		6	86 x 72,5	2525	2	8,7:1	95	129	233
M 123.921	B		6	86 x 72,5	2525	2	9,4:1	103	140	233
M 127.982	B		6	80 x 72,8	2196	2	8,7:1	88	120	212
M 127.984	B		6	80 x 72,8	2196	2	8,7:1	88	120	212
M 129.980	B		6	82 x 78,8	2496	2	9,3:1	110	150	212, 242
M 129.981	B		6	82 x 78,8	2496	2	9,3:1	110	150	212, 243
M 129.982	B		6	82 x 78,8	2496	2	9,3:1	110	150	244
M 130.920	B		6	86,5 x 78,8	2778	2	9,5:1	103	140	255
M 130.921	B		6	86,5 x 78,8	2778	2	8,7:1	92	125	255
M 130.923	B		6	86,5 x 78,8	2778	2	9,5:1	96	130	234
M 130.933	B		6	86,5 x 78,8	2778	2	8,7:1	87	118	234
M 130.980	B		6	86,5 x 78,8	2778	2	9,5:1	118	160	258, 259
M 130.981	B		6	86,5 x 78,8	2778	2	9,5:1	125	170	285
M 130.983	B		6	86,5 x 78,8	2778	2	9,5:1	125	170	265
M 130.984	B		6	86,5 x 78,8	2778	2	8,7:1	103	140	258, 259
M 166.940	B		4	80 x 69,5	1397	2	11:1	60	82	1
M 166.960	B		4	80 x 79,5	1598	2	10,8:1	75	102	1, 2
M 166.961	B		4	80 x 79,5	1598	2	11:1	60-75	82-102	159
M 166.990	B		4	84 x 85,6	1898	2	10,8:1	92	125	5
M 166.991	B		4	84 x 85,6	1898	2	10,8:1	92	125	160
M 166.995	B		4	84 x 84	2084	2	11:1	103	140	6
M 180.940	B		6	80 x 72,8	2196	2	8,7:1	70	95	208, 214
M 180.941	B		6	80 x 72,8	2196	2	8,7:1	81	110	208
M 180.945	B		6	81,75 x 72,8	2292	2	9:1	77	105	213
M 180.947	B		6	81,75 x 72,8	2292	2	9:1	88	120	208, 223
M 180.949	B		6	81,75 x 72,8	2292	2	9:1	88	120	213
M 180.950	B		6	82 x 72,8	2306	2	9:1	79	108	213
M 180.951	B		6	82 x 72,8	2306	2	9:1	79	108	223
M 180.954	B		6	82 x 72,8	2306	2	9:1	88	120	225
M 180.955	B		6	82 x 72,8	2306	2	9:1	78	106	225
M 271.940	B	(K)	4	82 x 85	1796	4	9,3:1	120	163	11, 36
M 352.921	B		6	97 x 128	5675	2		93	126	992
M 352.923	B		6	97 x 128	5675	2		93	126	992
M 352.924	B		6	97 x 128	5675	2		93	126	698, 992
M 352.929	B		6	97 x 128	5675	2		93	126	992
M 476.920	G	(LA)	6	128 x 155	11970	2		177	240	800, 889
M 476.921	G	(LA)	6	128 x 155	11970	2		175	238	992
OM 304.900-001	D	(A)	4	97,5 x 133	3972	2	16,5:1	61	83	992
OM 304.900-401	D	(A)	4	97,5 x 133	3972	2	16,5:1	85	115	992
OM 306.900-016 (ZA)	D	(A)	6	97,5 x 133	5958	2	16,5:1	92	125	699, 707, 723, 992
OM 306.900-017 (ZA)	D	(A)	6	97,5 x 133	5958	2	16,5:1	92	125	730, 992
OM 306.900-018 (ZA)	D	(A)	6	97,5 x 133	5958	2	16,5:1	92	125	695, 992
OM 314.900	D	(AN)	4	97 x 128	3780	2				992
OM 314.900-000	D	(AN)	4	97 x 128	3780	2				992
OM 314.900-001	D	(AN)	4	97 x 128	3780	2	17:1	47	64	992
OM 314.900-002	D	(AN)	4	97 x 128	3780	2	17:1	51	69	992
OM 314.900-003	D	(AN)	4	97 x 128	3780	2	17:1	46-54	63-74	992
OM 314.900-004	D	(AN)	4	97 x 128	3780	2	17:1	54	73	992
OM 314.900-005	D	(AN)	4	97 x 128	3780	2	17:1	59	80	992
OM 314.900-006	D	(AN)	4	97 x 128	3780	2	17:1	54	73	992
OM 314.900-007	D	(AN)	4	97 x 128	3780	2	17:1	54	73	992
OM 314.900-008	D	(AN)	4	97 x 128	3780	2	17:1	54	73	992
OM 314.900-010	D	(AN)	4	97 x 128	3780	2	17:1	54	73	992
OM 314.900-011	D	(AN)	4	97 x 128	3780	2	17:1	35	47	992
OM 314.900-012	D	(AN)	4	97 x 128	3780	2	17:1	54	73	992
OM 314.900-013	D	(AN)	4	97 x 128	3780	2	17:1	54	73	992
OM 314.900-014	D	(AN)	4	97 x 128	3780	2	17:1	59	80	992
OM 314.900-015	D	(AN)	4	97 x 128	3780	2	17:1	58	79	992
OM 314.900-016	D	(AN)	4	97 x 128	3780	2	17:1	57	78	992
OM 314.900-017	D	(AN)	4	97 x 128	3780	2	17:1	54	73	992
OM 314.900-018	D	(AN)	4	97 x 128	3780	2	17:1	54	73	992



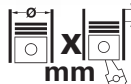

M



			Cyl	 mm	cm ³		Comp. Ratio ε	kW	PS	Pos
OM 314.900-019	D	(AN)	4	97 x 128	3780	2	17:1	59	80	992
OM 314.900-020	D	(AN)	4	97 x 128	3780	2	17:1	54	73	992
OM 314.900-021	D	(AN)	4	97 x 128	3780	2	17:1	63	85	992
OM 314.900-022	D	(AN)	4	97 x 128	3780	2	17:1	59	80	992
OM 314.900-023	D	(AN)	4	97 x 128	3780	2	17:1	54	73	992
OM 314.900-025	D	(AN)	4	97 x 128	3780	2	17:1	60	81	992
OM 314.910	D	(AN)	4	97 x 128	3780	2	17:1	63	85	669, 676, 681, 682, 992
OM 314.914	D	(AN)	4	97 x 128	3780	2				992
OM 314.916	D	(AN)	4	97 x 128	3780	2	17:1	40	54	554, 992
OM 314.917	D	(AN)	4	97 x 128	3780	2	17:1	55	75	558, 560, 561, 586, 992
OM 314.918	D	(AN)	4	97 x 128	3780	2	17:1	53	72	992
OM 314.919	D	(AN)	4	97 x 128	3780	2	17:1	53	72	992
OM 314.920	D	(AN)	4	97 x 128	3780	2	17:1	55	75	541, 992
OM 314.921	D	(AN)	4	97 x 128	3780	2	17:1	48	65	540, 992
OM 314.922	D	(AN)	4	97 x 128	3780	2	17:1	57	77	666, 669, 992
OM 314.940	D	(AN)	4	97 x 128	3780	2	17:1	49	67	992
OM 314.941	D	(AN)	4	97 x 128	3780	2	17:1	57	78	992
OM 314.942	D	(AN)	4	97 x 128	3780	2	17:1	59	80	992
OM 314.943	D	(AN)	4	97 x 128	3780	2	17:1	39	53	992
OM 314.944	D	(AN)	4	97 x 128	3780	2	17:1	63	85	669, 676, 681, 682, 992
OM 314.945	D	(AN)	4	97 x 128	3780	2	17:1			992
OM 314.946	D	(AN)	4	97 x 128	3780	2	17:1	63	85	659, 666, 668, 669, 992
OM 314.947	D	(AN)	4	97 x 128	3780	2	17:1	57	78	992
OM 314.948	D	(AN)	4	97 x 128	3780	2	17:1	63	86	508, 659, 666, 669, 992
OM 314.949	D	(AN)	4	97 x 128	3780	2	17:1	49	67	992
OM 314.950	D	(AN)	4	97 x 128	3780	2	17:1	53	72	992
OM 314.951	D	(AN)	4	97 x 128	3780	2	17:1	66	90	992
OM 314.953	D	(AN)	4	97 x 128	3780	2	17:1	59	80	561, 992
OM 314.954	D	(AN)	4	97 x 128	3780	2	17:1	53	72	992
OM 314.956	D	(AN)	4	97 x 128	3780	2	17:1	48	65	532, 540, 992
OM 314.957	D	(AN)	4	97 x 128	3780	2	17:1	53-55	72-75	540, 541, 992
OM 314.958 (TUR)	D	(AN)	4	97 x 128	3780	2	17:1	63	85	992
OM 314.959	D	(AN)	4	97 x 128	3780	2	17:1	63	85	508, 666, 669, 992
OM 314.960 (TUR)	D	(A)	4	97 x 128	3780	2	17:1	63	86	992
OM 314.961	D	(AN)	4	97 x 128	3780	2	17:1	63	86	666, 669, 992
OM 314.962	D	(AN)	4	97 x 128	3780	2	17:1	63	85	508, 666, 669, 992
OM 314.963	D	(AN)	4	97 x 128	3780	2	17:1	63	85	508, 666, 669, 992
OM 314.964	D	(AN)	4	97 x 128	3780	2	17:1	63	85	676, 682, 992
OM 314.965	D	(AN)	4	97 x 128	3780	2	17:1	63	85	676, 682, 992
OM 314.967	D	(AN)	4	97 x 128	3780	2	17:1	63	85	669, 992
OM 314.970	D	(A)	4	97 x 128	3780	2	16:1	63	85	543
OM 335.910 (IRN)	D	(AN)	6	128 x 150	11581	2	17,2:1	176	240	992
OM 335.930 (IRN)	D	(AN)	6	128 x 150	11581	2	17,2:1	154	210	817, 992
OM 335.932	D	(AN)	6	128 x 150	11581	2	17,2:1	176	240	992
OM 341.918 (AMS)	D	(AN)	6	97 x 128	5675	2	17:1	66	90	563, 581, 992
OM 341.934	D	(AN)	6	97 x 128	5675	2	17:1	62	84	577, 992
OM 341.937	D	(A)	6	97 x 128	5675	2	17:1	96	130	746, 747, 992
OM 341.938	D	(AN)	6	97 x 128	5675	2	17:1	66	90	563, 992
OM 341.941	D	(AN)	6	97 x 128	5675	2	17:1	96	130	707, 992
OM 341.947	D	(A)	6	97 x 128	5675	2	17:1	96	130	726, 732, 992
OM 344.912	D	(AN)	6	97 x 128	5675	2	17:1	96	130	698, 992
OM 344.937	D	(A)	6	97 x 128	5675	2	16:1	115	156	698, 701, 722, 723, 724, 726, 992
OM 344.939	D	(A)	6	97 x 128	5675	2	16:1	115	156	722, 723, 724, 992
OM 344.951	D	(A)	6	97 x 128	5675	2	16:1	115	156	722, 724, 992
OM 345.900 (USA)	D	(AN)	5	128 x 150	9651	2	17,2:1	141	192	732, 992
OM 345.910 (BRA)	D	(AN)	6	128 x 150	11581	2	17,2:1	176	240	820, 992
OM 345.912 (BRA)	D	(AN)	6	128 x 150	11581	2	17,2:1	176	240	820, 992
OM 345.913 (BRA)	D	(A)	6	128 x 150	11581	2	16,5:1	210	285	820, 825, 826, 992
OM 345.915 (BRA)	D	(AN)	5	128 x 150	9651	2	17,2:1	141	192	748, 749, 797, 798, 852, 853, 992
OM 345.947 (USA)	D	(AN)	5	128 x 150	9651	2	17,2:1	132	180	732
OM 345.950 (BRA)	D	(LA)	6	128 x 150	11581	2	16,5:1	235	320	827, 828, 992
OM 345.953 (BRA)	D	(LA)	6	128 x 150	11581	2	16,5:1	250	340	829, 992
OM 345.973 (BRA)	D	(AN)	5	128 x 150	9651	2	17,2:1	147	200	852, 853, 992
OM 346.951	D	(A)	6	128 x 140	10809	2				992
OM 347.915	D	(AN)	5	128 x 150	9651	2	17,2:1	141	192	750, 992
OM 352.900	D	(AN)	6	97 x 128	5675	2				992
OM 352.900-006	D	(A)	6	97 x 128	5675	2	16:1	115	156	992



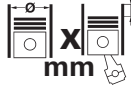

M





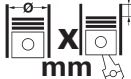

			Cyl	 mm	cm ³		Comp. Ratio ε	kW	PS	Pos
OM 352.900-000	D	(AN)	6	97 x 128	5675	2				992
OM 352.900-001	D	(AN)	6	97 x 128	5675	2	17:1	79	108	992
OM 352.900-002	D	(AN)	6	97 x 128	5675	2	17:1	92	125	992
OM 352.900-003	D	(AN)	6	97 x 128	5675	2	17:1	66	90	992
OM 352.900-004	D	(AN)	6	97 x 128	5675	2	17:1	67	91	992
OM 352.900-005	D	(AN)	6	97 x 128	5675	2	17:1	79	108	992
OM 352.900-007	D	(AN)	6	97 x 128	5675	2	17:1	88	120	992
OM 352.900-008	D	(A)	6	97 x 128	5675	2	16:1	124	168	992
OM 352.900-009	D	(AN)	6	97 x 128	5675	2	17:1	96	130	992
OM 352.900-010	D	(A)	6	97 x 128	5675	2	16:1	115	156	992
OM 352.900-011	D	(AN)	6	97 x 128	5675	2	17:1	91	124	992
OM 352.900-012	D	(AN)	6	97 x 128	5675	2	17:1	89	121	992
OM 352.900-013	D	(A)	6	97 x 128	5675	2	16:1	99	135	992
OM 352.900-014	D	(AN)	6	97 x 128	5675	2	17:1	79	108	992
OM 352.900-015	D	(A)	6	97 x 128	5675	2	16:1	103	140	992
OM 352.900-016	D	(AN)	6	97 x 128	5675	2	17:1	93	126	992
OM 352.900-017	D	(AN)	6	97 x 128	5675	2	17:1	79	108	992
OM 352.900-018	D	(AN)	6	97 x 128	5675	2	17:1	88	120	992
OM 352.900-019	D	(AN)	6	97 x 128	5675	2	17:1	90	122	992
OM 352.900-020	D	(AN)	6	97 x 128	5675	2	17:1	96	130	992
OM 352.900-021	D	(AN)	6	97 x 128	5675	2	17:1	85	116	992
OM 352.900-400	D	(A)	6	97 x 128	5675	2				992
OM 352.900-410	D	(A)	6	97 x 128	5675	2	16:1	107	145	992
OM 352.900-411	D	(A)	6	97 x 128	5675	2	16:1	103	140	992
OM 352.900-412	D	(A)	6	97 x 128	5675	2	16:1	103	140	992
OM 352.900-413	D	(A)	6	97 x 128	5675	2	16:1	107	145	992
OM 352.900-414	D	(A)	6	97 x 128	5675	2	16:1	123	168	992
OM 352.900-415	D	(A)	6	97 x 128	5675	2	16:1	123	168	992
OM 352.900-416	D	(A)	6	97 x 128	5675	2	16:1	115	156	992
OM 352.900-417	D	(A)	6	97 x 128	5675	2	16:1	106	144	992
OM 352.900-418	D	(A)	6	97 x 128	5675	2	16:1	124	168	992
OM 352.900-419	D	(A)	6	97 x 128	5675	2	16:1	124	168	992
OM 352.900-420	D	(A)	6	97 x 128	5675	2	16:1	107	145	992
OM 352.900-421	D	(A)	6	97 x 128	5675	2	16:1	111	150	992
OM 352.900-422	D	(A)	6	97 x 128	5675	2	16:1	113	154	992
OM 352.900-423	D	(A)	6	97 x 128	5675	2	16:1	110	150	992
OM 352.900-424	D	(A)	6	97 x 128	5675	2	16:1	110	150	992
OM 352.900-425	D	(A)	6	97 x 128	5675	2	16:1	124	168	992
OM 352.900-426	D	(A)	6	97 x 128	5675	2	16:1	115	156	992
OM 352.900-427	D	(A)	6	97 x 128	5675	2	16:1	114	155	992
OM 352.900-428	D	(A)	6	97 x 128	5675	2	16:1	110	150	992
OM 352.900-429	D	(A)	6	97 x 128	5675	2	16:1	115	156	992
OM 352.900-430	D	(A)	6	97 x 128	5675	2	16:1	119	162	992
OM 352.901	D	(AN)	6	97 x 128	5675	2	17:1	96	130	641, 729, 992
OM 352.902	D	(AN)	6	97 x 128	5675	2	17:1	52	70	559, 992
OM 352.903	D	(AN)	6	97 x 128	5675	2	17:1	66	90	561, 563, 992
OM 352.904	D	(AN)	6	97 x 128	5675	2	17:1	93	126	689, 698, 992
OM 352.905	D	(AN)	6	97 x 128	5675	2	17:1	96	130	698, 722, 725, 746, 992
OM 352.906	D	(AN)	6	97 x 128	5675	2	17:1	81	110	689, 992
OM 352.907	D	(AN)	6	97 x 128	5675	2	17:1	81	110	683, 689, 992
OM 352.908	D	(AN)	6	97 x 128	5675	2	17:1	96	130	689, 698, 992
OM 352.909	D	(AN)	6	97 x 128	5675	2	17:1	81	110	683, 689, 992
OM 352.910	D	(AN)	6	97 x 128	5675	2	17:1	74	100	640, 677, 992
OM 352.911	D	(AN)	6	97 x 128	5675	2	17:1	81	110	642, 689, 992
OM 352.912	D	(AN)	6	97 x 128	5675	2	17:1	96	130	639, 641, 642, 689, 698, 729, 744, 992
OM 352.913	D	(A)	6	97 x 128	5675	2	16:1	115	156	639, 641, 698, 729, 744, 992
OM 352.914	D	(AN)	6	97 x 128	5675	2	17:1	81	110	513, 698, 992
OM 352.915	D	(AN)	6	97 x 128	5675	2	17:1	93	126	513
OM 352.916	D	(A)	6	97 x 128	5675	2	16:1	110	150	513
OM 352.917	D	(AN)	6	97 x 128	5675	2	17:1	93	126	514
OM 352.918	D	(A)	6	97 x 128	5675	2	16:1	110	150	514
OM 352.919	D	(AN)	6	97 x 128	5675	2	17:1	48	65	557, 559, 561, 562, 587, 992
OM 352.930	D	(AN)	6	97 x 128	5675	2	17:1	96	130	641, 729, 744, 992
OM 352.931	D	(AN)	6	97 x 128	5675	2	17:1	96	130	641, 729, 776, 992
OM 352.932	D	(AN)	6	97 x 128	5675	2	17:1	81	110	640, 677, 992
OM 352.933	D	(AN)	6	97 x 128	5675	2	17:1	81	110	640, 677, 992

M





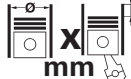

			Cyl	 X mm	cm ³		Comp. Ratio ε	kW	PS	Pos
OM 352.934	D	(AN)	6	97 x 128	5675	2	17:1	96	130	683, 689, 992
OM 352.935	D	(AN)	6	97 x 128	5675	2	17:1	96	130	744, 992
OM 352.936	D	(AN)	6	97 x 128	5675	2	17:1	96	130	689, 744, 992
OM 352.937	D	(A)	6	97 x 128	5675	2	16:1	110	150	547, 744, 992
OM 352.938	D	(AN)	6	97 x 128	5675	2	17:1	96	130	722, 992
OM 352.939	D	(AN)	6	97 x 128	5675	2	17:1	96	130	706, 722, 992
OM 352.942	D	(AN)	6	97 x 128	5675	2	17:1	74	100	640, 677, 992
OM 352.943	D	(AN)	6	97 x 128	5675	2	17:1	81	110	642, 689, 992
OM 352.944	D	(AN)	6	97 x 128	5675	2	17:1	93	126	639, 642, 689, 992
OM 352.945	D	(AN)	6	97 x 128	5675	2	17:1	96	130	641, 729, 992
OM 352.946	D	(A)	6	97 x 128	5675	2	16:1	110	150	641, 729, 992
OM 352.948	D	(AN)	6	97 x 128	5675	2	17:1	93	126	643, 689, 992
OM 352.949	D	(A)	6	97 x 128	5675	2	16:1	115	156	639, 698, 992
OM 352.950	D	(A)	6	97 x 128	5675	2	16:1	110	150	639, 698, 992
OM 352.953	D	(AN)	6	97 x 128	5675	2	17:1	93	126	639, 698, 992
OM 352.954	D	(AN)	6	97 x 128	5675	2	17:1	93	126	639, 992
OM 352.955	D	(AN)	6	97 x 128	5675	2	17:1	93	126	639, 698, 992
OM 352.956	D	(AN)	6	97 x 128	5675	2				992
OM 352.957	D	(AN)	6	97 x 128	5675	2				992
OM 352.958	D	(AN)	6	97 x 128	5675	2				992
OM 352.959	D	(AN)	6	97 x 128	5675	2	17:1	96	130	992
OM 352.960	D	(AN)	6	97 x 128	5675	2				992
OM 352.961	D	(AN)	6	97 x 128	5675	2				992
OM 352.962	D	(AN)	6	97 x 128	5675	2				992
OM 352.963	D	(AN)	6	97 x 128	5675	2	17:1	96	130	698, 722, 793, 992
OM 352.964	D	(AN)	6	97 x 128	5675	2	17:1	96	130	694, 698, 706, 722, 992
OM 352.965	D	(AN)	6	97 x 128	5675	2	17:1	69	94	992
OM 352.966	D	(AN)	6	97 x 128	5675	2	17:1	79	108	992
OM 352.967	D	(AN)	6	97 x 128	5675	2	17:1	74	100	992
OM 352.968	D	(A)	6	97 x 128	5675	2	16:1	115	156	698, 722, 992
OM 352.969	D	(AN)	6	97 x 128	5675	2	17:1	96	130	689, 992
OM 352.970	D	(AN)	6	97 x 128	5675	2	17:1	81	110	992
OM 352.971	D	(AN)	6	97 x 128	5675	2	17:1	74	100	992
OM 352.972	D	(AN)	6	97 x 128	5675	2	17:1	74	100	640, 677, 992
OM 352.973	D	(AN)	6	97 x 128	5675	2	17:1	74	100	640, 677, 992
OM 352.974	D	(AN)	6	97 x 128	5675	2	17:1	74	100	642, 689, 992
OM 352.975	D	(AN)	6	97 x 128	5675	2	17:1	74	100	642, 689, 992
OM 352.976	D	(AN)	6	97 x 128	5675	2	17:1	81	110	641, 729, 992
OM 352.978	D	(AN)	6	97 x 128	5675	2	17:1	96	130	641, 729, 992
OM 352.979	D	(AN)	6	97 x 128	5675	2	17:1	81	110	633, 634, 992
OM 352.980	D	(AN)	6	97 x 128	5675	2	17:1	96	130	498
OM 352.981	D	(AN)	6	97 x 128	5675	2	17:1	74	100	633, 634, 992
OM 352.982	D	(AN)	6	97 x 128	5675	2	17:1	81	110	638, 992
OM 352.983	D	(AN)	6	97 x 128	5675	2	17:1	74	100	633, 634, 992
OM 352.984	D	(AN)	6	97 x 128	5675	2	17:1	59	80	561, 578, 992
OM 352.985	D	(AN)	6	97 x 128	5675	2	17:1	74	100	683, 689, 992
OM 352.986	D	(AN)	6	97 x 128	5675	2	17:1	81	110	683, 689, 992
OM 352.987	D	(AN)	6	97 x 128	5675	2	17:1	93	126	706, 722, 992
OM 352.988	D	(A)	6	97 x 128	5675	2	16:1	96	130	992
OM 352.989	D	(AN)	6	97 x 128	5675	2	17:1	74	100	689, 992
OM 352.990	D	(AN)	6	97 x 128	5675	2	17:1	81	110	689, 698, 992
OM 352.991	D	(AN)	6	97 x 128	5675	2	17:1	93	126	722, 992
OM 352.992	D	(AN)	6	97 x 128	5675	2	17:1	93	126	633, 634, 992
OM 352.993	D	(AN)	6	97 x 128	5675	2	17:1	96	130	498
OM 352.994	D	(A)	6	97 x 128	5675	2	16:1	110	150	698, 722, 793, 992
OM 352.996	D	(AN)	6	97 x 128	5675	2	17:1	96	130	683, 689, 694, 698, 992
OM 352.997	D	(AN)	6	97 x 128	5675	2	17:1	96	130	698, 722, 725, 729, 731, 755, 992
OM 352.998	D	(AN)	6	97 x 128	5675	2	17:1	96	130	698, 992
OM 352.999	D	(AN)	6	97 x 128	5675	2	17:1	79	108	992
OM 353.900	D	(AN)	6	97 x 128	5675	2	17:1	96	130	689, 992
OM 353.901	D	(AN)	6	97 x 128	5675	2	17:1	74	100	561, 563, 566, 568, 578, 587, 589, 992
OM 353.902	D	(AN)	6	97 x 128	5675	2	17:1	62	84	557, 559, 561, 562, 563, 587, 589, 590, 992
OM 353.903	D	(AN)	6	97 x 128	5675	2	17:1	81	110	684, 691, 992
OM 353.904	D	(AN)	6	97 x 128	5675	2	17:1	96	130	686, 691, 694, 698, 992
OM 353.905	D	(AN)	6	97 x 128	5675	2	17:1	74	101	566, 578, 589, 992



			Cyl	 mm	cm ³		Comp. Ratio ε	kW	PS	Pos
OM 353.907	D	(AN)	6	97 x 128	5675	2	17:1	92	125	566, 570, 589, 590, 992
OM 353.909	D	(A)	6	97 x 128	5675	2	16:1	124	168	683, 689, 694, 698, 706, 722, 992
OM 353.910	D	(A)	6	97 x 128	5675	2	16:1	124	168	722, 744, 992
OM 353.911	D	(A)	6	97 x 128	5675	2	16:1	124	168	689, 698, 722, 793, 992
OM 353.912	D	(A)	6	97 x 128	5675	2	16:1	124	168	722, 744, 746, 992
OM 353.913	D	(A)	6	97 x 128	5675	2	16:1	124	168	698, 722, 992
OM 353.914	D	(A)	6	97 x 128	5675	2	16:1	124	168	722, 992
OM 353.915	D	(AN)	6	97 x 128	5675	2	17:1	81	110	684, 691, 992
OM 353.916	D	(AN)	6	97 x 128	5675	2	17:1	81	110	992
OM 353.917	D	(AN)	6	97 x 128	5675	2	17:1	96	130	992
OM 353.920	D	(A)	6	97 x 128	5675	2	16:1	124	168	731, 992
OM 353.921	D	(A)	6	97 x 128	5675	2	16:1	110	150	549, 593, 597, 992
OM 353.922	D	(AN)	6	97 x 128	5675	2	17:1	88	120	589, 992
OM 353.923	D	(AN)	6	97 x 128	5675	2	17:1	81	110	589, 992
OM 353.930	D	(AN)	6	97 x 128	5675	2	17:1	62	84	587, 992
OM 353.931	D	(AN)	6	97 x 128	5675	2	17:1	81	110	589, 992
OM 353.932	D	(AN)	6	97 x 128	5675	2	17:1	88	120	589, 992
OM 353.933	D	(AN)	6	97 x 128	5675	2	17:1	88	120	589, 698, 992
OM 353.934	D	(AN)	6	97 x 128	5675	2	17:1	88	120	689, 992
OM 353.935	D	(AN)	6	97 x 128	5675	2	17:1	88	120	706, 729, 992
OM 353.936	D	(AN)	6	97 x 128	5675	2	17:1	81	110	589, 992
OM 353.937	D	(A)	6	97 x 128	5675	2	16:1	92	125	593, 992
OM 353.938	D	(AN)	6	97 x 128	5675	2	17:1	88	120	698, 992
OM 353.939	D	(A)	6	97 x 128	5675	2	16:1	124	168	744, 746, 992
OM 353.940	D	(AN)	6	97 x 128	5675	2	17:1	81	110	566, 568, 587, 589, 590, 992
OM 353.941	D	(AN)	6	97 x 128	5675	2	17:1	96	130	684, 691, 992
OM 353.942	D	(AN)	6	97 x 128	5675	2	17:1	96	130	694, 992
OM 353.943	D	(AN)	6	97 x 128	5675	2	17:1	96	130	694, 706, 992
OM 353.944	D	(AN)	6	97 x 128	5675	2	17:1	96	130	694, 706, 729, 753, 992
OM 353.945	D	(AN)	6	97 x 128	5675	2	17:1	96	130	694, 706, 992
OM 353.946	D	(AN)	6	97 x 128	5675	2	17:1	96	130	694, 706, 729, 753, 992
OM 353.949	D	(AN)	6	97 x 128	5675	2	17:1	81	110	545, 992
OM 353.950	D	(A)	6	97 x 128	5675	2	16:1	124	168	696, 710, 992
OM 353.951	D	(A)	6	97 x 128	5675	2	16:1	124	168	696, 710, 731, 753, 755, 992
OM 353.952	D	(A)	6	97 x 128	5675	2	16:1	124	168	696, 710, 992
OM 353.953	D	(A)	6	97 x 128	5675	2	16:1	124	168	696, 710, 731, 755, 992
OM 353.954	D	(A)	6	97 x 128	5675	2	16:1	124	168	696, 992
OM 353.957	D	(AN)	6	97 x 128	5675	2	17:1	92	125	546, 992
OM 353.958	D	(A)	6	97 x 128	5675	2	16:1	110	150	573, 580, 592, 593, 597, 598, 601, 992
OM 353.959	D	(A)	6	97 x 128	5675	2	16:1	124	168	593, 601, 992
OM 353.960	D	(AN)	6	97 x 128	5675	2	17:1	88	120	569, 593, 992
OM 353.961	D	(AN)	6	97 x 128	5675	2	17:1	96	131	591, 592, 593, 598, 992
OM 353.962	D	(AN)	6	97 x 128	5675	2	17:1	70	95	565, 588, 589, 992
OM 353.963	D	(AN)	6	97 x 128	5675	2	17:1	96	130	509, 673, 992
OM 353.964	D	(AN)	6	97 x 128	5675	2	17:1	96	130	729, 753, 755, 992
OM 353.965	D	(AN)	6	97 x 128	5675	2	17:1	96	130	684, 686, 691, 694, 698, 992
OM 353.966	D	(AN)	6	97 x 128	5675	2	17:1	96	130	509, 673, 992
OM 353.967	D	(AN)	6	97 x 128	5675	2	17:1	74	100	501
OM 353.968	D	(AN)	6	97 x 128	5675	2	17:1	96	130	509, 673, 992
OM 353.969	D	(AN)	6	97 x 128	5675	2	17:1	96	130	509, 673, 992
OM 353.970	D	(A)	6	97 x 128	5675	2	16:1	124	168	696, 710, 992
OM 353.971	D	(A)	6	97 x 128	5675	2	16:1	124	168	696, 710, 731, 755, 992
OM 353.972	D	(A)	6	97 x 128	5675	2	16:1	124	168	696, 992
OM 353.973	D	(A)	6	97 x 128	5675	2	16:1	92	125	569, 580, 588, 593, 992
OM 353.974	D	(A)	6	97 x 128	5675	2	16:1	127	172	992
OM 353.975	D	(A)	6	97 x 128	5675	2	16:1	127	172	696, 992
OM 353.976	D	(A)	6	97 x 128	5675	2	16:1	110	150	549, 992
OM 353.977	D	(A)	6	97 x 128	5675	2	16:1	124	168	582, 992
OM 353.978	D	(A)	6	97 x 128	5675	2	16:1	124	168	755, 992
OM 353.980	D	(AN)	6	97 x 128	5675	2	17:1	81	110	588, 589, 992
OM 353.981	D	(AN)	6	97 x 128	5675	2	17:1	96	130	686, 691, 694, 992
OM 353.982	D	(AN)	6	97 x 128	5675	2	17:1	96	130	686, 691, 694, 698, 992
OM 353.983	D	(AN)	6	97 x 128	5675	2	17:1	96	130	683, 689, 992
OM 353.984	D	(AN)	6	97 x 128	5675	2	17:1	96	130	689, 992



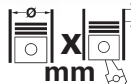

M



			Cyl	 mm	cm ³		Comp. Ratio ε	kW	PS	Pos
OM 353.985	D	(AN)	6	97 x 128	5675	2	17:1	70	95	544, 992
OM 353.989	D	(AN)	6	97 x 128	5675	2	17:1	96	130	694, 706, 992
OM 353.991	D	(A)	6	97 x 128	5675	2	16:1	124	168	693, 992
OM 353.995	D	(A)	6	97 x 128	5675	2	16:1	92	125	591, 592, 598, 992
OM 353.997	D	(A)	6	97 x 128	5675	2	16:1	124	168	696, 710, 992
OM 354.900	D	(LA)	4	97,5 x 133	3972	2	18:1	77	105	678, 684, 992
OM 354.901	D	(LA)	4	97,5 x 133	3972	2	18:1	77	105	684, 992
OM 354.902	D	(LA)	4	97,5 x 133	3972	2	18:1	77	105	671, 672, 677, 992
OM 354.903	D	(LA)	4	97,5 x 133	3972	2	18:1	77	105	677, 683, 684, 992
OM 354.920	D	(LA)	4	97,5 x 133	3972	2	18:1	103	140	687, 992
OM 354.921	D	(LA)	4	97,5 x 133	3972	2	18:1	103	140	687, 992
OM 354.922	D	(LA)	4	97,5 x 133	3972	2	18:1	103	140	687, 992
OM 354.923	D	(LA)	4	97,5 x 133	3972	2	18:1	103	140	680, 992
OM 354.924	D	(LA)	4	97,5 x 133	3972	2	18:1	103	140	674, 687, 992
OM 354.925	D	(LA)	4	97,5 x 133	3972	2	18:1	103	140	687, 992
OM 354.926	D	(LA)	4	97,5 x 133	3972	2		103	140	571, 572, 992
OM 355.910	D	(AN)	6	128 x 150	11581	2	17,2:1	169	230	853, 906, 992
OM 355.912	D	(AN)	6	128 x 150	11581	2	17,2:1	169	230	758, 761, 856, 906, 992
OM 355.913	D	(AN)	6	128 x 150	11581	2	17,2:1	169	230	819, 992
OM 355.914	D	(AN)	6	128 x 150	11581	2	17,2:1	169	230	819, 992
OM 355.916	D	(AN)	6	128 x 150	11581	2	17,2:1	169	230	992
OM 355.918	D	(AN)	6	128 x 150	11581	2	17,2:1	169	230	992
OM 355.960	D	(AN)	6	128 x 150	11581	2	17,2:1	176	240	761, 820, 906, 992
OM 355.962	D	(AN)	6	128 x 150	11581	2	17,2:1	176	240	761, 838, 855, 856, 992
OM 355.963	D	(AN)	6	128 x 150	11581	2	17,2:1	176	240	761, 820, 906, 992
OM 355.964	D	(AN)	6	128 x 150	11581	2	17,2:1	176	240	820, 992
OM 355.966	D	(AN)	6	128 x 150	11581	2	17,2:1	155	210	759, 817, 992
OM 355.967	D	(AN)	6	128 x 150	11581	2	17,2:1	176	240	498
OM 355.969	D	(A)	6	128 x 150	11581	2	16,5:1	207	280	824, 909, 992
OM 355.968	D	(A)	6	128 x 150	11581	2	16,5:1	191	260	498, 820, 825, 992
OM 355.970	D	(AN)	6	128 x 150	11581	2	17,2:1	191	260	992
OM 355.974	D	(AN)	6	128 x 150	11581	2	17,2:1	176	240	992
OM 355.975	D	(AN)	6	128 x 150	11581	2	17,2:1	176	240	906, 992
OM 355.976	D	(AN)	6	128 x 150	11581	2	17,2:1	177	240	906, 992
OM 355.977 (MEX)	D	(A)	6	128 x 150	11581	2	16,5:1	205	275	498, 820, 825
OM 355.978	D	(AN)	6	128 x 150	11581	2	17,2:1	176	240	498
OM 355.979 (ITA)	D	(AN)	6	128 x 150	11581	2	17,2:1	176	240	992
OM 355.980 (ITA)	D	(AN)	6	128 x 150	11581	2	17,2:1	176	240	992
OM 355.981 (SUI)	D	(AN)	6	128 x 150	11581	2	17,2:1	184	250	906, 992
OM 355.982 (SUI)	D	(AN)	6	128 x 150	11581	2	17,2:1	184	250	906, 992
OM 355.983	D	(AN)	6	128 x 150	11581	2	17,2:1	176	240	761, 820, 906, 992
OM 355.984	D	(AN)	6	128 x 150	11581	2	17,2:1	176	240	820, 906, 992
OM 356.901	D	(AN)	6	97,5 x 133	5958	2	17,25:1	95	129	687, 692, 992
OM 356.902	D	(AN)	6	97,5 x 133	5958	2	17,25:1	95	129	687, 992
OM 356.903	D	(AN)	6	97,5 x 133	5958	2	17,25:1	95	129	692, 699, 992
OM 356.904	D	(AN)	6	97,5 x 133	5958	2	17,25:1	95	129	699, 992
OM 356.905	D	(AN)	6	97,5 x 133	5958	2	17,25:1	95	129	992
OM 356.906	D	(AN)	6	97,5 x 133	5958	2	17,25:1	95	129	992
OM 356.907	D	(AN)	6	97,5 x 133	5958	2	17,25:1	95	129	699, 992
OM 356.908	D	(AN)	6	97,5 x 133	5958	2	17,25:1	95	129	723, 745, 992
OM 356.909	D	(AN)	6	97,5 x 133	5958	2	17,25:1	95	129	723, 992
OM 356.910	D	(AN)	6	97,5 x 133	5958	2	17,25:1	95	129	723, 992
OM 356.911	D	(AN)	6	97,5 x 133	5958	2	17,25:1	95	129	687, 692, 992
OM 356.912	D	(AN)	6	97,5 x 133	5958	2	17,25:1	81	110	587, 590, 992
OM 356.913	D	(AN)	6	97,5 x 133	5958	2	17,25:1	100	136	992
OM 356.914	D	(AN)	6	97,5 x 133	5958	2	17,25:1	92	102	588, 992
OM 356.915	D	(AN)	6	97,5 x 133	5958	2	17,25:1	97	132	992
OM 356.916	D	(AN)	6	97,5 x 133	5958	2	17,25:1	97	132	699, 992
OM 356.940	D	(A)	6	97,5 x 133	5958	2	17,25:1	116-129	158-175	731, 777, 992
OM 356.941	D	(A)	6	97,5 x 133	5958	2	16,5:1	116	158	693, 992
OM 356.943	D	(A)	6	97,5 x 133	5958	2	16,5:1	121	165	731, 992
OM 356.944	D	(A)	6	97,5 x 133	5958	2	16,5:1	116	158	725, 992
OM 356.945	D	(A)	6	97,5 x 133	5958	2	16,5:1	116	158	725, 992
OM 356.946	D	(A)	6	97,5 x 133	5958	2	16,5:1	116	158	746, 992
OM 356.947	D	(A)	6	97,5 x 133	5958	2	16,5:1	116	158	702, 992
OM 356.948	D	(A)	6	97,5 x 133	5958	2	16,5:1	116	158	688, 992
OM 356.949	D	(A)	6	97,5 x 133	5958	2	16,5:1	116	158	702, 992
OM 356.950	D	(A)	6	97,5 x 133	5958	2	16,5:1	92	125	591, 592, 596, 992
OM 356.951	D	(A)	6	97,5 x 133	5958	2	16,5:1	116	158	688, 992



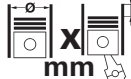

M



			Cyl	 mm	cm ³	 Comp. Ratio ε	kW	PS	Pos
OM 356.952	D	(A)	6	97,5 x 133	5958	2 16,5:1	116	158	693, 992
OM 356.953	D	(A)	6	97,5 x 133	5958	2 16,5:1	116	158	746, 992
OM 356.954	D	(A)	6	97,5 x 133	5958	2 16,5/18:1	92	125	591, 592, 595, 596, 599, 600, 992
OM 356.955	D	(A)	6	97,5 x 133	5958	2 18:1	100	136	591, 592, 593, 594, 595, 596, 598, 599, 600, 992
OM 356.956	D	(A)	6	97,5 x 133	5958	2 18:1	115	156	595, 596, 598, 599, 600, 992
OM 356.957	D	(A)	6	97,5 x 133	5958	2 18:1	125	170	601, 602, 992
OM 356.958	D	(A)	6	97,5 x 133	5958	2 16,5:1	116	158	731, 992
OM 356.959	D	(A)	6	97,5 x 133	5958	2 16,5:1	121	165	702, 992
OM 356.977 (TUR)	D	(LA)	6	97,5 x 133	5958	2 16,5:1	177	240	889, 992
OM 356.978	D	(LA)	6	97,5 x 133	5958	2 16,5:1	155	211	780, 816, 992
OM 356.979	D	(LA)	6	97,5 x 133	5958	2 16,5:1	177	240	705, 992
OM 356.980	D	(LA)	6	97,5 x 133	5958	2 16,5:1	170-177	231-240	598, 599, 600, 605, 606, 607, 608, 992
OM 356.981	D	(LA)	6	97,5 x 133	5958	2 18:1	127	173	602, 992
OM 356.983	D	(LA)	6	97,5 x 133	5958	2 16,5:1	177	240	703, 705, 727, 728, 992
OM 356.984	D	(LA)	6	97,5 x 133	5958	2 16,5:1	155	211	734, 780, 867, 870, 992
OM 356.985	D	(LA)	6	97,5 x 133	5958	2 16,5:1	150	204	780, 816, 992
OM 356.986	D	(LA)	6	97,5 x 133	5958	2 16,5:1	155	211	703, 992
OM 356.987	D	(LA)	6	97,5 x 133	5958	2 16,5:1	155	211	734, 798, 867, 992
OM 356.988	D	(LA)	6	97,5 x 133	5958	2 16,5:1	177	240	736, 992
OM 356.989	D	(LA)	6	97,5 x 133	5958	2 16,5:1	177	240	705, 992
OM 356.990	D	(LA)	6	97,5 x 133	5958	2 16,5:1	155	211	749, 992
OM 356.991	D	(LA)	6	97,5 x 133	5958	2 16,5:1	177	240	705, 992
OM 356.992	D	(LA)	6	97,5 x 133	5958	2 16,5:1	155	211	727, 992
OM 356.993	D	(LA)	6	97,5 x 133	5958	2 16,5:1	155	211	703, 727, 992
OM 356.994	D	(LA)	6	97,5 x 133	5958	2 16,5:1	155	211	703, 992
OM 356.995	D	(LA)	6	97,5 x 133	5958	2 16,5:1	155	211	703, 725, 727, 992
OM 356.996	D	(LA)	6	97,5 x 133	5958	2 16,5:1	155	211	703, 992
OM 356.997	D	(LA)	6	97,5 x 133	5958	2 16,5:1	132-155	170-211	598, 599, 600, 603, 605, 606, 992
OM 356.998	D	(LA)	6	97,5 x 133	5958	2 17,25:1	132	180	598, 599, 600, 603, 604, 992
OM 356.999	D	(LA)	6	97,5 x 133	5958	2 16,5:1	177	240	714, 719, 736, 738, 739, 742, 749, 751, 782, 800, 802, 992
OM 357.900	D	(LA)	6	97,5 x 133	5958	2 18:1	125	170	688, 693, 992
OM 357.901	D	(LA)	6	97,5 x 133	5958	2 18:1	125	170	693, 702, 992
OM 357.902	D	(LA)	6	97,5 x 133	5958	2 18:1	125	170	702, 725, 727, 992
OM 357.903	D	(LA)	6	97,5 x 133	5958	2 18:1	125	170	725, 746, 992
OM 357.904	D	(LA)	6	97,5 x 133	5958	2 18:1	125	170	688, 992
OM 357.906	D	(LA)	6	97,5 x 133	5958	2 18:1	125	170	693, 702, 992
OM 357.907	D	(LA)	6	97,5 x 133	5958	2 18:1	125	170	702, 725, 728, 992
OM 357.908	D	(LA)	6	97,5 x 133	5958	2 18:1	125	170	688, 992
OM 357.909	D	(LA)	6	97,5 x 133	5958	2 18:1	125	170	693, 992
OM 357.910	D	(LA)	6	97,5 x 133	5958	2 18:1	125	170	693, 992
OM 357.912	D	(LA)	6	97,5 x 133	5958	2 18:1	100	136	591, 592, 595, 596, 598, 599, 600, 992
OM 357.913	D	(LA)	6	97,5 x 133	5958	2 18:1	120	163	592, 595, 596, 598, 599, 600, 992
OM 357.915	D	(LA)	6	97,5 x 133	5958	2 18:1	125	170	731, 992
OM 357.916	D	(LA)	6	97,5 x 133	5958	2 18:1	125	170	688, 693, 992
OM 357.917	D	(LA)	6	97,5 x 133	5958	2 18:1	125	170	688, 992
OM 357.918	D	(LA)	6	97,5 x 133	5958	2 18:1	125	170	693, 702, 992
OM 357.919	D	(LA)	6	97,5 x 133	5958	2 18:1	125	170	702, 992
OM 357.920	D	(LA)	6	97,5 x 133	5958	2 18:1	155	211	703, 992
OM 357.921	D	(LA)	6	97,5 x 133	5958	2 18:1	155	211	703, 727, 992
OM 357.922	D	(LA)	6	97,5 x 133	5958	2 18:1	155	211	749, 992
OM 357.924	D	(LA)	6	97,5 x 133	5958	2 18:1	155	211	598, 599, 600, 603, 605, 606, 992
OM 357.925	D	(LA)	6	97,5 x 133	5958	2 18:1	155	211	780, 798, 992
OM 357.926	D	(LA)	6	97,5 x 133	5958	2 18:1	155	211	817, 992
OM 357.927	D	(LA)	6	97,5 x 133	5958	2 18:1	155	211	703, 992
OM 357.929	D	(LA)	6	97,5 x 133	5958	2 18:1	155	211	703, 992
OM 357.930	D	(LA)	6	97,5 x 133	5958	2 18:1	155	211	727, 749, 837, 992
OM 357.931	D	(LA)	6	97,5 x 133	5958	2 18:1	155	211	992
OM 357.932	D	(LA)	6	97,5 x 133	5958	2 18:1	155	211	703, 727, 992
OM 357.933	D	(LA)	6	97,5 x 133	5958	2 18:1	155	211	705, 992



M





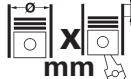

			Cyl	 mm	cm ³		Comp. Ratio ε	kW	PS	Pos
OM 357.936	D	(LA)	6	97,5 x 133	5958	2	18:1	155	211	688, 992
OM 357.937	D	(LA)	6	97,5 x 133	5958	2	18:1	155	211	688, 992
OM 357.938	D	(LA)	6	97,5 x 133	5958	2	18:1	155	211	688, 992
OM 357.940	D	(LA)	6	97,5 x 133	5958	2	18:1	177	240	728, 992
OM 357.941	D	(LA)	6	97,5 x 133	5958	2	18:1	177	240	751, 782, 992
OM 357.942	D	(LA)	6	97,5 x 133	5958	2	18:1	177	240	705, 992
OM 357.943	D	(LA)	6	97,5 x 133	5958	2	18:1	177	240	705, 992
OM 357.944	D	(LA)	6	97,5 x 133	5958	2	18:1	177	240	705, 992
OM 357.945	D	(LA)	6	97,5 x 133	5958	2	16,5:1	177	240	598, 599, 600, 605, 606, 607, 608, 992
OM 357.946	D	(LA)	6	97,5 x 133	5958	2	18:1	177	240	714, 731, 736, 992
OM 357.947	D	(LA)	6	97,5 x 133	5958	2	18:1	177	240	728, 751, 992
OM 357.948	D	(LA)	6	97,5 x 133	5958	2	18:1	177	240	728, 992
OM 357.949	D	(LA)	6	97,5 x 133	5958	2	18:1	177	240	820, 992
OM 357.961	D	(LA)	6	97,5 x 133	5958	2	18:1	125	170	693, 702, 725, 992
OM 357.962	D	(LA)	6	97,5 x 133	5958	2	18:1	125	170	725, 746, 992
OM 357.963	D	(LA)	6	97,5 x 133	5958	2	18:1	125	170	746, 992
OM 360.910	D	(AN)	6	115 x 140	8725	2				992
OM 360.911	D	(AN)	6	115 x 140	8725	2	16,8:1	125	170	501
OM 360.914	D	(AN)	6	115 x 140	8725	2	16,8:1	141	192	498
OM 360.915	D	(AN)	6	115 x 140	8725	2	16,8:1	141	192	498
OM 360.916 (TUR)	D	(AN)	6	115 x 140	8725	2	16,8:1	125	170	498
OM 360.917	D	(AN)	6	115 x 140	8725	2	16,8:1	125	170	498
OM 360.918	D	(AN)	6	115 x 140	8725	2	16,8:1	125	170	498
OM 360.930	D	(AN)	6	115 x 140	8725	2				992
OM 360.931	D	(AN)	6	115 x 140	8725	2	16,8:1	141	192	498
OM 360.933	D	(AN)	6	115 x 140	8725	2	16,8:1	125	170	498
OM 360.935	D	(AN)	6	115 x 140	8725	2	16,8:1	125	170	698, 722, 725, 746, 992
OM 360.936	D	(AN)	6	115 x 140	8725	2	16,8:1	125	170	698, 722, 725, 746, 992
OM 360.937	D	(AN)	6	115 x 140	8725	2	16,8:1	127	172	698, 722, 725, 729, 731, 755, 992
OM 360.938	D	(AN)	6	115 x 140	8725	2	16,8:1	127	172	698, 722, 725, 729, 731, 755, 992
OM 360.939	D	(AN)	6	115 x 140	8725	2	16,8:1	127	172	709, 725, 992
OM 360.940	D	(AN)	6	115 x 140	8725	2	16,8:1	127	172	746, 748, 992
OM 360.941	D	(AN)	6	115 x 140	8725	2	16,8:1	141	192	746, 748, 992
OM 360.942	D	(AN)	6	115 x 140	8725	2	16,8:1	127	172	746, 992
OM 360.943	D	(AN)	6	115 x 140	8725	2	16,8:1	127	172	796, 992
OM 360.944	D	(AN)	6	115 x 140	8725	2	16,8:1	127	172	709, 725, 992
OM 360.946	D	(AN)	6	115 x 140	8725	2	16,8:1	127	172	709, 725, 992
OM 360.948	D	(AN)	6	115 x 140	8725	2	16,8:1	125	170	746, 748, 992
OM 360.949	D	(AN)	6	115 x 140	8725	2	16,8:1	125	170	709, 725, 992
OM 360.950	D	(AN)	6	115 x 140	8725	2	16,8:1	125	170	709, 725, 992
OM 360.951	D	(AN)	6	115 x 140	8725	2	16,8:1	125	170	698, 722, 725, 729, 731, 755, 992
OM 360.952	D	(AN)	6	115 x 140	8725	2	16,8:1	125	170	698, 722, 725, 729, 731, 755, 992
OM 360.960	D	(AN)	6	115 x 140	8725	2	16,8:1	141	192	746, 992
OM 360.961	D	(AN)	6	115 x 140	8725	2	16,8:1	141	192	709, 725, 992
OM 360.962	D	(AN)	6	115 x 140	8725	2	16,8:1	127	172	698, 722, 725, 729, 731, 755, 992
OM 360.963	D	(AN)	6	115 x 140	8725	2	16,8:1	141	192	796, 797, 992
OM 360.964	D	(AN)	6	115 x 140	8725	2	16,8:1	141	192	709, 725, 992
OM 360.965	D	(AN)	6	115 x 140	8725	2	16,8:1	141	192	709, 725, 992
OM 360.966	D	(AN)	6	115 x 140	8725	2	16,8:1	141	192	992
OM 360.967	D	(AN)	6	115 x 140	8725	2	16,8:1	127	172	992
OM 360.968	D	(AN)	6	115 x 140	8725	2	16,8:1	93	127	992
OM 360.969	D	(AN)	6	115 x 140	8725	2	16,8:1	93	127	992
OM 360.970	D	(AN)	6	115 x 140	8725	2	16,8:1	103	140	992
OM 360.971	D	(AN)	6	115 x 140	8725	2	16,8:1	141	192	992
OM 360.972	D	(AN)	6	115 x 140	8725	2	16,8:1	141	192	709, 725, 992
OM 360.973	D	(AN)	6	115 x 140	8725	2	16,8:1	81	110	992
OM 360.975	D	(AN)	6	115 x 140	8725	2	16,8:1	141	192	992
OM 360.979 (TUR)	D	(AN)	6	115 x 140	8725	2	16,8:1	125	170	498
OM 360.982	D	(A)	6	115 x 140	8725	2	16,8:1	154	210	759, 992
OM 360.983	D	(AN)	6	115 x 140	8725	2	16,8:1	125	170	755, 992
OM 362.906	D	(LA)	6	97 x 128	5675	2	17:1	141	192	710, 733, 755, 757, 852, 992
OM 362.909	D	(LA)	6	97 x 128	5675	2	17:1	141	192	733, 734, 758, 853, 992

M





			Cyl		mm	cm ³	Comp. Ratio ϵ	kW	PS	Pos
OM 362.910	D	(LA)	6	97 x 128	5675	2	17:1	141	192	733, 734, 758, 852, 853, 992
OM 364.906	D	(AN)	4	97,5 x 133	3972	2	17,25:1	66	90	670, 676, 682, 992
OM 364.907	D	(AN)	4	97,5 x 133	3972	2	17,25:1	66	90	676, 682, 992
OM 364.908	D	(AN)	4	97,5 x 133	3972	2	17,25:1	50	68	540, 992
OM 364.909	D	(AN)	4	97,5 x 133	3972	2	17,25:1	57	78	541, 992
OM 364.911	D	(AN)	4	97,5 x 133	3972	2	17,25:1	66	90	682, 992
OM 364.912	D	(AN)	4	97,5 x 133	3972	2	17,25:1	66	90	676, 682, 992
OM 364.913	D	(AN)	4	97,5 x 133	3972	2		63	86	670, 676, 682, 992
OM 364.916	D	(AN)	4	97,5 x 133	3972	2	19:1	58	79	992
OM 364.917	D	(AN)	4	97,5 x 133	3972	2	19:1	60	82	992
OM 364.918	D	(AN)	4	97,5 x 133	3972	2	19:1	63	86	676, 682, 992
OM 364.919	D	(AN)	4	97,5 x 133	3972	2	19:1	63	86	670, 676, 992
OM 364.920	D	(AN)	4	97,5 x 133	3972	2	19:1	63	86	682, 992
OM 364.921	D	(AN)	4	97,5 x 133	3972	2	19:1	63	86	676, 682, 992
OM 364.950	D	(A)	4	97,5 x 133	3972	2	16,5:1	85	115	678, 684, 992
OM 364.951	D	(A)	4	97,5 x 133	3972	2	16,5:1	66	90	543, 992
OM 364.952	D	(A)	4	97,5 x 133	3972	2	16,5:1	85	115	678, 684, 992
OM 364.954	D	(A)	4	97,5 x 133	3972	2	16,5:1	85	115	672, 684, 992
OM 364.955	D	(LA)	4	97,5 x 133	3972	2	16,5:1	75	102	568, 992
OM 364.956	D	(LA)	4	97,5 x 133	3972	2	16,5:1	77	105	568, 992
OM 364.957	D	(A)	4	97,5 x 133	3972	2	18:1	77	105	678, 992
OM 364.958	D	(A)	4	97,5 x 133	3972	2	18:1	77	105	684, 992
OM 364.959	D	(A)	4	97,5 x 133	3972	2	18:1	77	105	531, 992
OM 364.981	D	(LA)	4	97,5 x 133	3972	2	17:1	100	136	687, 992
OM 364.982	D	(LA)	4	97,5 x 133	3972	2	18:1	98	133	571, 572, 992
OM 364.983	D	(LA)	4	97,5 x 133	3972	2	18:1	102	139	992
OM 364.984	D	(LA)	4	97,5 x 133	3972	2	17:1	100	136	687, 992
OM 364.985	D	(LA)	4	97,5 x 133	3972	2	18:1	100	136	572, 992
OM 364.986	D	(LA)	4	97,5 x 133	3972	2	18:1	100	136	687, 992
OM 364.987	D	(LA)	4	97,5 x 133	3972	2	18:1	100	136	687, 992
M OM 364.989	D	(LA)	4	97,5 x 133	3972	2	18:1	100	136	572, 992
OM 366.905	D	(AN)	6	97,5 x 133	5958	2	17,25:1	92-100	125-136	687, 692, 992
OM 366.906	D	(AN)	6	97,5 x 133	5958	2	17,25:1	92-102	125-139	699, 723, 730, 754, 794, 992
OM 366.907	D	(AN)	6	97,5 x 133	5958	2	17,25:1	100	136	687, 692, 699, 723, 992
OM 366.908	D	(AN)	6	97,5 x 133	5958	2	17,25:1	81	110	545, 992
OM 366.909	D	(AN)	6	97,5 x 133	5958	2	17,25:1	92-102	125-139	730, 754, 992
OM 366.910	D	(AN)	6	97,5 x 133	5958	2	17,25:1	92-102	125-139	687, 992
OM 366.911 (TUR)	D	(AN)	6	97,5 x 133	5958	2	19:1	96	130	588, 992
OM 366.912	D	(AN)	6	97,5 x 133	5958	2	17,25:1	74	101	544, 992
OM 366.913	D	(AN)	6	97,5 x 133	5958	2	17,25:1	92-102	125-139	707, 992
OM 366.914	D	(AN)	6	97,5 x 133	5958	2	17,25:1	92-102	125-139	692, 699, 723, 992
OM 366.915	D	(AN)	6	97,5 x 133	5958	2	17,25:1	96	102	588, 992
OM 366.917	D	(AN)	6	97,5 x 133	5958	2	17,25:1	92-102	125-139	497, 521
OM 366.918	D	(AN)	6	97,5 x 133	5958	2	17,25:1	92-102	125-139	692, 699, 723, 992
OM 366.919	D	(AN)	6	97,5 x 133	5958	2	17,25:1	92-102	125-139	687, 992
OM 366.930	D	(AN)	6	97,5 x 133	5958	2	17,25:1	92-102	125-139	692, 699, 992
OM 366.931	D	(AN)	6	97,5 x 133	5958	2	17,25:1	92-102	125-139	699, 992
OM 366.932	D	(AN)	6	97,5 x 133	5958	2	17,25:1	92-102	125-139	687, 692, 992
OM 366.933	D	(AN)	6	97,5 x 133	5958	2	17,25:1	92-102	125-139	699, 992
OM 366.935	D	(AN)	6	97,5 x 133	5958	2	17,25:1	92-102	125-139	699, 992
OM 366.936	D	(AN)	6	97,5 x 133	5958	2	19:1	92-102	125-139	723, 745, 992
OM 366.937	D	(AN)	6	97,5 x 133	5958	2	17,25:1	92-102	125-136	723, 992
OM 366.938	D	(AN)	6	97,5 x 133	5958	2	19:1	92-102	125-139	723, 992
OM 366.939	D	(LA)	6	97,5 x 133	5958	2	17,25:1	81	110	587, 590, 992
OM 366.940	D	(AN)	6	97,5 x 133	5958	2	17,25:1	100	136	692, 992
OM 366.941	D	(A)	6	97,5 x 133	5958	2	18:1	116	158	702, 704, 992
OM 366.942	D	(A)	6	97,5 x 133	5958	2	18:1	116	158	688, 992
OM 366.943	D	(A)	6	97,5 x 133	5958	2	18:1	116	158	688, 992
OM 366.944	D	(A)	6	97,5 x 133	5958	2	16,5:1	116-129	158-175	693, 725, 992
OM 366.945	D	(A)	6	97,5 x 133	5958	2	16,5:1	116-129	158-175	693, 746, 992
OM 366.946	D	(A)	6	97,5 x 133	5958	2	16,5:1	116-129	158-175	725, 992
OM 366.947	D	(A)	6	97,5 x 133	5958	2	16,5:1	100	136	592, 595, 596, 599, 600, 992
OM 366.948	D	(A)	6	97,5 x 133	5958	2	16,5:1	115	156	595, 596, 599, 600, 992
OM 366.949	D	(A)	6	97,5 x 133	5958	2	16,5:1	92	125	591, 592, 595, 599, 600, 992
OM 366.951	D	(A)	6	97,5 x 133	5958	2	16,5:1	125	170	696, 731, 755, 992





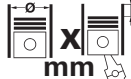

			Cyl	 mm	cm ³		Comp. Ratio ε	kW	PS	Pos
OM 366.952	D	(A)	6	97,5 x 133	5958	2	16,5:1	116-129	158-175	731, 733, 755, 777, 795, 992
OM 366.953	D	(A)	6	97,5 x 133	5958	2	16,5:1	125	170	702, 725, 746, 992
OM 366.954	D	(A)	6	97,5 x 133	5958	2	16,5:1	115	156	550, 992
OM 366.955	D	(A)	6	97,5 x 133	5958	2	16,5:1	100	136	593, 594, 595, 596, 598, 992
OM 366.956	D	(A)	6	97,5 x 133	5958	2	16,5:1	100	136	593, 595, 596, 598, 992
OM 366.957	D	(A)	6	97,5 x 133	5958	2	16,5:1	116-129	158-175	731, 992
OM 366.958	D	(A)	6	97,5 x 133	5958	2	16,5:1	100	136	548, 992
OM 366.960	D	(A)	6	97,5 x 133	5958	2	16,5:1	116-129	158-175	710, 992
OM 366.962	D	(A)	6	97,5 x 133	5958	2	16,5:1	116-129	158-175	702, 703, 704, 723, 725, 727, 746, 992
OM 366.963	D	(A)	6	97,5 x 133	5958	2	16,5:1	125-129	170-175	595, 596, 598, 601, 602, 992
OM 366.965	D	(A)	6	97,5 x 133	5958	2	16,5:1	125	170	497, 521
OM 366.966	D	(A)	6	97,5 x 133	5958	2	16,5:1	116-129	158-175	688, 693, 702, 723, 725, 727, 992
OM 366.967	D	(A)	6	97,5 x 133	5958	2	16,5:1	116-129	158-175	688, 992
OM 366.968	D	(A)	6	97,5 x 133	5958	2	16,5:1	116-129	158-175	688, 992
OM 366.969	D	(A)	6	97,5 x 133	5958	2	16,5:1	116-129	158-175	688, 992
OM 366.970	D	(A)	6	97,5 x 133	5958	2	16,5:1	116-129	158-175	702, 992
OM 366.971	D	(A)	6	97,5 x 133	5958	2	16,5:1	116-129	158-175	702, 992
OM 366.973	D	(A)	6	97,5 x 133	5958	2	16,5:1	116-129	158-175	688, 992
OM 366.974	D	(A)	6	97,5 x 133	5958	2	16,5:1	116-129	158-175	693, 992
OM 366.975	D	(A)	6	97,5 x 133	5958	2	16,5:1	116-129	158-175	702, 992
OM 366.976	D	(A)	6	97,5 x 133	5958	2	16,5:1	116-129	159-175	702, 992
OM 366.977	D	(A)	6	97,5 x 133	5958	2	16,5:1	92	125	547, 992
OM 366.978	D	(A)	6	97,5 x 133	5958	2	16,5:1	116-129	158-175	693, 992
OM 366.979	D	(A)	6	97,5 x 133	5958	2	16,5:1	116-129	158-175	746, 992
OM 366.980	D	(LA)	6	97,5 x 133	5958	2	16,5:1	148	201	703, 727, 992
OM 366.981	D	(LA)	6	97,5 x 133	5958	2	16,5:1	148	201	696, 733, 755, 758, 992
OM 366.983	D	(LA)	6	97,5 x 133	5958	2	16,5:1	146-155	199-211	733, 734, 755, 757, 758, 780, 781, 852, 853, 854, 870, 992
OM 366.984	D	(LA)	6	97,5 x 133	5958	2	16,5:1	148-157	201-214	598, 602, 605, 606, 992
OM 366.988	D	(LA)	6	97,5 x 133	5958	2	16,5:1	146-155	199-211	703, 725, 727, 992
OM 366.990	D	(LA)	6	97,5 x 133	5958	2	16,5:1	146-155	199-211	703, 992
OM 366.992	D	(LA)	6	97,5 x 133	5958	2	16,5:1	146-155	199-211	703, 727, 992
OM 366.993	D	(LA)	6	97,5 x 133	5958	2	16,5:1	146-155	199-211	703, 992
OM 366.994	D	(LA)	6	97,5 x 133	5958	2	16,5:1	146-155	199-211	703, 992
OM 366.995	D	(LA)	6	97,5 x 133	5958	2	16,5:1	146-155	199-211	749, 780, 837, 992
OM 366.996	D	(LA)	6	97,5 x 133	5958	2	16,5:1	146-155	199-211	780, 816, 992
OM 366.997	D	(LA)	6	97,5 x 133	5958	2	16,5:1	146-155	199-211	725, 727, 837, 992
OM 366.999	D	(LA)	6	97,5 x 133	5958	2	17,25:1	170	231	703, 713, 714, 719, 728, 751, 782, 838, 992
OM 370.905	D	(AN)	4	97,5 x 133	3972	2	17,25:1	66	90	677, 992
OM 370.950	D	(A)	4	97,5 x 133	3972	2	16,5:1	85	115	691, 992
OM 370.951	D	(A)	4	97,5 x 133	3972	2	16,5:1	85	115	686, 992
OM 370.952	D	(A)	4	97,5 x 133	3972	2	16,5:1	80	110	677, 992
OM 374.905	D	(AN)	4	97,5 x 133	3972	2	17,25:1	66	90	676, 677, 992
OM 374.907	D	(AN)	4	97,5 x 133	3972	2	17,25:1	66	90	682, 992
OM 374.908	D	(AN)	4	97,5 x 133	3972	2	17,25:1	66	90	682, 992
OM 374.950	D	(AN)	4	97,5 x 133	3972	2	16,5:1	85	115	685, 690, 691, 992
OM 374.951	D	(AN)	4	97,5 x 133	3972	2	16,5:1	85	115	679, 992
OM 374.952	D	(AN)	4	97,5 x 133	3972	2	16,5:1	85	115	685, 992
OM 374.953	D	(AN)	4	97,5 x 133	3972	2	16,5:1	80	110	671, 677, 992
OM 374.980	D	(A)	4	97,5 x 133	3972	2	16,5:1	100	136	687, 692, 699, 992
OM 374.981	D	(A)	4	97,5 x 133	3972	2	16,5:1	104	140	692, 992
OM 374.982	D	(A)	4	97,5 x 133	3972	2	16,5:1	104	140	692, 992
OM 374.984	D	(A)	4	97,5 x 133	3972	2	16,5:1	100	136	687, 692, 699, 992
OM 374.985	D	(A)	4	97,5 x 133	3972	2	16,5:1	104	140	707, 992
OM 374.986	D	(A)	4	97,5 x 133	3972	2	16,5:1	77	105	677, 992
OM 374.987	D	(A)	4	97,5 x 133	3972	2	16,5:1	104	140	687, 992
OM 374.988	D	(A)	4	97,5 x 133	3972	2	16,5:1	81	110	677, 992
OM 382.912	D	(AN)	6	97,5 x 133	5958	2	17,25:1	100	136	730, 794, 992
OM 382.913	D	(A)	6	97,5 x 133	5958	2	16,5:1	125	170	796, 886, 992
OM 382.916 (TUR)	D	(AN)	6	97,5 x 133	5958	2		96	130	593, 992
OM 382.919	D	(A)	6	97,5 x 133	5958	2	16,5:1	150	204	799, 887, 992
OM 382.971	D	(A)	6	97,5 x 133	5958	2	16,5:1	150	204	799, 992





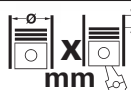

			Cyl		mm	cm ³	Comp. Ratio	€	kW	PS	Pos
OM 394.900-005 (AFS)	D	(AN)	4	97 x 128	3780	2	17:1	57	78	668, 669, 992	
OM 394.900-006 (AFS)	D	(AN)	4	97 x 128	3780	2	17:1	55	75	541, 992	
OM 394.900-007 (AFS)	D	(AN)	4	97 x 128	3780	2	17:1	48	65	540, 992	
OM 394.900-009 (AFS)	D	(AN)	4	97 x 128	3780	2	17:1	63	85	542, 992	
OM 396.900-005	D	(AN)	6	97 x 128	5675	2	17:1	88	120	689, 698, 992	
OM 396.900-007	D	(AN)	6	97 x 128	5675	2	17:1	88	120	689, 992	
OM 396.900-008 (AFS)	D	(AN)	6	97 x 128	5675	2	17:1	88	120	706, 729, 992	
OM 396.900-009	D	(AN)	6	97 x 128	5675	2	17:1	81	110	992	
OM 396.900-010	D	(AN)	6	97 x 128	5675	2	17:1	81	110	992	
OM 396.900-011	D	(AN)	6	97 x 128	5675	2	17:1	81	110	992	
OM 396.900-012	D	(AN)	6	97 x 128	5675	2	17:1	88	120	698, 992	
OM 396.900-013	D	(AN)	6	97 x 128	5675	2	17:1	81	110	992	
OM 396.900-014	D	(AN)	6	97 x 128	5675	2	17:1	88	120	992	
OM 396.900-015	D	(AN)	6	97 x 128	5675	2	17:1	81	110	992	
OM 396.900-016 (AFS)	D	(AN)	6	97 x 128	5675	2	17:1	88	120	729, 992	
OM 396.900-017	D	(AN)	6	97 x 128	5675	2	17:1	88	120	992	
OM 396.900-020 (AFS)	D	(AN)	6	97 x 128	5675	2	17:1	88	120	706, 992	
OM 396.900-021	D	(AN)	6	97 x 128	5675	2	17:1	88	120	992	
OM 396.900-024	D	(AN)	6	97 x 128	5675	2	17:1	70	95	992	
OM 396.900-026	D	(AN)	6	97 x 128	5675	2	17:1	88	120	992	
OM 401.901-504	D	(LA)	6	125 x 130	9572	2				992	
OM 401.905	D	(AN)	6	125 x 130	9572	2	17,2:1	141	192	712, 733, 757, 797, 852, 992	
OM 401.906	D	(AN)	6	125 x 130	9572	2	17,2:1	141	192	712, 992	
OM 401.907	D	(AN)	6	125 x 130	9572	2	17,2:1	141	192	499	
OM 401.908	D	(AN)	6	125 x 130	9572	2	17,2:1	141	192	499	
OM 401.909	D	(AN)	6	125 x 130	9572	2	17,2:1	141	192	779, 815, 992	
OM 401.912	D	(AN)	6	125 x 130	9572	2	17,2:1	141	192	499	
OM 401.913	D	(AN)	6	125 x 130	9572	2	17,2:1	141	192	499	
OM 401.914	D	(AN)	6	125 x 130	9572	2	17,2:1	141	192	712, 733, 757, 852, 992	
OM 401.915	D	(AN)	6	125 x 130	9572	2	17,2:1	141	192	712, 992	
M OM 401.916	D	(AN)	6	125 x 130	9572	2	17,2:1	141	192	779, 815, 992	
OM 401.917	D	(A)	6	125 x 130	9572	2	17,2:1	188	256	499	
OM 401.918	D	(AN)	6	125 x 130	9572	2	17,2:1	141	192	712, 992	
OM 401.919	D	(AN)	6	125 x 130	9572	2	17,2:1	141	192	697, 712, 733, 992	
OM 401.921	D	(AN)	6	125 x 130	9572	2	17,2:1	141	192	712, 992	
OM 401.922	D	(AN)	6	125 x 130	9572	2	17,2:1	141	192	697, 712, 733, 992	
OM 401.923	D	(AN)	6	125 x 130	9572	2	17,2:1	141	192	733, 757, 814, 852, 992	
OM 401.924	D	(AN)	6	125 x 142	10456	2	17,5:1	144	196	697, 712, 733, 757, 779, 852, 992	
OM 401.925	D	(AN)	6	125 x 130	9572	2	17,2:1	141	192	712, 852, 992	
OM 401.926	D	(AN)	6	125 x 130	9572	2	17,2:1	141	192	852, 992	
OM 401.927	D	(AN)	6	125 x 130	9572	2	17,2:1	141	192	852, 992	
OM 401.928	D	(AN)	6	125 x 130	9572	2	17,2:1	141	192	757, 852, 992	
OM 401.970	D	(LA)	6	125 x 130	9572	2	16,75:1	213	290	494, 523	
OM 401.972	D	(LA)	6	125 x 130	9572	2	16,75:1	230	313	804, 843, 893, 911, 939, 992	
OM 401.973	D	(LA)	6	125 x 130	9572	2	16,75:1	200	272	716, 717, 735, 736, 739, 741, 784, 785, 800, 802, 823, 871, 874, 875, 890, 992	
OM 401.974	D	(LA)	6	125 x 130	9572	2	16,75:1	200	272	523, 719, 992	
OM 401.975	D	(LA)	6	125 x 130	9572	2	16,75:1	180	245	713, 714, 735, 736, 800, 818, 838, 889, 906, 908, 992	
OM 401.977	D	(LA)	6	125 x 130	9572	2	16,75:1	200	272	735, 739, 802, 871, 874, 875, 890, 992	
OM 401.978	D	(LA)	6	125 x 130	9572	2	16,75:1	200	272	717, 739, 785, 802, 874, 875, 890, 906, 908, 992	
OM 401.979	D	(LA)	6	125 x 130	9572	2	16,75:1	230	313	735, 742, 804, 843, 871, 893, 910, 911, 930, 939, 992	
OM 401.980	D	(LA)	6	125 x 130	9572	2	16,75:1	200	272	890, 992	
OM 401.981	D	(LA)	6	125 x 130	9572	2	16,75:1	230	313	911, 992	
OM 401.984	D	(LA)	6	125 x 130	9572	2	16,75:1	180	245	714, 716, 764, 800, 838, 992	
OM 401.985	D	(LA)	6	125 x 130	9572	2	16,75:1	200	272	739, 992	
OM 401.986	D	(LA)	6	125 x 130	9572	2	16,75:1	230	313	719, 804, 843, 911, 992	
OM 401.987	D	(LA)	6	125 x 130	9572	2	16,75:1	230	313	911, 992	
OM 401.989	D	(LA)	6	125 x 130	9572	2	16,75:1	200	272	716, 717, 802, 841, 992	



			Cyl	 X mm	cm ³		Comp. Ratio ε	kW	PS	Pos
OM 401.990	D	(LA)	6	125 x 130	9572	2	16,75:1	180	245	714, 800, 992
OM 401.991	D	(LA)	6	125 x 130	9572	2	16,75:1	200	272	739, 802, 992
OM 401.993	D	(LA)	6	125 x 130	9572	2	16,75:1	230	313	804, 843, 893, 911, 939, 992
OM 401.994	D	(LA)	6	125 x 130	9572	2	16,75:1	180	245	736, 992
OM 402.900-001	D	(AN)	8	125 x 130	12760	2	16,75:1	188	256	992
OM 402.900-003	D	(AN)	8	125 x 130	12760	2	16,75:1	177	240	992
OM 402.900-004	D	(AN)	8	125 x 130	12760	2	16,75:1	147	188	992
OM 402.900-400	D	(A)	8	125 x 130	12760	2	16,75:1	180	245	992
OM 402.900/-000	D	(A)	8	125 x 130	12760	2				992
OM 402.901/-000	D	(AN)	8	125 x 142	13941	2				992
OM 402.901/-504	D	(LA)	8	125 x 130	12760	2				992
OM 402.905	D	(AN)	8	125 x 130	12760	2	17,2:1	188	256	763, 858, 992
OM 402.906	D	(AN)	8	125 x 130	12760	2	17,2:1	188	256	763, 822, 907, 992
OM 402.907	D	(AN)	8	125 x 130	12760	2	17,2:1	188	256	499
OM 402.910	D	(AN)	8	125 x 130	12760	2	17,2:1	177	240	736, 761, 856, 992
OM 402.911	D	(AN)	8	125 x 130	12760	2	17,2:1	177	240	736, 761, 856, 992
OM 402.912	D	(AN)	8	125 x 130	12760	2	17,2:1	188	256	763, 822, 840, 858, 907, 992
OM 402.913	D	(AN)	8	125 x 130	12760	2	17,2:1	177	240	992
OM 402.914	D	(AN)	8	125 x 130	12760	2	17,2:1	177	240	856, 992
OM 402.916	D	(AN)	8	125 x 130	12760	2	17,2:1	188	256	763, 822, 840, 858, 907, 992
OM 402.917	D	(AN)	8	125 x 130	12760	2	17,2:1	177	240	820, 992
OM 402.919	D	(AN)	8	125 x 130	12760	2	17,2:1	177	240	736, 992
OM 402.921	D	(AN)	8	125 x 130	12760	2	17,2:1	177	240	736, 992
OM 402.923	D	(AN)	8	125 x 130	12760	2	17,2:1	177	240	761, 992
OM 402.924	D	(AN)	8	125 x 130	12760	2	17,2:1	188	256	763, 858, 992
OM 402.925	D	(AN)	8	125 x 130	12760	2	17,2:1	188	256	907, 992
OM 402.926	D	(AN)	8	125 x 130	12760	2	17,2:1	188	256	907, 992
OM 402.927	D	(AN)	8	125 x 130	12760	2	17,2:1	177	240	856, 992
OM 402.928	D	(AN)	8	125 x 130	12760	2	17,2:1	177	240	856, 992
OM 402.970	D	(LA)	8	125 x 130	12760	2	16,75:1	280	381	494, 523
OM 402.971	D	(LA)	8	125 x 130	12760	2	16,75:1	280	381	808, 809, 848, 898, 900, 915, 918, 943, 992
OM 402.972	D	(LA)	8	125 x 130	12760	2	16,75:1	280	381	808, 848, 898, 918, 992
OM 402.973	D	(LA)	8	125 x 130	12760	2	16,75:1	280	381	943, 961, 992
OM 402.974	D	(LA)	8	125 x 130	12760	2	16,75:1	280-295	381-401	523, 918, 961, 992
OM 402.975	D	(LA)	8	125 x 130	12760	2	16,75:1	280	381	808, 898, 918, 992
OM 402.977	D	(LA)	8	125 x 130	12760	2	16,75:1	280	381	943, 961, 992
OM 402.978	D	(LA)	8	125 x 130	12760	2	16,75:1	280	381	848, 918, 961, 992
OM 402.982	D	(LA)	8	125 x 130	12760	2	16,75:1	280	381	943, 961, 992
OM 402.983	D	(LA)	8	125 x 130	12760	2	16,75:1	280	381	942, 959, 961, 992
OM 402.984	D	(LA)	8	125 x 130	12760	2	16,75:1	280	381	499, 515, 516, 918, 961, 992
OM 402.985	D	(LA)	8	125 x 130	12760	2	16,75:1	280	381	808, 832, 848, 898, 918, 943, 992
OM 402.986	D	(LA)	8	125 x 130	12760	2	16,75:1	280	381	808, 848, 898, 918, 992
OM 402.987	D	(LA)	8	125 x 130	12760	2	16,75:1	280	381	943, 961, 992
OM 402.989	D	(LA)	8	125 x 130	12760	2	16,75:1	280	381	898, 992
OM 402.990	D	(LA)	8	125 x 130	12760	2	16,75:1	280	381	898, 992
OM 402.995	D	(LA)	8	125 x 130	12760	2	16,75:1	280	381	499, 515, 516
OM 402.996	D	(LA)	8	125 x 130	12760	2	16,75:1	280	381	808, 811, 813, 843, 848, 898, 901, 919, 992
OM 403.910-001	D	(AN)	10	125 x 130	15960	2	17,2:1	184	250	992
OM 403.910-002	D	(AN)	10	125 x 130	15960	2	17,2:1	236	320	992
OM 403.910-003	D	(AN)	10	125 x 130	15960	2	17,2:1	199	270	992
OM 403.910-004	D	(AN)	10	125 x 130	15960	2	17,2:1	199	270	992
OM 403.910-005	D	(AN)	10	125 x 130	15960	2	17,2:1	236	320	992
OM 403.910-006	D	(AN)	10	125 x 130	15960	2	17,2:1	211	300	992
OM 403.910/-000	D	(AN)	10	125 x 130	15960	2				992
OM 403.911/-000	D	(AN)	10	125 x 130	15960	2				992
OM 403.915	D	(AN)	10	125 x 130	15960	2	17,2:1	236	320	768, 827, 844, 861, 992
OM 403.916	D	(AN)	10	125 x 130	15960	2	17,2:1	236	320	768, 827, 912, 992
OM 403.917	D	(AN)	10	125 x 130	15960	2	17,2:1	236	320	992
OM 403.918	D	(AN)	10	125 x 130	15960	2	17,2:1	236	320	499
OM 403.919	D	(AN)	10	125 x 130	15960	2	17,2:1	236	320	992
OM 403.930	D	(AN)	10	125 x 130	15960	2	17,2:1	236	320	992



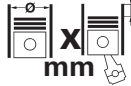

M





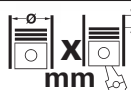

			Cyl	 mm	cm ³		Comp. Ratio ε	kW	PS	Pos
OM 403.931	D	(AN)	10	125 x 130	15960	2	17,2:1	236	320	768, 827, 844, 861, 912, 950, 992
OM 403.932	D	(AN)	10	125 x 130	15960	2	17,2:1	236	320	768, 827, 844, 861, 912, 950, 992
OM 403.933	D	(AN)	10	125 x 130	15960	2	17,2:1	261	355	827, 912, 992
OM 403.934	D	(AN)	10	125 x 130	15960	2	17,2:1	236	320	768, 827, 861, 992
OM 403.935	D	(AN)	10	125 x 130	15960	2	17,2:1	261	355	768, 827, 844, 861, 912, 992
OM 407.900-001	D	(AN)	6	125 x 150	11040	2	17:1	155	210	992
OM 407.900-002	D	(AN)	6	125 x 150	11040	2	17:1	132	180	992
OM 407.900/-000	D	(AN)	6	125 x 150	11040	2				992
OM 407.901	D	(AN)	6	125 x 155	11412	2				992
OM 407.901-400	D	(A)	6	125 x 155	11412	2				992
OM 407.901-500	D	(LA)	6	125 x 155	11412	2				992
OM 407.901-600	D	(A)	6	125 x 155	11412	2				992
OM 407.905	D	(AN)	6	125 x 150	11040	2	17:1	132	180	501, 502
OM 407.907	D	(AN)	6	125 x 150	11040	2	17:1	155	210	502
OM 407.908	D	(AN)	6	125 x 150	11040	2	17:1	132	180	501
OM 407.909	D	(AN)	6	125 x 150	11040	2	17:1	155	210	501
OM 407.910	D	(AN)	6	125 x 150	11040	2	17:1	155	210	501
OM 407.911	D	(AN)	6	125 x 150	11040	2	17:1	155	210	502
OM 407.913	D	(AN)	6	125 x 155	11412	2		147	200	501
OM 407.914	D	(AN)	6	125 x 155	11412	2		147	200	501
OM 407.915	D	(AN)	6	125 x 155	11412	2		147	200	502
OM 407.916	D	(AN)	6	125 x 155	11412	2		177	240	502
OM 407.917	D	(AN)	6	125 x 155	11412	2		177	240	501
OM 407.918	D	(AN)	6	125 x 155	11412	2		177	240	502
OM 407.919	D	(AN)	6	125 x 155	11412	2		177	240	501
OM 407.920	D	(AN)	6	125 x 155	11412	2	16,5:1	177	240	992
OM 407.930 (AFS)	D	(AN)	6	125 x 155	11412	2	16,5:1	162	220	820, 906, 992
OM 407.931 (AFS)	D	(AN)	6	125 x 155	11412	2	16,5:1	162	220	761, 992
OM 407.932 (AFS)	D	(AN)	6	125 x 155	11412	2	16,5:1	162	220	906, 992
OM 407.951	D	(A)	6	125 x 155	11412	2	16,5:1	206	280	501, 992
OM 407.952 (AFS)	D	(A)	6	125 x 155	11412	2	16,5:1	206	280	824, 909, 992
OM 407.953 (AFS)	D	(A)	6	125 x 155	11412	2	16,5:1	206	280	909, 992
OM 407.954 (AFS)	D	(LA)	6	125 x 155	11412	2	16,5:1	235	320	912, 992
OM 407.955	D	(A)	6	125 x 155	11412	2	16,5:1	206	280	501, 502
OM 407.956 (AFS)	D	(A)	6	125 x 155	11412	2	16,5:1	206	280	824, 909, 992
OM 409.906 (AFS)	D	(AN)	5	125 x 150	9204	2	17:1	135	183	733, 852, 992
OM 409.907 (AFS)	D	(AN)	5	125 x 150	9204	2	17:1	135	183	733, 757, 992
OM 409.908 (AFS)	D	(AN)	5	125 x 150	9204	2	17:1	135	183	852, 992
OM 421.900	D	(AN)	6	128 x 142	10965	2				992
OM 421.901-410	D	(A)	6	128 x 142	10965	2				992
OM 421.901-500	D	(LA)	6	128 x 142	10965	2				992
OM 421.901-510	D	(LA)	6	128 x 142	10965	2				992
OM 421.901/-400	D	(A)	6	128 x 142	10965	2				992
OM 421.905	D	(AN)	6	128 x 142	10965	2	16,9:1	159	216	713, 735, 760, 818, 854, 871, 905, 924, 925, 926, 992
OM 421.906	D	(AN)	6	128 x 142	10965	2	16,9:1	159	216	713, 735, 992
OM 421.907	D	(AN)	6	128 x 142	10965	2	16,9:1	159	216	854, 992
OM 421.908	D	(AN)	6	128 x 142	10965	2	16,9:1	159	216	498, 499
OM 421.909	D	(AN)	6	128 x 142	10965	2	16,9:1	159	216	713, 715, 992
OM 421.910	D	(AN)	6	128 x 142	10965	2	16,9:1	159	216	760, 765, 859, 992
OM 421.951	D	(A)	6	128 x 142	10965	2		184	250	499
OM 422.900/-000	D	(AN)	8	128 x 142	14618	2				992
OM 422.901	D	(LA)	8	128 x 142	14618	2				992
OM 422.901-400	D	(A)	8	128 x 142	14618	2				992
OM 422.901-410	D	(A)	8	128 x 142	14618	2		206	280	992
OM 422.901-500	D	(LA)	8	128 x 142	14618	2				992
OM 422.905	D	(AN)	8	128 x 142	14618	2	16,9:1	206	280	765, 768, 824, 842, 859, 909, 992
OM 422.906	D	(AN)	8	128 x 142	14618	2	16,9:1	206	280	765, 824, 842, 859, 992
OM 422.907	D	(AN)	8	128 x 142	14618	2	16,9:1	206	280	713, 718, 740, 741, 787, 824, 842, 847, 909, 992
OM 422.908	D	(AN)	8	128 x 142	14618	2	16,9:1	206	280	499, 735, 737, 992

M





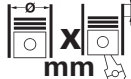

			Cyl	 X mm	cm ³		Comp. Ratio ε	kW	PS	Pos
OM 422.909	D	(AN)	8	128 x 142	14618	2	16,9:1	184	250	713, 715, 718, 735, 737, 740, 741, 760, 762, 818, 821, 839, 857, 873, 928, 992
OM 422.910	D	(AN)	8	128 x 142	14618	2	16,9:1	206	280	842, 992
OM 422.911	D	(AN)	8	128 x 142	14618	2	16,9:1	206	280	762, 765, 824, 842, 854, 857, 859, 873, 876, 891, 909, 926, 929, 937, 949, 956, 992
OM 422.912	D	(AN)	8	128 x 142	14618	2	16,9:1	184	250	762, 857, 873, 928, 992
OM 422.913	D	(AN)	8	128 x 142	14618	2	16,9:1	206	280	713, 715, 718, 735, 737, 740, 741, 743, 762, 765, 824, 842, 854, 857, 859, 873, 876, 891, 909, 926, 929, 937, 949, 956, 992
OM 422.914	D	(AN)	8	128 x 142	14618	2	16,9:1	206	280	949, 992
OM 422.915	D	(AN)	8	128 x 142	14618	2	16,9:1	184	250	762, 992
OM 422.916	D	(AN)	8	128 x 142	14618	2	16,9:1	206	280	765, 787, 824, 825, 842, 859, 863, 876, 877, 891, 915, 932, 942, 949, 952, 992
OM 422.917	D	(AN)	8	128 x 142	14618	2	16,9:1	206	280	499
OM 422.918	D	(AN)	8	128 x 142	14618	2	16,9:1	206	280	765, 992
OM 422.919	D	(AN)	8	128 x 142	14618	2	16,9:1	206	280	929, 937, 949, 956, 992
OM 422.920	D	(AN)	8	128 x 142	14618	2	16,9:1	184	250	928, 992
OM 422.921	D	(AN)	8	128 x 142	14618	2	16,9:1	206	280	929, 937, 949, 992
OM 422.922	D	(AN)	8	128 x 142	14618	2	16,9:1	206	280	909, 992
OM 422.923	D	(AN)	8	128 x 142	14618	2	16,9:1	184	250	715, 735, 737, 857, 992
OM 422.951	D	(A)	8	128 x 142	14618	2		243	330	499
OM 422.952	D	(A)	8	128 x 142	14618	2		243	330	769, 828, 845, 862, 913, 992
OM 422.953	D	(LA)	8	128 x 142	14618	2		276	375	773, 832, 865, 918, 992
OM 422.954	D	(A)	8	128 x 142	14618	2		243	330	769, 828, 845, 862, 878, 913, 927, 931, 951, 992
OM 422.955	D	(LA)	8	128 x 142	14618	2		276	375	773, 832, 865, 918, 954, 992
OM 422.956	D	(A)	8	128 x 142	14618	2		243	330	769, 828, 845, 862, 913, 992
OM 422.957	D	(A)	8	128 x 142	14618	2	16,25:1	243	330	769, 828, 845, 862, 878, 951, 968, 992
OM 422.958	D	(A)	8	128 x 142	14618	2	16,25:1	243	330	769, 828, 845, 862, 992
OM 422.959	D	(LA)	8	128 x 142	14618	2	16,25:1	276	375	773, 832, 865, 882, 934, 992
OM 422.963	D	(A)	8	128 x 142	14618	2	16,25:1	243	330	499
OM 423.900/-000	D	(AN)	10	128 x 142	18273	2				992
OM 423.901	D	(A)	10	128 x 142	18273	2		346	470	992
OM 423.905	D	(AN)	10	128 x 142	18273	2	16,9:1	261	355	765, 768, 772, 831, 847, 859, 864, 880, 916, 942, 953, 992
OM 423.906	D	(AN)	10	128 x 142	18273	2	16,9:1	261	355	831, 847, 864, 916, 953, 960, 966, 976, 981, 992
OM 423.907	D	(AN)	10	128 x 142	18273	2	16,9:1	261	355	831, 842, 846, 847, 881, 897, 916, 933, 953, 960, 966, 970, 976, 981, 990, 991, 992
OM 423.908	D	(AN)	10	128 x 142	18273	2	16,9:1	261	355	765, 769, 772, 831, 847, 859, 862, 864, 876, 909, 926, 929, 937, 949, 956, 992
OM 423.950	D	(LA)	10	128 x 142	18273	2	16,25:1	368	500	774, 775, 883, 947, 967, 971, 973, 984, 992
OM 424.901	D	(LA)	12	128 x 142	21930	2		441	600	992
OM 427.900/-000	D	(AN)	6	128 x 155	11970	2				992
OM 427.902-500	D	(LA)	6	128 x 155	11970	2				992
OM 427.902/-400	D	(A)	6	128 x 155	11970	2				992
OM 427.905	D	(AN)	6	128 x 155	11970	2	16,6:1	150	204	524
OM 427.910	D	(AN)	6	128 x 155	11970	2	16,6:1	177	240	524
OM 427.911	D	(AN)	6	128 x 155	11970	2	16,6:1	177	240	524
OM 427.950	D	(A)	6	128 x 155	11970	2	16,25:1	206	280	524
OM 427.951	D	(A)	6	128 x 155	11970	2	16,25:1	206	280	524



			Cyl		cm ³		Comp. Ratio ε	kW	PS	Pos
OM 427.952	D	(A)	6	128 x 155	11970	2	16,25:1	206	280	524
OM 429.951 (USA)	D	(A)	5	128 x 155	9973	2	17,25:1	175	238	752, 992
OM 429.953 (USA)	D	(A)	5	128 x 155	9973	2	17,25:1	186	250	752, 992
OM 429.955 (USA)	D	(LA)	5	128 x 155	9973	2	17,25:1	186	253	752, 992
OM 440.907	D	(AN)	8	130 x 142	15080	2	18:1	195	265	764, 803, 992
OM 440.909	D	(AN)	8	130 x 142	15080	2	16,9:1	195	265	784, 992
OM 440.910	D	(AN)	8	130 x 142	15080	2	16,9:1	195	265	992
OM 440.911	D	(AN)	8	130 x 142	15080	2	16,9:1	195	265	992
OM 440.940	D	(A)	8	128 x 142	14618	2	18:1	250	340	790, 830, 880, 915, 992
OM 440.941	D	(A)	8	128 x 142	14618	2	18:1	250	340	830, 915, 992
OM 440.942	D	(A)	8	128 x 142	14618	2	18:1	250	340	830, 915, 992
OM 440.945	D	(A)	8	128 x 142	14618	2	18:1	250	340	770, 805, 992
OM 440.948	D	(A)	8	128 x 142	14618	2	18:1	269	366	992
OM 440.970	D	(LA)	8	128 x 142	14618	2	16,75:1	320	435	811, 849, 901, 919, 945, 962, 992
OM 440.971	D	(LA)	8	128 x 142	14618	2	16,75:1	370	503	792, 903, 922, 947, 964, 984, 992
OM 440.972	D	(LA)	8	128 x 142	14618	2	16,75:1	320	435	901, 992
OM 440.973	D	(LA)	8	128 x 142	14618	2	16,75:1	370	503	812, 903, 915, 921, 922, 992
OM 440.975	D	(LA)	8	128 x 142	14618	2	16,75:1	370	503	922, 945, 961, 962, 964, 973, 983, 985, 992
OM 440.976	D	(LA)	8	128 x 142	14618	2	16,75:1	370	503	850, 935, 936, 964, 965, 992
OM 440.978	D	(LA)	8	128 x 142	14618	2		320	435	808, 811, 848, 898, 901, 918, 919, 945, 974, 992
OM 440.979	D	(LA)	8	128 x 142	14618	2		320	435	808, 811, 813, 843, 848, 849, 898, 901, 918, 923, 961, 962, 983, 985, 992
OM 440.980	D	(LA)	8	128 x 142	14618	2		320	435	901, 943, 945, 961, 992
OM 440.981	D	(LA)	8	128 x 142	14618	2		370	503	901, 918, 919, 923, 945, 974, 992
OM 440.982	D	(LA)	8	128 x 142	14618	2		370	503	808, 811, 813, 898, 901, 919, 922, 923, 961, 962, 983, 985, 992
OM 440.983	D	(LA)	8	128 x 142	14618	2		370	503	961, 962, 964, 965, 982, 992
OM 440.984	D	(LA)	8	128 x 142	14618	2		320	435	961, 962, 983, 985, 992
OM 440.985	D	(LA)	8	128 x 142	14618	2		320	435	961, 962, 983, 984, 985, 988, 992
OM 440.986	D	(LA)	8	128 x 142	14618	2		320	435	898, 992
OM 440.987	D	(LA)	8	128 x 142	14618	2	16,75:1	280	381	961, 962, 964, 992
OM 440.988	D	(LA)	8	128 x 142	14618	2	16,75:1	280	381	961, 988, 992
OM 440.989	D	(LA)	8	128 x 142	14618	2	16,75:1	280	381	808, 848, 918, 992
OM 440.990	D	(LA)	8	128 x 142	14618	2	16,75:1	280	381	848, 918, 992
OM 440.991	D	(LA)	8	128 x 142	14618	2		320	435	808, 992
OM 441.901	D	(A)	6	128 x 142	10965	2		250	340	781, 992
OM 441.901-400	D	(A)	6	128 x 142	10965	2				992
OM 441.901-500	D	(LA)	6	128 x 142	10965	2				992
OM 441.901-504	D	(LA)	6	128 x 142	10965	2				992
OM 441.901-505	D	(LA)	6	128 x 142	10965	2				992
OM 441.901-507	D	(LA)	6	128 x 142	10965	2				992
OM 441.901-520	D	(LA)	6	128 x 142	10965	2				992
OM 441.901-530	D	(LA)	6	128 x 142	10965	2		250	340	992
OM 441.905	D	(AN)	6	130 x 142	11309	2	16,9:1	165	224	713, 735, 760, 781, 818, 871, 992
OM 441.906	D	(AN)	6	130 x 142	11309	2	16,9:1	150	204	760, 857, 992
OM 441.907	D	(AN)	6	130 x 142	11309	2	16,9:1	150	204	760, 992
OM 441.908	D	(AN)	6	130 x 142	11309	2	16,9:1	165	224	499, 800
OM 441.909	D	(AN)	6	130 x 142	11309	2	16,9:1	165	224	499, 800
OM 441.911	D	(AN)	6	130 x 142	11309	2	16,9:1	165	224	499
OM 441.912	D	(AN)	6	130 x 142	11309	2	16,9:1	165	224	871, 992
OM 441.913	D	(AN)	6	130 x 142	11309	2	16,9:1	165	224	713, 735, 781, 992
OM 441.914	D	(AN)	6	130 x 142	11309	2	16,9:1	165	224	713, 760, 781, 818, 854, 871, 992
OM 441.915	D	(AN)	6	130 x 142	11309	2	16,9:1	165	224	713, 992
OM 441.916	D	(AN)	6	130 x 142	11309	2	16,9:1	153	208	781, 992
OM 441.917	D	(AN)	6	130 x 142	11309	2	16,9:1	153	208	713, 760, 992
OM 441.918	D	(AN)	6	130 x 142	11309	2	16,9:1	165	224	499, 992
OM 441.919	D	(AN)	6	130 x 142	11309	2	16,9:1	153	208	760, 854, 992

M

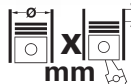

			Cyl	 mm	cm ³		Comp. Ratio ε	kW	PS	Pos
OM 441.920	D	(AN)	6	130 x 142	11309	2	16,9:1	153	208	713, 735, 781, 871, 992
OM 441.921	D	(AN)	6	130 x 142	11309	2	16,9:1	165	224	523
OM 441.922	D	(AN)	6	130 x 142	11309	2	18:1	151	205	523
OM 441.923	D	(AN)	6	130 x 142	11309	2	16,9:1	160	218	713, 735, 781, 789, 818, 871, 888, 992
OM 441.924	D	(AN)	6	130 x 142	11309	2	16,9:1	160	218	871, 992
OM 441.925	D	(AN)	6	130 x 142	11309	2	16,9:1	160	218	713, 992
OM 441.926	D	(AN)	6	130 x 142	11309	2	16,9:1	160	218	713, 781, 818, 992
OM 441.927	D	(AN)	6	130 x 142	11309	2	16,9:1	160	218	713, 714, 992
OM 441.932	D	(AN)	6	130 x 142	11309	2	18:1	151	205	781, 818, 992
OM 441.933	D	(AN)	6	130 x 142	11309	2	18:1	151	205	781, 992
OM 441.950	D	(A)	6	128 x 142	10965	2		200	272	499
OM 441.951	D	(LA)	6	128 x 142	10965	2		250	340	765, 769, 789, 842, 859, 862, 864, 876, 878, 929, 937, 942, 992
OM 441.953	D	(A)	6	128 x 142	10965	2		200	272	499
OM 441.960	D	(LA)	6	128 x 142	10965	2		250	340	784, 788, 789, 805, 874, 878, 895, 937, 940, 943, 992
OM 441.961	D	(LA)	6	128 x 142	10965	2		250	340	760, 789, 854, 857, 859, 878, 992
OM 441.962	D	(LA)	6	128 x 142	10965	2		250	340	789, 878, 992
OM 441.980	D	(LA)	6	128 x 142	10965	2	16,25:1	250	340	494, 522, 523
OM 441.981	D	(LA)	6	128 x 142	10965	2		250	340	789, 878, 941, 958, 992
OM 441.982	D	(LA)	6	128 x 142	10965	2		250	340	940, 992
OM 441.983	D	(LA)	6	128 x 142	10965	2		250	340	789, 878, 992
OM 441.985	D	(LA)	6	128 x 142	10965	2		250	340	940, 941, 992
OM 441.986	D	(LA)	6	128 x 142	10965	2	16,25:1	250	340	716, 764, 804, 805, 879, 889, 895, 914, 992
OM 441.987	D	(LA)	6	128 x 142	10965	2	16,25:1	250	340	805, 895, 992
OM 441.988	D	(LA)	6	128 x 142	10965	2	16,25:1	250	340	940, 941, 958, 992
OM 441.989	D	(LA)	6	128 x 142	10965	2	16,25:1	250	340	716, 720, 805, 879, 895, 914, 992
OM 441.990	D	(LA)	6	128 x 142	10965	2		250	340	940, 941, 992
OM 441.991	D	(LA)	6	128 x 142	10965	2	16,25:1	250	340	789, 878, 992
OM 441.992	D	(LA)	6	128 x 142	10965	2	16,25:1	250	340	940, 941, 992
OM 441.993	D	(LA)	6	128 x 142	10965	2	16,25:1	250	340	720, 804, 805, 992
OM 441.994	D	(LA)	6	128 x 142	10965	2	16,25:1	250	340	499, 500, 516
OM 441.995	D	(LA)	6	128 x 142	10965	2	16,25:1	250	340	499, 500, 516
OM 441.996	D	(LA)	6	128 x 142	10965	2	16,25:1	250	340	805, 992
OM 441.997	D	(LA)	6	128 x 142	10965	2	16,25:1	230	313	804, 843, 911, 992
OM 441.998	D	(LA)	6	128 x 142	10965	2	16,25:1	230	313	843, 992
OM 441.999	D	(LA)	6	128 x 142	10965	2	16,25:1	250	340	805, 992
OM 442.900-004	D	(AN)	8	130 x 142	15080	2				992
OM 442.900/-000	D	(AN)	8	130 x 142	15080	2				992
OM 442.901-404	D	(A)	8	128 x 142	14618	2				992
OM 442.901-500	D	(LA)	8	128 x 142	14618	2				992
OM 442.901-501	D	(LA)	8	128 x 142	14618	2				992
OM 442.901-502	D	(LA)	8	128 x 142	14618	2				992
OM 442.901-504	D	(LA)	8	128 x 142	14618	2				992
OM 442.901-505	D	(LA)	8	128 x 142	14618	2				992
OM 442.901-506	D	(LA)	8	128 x 142	14618	2				992
OM 442.901-507	D	(LA)	8	128 x 142	14618	2				992
OM 442.901-508	D	(LA)	8	128 x 142	14618	2				992
OM 442.901-520	D	(LA)	8	128 x 142	14618	2				992
OM 442.901/-400	D	(LA)	8	128 x 142	14618	2				992
OM 442.905	D	(AN)	8	130 x 142	15080	2	16,9:1	191	260	762, 857, 949, 956, 959, 992
OM 442.906	D	(AN)	8	130 x 142	15080	2	16,9:1	218	296	784, 787, 790, 825, 877, 892, 910, 992
OM 442.907	D	(AN)	8	130 x 142	15080	2	16,9:1	218	296	715, 716, 717, 718, 740, 741, 743, 766, 784, 787, 825, 860, 877, 910, 957, 992
OM 442.908	D	(AN)	8	130 x 142	15080	2	16,9:1	210	286	762, 765, 787, 824, 825, 857, 877, 909, 992
OM 442.909	D	(AN)	8	130 x 142	15080	2	16,9:1	210	286	762, 765, 825, 857, 859, 874, 915, 959, 992
OM 442.910	D	(AN)	8	130 x 142	15080	2	16,9:1	218	296	499





M



			Cyl		mm	cm ³	Comp. Ratio	€	kW	PS	Pos
OM 442.911	D	(AN)	8	130 x 142	15080	2	16,9:1		218	296	499
OM 442.914	D	(AN)	8	130 x 142	15080	2	16,9:1		195	265	717, 738, 784, 871, 874, 875, 890, 992
OM 442.915	D	(AN)	8	130 x 142	15080	2	16,9:1		218	296	938, 957, 992
OM 442.916	D	(AN)	8	130 x 142	15080	2	16,9:1		218	296	938, 992
OM 442.917	D	(AN)	8	130 x 142	15080	2	16,9:1		218	296	910, 992
OM 442.918	D	(AN)	8	130 x 142	15080	2	16,9:1		218	296	499
OM 442.919	D	(AN)	8	130 x 142	15080	2	16,9:1		218	296	499
OM 442.920	D	(AN)	8	130 x 142	15080	2	16,9:1		195	265	716, 717, 992
OM 442.921	D	(AN)	8	130 x 142	15080	2	16,9:1		195	265	874, 992
OM 442.922	D	(AN)	8	130 x 142	15080	2	16,9:1		195	265	784, 787, 822, 874, 877, 992
OM 442.923	D	(AN)	8	130 x 142	15080	2	16,9:1		206	280	784, 786, 787, 825, 874, 877, 938, 992
OM 442.924	D	(AN)	8	130 x 142	15080	2	16,9:1		210	286	825, 892, 992
OM 442.925	D	(AN)	8	130 x 142	15080	2	16,9:1		213	290	786, 787, 825, 877, 910, 992
OM 442.926	D	(AN)	8	130 x 142	15080	2	16,9:1		213	290	716, 717, 741, 764, 787, 825, 910, 992
OM 442.927	D	(AN)	8	130 x 142	15080	2	16,9:1		213	290	938, 992
OM 442.928	D	(AN)	8	130 x 142	15080	2	16,9:1		213	290	938, 992
OM 442.929	D	(AN)	8	130 x 142	15080	2	16,9:1		213	290	892, 910, 992
OM 442.930	D	(AN)	8	130 x 142	15080	2	16,9:1		213	290	523
OM 442.931	D	(AN)	8	130 x 142	15080	2	18:1		195	265	523
OM 442.932	D	(AN)	8	130 x 142	15080	2	16,9:1		195	265	717, 738, 784, 874, 890, 992
OM 442.933	D	(AN)	8	130 x 142	15080	2	16,9:1		195	265	716, 717, 741, 992
OM 442.934	D	(AN)	8	130 x 142	15080	2	16,9:1		195	265	874, 992
OM 442.935	D	(AN)	8	130 x 142	15080	2	16,9:1		195	265	784, 992
OM 442.939	D	(AN)	8	130 x 142	15080	2	16,9:1		213	290	499, 515
OM 442.941	D	(A)	8	128 x 142	14618	2			269	366	880, 992
OM 442.942	D	(A)	8	128 x 142	14618	2			269	366	790, 830, 910, 915, 922, 959, 979, 980, 987, 992
OM 442.943	D	(A)	8	128 x 142	14618	2			269	366	830, 880, 992
OM 442.944	D	(A)	8	128 x 142	14618	2			269	366	790, 830, 880, 915, 942, 959, 975, 992
OM 442.945	D	(A)	8	128 x 142	14618	2			269	366	942, 959, 963, 975, 992
OM 442.946	D	(A)	8	128 x 142	14618	2			269	366	959, 992
OM 442.950	D	(A)	8	128 x 142	14618	2			260-269	354-366	771, 830, 831, 846, 847, 863, 864, 881, 897, 909, 915, 916, 918, 929, 933, 937, 942, 943, 949, 952, 953, 954, 956, 959, 960, 975, 976, 979, 990, 991, 992
OM 442.951	D	(LA)	8	128 x 142	14618	2			320	435	774, 834, 866, 883, 919, 955, 962, 972, 983, 992
OM 442.952	D	(A)	8	128 x 142	14618	2			269	366	771, 824, 830, 831, 846, 863, 864, 876, 880, 881, 891, 896, 897, 909, 915, 916, 929, 932, 933, 937, 942, 949, 952, 953, 956, 959, 960, 966, 969, 975, 976, 978, 979, 986, 990, 991, 992
OM 442.953	D	(LA)	8	128 x 142	14618	2			329	447	721, 774, 834, 835, 866, 883, 919, 920, 955, 962, 972, 979, 983, 992
OM 442.954	D	(A)	8	128 x 142	14618	2			269	366	499
OM 442.955	D	(A)	8	128 x 142	14618	2			269	366	499, 515
OM 442.957	D	(A)	8	128 x 142	14618	2			269	366	959, 992
OM 442.958	D	(A)	8	128 x 142	14618	2	16,25:1		269	366	846, 992
OM 442.959	D	(A)	8	128 x 142	14618	2			269	366	831, 910, 915, 942, 957, 959, 979, 980, 992
OM 442.960	D	(A)	8	128 x 142	14618	2			269	366	499, 953
OM 442.961	D	(A)	8	128 x 142	14618	2			269	366	499, 515



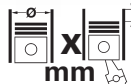

M



			Cyl	 mm	cm ³		Comp. Ratio ε	kW	PS	Pos
OM 442.962	D	(A)	8	128 x 142	14618	2		269	366	824, 830, 831, 835, 842, 846, 847, 859, 864, 876, 880, 881, 891, 896, 897, 909, 915, 949, 952, 953, 956, 959, 960, 975, 976, 977, 979, 981, 992
OM 442.963	D	(A)	8	128 x 142	14618	2		269	366	771, 790, 830, 880, 992
OM 442.964	D	(A)	8	128 x 142	14618	2		269	366	790, 830, 880, 915, 992
OM 442.965	D	(A)	8	128 x 142	14618	2		269	366	880, 992
OM 442.966	D	(A)	8	128 x 142	14618	2		269	366	790, 825, 830, 835, 899, 910, 915, 942, 959, 975, 979, 980, 987, 992
OM 442.967	D	(A)	8	128 x 142	14618	2	16,25:1	269	366	846, 992
OM 442.968	D	(A)	8	128 x 142	14618	2		269	366	880, 992
OM 442.969-502 (USA)	D	(LA)	8	128 x 142	14618	2	16,25:1	261	350	484, 992
OM 442.969-503 (USA)	D	(LA)	8	128 x 142	14618	2	16,25:1	298	400	484, 992
OM 442.969-504 (USA)	D	(LA)	8	128 x 142	14618	2	16,25:1	261	350	484, 992
OM 442.971	D	(A)	8	128 x 142	14618	2		269	366	790, 825, 830, 835, 892, 915, 942, 992
OM 442.972	D	(A)	8	128 x 142	14618	2		269	366	830, 915, 992
OM 442.976	D	(A)	8	128 x 142	14618	2		269	366	790, 830, 880, 992
OM 442.977	D	(A)	8	128 x 142	14618	2	18:1	250	340	830, 992
OM 442.978	D	(A)	8	128 x 142	14618	2	18:1	250	340	830, 915, 992
OM 442.980	D	(LA)	8	128 x 142	14618	2		320	435	774, 834, 866, 883, 919, 962, 992
OM 442.982	D	(LA)	8	128 x 142	14618	2		329	447	774, 992
OM 442.983	D	(LA)	8	128 x 142	14618	2		329	447	919, 992
OM 442.985	D	(LA)	8	128 x 142	14618	2		362	492	791, 812, 836, 885, 903, 921, 922, 946, 947, 963, 989, 992
OM 442.989	D	(LA)	8	128 x 142	14618	2		362	492	791, 792, 812, 836, 850, 885, 903, 921, 922, 935, 944, 947, 959, 964, 992
OM 442.992	D	(LA)	8	128 x 142	14618	2		362	492	791, 836, 885, 921
OM 442.993	D	(LA)	8	128 x 142	14618	2		362	492	964, 992
OM 442.994	D	(LA)	8	128 x 142	14618	2		362	492	921, 922, 992
OM 442.995	D	(LA)	8	128 x 142	14618	2	16,75:1	320	435	523
OM 442.996	D	(LA)	8	128 x 142	14618	2	16,75:1	370	503	523
OM 442.997	D	(LA)	8	128 x 142	14618	2	16,75:1	370	503	812, 836, 849, 850, 901, 903, 921, 922, 935, 945, 964, 984, 992
OM 442.998	D	(LA)	8	128 x 142	14618	2	16,75:1	370	503	885, 903, 992
OM 442.999	D	(LA)	8	128 x 142	14618	2	16,75:1	370	503	964, 992
OM 443.900/-000	D	(AN)	10	130 x 142	18848	2				992
OM 443.905	D	(AN)	10	130 x 142	18848	2	16,9:1	271	369	771, 772, 831, 992
OM 443.980	D	(LA)	10	128 x 142	18273	2		412	560	916, 920, 933, 947, 953, 960, 976, 990, 991, 992
OM 445.920	D	(LA)	6	128 x 142	10965	2	17,25:1	250	340	805, 895, 914, 992
OM 445.921	D	(LA)	6	128 x 142	10965	2	17,25:1	250	340	805, 895, 992
OM 445.922	D	(LA)	6	128 x 142	10965	2	17,25:1	250	340	940, 941, 958, 992
OM 445.923	D	(LA)	6	128 x 142	10965	2	17,25:1	250	340	720, 992
OM 445.924	D	(LA)	6	128 x 142	10965	2	17,25:1	180	245	736, 746, 761, 800, 838, 889, 992
OM 445.925	D	(LA)	6	128 x 142	10965	2	17,25:1	180	245	800, 838, 992
OM 445.926	D	(LA)	6	128 x 142	10965	2	17,25:1	200	272	736, 739, 802, 869, 890, 992
OM 445.927	D	(LA)	6	128 x 142	10965	2	17,25:1	200	272	890, 992
OM 445.929	D	(LA)	6	128 x 142	10965	2	17,25:1	230	313	804, 843, 894, 911, 992
OM 445.930	D	(LA)	6	128 x 142	10965	2	17,25:1	230	313	800, 804, 843, 893, 911, 992
OM 445.931	D	(LA)	6	128 x 142	10965	2	17,25:1	230	313	911, 992
OM 445.933	D	(LA)	6	128 x 142	10965	2	17,25:1	200	272	717, 720, 800, 802, 841, 992
OM 445.934	D	(LA)	6	128 x 142	10965	2	17,25:1	250	340	494, 522, 523, 764, 770, 803, 805
OM 445.935	D	(LA)	6	128 x 142	10965	2	17,25:1	213	290	523, 764, 803
OM 445.936	D	(LA)	6	128 x 142	10965	2	17,25:1	200	272	739, 802, 890, 992
OM 445.937	D	(LA)	6	128 x 142	10965	2	17,25:1	230	313	804, 992
OM 445.938	D	(LA)	6	128 x 142	10965	2	17,25:1	180	245	736, 800, 992
OM 445.939	D	(LA)	6	128 x 142	10965	2	17,25:1	250	340	789, 805, 895, 992



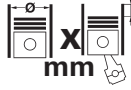

M



			Cyl	 mm	cm ³		Comp. Ratio ε	kW	PS	Pos
OM 445.940	D	(LA)	6	128 x 142	10965	2	17,25:1	200	272	890, 893, 895, 992
OM 445.941	D	(LA)	6	128 x 142	10965	2	17,25:1	180	245	800, 889, 992
OM 446.920	D	(LA)	8	128 x 142	14618	2	17,25:1	390	530	808, 811, 812, 813, 850, 851, 883, 898, 901, 903, 904, 918, 922, 923, 943, 948, 962, 965, 983, 985, 992
OM 446.922	D	(LA)	8	128 x 142	14618	2	17,25:1	320	435	811, 849, 901, 919, 945, 992
OM 446.923	D	(LA)	8	128 x 142	14618	2	17,25:1	320	435	992
OM 446.924	D	(LA)	8	128 x 142	14618	2	17,25:1	280	381	808, 848, 898, 918, 943, 992
OM 446.925	D	(LA)	8	128 x 142	14618	2	17,25:1	280	381	808, 848, 898, 918, 992
OM 446.926	D	(LA)	8	128 x 142	14618	2	17,25:1	280	381	918, 943, 961, 992
OM 446.927	D	(LA)	8	128 x 142	14618	2	17,25:1	280	381	808, 848, 849, 904, 918, 992
OM 446.928	D	(LA)	8	128 x 142	14618	2	17,25:1	280	381	898, 992
OM 446.929	D	(LA)	8	128 x 142	14618	2	17,25:1	280	381	898, 992
OM 446.930	D	(LA)	8	128 x 142	14618	2	17,25:1	280	381	961, 992
OM 446.931	D	(LA)	8	128 x 142	14618	2	17,25:1	280	381	961, 992
OM 446.932	D	(LA)	8	128 x 142	14618	2	17,25:1	390	530	935, 963, 964, 965, 992
OM 446.933	D	(LA)	8	128 x 142	14618	2	17,25:1	390	530	910, 923, 935
OM 446.934	D	(LA)	8	128 x 142	14618	2	17,25:1	280	381	523, 992
OM 446.935	D	(LA)	8	128 x 142	14618	2	17,25:1	320	435	808, 848, 898, 918, 992
OM 446.936	D	(LA)	8	128 x 142	14618	2	17,25:1	320	435	808, 811, 813, 848, 849, 898, 918, 919, 923, 992
OM 446.938	D	(LA)	8	128 x 142	14618	2	17,25:1	280	381	494, 522, 523
OM 446.939	D	(LA)	8	128 x 142	14618	2	17,25:1	320	435	943, 948, 961, 962, 965, 982, 992
OM 446.940	D	(LA)	8	128 x 142	14618	2	17,25:1	320	435	961, 985, 992
OM 446.941	D	(LA)	8	128 x 142	14618	2	17,25:1	320	435	961, 992
OM 446.942	D	(LA)	8	128 x 142	14618	2	17,25:1	320	435	898, 992
OM 446.943	D	(LA)	8	128 x 142	14618	2	17,25:1	320	435	808, 992
OM 446.945	D	(LA)	8	128 x 142	14618	2	17,25:1	390	530	904, 923, 948, 962, 965, 992
OM 446.946	D	(LA)	8	128 x 142	14618	2	17,25:1	390	530	806, 808, 811, 901, 919, 923, 992
OM 446.948	D	(LA)	8	128 x 142	14618	2	17,25:1	320	435	898, 992
OM 447.900/-000	D	(AN)	6	128 x 155	11970	2				992
OM 447.902	D	(LA)	6	128 x 155	11970	2				992
OM 447.902-400	D	(A)	6	128 x 155	11970	2				992
OM 447.902-500	D	(LA)	6	128 x 155	11970	2				992
OM 447.902-501	D	(LA)	6	128 x 155	11970	2				992
OM 447.902-520	D	(LA)	6	128 x 155	11970	2				992
OM 447.902-521	D	(LA)	6	128 x 155	11970	2				992
OM 447.903	D	(A)	6	128 x 155	11970	2		184	250	530, 992
OM 447.905	D	(AN)	6	128 x 155	11970	2	16,5:1	150	204	524
OM 447.906	D	(AN)	6	128 x 155	11970	2	16,5:1	177	240	524, 526
OM 447.907	D	(AN)	6	128 x 155	11970	2	16,5:1	177	240	524
OM 447.908	D	(AN)	6	128 x 155	11970	2	16,5:1	177	240	524, 526, 527
OM 447.910	D	(AN)	6	128 x 155	11970	2	16,6:1	177	240	524
OM 447.911	D	(AN)	6	128 x 155	11970	2	16,6:1	150	204	524
OM 447.912	D	(AN)	6	128 x 155	11970	2	16,6:1	184	250	527
OM 447.913	D	(AN)	6	128 x 155	11970	2	18:1	157	213	524
OM 447.914	D	(AN)	6	128 x 155	11970	2	18:1	157	213	524
OM 447.915	A	(AN)	6	128 x 155	11970	2	18:1	185	252	527
OM 447.916	A	(AN)	6	128 x 155	11970	2	18:1	185	252	524
OM 447.925	G	(AN)	6	128 x 155	11970	2	18:1	150	204	524
OM 447.950	D	(A)	6	128 x 155	11970	2	16,25:1	206	280	524
OM 447.951	D	(A)	6	128 x 155	11970	2	16,25:1	206	280	524
OM 447.952	D	(A)	6	128 x 155	11970	2	16,25:1	206	280	992
OM 447.953	D	(A)	6	128 x 155	11970	2	16,25:1	206	280	992
OM 447.954	D	(A)	6	128 x 155	11970	2	18:1	184	250	526
OM 447.955	D	(A)	6	128 x 155	11970	2	18:1	184	250	524
OM 447.956	D	(A)	6	128 x 155	11970	2	18:1	184	250	524
OM 447.957	D	(A)	6	128 x 155	11970	2	18:1	184	250	524
OM 447.958	D	(A)	6	128 x 155	11970	2	18:1	184	250	527
OM 447.959	D	(A)	6	128 x 155	11970	2	18:1	184	250	524
OM 447.968	D	(LA)	6	128 x 155	11970	2		235	320	524

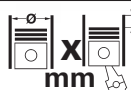

M



			Cyl	 X mm	cm ³		Comp. Ratio ε	kW	PS	Pos
OM 447.969-501 (USA)	D	(LA)	6	128 x 155	11970	2		261	350	484, 992
OM 447.969-502 (USA)	D	(LA)	6	128 x 155	11970	2		224	300	484, 992
OM 447.969-503 (USA)	D	(LA)	6	128 x 155	11970	2		261	350	484, 992
OM 447.970	D	(LA)	6	128 x 155	11970	2	18:1	157	213	524
OM 447.971	D	(LA)	6	128 x 155	11970	2	18:1	184	250	524
OM 447.972	D	(LA)	6	128 x 155	11970	2	18:1	220	300	524
OM 447.973	D	(LA)	6	128 x 155	11970	2	18:1	157	213	524
OM 447.974	D	(LA)	6	128 x 155	11970	2	18:1	184	250	524
OM 447.975	D	(LA)	6	128 x 155	11970	2	18:1	220	300	524
OM 447.976	D	(LA)	6	128 x 155	11970	2	18:1	184	250	524
OM 447.977	D	(LA)	6	128 x 155	11970	2	18:1	220	300	524
OM 447.978	D	(LA)	6	128 x 155	11970	2	18:1	184	250	524
OM 447.979	D	(LA)	6	128 x 155	11970	2	18:1	220	300	524
OM 447.980	D	(LA)	6	128 x 155	11970	2	18:1	220	300	524
OM 447.981	D	(LA)	6	128 x 155	11970	2	18:1	220	300	524
OM 447.982	D	(LA)	6	128 x 155	11970	2	18:1	220	300	992
OM 447.983	D	(LA)	6	128 x 155	11970	2	18:1	220	300	992
OM 447.984	D	(LA)	6	128 x 155	11970	2	18:1	220	300	524
OM 447.985	D	(LA)	6	128 x 155	11970	2	18:1	220	300	526
OM 447.986	D	(LA)	6	128 x 155	11970	2	18:1	220	300	524
OM 447.987	D	(LA)	6	128 x 155	11970	2	18:1	220	300	527
OM 447.988	D	(LA)	6	128 x 155	11970	2	18:1	220	300	992
OM 447.990	D	(LA)	6	128 x 155	11970	2	18:1	184	250	526
OM 447.991	D	(LA)	6	128 x 155	11970	2	18:1	220	300	526
OM 447.992	D	(LA)	6	128 x 155	11970	2	18:1	184	250	527
OM 447.993	D	(LA)	6	128 x 155	11970	2	18:1	220	300	527
OM 447.994	D	(LA)	6	128 x 155	11970	2	18:1	220	300	992
OM 447.995	D	(A)	6	128 x 155	11970	2	18:1	184	250	524
OM 447.996	D	(LA)	6	128 x 155	11970	2	18:1	184	250	524, 527
OM 447.998	D	(LA)	6	128 x 155	11970	2	18:1	220	300	524
OM 447.999	D	(LA)	6	128 x 155	11970	2	18:1	220	300	524
OM 457.933	D	(LA)	6	128 x 155	11970	4	17,25:1	260	354	476
OM 457.934	D	(LA)	6	128 x 155	11970	4	17,25:1	220	300	476
OM 457.935	D	(LA)	6	128 x 155	11970	4	17,25:1	185	252	476
OM 457.936	D	(LA)	6	128 x 155	11970	4	17,25:1	300	408	478, 992
OM 457.937	D	(LA)	6	128 x 155	11970	4	17,25:1	260	354	467, 468, 469, 472, 473, 474, 992
OM 457.938	D	(LA)	6	128 x 155	11970	4	17,25:1	300	408	478, 496
OM 457.940	D	(LA)	6	128 x 155	11970	4	17,25:1	260	354	478
OM 457.941	D	(LA)	6	128 x 155	11970	4	17,25:1	185-300	252-408	496, 528
OM 457.942	D	(LA)	6	128 x 155	11970	4	17,25:1	185-260	252-354	476, 480, 517, 801
OM 457.943	D	(LA)	6	128 x 155	11970	4	17,25:1	195	252	476
OM 457.944	D	(LA)	6	128 x 155	11970	4	17,25:1	260-310	354-421	477, 494, 495, 496, 522, 528, 529, 807, 810
OM 458.960	D	(LA)	6	128 x 155	11970	4	17,25:1	260	354	992
OM 458.970	D	(LA)	6	128 x 155	11970	4	17,25:1	295	401	992
OM 458.980	D	(LA)	6	128 x 155	11970	4	17,25:1	335	456	992
OM 462.900-010	D	(AN)	8	130 x 142	15080	2	16,9:1	195	265	992
OM 462.900-011 (AFS)	D	(AN)	8	130 x 142	15080	2	16,9:1	195	265	874, 910, 992
OM 462.900-012	D	(AN)	8	130 x 142	15080	2	16,9:1	195-203	265-276	992
OM 462.900-013 (AFS)	D	(AN)	8	130 x 142	15080	2	16,9:1	195	265	874, 992
OM 462.900-410 (AFS)	D	(A)	8	128 x 142	14618	2	16,25	260	354	790, 880, 992
OM 462.900-411 (AFS)	D	(A)	8	128 x 142	14618	2	16,25	269	366	880, 884, 992
OM 462.900-414	D	(A)	8	128 x 142	14618	2	16,25	269	366	992
OM 462.900-510 (AFS)	D	(LA)	8	128 x 142	14618	2	16,25	320	435	883, 992
OM 462.900-511 (AFS)	D	(LA)	8	128 x 142	14618	2	16,25	329	447	883, 902, 919, 992
OM 463.900-010	D	(AN)	10	130 x 142	18848	2	16,9:1	260-271	354-368	992
OM 466.900-005 (AFS)	D	(A)	6	128 x 155	11970	2	16,25	175	238	782, 992
OM 466.900-405	D	(A)	6	128 x 155	11970	2	16,25	175	238	806, 992
OM 466.900-505	D	(A)	6	128 x 155	11970	2	16,25	265	360	806, 992
OM 475.907	D	(LA)	5	128 x 155	9973	2	16,25:1	221	300	992
OM 475.907-505	D	(LA)	5	128 x 155	9973	2	16,25:1	221	300	992
OM 475.907-506	D	(LA)	5	128 x 155	9973	2	16,25:1	221	300	992
OM 475.950 (BRA)	D	(A)	5	128 x 155	9973	2	16,25:1	184	250	762, 992
OM 475.951 (BRA)	D	(A)	5	128 x 155	9973	2	16,25:1	184	250	762, 783, 868, 873, 992
OM 475.952 (BRA)	D	(A)	5	128 x 155	9973	2	16,25:1	184	250	518
OM 475.953 (BRA)	D	(A)	5	128 x 155	9973	2	16,25:1	184	250	520
OM 475.954 (BRA)	D	(A)	5	128 x 155	9973	2	16,25:1	184	250	857, 868, 873, 992
OM 475.974 (AFS/LAM)	D	(LA)	5	128 x 155	9973	2	16,25:1	205	280	765, 992



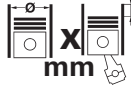

M



			Cyl		mm	cm ³	Comp. Ratio ϵ	kW	PS	Pos
OM 475.976 (AFS/LAM)	D	(LA)	5	128 x 155	9973	2	16,25:1	205	280	762, 765, 992
OM 475.977 (AFS/LAM)	D	(LA)	5	128 x 155	9973	2	16,25:1	205	280	520, 992
OM 475.978 (AFS/LAM)	D	(LA)	5	128 x 155	9973	2	16,25:1	235	320	520, 992
OM 475.979 (AFS/LAM)	D	(LA)	5	128 x 155	9973	2	16,25:1	235	320	768, 992
OM 475.982 (AFS/LAM)	D	(LA)	5	128 x 155	9973	2	16,25:1	221	300	767, 769, 992
OM 475.984 (AFS/LAM)	D	(LA)	5	128 x 155	9973	2	16,25:1	224	305	520
OM 475.985 (AFS/LAM)	D	(LA)	5	128 x 155	9973	2	16,25:1	224	305	767, 992
OM 475.986 (AFS/LAM)	D	(LA)	5	128 x 155	9973	2	16,25:1	184	250	762, 765, 992
OM 475.989 (AFS/LAM)	D	(LA)	5	128 x 155	9973	2	16,25:1	221	300	767, 992
OM 475.991 (AFS/LAM)	D	(LA)	5	128 x 155	9973	2	16,25:1	184	250	520, 992
OM 475.994	D	(LA)	5	128 x 155	9973	2	16,25:1	184	250	762, 765, 992
OM 475.997 (AFS/LAM)	D	(LA)	5	128 x 155	9973	2	16,25:1	224	305	520
OM 475.998 (AFS/LAM)	D	(LA)	5	128 x 155	9973	2	16,25:1	184	250	520
OM 476.916	D	(A)	6	128 x 155	11970	2		246	330	992
OM 476.916-405	D	(A)	6	128 x 155	11970	2		213	290	992
OM 476.916-406	D	(A)	6	128 x 155	11970	2		246	330	992
OM 476.917	D	(A)	6	128 x 155	11970	2		287	390	992
OM 476.917-505	D	(A)	6	128 x 155	11970	2		310	422	992
OM 476.917-506	D	(A)	6	128 x 155	11970	2		287	390	992
OM 476.950 (BRA)	D	(A)	6	128 x 155	11970	2		215	292	825, 992
OM 476.971 (BRA)	D	(LA)	6	128 x 155	11970	2		264	360	770, 992
OM 476.972	D	(LA)	6	128 x 155	11970	2		264	360	520
OM 476.973	D	(LA)	6	128 x 155	11970	2		264	360	830, 992
OM 476.977 (BRA)	D	(LA)	6	128 x 155	11970	2		264	360	519, 520
OM 476.978 (BRA)	D	(LA)	6	128 x 155	11970	2		264	360	771, 772, 992
OM 476.979 (BRA)	D	(LA)	6	128 x 155	11970	2		264	360	830, 832, 992
OM 476.980 (BRA)	D	(LA)	6	128 x 155	11970	2		257	350	830, 832, 992
OM 476.981 (BRA)	D	(LA)	6	128 x 155	11970	2		257	350	518, 519, 520
OM 476.982 (BRA)	D	(LA)	6	128 x 155	11970	2		294	400	833, 835, 992
OM 476.983 (BRA)	D	(LA)	6	128 x 155	11970	2		257	350	830, 915, 992
OM 476.985 (BRA)	D	(LA)	6	128 x 155	11970	2	16,6:1	261	355	520
OM 476.988 (BRA)	D	(LA)	6	128 x 155	11970	2	16,6:1	257	350	771, 772, 992
OM 476.991 (BRA)	D	(LA)	6	128 x 155	11970	2	16,25:1	257	350	771, 992
OM 476.992 (BRA)	D	(LA)	6	128 x 155	11970	2	16,6:1	257	350	520
OM 481.902 (TUR)	D	(AN)	6	128 x 142	10965	2	16,9:1	159	216	818, 854, 905, 992
OM 481.904 (TUR)	D	(AN)	6	128 x 142	10965	2	16,9:1	159	216	498, 992
OM 482.912 (TUR)	D	(AN)	8	128 x 142	14618	2	16,9:1	206	280	824, 909, 992
OM 482.930 (TUR)	D	(AN)	8	128 x 142	14618	2	16,9:1	206	280	498, 499
OM 482.940 (TUR)	D	(A)	8	128 x 142	14618	2	16,25:1	269	366	915, 992
OM 482.941 (TUR)	D	(A)	8	128 x 142	14618	2	16,25:1	269	366	917, 992
OM 485.980 (BRA)	D	(LA)	5	128 x 155	9973	2		221	300	769, 992
OM 492.900-001 (AFS)	D	(AN)	8	128 x 142	14618	2	16,9:1	184	250	857, 992
OM 492.900-002 (AFS)	D	(AN)	8	128 x 142	14618	2	16,9:1	206	280	824, 909, 992
OM 492.900-004 (AFS)	D	(AN)	8	128 x 142	14618	2	16,9:1	206	280	992
OM 492.900-005	D	(AN)	8	128 x 142	14618	2	16,9:1	184	250	992
OM 492.900-007	D	(AN)	8	128 x 142	14618	2	16,9:1	184	250	992
OM 492.900-008	D	(AN)	8	128 x 142	14618	2	16,9:1	206	280	992
OM 492.900-009	D	(AN)	8	128 x 142	14618	2	16,9:1	184	250	992
OM 492.900-010	D	(AN)	8	128 x 142	14618	2	16,9:1	206	280	992
OM 492.900-013	D	(AN)	8	128 x 142	14618	2	16,9:1	206	280	992
OM 492.900-405 (AFS)	D	(A)	8	128 x 142	14618	2	16,25:1	243	330	862, 992
OM 492.900-406 (AFS)	D	(A)	8	128 x 142	14618	2	16,25:1	243	330	913, 992
OM 492.900-409 (AFS)	D	(A)	8	128 x 142	14618	2	16,25:1	236	321	828, 992
OM 492.900-411 (AFS)	D	(A)	8	128 x 142	14618	2	16,25:1	221	300	992
OM 492.900-501 (AFS)	D	(LA)	8	128 x 142	14618	2	16,25:1	276	375	918, 992
OM 493.900-001 (AFS)	D	(AN)	10	128 x 142	18273	2	16,9:1	261	355	916, 992
OM 495.900-001 (AFS)	D	(AN)	5	125 x 150	9204	2	17:1	135	183	733, 852, 992
OM 495.900-002 (AFS)	D	(AN)	5	125 x 150	9204	2	17:1	135	183	733, 757, 992
OM 495.900-003 (AFS)	D	(AN)	5	125 x 150	9204	2	17:1	135	183	852, 992
OM 495.900-009 (AFS)	D	(AN)	5	125 x 150	9204	2	17:1	135	183	733, 852, 992
OM 495.900-010 (AFS)	D	(AN)	5	125 x 150	9204	2	17:1	135	183	733, 852, 992
OM 496.900-001 (AFS)	D	(AN)	6	125 x 155	11412	2	16,5:1	162	220	820, 906, 992
OM 496.900-002 (AFS)	D	(AN)	6	125 x 155	11412	2	16,5:1	162	220	761, 992
OM 496.900-003 (AFS)	D	(AN)	6	125 x 155	11412	2	16,5:1	162	220	906, 992
OM 496.900-023 (AFS)	D	(AN)	6	125 x 155	11412	2	16,5:1	162	220	761, 992
OM 496.900-026 (AFS)	D	(AN)	6	125 x 155	11412	2	16,5:1	162	220	820, 906, 992
OM 496.900-027 (AFS)	D	(AN)	6	125 x 155	11412	2	16,5:1	162	220	820, 906, 992
OM 496.900-030 (AFS)	D	(AN)	6	125 x 155	11412	2	16,5:1	147	200	992
OM 496.900-031 (AFS)	D	(AN)	6	125 x 155	11412	2	16,5:1	147	200	992



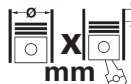

M



			Cyl	 X mm	cm ³		Comp. Ratio ε	kW	PS	Pos
OM 496.900-034 (AFS)	D	(AN)	6	125 x 155	11412	2	16,5:1	162	220	761, 992
OM 496.900-035 (AFS)	D	(AN)	6	125 x 155	11412	2	16,5:1	162	220	761, 992
OM 496.900-401 (AFS)	D	(AN)	6	125 x 155	11412	2	16,5:1	206	280	824, 909, 992
OM 496.900-402 (AFS)	D	(AN)	6	125 x 155	11412	2	16,5:1	206	280	909, 992
OM 496.900-425 (AFS)	D	(AN)	6	125 x 155	11412	2	16,5:1	206	280	992
OM 496.900-426 (AFS)	D	(AN)	6	125 x 155	11412	2	16,5:1	206	280	824, 909, 992
OM 496.900-429 (AFS)	D	(AN)	6	125 x 155	11412	2	16,5:1	206	280	992
OM 496.900-430 (AFS)	D	(AN)	6	125 x 155	11412	2	16,5:1	202	275	824, 992
OM 496.900-431 (AFS)	D	(AN)	6	125 x 155	11412	2	16,5:1	202	275	992
OM 496.900-501 (AFS)	D	(AN)	6	125 x 155	11412	2	16,5:1	235	320	912, 992
OM 521.940	D	(LA)	6	130 x 150	11946	4	17,25:1	315	428	992
OM 522.940	D	(LA)	8	130 x 150	15928	4	17,25:1	420	570	992
OM 522.941	D	(LA)	8	130 x 150	15928	4	17,25:1	413	562	992
OM 522.942	D	(LA)	8	130 x 150	15928	4	17,25:1	362	496	992
OM 522.943	D	(LA)	8	130 x 150	15928	4	17,25:1	362	496	992
OM 522.950	D	(LA)	8	130 x 150	15928	4	17,25:1	530	721	992
OM 541.920	D	(LA)	6	130 x 150	11946	4	17,25:1	230	313	320, 321, 336, 349, 350, 365, 380, 389, 992
OM 541.921	D	(LA)	6	130 x 150	11946	4	17,25:1	315	428	327, 342, 395, 406, 992
OM 541.922	D	(LA)	6	130 x 150	11946	4	17,25:1	260	354	322, 338, 351, 367, 382, 391, 992
OM 541.923	D	(LA)	6	130 x 150	11946	4	17,25:1	290	394	324, 325, 340, 353, 354, 369, 384, 385, 393, 404, 992
OM 541.924	D	(LA)	6	130 x 150	11946	4	17,25:1	290	394	325, 340, 393, 404, 992
OM 541.925	D	(LA)	6	130 x 150	11946	4	17,25:1	315	428	327, 340, 356, 371, 386, 387, 395, 406, 992
OM 541.926	D	(LA)	6	130 x 150	11946	4	17,25:1	230	331	320, 336, 337, 389, 992
OM 541.927	D	(LA)	6	130 x 150	11946	4	17,25:1	260	354	322, 338, 339, 391, 992
OM 541.928	D	(LA)	6	130 x 150	11946	4	17,25:1	315	428	992
OM 541.940	D	(LA)	6	130 x 150	11946	4	17,25:1	230-235	313-320	320, 321, 336, 337, 349, 350, 359, 365, 366, 380, 381, 389, 390, 992
OM 541.941	D	(LA)	6	130 x 150	11946	4	17,25:1	230-235	313-320	320, 336, 337, 389, 992
OM 541.942	D	(LA)	6	130 x 150	11946	4	17,25:1	260-265	354-360	322, 323, 338, 339, 351, 352, 367, 368, 382, 383, 391, 392, 992
OM 541.943	D	(LA)	6	130 x 150	11946	4	17,25:1	260-265	354-360	322, 338, 339, 391, 992
OM 541.944	D	(LA)	6	130 x 150	11946	4	17,25:1	290-300	394-408	325, 326, 340, 341, 354, 355, 369, 370, 384, 385, 393, 394, 404, 405, 992
OM 541.945	D	(LA)	6	130 x 150	11946	4	17,25:1	290-300	394-408	325, 340, 393, 404, 992
OM 541.946	D	(LA)	6	130 x 150	11946	4	17,25:1	315-320	428-435	327, 328, 340, 343, 356, 357, 371, 372, 386, 387, 395, 396, 406, 407, 992
OM 541.947	D	(LA)	6	130 x 150	11946	4	17,25:1	315-320	428-435	327, 342, 395, 406, 992
OM 541.948	D	(LA)	6	130 x 150	11946	4	17,25:1	335-355	456-483	329, 330, 340, 344, 345, 358, 359, 373, 374, 386, 388, 393, 395, 397, 398, 404, 406, 408, 409, 992
OM 541.949	D	(LA)	6	130 x 150	11946	4	17,25:1	355	455	330, 345, 398, 409, 992
OM 541.950	D	(LA)	6	130 x 150	11946	4	17,25:1	260	353	992
OM 541.951	D	(LA)	6	130 x 150	11946	4	17,25:1	230-260	313-353	992
OM 541.952	D	(LA)	6	130 x 150	11946	4	17,25:1	230-260	313-353	992
OM 542.920	D	(LA)	8	130 x 150	15928	4	17,25:1	390	530	332, 347, 361, 376, 400, 992
OM 542.921	D	(LA)	8	130 x 150	15928	4	17,25:1	350	476	330, 345, 359, 374, 398, 409, 992
OM 542.922	D	(LA)	8	130 x 150	15928	4	17,25:1	420	571	334, 363, 378, 402, 992
OM 542.923	D	(LA)	8	130 x 150	15928	4	17,25:1	420	571	992
OM 542.924	D	(LA)	8	130 x 150	15928	4	17,25:1	420	570	992
OM 542.925	D	(LA)	8	130 x 150	15928	4	17,25:1	350	476	330, 345, 359, 398, 409, 992
OM 542.926	D	(LA)	8	130 x 150	15928	4	17,25:1	390	530	400, 992
OM 542.940	D	(LA)	8	130 x 150	15928	4	17,25:1	350-370	476-503	330, 345, 359, 374, 398, 409, 992
OM 542.941	D	(LA)	8	130 x 150	15928	4	17,25:1	350-370	476-503	330, 331, 345, 346, 360, 375, 398, 399, 409, 410, 992



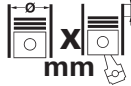

M



			Cyl	 mm	cm ³		Comp. Ratio ϵ	kW	PS	Pos
OM 542.942	D	(LA)	8	130 x 150	15928	4	17,25:1	390-395	530-537	332, 333, 347, 348, 361, 362, 376, 377, 400, 401, 992
OM 542.943	D	(LA)	8	130 x 150	15928	4	17,25:1	390-395	530-587	400, 992
OM 542.944	D	(LA)	8	130 x 150	15928	4	17,25:1	420-425	570-578	334, 335, 363, 364, 378, 379, 402, 403, 992
OM 542.945	D	(LA)	8	130 x 150	15928	4	17,25:1	420-425	570-578	992
OM 542.947	D	(LA)	8	130 x 150	15928	4	17,25:1	390-420	530-571	992
OM 542.948	D	(LA)	8	130 x 150	15928	4	17,25:1	320-370	435-503	496
OM 601.911	D	(AN)	4	87 x 84	1997	2		53	72	187, 992
OM 601.912	D	(AN)	4	87 x 84	1997	2	22:1	53-55	72-75	50, 205, 992
OM 601.913	D	(AN)	4	87 x 84	1997	2	22:1	55	75	12, 992
OM 601.940	D	(AN)	4	89 x 92,4	2299	2	21:1	58	79	618, 625, 628, 658, 992
OM 601.941	D	(AN)	4	89 x 92,4	2299	2	21:1	58	79	667, 992
OM 601.942	D	(AN)	4	89 x 92,4	2299	2	22:1	60	82	179, 992
OM 601.943	D	(AN)	4	89 x 92,4	2299	2	22:1	60	82	127, 135, 144, 992
OM 601.970	D	(LA)	4	89 x 92,4	2299	2	19,5:1	72	98	157, 175, 181, 992
OM 602.911	D	(AN)	5	87 x 84	2497	2	22:1	69	94	188, 237, 992
OM 602.912	D	(AN)	5	87 x 84	2497	2	22:1	69	94	237, 992
OM 602.930	D	(AN)	5	87 x 84	2497	2	22:1	69	94	239, 240, 992
OM 602.931	D	(AN)	5	87 x 84	2497	2	22:1	62	84	241, 992
OM 602.938	D	(AN)	5	87 x 84	2497	2	22:1	69	94	240, 992
OM 602.939	D	(AN)	5	87 x 84	2497	2	22:1	69	94	240, 992
OM 602.940	D	(AN)	5	89 x 92,4	2874	2	21:1	70	95	619, 621, 630, 632, 664, 992
OM 602.941	D	(AN)	5	89 x 92,4	2874	2	21:1	70	95	563, 566, 992
OM 602.942	D	(AN)	5	89 x 92,4	2874	2	21:1	72	98	266, 992
OM 602.946	D	(AN)	5	89 x 92,4	2874	2	21:1	70	95	266, 992
OM 602.947	D	(AN)	5	89 x 92,4	2874	2	21:1	72	98	266, 992
OM 602.948	D	(AN)	5	89 x 92,4	2874	2	21:1	71	97	566
OM 602.961	D	(A)	5	87 x 84	2497	2	22:1	93	126	189, 992
OM 602.962	D	(A)	5	87 x 84	2497	2	22:1	93	126	65, 238
OM 602.980	D	(LA)	5	89 x 92,4	2874	2	19,5:1	90	122	130, 138, 145, 147
OM 602.981	D	(LA)	5	89 x 92,4	2874	2	19,5:1	85-90	116-122	564, 567
OM 602.982	D	(LA)	5	89 x 92,4	2874	2	19,5:1	95	129	71
OM 602.983	D	(LA)	5	89 x 92,4	2874	2	19,5:1	88	120	267
OM 602.984	D	(LA)	5	89 x 92,4	2874	2	19,5:1	90	122	161, 162, 164, 167, 169, 171, 173
OM 602.985	D	(LA)	5	89 x 92,4	2874	2	19,5:1	90	122	162, 164, 167, 169, 171, 173
OM 602.986	D	(A)	5	89 x 92,4	2874	2	19,5:1	90	122	128, 136, 145
OM 602.989	D	(LA)	5	89 x 92,4	2874	2	19,5:1	80	109	612
OM 602.990	D	(AN)	5	87 x 84	2497	2	22:1	63	86	525
OM 602.991	D	(AN)	5	89 x 92,4	2874	2	21:1	70	95	992
OM 602.993	D	(A)	5	87 x 84	2497	2	22:1	93	126	992
OM 602.994	D	(AN)	5	89 x 92,4	2874	2	21:1	72	98	525
OM 603.912	D	(AN)	6	87 x 84	2996	2	22:1	80-83	109-113	272, 992
OM 603.913	D	(AN)	6	87 x 84	2996	2	22:1	83	113	272, 992
OM 603.931	D	(AN)	6	87 x 84	2996	2	22:1	80	109	89, 279, 992
OM 603.960	D	(A)	6	87 x 84	2996	2	22:1	105-108	143-147	75, 269, 992
OM 603.961	D	(A)	6	87 x 84	2996	2	22:1	105	143	282
OM 603.963	D	(A)	6	87 x 84	2996	2	22:1	108	147	75, 269, 992
OM 603.971	D	(A)	6	89 x 92,4	3449	2	19,5:1	110	150	110, 283, 992
OM 603.972	D	(A)	6	89 x 92,4	3449	2	19,5:1	100	136	93, 296, 992
OM 604.910	D	(AN)	4	89 x 86,6	2155	4	22:1	70	95	16
OM 604.912	D	(AN)	4	89 x 86,6	2155	4	22:1	70	95	55
OM 604.915 (POR)	D	(AN)	4	87 x 84	1997	4	22:1	83	113	12
OM 604.917 (POR)	D	(AN)	4	87 x 84	1997	4	22:1	65	88	51
OM 605.910	D	(AN)	5	87 x 84	2497	4	22:1	83	113	24
OM 605.911	D	(AN)	5	87 x 84	2497	4	22:1	83	113	63
OM 605.912	D	(AN)	5	87 x 84	2497	4	22:1	83	113	64
OM 605.960	D	(LA)	5	87 x 84	2497	4	22:1	110	150	25
OM 605.962	D	(LA)	5	87 x 84	2497	4	22:1	110	150	66
OM 606.910	D	(AN)	6	87 x 84	2996	4	22:1	100	136	73
OM 606.912	D	(AN)	6	87 x 84	2996	4	22:1	100	136	74
OM 606.961	D	(LA)	6	87 x 84	2996	4	22:1	130	177	106
OM 606.962	D	(LA)	6	87 x 84	2996	4	22:1	130	177	76
OM 606.964	D	(LA)	6	87 x 84	2996	4	22:1	130	177	90
OM 611.960	D	(LA)	4	88 x 88,3	2148	4	19:1	75-92	102-125	13, 17, 992





M



			Cyl	 mm	cm ³		Comp. Ratio ε	kW	PS	Pos
OM 611.961	D	(LA)	4	88 x 88,3	2151	4	19:1	75-105	102-143	52, 56, 992
OM 611.962	D	(LA)	4	88 x 88,3	2151	4	18:1	85-105	116-143	14, 18, 992
OM 611.980	D	(LA)	4	88 x 88,3	2151	4	18:1	60-90	82-122	154, 155, 178, 180, 182, 992
OM 611.981	D	(LA)	4	88 x 88,3	2151	4	18:1	80	109	129, 131, 137, 139, 146, 148, 992
OM 612.961	D	(LA)	5	88 x 88,3	2686	4	18:1	125	170	67, 992
OM 612.962	D	(LA)	5	88 x 88,3	2686	2	18:1	125	170	26, 39, 992
OM 612.963	D	(LA)	5	88 x 88,3	2686	4	19:1	120	163	87, 97, 992
OM 612.966	D	(LA)	5	88 x 88,4	2686	4	19:1	115	156	87, 992
OM 612.967	D	(LA)	5	88 x 88,3	2686	4	18:1	125	170	39, 992
OM 612.981	D	(LA)	5	88 x 88,3	2686	2	18:1	110-115	150-156	133, 142, 151, 152, 992
OM 613.961	D	(LA)	6	88 x 88,3	3222	4	18:1	145	197	80
OM 615.910	D	(AN)	4	87 x 92,4	2197	2	21:1	44	60	506, 647, 652
OM 615.911	D	(AN)	4	87 x 92,4	2197	2	21:1	33	45	551, 552, 576
OM 615.912	D	(AN)	4	87 x 92,4	2197	2	21:1	44-49	60-67	209
OM 615.913	D	(AN)	4	87 x 83,6	1988	2	21:1	40	55	203, 992
OM 615.914	D	(AN)	4	87 x 92,4	2197	2	21:1	44	60	551, 555
OM 615.915	D	(AN)	4	87 x 83,6	1988	2	21:1	40	55	613, 622
OM 615.916	D	(AN)	4	87 x 92,4	2197	2	21:1	40	54	992
OM 615.917	D	(AN)	4	87 x 92,4	2197	2	21:1	44	60	486, 614
OM 615.932	D	(AN)	4	87 x 92,4	2197	2	21:1	44	60	576
OM 615.937	D	(AN)	4	87 x 92,4	2197	2	21:1	44	60	623
OM 615.938	D	(AN)	4	87 x 92,4	2197	2	21:1	44	60	506, 647, 652
OM 615.939	D	(AN)	4	87 x 92,4	2197	2	21:1	44	60	623
OM 615.940	D	(AN)	4	87 x 83,6	1988	2		40	55	204
OM 615.941	D	(AN)	4	87 x 92,4	2197	2	21:1	44	60	210
OM 615.943 (ITA)	D	(AN)	4	87 x 83,6	1988	2	21:1	39	53	613
OM 615.944	D	(AN)	4	87 x 83,6	1988	2		40	55	615, 624
OM 615.963	D	(AN)	4	87 x 83,6	1988	2	21:1	43	58	485, 486, 533, 534, 992
OM 616.910	D	(AN)	4	90,9 x 92,4	2399	2		53	72	507, 648, 653
OM 616.911	D	(AN)	4	90,9 x 92,4	2399	2		38	52	553, 556, 584
OM 616.912	D	(AN)	4	90,9 x 92,4	2399	2		48-53	65-72	226, 227, 579, 584, 616, 626, 992
OM 616.913	D	(AN)	4	90,9 x 92,4	2399	2	21:1	53	72	653
OM 616.914	D	(AN)	4	90,9 x 92,4	2399	2	21:1	53	72	665
OM 616.915	D	(AN)	4	92 x 92,4	2448	2	21:1	38	52	553, 584
OM 616.916	D	(AN)	4	90,9 x 92,4	2399	2	21:1	48	65	226, 228, 579, 584, 616, 626, 992
OM 616.917	D	(AN)	4	90,9 x 92,4	2399	2		48	65	616, 992
OM 616.930	D	(AN)	4	92 x 92,4	2448	2	21:1	44	60	556, 584
OM 616.931	D	(AN)	4	92 x 92,4	2448	2	21:1	44	60	556, 584
OM 616.932	D	(AN)	4	90,9 x 92,4	2399	2		44	60	556, 584
OM 616.933	D	(AN)	4	90,9 x 92,4	2399	2		44	60	556, 584
OM 616.934	D	(AN)	4	90,9 x 92,4	2399	2		48	65	616, 626, 629
OM 616.936	D	(AN)	4	90,9 x 92,4	2399	2	21:1	53	72	230
OM 616.937	D	(AN)	4	90,9 x 92,4	2399	2	21:1	53	72	507, 616, 626
OM 616.938	D	(AN)	4	90,9 x 92,4	2399	2	21:1	53	72	230, 231
OM 616.939	D	(AN)	4	90,9 x 92,4	2399	2	21:1	53	72	507, 616, 626, 629, 653
OM 616.942	D	(AN)	4	90,9 x 92,4	2399	2	21:1	38	52	584
OM 616.943	D	(AN)	4	90,9 x 92,4	2399	2	21:1	44	60	584, 585
OM 616.944	D	(AN)	4	90,9 x 92,4	2399	2	21:1	44	60	584, 585
OM 616.963	D	(AN)	4	90,9 x 92,4	2399	2	21:1	53-56	72-76	488, 490, 491, 492, 493, 534, 535, 536, 537, 538, 539, 992
OM 617.910	D	(AN)	5	90,9 x 92,4	2998	2	21:1	59	80	229, 270, 992
OM 617.912	D	(AN)	5	90,9 x 92,4	2998	2		59-65	80-88	271, 992
OM 617.931	D	(AN)	5	90,9 x 92,4	2998	2	21:1	65	88	277
OM 617.932	D	(AN)	5	90,9 x 92,4	2998	2	21:1	65	88	277, 278
OM 617.933	D	(AN)	5	90,9 x 92,4	2998	2	21:1	65	88	278
OM 617.950	D	(A)	5	90,9 x 92,4	2998	2	21,5:1	85-92	116-125	281
OM 617.951	D	(A)	5	90,9 x 92,4	2998	2	21,5:1	92	125	282
OM 617.952	D	(A)	5	90,9 x 92,4	2998	2	21,5:1	92	125	268
OM 621.912	D	(AN)	4	87 x 83,6	1988	2	21:1	40	55	190, 202
OM 621.913	D	(AN)	4	87 x 83,6	1988	2	21:1	40	55	637, 644, 646
OM 621.915	D	(AN)	4	87 x 83,6	1988	2	21:1	40	55	637, 644, 646
OM 621.916	D	(AN)	4	87 x 83,6	1988	2	21:1	25-29	34-39	551, 552, 555
OM 621.918	D	(AN)	4	87 x 83,6	1988	2	21:1	40	55	190, 202
OM 621.919	D	(AN)	4	87 x 83,6	1988	2	21:1	40	55	637, 644, 646, 647



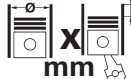

M





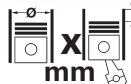

			Cyl		cm ³		Comp. Ratio ε	kW	PS	Pos
OM 621.930	D	(AN)	4	87 x 83,6	1988	2	21:1	40	55	637, 644, 646
OM 621.931	D	(AN)	4	87 x 83,6	1988	2	21:1	25-29	34-39	551, 552, 555
OM 621.932	D	(AN)	4	87 x 83,6	1988	2	21:1	40	55	504, 510, 646, 647, 651
OM 646.951	D	(LA)	4	88 x 88,3	2148	4	18:1	90	122	53
OM 646.961	D	(LA)	4	88 x 88,3	2148	4	18:1	110	150	57
OM 646.962	D	(LA)	4	88 x 88,3	2148	4	18:1	90-110	122-150	14, 18, 32, 33
OM 646.963	D	(LA)	4	88 x 88,3	2148	4	18:1	90-110	122-150	14, 18, 33
OM 647.961	D	(LA)	5	88 x 88,3	2685	4	18:1	130	177	68
OM 647.981	D	(LA)	5	88 x 88,3	2685	4	18:1			134, 137, 141, 143, 146, 148, 150, 151
OM 661.911	D	(AN)	4	89 x 92,4	2299	2	21:1	58	79	487, 992
OM 662.911	D	(AN)	5	89 x 92,4	2874	2	21:1	70	95	489, 992
OM 668.940	D	(LA)	4	80 x 84	1689	4	19,5:1	55-66	75-90	3, 4
OM 668.941	D	(LA)	4	80 x 84	1689	4	19,5:1	44	60	3
OM 904.904	D	(LA)	4	102 x 130	4250	2	17:1	75	102	168, 170, 172, 174, 992
OM 904.905	D	(LA)	4	102 x 130	4250	2	17:1	90	122	678, 684, 992
OM 904.906	D	(LA)	4	102 x 130	4250	2	17:1	100	136	172, 692, 693, 699, 702, 992
OM 904.907	D	(LA)	4	102 x 130	4250	2	17:1	125	170	688, 693, 699, 702, 725, 746, 992
OM 904.908	D	(LA)	4	102 x 130	4250	2	17:1	100	136	163, 165, 170, 172, 174, 992
OM 904.909	D	(LA)	4	102 x 130	4250	2	17:1	90	122	411, 413, 416, 418, 419, 420, 992
OM 904.910	D	(LA)	4	102 x 130	4250	2	17:1	100	136	412, 417, 418, 419, 420, 421, 432, 433, 434, 436, 439, 992
OM 904.911	D	(LA)	4	102 x 130	4250	2	17:1	125	170	415, 419, 420, 422, 423, 428, 429, 434, 440, 446, 447, 992
OM 904.912	D	(LA)	4	102 x 130	4250	2	17:1	134	180	711, 732, 756, 992
OM 904.914	D	(LA)	4	102 x 130	4250	2		100	136	163, 165, 170, 172, 174, 992
OM 904.915	D	(LA)	4	102 x 130	4250	2		90	122	411, 416, 420, 992
OM 904.916	D	(LA)	4	102 x 130	4250	2		100	136	411, 412, 413, 417, 418, 420, 427, 429, 430, 432, 433, 992
OM 904.917	D	(LA)	4	102 x 130	4250	2		125	170	419, 420, 423, 428, 429, 434, 440, 446, 447, 992
OM 904.918	D	(LA)	4	102 x 130	4250	2	17,4:1	90	122	679, 992
OM 904.919	D	(LA)	4	102 x 130	4250	2	17:1	100	136	692, 992
OM 904.920	D	(LA)	4	102 x 130	4250	2	17:1	125	170	731, 992
OM 904.921	D	(LA)	4	102 x 130	4250	2	17:1	112	152	417, 992
OM 904.922	D	(LA)	4	102 x 130	4250	2	17:1	112	152	411, 413, 414, 416, 418, 419, 421, 422, 423, 427, 433, 434, 436, 439, 992
OM 904.923	D	(LA)	4	102 x 130	4250	2	17:1	112	152	163, 165, 166, 168, 170, 172, 174, 992
OM 904.924	D	(LA)	4	102 x 130	4250	2	17:1	100	136	692, 992
OM 904.925	D	(LA)	4	102 x 130	4250	2	17:1	112	152	700, 708, 992
OM 904.927	D	(LA)	4	102 x 130	4250	2		110	150	574, 575, 992
OM 904.928	D	(LA)	4	102 x 130	4250	2		125	170	574, 575, 992
OM 904.929	D	(LA)	4	102 x 130	4250	2	17:1	125	170	479, 992
OM 904.930	D	(LA)	4	102 x 130	4250	2	17:1	100	136	992
OM 904.936	D	(LA)	4	102 x 130	4250	2		110	150	163, 165, 166, 170, 172, 174, 992
OM 904.938	D	(LA)	4	102 x 130	4250	2	17,4:1	125	170	711, 726, 732, 756, 778, 992
OM 904.941	D	(LA)	4	102 x 130	4250	2	17,4:1	112	152	992
OM 904.942	D	(LA)	4	102 x 130	4250	2		130	177	479, 992
OM 904.943	D	(LA)	4	102 x 130	4250	2	17,4:1	112	152	422, 992
OM 904.950	D	(LA)	4	102 x 130	4250	2		90-110	122-150	413, 418, 422, 427, 433, 992
OM 904.951	D	(LA)	4	102 x 130	4250	2		130	177	420, 424, 429, 435, 441, 447, 992
OM 904.952	D	(LA)	4	102 x 130	4250	2		130	177	609, 610, 992
OM 904.953	D	(LA)	4	102 x 130	4250	2		110	150	609, 610, 992
OM 904.955	D	(LA)	4	102 x 130	4250	2	17,4:1	100	136	163, 165, 170, 172, 174, 675, 992
OM 904.957	D	(LA)	4	102 x 130	4250	2	17,4:1	110	150	692, 992

M



			Cyl	 X mm	cm ³		Comp. Ratio ε	kW	PS	Pos
OM 904.959	D	(LA)	4	102 x 130	4250	2	17,4:1	128	170	479, 992
OM 904.961	D	(LA)	4	102 x 130	4250	2		90	122	168, 992
OM 904.962	D	(LA)	4	102 x 130	4250	2	17,4:1	130	177	529, 731, 992
OM 906.910	D	(LA)	6	102 x 130	6374	2	17,4:1	170	231	418, 419, 421, 423, 425, 428, 429, 430, 431, 433, 434, 436, 439, 440, 442, 443, 445, 446, 448, 451, 458, 459, 992
OM 906.911	D	(LA)	6	102 x 130	6374	2	17,4:1	205	279	433, 434, 436, 439, 440, 442, 444, 445, 446, 448, 450, 451, 992
OM 906.912	D	(LA)	6	102 x 130	6374	2	17,4:1	194	260	992
OM 906.913	D	(LA)	6	102 x 130	6374	2	17,4:1	172	230	992
OM 906.914	D	(LA)	6	102 x 130	6374	2	17,4:1	157	210	674, 992
OM 906.915	D	(LA)	6	102 x 130	6374	2		170	231	421, 425, 427, 429, 430, 431, 436, 437, 442, 448, 449, 458, 459, 992
OM 906.916	D	(LA)	6	102 x 130	6374	2		205	279	439, 445, 451, 992
OM 906.917	D	(LA)	6	102 x 130	6374	2	17,4:1	170	231	452, 453, 992
OM 906.918	D	(LA)	6	102 x 130	6374	2	17,4:1	180	245	453, 454, 455, 529, 992
OM 906.919	D	(LA)	6	102 x 130	6374	2	17,4:1	180	245	426, 438, 444, 445, 450, 451, 992
OM 906.920	D	(LA)	6	102 x 130	6374	2	17,4:1	170	231	456, 460, 462, 465, 470, 992
OM 906.921	D	(LA)	6	102 x 130	6374	2	17,4:1	205	279	456, 457, 460, 461, 463, 464, 466, 471, 475, 992
OM 906.922	D	(LA)	6	102 x 130	6374	2	17,4:1	170	231	456, 457, 992
OM 906.923	D	(LA)	6	102 x 130	6374	2	17,4:1	205	279	456, 457, 992
OM 906.924	D	(LA)	6	102 x 130	6374	2	17,4:1	170	231	872, 992
OM 906.925	D	(LA)	6	102 x 130	6374	2		170	231	421, 425, 430, 448, 456, 457, 460, 992
OM 906.926	D	(LA)	6	102 x 130	6374	2		205	279	457, 461, 463, 992
OM 906.927	D	(LA)	6	102 x 130	6374	2		170	231	456, 992
OM 906.928	D	(LA)	6	102 x 130	6374	2		205	279	457, 992
OM 906.930	D	(LA)	6	102 x 130	6374	2	17,4:1	205	279	476, 992
OM 906.931	D	(LA)	6	102 x 130	6374	2	17,4:1	170	231	476, 992
OM 906.933	D	(LA)	6	102 x 130	6374	2		209	284	484, 529, 786, 992
OM 906.934	D	(LA)	6	102 x 130	6374	2	17,4:1	209	280	476, 992
OM 906.935	D	(LA)	6	102 x 130	6374	2		170	231	575, 583, 611, 992
OM 906.937	D	(LA)	6	102 x 130	6374	2	17,4:1	170	231	992
OM 906.938	D	(LA)	6	102 x 130	6374	2	17,4:1	205	279	476, 992
OM 906.939	D	(LA)	6	102 x 130	6374	2		180	245	426, 438, 444, 450, 992
OM 906.940	D	(LA)	6	102 x 130	6374	2	17,4:1	170	231	481, 992
OM 906.941	D	(LA)	6	102 x 130	6374	2	17,4:1	205	279	482, 483, 992
OM 906.947	D	(LA)	6	102 x 130	6374	2		194	260	484, 992
OM 906.951	D	(LA)	6	102 x 130	6374	2		170	231	481, 992
OM 906.952	D	(LA)	6	102 x 130	6374	2		205	279	482, 483, 992
OM 906.953	D	(LA)	6	102 x 130	6374	2		205	279	786, 876, 926, 992
OM 906.954	D	(LA)	6	102 x 130	6374	2	17,4:1	172	234	436, 448, 992
OM 906.955	D	(LA)	6	102 x 130	6374	2		205	279	583, 992
OM 906.956	D	(LA)	6	102 x 130	6374	2	17,4:1	209	284	457, 992
OM 906.960	D	(LA)	6	102 x 130	6374	2		205	279	476, 480, 992
OM 906.961	D	(LA)	6	102 x 130	6374	2		205	279	476, 992
OM 906.962	D	(LA)	6	102 x 130	6374	2		180	245	476, 992
OM 906.963	D	(LA)	6	102 x 130	6374	2		180	245	476, 992
OM 906.964	D	(LA)	6	102 x 130	6374	2		170-180	231-245	992
OM 906.965	D	(LA)	6	102 x 130	6374	2		205	279	992
OM 906.974	D	(LA)	6	102 x 130	6374	2	17,4:1	209	280	529, 786, 992
OM 906.975	D	(LA)	6	102 x 130	6374	2		180	245	529, 783, 992
OM 906.977	D	(LA)	6	102 x 130	6374	2	17,4:1	209	280	529, 786, 992
OM 906.982	D	(LA)	6	102 x 130	6374	2		170	231	992
OM 906.983	D	(LA)	6	102 x 130	6374	2		180	245	454, 529, 992
OM 907.910	D	(LA)	4	102 x 130	4250	2	17,4:1	75	102	992
OM 907.920	D	(LA)	4	102 x 130	4250	2	17,4:1	90	122	992
OM 907.930	D	(LA)	4	102 x 130	4250	2	17,4:1	100	136	992
OM 907.940	D	(LA)	4	102 x 130	4250	2	17,4:1	125	170	992
OM 907.941	D	(LA)	4	102 x 130	4250	2	17,4:1	125	170	479, 992
OM 907.960	D	(LA)	4	102 x 130	4250	2	17,4:1	75	102	992
OM 907.970	D	(LA)	4	102 x 130	4250	2	17,4:1	90	122	992
OM 907.980	D	(LA)	4	102 x 130	4250	2	17,4:1	100	136	992

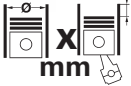



			Cyl	 mm	cm ³		Comp. Ratio ε	kW	PS	Pos
OM 907.990	D	(LA)	4	102 x 130	4250	2	17,4:1	125	170	992
OM 909.900	D	(LA)	6	102 x 130	6374	2	17,4:1	170	231	476, 992
OM 909.901	D	(LA)	6	102 x 130	6374	2	17,4:1	205	279	476, 992
OM 909.910	D	(LA)	6	102 x 130	6374	2	17,4:1	170	231	992
OM 909.911	D	(LA)	6	102 x 130	6374	2	17,4:1	170	231	476, 992
OM 909.920	D	(LA)	6	102 x 130	6374	2	17,4:1	205	279	992
OM 909.921	D	(LA)	6	102 x 130	6374	2	17,4:1	205	279	476, 992
OM 909.960	D	(LA)	6	102 x 130	6374	2	17,4:1	170	231	992
OM 909.970	D	(LA)	6	102 x 130	6374	2	17,4:1	205	279	992
OM 909.971	D	(LA)	6	102 x 130	6374	2	17,4:1	205	279	992
OM 924.910	D	(LA)	4	106 x 136	4800	2	17,4:1	160	218	760, 992
OM 924.911	D	(LA)	4	106 x 136	4800	2		160	218	611, 992
OM 924.912	D	(LA)	4	106 x 136	4800	2	17,4:1	160	218	781, 992
OM 924.914	D	(LA)	4	106 x 136	4800	2	17,4:1	160	218	781, 992
OM 926.911	D	(LA)	6	106 x 136	7201	2		240	326	992
OM 926.912	D	(LA)	6	106 x 136	7201	2		240	326	992
OM 926.914	D	(LA)	6	106 x 136	7201	2	17:1	240	326	992
OM 926.915	D	(LA)	6	106 x 136	7201	2	17:1	240	326	992
OM 904.931	D	(LA)	4	102 x 130	4250	2	17:1	135	184	992
OM 941.910	D	(LA)	6	130 x 150	11946	4	17,25:1	230	313	992
OM 941.920	D	(LA)	6	130 x 150	11946	4	17,25:1	260	354	992
OM 941.921	D	(LA)	6	130 x 150	11946	4	17,25:1	260	356	395, 992
OM 941.929	D	(LA)	6	130 x 150	11946	4	17,25:1	290	394	395, 992
OM 941.930	D	(LA)	6	130 x 150	11946	4	17,25:1	300	408	992
OM 941.940	D	(LA)	6	130 x 150	11946	4	17,25:1	315	428	992
OM 941.960	D	(LA)	6	130 x 150	11946	4	17,25:1	230	313	992
OM 941.970	D	(LA)	6	130 x 150	11946	4	17,25:1	260	354	992
OM 941.980	D	(LA)	6	130 x 150	11946	4	17,25:1	290	394	992
OM 941.981	D	(LA)	6	130 x 150	11946	4	17,25:1	290	394	992
OM 941.990	D	(LA)	6	130 x 150	11946	4	17,25:1	315	428	992
M OM 942.900	D	(LA)	8	130 x 150	15928	4	17,25:1	300	408	496, 992
OM 942.910	D	(LA)	8	130 x 150	15928	4	17,25:1	350	476	992
OM 942.911	D	(LA)	8	130 x 150	15928	4	17,25:1	350	476	496, 992
OM 942.912	D	(LA)	8	130 x 150	15928	4	17,25:1	350	476	992
OM 942.925	D	(LA)	8	130 x 150	15928	4	17,25:1	400	540	992
OM 942.930	D	(LA)	8	130 x 150	15928	4	17,25:1	420	570	992
OM 942.960	D	(LA)	8	130 x 150	15928	4	17,25:1	350	476	992
OM 942.967	D	(LA)	8	130 x 150	15928	4	17,25:1	370-380	503-516	992
OM 942.970	D	(LA)	8	130 x 150	15928	4	17,25:1	390	530	992
OM 942.980	D	(LA)	8	130 x 150	15928	4	17,25:1	420	570	992
OM 942.990	D	(LA)	8	130 x 150	15928	4	17,25:1	330-448	445-609	992





A 140 (168)

1

10.1997→08.2004	M 166	940, 960				
Reference	166 200 03 20	166 200 04 20	166 200 05 20			50 005 470
	→063274					
10.1997→08.2004	M 166	940, 960				
Reference	166 200 06 20	166 200 07 20				50 005 471
	30134437→					



A 160 (168)

2

10.1997→08.2004	M 166	960				
Reference	166 200 03 20	166 200 04 20	166 200 05 20			50 005 470
	→063274					
10.1997→08.2004	M 166	960				
Reference	166 200 06 20	166 200 07 20				50 005 471
	30134437→					



A 160 CDI (168)

3

09.1998→	OM 668	940-941				
Reference	166 200 03 20	166 200 04 20	166 200 05 20			50 005 470
	→014963					
09.1998→	OM 668	940-941				
Reference	166 200 06 20	166 200 07 20				50 005 471
	OM 668.941: 30134437→					

A 170 CDI (168)

4

07.1998→02.2001	OM 668	940				
Reference	166 200 03 20	166 200 04 20	166 200 05 20			50 005 470
	→014963					
07.1998→02.2001	OM 668	940				
Reference	166 200 06 20	166 200 07 20				50 005 471
	30134437→					

A 190 (168)

5

06.1999→08.2004	M 166	990				
Reference	166 200 03 20	166 200 04 20	166 200 05 20			50 005 470
	→063274					



06.1999→08.2004 Reference 	M 166 990 166 200 06 20 166 200 07 20 063275→			50 005 471
A 210 Evolution (168)				6
03.2002→08.2004 Reference	M 166 995 166 200 06 20 166 200 07 20			50 005 471
C 180 (202)				7
09.2000→02.2001 Reference	M 111 952 111 200 42 01			50 005 908 <small>NEW</small>
06.1993→02.2001 Reference	M 111 920-921 111 200 04 01 111 200 40 01			50 005 433
C 180 (203)				8
01.2001→08.2002 Reference	M 111 951 111 200 43 01			50 005 773
01.2001→08.2002 Reference	M 111 951 111 200 04 01 111 200 40 01			50 005 433
C 200 (202)				9
01.1994→02.2001 Reference	M 111 941, 945 111 200 04 01 111 200 40 01			50 005 433
C 200 Kompressor (202)				10
09.1995→03.2001 Reference	M 111 944 111 200 23 01			50 005 491
04.2000→02.2001 Reference	M 111 956 111 200 42 01			50 005 908 <small>NEW</small>

M



C 200 Kompressor (203)

11

05.2000→08.2002 M 111 955
 09.2002→ M 271 940
 Reference 111 200 42 01



50 005 908
 NEW

C 200 D (202)

12

03.1993→08.1995 OM 601 913
 09.1996→06.1999 OM 604 915 (POR)
 Reference 601 200 11 20



50 005 036

C 200 CDI (202)

13

03.1998→02.2001 OM 611 960
 Reference 611 200 02 01 611 200 12 01



50 005 455

C 200 CDI (203)

14

03.2003→ OM 646 962-963
 Reference 646 200 03 01



50 005 909
 NEW

10.2000→02.2003 OM 611 962
 Reference 611 200 02 01 611 200 12 01



50 005 455

M

C 220 (202)

15

03.1993→09.1996 M 111 961
 Reference 111 200 04 01 111 200 40 01



50 005 433

C 220 D (202)

16

08.1993→06.1999 OM 604 910
 Reference 601 200 11 20



50 005 036

C 220 CDI (202)

17

12.1997→02.2001 OM 611 960
 Reference 611 200 02 01 611 200 12 01



50 005 455

C 220 CDI (203)

18

03.2003→ OM 646 962-963
 Reference 646 200 03 01



50 005 909
 NEW

05.2000→02.2003 OM 611 962
 Reference 611 200 02 01 611 200 12 01



50 005 455







C 230 (202) 19				
05.1996→05.1997 Reference	M 111 111 200 04 01	974 111 200 40 01		50 005 433
C 230 Kompressor (202) 20				
09.1995→02.2001 Reference	M 111 111 200 23 01	975		50 005 491
C 230 Kompressor (203) 21				
01.2001→01.2004 Reference	M 111 111 200 42 01	981		50 005 908 <small>NEW</small>
C 240 (202) 22				
06.1997→02.2001 Reference	M 112 112 200 02 01	910, 915 112 200 04 01		50 005 457
		112 200 11 01		
		112 200 14 01		
		M 112.910: →036808 / 033140 (USA)		
06.1997→02.2001 Reference	M 112 112 200 05 01	910, 915 112 200 10 01		50 005 456
		112 200 12 01		
		112 200 15 01		
		M 112.910: 036809 / 033141 (usa)→		
C 240 (203) 23				
05.2000→06.2005 Reference	M 112 112 200 02 01	912, 916 112 200 04 01		50 005 457
		112 200 11 01		
		112 200 14 01		
05.2000→06.2005 Reference	M 112 112 200 05 01	912, 916 112 200 10 01		50 005 456
		112 200 12 01		
		112 200 15 01		
C 250 D (202) 24				
05.1993→08.1995 Reference	OM 605 602 200 00 20	910 602 200 01 20		50 005 439
		602 200 02 20		
C 250 D Turbo (202) 25				
09.1995→02.2001 Reference	OM 605 605 200 01 20	960 605 200 03 20		50 005 490
		605 200 05 20		
		605 200 08 20		
C 270 CDI (203) 26				
12.2000→08.2004 Reference	OM 612 611 200 02 01	962 611 200 12 01		50 005 455

M





C 280 (202)

27

05.1993→05.1997	M 104	941							
Reference	104 200 28 01	104 200 45 01	104 200 49 01						50 005 434
06.1997→02.2001	M 112	920							
Reference	112 200 02 01	112 200 04 01	112 200 11 01	112 200 14 01					50 005 457
	→036808 / 033140 (USA)								
06.1997→02.2001	M 112	920							
Reference	112 200 05 01	112 200 10 01	112 200 12 01	112 200 15 01					50 005 456
	036809 / 033141 (usa)→								
05.1993→05.1997	M 104	941							
Reference	104 200 33 01	104 200 44 01	104 200 47 01						50 005 436

C 320 (203)

28

05.2000→06.2005	M 112	946, 953							
Reference	112 200 02 01	112 200 04 01	112 200 11 01	112 200 14 01					50 005 457
05.2000→06.2005	M 112	946, 953							
Reference	112 200 05 01	112 200 10 01	112 200 12 01	112 200 15 01					50 005 456



C 43 AMG (202)

29

10.1997→02.2001	M 113	944 AMG							
Reference	112 200 02 01	112 200 04 01	112 200 11 01	112 200 14 01					50 005 457

CL 500 (215)

30









09.1999→09.2006	M 113	960							
Reference	112 200 02 01	112 200 04 01	112 200 11 01	112 200 14 01					50 005 457
	→000200								
09.1999→09.2006	M 113	960							
Reference	112 200 05 01	112 200 10 01	112 200 12 01	112 200 15 01					50 005 456
	000201→								

CL 55 AMG (215)

31

09.1999→08.2002	M 113	986 AMG							
Reference	112 200 02 01	112 200 04 01	112 200 11 01	112 200 14 01					50 005 457



CLC 200 CDI (203)					32
03.2003→ Reference	OM 646 646 200 03 01	962			50 005 909 NEW
CLC 220 CDI (203)					33
03.2003→ Reference	OM 646 646 200 03 01	962-963			50 005 909 NEW
CLK 200 (208)					34
06.1997→06.2000 Reference	M 111 111 200 04 01	945 111 200 40 01			50 005 433
CLK 200 Kompressor (208)					35
09.1996→06.2000 Reference	M 111 111 200 23 01	944			50 005 491
M	06.2000→01.2003 Reference	M 111 111 200 42 01	956		50 005 908 NEW
	CLK 200 Kompressor (209)				
09.2002→ Reference	M 271 111 200 42 01	940			50 005 908 NEW
CLK 230 Kompressor (208)					37
06.1997→06.2000 Reference	M 111 111 200 23 01	975			50 005 491
06.2000→01.2003 Reference	M 111 111 200 42 01	982			50 005 908 NEW
CLK 240 (209)					38
05.2002→ Reference	M 112 112 200 02 01	912 112 200 04 01	112 200 11 01 112 200 14 01		50 005 457













MERCEDES-BENZ

05.2002→ Reference	M 112 912 112 200 05 01	112 200 10 01	112 200 12 01	112 200 15 01				50 005 456
CLK 270 CDI (209)								39
09.2002→06.2005 Reference	OM 612 962, 967 611 200 02 01	611 200 12 01						50 005 455
CLK 320 (208)								40
01.1997→01.2003 Reference 	M 112 940 112 200 02 01 →036808 / 033140 (USA)	112 200 04 01	112 200 11 01	112 200 14 01				50 005 457
01.1997→01.2003 Reference 	M 112 940 112 200 05 01 036809 / 033141 (usa)→	112 200 10 01	112 200 12 01	112 200 15 01				50 005 456
CLK 320 (209)								41
05.2002→ Reference	M 112 955 112 200 02 01	112 200 04 01	112 200 11 01	112 200 14 01				50 005 457
05.2002→ Reference	M 112 955 112 200 05 01	112 200 10 01	112 200 12 01	112 200 15 01				50 005 456
CLK 430 (208)								42
08.1998→01.2003 Reference 	M 113 943 112 200 02 01 →000206 / 000200 (USA)	112 200 04 01	112 200 11 01	112 200 14 01				50 005 457
08.1998→01.2003 Reference 	M 113 943 112 200 05 01 000207 / 000201 (usa)→	112 200 10 01	112 200 12 01	112 200 15 01				50 005 456
CLK 500 (209)								43
05.2002→06.2006 Reference	M 113 968 112 200 02 01	112 200 04 01	112 200 11 01	112 200 14 01				50 005 457
05.2002→06.2006 Reference	M 113 968 112 200 05 01	112 200 10 01	112 200 12 01	112 200 15 01				50 005 456









M



CLK 55 AMG (208)										44
05.1999→04.2002	M 113	984 AMG								
Reference	112 200 02 01	112 200 04 01	112 200 11 01	112 200 14 01						50 005 457
CLK 55 AMG (209)										45
09.2002→	M 113	987 AMG								
Reference	112 200 02 01	112 200 04 01	112 200 11 01	112 200 14 01						50 005 457
CLS 500 (219)										46
06.2004→06.2006	M 113	967								
Reference	112 200 02 01	112 200 04 01	112 200 11 01	112 200 14 01						50 005 457
06.2004→06.2006	M 113	967								
Reference	112 200 05 01	112 200 10 01	112 200 12 01	112 200 15 01						50 005 456
E 200 (124)										47
07.1993→06.1998	M 111	940								
Reference	111 200 04 01	111 200 40 01								50 005 433
E 200 (210)										48
06.1995→01.2003	M 111	942								
Reference	111 200 04 01	111 200 40 01								50 005 433
E 200 Kompressor (210)										49
06.1995→01.2003	M 111	947								
Reference	111 200 23 01									50 005 491
09.2000→01.2003	M 111	957								
Reference	111 200 42 01									50 005 908 <small>NEW</small>
E 200 D (124)										50
07.1993→06.1995	OM 601	912								
Reference	601 200 02 20	601 200 07 20	601 200 09 20							50 005 031
	156813 / 014321 (autom.)→195582									
07.1993→06.1995	OM 601	912								
Reference	602 200 00 20	602 200 01 20	602 200 02 20							50 005 439
	195583→									

M



E 200 D (210)					51
03.1997→06.1999 Reference	OM 604 601 200 11 20	917 (POR)			50 005 036
E 200 CDI (210)					52
07.1998→06.1999 Reference	OM 611 611 200 02 01	961 611 200 12 01			50 005 455
E 200 CDI (211)					53
07.2002→07.2006 Reference	OM 646 646 200 03 01	951			50 005 909 <small>NEW</small>
E 220 (124)					54
07.1993→06.1998 Reference	M 111 111 200 04 01	960 111 200 40 01			50 005 433
E 220 D (210)					55
06.1995→06.1999 Reference	OM 604 601 200 11 20	912			50 005 036
E 220 CDI (210)					56
06.1999→01.2003 Reference	OM 611 611 200 02 01	961 611 200 12 01			50 005 455
E 220 CDI (211)					57
03.2002→03.2006 Reference	OM 646 646 200 03 01	961			50 005 909 <small>NEW</small>
E 230 (210)					58
06.1995→08.1997 Reference	M 111 111 200 04 01	970 111 200 40 01			50 005 433
E 240 (210)					59
06.1997→08.2000 Reference	M 112 112 200 02 01 →036808 / 033140 (USA)	911 112 200 04 01 112 200 11 01 112 200 14 01			50 005 457

M



06.1997→08.2000 Reference 	M 112 911 112 200 05 01 112 200 10 01 036809 / 033141 (usa)→	112 200 12 01	112 200 15 01				50 005 456	
E 240 (211)							60	
03.2002→ Reference	M 112 912 112 200 02 01	112 200 04 01	112 200 11 01	112 200 14 01			50 005 457	
03.2002→ Reference	M 112 912 112 200 05 01	112 200 10 01	112 200 12 01	112 200 15 01			50 005 456	
E 240.2.6 (210)							61	
06.1999→01.2003 Reference	M 112 914 112 200 02 01	112 200 04 01	112 200 11 01	112 200 14 01			50 005 457	
06.1999→01.2003 Reference	M 112 914 112 200 05 01	112 200 10 01	112 200 12 01	112 200 15 01			50 005 456	
M	E 240 2.6 (211)							62
03.2002→03.2005 Reference	M 112 913 112 200 02 01	112 200 04 01	112 200 11 01	112 200 14 01			50 005 457	
03.2002→03.2005 Reference	M 112 913 112 200 05 01	112 200 10 01	112 200 12 01	112 200 15 01			50 005 456	
E 250 D (124)							63	
07.1993→05.1996 Reference	OM 605 911 602 200 00 20	602 200 01 20	602 200 02 20				50 005 439	
E 250 D (210)							64	
06.1995→06.1999 Reference	OM 605 912 602 200 00 20	602 200 01 20	602 200 02 20				50 005 439	
E 250 D Turbo (124)							65	
07.1993→05.1995 Reference 	OM 602 962 602 200 00 20 →033729 / 020852 (autom.)	602 200 01 20	602 200 02 20				50 005 439	



07.1993→05.1995 Reference 	OM 602 962 605 200 01 20 605 200 03 20 033730 / 020853 (autom.)→	605 200 05 20	605 200 08 20				50 005 490
E 250 D Turbo (210)							66
09.1997→06.1999 Reference	OM 605 962 605 200 01 20 605 200 03 20	605 200 05 20	605 200 08 20				50 005 490
E 270 CDI (210)							67
06.1999→01.2003 Reference	OM 612 961 611 200 02 01 611 200 12 01						50 005 455
E 270 CDI (211)							68
03.2002→03.2005 Reference	OM 647 961 646 200 03 01						50 005 909 NEW
E 280 (124)							69
07.1993→05.1996 Reference	M 104 942 104 200 28 01 104 200 45 01	104 200 49 01					50 005 434
07.1993→05.1996 Reference	M 104 942 104 200 33 01 104 200 44 01	104 200 47 01					50 005 436
E 280 (210)							70
06.1995→02.1997 Reference	M 104 942 104 200 28 01 104 200 45 01	104 200 49 01					50 005 434
06.1995→01.2003 Reference 	M 112 921 112 200 02 01 112 200 04 01 →036808 / 033140 (USA)	112 200 11 01	112 200 14 01				50 005 457
06.1995→01.2003 Reference 	M 112 921 112 200 05 01 112 200 10 01 036809 / 033141 (usa)→	112 200 12 01	112 200 15 01				50 005 456

M





06.1995→02.1997 Reference	M 104 104 200 33 01	942, 945 104 200 44 01	104 200 47 01			50 005 436
E 290 D Turbo (210)						71
01.1996→06.1999 Reference	OM 602 602 200 00 20	982 602 200 01 20	602 200 02 20			50 005 439
E 300 (124)						72
07.1993→06.1995 Reference 	M 103 103 200 07 01	985 103 200 17 01				50 005 442
	mit Thermostat/with thermostat/avec thermostat/con termostato/c termostatom 00583 / 002104 (autom.)→					
07.1993→06.1995 Reference 	M 103 103 200 20 01	985 103 200 26 01	103 200 37 01			50 005 446
	ohne Thermostat/without thermostat/sans thermostat/sin termostato/без термостата 00583 / 002104 (autom.)→					
07.1993→06.1995 Reference 	M 103 103 200 04 01	985				50 005 440
	ohne Thermostat/without thermostat/sans thermostat/sin termostato/без термостата →000582 / 002103 (autom.)					
E 300 D (124)						73
07.1993→05.1996 Reference	OM 606 602 200 00 20	910 602 200 01 20	602 200 02 20			50 005 439
E 300 D (210)						74
06.1995→08.1997 Reference	OM 606 602 200 00 20	912 602 200 01 20	602 200 02 20			50 005 439
E 300 D Turbo (124)						75
07.1993→05.1996 Reference 	OM 603 602 200 00 20	960, 963 602 200 01 20	602 200 02 20			50 005 439
	OM 603.960: →054622					
07.1993→05.1996 Reference 	OM 603 605 200 01 20	960 605 200 03 20	605 200 05 20	605 200 08 20		50 005 490
	054623→					
E 300 D Turbo (210)						76
03.1997→06.1999 Reference	OM 606 605 200 01 20	962 605 200 03 20	605 200 05 20	605 200 08 20		50 005 490

M







E 320 (124)

77

05.1993→06.1998	M 104 992							
Reference	104 200 28 01	104 200 45 01	104 200 49 01					50 005 434
05.1993→06.1998	M 104 992							
Reference	104 200 33 01	104 200 44 01	104 200 47 01					50 005 436

E 320 (210)



78

06.1995→02.1997	M 104 995							
Reference	104 200 28 01	104 200 45 01	104 200 49 01					50 005 434
03.1997→01.2003	M 112 941							
Reference	112 200 02 01	112 200 04 01	112 200 11 01	112 200 14 01				50 005 457
	→036808 / 033140 (USA)							
03.1997→01.2003	M 112 941							
Reference	112 200 05 01	112 200 10 01	112 200 12 01	112 200 15 01				50 005 456
	036809 / 033141 (usa)→							
06.1995→02.1997	M 104 995							
Reference	104 200 33 01	104 200 44 01	104 200 47 01					50 005 436

M

E 320 (211)

79

03.2002→03.2005	M 112 949							
Reference	112 200 02 01	112 200 04 01	112 200 11 01	112 200 14 01				50 005 457
03.2002→03.2005	M 112 949							
Reference	112 200 05 01	112 200 10 01	112 200 12 01	112 200 15 01				50 005 456

E 320 CDI (210)



80

06.1999→01.2003	OM 613 961							
Reference	613 200 07 01							50 005 767



E 420 (124)

81

07.1993→06.1995	M 119	975						
Reference	119 200 04 01	119 200 09 01	119 200 15 01					50 005 430
	→020771							
								
07.1993→06.1995	M 119	975						
Reference	119 200 21 01							50 005 454
	020772→							
								



E 420 (210)

82

01.1996→08.1997	M 119	985						
Reference	119 200 21 01							50 005 454
								



E 430 (210)

83

06.1997→01.2003	M 113	940						
Reference	112 200 02 01	112 200 04 01	112 200 11 01	112 200 14 01				50 005 457
	→000206 / 000200 (USA)							
								
06.1997→01.2003	M 113	940						
Reference	112 200 05 01	112 200 10 01	112 200 12 01	112 200 15 01				50 005 456
	000207 / 000201 (usa)→							
								



E 500 (124)

84

07.1993→06.1995	M 119	974						
Reference	119 200 04 01	119 200 09 01	119 200 15 01					50 005 430
	→010204							
								
07.1993→06.1995	M 119	974						
Reference	119 200 21 01							50 005 454
	010205→							
								

E 500 (211)

85

03.2002→03.2006	M 113	967						
Reference	112 200 02 01	112 200 04 01	112 200 11 01	112 200 14 01				50 005 457
								
03.2002→03.2006	M 113	967						
Reference	112 200 05 01	112 200 10 01	112 200 12 01	112 200 15 01				50 005 456
								

M



E 55 AMG (210)

86

09.1997→01.2003 M 113 980 AMG
 Reference 112 200 02 01 112 200 04 01 112 200 11 01 112 200 14 01

**50 005 457**

G 270 CDI (461)

87

11.1999→ OM 612 963, 966
 Reference 611 200 02 01 611 200 12 01

**50 005 455**

G 300 (463)

88

08.1993→10.1994 M 103 987
 Reference 103 200 07 01 103 200 17 01
 mit Thermostat/with thermostat/avec thermostat/con termostato/c termostatom

**50 005 442**

08.1993→10.1994 M 103 987
 Reference 103 200 20 01 103 200 26 01 103 200 37 01
 ohne Thermostat/without thermostat/sans thermostat/sin termostato/без термостата

**50 005 446**

G 300 D (463)

89

08.1993→10.1994 OM 603 931
 Reference 602 200 00 20 602 200 01 20 602 200 02 20

**50 005 439**

G 300 D Turbo (463)

90

09.1996→12.2000 OM 606 964
 Reference 605 200 01 20 605 200 03 20 605 200 05 20 605 200 08 20

**50 005 490**

G 320 (460)

91

09.1994→ M 104 995
 Reference 104 200 28 01 104 200 45 01 104 200 49 01

**50 005 434**

09.1994→ M 104 995
 Reference 104 200 33 01 104 200 44 01 104 200 47 01

**50 005 436**

G 320 (463)

92

12.1997→09.2006 M 112 945
 Reference 112 200 02 01 112 200 04 01 112 200 11 01 112 200 14 01
 →036808 / 033140 (USA)

**50 005 457****M**





08.1993→11.1997 Reference	M 104 996 104 200 27 01	104 200 32 01	104 200 48 01			50 005 437
12.1997→09.2006 Reference	M 112 945 112 200 05 01 036809 / 033141 (usa)→	112 200 10 01	112 200 12 01	112 200 15 01		50 005 456
G 350 D Turbo (463)						93
08.1993→06.1996 Reference	OM 603 972 602 200 00 20 →004348	602 200 01 20	602 200 02 20			50 005 439
08.1993→06.1996 Reference	OM 603 972 605 200 01 20 004349→	605 200 03 20	605 200 05 20	605 200 08 20		50 005 490
G 500 (463)						94
08.1993→10.1994 Reference	M 117 965 116 200 11 01 116 200 16 01	116 200 12 01 116 200 17 01	116 200 13 01	116 200 14 01		50 005 427
04.1998→ Reference	M 113 962 112 200 02 01 →000200	112 200 04 01	112 200 11 01	112 200 14 01		50 005 457
04.1998→ Reference	M 113 962 112 200 05 01 000201→	112 200 10 01	112 200 12 01	112 200 15 01		50 005 456
G 55 AMG (463)						95
08.1999→06.2002 Reference	M 113 982 AMG 112 200 02 01	112 200 04 01	112 200 11 01	112 200 14 01		50 005 457
ML 230 (163)						96
03.1998→06.2000 Reference	M 111 977 111 200 04 01	111 200 40 01				50 005 433
ML 270 CDI (163)						97
11.1999→06.2005 Reference	OM 612 963 611 200 02 01	611 200 12 01				50 005 455

M





ML 320 (163)

98

03.1998→07.2002	M 112 942						
Reference	112 200 02 01	112 200 04 01	112 200 11 01	112 200 14 01			50 005 457
	→036808 / 033140 (USA)						
03.1998→07.2002	M 112 942						
Reference	112 200 05 01	112 200 10 01	112 200 12 01	112 200 15 01			50 005 456
	036809 / 03314 (usa)→						

ML 350 3.7 (163)

99

08.2002→06.2005	M 112 970						
Reference	112 200 02 01	112 200 04 01	112 200 11 01	112 200 14 01			50 005 457
08.2002→06.2005	M 112 970						
Reference	112 200 05 01	112 200 10 01	112 200 12 01	112 200 15 01			50 005 456

ML 430 (163)

100

06.1998→07.2002	M 113 942						
Reference	112 200 02 01	112 200 04 01	112 200 11 01	112 200 14 01			50 005 457

ML 500 (163)

101

09.2001→06.2005	M 113 965						
Reference	112 200 02 01	112 200 04 01	112 200 11 01	112 200 14 01			50 005 457



ML 55 AMG (163)

102

03.2000→06.2005	M 113 981 AMG						
Reference	112 200 02 01	112 200 04 01	112 200 11 01	112 200 14 01			50 005 457

S 280 (140)

103

06.1993→09.1998	M 104 944						
Reference	104 200 13 01	104 200 30 01	104 200 46 01				50 005 435
	→000508 / 004534 (autom.)						
06.1993→09.1998	M 104 944						
Reference	104 200 27 01	104 200 32 01	104 200 48 01				50 005 437
	000509 / 004535 (autom.)→						

M



S 280 (220)

104

01.1999→08.2005	M 112 922						
Reference	112 200 02 01	112 200 04 01	112 200 11 01	112 200 14 01			50 005 457
	→036808 / 033140 (USA)						

01.1999→08.2005	M 112 922						
Reference	112 200 05 01	112 200 10 01	112 200 12 01	112 200 15 01			50 005 456
	036809 / 033141 (usa)→						

S 300 3.2 (140)

105

03.1991→04.1993	M 104 994						
Reference	104 200 13 01	104 200 30 01	104 200 46 01				50 005 435
	→020623 (autom.)						

03.1991→04.1993	M 104 994						
Reference	104 200 27 01	104 200 32 01	104 200 48 01				50 005 437
	020624 (autom.)→						

S 300 D Turbo (140)

106

06.1996→09.1998	OM 606 961						
Reference	605 200 01 20	605 200 03 20	605 200 05 20	605 200 08 20			50 005 490

M

S 320 (140)

107

03.1993→09.1998	M 104 990, 994						
Reference	104 200 13 01	104 200 30 01	104 200 46 01				50 005 435
	M 104.990: →000259 / 017742 (autom.) M 104.994: →020623 (autom.)						

03.1993→09.1998	M 104 990, 994						
Reference	104 200 27 01	104 200 32 01	104 200 48 01				50 005 437
	M 104.990: 000260 / 017743 (autom.)→ M 104.994: 020624 (autom.)→						

S 320 (220)

108

10.1998→08.2002	M 112 944						
Reference	112 200 02 01	112 200 04 01	112 200 11 01	112 200 14 01			50 005 457
	→036808 / 033140 (USA)						

10.1998→08.2002	M 112 944						
Reference	112 200 05 01	112 200 10 01	112 200 12 01	112 200 15 01			50 005 456
	036809 / 033141 (usa)→						



S 350 3.7 (220)

109

09.2002→08.2005	M 112	972, 975						
Reference	112 200 02 01	112 200 04 01	112 200 11 01	112 200 14 01				50 005 457
09.2002→08.2005	M 112	972, 975						
Reference	112 200 05 01	112 200 10 01	112 200 12 01	112 200 15 01				50 005 456

S 350 D Turbo (140)

110

06.1993→06.1996	OM 603	971						
Reference	602 200 00 20 →018738	602 200 01 20	602 200 02 20					50 005 439
06.1993→06.1996	OM 603	971						
Reference	605 200 01 20 018739→	605 200 03 20	605 200 05 20	605 200 08 20				50 005 490

S 370 (220)

111

09.2002→08.2005	M 112	972						
Reference	112 200 02 01	112 200 04 01	112 200 11 01	112 200 14 01				50 005 457
09.2002→08.2005	M 112	972						
Reference	112 200 05 01	112 200 10 01	112 200 12 01	112 200 15 01				50 005 456

S 420 (140)

112

06.1993→09.1998	M 119	971						
Reference	119 200 04 01 →026750	119 200 09 01	119 200 15 01					50 005 430
06.1993→08.1999	M 119	971, 981						
Reference	119 200 21 01 M 119.971: 026751→							50 005 454

S 430 (220)

113

10.1998→08.2005	M 113	941, 948						
Reference	112 200 02 01 M 113.941: →000206 / 000200 (USA)	112 200 04 01	112 200 11 01	112 200 14 01				50 005 457
10.1998→08.2005	M 113	941, 948						
Reference	112 200 05 01 M 113.941: 000207 / 000201 (usa)→	112 200 10 01	112 200 12 01	112 200 15 01				50 005 456

M



S 500 (129)

114

09.1995→05.1998 M 119 982

Reference 119 200 21 01
013778→**50 005 454**

S 500 (140)

115

06.1993→09.1998 M 119 970

Reference 119 200 04 01 119 200 09 01 119 200 15 01
→056885**50 005 430**

06.1993→09.1998 M 119 970, 980

Reference 119 200 21 01
M 119.970: 056886→**50 005 454**

S 500 (220)

116

10.1998→08.2005 M 113 960, 966

Reference 112 200 02 01 112 200 04 01 112 200 11 01 112 200 14 01
M 113.960: →000200**50 005 457****M**

10.1998→08.2005 M 113 960, 966

Reference 112 200 05 01 112 200 10 01 112 200 12 01 112 200 15 01
M 113.960: 000201→**50 005 456**

S 55 AMG (220)

117

08.2000→08.2002 M 113 986 AMG

Reference 112 200 02 01 112 200 04 01 112 200 11 01 112 200 14 01

**50 005 457**

SL 280 (129)

118

06.1998→08.2001 M 112 923

Reference 112 200 02 01 112 200 04 01 112 200 11 01 112 200 14 01
→036808 / 033140 (USA)**50 005 457**

06.1998→08.2001 M 112 923

Reference 112 200 05 01 112 200 10 01 112 200 12 01 112 200 15 01
036809 / 033141 (usa)→**50 005 456**

07.1993→05.1998 M 104 943

Reference 104 200 33 01 104 200 44 01 104 200 47 01

**50 005 436**



SL 320 (129)

119

07.1993→05.1998 Reference	M 104 991 104 200 28 01 104 200 45 01 104 200 49 01		50 005 434
06.1998→08.2001 Reference	M 112 943 112 200 02 01 112 200 04 01 112 200 11 01 112 200 14 01 →036808 / 033140 (USA)		50 005 457
06.1998→08.2001 Reference	M 112 943 112 200 05 01 112 200 10 01 112 200 12 01 112 200 15 01 036809 / 033141 (usa)→		50 005 456
07.1993→05.1998 Reference	M 104 991 104 200 33 01 104 200 44 01 104 200 47 01		50 005 436

SL 350 3.7 (230)

120

03.2003→12.2005 Reference	M 112 973 112 200 02 01 112 200 04 01 112 200 11 01 112 200 14 01		50 005 457
03.2003→12.2005 Reference	M 112 973 112 200 05 01 112 200 10 01 112 200 12 01 112 200 15 01		50 005 456

M

SL 500 (129)

121

06.1998→08.2001 Reference	M 113 961 112 200 02 01 112 200 04 01 112 200 11 01 112 200 14 01 →000206 / 000200 (USA)		50 005 457
06.1998→08.2001 Reference	M 113 961 112 200 05 01 112 200 10 01 112 200 12 01 112 200 15 01 000207 / 000201 (usa)→		50 005 456
07.1993→05.1998 Reference	M 119 982 119 200 21 01 013778→		50 005 454

SL 500 (230)

122

10.2001→12.2005 Reference	M 113 963 112 200 02 01 112 200 04 01 112 200 11 01 112 200 14 01		50 005 457
------------------------------	--	--	------------



10.2001→12.2005 Reference	M 113 112 200 05 01	963 112 200 10 01	112 200 12 01	112 200 15 01				50 005 456
SLK 200 (170)								123
09.1996→01.2000 Reference	M 111 111 200 04 01	946 111 200 40 01						50 005 433
SLK 200 Kompressor (170)								124
09.1996→01.2000 Reference	M 111 111 200 23 01	943						50 005 491
02.2000→03.2004 Reference	M 111 111 200 42 01	958						50 005 908 <small>NEW</small>
SLK 230 Kompressor (170)								125
09.1996→01.2000 Reference	M 111 111 200 23 01	973 (JPN)						50 005 491
02.2000→03.2004 Reference	M 111 111 200 42 01	983						50 005 908 <small>NEW</small>
SLK 320 (170)								126
06.1999→03.2004 Reference	M 112 112 200 02 01	947 112 200 04 01	112 200 11 01	112 200 14 01				50 005 457
06.1999→03.2004 Reference	M 112 112 200 05 01	947 112 200 10 01	112 200 12 01	112 200 15 01				50 005 456
Sprinter 208 D 2.3								127
02.1995→03.2000 Reference	OM 601 602 200 00 20	943 602 200 01 20	602 200 02 20					50 005 439
Sprinter 210 D 2.9								128
01.1997→03.2000 Reference	OM 602 602 200 00 20	986 602 200 01 20	602 200 02 20					50 005 439

M



Sprinter 211 CDI

129

04.2000→ OM 611 981
 Reference 611 200 05 01 611 200 11 01



50 005 782
 NEW

Sprinter 212 D 2.9

130

02.1995→03.2000 OM 602 980
 Reference 602 200 00 20 602 200 01 20 602 200 02 20



50 005 439

Sprinter 213 CDI

131

04.2000→ OM 611 981
 Reference 611 200 05 01 611 200 11 01



50 005 782
 NEW

Sprinter 214 2.3

132

02.1995→ M 111 979
 Reference 111 200 22 01



50 005 164

Sprinter 216 CDI

133

04.2000→ OM 612 981
 Reference 611 200 05 01 611 200 11 01



50 005 782
 NEW

M

Sprinter 308 CDI

134

Reference OM 647 981
 647 200 01 01



50 005 010
 NEW

Sprinter 308 D 2.3

135

02.1995→03.2000 OM 601 943
 Reference 602 200 00 20 602 200 01 20 602 200 02 20



50 005 439

Sprinter 310 D 2.9

136

02.1995→03.2000 OM 602 986
 Reference 602 200 00 20 602 200 01 20 602 200 02 20



50 005 439

Sprinter 311 CDI

137

04.2000→ OM 611 981
 Reference 611 200 05 01 611 200 11 01



50 005 782
 NEW



Reference	OM 647 981 647 200 01 01			50 005 010 NEW
Sprinter 312 D 2.9 138				
02.1995→03.2000 Reference	OM 602 980 602 200 00 20 602 200 01 20 602 200 02 20			50 005 439
Sprinter 313 CDI 139				
04.2000→ Reference	OM 611 981 611 200 05 01 611 200 11 01			50 005 782 NEW
Sprinter 314 2.3 140				
02.1995→ Reference	M 111 979 111 200 22 01			50 005 164
Sprinter 314 CDI 141				
Reference	OM 647 981 647 200 01 01			50 005 010 NEW
Sprinter 316 CDI 142				
04.2000→ Reference	OM 612 981 611 200 05 01 611 200 11 01			50 005 782 NEW
Sprinter 408 CDI 143				
Reference	OM 647 981 647 200 01 01			50 005 010 NEW
Sprinter 408 D 2.3 144				
02.1995→03.2000 Reference	OM 601 943 602 200 00 20 602 200 01 20 602 200 02 20			50 005 439
Sprinter 410 D 2.9 145				
02.1995→ Reference	OM 602 980, 986 602 200 00 20 602 200 01 20 602 200 02 20			50 005 439

M



Sprinter 411 CDI

146

04.2000→ Reference	OM 611 981 611 200 05 01 611 200 11 01			50 005 782 <small>NEW</small>
-----------------------	---	---	--	---

Reference	OM 647 981 647 200 01 01			50 005 010 <small>NEW</small>
-----------	-----------------------------	---	--	---

Sprinter 412 D 2.9

147

02.1995→03.2000 Reference	OM 602 980 602 200 00 20 602 200 01 20 602 200 02 20			50 005 439
------------------------------	---	---	--	-------------------

Sprinter 413 CDI

148

04.2000→ Reference	OM 611 981 611 200 05 01 611 200 11 01			50 005 782 <small>NEW</small>
-----------------------	---	--	--	---

Reference	OM 647 981 647 200 01 01			50 005 010 <small>NEW</small>
-----------	-----------------------------	---	--	---

M

Sprinter 414 2.3

149

02.1995→ Reference	M 111 979 111 200 22 01			50 005 164
-----------------------	----------------------------	---	--	-------------------

Sprinter 414 CDI

150

Reference	OM 647 981 647 200 01 01			50 005 010 <small>NEW</small>
-----------	-----------------------------	---	--	---

Sprinter 416 CDI

151

04.2000→ Reference	OM 612 981 611 200 05 01 611 200 11 01			50 005 782 <small>NEW</small>
-----------------------	---	---	--	---

Reference	OM 647 981 647 200 01 01			50 005 010 <small>NEW</small>
-----------	-----------------------------	---	--	---



Sprinter 616 CDI

152

02.2001→
Reference OM 612 981
611 200 05 01 611 200 11 01



50 005 782
NEW

V 200 (638)

153

04.1996→09.2003 M 111 948
Reference 111 200 21 01 111 200 38 01
→002353 / 000132 (autom.)



50 005 474

04.1996→09.2003 M 111 948, 950
Reference 111 200 24 01 111 200 39 01
M 111.948: 002354 / 000133 (autom.)→



50 005 475

V 200 CDI 2.2 (638)

154

06.1999→08.2003 OM 611 980
Reference 611 200 04 01 611 200 10 01



50 005 776

V 220 CDI (638)

155

06.1999→08.2003 OM 611 980
Reference 611 200 04 01 611 200 10 01



50 005 776

V 230 (638)

156

04.1996→09.2003 M 111 978
Reference 111 200 21 01 111 200 38 01
→001594 / 000128 (autom.)



50 005 474

04.1996→09.2003 M 111 978, 980
Reference 111 200 24 01 111 200 39 01
M 111.978: 001595 / 000129 (autom.)→



50 005 475

V 230 TD (638)

157

04.1996→08.2003 OM 601 970
Reference 602 200 00 20 602 200 01 20 602 200 02 20



50 005 439

V 280 (638)

158

04.1996→09.2003 M 104 900
Reference 000 200 03 01



50 005 165

M



Vaneo 1.6

159

02.2002→08.2005 M 166 961
 Reference 166 200 06 20 166 200 07 20



50 005 471

Vaneo 1.9

160

02.2002→08.2005 M 166 991
 Reference 166 200 06 20 166 200 07 20



50 005 471

Vario 512 D 2.9

161

09.1996→ OM 602 984
 Reference 602 200 00 20 602 200 01 20 602 200 02 20



50 005 439

Vario 612 D 2.9

162

09.1996→ OM 602 984-985
 Reference 602 200 00 20 602 200 01 20 602 200 02 20



50 005 439

Vario 612 D 4.2

163

09.1996→ OM 904 908, 914, 923, 936, 955
 Reference 904 200 04 01 904 200 06 01 904 200 08 01 904 200 20 01
 904 200 22 01 904 200 26 01 904 200 49 01 904 201 02 01
 904 201 07 01



50 005 627

M

Vario 614 D 2.9

164

09.1996→ OM 602 984-985
 Reference 602 200 00 20 602 200 01 20 602 200 02 20



50 005 439

Vario 614 D 4.2

165

09.1996→ OM 904 908, 914, 923, 936, 955
 Reference 904 200 04 01 904 200 06 01 904 200 08 01 904 200 20 01
 904 200 22 01 904 200 26 01 904 200 49 01 904 201 02 01
 904 201 07 01



50 005 627

Vario 615 D 4.2

166

12.1995→ OM 904 923, 936
 Reference 904 200 04 01 904 200 06 01 904 200 08 01 904 200 20 01
 904 200 22 01 904 200 26 01 904 200 49 01 904 201 02 01
 904 201 07 01



50 005 627

Vario 810 D 2.9

167

09.1996→ OM 602 984-985
 Reference 602 200 00 20 602 200 01 20 602 200 02 20



50 005 439

Vario 810 D 4.2

168

09.1996→ OM 904 904, 923, 961
 Reference 904 200 04 01 904 200 06 01 904 200 08 01 904 200 20 01
 904 200 22 01 904 200 26 01 904 200 49 01 904 201 02 01
 904 201 07 01



50 005 627



Vario 812 D 2.9

169

09.1996→
Reference OM 602 984-985
602 200 00 20 602 200 01 20 602 200 02 20

**50 005 439**

Vario 812 D 4.2

170

09.1996→
Reference OM 904 904, 908, 914, 923, 936, 955
904 200 04 01 904 200 06 01 904 200 08 01 904 200 20 01
904 200 22 01 904 200 26 01 904 200 49 01 904 201 02 01
904 201 07 01

**50 005 627**

Vario 814 D 2.9

171

09.1996→
Reference OM 602 984-985
602 200 00 20 602 200 01 20 602 200 02 20

**50 005 439**

Vario 814 D 4.2

172

09.1996→
Reference OM 904 904, 906, 908, 914, 923, 936, 955
904 200 04 01 904 200 06 01 904 200 08 01 904 200 20 01
904 200 22 01 904 200 26 01 904 200 49 01 904 201 02 01
904 201 07 01

**50 005 627**

Vario 815 D 2.9

173

09.1996→
Reference OM 602 984-985
602 200 00 20 602 200 01 20 602 200 02 20

**50 005 439****M**

Vario 815 D 4.2

174

09.1996→
Reference OM 904 904, 908, 914, 923, 936, 955
904 200 04 01 904 200 06 01 904 200 08 01 904 200 20 01
904 200 22 01 904 200 26 01 904 200 49 01 904 201 02 01
904 201 07 01

**50 005 627**

Viano 110 D 2.3

175

02.1996→
Reference OM 601 970
602 200 00 20 602 200 01 20 602 200 02 20

**50 005 439**

Viano 200 (Italy)

176

1998 →
Reference M 111 948
111 200 21 01 111 200 38 01
→002353 / 000132 (autom.)

**50 005 474**

1995 →
Reference M 111 948, 950
111 200 24 01 111 200 39 01
M 111.948: 002354 / 000133 (autom.)→

**50 005 475**

Viano 230 (Italy)

177

04.1996→
Reference M 111 978
111 200 21 01 111 200 38 01
→001594 / 000128 (autom.)

**50 005 474**



04.1996→ Reference 	M 111 978, 980 111 200 24 01 111 200 39 01 M 111.978: 001595 / 000129 (autom.)→			50 005 475
Vito 108 CDI 2.2				178
04.1999→ Reference	OM 611 980 611 200 04 01 611 200 10 01			50 005 776
Vito 108 D 2.3				179
11.1995→10.2003 Reference	OM 601 942 602 200 00 20 602 200 01 20 602 200 02 20			50 005 439
Vito 110 CDI 2.2				180
04.1999→ Reference	OM 611 980 611 200 04 01 611 200 10 01			50 005 776
Vito 110 D 2.3				181
11.1995→ Reference	OM 601 970 602 200 00 20 602 200 01 20 602 200 02 20			50 005 439
Vito 112 CDI 2.2				182
04.1999→ Reference	OM 611 980 611 200 04 01 611 200 10 01			50 005 776
Vito 113 2.0				183
11.1995→10.2003 Reference 	M 111 948 111 200 21 01 111 200 38 01 →002353 / 000132 (autom.)			50 005 474
11.1995→ Reference	M 111 979 111 200 22 01			50 005 164
11.1995→10.2003 Reference 	M 111 948 111 200 24 01 111 200 39 01 002354 / 000133 (autom.)→			50 005 475

M



Vito 114 2.0

184

11.1995→ Reference 	M 111 978 111 200 21 01 111 200 38 01 →001594 / 000128 (autom.)			50 005 474
11.1995→ Reference 	M 111 978, 980 111 200 24 01 111 200 39 01 M 111.978: 001595 / 000129 (autom.)→			50 005 475

190 2.0 (201)

185

10.1982→08.1986 Reference 	M 102 921 102 200 03 01 102 200 03 20 102 200 04 01 102 200 04 20 102 200 11 01 102 200 43 01 →123428 / 036023 (autom.)			50 005 028
10.1982→08.1986 Reference 	M 102 921, 938 102 200 01 20 102 200 08 01 102 200 09 01 102 200 42 01 M 102.921: 123429 / 036024 (autom.)→			50 005 029
10.1982→05.1990 Reference	M 102 924 102 200 05 20 102 200 06 20 102 200 09 20 102 200 39 01 102 200 49 01 102 200 50 01			50 005 425

M

190 C (110)

186

06.1961→08.1965 Reference	M 121 924 115 200 01 20 115 200 12 20 115 200 16 20 121 200 06 20 121 200 11 20 127 200 01 20 127 200 02 20			50 005 033
------------------------------	---	--	--	------------

190 D (201)

187

09.1983→08.1993 Reference	OM 601 911 601 200 02 20 601 200 07 20 601 200 09 20			50 005 031
------------------------------	---	--	--	------------

190 D 2.5 (201)

188

04.1985→08.1993 Reference	OM 602 911 602 200 00 20 602 200 01 20 602 200 02 20			50 005 439
------------------------------	---	--	--	------------

190 D 2.5 Turbo (201)

189

02.1988→08.1993 Reference	OM 602 961 602 200 00 20 602 200 01 20 602 200 02 20			50 005 439
------------------------------	---	--	--	------------

190 DC (110)

190

04.1961→08.1965 Reference	OM 621 918 110 200 00 20 110 200 02 20 110 200 08 20 110 200 10 20 110 200 20 20 121 200 08 20			50 005 034
------------------------------	--	--	--	------------



04.1961→08.1965 Reference	OM 621 115 200 01 20 121 200 11 20	912, 918 115 200 12 20 127 200 01 20	115 200 16 20 127 200 02 20	121 200 06 20		50 005 033
190 E 1.8 (201)						191
04.1990→08.1993 Reference	M 102 102 200 05 20 102 200 49 01	910, 919 (POR) 102 200 06 20 102 200 50 01	102 200 09 20	102 200 39 01		50 005 425
190 E 2.0 (201)						192
10.1982→06.1993 Reference	M 102 102 200 01 20	961 102 200 08 01	102 200 09 01	102 200 42 01		50 005 029
01.1984→06.1993 Reference	M 102 102 200 05 20 102 200 49 01	962 102 200 06 20 102 200 50 01	102 200 09 20	102 200 39 01		50 005 425
190 E 2.3 (201)						193
09.1983→08.1993 Reference	M 102 102 200 05 20 102 200 49 01	985 102 200 06 20 102 200 50 01	102 200 09 20	102 200 39 01		50 005 425
190 E 2.3-16 (201)						194
09.1985→07.1988 Reference	M 102 102 200 05 20 102 200 49 01	983 102 200 06 20 102 200 50 01	102 200 09 20	102 200 39 01		50 005 425
190 E 2.5-16 (201)						195
08.1988→08.1993 Reference	M 102 102 200 05 20 102 200 49 01	990 102 200 06 20 102 200 50 01	102 200 09 20	102 200 39 01		50 005 425
190 E 2.5-16 EVOLUTION (201)						196
03.1989→08.1993 Reference	M 102 102 200 05 20 102 200 49 01	991-992 102 200 06 20 102 200 50 01	102 200 09 20	102 200 39 01		50 005 425
190 E 2.6 (201)						197
06.1985→08.1992 Reference	M 103 103 200 07 01	942 103 200 17 01	mit Thermostat/with thermostat/avec thermostat/con termostato/c термостатом			50 005 442
06.1985→08.1992 Reference	M 103 103 200 20 01	942 103 200 26 01	103 200 37 01	ohne Thermostat/without thermostat/sans thermostat/sin termostato/без термостата		50 005 446
06.1985→08.1992 Reference	M 103 103 200 06 01 103 200 38 01	942 103 200 19 01	103 200 21 01	103 200 27 01		50 005 447
		ohne Thermostat/without thermostat/sans thermostat/sin termostato/без термостата		für Automatikgetriebe/for automatic gear box/pour boîte de vitesse automatique/para caja de cambios automática/для автоматической коробки передач VT / VTO		

M



200 (110)

198

08.1965→12.1967 M 121 940
 Reference 110 200 00 20 110 200 02 20 110 200 08 20 110 200 10 20
 110 200 20 20 121 200 08 20

**50 005 034**

08.1965→12.1967 M 121 940
 Reference 115 200 01 20 115 200 12 20 115 200 16 20 121 200 06 20
 121 200 11 20 127 200 01 20 127 200 02 20

**50 005 033**

200 (115)

199

01.1968→01.1977 M 115 923, 926
 Lager/bearing/coussinet/cojinete/подшипник: 30 mm
 000026 / 000005 (autom.)→

**50 005 932**

01.1968→01.1977 M 115 923, 926
 Reference 110 200 01 20
 Lager/bearing/coussinet/cojinete/подшипник: 36 mm
 000026 / 000005 (autom.)→

**50 005 032**

01.1968→01.1977 M 115 923, 926
 Reference 115 200 01 20 115 200 12 20 115 200 16 20 121 200 06 20
 121 200 11 20 127 200 01 20 127 200 02 20
 →000025 / 000004 (autom.)

**50 005 033**

01.1968→01.1977 M 115 923, 926
 Reference 110 200 01 20 110 200 09 20 110 200 17 20 115 200 00 20
 115 200 15 20 115 200 18 20 121 200 09 20
 Lager/bearing/coussinet/cojinete/подшипник: 40 mm
 000026 / 000005 (autom.)→

**50 005 035**

200 (123)

200

06.1980→11.1985 M 102 920, 939
 Reference 102 200 03 01 102 200 03 20 102 200 04 01 102 200 04 20
 102 200 11 01 102 200 43 01
 M 102.939: →012089 / 000787 (autom.)→
 M 102.920: →123428 / 036023 (autom.)→

**50 005 028**

02.1976→08.1980 M 115 938-939
 Lager/bearing/coussinet/cojinete/подшипник: 30 mm

**50 005 932**

06.1980→11.1985 M 102 920, 939
 Reference 102 200 01 20 102 200 08 01 102 200 09 01 102 200 42 01
 M 102.939: 012090 / 000788 (autom.)→
 M 102.920: 123429 / 036024 (autom.)→

**50 005 029**

02.1976→08.1980 M 115 938-939
 Reference 110 200 01 20
 Lager/bearing/coussinet/cojinete/подшипник: 36 mm

**50 005 032**

02.1976→08.1980 M 115 938-939
 Reference 110 200 01 20 110 200 09 20 110 200 17 20 115 200 00 20
 115 200 15 20 115 200 18 20 121 200 09 20
 Lager/bearing/coussinet/cojinete/подшипник: 40 mm

**50 005 035****M**



200 (124)

201

01.1985→06.1993	M 102	922							
Reference	102 200 05 20 102 200 49 01	102 200 06 20 102 200 50 01	102 200 09 20	102 200 39 01					50 005 425

200 D (110)

202

07.1965→12.1967	OM 621	918							
Reference	110 200 00 20 110 200 20 20	110 200 02 20 121 200 08 20	110 200 08 20	110 200 10 20					50 005 034

06.1961→12.1967	OM 621	912, 918							
Reference	115 200 01 20 121 200 11 20	115 200 12 20 127 200 01 20	115 200 16 20 127 200 02 20	121 200 06 20					50 005 033

200 D (115)

203

05.1969→01.1976	OM 615	913							
	Lager/bearing/coussinet/cojinete/подшипник: 30 mm								50 005 932

05.1969→01.1976	OM 615	913							
Reference	110 200 01 20	Lager/bearing/coussinet/cojinete/подшипник: 36 mm							50 005 032
									

05.1969→01.1976	OM 615	913							
Reference	115 200 01 20 121 200 11 20	115 200 12 20 127 200 01 20	115 200 16 20 127 200 02 20	121 200 06 20					50 005 033

05.1969→01.1976	OM 615	913							
Reference	110 200 01 20 115 200 15 20	110 200 09 20 115 200 18 20	110 200 17 20 121 200 09 20	115 200 00 20					50 005 035
	Lager/bearing/coussinet/cojinete/подшипник: 40 mm								

200 D (123)

204

02.1976→11.1985	OM 615	940							
	Lager/bearing/coussinet/cojinete/подшипник: 30 mm								50 005 932

02.1976→11.1985	OM 615	940							
Reference	110 200 01 20	Lager/bearing/coussinet/cojinete/подшипник: 36 mm							50 005 032
									

02.1976→11.1985	OM 615	940							
Reference	110 200 01 20 115 200 15 20	110 200 09 20 115 200 18 20	110 200 17 20 121 200 09 20	115 200 00 20					50 005 035
	Lager/bearing/coussinet/cojinete/подшипник: 40 mm								

M



200 D (124)

205

12.1984→06.1993	OM 601 912						
Reference	601 200 02 20	601 200 07 20	601 200 09 20				50 005 031
	156813 / 014321 (autom.)→195582						
12.1984→06.1993	OM 601 912						
Reference	602 200 00 20	602 200 01 20	602 200 02 20				50 005 439
	195583→						

200 E (124)

206

06.1985→06.1993	M 102 963						
Reference	102 200 05 20	102 200 06 20	102 200 09 20	102 200 39 01			50 005 425
	102 200 49 01	102 200 50 01					
09.1992→06.1993	M 111 940						
Reference	111 200 04 01	111 200 40 01					50 005 433

220 (115)

207

01.1968→07.1973	M 115 920, 924						
	Lager/bearing/coussinet/cojinete/подшипник: 30 mm						50 005 932
	000067 / 000013 (autom.)→						
01.1968→07.1973	M 115 920, 924						
Reference	110 200 01 20						50 005 032
	Lager/bearing/coussinet/cojinete/подшипник: 36 mm						
	000067 / 000013 (autom.)→						
01.1968→07.1973	M 115 920, 924						
Reference	115 200 01 20	115 200 12 20	115 200 16 20	121 200 06 20			50 005 033
	121 200 11 20	127 200 01 20	127 200 02 20				
	→000066 / 000012 (autom.)						
01.1968→07.1973	M 115 920, 924						
Reference	110 200 01 20	110 200 09 20	110 200 17 20	115 200 00 20			50 005 035
	115 200 15 20	115 200 18 20	121 200 09 20				
	Lager/bearing/coussinet/cojinete/подшипник: 40 mm						
	000067 / 000013 (autom.)→						

220 B (111)

208

05.1959→08.1965	M 180 940-941, 947						
Reference	115 200 01 20	115 200 12 20	115 200 16 20	121 200 06 20			50 005 033
	121 200 11 20	127 200 01 20	127 200 02 20				

220 D (115)

209

07.1973→03.1979	OM 615 912						
	Lager/bearing/coussinet/cojinete/подшипник: 30 mm						50 005 932
	000149 / 000015 (autom.)→						
07.1973→03.1979	OM 615 912						
Reference	110 200 01 20						50 005 032
	Lager/bearing/coussinet/cojinete/подшипник: 36 mm						
	000149 / 000015 (autom.)→						

M



MERCEDES-BENZ

07.1973→03.1979 Reference	OM 615 912	115 200 01 20 121 200 11 20 →000148 / 000014 (autom.)	115 200 12 20 127 200 01 20	115 200 16 20 127 200 02 20	121 200 06 20	 50 005 033	
07.1973→03.1979 Reference	OM 615 912	110 200 01 20 115 200 15 20 Lager/bearing/coussinete/cojinete/подшипник: 40 mm 000149 / 000015 (autom.)→	110 200 09 20 115 200 18 20	110 200 17 20 121 200 09 20	115 200 00 20	 50 005 035	
220 D (123)						210	
02.1976→03.1979	OM 615 941	Lager/bearing/coussinete/cojinete/подшипник: 30 mm					50 005 932
02.1976→03.1979 Reference	OM 615 941	110 200 01 20 Lager/bearing/coussinete/cojinete/подшипник: 36 mm					50 005 032
02.1976→03.1979 Reference	OM 615 941	110 200 01 20 115 200 15 20 Lager/bearing/coussinete/cojinete/подшипник: 40 mm	110 200 09 20 115 200 18 20	110 200 17 20 121 200 09 20	115 200 00 20	 50 005 035	
220 E (124)						211	
09.1992→06.1993 Reference	M 111 960	111 200 04 01 111 200 40 01					50 005 433
220 S (111)						212	
01.1961→12.1965 Reference	M 129 980-981	110 200 00 20 110 200 20 20	110 200 02 20 121 200 08 20	110 200 08 20	110 200 10 20	 50 005 034	
01.1961→12.1965 Reference	M 127 982, 984	115 200 01 20 121 200 11 20	115 200 12 20 127 200 01 20	115 200 16 20 127 200 02 20	121 200 06 20	 50 005 033	
230 (110)						213	
08.1965→12.1967 Reference	M 180 945, 949-950	115 200 01 20 121 200 11 20	115 200 12 20 127 200 01 20	115 200 16 20 127 200 02 20	121 200 06 20	 50 005 033	
230 (111)						214	
08.1965→12.1967 Reference	M 180 940	115 200 01 20 121 200 11 20	115 200 12 20 127 200 01 20	115 200 16 20 127 200 02 20	121 200 06 20	 50 005 033	

M







230 (123)

215

02.1976→03.1981	M 115 954							50 005 932
	Lager/bearing/coussinet/cojinete/подшипник: 30 mm							
02.1976→03.1981	M 115 954							50 005 032
Reference	110 200 01 20							
	Lager/bearing/coussinet/cojinete/подшипник: 36 mm							
02.1976→03.1981	M 115 954							50 005 035
Reference	110 200 01 20 110 200 09 20 110 200 17 20 115 200 00 20							
	115 200 15 20 115 200 18 20 121 200 09 20							
	Lager/bearing/coussinet/cojinete/подшипник: 40 mm							

230 E (123)

216

04.1980→12.1985	M 102 980							50 005 028
Reference	102 200 03 01 102 200 03 20 102 200 04 01 102 200 04 20							
	102 200 11 01 102 200 43 01							
	→123428 / 036023 (autom.)							
04.1980→12.1985	M 102 980							50 005 029
Reference	102 200 01 20 102 200 08 01 102 200 09 01 102 200 42 01							
	123429 / 036024 (autom.)→							

M

230 E (124)

217

12.1984→08.1992	M 102 982							50 005 425
Reference	102 200 05 20 102 200 06 20 102 200 09 20 102 200 39 01							
	102 200 49 01 102 200 50 01							







230 E 2.8 (114)

218

10.1981→12.1984	M 110 991							50 005 034
Reference	110 200 00 20 110 200 02 20 110 200 08 20 110 200 10 20							
	110 200 20 20 121 200 08 20							

230 G (460)

219

03.1979→03.1982	M 115 973							50 005 932
	Lager/bearing/coussinet/cojinete/подшипник: 30 mm							
03.1979→03.1982	M 115 973							50 005 032
Reference	110 200 01 20							
	Lager/bearing/coussinet/cojinete/подшипник: 36 mm							
03.1979→03.1982	M 115 973							50 005 035
Reference	110 200 01 20 110 200 09 20 110 200 17 20 115 200 00 20							
	115 200 15 20 115 200 18 20 121 200 09 20							
	Lager/bearing/coussinet/cojinete/подшипник: 40 mm							



230 G (461)

220

03.1979→03.1982	M 115	974			
Reference	110 200 01 20	110 200 09 20	110 200 17 20	115 200 00 20	
	115 200 15 20	115 200 18 20	121 200 09 20		
	Lager/bearing/coussinnet/cojinete/подшипник: 40 mm				

**50 005 035**

230 GE (460)

221

04.1982→08.1993	M 102	981, 998			
Reference	102 200 03 01	102 200 03 20	102 200 04 01	102 200 04 20	
	102 200 11 01	102 200 43 01			

**50 005 028**

04.1982→08.1993	M 102	981			
Reference	102 200 01 20	102 200 08 01	102 200 09 01	102 200 42 01	

**50 005 029**

230 GE (461)

222

01.1984→09.1995	M 102	981, 998			
Reference	102 200 03 01	102 200 03 20	102 200 04 01	102 200 04 20	
	102 200 11 01	102 200 43 01			

**50 005 028**

01.1984→08.1193	M 102	981			
Reference	102 200 01 20	102 200 08 01	102 200 09 01	102 200 42 01	

**50 005 029****M**

230 S (111)

223

08.1965→12.1967	M 180	947, 951			
Reference	115 200 01 20	115 200 12 20	115 200 16 20	121 200 06 20	
	121 200 11 20	127 200 01 20	127 200 02 20		

**50 005 033**

230.4 (115)

224

M 115	951, 954
Lager/bearing/coussinnet/cojinete/подшипник: 30 mm	

**50 005 932**

Reference



M 115	951, 954
110 200 01 20	
Lager/bearing/coussinnet/cojinete/подшипник: 36 mm	

**50 005 032**

Reference



M 115	951, 954			
110 200 01 20	110 200 09 20	110 200 17 20	115 200 00 20	
115 200 15 20	115 200 18 20	121 200 09 20		
Lager/bearing/coussinnet/cojinete/подшипник: 40 mm				

**50 005 035**

230.6 (114)

225

M 180	954-955
Lager/bearing/coussinnet/cojinete/подшипник: 30 mm	
M 180.955: 000161 / 000031 (autom.)→	
M 180.954: 007682 / 003564 (autom.)→	

**50 005 932**



01.1968→11.1976 Reference	M 180 954-955 110 200 01 20 Lager/bearing/coussinet/cojinete/подшипник: 36 mm M 180.955: 000161 / 000031 (autom.)→ M 180.954: 007682 / 003564 (autom.)→			50 005 032
01.1968→11.1976 Reference	M 180 954-955 115 200 01 20 115 200 12 20 115 200 16 20 121 200 06 20 121 200 11 20 127 200 01 20 127 200 02 20 M 180.955: →000160 / 000030 (autom.) M 180.954: →007681 / 003563 (autom.)			50 005 033
01.1968→11.1976 Reference	M 180 954-955 110 200 01 20 110 200 09 20 110 200 17 20 115 200 00 20 115 200 15 20 115 200 18 20 121 200 09 20 Lager/bearing/coussinet/cojinete/подшипник: 40 mm M 180.955: 000161 / 000031 (autom.)→ M 180.954: 007682 / 003564 (autom.)→			50 005 035
240 D (115)				226
	OM 616 912, 916 Lager/bearing/coussinet/cojinete/подшипник: 30 mm			50 005 932
Reference	OM 616 912, 916 110 200 01 20 Lager/bearing/coussinet/cojinete/подшипник: 36 mm			50 005 032
Reference	OM 616 912, 916 110 200 01 20 110 200 09 20 110 200 17 20 115 200 00 20 115 200 15 20 115 200 18 20 121 200 09 20 Lager/bearing/coussinet/cojinete/подшипник: 40 mm			50 005 035
240 D (123)				227
02.1976→11.1985	OM 616 912 Lager/bearing/coussinet/cojinete/подшипник: 30 mm			50 005 932
02.1976→11.1985 Reference	OM 616 912 110 200 01 20 Lager/bearing/coussinet/cojinete/подшипник: 36 mm			50 005 032
02.1976→11.1985 Reference	OM 616 912 110 200 01 20 110 200 09 20 110 200 17 20 115 200 00 20 115 200 15 20 115 200 18 20 121 200 09 20 Lager/bearing/coussinet/cojinete/подшипник: 40 mm			50 005 035
240 D (USA) (115)				228
01.1974→09.1976	OM 616 916 Lager/bearing/coussinet/cojinete/подшипник: 30 mm			50 005 932
01.1974→09.1976 Reference	OM 616 916 110 200 01 20 Lager/bearing/coussinet/cojinete/подшипник: 36 mm			50 005 032

M



MERCEDES-BENZ

01.1974→09.1976 Reference 	OM 616 916 110 200 01 20 110 200 09 20 110 200 17 20 115 200 00 20 115 200 15 20 115 200 18 20 121 200 09 20 Lager/bearing/coussinnet/cojinete/подшипник: 40 mm			50 005 035
240 D 3.0 (115)				229
08.1974→11.1976 	OM 617 910 Lager/bearing/coussinnet/cojinete/подшипник: 30 mm			50 005 932
08.1974→11.1976 Reference 	OM 617 910 110 200 01 20 Lager/bearing/coussinnet/cojinete/подшипник: 36 mm			50 005 032
08.1974→11.1976 Reference 	OM 617 910 110 200 01 20 110 200 09 20 110 200 17 20 115 200 00 20 115 200 15 20 115 200 18 20 121 200 09 20 Lager/bearing/coussinnet/cojinete/подшипник: 40 mm			50 005 035
240 GD (460)				230
09.1978→ 	OM 616 936, 938 Lager/bearing/coussinnet/cojinete/подшипник: 30 mm			50 005 932
09.1978→ Reference 	OM 616 936, 938 110 200 01 20 Lager/bearing/coussinnet/cojinete/подшипник: 36 mm			50 005 032
09.1978→ Reference 	OM 616 936, 938 110 200 01 20 110 200 09 20 110 200 17 20 115 200 00 20 115 200 15 20 115 200 18 20 121 200 09 20 Lager/bearing/coussinnet/cojinete/подшипник: 40 mm			50 005 035
240 GD (461)				231
09.1978→ 	OM 616 938 Lager/bearing/coussinnet/cojinete/подшипник: 30 mm			50 005 932
09.1978→ Reference 	OM 616 938 110 200 01 20 Lager/bearing/coussinnet/cojinete/подшипник: 36 mm			50 005 032
09.1978→ Reference 	OM 616 938 110 200 01 20 110 200 09 20 110 200 17 20 115 200 00 20 115 200 15 20 115 200 18 20 121 200 09 20 Lager/bearing/coussinnet/cojinete/подшипник: 40 mm			50 005 035
250 (114)				232
01.1968→08.1972 	M 114 920, 923 Lager/bearing/coussinnet/cojinete/подшипник: 30 mm M 114.923: 000238 / 000008 (autom.)→ M 114.920: 008601 / 006186 (autom.)→			50 005 932

M



01.1968→08.1972 Reference	M 114 110 200 01 20	920, 923				50 005 032
	Lager/bearing/coussinet/cojinete/подшипник: 36 mm M 114.923: 000238 / 000008 (autom.)→ M 114.920: 008601 / 006186 (autom.)→					
01.1968→08.1972 Reference	M 114 115 200 01 20 121 200 11 20	920, 923 115 200 12 20 127 200 01 20	115 200 16 20 127 200 02 20	121 200 06 20		50 005 033
	M 114.923: →000237 / 000007 (autom.) M 114.920: →008600 / 006185 (autom.)					
01.1968→08.1972 Reference	M 114 110 200 01 20 115 200 15 20	920, 923 110 200 09 20 115 200 18 20	110 200 17 20 121 200 09 20	115 200 00 20		50 005 035
	Lager/bearing/coussinet/cojinete/подшипник: 40 mm M 114.923: 000238 / 000008 (autom.)→ M 114.920: 008601 / 006186 (autom.)→					
250 (123)						233
02.1976→07.1985 Reference	M 123 110 200 04 20	920-921 110 200 11 20	110 200 19 20			50 005 038
250 2.8 (114)						234
10.1967→11.1976 Reference	M 130 110 200 00 20 110 200 20 20	923, 933 110 200 02 20 121 200 08 20	110 200 08 20	110 200 10 20		50 005 034
250 C 2.8 (114)						235
10.1981→12.1984 Reference	M 110 110 200 00 20 110 200 20 20	991 110 200 02 20 121 200 08 20	110 200 08 20	110 200 10 20		50 005 034
250 CE (114)						236
04.1969→04.1972 Reference	M 114 110 200 00 20 110 200 20 20	980-981 110 200 02 20 121 200 08 20	110 200 08 20	110 200 10 20		50 005 034
04.1969→04.1972 Reference	M 114 110 200 01 20 115 200 15 20	980-981 110 200 09 20 115 200 18 20	110 200 17 20 121 200 09 20	115 200 00 20		50 005 035
	Lager/bearing/coussinet/cojinete/подшипник: 40 mm					
250 D (124)						237
Reference	OM 602 602 200 00 20	911-912 602 200 01 20	602 200 02 20			50 005 439
250 D Turbo (124)						238
09.1988→06.1993 Reference	OM 602 602 200 00 20	962 602 200 01 20	602 200 02 20			50 005 439
	→033729 / 020852 (autom.)					

M



09.1988→06.1993 Reference 	OM 602 962 605 200 01 20 605 200 03 20 605 200 05 20 605 200 08 20 033730 / 020853 (autom.)→					50 005 490
250 GD (460)						239
09.1987→08.1992 Reference	OM 602 930 602 200 00 20 602 200 01 20 602 200 02 20					50 005 439
250 GD (461)						240
09.1987→07.1993 Reference	OM 602 930, 938-939 602 200 00 20 602 200 01 20 602 200 02 20					50 005 439
250 GD (463)						241
09.1989→07.1993 Reference	OM 602 931 602 200 00 20 602 200 01 20 602 200 02 20					50 005 439
250 S (108)						242
01.1966→12.1969 01.1966→12.1967 Reference	M 108 920, 924 M 129 980 110 200 00 20 110 200 02 20 110 200 08 20 110 200 10 20 110 200 20 20 121 200 08 20					50 005 034
250 SE (111)						243
01.1965→12.1967 Reference	M 129 981 110 200 00 20 110 200 02 20 110 200 08 20 110 200 10 20 110 200 20 20 121 200 08 20					50 005 034
250 SL (113)						244
01.1966→12.1968 Reference	M 129 982 110 200 00 20 110 200 02 20 110 200 08 20 110 200 10 20 110 200 20 20 121 200 08 20					50 005 034
260 E (124)						245
06.1985→10.1992 Reference 	M 103 940, 943 103 200 07 01 103 200 17 01 mit Thermostat/with thermostat/avec thermostat/con termostato/c termostatom M 103.943: 000138 / 000299 (autom.)→ M 103.940: 016912 / 035732 (autom.)→					50 005 442
06.1985→10.1992 Reference 	M 103 940, 943 103 200 20 01 103 200 26 01 103 200 37 01 ohne Thermostat/without thermostat/sans thermostat/sin termostato/без термостата M 103.943: 000138 / 000299 (autom.)→ M 103.940: 016912 / 035732 (autom.)→					50 005 446
06.1985→10.1992 Reference 	M 103 940, 943 103 200 04 01 ohne Thermostat/without thermostat/sans thermostat/sin termostato/без термостата M 103.943: →000137 / 000298 (autom.) M 103.940: →016911 / 035731 (autom.)→					50 005 440

M

**260 E (126)****246**

06.1985→08.1992	M 103 941							
Reference	103 200 07 01 103 200 17 01							
	mit Thermostat/with thermostat/avec thermostat/con termostato/c termostatom 002988 / 009802 (autom.)→							50 005 442
06.1985→08.1992	M 103 941							
Reference	103 200 20 01 103 200 26 01 103 200 37 01							
	ohne Thermostat/without thermostat/sans thermostat/sin termostato/без термостата 002988 / 009802 (autom.)→							50 005 446
06.1985→08.1992	M 103 941							
Reference	103 200 04 01							
	ohne Thermostat/without thermostat/sans thermostat/sin termostato/без термостата →002987 / 009801 (autom.)							50 005 440

280 (114)**247**

06.1972→12.1984	M 110 921, 931							
Reference	110 200 00 20 110 200 02 20 110 200 08 20 110 200 10 20 110 200 20 20 121 200 08 20							
								50 005 034

280 (123)**248**

02.1976→08.1981	M 110 923							
Reference	110 200 04 20 110 200 11 20 110 200 19 20							
								50 005 038

280 E (114)**249**

06.1972→12.1984	M 110 981, 991							
Reference	110 200 00 20 110 200 02 20 110 200 08 20 110 200 10 20 110 200 20 20 121 200 08 20							
								50 005 034

280 E (116)**250**

09.1972→07.1976	M 110 983							
	Lager/bearing/coussinet/cojinete/подшипник: 30 mm							50 005 932
09.1972→07.1976	M 110 983							
Reference	110 200 01 20							
	Lager/bearing/coussinet/cojinete/подшипник: 36 mm							50 005 032
09.1972→07.1976	M 110 983							
Reference	110 200 01 20 110 200 09 20 110 200 17 20 115 200 00 20 115 200 15 20 115 200 18 20 121 200 09 20							
	Lager/bearing/coussinet/cojinete/подшипник: 40 mm							50 005 035

280 E (123)**251**

02.1976→11.1985	M 110 984							
Reference	110 200 01 20							
	Lager/bearing/coussinet/cojinete/подшипник: 36 mm							50 005 032

M



MERCEDES-BENZ



02.1976→11.1985 Reference	M 110 984, 988 110 200 01 20 110 200 09 20 110 200 17 20 115 200 15 20 115 200 18 20 121 200 09 20 Lager/bearing/coussinete/cojinete/подшипник: 40 mm			50 005 035
02.1976→11.1985 Reference	M 110 984, 988 110 200 04 20 110 200 11 20 110 200 19 20			50 005 038
280 E (124)				252
09.1992→06.1993 Reference	M 104 942 104 200 28 01 104 200 45 01 104 200 49 01			50 005 434
09.1992→06.1993 Reference	M 104 942 104 200 33 01 104 200 44 01 104 200 47 01			50 005 436
280 GE (460)				253
11.1979→08.1989	M 110 994 Lager/bearing/coussinete/cojinete/подшипник: 30 mm			50 005 932
11.1979→08.1989 Reference	M 110 994 110 200 01 20 Lager/bearing/coussinete/cojinete/подшипник: 36 mm			50 005 032
11.1979→08.1989 Reference	M 110 994 110 200 01 20 110 200 09 20 110 200 17 20 115 200 15 20 115 200 18 20 121 200 09 20 Lager/bearing/coussinete/cojinete/подшипник: 40 mm			50 005 035
280 GE (461)				254
11.1979→08.1989	M 110 994 Lager/bearing/coussinete/cojinete/подшипник: 30 mm			50 005 932
11.1979→08.1989 Reference	M 110 994 110 200 01 20 Lager/bearing/coussinete/cojinete/подшипник: 36 mm			50 005 032
11.1979→08.1989 Reference	M 110 994 110 200 01 20 110 200 09 20 110 200 17 20 115 200 15 20 115 200 18 20 121 200 09 20 Lager/bearing/coussinete/cojinete/подшипник: 40 mm			50 005 035

M



280 S (108)

255

10.1967→07.1972	M 130	920-921					
Reference	110 200 00 20	110 200 02 20	110 200 08 20	110 200 10 20			50 005 034
	110 200 20 20	121 200 08 20					
	M 130.921: →000034 / 000005 (autom.)→ M 130.920: →001048 / 001253 (autom.)						
10.1967→07.1972	M 130	920-921					
	Lager/bearing/coussinet/cojinete/подшипник: 30 mm						
	M 130.921: 000035 / 000006 (autom.)→ M 130.920: 001049 / 001254 (autom.)→						50 005 932
10.1967→07.1972	M 130	920-921					
Reference	110 200 01 20						50 005 032
	Lager/bearing/coussinet/cojinete/подшипник: 36 mm						
	M 130.921: 000035 / 000006 (autom.)→ M 130.920: 001049 / 001254 (autom.)→						
10.1967→07.1972	M 130	920-921					
Reference	110 200 01 20	110 200 09 20	110 200 17 20	115 200 00 20			
	115 200 15 20	115 200 18 20	121 200 09 20				50 005 035
	Lager/bearing/coussinet/cojinete/подшипник: 40 mm						
	M 130.921: 000035 / 000006 (autom.)→ M 130.920: 001049 / 001254 (autom.)→						

280 S (116)

256

08.1972→12.1984	M 110	922, 932					
	Lager/bearing/coussinet/cojinete/подшипник: 30 mm						50 005 932
							
08.1972→12.1984	M 110	922, 932					
Reference	110 200 01 20						50 005 032
	Lager/bearing/coussinet/cojinete/подшипник: 36 mm						
							
08.1972→12.1984	M 110	922, 932					
Reference	110 200 01 20	110 200 09 20	110 200 17 20	115 200 00 20			
	115 200 15 20	115 200 18 20	121 200 09 20				50 005 035
	Lager/bearing/coussinet/cojinete/подшипник: 40 mm						



280 S (126)

257

12.1979→07.1985	M 110	924, 926					
Reference	110 200 04 20	110 200 11 20	110 200 19 20				50 005 038
							

280 SE (108)

258

01.1968→08.1972	M 130	980, 984					
Reference	110 200 00 20	110 200 02 20	110 200 08 20	110 200 10 20			
	110 200 20 20	121 200 08 20					50 005 034
	M 130.984: →000099 / 000046 (autom.)→ M 130.980: →005238 / 009385 (autom.)						
01.1968→08.1972	M 130	980, 984					
	Lager/bearing/coussinet/cojinete/подшипник: 30 mm						
	M 130.984: 000100 / 000047 (autom.)→ M 130.980: 005239 / 009386 (autom.)→						50 005 932
							



01.1968→08.1972 Reference 	M 130 110 200 01 20 Lager/bearing/coussinet/cojinete/подшипник: 36 mm M 130.984: 000100 / 000047 (autom.)→ M 130.980: 005239 / 009386 (autom.)→	980, 984		50 005 032
01.1968→08.1972 Reference 	M 130 110 200 01 20 110 200 09 20 110 200 17 20 115 200 00 20 115 200 15 20 115 200 18 20 121 200 09 20 Lager/bearing/coussinet/cojinete/подшипник: 40 mm M 130.984: 000100 / 000047 (autom.)→ M 130.980: 005239 / 009386 (autom.)→	980, 984		50 005 035
280 SE (111)				259
01.1967→08.1972 Reference 	M 130 110 200 00 20 110 200 02 20 110 200 08 20 110 200 10 20 110 200 20 20 121 200 08 20 M 130.984: →000099 / 000046 (autom.) M 130.980: →005238 / 009385 (autom.)	980, 984		50 005 034
01.1967→08.1972 	M 130 Lager/bearing/coussinet/cojinete/подшипник: 30 mm M 130.984: 000100 / 000047 (autom.)→ M 130.980: 005239 / 009386 (autom.)→	980, 984		50 005 932
01.1967→08.1972 Reference 	M 130 110 200 01 20 Lager/bearing/coussinet/cojinete/подшипник: 36 mm M 130.984: 000100 / 000047 (autom.)→ M 130.980: 005239 / 009386 (autom.)→	980, 984		50 005 032
01.1967→08.1972 Reference 	M 130 110 200 01 20 110 200 09 20 110 200 17 20 115 200 00 20 115 200 15 20 115 200 18 20 121 200 09 20 Lager/bearing/coussinet/cojinete/подшипник: 40 mm M 130.984: 000100 / 000047 (autom.)→ M 130.980: 005239 / 009386 (autom.)→	980, 984		50 005 035
280 SE (116)				260
10.1976→12.1984 	M 110 Lager/bearing/coussinet/cojinete/подшипник: 30 mm	985, 993		50 005 932
10.1976→12.1984 Reference 	M 110 110 200 01 20 Lager/bearing/coussinet/cojinete/подшипник: 36 mm	985, 993		50 005 032
10.1976→12.1984 Reference 	M 110 110 200 01 20 110 200 09 20 110 200 17 20 115 200 00 20 115 200 15 20 115 200 18 20 121 200 09 20 Lager/bearing/coussinet/cojinete/подшипник: 40 mm	985, 993		50 005 035
280 SE (126)				261
10.1979→07.1985 Reference 	M 110 110 200 01 20 110 200 09 20 110 200 17 20 115 200 00 20 115 200 15 20 115 200 18 20 121 200 09 20 Lager/bearing/coussinet/cojinete/подшипник: 40 mm	987, 989		50 005 035
10.1979→07.1985 Reference	M 110 110 200 04 20 110 200 11 20 110 200 19 20	987, 989		50 005 038

M



280 SE 3.5 (108)

262

04.1969→08.1972 M 116 980, 990
 Reference 117 200 00 01 117 200 02 01 117 200 03 01 117 200 08 01
 117 200 28 01 117 200 38 01
 ohne Thermostat/without thermostat/sans thermostat/sin termostato/без термостата

**50 005 021**

280 SE 3.5 (111)

263

01.1969→12.1971 M 116 980
 Reference 117 200 00 01 117 200 02 01 117 200 03 01 117 200 08 01
 117 200 28 01 117 200 38 01
 ohne Thermostat/without thermostat/sans thermostat/sin termostato/без термостата

**50 005 021**

280 SL (107)

264

06.1976→08.1985 M 110 982, 986, 990, 992
 Lager/bearing/coussinet/cojinetete/подшипник: 30 mm

**50 005 932**

06.1976→08.1985 M 110 982, 986, 990, 992
 Reference 110 200 01 20
 Lager/bearing/coussinet/cojinetete/подшипник: 36 mm

**50 005 032**

06.1976→08.1985 M 110 982, 986, 990, 992
 Reference 110 200 01 20 110 200 09 20 110 200 17 20 115 200 00 20
 115 200 15 20 115 200 18 20 121 200 09 20
 Lager/bearing/coussinet/cojinetete/подшипник: 40 mm

**50 005 035**

280 SL (113)

265

01.1968→12.1971 M 130 983
 Reference 110 200 00 20 110 200 02 20 110 200 08 20 110 200 10 20
 110 200 20 20 121 200 08 20

**50 005 034**

01.1968→12.1971 M 130 983
 Reference 110 200 01 20 110 200 09 20 110 200 17 20 115 200 00 20
 115 200 15 20 115 200 18 20 121 200 09 20
 Lager/bearing/coussinet/cojinetete/подшипник: 40 mm

**50 005 035**

290 GD (461)

266

04.1992→11.1997 OM 602 942, 946-947
 Reference 602 200 00 20 602 200 01 20 602 200 02 20

**50 005 439**

290 GD Turbo (461)

267

04.1992→09.2001 OM 602 983
 Reference 602 200 00 20 602 200 01 20 602 200 02 20

**50 005 439**

300 D Turbo (123)

268

10.1980→11.1985 OM 617 952
 Lager/bearing/coussinet/cojinetete/подшипник: 30 mm

**50 005 932****M**



MERCEDES-BENZ

10.1980→11.1985 Reference 	OM 617 952 110 200 01 20 Lager/bearing/coussinete/cojinete/подшипник: 36 mm			50 005 032
10.1980→11.1985 Reference 	OM 617 952 110 200 01 20 110 200 09 20 110 200 17 20 115 200 00 20 115 200 15 20 115 200 18 20 121 200 09 20 Lager/bearing/coussinete/cojinete/подшипник: 40 mm			50 005 035
300 D Turbo (124)				269
09.1986→06.1993 Reference 	OM 603 960, 963 602 200 00 20 602 200 01 20 602 200 02 20 OM 603.960: →054622			50 005 439
01.1988→06.1993 Reference 	OM 603 960 605 200 01 20 605 200 03 20 605 200 05 20 605 200 08 20 054623→			50 005 490
300 D (115)				270
08.1973→01.1977 	OM 617 910 Lager/bearing/coussinete/cojinete/подшипник: 30 mm			50 005 932
08.1973→01.1977 Reference 	OM 617 910 110 200 01 20 Lager/bearing/coussinete/cojinete/подшипник: 36 mm			50 005 032
08.1973→01.1977 Reference 	OM 617 910 110 200 01 20 110 200 09 20 110 200 17 20 115 200 00 20 115 200 15 20 115 200 18 20 121 200 09 20 Lager/bearing/coussinete/cojinete/подшипник: 40 mm			50 005 035
300 D (123)				271
02.1976→11.1985 	OM 617 912 Lager/bearing/coussinete/cojinete/подшипник: 30 mm			50 005 932
02.1976→11.1985 Reference 	OM 617 912 110 200 01 20 Lager/bearing/coussinete/cojinete/подшипник: 36 mm			50 005 032
02.1976→11.1985 Reference 	OM 617 912 110 200 01 20 110 200 09 20 110 200 17 20 115 200 00 20 115 200 15 20 115 200 18 20 121 200 09 20 Lager/bearing/coussinete/cojinete/подшипник: 40 mm			50 005 035
300 D (124)				272
12.1984→06.1993 Reference	OM 603 912-913 602 200 00 20 602 200 01 20 602 200 02 20			50 005 439

M



300 E (124)

273

01.1985→06.1993	M 103	980, 983, 985			
Reference	103 200 07 01	103 200 17 01			50 005 442
	mit Thermostat/with thermostat/avec thermostat/con termostato/c tepmochtatom M 103.985: 00583 / 002104 (autom.)→ M 103.980, M 103.983: 018293 / 094339 (autom.)→				
01.1985→06.1993	M 103	980, 983, 985			50 005 446
Reference	103 200 20 01	103 200 26 01	103 200 37 01		
	ohne Thermostat/without thermostat/sans thermostat/sin termostato/без термостата M 103.985: 00583 / 002104 (autom.)→ M 103.980, M 103.983: 018293 / 094339 (autom.)→				
01.1985→06.1993	M 103	980, 983, 985			50 005 440
Reference	103 200 04 01				
	ohne Thermostat/without thermostat/sans thermostat/sin termostato/без термостата M 103.985: →000582 / 002103 (autom.) M 103.980, M 103.983: →018292 / 094338 (autom.)				
09.1989→06.1993	M 104	980			50 005 449
Reference	104 200 03 01	104 200 29 01			
09.1989→06.1993	M 104	980			50 005 452
Reference	104 200 08 01	104 200 31 01			

M

300 E 2.6 (124)

274

09.1989→10.1992	M 103	940			
Reference	103 200 07 01	103 200 17 01			50 005 442
	mit Thermostat/with thermostat/avec thermostat/con termostato/c tepmochtatom 016912 / 035732 (autom.)→				
09.1989→10.1992	M 103	940			50 005 446
Reference	103 200 20 01	103 200 26 01	103 200 37 01		
	ohne Thermostat/without thermostat/sans thermostat/sin termostato/без термостата 016912 / 035732 (autom.)→				
09.1989→10.1992	M 103	940			50 005 440
Reference	103 200 04 01				
	ohne Thermostat/without thermostat/sans thermostat/sin termostato/без термостата →016911 / 035731 (autom.)				

300 E 3.2 (124)



275

09.1992→06.1993	M 104	992			
Reference	104 200 28 01	104 200 45 01	104 200 49 01		50 005 434
09.1992→06.1993	M 104	992			50 005 436
Reference	104 200 33 01	104 200 44 01	104 200 47 01		







300 E-24 (124)

276

09.1989→06.1993	M 104	980			
Reference	104 200 03 01	104 200 29 01			50 005 449
09.1989→06.1993	M 104	980			
Reference	104 200 08 01	104 200 31 01			50 005 452





300 GD (460)

277

12.1979→08.1990	OM 617	931-932			
Reference	616 200 04 20	616 200 07 20			50 005 428
	OM 617.932: 000091 / 000002 (autom.)→ OM 617.931: 011425 / 001230 (autom.)→				
12.1979→08.1990	OM 617	931-932			
	Lager/bearing/coussinnet/cojinete/подшипник: 30 mm OM 617.932: →000090 / 000001 (autom.) OM 617.931: →011424 / 001229 (autom.)				50 005 932
12.1979→08.1990	OM 617	931-932			
Reference	110 200 01 20				50 005 032
	Lager/bearing/coussinnet/cojinete/подшипник: 36 mm OM 617.932: →000090 / 000001 (autom.) OM 617.931: →011424 / 001229 (autom.)				
12.1979→08.1990	OM 617	931-932			
Reference	110 200 01 20	110 200 09 20	110 200 17 20	115 200 00 20	
	115 200 15 20	115 200 18 20	121 200 09 20		
	Lager/bearing/coussinnet/cojinete/подшипник: 40 mm OM 617.932: →000090 / 000001 (autom.) OM 617.931: →011424 / 001229 (autom.)				50 005 035

300 GD (461)

278

12.1979→08.1990	OM 617	932-933			
Reference	616 200 04 20	616 200 07 20			50 005 428
	OM 617.932: 000091 / 000002 (autom.)→				
12.1979→08.1990	OM 617	932			
	Lager/bearing/coussinnet/cojinete/подшипник: 30 mm →000090 / 000001 (autom.)				50 005 932
12.1979→08.1990	OM 617	932			
Reference	110 200 01 20				50 005 032
	Lager/bearing/coussinnet/cojinete/подшипник: 36 mm →000090 / 000001 (autom.)				
12.1979→08.1990	OM 617	932			
Reference	110 200 01 20	110 200 09 20	110 200 17 20	115 200 00 20	
	115 200 15 20	115 200 18 20	121 200 09 20		
	Lager/bearing/coussinnet/cojinete/подшипник: 40 mm →000090 / 000001 (autom.)				50 005 035

M



300 GD (463)				279
02.1989→10.1994 Reference	OM 603 931 602 200 00 20 602 200 01 20 602 200 02 20			50 005 439
300 GE (463)				280
09.1989→07.1993 Reference	M 103 987 103 200 07 01 103 200 17 01 mit Thermostat/with thermostat/avec thermostat/con termostato/c термостатом			50 005 442
09.1989→07.1993 Reference	M 103 987 103 200 20 01 103 200 26 01 103 200 37 01 ohne Thermostat/without thermostat/sans thermostat/sin termostato/без термостата			50 005 446
300 SD Turbo (USA) (116)				281
02.1978→08.1980 Reference	OM 617 950 110 200 01 20 Lager/bearing/coussinet/cojinete/подшипник: 36 mm			50 005 032
02.1978→08.1980 Reference	OM 617 950 110 200 01 20 110 200 09 20 110 200 17 20 115 200 00 20 115 200 15 20 115 200 18 20 121 200 09 20 Lager/bearing/coussinet/cojinete/подшипник: 40 mm			50 005 035
300 SD Turbo (USA) (126)				282
08.1980→10.1985 Reference	OM 617 951 Lager/bearing/coussinet/cojinete/подшипник: 30 mm			50 005 932
08.1980→10.1985 Reference	OM 617 951 110 200 01 20 Lager/bearing/coussinet/cojinete/подшипник: 36 mm			50 005 032
11.1985→12.1987 Reference	OM 603 961 602 200 00 20 602 200 01 20 602 200 02 20			50 005 439
08.1980→10.1985 Reference	OM 617 951 110 200 01 20 110 200 09 20 110 200 17 20 115 200 00 20 115 200 15 20 115 200 18 20 121 200 09 20 Lager/bearing/coussinet/cojinete/подшипник: 40 mm			50 005 035
300 SD 3.5 Turbo (140)				283
07.1991→05.1993 Reference	OM 603 971 602 200 00 20 602 200 01 20 602 200 02 20 →018738			50 005 439

M



07.1991→05.1993 Reference 	OM 603 971 605 200 01 20 605 200 03 20 605 200 05 20 605 200 08 20 018739→			50 005 490
300 SE (126)				284
09.1985→06.1993 Reference 	M 103 981 103 200 07 01 103 200 17 01 mit Thermostat/with thermostat/avec thermostat/con termostato/c термостатом 004966→			50 005 442
09.1985→06.1993 Reference 	M 103 981 103 200 20 01 103 200 26 01 103 200 37 01 ohne Thermostat/without thermostat/sans thermostat/sin termostato/без термостата 004966→			50 005 446
09.1985→06.1993 Reference 	M 103 981 103 200 04 01 ohne Thermostat/without thermostat/sans thermostat/sin termostato/без термостата →004965			50 005 440
09.1985→06.1993 Reference 	M 103 981 103 200 05 01 103 200 18 01 für Automatikgetriebe/for automatic gear box/pour boîte de vitesse automatique/para caja de cambios automática/для автоматической коробки передач VT / VTO ohne Thermostat/without thermostat/sans thermostat/sin termostato/без термостата →045442			50 005 441
09.1985→06.1993 Reference 	M 103 981 103 200 06 01 103 200 19 01 103 200 21 01 103 200 27 01 103 200 38 01 ohne Thermostat/without thermostat/sans thermostat/sin termostato/без термостата für Automatikgetriebe/for automatic gear box/pour boîte de vitesse automatique/ para caja de cambios automática/для автоматической коробки передач VT / VTO 045443→			50 005 447
300 SE 2.8 (109)				285
01.1968→08.1972 Reference 	M 130 981 110 200 00 20 110 200 02 20 110 200 08 20 110 200 10 20 110 200 20 20 121 200 08 20 →000104 / 000828 (autom.)			50 005 034
01.1968→08.1972 Reference 	M 130 981 Lager/bearing/coussinet/cojinete/подшипник: 30 mm 000105 / 000829 (autom.)→			50 005 932
01.1968→08.1972 Reference 	M 130 981 110 200 01 20 Lager/bearing/coussinet/cojinete/подшипник: 36 mm 000105 / 000829 (autom.)→			50 005 032
01.1968→08.1972 Reference 	M 130 981 110 200 01 20 110 200 09 20 110 200 17 20 115 200 00 20 115 200 15 20 115 200 18 20 121 200 09 20 Lager/bearing/coussinet/cojinete/подшипник: 40 mm 000105 / 000829 (autom.)→			50 005 035

M



300 SE 2.8 (124)

286

01.1993→06.1993 M 104 942
 Reference 104 200 28 01 104 200 45 01 104 200 49 01

**50 005 434**

01.1993→06.1993 M 104 942
 Reference 104 200 33 01 104 200 44 01 104 200 47 01

**50 005 436**

300 SE 2.8 (126)

287

01.1993→06.1993 M 104 942
 Reference 104 200 28 01 104 200 45 01 104 200 49 01

**50 005 434**

01.1993→06.1993 M 104 942
 Reference 104 200 33 01 104 200 44 01 104 200 47 01

**50 005 436**

300 SE 2.8 (140)

288**M**

09.1992→05.1993 M 104 944
 Reference 104 200 13 01 104 200 30 01 104 200 46 01
 →000508 / 004534 (autom.)

**50 005 435**

09.1992→05.1993 M 104 944
 Reference 104 200 27 01 104 200 32 01 104 200 48 01
 000509 / 004535 (autom.)→

**50 005 437**

300 SE 3.2 (140)

289

03.1991→05.1993 M 104 990
 Reference 104 200 13 01 104 200 30 01 104 200 46 01
 →000259 / 017742 (autom.)

**50 005 435**

03.1991→05.1993 M 104 990
 Reference 104 200 27 01 104 200 32 01 104 200 48 01
 000260 / 017743 (autom.)→

**50 005 437**

300 SE 3.5 (109)

290

01.1968→07.1972 M 116 981, 991
 Reference 117 200 00 01 117 200 02 01 117 200 03 01 117 200 08 01
 117 200 28 01 117 200 38 01
 ohne Thermostat/without thermostat/sans thermostat/sin termostato/без термостата

**50 005 021**



300 SEL 4.5 (109)

291

Reference	M 117 981 117 200 00 01 117 200 02 01 117 200 03 01 117 200 08 01 117 200 28 01 117 200 38 01 ohne Thermostat/without thermostat/sans thermostat/sin termostato/без термостата			50 005 021
-----------	---	---	--	------------

300 SL (107)



292

09.1985→09.1989	M 103 982			
Reference	103 200 07 01 103 200 17 01 mit Thermostat/with thermostat/avec thermostat/con termostato/c термостатом 001731→			50 005 442
09.1985→09.1989	M 103 982			
Reference	103 200 20 01 103 200 26 01 103 200 37 01 ohne Thermostat/without thermostat/sans thermostat/sin termostato/без термостата 001731→			50 005 446
09.1985→09.1989	M 103 982			
Reference	103 200 04 01 ohne Thermostat/without thermostat/sans thermostat/sin termostato/без термостата →001730			50 005 440
09.1985→09.1989	M 103 982			
Reference	103 200 05 01 103 200 18 01 für Automatikgetriebe/for automatic gear box/pour boîte de vitesse automatique/para caja de cambios automática/для автоматической коробки передач VT / VTO ohne Thermostat/without thermostat/sans thermostat/sin termostato/без термостата →007505			50 005 441
09.1985→09.1989	M 103 982			
Reference	103 200 06 01 103 200 19 01 103 200 21 01 103 200 27 01 103 200 38 01 ohne Thermostat/without thermostat/sans thermostat/sin termostato/без термостата für Automatikgetriebe/for automatic gear box/pour boîte de vitesse automatique/ para caja de cambios automática/для автоматической коробки передач VT / VTO 001731→			50 005 447

M

300 SL (129)

293

03.1989→06.1993	M 103 984			
Reference	103 200 07 01 103 200 17 01 mit Thermostat/with thermostat/avec thermostat/con termostato/c термостатом			50 005 442
03.1989→06.1993	M 103 984			
Reference	103 200 20 01 103 200 26 01 103 200 37 01 ohne Thermostat/without thermostat/sans thermostat/sin termostato/без термостата			50 005 446

300 SL-24 (129)

294

03.1989→06.1993	M 104 981			
Reference	104 200 03 01 104 200 29 01			50 005 449



03.1989→06.1993 Reference	M 104 981 104 200 08 01 104 200 31 01			50 005 452
320 E (124)				295
09.1992→06.1993 Reference	M 104 992 104 200 28 01 104 200 45 01 104 200 49 01			50 005 434
09.1992→06.1993 Reference	M 104 992 104 200 33 01 104 200 44 01 104 200 47 01			50 005 436
350 GD Turbo (463)				296
09.1991→07.1993 Reference 	OM 603 972 602 200 00 20 602 200 01 20 602 200 02 20 →004348			50 005 439
09.1991→07.1993 Reference 	OM 603 972 605 200 01 20 605 200 03 20 605 200 05 20 605 200 08 20 004349→			50 005 490
350 SE (116)				297
04.1971→03.1980 Reference 	M 116 983, 985, 993 117 200 00 01 117 200 02 01 117 200 03 01 117 200 08 01 117 200 28 01 117 200 38 01 ohne Thermostat/without thermostat/sans thermostat/sin termostato/без термостата			50 005 021
350 SE 2.8 (116)				298
10.1981→12.1984 	M 110 993 Lager/bearing/coussinet/cojinete/подшипник: 30 mm			50 005 932
10.1981→12.1984 Reference 	M 110 993 110 200 01 20 Lager/bearing/coussinet/cojinete/подшипник: 36 mm			50 005 032
10.1981→12.1984 Reference 	M 110 993 110 200 01 20 110 200 09 20 110 200 17 20 115 200 00 20 115 200 15 20 115 200 18 20 121 200 09 20 Lager/bearing/coussinet/cojinete/подшипник: 40 mm			50 005 035

M

**350 SL (107)****299**

02.1971→02.1980 M 116 982, 984, 992
 Reference 117 200 00 01 117 200 02 01 117 200 03 01 117 200 08 01
 117 200 28 01 117 200 38 01
 ohne Thermostat/without thermostat/sans thermostat/sin termostato/без термостата



50 005 021

350 SL 2.8 (107)**300**

06.1976→08.1985 M 110 986, 990, 992
 Lager/bearing/coussinnet/cojinete/подшипник: 30 mm



50 005 932

06.1976→08.1985 M 110 986, 990, 992
 Reference 110 200 01 20
 Lager/bearing/coussinnet/cojinete/подшипник: 36 mm



50 005 032

06.1976→08.1985 M 110 986, 990, 992
 Reference 110 200 01 20 110 200 09 20 110 200 17 20 115 200 00 20
 115 200 15 20 115 200 18 20 121 200 09 20
 Lager/bearing/coussinnet/cojinete/подшипник: 40 mm



50 005 035

380 SE (126)**301**

12.1979→08.1985 M 116 961, 963
 Reference 117 200 10 01 117 200 17 01 117 200 29 01 117 200 33 01



50 005 030

380 SE 2.8 (126)**302**

10.1979→12.1985 M 110 987, 989
 Reference 110 200 01 20 110 200 09 20 110 200 17 20 115 200 00 20
 115 200 15 20 115 200 18 20 121 200 09 20
 Lager/bearing/coussinnet/cojinete/подшипник: 40 mm



50 005 035

10.1979→12.1985 M 110 987, 989
 Reference 110 200 04 20 110 200 11 20 110 200 19 20



50 005 038

380 SL (107)**303**

07.1980→08.1985 M 116 960, 962
 Reference 117 200 10 01 117 200 17 01 117 200 29 01 117 200 33 01



50 005 030

400 E 4.2 (124)**304**

10.1992→06.1993 M 119 975
 Reference 119 200 04 01 119 200 09 01 119 200 15 01
 →020771



50 005 430

M



MERCEDES-BENZ

10.1992→06.1993 Reference 	M 119 975 119 200 21 01 020772→			
400 SE 4.2 (140)				305
02.1991→05.1993 Reference 	M 119 971 119 200 04 01 119 200 09 01 119 200 15 01 →026750			
02.1991→05.1993 Reference 	M 119 971 119 200 21 01 026751→			
420 SE (126)				306
09.1985→06.1991 Reference	M 116 965 116 200 11 01 116 200 12 01 116 200 13 01 116 200 14 01 116 200 16 01 116 200 17 01			
420 SL (107)				307
01.1986→08.1989 Reference	M 116 964 116 200 11 01 116 200 12 01 116 200 13 01 116 200 14 01 116 200 16 01 116 200 17 01			
450 SE (116)				308
01.1973→04.1980 Reference 	M 117 983, 986, 993 117 200 00 01 117 200 02 01 117 200 03 01 117 200 08 01 117 200 28 01 117 200 38 01 ohne Thermostat/without thermostat/sans thermostat/sin termostato/без термостата			
450 SE 2.8 (116)				309
10.1981→12.1984 	M 110 993 Lager/bearing/coussinet/cojinetete/подшипник: 30 mm			
10.1981→12.1984 Reference 	M 110 993 110 200 01 20 Lager/bearing/coussinet/cojinetete/подшипник: 36 mm			
10.1981→12.1984 Reference 	M 110 993 110 200 01 20 110 200 09 20 110 200 17 20 115 200 00 20 115 200 15 20 115 200 18 20 121 200 09 20 Lager/bearing/coussinet/cojinetete/подшипник: 40 mm			

M



450 SL (107)

310

10.1972→10.1980 M 117 982, 985, 992
 Reference 117 200 00 01 117 200 02 01 117 200 03 01 117 200 08 01
 117 200 28 01 117 200 38 01
 ohne Thermostat/without thermostat/sans thermostat/sin termostato/без термостата

50 005 021

450 SL 2.8 (107)

311

06.1976→08.1985 M 110 986, 990, 992
 Lager/bearing/coussinete/cojinete/подшипник: 30 mm

50 005 932

06.1976→08.1985 M 110 986, 990, 992
 Reference 110 200 01 20
 Lager/bearing/coussinete/cojinete/подшипник: 36 mm

50 005 032

06.1976→08.1985 M 110 986, 990, 992
 Reference 110 200 01 20 110 200 09 20 110 200 17 20 115 200 00 20
 115 200 15 20 115 200 18 20 121 200 09 20
 Lager/bearing/coussinete/cojinete/подшипник: 40 mm

50 005 035

500 E (124)

312

01.1991→06.1993 M 119 974
 Reference 119 200 04 01 119 200 09 01 119 200 15 01
 →010204

50 005 430

01.1991→06.1993 M 119 974
 Reference 119 200 21 01
 010205→

50 005 454

500 GE (463)

313

01.1993→08.1993 M 117 965
 Reference 116 200 11 01 116 200 12 01 116 200 13 01 116 200 14 01
 116 200 16 01 116 200 17 01

50 005 427

500 SE (126)

314

12.1979→08.1985 M 117 963
 Reference 117 200 10 01 117 200 17 01 117 200 29 01 117 200 33 01

50 005 030

09.1985→06.1991 M 117 965
 Reference 116 200 11 01 116 200 12 01 116 200 13 01 116 200 14 01
 116 200 16 01 116 200 17 01

50 005 427



500 SE (140)

315

02.1991→05.1993 M 119 970
 Reference 119 200 04 01 119 200 09 01 119 200 15 01
 →056885

**50 005 430**

02.1991→05.1993 M 119 970
 Reference 119 200 21 01
 056886→

**50 005 454**

500 SE 2.8 (126)

316

10.1979→12.1985 M 110 987, 989
 Reference 110 200 01 20 110 200 09 20 110 200 17 20 115 200 00 20
 115 200 15 20 115 200 18 20 121 200 09 20
 Lager/bearing/coussinet/cojinete/подшипник: 40 mm

**50 005 035**

10.1979→12.1985 M 110 987, 989
 Reference 110 200 04 20 110 200 11 20 110 200 19 20

**50 005 038**

500 SL (107)

317

05.1980→12.1985 M 117 962
 Reference 117 200 10 01 117 200 17 01 117 200 29 01 117 200 33 01

**50 005 030**

01.1986→08.1989 M 117 964
 Reference 116 200 11 01 116 200 12 01 116 200 13 01 116 200 14 01
 116 200 16 01 116 200 17 01

**50 005 427**

500 SL (129)

318

03.1989→09.1995 M 119 960, 972
 Reference 119 200 04 01 119 200 09 01 119 200 15 01
 M 119.972: →013777

**50 005 430**

09.1992→09.1995 M 119 972
 Reference 119 200 21 01
 013778→

**50 005 454**

560 SE (126)

319



10.1985→06.1991 M 117 968
 Reference 116 200 11 01 116 200 12 01 116 200 13 01 116 200 14 01
 116 200 16 01 116 200 17 01

**50 005 427****M**





Actros 1831

320

09.1996→02.2003 Reference	OM 541 542 200 05 01	920, 926, 940-941 542 200 15 01	542 200 19 01		50 005 619
09.1996→02.2003 Reference	OM 541 541 200 01 01	920, 926, 940-941 541 200 11 01	541 200 12 01		50 005 628
09.1996→02.2003 Reference	OM 541 541 180 00 01	920, 926, 940-941 541 180 01 01	541 180 02 01 541 180 03 01		50 005 831



Actros 1832

321

09.1996→ Reference	OM 541 542 200 05 01	920, 940 542 200 15 01	542 200 19 01		50 005 619
09.1996→ Reference	OM 541 541 200 01 01	920, 940 541 200 11 01	541 200 12 01		50 005 628
09.1996→ Reference	OM 541 541 180 00 01	920, 940 541 180 01 01	541 180 02 01 541 180 03 01		50 005 831

Actros 1835

322

09.1996→02.2003 Reference	OM 541 542 200 05 01	922, 927, 942-943 542 200 15 01	542 200 19 01		50 005 619
09.1996→02.2003 Reference	OM 541 541 200 01 01	922, 927, 942-943 541 200 11 01	541 200 12 01		50 005 628
09.1996→02.2003 Reference	OM 541 541 180 00 01	922, 927, 942-943 541 180 01 01	541 180 02 01 541 180 03 01		50 005 831

Actros 1836

323

04.2003→ Reference	OM 541 542 200 05 01	942 542 200 15 01	542 200 19 01		50 005 619

M





				
04.2003→ Reference	OM 541 942 541 200 01 01	541 200 11 01	541 200 12 01	 50 005 628
04.2003→ Reference	OM 541 942 541 180 00 01	541 180 01 01	541 180 02 01 541 180 03 01	 50 005 831
Actros 1839				324
06.1996→ Reference	OM 541 923 542 200 05 01	542 200 15 01	542 200 19 01	 50 005 619
06.1996→ Reference	OM 541 923 541 200 01 01	541 200 11 01	541 200 12 01	 50 005 628
Actros 1840				325
09.1996→02.2003 Reference	OM 541 923-924, 944-945 542 200 05 01	542 200 15 01	542 200 19 01	 50 005 619
09.1996→02.2003 Reference	OM 541 923-924, 944-945 541 200 01 01	541 200 11 01	541 200 12 01	 50 005 628
09.1996→02.2003 Reference	OM 541 923-924, 944-945 541 180 00 01	541 180 01 01	541 180 02 01 541 180 03 01	 50 005 831
Actros 1841				326
04.2003→ Reference	OM 541 944 542 200 05 01	542 200 15 01	542 200 19 01	 50 005 619
04.2003→ Reference	OM 541 944 541 200 01 01	541 200 11 01	541 200 12 01	 50 005 628
04.2003→ Reference	OM 541 944 541 180 00 01	541 180 01 01	541 180 02 01 541 180 03 01	 50 005 831

M





Actros 1843

327

09.1996→02.2003 Reference	OM 541 542 200 05 01	921, 925, 946-947 542 200 15 01	542 200 19 01		50 005 619
09.1996→02.2003 Reference	OM 541 541 200 01 01	921, 925, 946-947 541 200 11 01	541 200 12 01		50 005 628
09.1996→02.2003 Reference	OM 541 541 180 00 01	921, 925, 946-947 541 180 01 01	541 180 02 01 541 180 03 01		50 005 831



Actros 1844

328

04.2003→ Reference	OM 541 542 200 05 01	946 542 200 15 01	542 200 19 01		50 005 619
04.2003→ Reference	OM 541 541 200 01 01	946 541 200 11 01	541 200 12 01		50 005 628
04.2003→ Reference	OM 541 541 180 00 01	946 541 180 01 01	541 180 02 01 541 180 03 01		50 005 831

Actros 1846

329

04.2003→ Reference	OM 541 542 200 05 01	948 542 200 15 01	542 200 19 01		50 005 619
04.2003→ Reference	OM 541 541 200 01 01	948 541 200 11 01	541 200 12 01		50 005 628
04.2003→ Reference	OM 541 541 180 00 01	948 541 180 01 01	541 180 02 01 541 180 03 01		50 005 831















Actros 1848

330

09.1996→02.2003 Reference	OM 541 542 200 05 01	948-949 OM 542 921, 925, 940-941 542 200 15 01	542 200 19 01		50 005 619















M



							
Reference	OM 541 948-949	541 200 01 01	541 200 11 01	541 200 12 01		50 005 628	
Reference	OM 541 948-949	541 180 00 01	541 180 01 01	541 180 02 01	541 180 03 01		50 005 831
09.1996→02.2003 Reference	OM 542 921, 925, 940-941	542 180 00 01	542 180 01 01	542 180 02 01	542 180 07 01		50 005 838
Actros 1850							331
04.2003→ Reference	OM 542 941	542 200 05 01	542 200 15 01	542 200 19 01		50 005 619	
04.2003→ Reference	OM 542 941	542 180 00 01	542 180 01 01	542 180 02 01	542 180 07 01		50 005 838
Actros 1853							332
09.1996→02.2003 Reference	OM 542 920, 942	542 200 05 01	542 200 15 01	542 200 19 01		50 005 619	
09.1996→02.2003 Reference	OM 542 920, 942	542 180 00 01	542 180 01 01	542 180 02 01	542 180 07 01		50 005 838
Actros 1854							333
04.2003→ Reference	OM 542 942	542 200 05 01	542 200 15 01	542 200 19 01		50 005 619	
04.2003→ Reference	OM 542 942	542 180 00 01	542 180 01 01	542 180 02 01	542 180 07 01		50 005 838
Actros 1857							334
09.1996→02.2003 Reference	OM 542 922, 944	542 200 05 01	542 200 15 01	542 200 19 01		50 005 619	

M



							
09.1996→02.2003 Reference	OM 542 922, 944 542 180 00 01 542 180 01 01 542 180 02 01 542 180 07 01					50 005 838	
Actros 1858							335
04.2003→ Reference	OM 542 944 542 200 05 01 542 200 15 01 542 200 19 01						50 005 619
04.2003→ Reference	OM 542 944 542 180 00 01 542 180 01 01 542 180 02 01 542 180 07 01					50 005 838	
Actros 2031							336
09.1996→02.2003 Reference	OM 541 920, 926, 940-941 542 200 05 01 542 200 15 01 542 200 19 01						50 005 619
09.1996→02.2003 Reference	OM 541 920, 926, 940-941 541 200 01 01 541 200 11 01 541 200 12 01						50 005 628
09.1996→02.2003 Reference	OM 541 920, 926, 940-941 541 180 00 01 541 180 01 01 541 180 02 01 541 180 03 01					50 005 831	
Actros 2032							337
09.1996→ Reference	OM 541 926, 940-941 542 200 05 01 542 200 15 01 542 200 19 01						50 005 619
09.1996→ Reference	OM 541 926, 940-941 541 200 01 01 541 200 11 01 541 200 12 01						50 005 628
09.1996→ Reference	OM 541 926, 940-941 541 180 00 01 541 180 01 01 541 180 02 01 541 180 03 01					50 005 831	
Actros 2035							338
09.1996→ Reference	OM 541 922, 927, 942-943 542 200 05 01 542 200 15 01 542 200 19 01						50 005 619

M





09.1996→ Reference	OM 541 541 200 01 01	922, 927, 942-943 541 200 11 01	541 200 12 01	 50 005 628
09.1996→ Reference	OM 541 541 180 00 01	922, 927, 942-943 541 180 01 01	541 180 02 01 541 180 03 01	 50 005 831
Actros 2036				339
09.1996→ Reference	OM 541 542 200 05 01	927, 942-943 542 200 15 01	542 200 19 01	 50 005 619
09.1996→ Reference	OM 541 541 200 01 01	927, 942-943 541 200 11 01	541 200 12 01	 50 005 628
09.1996→ Reference	OM 541 541 180 00 01	927, 942-943 541 180 01 01	541 180 02 01 541 180 03 01	 50 005 831
Actros 2040				340
09.1996→ Reference	OM 541 542 200 05 01	923-925, 944-946, 948 542 200 15 01	542 200 19 01	 50 005 619
09.1996→ Reference	OM 541 541 200 01 01	923-925, 944-946, 948 541 200 11 01	541 200 12 01	 50 005 628
09.1996→ Reference	OM 541 541 180 00 01	923-925, 944-946, 948 541 180 01 01	541 180 02 01 541 180 03 01	 50 005 831
Actros 2041				341
02.2003→ Reference	OM 541 542 200 05 01	944 542 200 15 01	542 200 19 01	 50 005 619
02.2003→ Reference	OM 541 541 200 01 01	944 541 200 11 01	541 200 12 01	 50 005 628
02.2003→ Reference	OM 541 541 180 00 01	944 541 180 01 01	541 180 02 01 541 180 03 01	 50 005 831

M





Actros 2043

342

09.1996→02.2003 Reference	OM 541 921, 947 542 200 05 01 542 200 15 01 542 200 19 01		50 005 619
09.1996→02.2003 Reference	OM 541 921, 947 541 200 01 01 541 200 11 01 541 200 12 01		50 005 628
09.1996→02.2003 Reference	OM 541 921, 947 541 180 00 01 541 180 01 01 541 180 02 01 541 180 03 01		50 005 831

Actros 2044



343

04.2003→ Reference	OM 541 946 542 200 05 01 542 200 15 01 542 200 19 01		50 005 619
04.2003→ Reference	OM 541 946 541 200 01 01 541 200 11 01 541 200 12 01		50 005 628
04.2003→ Reference	OM 541 946 541 180 00 01 541 180 01 01 541 180 02 01 541 180 03 01		50 005 831

M

Actros 2046

344















04.2003→ Reference	OM 541 948 542 200 05 01 542 200 15 01 542 200 19 01		50 005 619
04.2003→ Reference	OM 541 948 541 200 01 01 541 200 11 01 541 200 12 01		50 005 628
04.2003→ Reference	OM 541 948 541 180 00 01 541 180 01 01 541 180 02 01 541 180 03 01		50 005 831

Actros 2048

345

02.1995→02.2003 Reference	OM 541 948-949 OM 542 921, 925, 940-941 542 200 05 01 542 200 15 01 542 200 19 01		50 005 619



							
Reference	OM 541 948-949	541 200 01 01	541 200 11 01	541 200 12 01		50 005 628	
Reference	OM 541 948-949	541 180 00 01	541 180 01 01	541 180 02 01	541 180 03 01		50 005 831
02.1995→02.2003 Reference	OM 542 921, 925, 940-941	542 180 00 01	542 180 01 01	542 180 02 01	542 180 07 01		50 005 838
Actros 2050							346
04.2003→ Reference	OM 542 941	542 200 05 01	542 200 15 01	542 200 19 01		50 005 619	
04.2003→ Reference	OM 542 941	542 180 00 01	542 180 01 01	542 180 02 01	542 180 07 01		50 005 838
Actros 2053							347
09.1996→02.2003 Reference	OM 542 920, 942	542 200 05 01	542 200 15 01	542 200 19 01		50 005 619	
09.1996→02.2003 Reference	OM 542 920, 942	542 180 00 01	542 180 01 01	542 180 02 01	542 180 07 01		50 005 838
Actros 2054							348
04.2003→ Reference	OM 542 942	542 200 05 01	542 200 15 01	542 200 19 01		50 005 619	
04.2003→ Reference	OM 542 942	542 180 00 01	542 180 01 01	542 180 02 01	542 180 07 01		50 005 838
Actros 2531							349
09.1996→02.2003 Reference	OM 541 920, 940	542 200 05 01	542 200 15 01	542 200 19 01		50 005 619	

M



MERCEDES-BENZ

						
09.1996→02.2003 Reference	OM 541 541 200 01 01	920, 940 541 200 11 01	541 200 12 01			50 005 628
09.1996→02.2003 Reference	OM 541 541 180 00 01	920, 940 541 180 01 01	541 180 02 01 541 180 03 01			50 005 831
Actros 2532						350
09.1996→ Reference	OM 541 542 200 05 01	920, 940 542 200 15 01	542 200 19 01			50 005 619
09.1996→ Reference	OM 541 541 200 01 01	920, 940 541 200 11 01	541 200 12 01			50 005 628
09.1996→ Reference	OM 541 541 180 00 01	920, 940 541 180 01 01	541 180 02 01 541 180 03 01			50 005 831
Actros 2535						351
09.1996→02.2003 Reference	OM 541 542 200 05 01	922, 942 542 200 15 01	542 200 19 01			50 005 619
09.1996→02.2003 Reference	OM 541 541 200 01 01	922, 942 541 200 11 01	541 200 12 01			50 005 628
09.1996→02.2003 Reference	OM 541 541 180 00 01	922, 942 541 180 01 01	541 180 02 01 541 180 03 01			50 005 831
Actros 2536						352
04.2003→ Reference	OM 541 542 200 05 01	942 542 200 15 01	542 200 19 01			50 005 619
04.2003→ Reference	OM 541 541 200 01 01	942 541 200 11 01	541 200 12 01			50 005 628
04.2003→ Reference	OM 541 541 180 00 01	942 541 180 01 01	541 180 02 01 541 180 03 01			50 005 831

M





Actros 2539

353

09.1996→ Reference	OM 541 923 542 200 05 01 542 200 15 01 542 200 19 01		50 005 619
09.1996→ Reference	OM 541 923 541 200 01 01 541 200 11 01 541 200 12 01		50 005 628

Actros 2540



354

09.1996→ Reference	OM 541 923, 944 542 200 05 01 542 200 15 01 542 200 19 01		50 005 619
09.1996→ Reference	OM 541 923, 944 541 200 01 01 541 200 11 01 541 200 12 01		50 005 628
09.1996→ Reference	OM 541 923, 944 541 180 00 01 541 180 01 01 541 180 02 01 541 180 03 01		50 005 831

M



Actros 2541

355

04.2003→ Reference	OM 541 944 542 200 05 01 542 200 15 01 542 200 19 01		50 005 619
04.2003→ Reference	OM 541 944 541 200 01 01 541 200 11 01 541 200 12 01		50 005 628
04.2003→ Reference	OM 541 944 541 180 00 01 541 180 01 01 541 180 02 01 541 180 03 01		50 005 831















Actros 2543

356

09.1996→02.2003 Reference	OM 541 925, 946 542 200 05 01 542 200 15 01 542 200 19 01		50 005 619
09.1996→02.2003 Reference	OM 541 925, 946 541 200 01 01 541 200 11 01 541 200 12 01		50 005 628



MERCEDES-BENZ



							
09.1996→02.2003 Reference	OM 541 541 180 00 01	925, 946 541 180 01 01	541 180 02 01	541 180 03 01		50 005 831	
Actros 2544							357
04.2003→ Reference	OM 541 542 200 05 01	946 542 200 15 01	542 200 19 01				50 005 619
04.2003→ Reference	OM 541 541 200 01 01	946 541 200 11 01	541 200 12 01				50 005 628
04.2003→ Reference	OM 541 541 180 00 01	946 541 180 01 01	541 180 02 01	541 180 03 01		50 005 831	
Actros 2546							358
04.2003→ Reference	OM 541 542 200 05 01	948 542 200 15 01	542 200 19 01				50 005 619
04.2003→ Reference	OM 541 541 200 01 01	948 541 200 11 01	541 200 12 01				50 005 628
04.2003→ Reference	OM 541 541 180 00 01	948 541 180 01 01	541 180 02 01	541 180 03 01		50 005 831	
Actros 2548							359
09.1996→04.2003 09.1996→02.2003 Reference	OM 541 OM 542 542 200 05 01	940, 948 921, 925, 940 542 200 15 01	542 200 19 01				50 005 619
09.1996→04.2003 Reference	OM 541 541 200 01 01	940, 948 541 200 11 01	541 200 12 01				50 005 628
09.1996→04.2003 Reference	OM 541 541 180 00 01	940, 948 541 180 01 01	541 180 02 01	541 180 03 01		50 005 831	
09.1996→02.2003 Reference	OM 542 542 180 00 01	921, 925, 940 542 180 01 01	542 180 02 01	542 180 07 01		50 005 838	

M





Actros 2550

360

04.2003→ Reference	OM 542 941 542 200 05 01 542 200 15 01 542 200 19 01			50 005 619
04.2003→ Reference	OM 542 941 542 180 00 01 542 180 01 01 542 180 02 01 542 180 07 01		50 005 838	



Actros 2553

361

09.1996→02.2003 Reference	OM 542 920, 942 542 200 05 01 542 200 15 01 542 200 19 01			50 005 619
09.1996→02.2003 Reference	OM 542 920, 942 542 180 00 01 542 180 01 01 542 180 02 01 542 180 07 01		50 005 838	



Actros 2554

362

04.2003→ Reference	OM 542 942 542 200 05 01 542 200 15 01 542 200 19 01			50 005 619
04.2003→ Reference	OM 542 942 542 180 00 01 542 180 01 01 542 180 02 01 542 180 07 01		50 005 838	

Actros 2557

363

09.1996→02.2003 Reference	OM 542 922, 944 542 200 05 01 542 200 15 01 542 200 19 01			50 005 619
09.1996→02.2003 Reference	OM 542 922, 944 542 180 00 01 542 180 01 01 542 180 02 01 542 180 07 01		50 005 838	

Actros 2558

364

04.2003→ Reference	OM 542 944 542 200 05 01 542 200 15 01 542 200 19 01			50 005 619

M





				
04.2003→ Reference	OM 542 944 542 180 00 01 542 180 01 01 542 180 02 01 542 180 07 01		50 005 838	
Actros 2631				365
09.1996→02.2003 Reference	OM 541 920, 940 542 200 05 01 542 200 15 01 542 200 19 01			50 005 619
09.1996→02.2003 Reference	OM 541 920, 940 541 200 01 01 541 200 11 01 541 200 12 01			50 005 628
09.1996→02.2003 Reference	OM 541 920, 940 541 180 00 01 541 180 01 01 541 180 02 01 541 180 03 01		50 005 831	
Actros 2632				366
04.2003→ Reference	OM 541 940 542 200 05 01 542 200 15 01 542 200 19 01			50 005 619
04.2003→ Reference	OM 541 940 541 200 01 01 541 200 11 01 541 200 12 01			50 005 628
04.2003→ Reference	OM 541 940 541 180 00 01 541 180 01 01 541 180 02 01 541 180 03 01		50 005 831	
Actros 2635				367
09.1996→02.2003 Reference	OM 541 922, 942 542 200 05 01 542 200 15 01 542 200 19 01			50 005 619
09.1996→02.2003 Reference	OM 541 922, 942 541 200 01 01 541 200 11 01 541 200 12 01			50 005 628
09.1996→02.2003 Reference	OM 541 922, 942 541 180 00 01 541 180 01 01 541 180 02 01 541 180 03 01		50 005 831	

M





Actros 2636

368

04.2003→ Reference	OM 541 942 542 200 05 01 542 200 15 01 542 200 19 01		50 005 619
04.2003→ Reference	OM 541 942 541 200 01 01 541 200 11 01 541 200 12 01		50 005 628
04.2003→ Reference	OM 541 942 541 180 00 01 541 180 01 01 541 180 02 01 541 180 03 01		50 005 831



Actros 2640

369

09.1996→ Reference	OM 541 923, 944 542 200 05 01 542 200 15 01 542 200 19 01		50 005 619
09.1996→ Reference	OM 541 923, 944 541 200 01 01 541 200 11 01 541 200 12 01		50 005 628
09.1996→ Reference	OM 541 923, 944 541 180 00 01 541 180 01 01 541 180 02 01 541 180 03 01		50 005 831

Actros 2641

370

06.2003→ Reference	OM 541 944 542 200 05 01 542 200 15 01 542 200 19 01		50 005 619
06.2003→ Reference	OM 541 944 541 200 01 01 541 200 11 01 541 200 12 01		50 005 628
06.2003→ Reference	OM 541 944 541 180 00 01 541 180 01 01 541 180 02 01 541 180 03 01		50 005 831

Actros 2643

371

09.1996→02.2003 Reference	OM 541 925, 946 542 200 05 01 542 200 15 01 542 200 19 01		50 005 619

M



MERCEDES-BENZ

						
09.1996→02.2003 Reference	OM 541 541 200 01 01	925, 946 541 200 11 01	541 200 12 01			50 005 628
09.1996→02.2003 Reference	OM 541 541 180 00 01	925, 946 541 180 01 01	541 180 02 01 541 180 03 01			50 005 831
Actros 2644						372
06.2003→ Reference	OM 541 542 200 05 01	946 542 200 15 01	542 200 19 01			50 005 619
06.2003→ Reference	OM 541 541 200 01 01	946 541 200 11 01	541 200 12 01			50 005 628
06.2003→ Reference	OM 541 541 180 00 01	946 541 180 01 01	541 180 02 01 541 180 03 01			50 005 831
Actros 2646						373
06.2003→ Reference	OM 541 542 200 05 01	948 542 200 15 01	542 200 19 01			50 005 619
06.2003→ Reference	OM 541 541 200 01 01	948 541 200 11 01	541 200 12 01			50 005 628
06.2003→ Reference	OM 541 541 180 00 01	948 541 180 01 01	541 180 02 01 541 180 03 01			50 005 831
Actros 2648						374
→04.2003 09.1996→02.2003 Reference	OM 541 OM 542 542 200 05 01	948 921, 940 542 200 15 01	542 200 19 01			50 005 619
→04.2003 Reference	OM 541 541 200 01 01	948 541 200 11 01	541 200 12 01			50 005 628
→04.2003 Reference	OM 541 541 180 00 01	948 541 180 01 01	541 180 02 01 541 180 03 01			50 005 831



M





							
09.1996→02.2003 Reference	OM 542 921, 940 542 180 00 01	542 180 01 01	542 180 02 01	542 180 07 01			50 005 838
Actros 2650							375
04.2003→ Reference	OM 542 941 542 200 05 01	542 200 15 01	542 200 19 01				50 005 619
04.2003→ Reference	OM 542 941 542 180 00 01	542 180 01 01	542 180 02 01	542 180 07 01			50 005 838
Actros 2653							376
09.1996→02.2003 Reference	OM 542 920, 942 542 200 05 01	542 200 15 01	542 200 19 01				50 005 619
09.1996→02.2003 Reference	OM 542 920, 942 542 180 00 01	542 180 01 01	542 180 02 01	542 180 07 01			50 005 838
Actros 2654							377
04.2003→ Reference	OM 542 942 542 200 05 01	542 200 15 01	542 200 19 01				50 005 619
04.2003→ Reference	OM 542 942 542 180 00 01	542 180 01 01	542 180 02 01	542 180 07 01			50 005 838
Actros 2657							378
09.1996→02.2003 Reference	OM 542 922, 944 542 200 05 01	542 200 15 01	542 200 19 01				50 005 619
09.1996→02.2003 Reference	OM 542 922, 944 542 180 00 01	542 180 01 01	542 180 02 01	542 180 07 01			50 005 838

M



**Actros 2658****379**

04.2003→ Reference	OM 542 944 542 200 05 01 542 200 15 01 542 200 19 01		50 005 619
04.2003→ Reference	OM 542 944 542 180 00 01 542 180 01 01 542 180 02 01 542 180 07 01		50 005 838



Actros 3231**380**

09.1996→02.2003 Reference	OM 541 920, 940 542 200 05 01 542 200 15 01 542 200 19 01		50 005 619
09.1996→02.2003 Reference	OM 541 920, 940 541 200 01 01 541 200 11 01 541 200 12 01		50 005 628
09.1996→02.2003 Reference	OM 541 920, 940 541 180 00 01 541 180 01 01 541 180 02 01 541 180 03 01		50 005 831

M**Actros 3232****381**

04.2003→ Reference	OM 541 940 542 200 05 01 542 200 15 01 542 200 19 01		50 005 619
04.2003→ Reference	OM 541 940 541 200 01 01 541 200 11 01 541 200 12 01		50 005 628
04.2003→ Reference	OM 541 940 541 180 00 01 541 180 01 01 541 180 02 01 541 180 03 01		50 005 831

Actros 3235**382**

04.1997→02.2003 Reference	OM 541 922, 942 542 200 05 01 542 200 15 01 542 200 19 01		50 005 619
04.1997→02.2003 Reference	OM 541 922, 942 541 200 01 01 541 200 11 01 541 200 12 01		50 005 628





				
04.1997→02.2003 Reference	OM 541 922, 942 541 180 00 01 541 180 01 01 541 180 02 01 541 180 03 01		50 005 831	
Actros 3236 383				
04.2003→ Reference	OM 541 942 542 200 05 01 542 200 15 01 542 200 19 01			50 005 619
04.2003→ Reference	OM 541 942 541 200 01 01 541 200 11 01 541 200 12 01			50 005 628
04.2003→ Reference	OM 541 942 541 180 00 01 541 180 01 01 541 180 02 01 541 180 03 01		50 005 831	
Actros 3240 384				
04.1997→02.2003 Reference	OM 541 923, 944 542 200 05 01 542 200 15 01 542 200 19 01			50 005 619
04.1997→02.2003 Reference	OM 541 923, 944 541 200 01 01 541 200 11 01 541 200 12 01			50 005 628
04.1997→02.2003 Reference	OM 541 923, 944 541 180 00 01 541 180 01 01 541 180 02 01 541 180 03 01		50 005 831	
Actros 3241 385				
04.1997→ Reference	OM 541 923, 944 542 200 05 01 542 200 15 01 542 200 19 01			50 005 619
04.1997→ Reference	OM 541 923, 944 541 200 01 01 541 200 11 01 541 200 12 01			50 005 628
04.2003→ Reference	OM 541 944 541 180 00 01 541 180 01 01 541 180 02 01 541 180 03 01		50 005 831	

M





Actros 3243

386

04.1997→ Reference	OM 541 925, 946, 948 542 200 05 01 542 200 15 01 542 200 19 01		50 005 619
04.1997→ Reference	OM 541 925, 946, 948 541 200 01 01 541 200 11 01 541 200 12 01		50 005 628
04.1997→ Reference	OM 541 925, 946, 948 541 180 00 01 541 180 01 01 541 180 02 01 541 180 03 01		50 005 831

Actros 3244



387

04.1997→ Reference	OM 541 925, 946 542 200 05 01 542 200 15 01 542 200 19 01		50 005 619
04.1997→ Reference	OM 541 925, 946 541 200 01 01 541 200 11 01 541 200 12 01		50 005 628
04.1997→ Reference	OM 541 925, 946 541 180 00 01 541 180 01 01 541 180 02 01 541 180 03 01		50 005 831

M

Actros 3248

388

04.1997→04.2003 Reference	OM 541 948 542 200 05 01 542 200 15 01 542 200 19 01		50 005 619
04.1997→04.2003 Reference	OM 541 948 541 200 01 01 541 200 11 01 541 200 12 01		50 005 628
04.1997→04.2003 Reference	OM 541 948 541 180 00 01 541 180 01 01 541 180 02 01 541 180 03 01		50 005 831

Actros 3331

389

09.1996→02.2003 Reference	OM 541 920, 926, 940-941 542 200 05 01 542 200 15 01 542 200 19 01		50 005 619





09.1996→02.2003 Reference	OM 541 541 200 01 01	920, 926, 940-941 541 200 11 01	541 200 12 01	 50 005 628
09.1996→02.2003 Reference	OM 541 541 180 00 01	920, 926, 940-941 541 180 01 01	541 180 02 01 541 180 03 01	 50 005 831
Actros 3332				390
04.2003→ Reference	OM 541 542 200 05 01	940 542 200 15 01	542 200 19 01	 50 005 619
04.2003→ Reference	OM 541 541 200 01 01	940 541 200 11 01	541 200 12 01	 50 005 628
04.2003→ Reference	OM 541 541 180 00 01	940 541 180 01 01	541 180 02 01 541 180 03 01	 50 005 831
Actros 3335				391
04.1997→02.2003 Reference	OM 541 542 200 05 01	922, 927, 942-943 542 200 15 01	542 200 19 01	 50 005 619
04.1997→02.2003 Reference	OM 541 541 200 01 01	922, 927, 942-943 541 200 11 01	541 200 12 01	 50 005 628
04.1997→02.2003 Reference	OM 541 541 180 00 01	922, 927, 942-943 541 180 01 01	541 180 02 01 541 180 03 01	 50 005 831
Actros 3336				392
04.2003→ Reference	OM 541 542 200 05 01	942 542 200 15 01	542 200 19 01	 50 005 619
04.2003→ Reference	OM 541 541 200 01 01	942 541 200 11 01	541 200 12 01	 50 005 628
04.2003→ Reference	OM 541 541 180 00 01	942 541 180 01 01	541 180 02 01 541 180 03 01	 50 005 831

M





Actros 3340

393

04.1997→ Reference	OM 541 923-924, 944-945, 948 542 200 05 01 542 200 15 01 542 200 19 01			50 005 619
04.1997→ Reference	OM 541 923-924, 944-945, 948 541 200 01 01 541 200 11 01 541 200 12 01			50 005 628
04.1997→ Reference	OM 541 923-924, 944-945, 948 541 180 00 01 541 180 01 01 541 180 02 01 541 180 03 01		50 005 831	

Actros 3341



394

04.2003→ Reference	OM 541 944 542 200 05 01 542 200 15 01 542 200 19 01			50 005 619
04.2003→ Reference	OM 541 944 541 200 01 01 541 200 11 01 541 200 12 01			50 005 628
04.2003→ Reference	OM 541 944 541 180 00 01 541 180 01 01 541 180 02 01 541 180 03 01		50 005 831	

M

Actros 3343

395

09.1996→04.2003 Reference	OM 541 921, 925, 946-948 OM 941 921, 929 542 200 05 01 542 200 15 01 542 200 19 01			50 005 619
09.1996→04.2003 Reference	OM 541 921, 925, 946-948 OM 941 921, 929 541 200 01 01 541 200 11 01 541 200 12 01			50 005 628
09.1996→04.2003 Reference	OM 541 921, 925, 946-948 OM 941 921, 929 541 180 00 01 541 180 01 01 541 180 02 01 541 180 03 01		50 005 831	

Actros 3344

396

06.2003→ Reference	OM 541 946 542 200 05 01 542 200 15 01 542 200 19 01			50 005 619



06.2003→ Reference	OM 541 946 541 200 01 01 541 200 11 01 541 200 12 01			50 005 628
06.2003→ Reference	OM 541 946 541 180 00 01 541 180 01 01 541 180 02 01 541 180 03 01		50 005 831	

Actros 3346**397**

06.2003→ Reference	OM 541 948 542 200 05 01 542 200 15 01 542 200 19 01			50 005 619
06.2003→ Reference	OM 541 948 541 200 01 01 541 200 11 01 541 200 12 01			50 005 628
06.2003→ Reference	OM 541 948 541 180 00 01 541 180 01 01 541 180 02 01 541 180 03 01		50 005 831	













Actros 3348**398****M**

04.1997→ 09.1996→02.2003 Reference	OM 541 948-949 OM 542 921, 925, 940-941 542 200 05 01 542 200 15 01 542 200 19 01			50 005 619
04.1997→ Reference	OM 541 948-949 541 200 01 01 541 200 11 01 541 200 12 01			50 005 628
04.1997→ Reference	OM 541 948-949 541 180 00 01 541 180 01 01 541 180 02 01 541 180 03 01		50 005 831	
09.1996→02.2003 Reference	OM 542 921, 925, 940-941 542 180 00 01 542 180 01 01 542 180 02 01 542 180 07 01		50 005 838	

Actros 3350**399**

04.2003→ Reference	OM 542 941 542 200 05 01 542 200 15 01 542 200 19 01			50 005 619





							
04.2003→ Reference	OM 542 941 542 180 00 01	542 180 01 01	542 180 02 01	542 180 07 01		50 005 838	
Actros 3353							400
09.1996→ Reference	OM 542 920, 926, 942-943 542 200 05 01	542 200 15 01	542 200 19 01				50 005 619
09.1996→ Reference	OM 542 920, 926, 942-943 542 180 00 01	542 180 01 01	542 180 02 01	542 180 07 01		50 005 838	
Actros 3354							401
04.2003→ Reference	OM 542 942 542 200 05 01	542 200 15 01	542 200 19 01				50 005 619
04.2003→ Reference	OM 542 942 542 180 00 01	542 180 01 01	542 180 02 01	542 180 07 01		50 005 838	
Actros 3357							402
09.1996→02.2003 Reference	OM 542 922, 944 542 200 05 01	542 200 15 01	542 200 19 01				50 005 619
09.1996→02.2003 Reference	OM 542 922, 944 542 180 00 01	542 180 01 01	542 180 02 01	542 180 07 01		50 005 838	
Actros 3358							403
04.2003→ Reference	OM 542 944 542 200 05 01	542 200 15 01	542 200 19 01				50 005 619
04.2003→ Reference	OM 542 944 542 180 00 01	542 180 01 01	542 180 02 01	542 180 07 01		50 005 838	

M





Actros 4140

404

04.1997→ Reference	OM 541 923-924, 944-945, 948 542 200 05 01 542 200 15 01 542 200 19 01			50 005 619
04.1997→ Reference	OM 541 923-924, 944-945, 948 541 200 01 01 541 200 11 01 541 200 12 01			50 005 628
04.1997→ Reference	OM 541 923-924, 944-945, 948 541 180 00 01 541 180 01 01 541 180 02 01 541 180 03 01		50 005 831	



Actros 4141

405

04.2003→ Reference	OM 541 944 542 200 05 01 542 200 15 01 542 200 19 01			50 005 619
04.2003→ Reference	OM 541 944 541 200 01 01 541 200 11 01 541 200 12 01			50 005 628
04.2003→ Reference	OM 541 944 541 180 00 01 541 180 01 01 541 180 02 01 541 180 03 01		50 005 831	

Actros 4143

406

09.1996→04.2003 Reference	OM 541 921, 925, 946-948 542 200 05 01 542 200 15 01 542 200 19 01			50 005 619
09.1996→04.2003 Reference	OM 541 921, 925, 946-948 541 200 01 01 541 200 11 01 541 200 12 01			50 005 628
09.1996→04.2003 Reference	OM 541 921, 925, 946-948 541 180 00 01 541 180 01 01 541 180 02 01 541 180 03 01		50 005 831	

Actros 4144















407

06.2003→ Reference	OM 541 946 542 200 05 01 542 200 15 01 542 200 19 01			50 005 619

M



MERCEDES-BENZ

						
06.2003→ Reference	OM 541 946 541 200 01 01	541 200 11 01	541 200 12 01			50 005 628
06.2003→ Reference	OM 541 946 541 180 00 01	541 180 01 01	541 180 02 01	541 180 03 01		50 005 831
Actros 4146						408
04.2003→ Reference	OM 541 948 542 200 05 01	542 200 15 01	542 200 19 01			50 005 619
04.2003→ Reference	OM 541 948 541 200 01 01	541 200 11 01	541 200 12 01			50 005 628
04.2003→ Reference	OM 541 948 541 180 00 01	541 180 01 01	541 180 02 01	541 180 03 01		50 005 831
Actros 4148						409
04.1997→ 04.1997→02.2003 Reference	OM 541 948-949 OM 542 921, 925, 940-941 542 200 05 01	542 200 15 01	542 200 19 01			50 005 619
04.1997→ Reference	OM 541 948-949 541 200 01 01	541 200 11 01	541 200 12 01			50 005 628
04.1997→ Reference	OM 541 948-949 541 180 00 01	541 180 01 01	541 180 02 01	541 180 03 01		50 005 831
04.1997→02.2003 Reference	OM 542 921, 925, 940-941 542 180 00 01	542 180 01 01	542 180 02 01	542 180 07 01		50 005 838
Actros 4150						410
04.2003→ Reference	OM 542 941 542 200 05 01	542 200 15 01	542 200 19 01			50 005 619

M



04.2003→ Reference	OM 542 941 542 180 00 01	542 180 01 01	542 180 02 01	542 180 07 01		50 005 838	
Atego 712							411
03.1997→ Reference	OM 904 909, 915-916, 922 904 200 04 01 904 200 22 01 904 201 07 01	904 200 06 01 904 200 26 01	904 200 08 01 904 200 49 01	904 200 20 01 904 201 02 01		50 005 627	
Atego 714							412
06.1997→ Reference	OM 904 910, 916 904 200 04 01 904 200 22 01 904 201 07 01	904 200 06 01 904 200 26 01	904 200 08 01 904 200 49 01	904 200 20 01 904 201 02 01		50 005 627	
Atego 715							413
06.1997→ Reference	OM 904 909, 916, 922, 950 904 200 04 01 904 200 22 01 904 201 07 01	904 200 06 01 904 200 26 01	904 200 08 01 904 200 49 01	904 200 20 01 904 201 02 01		50 005 627	
Atego 716							414
01.1998→ Reference	OM 904 922 904 200 04 01 904 200 22 01 904 201 07 01	904 200 06 01 904 200 26 01	904 200 08 01 904 200 49 01	904 200 20 01 904 201 02 01		50 005 627	
Atego 717							415
01.1998→ Reference	OM 904 911 904 200 04 01 904 200 22 01 904 201 07 01	904 200 06 01 904 200 26 01	904 200 08 01 904 200 49 01	904 200 20 01 904 201 02 01		50 005 627	
Atego 812							416
03.1997→ Reference	OM 904 909, 915, 922 904 200 04 01 904 200 22 01 904 201 07 01	904 200 06 01 904 200 26 01	904 200 08 01 904 200 49 01	904 200 20 01 904 201 02 01		50 005 627	
Atego 814							417
06.1997→ Reference	OM 904 910, 916, 921 904 200 04 01 904 200 22 01 904 201 07 01	904 200 06 01 904 200 26 01	904 200 08 01 904 200 49 01	904 200 20 01 904 201 02 01		50 005 627	
Atego 815							418
06.1997→ 01.1998→ Reference	OM 904 909-910, 916, 922, 950 OM 906 910 904 200 04 01 904 200 22 01 904 201 07 01	904 200 06 01 904 200 26 01	904 200 08 01 904 200 49 01	904 200 20 01 904 201 02 01		50 005 627	
Atego 817							419
03.1997→ 01.1998→ Reference	OM 904 909-911, 917, 922 OM 906 910 904 200 04 01 904 200 22 01 904 201 07 01	904 200 06 01 904 200 26 01	904 200 08 01 904 200 49 01	904 200 20 01 904 201 02 01		50 005 627	
Atego 818 Blue Tec							420
06.1997→ Reference	OM 904 909-911, 915-917, 951 904 200 04 01 904 200 22 01 904 201 07 01	904 200 06 01 904 200 26 01	904 200 08 01 904 200 49 01	904 200 20 01 904 201 02 01		50 005 627	

M



Atego 823

421

01.1998→	OM 904	910, 922			
01.1998→	OM 906	910, 915, 925			
Reference	904 200 04 01	904 200 06 01	904 200 08 01	904 200 20 01	
	904 200 22 01	904 200 26 01	904 200 49 01	904 201 02 01	
	904 201 07 01				

**50 005 627**

Atego 915

422

	OM 904	911, 922, 943, 950			
Reference	904 200 04 01	904 200 06 01	904 200 08 01	904 200 20 01	
	904 200 22 01	904 200 26 01	904 200 49 01	904 201 02 01	
	904 201 07 01				

**50 005 627**

Atego 917

423

03.1997→	OM 904	911, 917, 922			
01.1998→	OM 906	910			
Reference	904 200 04 01	904 200 06 01	904 200 08 01	904 200 20 01	
	904 200 22 01	904 200 26 01	904 200 49 01	904 201 02 01	
	904 201 07 01				

**50 005 627**

Atego 918

424

09.2000→	OM 904	951			
Reference	904 200 04 01	904 200 06 01	904 200 08 01	904 200 20 01	
	904 200 22 01	904 200 26 01	904 200 49 01	904 201 02 01	
	904 201 07 01				

**50 005 627**

Atego 923

425

01.1998→	OM 906	910, 915, 925			
Reference	904 200 04 01	904 200 06 01	904 200 08 01	904 200 20 01	
	904 200 22 01	904 200 26 01	904 200 49 01	904 201 02 01	
	904 201 07 01				

**50 005 627**

Atego 925

426

01.1998→	OM 906	919, 939			
Reference	904 200 04 01	904 200 06 01	904 200 08 01	904 200 20 01	
	904 200 22 01	904 200 26 01	904 200 49 01	904 201 02 01	
	904 201 07 01				

**50 005 627**

Atego 1015

427

06.1997→	OM 904	916, 922, 950			
09.2000→	OM 906	915			
Reference	904 200 04 01	904 200 06 01	904 200 08 01	904 200 20 01	
	904 200 22 01	904 200 26 01	904 200 49 01	904 201 02 01	
	904 201 07 01				

**50 005 627**

Atego 1017

428

03.1997→	OM 904	911, 917			
01.1998→	OM 906	910			
Reference	904 200 04 01	904 200 06 01	904 200 08 01	904 200 20 01	
	904 200 22 01	904 200 26 01	904 200 49 01	904 201 02 01	
	904 201 07 01				

**50 005 627**

Atego 1018

429

03.1997→	OM 904	911, 916-917, 951			
01.1998→	OM 906	910, 915			
Reference	904 200 04 01	904 200 06 01	904 200 08 01	904 200 20 01	
	904 200 22 01	904 200 26 01	904 200 49 01	904 201 02 01	
	904 201 07 01				

**50 005 627**

Atego 1023

430

06.1997→	OM 904	916			
01.1998→	OM 906	910, 915, 925			
Reference	904 200 04 01	904 200 06 01	904 200 08 01	904 200 20 01	
	904 200 22 01	904 200 26 01	904 200 49 01	904 201 02 01	
	904 201 07 01				

**50 005 627**

**Atego 1024****431**

01.1998→	OM 906	910, 915			
Reference	904 200 04 01	904 200 06 01	904 200 08 01	904 200 20 01	
	904 200 22 01	904 200 26 01	904 200 49 01	904 201 02 01	
	904 201 07 01				

**50 005 627****Atego 1214****432**

06.1997→	OM 904	910, 916			
Reference	904 200 04 01	904 200 06 01	904 200 08 01	904 200 20 01	
	904 200 22 01	904 200 26 01	904 200 49 01	904 201 02 01	
	904 201 07 01				

**50 005 627****Atego 1215****433**

06.1997→	OM 904	910, 916, 922, 950			
01.1998→	OM 906	910-911			
Reference	904 200 04 01	904 200 06 01	904 200 08 01	904 200 20 01	
	904 200 22 01	904 200 26 01	904 200 49 01	904 201 02 01	
	904 201 07 01				

**50 005 627****Atego 1217****434**

03.1997→	OM 904	910-911, 917, 922			
01.1998→	OM 906	910-911			
Reference	904 200 04 01	904 200 06 01	904 200 08 01	904 200 20 01	
	904 200 22 01	904 200 26 01	904 200 49 01	904 201 02 01	
	904 201 07 01				

**50 005 627****Atego 1218****435**

09.2000→	OM 904	951			
Reference	904 200 04 01	904 200 06 01	904 200 08 01	904 200 20 01	
	904 200 22 01	904 200 26 01	904 200 49 01	904 201 02 01	
	904 201 07 01				

**50 005 627****Atego 1223****436**

01.1998→	OM 904	910, 922			
01.1998→	OM 906	910-911, 915, 954			
Reference	904 200 04 01	904 200 06 01	904 200 08 01	904 200 20 01	
	904 200 22 01	904 200 26 01	904 200 49 01	904 201 02 01	
	904 201 07 01				

**50 005 627****Atego 1224****437**

01.1998→	OM 906	915			
Reference	904 200 04 01	904 200 06 01	904 200 08 01	904 200 20 01	
	904 200 22 01	904 200 26 01	904 200 49 01	904 201 02 01	
	904 201 07 01				

**50 005 627****Atego 1225****438**

01.1998→	OM 906	919, 939			
Reference	904 200 04 01	904 200 06 01	904 200 08 01	904 200 20 01	
	904 200 22 01	904 200 26 01	904 200 49 01	904 201 02 01	
	904 201 07 01				

**50 005 627****Atego 1228****439**

01.1998→	OM 904	910, 922			
01.1998→	OM 906	910-911, 916			
Reference	904 200 04 01	904 200 06 01	904 200 08 01	904 200 20 01	
	904 200 22 01	904 200 26 01	904 200 49 01	904 201 02 01	
	904 201 07 01				

**50 005 627****Atego 1317****440**

01.1998→	OM 904	911, 917			
01.1998→	OM 906	910-911			
Reference	904 200 04 01	904 200 06 01	904 200 08 01	904 200 20 01	
	904 200 22 01	904 200 26 01	904 200 49 01	904 201 02 01	
	904 201 07 01				

**50 005 627****M**

**Atego 1318****441**

09.2000→	OM 904	951						
Reference	904 200 04 01	904 200 06 01	904 200 08 01	904 200 20 01				50 005 627
	904 200 22 01	904 200 26 01	904 200 49 01	904 201 02 01				
	904 201 07 01							

Atego 1323**442**

01.1998→	OM 906	910-911, 915						
Reference	904 200 04 01	904 200 06 01	904 200 08 01	904 200 20 01				50 005 627
	904 200 22 01	904 200 26 01	904 200 49 01	904 201 02 01				
	904 201 07 01							

Atego 1324**443**

01.1998→	OM 906	910						
Reference	904 200 04 01	904 200 06 01	904 200 08 01	904 200 20 01				50 005 627
	904 200 22 01	904 200 26 01	904 200 49 01	904 201 02 01				
	904 201 07 01							

Atego 1325**444**

01.1998→	OM 906	911, 919, 939						
Reference	904 200 04 01	904 200 06 01	904 200 08 01	904 200 20 01				50 005 627
	904 200 22 01	904 200 26 01	904 200 49 01	904 201 02 01				
	904 201 07 01							

Atego 1328**445**

01.1998→	OM 906	910-911, 916, 919						
Reference	904 200 04 01	904 200 06 01	904 200 08 01	904 200 20 01				50 005 627
	904 200 22 01	904 200 26 01	904 200 49 01	904 201 02 01				
	904 201 07 01							

Atego 1517**446**

01.1998→	OM 904	911, 917						
01.1998→	OM 906	910-911						
Reference	904 200 04 01	904 200 06 01	904 200 08 01	904 200 20 01				50 005 627
	904 200 22 01	904 200 26 01	904 200 49 01	904 201 02 01				
	904 201 07 01							

Atego 1518**447**

03.1997→	OM 904	911, 917, 951						
Reference	904 200 04 01	904 200 06 01	904 200 08 01	904 200 20 01				50 005 627
	904 200 22 01	904 200 26 01	904 200 49 01	904 201 02 01				
	904 201 07 01							

Atego 1523**448**

01.1998→	OM 906	910-911, 915, 925, 954						
Reference	904 200 04 01	904 200 06 01	904 200 08 01	904 200 20 01				50 005 627
	904 200 22 01	904 200 26 01	904 200 49 01	904 201 02 01				
	904 201 07 01							

Atego 1524**449**

01.1998→	OM 906	915						
Reference	904 200 04 01	904 200 06 01	904 200 08 01	904 200 20 01				50 005 627
	904 200 22 01	904 200 26 01	904 200 49 01	904 201 02 01				
	904 201 07 01							

Atego 1525**450**

01.1998→	OM 906	911, 919, 939						
Reference	904 200 04 01	904 200 06 01	904 200 08 01	904 200 20 01				50 005 627
	904 200 22 01	904 200 26 01	904 200 49 01	904 201 02 01				
	904 201 07 01							

Atego 1528**451**

01.1998→	OM 906	910-911, 916, 919						
Reference	904 200 04 01	904 200 06 01	904 200 08 01	904 200 20 01				50 005 627
	904 200 22 01	904 200 26 01	904 200 49 01	904 201 02 01				
	904 201 07 01							

M



Atego 1721					452	
01.1998→	OM 906	917				50 005 627
Reference	904 200 04 01	904 200 06 01	904 200 08 01	904 200 20 01		
	904 200 22 01	904 200 26 01	904 200 49 01	904 201 02 01		
	904 201 07 01					
Atego 1722					453	
01.1998→	OM 906	917-918				50 005 627
Reference	904 200 04 01	904 200 06 01	904 200 08 01	904 200 20 01		
	904 200 22 01	904 200 26 01	904 200 49 01	904 201 02 01		
	904 201 07 01					
Atego 1725					454	
01.1998→	OM 906	918, 983				50 005 627
Reference	904 200 04 01	904 200 06 01	904 200 08 01	904 200 20 01		
	904 200 22 01	904 200 26 01	904 200 49 01	904 201 02 01		
	904 201 07 01					
Atego 1728					455	
01.1998→	OM 906	918				50 005 627
Reference	904 200 04 01	904 200 06 01	904 200 08 01	904 200 20 01		
	904 200 22 01	904 200 26 01	904 200 49 01	904 201 02 01		
	904 201 07 01					
Atego 1823					456	
01.1998→	OM 906	920-923, 925, 927				50 005 627
Reference	904 200 04 01	904 200 06 01	904 200 08 01	904 200 20 01		
	904 200 22 01	904 200 26 01	904 200 49 01	904 201 02 01		
	904 201 07 01					
Atego 1828					457	
01.1998→	OM 906	921-923, 925-926, 928, 956				50 005 627
Reference	904 200 04 01	904 200 06 01	904 200 08 01	904 200 20 01		
	904 200 22 01	904 200 26 01	904 200 49 01	904 201 02 01		
	904 201 07 01					
Atego 1923					458	
01.1998→	OM 906	910, 915				50 005 627
Reference	904 200 04 01	904 200 06 01	904 200 08 01	904 200 20 01		
	904 200 22 01	904 200 26 01	904 200 49 01	904 201 02 01		
	904 201 07 01					
Atego 2223					459	
01.1998→	OM 906	910, 915				50 005 627
Reference	904 200 04 01	904 200 06 01	904 200 08 01	904 200 20 01		
	904 200 22 01	904 200 26 01	904 200 49 01	904 201 02 01		
	904 201 07 01					
Atego 2523					460	
01.1998→	OM 906	920-921, 925				50 005 627
Reference	904 200 04 01	904 200 06 01	904 200 08 01	904 200 20 01		
	904 200 22 01	904 200 26 01	904 200 49 01	904 201 02 01		
	904 201 07 01					
Atego 2528					461	
01.1998→	OM 906	921, 926				50 005 627
Reference	904 200 04 01	904 200 06 01	904 200 08 01	904 200 20 01		
	904 200 22 01	904 200 26 01	904 200 49 01	904 201 02 01		
	904 201 07 01					
Atego 2623					462	
05.1998→	OM 906	920				50 005 627
Reference	904 200 04 01	904 200 06 01	904 200 08 01	904 200 20 01		
	904 200 22 01	904 200 26 01	904 200 49 01	904 201 02 01		
	904 201 07 01					

M

**Atego 2628****463**

01.1998→	OM 906	921, 926			
Reference	904 200 04 01	904 200 06 01	904 200 08 01	904 200 20 01	
	904 200 22 01	904 200 26 01	904 200 49 01	904 201 02 01	
	904 201 07 01				

**50 005 627****Atego 3228****464**

05.1998→	OM 906	921			
Reference	904 200 04 01	904 200 06 01	904 200 08 01	904 200 20 01	
	904 200 22 01	904 200 26 01	904 200 49 01	904 201 02 01	
	904 201 07 01				

**50 005 627****Axor 1823****465**

01.2002→	OM 906	920			
Reference	904 200 04 01	904 200 06 01	904 200 08 01	904 200 20 01	
	904 200 22 01	904 200 26 01	904 200 49 01	904 201 02 01	
	904 201 07 01				

**50 005 627****Axor 1828****466**

01.2002→	OM 906	921			
Reference	904 200 04 01	904 200 06 01	904 200 08 01	904 200 20 01	
	904 200 22 01	904 200 26 01	904 200 49 01	904 201 02 01	
	904 201 07 01				

**50 005 627****Axor 1835****467**

01.2002→	OM 457	937			
Reference	403 180 28 01				
	ohne Antriebsrad, without impeller, sans roue motrice, sin rueda motriz, без ведущего колеса				

**50 005 828**

01.2002→	OM 457	937			
Reference	403 180 27 01				
	mit Antriebsrad, with impeller, avec roue motrice, con rueda motriz, с приводным колесом				

**50 005 827****Axor 1840****468**

01.2002→	OM 457	937			
Reference	403 180 28 01				
	ohne Antriebsrad, without impeller, sans roue motrice, sin rueda motriz, без ведущего колеса				

**50 005 828**

01.2002→	OM 457	937			
Reference	403 180 27 01				
	mit Antriebsrad, with impeller, avec roue motrice, con rueda motriz, с приводным колесом				

**50 005 827****Axor 1843****469**

01.2002→	OM 457	937			
Reference	403 180 28 01				
	ohne Antriebsrad, without impeller, sans roue motrice, sin rueda motriz, без ведущего колеса				

**50 005 828**

01.2002→	OM 457	937			
Reference	403 180 27 01				
	mit Antriebsrad, with impeller, avec roue motrice, con rueda motriz, с приводным колесом				

**50 005 827****Axor 2523****470**

01.2002→	OM 906	920			
Reference	904 200 04 01	904 200 06 01	904 200 08 01	904 200 20 01	
	904 200 22 01	904 200 26 01	904 200 49 01	904 201 02 01	
	904 201 07 01				

**50 005 627****Axor 2528****471**

01.2002→	OM 906	921			
Reference	904 200 04 01	904 200 06 01	904 200 08 01	904 200 20 01	
	904 200 22 01	904 200 26 01	904 200 49 01	904 201 02 01	
	904 201 07 01				

**50 005 627**



Axor 2535

472

01.2002→ Reference 	OM 457 937 403 180 28 01 ohne Antriebsrad, without impeller, sans roue motrice, sin rueda motriz, без ведущего колеса		50 005 828	
01.2002→ Reference 	OM 457 937 403 180 27 01 mit Antriebsrad, with impeller, avec roue motrice, con rueda motriz, с приводным колесом		50 005 827	

Axor 2540

473

01.2002→ Reference 	OM 457 937 403 180 28 01 ohne Antriebsrad, without impeller, sans roue motrice, sin rueda motriz, без ведущего колеса		50 005 828	
01.2002→ Reference 	OM 457 937 403 180 27 01 mit Antriebsrad, with impeller, avec roue motrice, con rueda motriz, с приводным колесом		50 005 827	

Axor 2543

474

01.2002→ Reference 	OM 457 937 403 180 28 01 ohne Antriebsrad, without impeller, sans roue motrice, sin rueda motriz, без ведущего колеса		50 005 828	
01.2002→ Reference 	OM 457 937 403 180 27 01 mit Antriebsrad, with impeller, avec roue motrice, con rueda motriz, с приводным колесом		50 005 827	

Axor 2628

475

01.2002→ Reference	OM 906 921 904 200 04 01 904 200 06 01 904 200 08 01 904 200 20 01 904 200 22 01 904 200 26 01 904 200 49 01 904 201 02 01 904 201 07 01			50 005 627
-----------------------	---	--	--	------------

Citaro O 530

476

Reference 	OM 457 933-935, 942-943 403 180 28 01 ohne Antriebsrad, without impeller, sans roue motrice, sin rueda motriz, без ведущего колеса		50 005 828	
01.1998→ Reference	OM 906 930-931, 934, 938, 960-963 OM 909 900-901, 911, 921 904 200 04 01 904 200 06 01 904 200 08 01 904 200 20 01 904 200 22 01 904 200 26 01 904 200 49 01 904 201 02 01 904 201 07 01			50 005 627
Reference 	OM 457 933-935, 942-943 403 180 27 01 mit Antriebsrad, with impeller, avec roue motrice, con rueda motriz, с приводным колесом		50 005 827	

Citaro O 560

477

Reference 	OM 457 944 403 180 28 01 ohne Antriebsrad, without impeller, sans roue motrice, sin rueda motriz, без ведущего колеса		50 005 828	
Reference 	OM 457 944 403 180 27 01 mit Antriebsrad, with impeller, avec roue motrice, con rueda motriz, с приводным колесом		50 005 827	

M



Citaro O 580

478

Reference  OM 457 936, 938, 940
403 180 28 01
ohne Antriebsrad, without impeller, sans roue motrice, sin rueda motriz, без ведущего колеса

**50 005 828**

Reference  OM 457 936, 938, 940
403 180 27 01
mit Antriebsrad, with impeller, avec roue motrice, con rueda motriz, с приводным колесом

**50 005 827**

Cito O 520

479

01.1998→
08.1995→
Reference 904 200 04 01 904 200 06 01 904 200 08 01 904 200 20 01
904 200 22 01 904 200 26 01 904 200 49 01 904 201 02 01
904 201 07 01

**50 005 627**

Conecto O 345

480

10.2001→
Reference  OM 457 942
403 180 28 01
ohne Antriebsrad, without impeller, sans roue motrice, sin rueda motriz, без ведущего колеса

**50 005 828**

2000 →
Reference 904 200 04 01 904 200 06 01 904 200 08 01 904 200 20 01
904 200 22 01 904 200 26 01 904 200 49 01 904 201 02 01
904 201 07 01

**50 005 627**

10.2001→
Reference  OM 457 942
403 180 27 01
mit Antriebsrad, with impeller, avec roue motrice, con rueda motriz, с приводным колесом

**50 005 827****M**

Econic 1823

481

03.1998→
Reference 904 200 04 01 904 200 06 01 904 200 08 01 904 200 20 01
904 200 22 01 904 200 26 01 904 200 49 01 904 201 02 01
904 201 07 01

**50 005 627**

Econic 1828

482

03.1998→
Reference 904 200 04 01 904 200 06 01 904 200 08 01 904 200 20 01
904 200 22 01 904 200 26 01 904 200 49 01 904 201 02 01
904 201 07 01

**50 005 627**

Econic 2628

483

03.1998→
Reference 904 200 04 01 904 200 06 01 904 200 08 01 904 200 20 01
904 200 22 01 904 200 26 01 904 200 49 01 904 201 02 01
904 201 07 01

**50 005 627**

Freightliner (USA)

484

07.1987→
Reference 403 180 33 01 423 180 01 01 423 180 05 01

**50 005 834**

Reference 401 180 00 01 401 180 01 01 403 180 06 01 403 180 17 01

**50 005 837**

2000 →
Reference 904 200 04 01 904 200 06 01 904 200 08 01 904 200 20 01
904 200 22 01 904 200 26 01 904 200 49 01 904 201 02 01
904 201 07 01

**50 005 627**



MB 90 2.0 D

485

03.1985→12.1986 	OM 615 963 Lager/bearing/coussinet/cojinete/подшипник: 30 mm			50 005 932
03.1985→12.1986 Reference 	OM 615 963 110 200 01 20 Lager/bearing/coussinet/cojinete/подшипник: 36 mm			50 005 032
03.1985→12.1986 Reference 	OM 615 963 110 200 01 20 110 200 09 20 110 200 17 20 115 200 00 20 115 200 15 20 115 200 18 20 121 200 09 20 Lager/bearing/coussinet/cojinete/подшипник: 40 mm			50 005 035

MB 100 2.0 D

486

12.1980→06.1989 	OM 615 917, 963 Lager/bearing/coussinet/cojinete/подшипник: 30 mm			50 005 932
12.1980→06.1989 Reference 	OM 615 917, 963 110 200 01 20 Lager/bearing/coussinet/cojinete/подшипник: 36 mm			50 005 032
12.1980→06.1989 Reference 	OM 615 917, 963 110 200 01 20 110 200 09 20 110 200 17 20 115 200 00 20 115 200 15 20 115 200 18 20 121 200 09 20 Lager/bearing/coussinet/cojinete/подшипник: 40 mm			50 005 035

M

MB 100 2.3 D

487

01.1996→ Reference	OM 661 911 602 200 00 20 602 200 01 20 602 200 02 20			50 005 439
-----------------------	---	--	--	-------------------

MB 100 2.4 D

488

09.1987→01.1996 Reference	OM 616 963 616 200 04 20 616 200 07 20			50 005 428
------------------------------	--	--	--	-------------------

MB 100 2.9 D

489

01.1996→ Reference	OM 662 911 602 200 00 20 602 200 01 20 602 200 02 20			50 005 439
-----------------------	---	--	--	-------------------

MB 120 2.4 D

490

01.1987→12.1990 Reference	OM 616 963 616 200 04 20 616 200 07 20			50 005 428
------------------------------	--	--	--	-------------------



MB 140 2.4 D

491

01.1987→06.1990 OM 616 963
 Reference 616 200 04 20 616 200 07 20

**50 005 428**

MB 160 2.4 D

492

01.1987→06.1990 OM 616 963
 Reference 616 200 04 20 616 200 07 20

**50 005 428**

MB 180 2.4 D

493

10.1983→01.1996 OM 616 963
 Reference 616 200 04 20 616 200 07 20

**50 005 428**

Tourismo O 350

494

10.1995→ OM 402 970
 10.1995→ OM 446 938
 Reference 403 180 33 01 423 180 01 01 423 180 05 01

**50 005 834**

10.1999→ OM 457 944
 Reference 403 180 28 01
 ohne Antriebsrad, without impeller, sans roue motrice, sin rueda motriz, без ведущего колеса

**50 005 828**

10.1995→ OM 401 970
 10.1995→ OM 441 980
 10.1995→ OM 445 934
 Reference 401 180 00 01 401 180 01 01 403 180 06 01 403 180 17 01

**50 005 837**

10.1995→ OM 401 970
 10.1995→ OM 402 970
 10.1995→ OM 441 980
 10.1995→ OM 445 934
 10.1995→ OM 446 938
 Reference 403 200 76 01 403 200 77 01

**50 005 615**

10.1999→ OM 457 944
 Reference 403 180 27 01
 mit Antriebsrad, with impeller, avec roue motrice, con rueda motriz, с приводным колесом

**50 005 827**

10.1995→ OM 401 970
 10.1995→ OM 402 970
 10.1995→ OM 441 980
 10.1995→ OM 445 934
 10.1995→ OM 446 938
 Reference 403 200 44 01 403 200 51 01 403 200 71 01

**50 005 210**

Tourismo O 530

495

10.1999→ OM 457 944
 Reference 403 180 28 01
 ohne Antriebsrad, without impeller, sans roue motrice, sin rueda motriz, без ведущего колеса

**50 005 828**

10.1999→ OM 457 944
 Reference 403 180 27 01
 mit Antriebsrad, with impeller, avec roue motrice, con rueda motriz, с приводным колесом

**50 005 827**



Travego O 580

496

02.2001→	OM 542 948 OM 942 900, 911						
Reference	542 200 05 01 542 200 15 01 542 200 19 01						50 005 619
Reference	OM 457 938, 941, 944 403 180 28 01 ohne Antriebsrad, without impeller, sans roue motrice, sin rueda motriz, без ведущего колеса					50 005 828	
02.2001→	OM 542 948 OM 942 900, 911						
Reference	542 180 00 01 542 180 01 01 542 180 02 01 542 180 07 01					50 005 838	
Reference	OM 457 938, 941, 944 403 180 27 01 mit Antriebsrad, with impeller, avec roue motrice, con rueda motriz, с приводным колесом					50 005 827	

O 301

497

02.1986→02.2001	OM 366 917						
Reference	314 180 10 01 352 180 24 01 352 180 63 01 352 180 70 01 364 180 01 01					50 005 843	
02.1986→02.2001	OM 366 965						
Reference	366 180 01 01 366 180 04 01					50 005 836	
02.1986→02.2001	OM 366 917, 965						
Reference	366 200 09 01 366 200 59 01					50 005 629	

O 302

498

1968 →	OM 360 914-915, 916 (TUR), 917-918, 931, 933, 979 (TUR)						
Reference	360 180 06 01 360 180 07 01 360 180 15 01 360 180 18 01 360 180 20 01 360 180 24 01 360 180 26 01					50 005 830	
11.1964→12.1974	OM 352 980, 993						
Reference	353 200 56 01					50 005 618	
11.1964→12.1974	OM 352 980, 993						
Reference	314 180 10 01 352 180 24 01 352 180 63 01 352 180 70 01 364 180 01 01					50 005 843	

M



11.1964→12.1974 Reference	OM 352 980, 993 314 180 05 01 314 180 10 01 352 180 63 01			50 005 835
Reference	OM 355 968 355 180 01 01			50 005 829
Reference	OM 482 930 (TUR) 401 180 00 01 401 180 01 01 403 180 06 01 403 180 17 01			50 005 837
Reference	OM 421 908 403 200 76 01 403 200 77 01			50 005 615
Reference 	OM 355 967-968, 977 (MEX), 978 355 200 01 01 355 200 05 01 355 200 06 01 355 200 08 01 355 200 09 01 355 200 11 01 355 200 15 01 wartungsfrei maintenance-free sans entretien sin necesidad de mantenimiento не нуждающийся в обслуживании			50 005 211
11.1964→12.1974 Reference	OM 352 980, 993 353 200 36 01 353 200 37 01			50 005 617
Reference	OM 421 908 OM 481 904 (TUR) 403 200 44 01 403 200 51 01 403 200 71 01			50 005 210
O 303				499
1991 → 07.1975→06.1983 1979 → 09.1987→09.1992 Reference 	OM 402 984, 995 OM 403 918 OM 422 951, 963 OM 442 954-955, 960-961 403 180 33 01 423 180 01 01 423 180 05 01 OM 403.918: 121800→			50 005 834
03.1975→06.1983 07.1975→06.1983 11.1985→04.1989 01.1980→09.1987 12.1987→ 09.1987→09.1992 01.1980→09.1987 Reference 	OM 402 907 OM 403 918 OM 421 951 OM 422 908, 917 OM 441 950, 953, 994-995 OM 442 910-911, 918-919, 939 OM 482 930 (TUR) 401 180 00 01 401 180 01 01 403 180 06 01 403 180 17 01 OM 403.918: →121799			50 005 837

M











04.1972→1985 03.1975→ 07.1975→06.1983 01.1980→04.1989 1979 → 12.1987→ 09.1987→09.1992 Reference	OM 401 OM 402 OM 403 OM 421 OM 422 OM 441 OM 442 403 200 76 01 403 200 77 01	907-908, 912-913 907, 995 918 908, 951 908, 917, 951, 963 950, 953, 995 954-955, 960-961		50 005 615
09.1987→09.1992 09.1987→09.1992 Reference	OM 441 OM 442 441 200 01 01 441 200 02 01	908-909, 911, 918 910-911, 918-919, 939		50 005 616
04.1972→ 03.1975→06.1983 07.1975→06.1983 Reference	OM 401 OM 402 OM 403 403 200 27 01 403 200 32 01 403 200 34 01 403 200 35 01 403 200 49 01 403 200 70 01	907-908, 912-913, 917 907 918		50 005 207
01.1991→ 07.1995→ Reference	OM 402 984 OM 441 994 403 200 53 01 403 200 73 01			50 005 632
04.1972→ 03.1975→ 07.1975→06.1983 01.1980→04.1989 1979 → 09.1987→ 09.1987→09.1992 Reference	OM 401 OM 402 OM 403 OM 421 OM 422 OM 441 OM 442 403 200 44 01 403 200 51 01 403 200 71 01	907-908, 912-913, 917 907, 995 918 908, 951 908, 917, 951, 963 908-909, 911, 918, 950, 953, 994-995 910-911, 918-919, 954-955, 960-961		50 005 210
O 304				500
07.1995→ Reference	OM 441 994-995 401 180 00 01 401 180 01 01 403 180 06 01 403 180 17 01			50 005 837
07.1995→ Reference	OM 441 995 403 200 76 01 403 200 77 01			50 005 615
07.1995→ Reference	OM 441 994 403 200 53 01 403 200 73 01			50 005 632
07.1995→ Reference	OM 441 994-995 403 200 44 01 403 200 51 01 403 200 71 01			50 005 210

M





O 305

501

01.1969→05.1973	OM 360 911						
Reference	360 180 06 01 360 180 20 01	360 180 07 01 360 180 24 01	360 180 15 01 360 180 26 01	360 180 18 01		50 005 830	
Reference	OM 353 967					50 005 843	
Reference	314 180 10 01 364 180 01 01	352 180 24 01	352 180 63 01	352 180 70 01			
04.1973→05.1987	OM 407 905, 908-910, 913-914, 917, 919, 951, 955					50 005 828	
Reference	403 180 28 01	ohne Antriebsrad, without impeller, sans roue motrice, sin rueda motriz, без ведущего колеса					
04.1973→05.1987	OM 407 905, 908-910, 913-914, 917, 951, 955						50 005 615
Reference	403 200 76 01	403 200 77 01					
04.1973→05.1987	OM 407 905, 908-910, 913-914, 917, 951						50 005 207
Reference	403 200 27 01 403 200 49 01	403 200 32 01 403 200 70 01	403 200 34 01	403 200 35 01			
02.1978→05.1987	OM 407 919						50 005 632
Reference	403 200 53 01	403 200 73 01					
04.1973→05.1987	OM 407 905, 908-910, 913-914, 917, 919, 951, 955					50 005 827	
Reference	403 180 27 01	mit Antriebsrad, with impeller, avec roue motrice, con rueda motriz, с приводным колесом					
04.1973→05.1987	OM 407 905, 908-910, 913-914, 917, 951, 955						50 005 210
Reference	403 200 44 01	403 200 51 01	403 200 71 01				

O 307

502

04.1973→07.1987	OM 407 905, 907, 911, 915-916, 918, 955					50 005 828	
Reference	403 180 28 01	ohne Antriebsrad, without impeller, sans roue motrice, sin rueda motriz, без ведущего колеса					
04.1973→07.1987	OM 407 905, 907, 911, 915-916, 918, 955						50 005 615
Reference	403 200 76 01	403 200 77 01					



04.1973→07.1987 Reference	OM 407 403 200 27 01 403 200 49 01	905, 907, 911, 915-916, 918 403 200 32 01 403 200 70 01	403 200 34 01	403 200 35 01		50 005 207
04.1973→07.1987 Reference 	OM 407 403 180 27 01	905, 907, 911, 915-916, 918, 955 mit Antriebsrad, with impeller, avec roue motrice, con rueda motriz, с приводным колесом				50 005 827
04.1973→07.1987 Reference	OM 407 403 200 44 01	905, 907, 911, 915-916, 918, 955 403 200 51 01	403 200 71 01			50 005 210
O 309 2.0						503
08.1965→02.1968 Reference	M 121 115 200 01 20 121 200 11 20	943 115 200 12 20 127 200 01 20	115 200 16 20 127 200 02 20	121 200 06 20		50 005 033
O 309 2.2						504
01.1968→12.1974 1961 →1968 Reference	M 115 OM 621	921, 928 932				50 005 033
O 309 2.3						505
08.1982→02.1989 Reference	M 102 102 200 03 01 102 200 11 01	943 102 200 03 20 102 200 43 01	102 200 04 01	102 200 04 20		50 005 028
01.1975→08.1982 	M 115	952 Lager/bearing/coussinet/cojinete/подшипник: 30 mm				50 005 932
08.1982→02.1989 Reference	M 102 102 200 01 20	943, 959 102 200 08 01	102 200 09 01	102 200 42 01		50 005 029
01.1975→08.1982 Reference 	M 115 110 200 01 20	952 Lager/bearing/coussinet/cojinete/подшипник: 36 mm				50 005 032
01.1975→08.1982 Reference 	M 115 110 200 01 20 115 200 15 20	952 110 200 09 20 115 200 18 20	110 200 17 20 121 200 09 20	115 200 00 20		50 005 035

M



O 309 D 2.2

506

01.1968→07.1977 	OM 615 910, 938 Lager/bearing/coussinnet/cojinete/подшипник: 30 mm OM 615.938: 002248→ OM 615.910: 088767→			50 005 932
01.1968→07.1977 Reference 	OM 615 910, 938 110 200 01 20 Lager/bearing/coussinnet/cojinete/подшипник: 36 mm OM 615.938: 002248→ OM 615.910: 088767→			50 005 032
01.1968→07.1977 Reference 	OM 615 910, 938 115 200 01 20 115 200 12 20 115 200 16 20 121 200 06 20 121 200 11 20 127 200 01 20 127 200 02 20 OM 615.938: →002247 OM 615.910: →088766			50 005 033
01.1968→07.1977 Reference 	OM 615 910, 938 110 200 01 20 110 200 09 20 110 200 17 20 115 200 00 20 115 200 15 20 115 200 18 20 121 200 09 20 Lager/bearing/coussinnet/cojinete/подшипник: 40 mm OM 615.938: 002248→ OM 615.910: 088767→			50 005 035

O 309 D 2.4

507

09.1982→02.1989 Reference	OM 616 937, 939 616 200 04 20 616 200 07 20			50 005 428
01.1975→08.1982 	OM 616 910 Lager/bearing/coussinnet/cojinete/подшипник: 30 mm			50 005 932
01.1975→08.1982 Reference 	OM 616 910 110 200 01 20 Lager/bearing/coussinnet/cojinete/подшипник: 36 mm			50 005 032
01.1975→08.1982 Reference 	OM 616 910 110 200 01 20 110 200 09 20 110 200 17 20 115 200 00 20 115 200 15 20 115 200 18 20 121 200 09 20 Lager/bearing/coussinnet/cojinete/подшипник: 40 mm			50 005 035

O 309 D 3.8

508

01.1970→02.1989 Reference 	OM 314 948, 959, 962-963 314 180 10 01 352 180 24 01 352 180 63 01 352 180 70 01 364 180 01 01 OM 314.948, OM 314.959: 020056→			50 005 843
01.1970→02.1989 Reference 	OM 314 948, 959 314 180 05 01 314 180 10 01 352 180 63 01 →020055			50 005 835

M



O 309 D 5.7

509

05.1977→02.1989 OM 353 963, 966, 968-969
Reference 353 200 56 01

**50 005 618**

05.1977→02.1989 OM 353 963, 966, 968-969
Reference 314 180 10 01 352 180 24 01 352 180 63 01 352 180 70 01
364 180 01 01

**50 005 843**

Series 309 D 2.0

510

01.1967→12.1969 OM 621 932
Reference 115 200 01 20 115 200 12 20 115 200 16 20 121 200 06 20
121 200 11 20 127 200 01 20 127 200 02 20

**50 005 033**

O 319 1.9

511

1955→08.1965 M 121 922, 926, 929
Reference 115 200 01 20 115 200 12 20 115 200 16 20 121 200 06 20
121 200 11 20 127 200 01 20 127 200 02 20

**50 005 033**

O 319 2.0

512

08.1965→02.1968 M 121 941-942
Reference 115 200 01 20 115 200 12 20 115 200 16 20 121 200 06 20
121 200 11 20 127 200 01 20 127 200 02 20

**50 005 033****M**

O 321

513

1964→1982 OM 352 914-916
Reference 314 180 10 01 352 180 24 01 352 180 63 01 352 180 70 01
364 180 01 01

**50 005 843**

1964→1981 OM 352 914-915
Reference 314 180 05 01 314 180 10 01 352 180 63 01

**50 005 835**

1964→1982 OM 352 914-916
Reference 353 200 36 01 353 200 37 01

**50 005 617**

O 322















514

1968→1982 OM 352 917-918
Reference 314 180 10 01 352 180 24 01 352 180 63 01 352 180 70 01
364 180 01 01

**50 005 843**



MERCEDES-BENZ

						
1968 →1970 Reference	OM 352 917 314 180 05 01	314 180 10 01	352 180 63 01			50 005 835
1968 →1982 Reference	OM 352 917-918 353 200 36 01	353 200 37 01				50 005 617
O 330						515
1991 → 09.1987→09.1992 Reference	OM 402 984, 995 OM 442 955, 961 403 180 33 01	423 180 01 01	423 180 05 01			50 005 834
09.1987→09.1992 Reference	OM 442 939 401 180 00 01	401 180 01 01	403 180 06 01	403 180 17 01		50 005 837
1991 → 09.1987→09.1992 Reference	OM 402 995 OM 442 955, 961 403 200 76 01	403 200 77 01				50 005 615
09.1987→09.1992 Reference	OM 442 939 441 200 01 01	441 200 02 01				50 005 616
01.1991→ Reference	OM 402 984 403 200 53 01	403 200 73 01				50 005 632
1991 → 09.1987→09.1992 Reference	OM 402 995 OM 442 955, 961 403 200 44 01	403 200 51 01	403 200 71 01			50 005 210
O 340						516
01.1991→ Reference	OM 402 984, 995 403 180 33 01	423 180 01 01	423 180 05 01			50 005 834
07.1995→ Reference	OM 441 994-995 401 180 00 01	401 180 01 01	403 180 06 01	403 180 17 01		50 005 837

M



09.1992→09.1995 07.1995→ Reference	OM 402 995 OM 441 995 403 200 76 01 403 200 77 01			50 005 615
01.1991→ 07.1995→ Reference	OM 402 984 OM 441 994 403 200 53 01 403 200 73 01			50 005 632
09.1992→09.1995 07.1995→ Reference	OM 402 995 OM 441 994-995 403 200 44 01 403 200 51 01 403 200 71 01			50 005 210
O 345				517
05.1997→ Reference 	OM 457 942 403 180 28 01 ohne Antriebsrad, without impeller, sans roue motrice, sin rueda motriz, без ведущего колеса			50 005 828
05.1997→ Reference 	OM 457 942 403 180 27 01 mit Antriebsrad, with impeller, avec roue motrice, con rueda motriz, с приводным колесом			50 005 827
O 371				518
Reference	OM 475 952 (BRA) OM 476 981 (BRA) 401 180 00 01 401 180 01 01 403 180 06 01 403 180 17 01			50 005 837
O 374				519
Reference	OM 476 977 (BRA), 981 (BRA) 401 180 00 01 401 180 01 01 403 180 06 01 403 180 17 01			50 005 837
O 400				520
Reference	OM 475 953 (BRA), 977-978 (AFS/LAM), 984 (AFS/LAM), 991 (AFS/LAM), 997-998 (AFS/LAM) OM 476 972, 977 (BRA), 981 (BRA), 985 (BRA), 992 (BRA) 401 180 00 01 401 180 01 01 403 180 06 01 403 180 17 01			50 005 837
O 402				521
02.1986→02.2001 Reference	OM 366 917 314 180 10 01 352 180 24 01 352 180 63 01 352 180 70 01 364 180 01 01			50 005 843
06.1986→ Reference	OM 366 965 366 180 01 01 366 180 04 01			50 005 836

M



MERCEDES-BENZ

02.1986→ Reference	OM 366 917, 965 366 200 09 01 366 200 59 01			50 005 629
O 403				522
01.1995→ Reference	OM 446 938 403 180 33 01 423 180 01 01 423 180 05 01			50 005 834
10.1999→ Reference	OM 457 944 403 180 28 01 ohne Antriebsrad, without impeller, sans roue motrice, sin rueda motriz, без ведущего колеса			50 005 828
10.1995→ 10.1995→ Reference	OM 441 980 OM 445 934 401 180 00 01 401 180 01 01 403 180 06 01 403 180 17 01			50 005 837
10.1995→ 10.1995→ 01.1995→ Reference	OM 441 980 OM 445 934 OM 446 938 403 200 76 01 403 200 77 01			50 005 615
10.1999→ Reference	OM 457 944 403 180 27 01 mit Antriebsrad, with impeller, avec roue motrice, con rueda motriz, с приводным колесом			50 005 827
10.1995→ 10.1995→ 01.1995→ Reference	OM 441 980 OM 445 934 OM 446 938 403 200 44 01 403 200 51 01 403 200 71 01			50 005 210
O 404				523
09.1991→10.1999 07.1995→ 01.1995→10.1999 Reference	OM 402 970, 974 OM 442 995-996 OM 446 934, 938 403 180 33 01 423 180 01 01 423 180 05 01			50 005 834
09.1991→ 09.1991→05.1998 09.1991→01.1992 01.1995→10.1999 Reference	OM 401 970, 974 OM 441 980 OM 442 930-931 OM 445 934-935 401 180 00 01 401 180 01 01 403 180 06 01 403 180 17 01			50 005 837
09.1991→ 09.1991→10.1999 09.1991→05.1998 07.1995→ 01.1995→10.1999 01.1995→10.1999 Reference	OM 401 970, 974 OM 402 970, 974 OM 441 980 OM 442 995-996 OM 445 934-935 OM 446 934, 938 403 200 76 01 403 200 77 01			50 005 615
09.1991→01.1992 09.1991→01.1992 Reference	OM 441 921-922 OM 442 930-931 441 200 01 01 441 200 02 01			50 005 616

M



09.1991→ 09.1991→10.1999 09.1991→05.1998 07.1995→ 01.1995→10.1999 01.1995→10.1999 Reference	OM 401 OM 402 OM 441 OM 442 OM 445 OM 446 403 200 44 01	970, 974 970, 974 921-922, 980 995-996 934-935 934, 938 403 200 51 01 403 200 71 01		50 005 210
O 405				524
10.1984→ Reference	OM 427 OM 447 403 180 28 01	905, 910-911, 950-952 905-908, 910-911, 913-914, 916, 925, 950-951, 955-957, 959, 968, 970-981, 984, 986, 995-996, 998-999 ohne Antriebsrad, without impeller, sans roue motrice, sin rueda motriz, без ведущего колеса		50 005 828
11.1985→12.1986 Reference	OM 427 OM 447 403 200 76 01 403 200 77 01	910 906, 996, 999		50 005 615
10.1984→ Reference	OM 427 OM 447 403 200 53 01 403 200 73 01	905, 911, 950-952 905, 907-908, 910-911, 913-914, 916, 925, 950-951, 955-957, 959, 968, 970-981, 984, 986, 998		50 005 632
10.1984→ Reference	OM 427 OM 447 403 180 27 01	905, 910-911, 950-952 905-908, 910-911, 913-914, 916, 925, 950-951, 955-957, 959, 968, 970-981, 984, 986, 995-996, 998-999 mit Antriebsrad, with impeller, avec roue motrice, con rueda motriz, с приводным колесом		50 005 827
11.1985→12.1986 01.1985→ Reference	OM 427 OM 447 403 200 44 01 403 200 51 01 403 200 71 01	910 906, 995		50 005 210
O 405 GTZ				525
11.1986→02.2001 Reference	OM 602 602 200 00 20 602 200 01 20 602 200 02 20	990, 994		50 005 439
O 407				526
03.1987→ Reference	OM 447 403 180 28 01	906, 908, 954, 985, 990-991 ohne Antriebsrad, without impeller, sans roue motrice, sin rueda motriz, без ведущего колеса		50 005 828
03.1987→ Reference	OM 447 403 200 76 01 403 200 77 01	906, 954, 985, 990-991		50 005 615

M



MERCEDES-BENZ

03.1987→02.2001 Reference	OM 447 908 403 200 53 01 403 200 73 01			50 005 632
03.1987→ Reference 	OM 447 906, 908, 954, 985, 990-991 403 180 27 01 mit Antriebsrad, with impeller, avec roue motrice, con rueda motriz, с приводным колесом		50 005 827	
03.1987→ Reference	OM 447 906, 954, 985, 990-991 403 200 44 01 403 200 51 01 403 200 71 01			50 005 210
O 408				527
Reference 	OM 447 908, 912, 915, 958, 987, 992-993, 996 403 180 28 01 ohne Antriebsrad, without impeller, sans roue motrice, sin rueda motriz, без ведущего колеса		50 005 828	
Reference	OM 447 912, 915, 958, 987, 992-993, 996 403 200 76 01 403 200 77 01			50 005 615
Reference	OM 447 908 403 200 53 01 403 200 73 01			50 005 632
Reference 	OM 447 908, 912, 915, 958, 987, 992-993, 996 403 180 27 01 mit Antriebsrad, with impeller, avec roue motrice, con rueda motriz, с приводным колесом		50 005 827	
01.1991→ Reference	OM 447 912, 915, 958, 987, 992-993 403 200 44 01 403 200 51 01 403 200 71 01			50 005 210
O 415				528
Reference 	OM 457 941, 944 403 180 28 01 ohne Antriebsrad, without impeller, sans roue motrice, sin rueda motriz, без ведущего колеса		50 005 828	
Reference 	OM 457 941, 944 403 180 27 01 mit Antriebsrad, with impeller, avec roue motrice, con rueda motriz, с приводным колесом		50 005 827	
O 500				529
Reference 	OM 457 944 403 180 28 01 ohne Antriebsrad, without impeller, sans roue motrice, sin rueda motriz, без ведущего колеса		50 005 828	

M



MERCEDES-BENZ

Reference	OM 904 962 OM 906 918, 933, 974-975, 977, 983	904 200 04 01 904 200 06 01 904 200 08 01 904 200 20 01 904 200 22 01 904 200 26 01 904 200 49 01 904 201 02 01 904 201 07 01		50 005 627
Reference	OM 457 944 403 180 27 01 mit Antriebsrad, with impeller, avec roue motrice, con rueda motriz, с приводным колесом			50 005 827
O 550 Integro				530
01.1997→ Reference	OM 447 903 403 180 28 01 ohne Antriebsrad, without impeller, sans roue motrice, sin rueda motriz, без ведущего колеса			50 005 828
01.1997→ Reference	OM 447 903 403 200 76 01 403 200 77 01			50 005 615
01.1997→ Reference	OM 447 903 403 180 27 01 mit Antriebsrad, with impeller, avec roue motrice, con rueda motriz, с приводным колесом			50 005 827
01.1997→ Reference	OM 447 903 403 200 44 01 403 200 51 01 403 200 71 01			50 005 210
Forst-Trac				531
04.1991→ Reference	OM 364 959 314 180 10 01 352 180 24 01 352 180 63 01 352 180 70 01 364 180 01 01			50 005 843
04.1991→ Reference	OM 364 959 364 200 01 01 364 200 09 01 364 200 20 01			50 005 633 <small>NEW</small>
MB-Trac 65/70				532
07.1973→12.1975 Reference	OM 314 956 314 180 10 01 352 180 24 01 352 180 63 01 352 180 70 01 364 180 01 01			50 005 843
MB-Trac 90				533
03.1985→12.1986 Reference	OM 615 963 Lager/bearing/coussinet/cojinete/подшипник: 30 mm			50 005 932

M



03.1985→12.1986 Reference 	OM 615 963 110 200 01 20 Lager/bearing/coussinete/cojinete/подшипник: 36 mm				50 005 032
03.1985→12.1986 Reference 	OM 615 963 110 200 01 20 110 200 09 20 110 200 17 20 115 200 00 20 115 200 15 20 115 200 18 20 121 200 09 20 Lager/bearing/coussinete/cojinete/подшипник: 40 mm				50 005 035
MB-Trac 100					534
09.1987→12.1994 Reference	OM 616 963 616 200 04 20 616 200 07 20				50 005 428
12.1980→08.1991 	OM 615 963 Lager/bearing/coussinete/cojinete/подшипник: 30 mm				50 005 932
12.1980→08.1991 Reference 	OM 615 963 110 200 01 20 Lager/bearing/coussinete/cojinete/подшипник: 36 mm				50 005 032
12.1980→08.1991 Reference 	OM 615 963 110 200 01 20 110 200 09 20 110 200 17 20 115 200 00 20 115 200 15 20 115 200 18 20 121 200 09 20 Lager/bearing/coussinete/cojinete/подшипник: 40 mm				50 005 035
MB-Trac 120					535
01.1987→12.1990 Reference	OM 616 963 616 200 04 20 616 200 07 20				50 005 428
MB-Trac 140					536
10.1983→06.1990 Reference	OM 616 963 616 200 04 20 616 200 07 20				50 005 428
MB-Trac 150					537
12.1980→09.1983 Reference	OM 616 963 616 200 04 20 616 200 07 20				50 005 428
MB-Trac 160					538
01.1987→06.1990 Reference	OM 616 963 616 200 04 20 616 200 07 20				50 005 428

M



MB-Trac 180

539

10.1983→
Reference OM 616 963
616 200 04 20 616 200 07 20

**50 005 428**

MB-Trac 700

540

03.1987→12.1992
Reference OM 314 921, 956-957
OM 364 908
OM 394 900 007 (AFS)
314 180 10 01 352 180 24 01 352 180 63 01 352 180 70 01
364 180 01 01

**50 005 843**

03.1987→12.1992
Reference OM 364 908
364 200 01 01 364 200 09 01 364 200 20 01

**50 005 633****NEW**

MB-Trac 800

541

03.1987→12.1992
Reference OM 314 920, 957
OM 364 909
OM 394 900 006 (AFS)
314 180 10 01 352 180 24 01 352 180 63 01 352 180 70 01
364 180 01 01

**50 005 843**

03.1987→12.1992
Reference OM 364 909
364 200 01 01 364 200 09 01 364 200 20 01

**50 005 633****NEW**

MB-Trac 900

542

Reference OM 394 900 009 (AFS)
314 180 10 01 352 180 24 01 352 180 63 01 352 180 70 01
364 180 01 01

**50 005 843**

MB-Trac 900 Turbo

543









09.1981→03.1987
03.1987→12.1992
Reference OM 314 970
OM 364 951
314 180 10 01 352 180 24 01 352 180 63 01 352 180 70 01
364 180 01 01

**50 005 843**

03.1987→12.1992
Reference OM 364 951
364 200 01 01 364 200 09 01 364 200 20 01













**50 005 633****NEW****M**



MB-Trac 1000					544
11.1982→03.1987 03.1987→12.1992	OM 353 985 OM 366 912				
Reference	314 180 10 01 364 180 01 01	352 180 24 01	352 180 63 01	352 180 70 01	 50 005 843
03.1987→12.1992	OM 366 912				
Reference	366 200 09 01	366 200 59 01			 50 005 629
MB-Trac 1100					545
10.1976→03.1987 03.1987→12.1992	OM 353 949 OM 366 908				
Reference	314 180 10 01 364 180 01 01	352 180 24 01	352 180 63 01	352 180 70 01	 50 005 843
10.1976→03.1987	OM 353 949				
Reference	353 200 36 01	353 200 37 01			 50 005 617
03.1987→12.1992	OM 366 908				
Reference	366 200 09 01	366 200 59 01			 50 005 629
MB-Trac 1300					546
10.1976→03.1987	OM 353 957				
Reference	314 180 10 01 364 180 01 01	352 180 24 01	352 180 63 01	352 180 70 01	 50 005 843
10.1976→03.1987	OM 353 957				
Reference	353 200 36 01	353 200 37 01			 50 005 617
MB-Trac 1300 turbo					547
01.1977→05.1988 03.1987→12.1992	OM 352 937 OM 366 977				
Reference	314 180 10 01 364 180 01 01	352 180 24 01	352 180 63 01	352 180 70 01	 50 005 843
01.1977→05.1988	OM 352 937				
Reference	314 180 05 01	314 180 10 01	352 180 63 01		 50 005 835

M



				
03.1987→12.1992 Reference	OM 366 977 366 180 01 01 366 180 04 01		50 005 836	
01.1977→05.1988 Reference	OM 352 937 353 200 36 01 353 200 37 01			50 005 617
03.1987→12.1992 Reference	OM 366 977 366 200 09 01 366 200 59 01			50 005 629
MB-Trac 1400 turbo				548
03.1987→12.1992 Reference	OM 366 958 314 180 10 01 352 180 24 01 352 180 63 01 352 180 70 01 364 180 01 01		50 005 843	
03.1987→12.1992 Reference	OM 366 958 366 180 01 01 366 180 04 01		50 005 836	
03.1987→12.1992 Reference	OM 366 958 366 200 09 01 366 200 59 01			50 005 629
MB-Trac 1500 turbo				549
07.1980→03.1987 Reference	OM 353 921, 976 366 180 01 01 366 180 04 01		50 005 836	
07.1980→03.1987 Reference	OM 353 921, 976 353 200 36 01 353 200 37 01			50 005 617
MB-Trac 1600 turbo				550
03.1987→12.1992 Reference	OM 366 954 366 180 01 01 366 180 04 01		50 005 836	

M



03.1987→12.1992 Reference	OM 366 954 366 200 09 01	366 200 59 01				 50 005 629
U 40						551
01.1968→12.1971 01.1966→12.1967 Reference	OM 615 911, 914 OM 621 916, 931 115 200 01 20 121 200 11 20	115 200 12 20 127 200 01 20	115 200 16 20 127 200 02 20	121 200 06 20		 50 005 033
U 45						552
01.1968→12.1971 01.1966→12.1967 Reference	OM 615 911 OM 621 916, 931 115 200 01 20 121 200 11 20	115 200 12 20 127 200 01 20	115 200 16 20 127 200 02 20	121 200 06 20		 50 005 033
U 52						553
Reference	OM 616 911, 915 115 200 01 20 121 200 11 20	115 200 12 20 127 200 01 20	115 200 16 20 127 200 02 20	121 200 06 20		 50 005 033
U 54						554
04.1966→12.1976 Reference	OM 314 916 314 180 10 01 364 180 01 01	352 180 24 01	352 180 63 01	352 180 70 01		 50 005 843
U 55						555
01.1968→12.1971 01.1966→12.1967 Reference	OM 615 914 OM 621 916, 931 115 200 01 20 121 200 11 20	115 200 12 20 127 200 01 20	115 200 16 20 127 200 02 20	121 200 06 20		 50 005 033
U 60						556
05.1969→05.1988 Reference	OM 616 911, 930-933 115 200 01 20 121 200 11 20	115 200 12 20 127 200 01 20	115 200 16 20 127 200 02 20	121 200 06 20		 50 005 033
U 65						557
Reference	OM 352 919 OM 353 902 314 180 10 01 364 180 01 01	352 180 24 01	352 180 63 01	352 180 70 01		 50 005 843
Reference	OM 352 919 OM 353 902 353 200 36 01	353 200 37 01				 50 005 617

M



U 66

558

04.1966→12.1975 OM 314 917
 Reference 314 180 10 01 352 180 24 01 352 180 63 01 352 180 70 01
 364 180 01 01

**50 005 843**

U 70

559

Reference OM 352 902, 919
 OM 353 902
 314 180 10 01 352 180 24 01 352 180 63 01 352 180 70 01
 364 180 01 01

**50 005 843**

Reference OM 352 902, 919
 OM 353 902
 353 200 36 01 353 200 37 01

**50 005 617**

U 72

560

01.1976→12.1976 OM 314 917
 Reference 314 180 10 01 352 180 24 01 352 180 63 01 352 180 70 01
 364 180 01 01

**50 005 843****M**

U 80

561

Reference OM 314 917, 953
 OM 352 903, 919, 984
 OM 353 901-902
 314 180 10 01 352 180 24 01 352 180 63 01 352 180 70 01
 364 180 01 01

**50 005 843**

Reference OM 352 903, 919, 984
 OM 353 901-902
 353 200 36 01 353 200 37 01

**50 005 617**

U 84

562

05.1969→12.1976 OM 352 919
 OM 353 902
 Reference 314 180 10 01 352 180 24 01 352 180 63 01 352 180 70 01
 364 180 01 01

**50 005 843**



05.1969→12.1976 OM 352 919
 OM 353 902
 Reference 353 200 36 01 353 200 37 01

**50 005 617**



U 90

563

05.1969→12.1976	OM 341 918 (AMS), 938 OM 352 903 OM 353 901-902					50 005 843	
Reference	314 180 10 01 364 180 01 01	352 180 24 01	352 180 63 01	352 180 70 01			
11.1992→	OM 602 941						50 005 439
Reference	602 200 00 20	602 200 01 20	602 200 02 20				
05.1969→12.1976	OM 352 903 OM 353 901-902						50 005 617
Reference	353 200 36 01	353 200 37 01					

U 90 turbo

564

07.1996→	OM 602 981						50 005 439
Reference	602 200 00 20	602 200 01 20	602 200 02 20				



U 95

565

10.1976→12.1976	OM 353 962					50 005 843	
Reference	314 180 10 01 364 180 01 01	352 180 24 01	352 180 63 01	352 180 70 01			

U 100

566

Reference	OM 353 901, 905, 907, 940 314 180 10 01 364 180 01 01	352 180 24 01	352 180 63 01	352 180 70 01		50 005 843	
11.1992→	OM 602 941, 948						50 005 439
Reference	602 200 00 20	602 200 01 20	602 200 02 20				
Reference	OM 353 901, 905, 907, 940 353 200 36 01	353 200 37 01					50 005 617

U 100 turbo

567

07.1996→	OM 602 981						50 005 439
Reference	602 200 00 20	602 200 01 20	602 200 02 20				

M



U 110

568

07.1992→ Reference	OM 353 901, 940 OM 364 955-956 314 180 10 01 352 180 24 01 352 180 63 01 352 180 70 01 364 180 01 01		50 005 843	
Reference	OM 353 901, 940 353 200 36 01 353 200 37 01			50 005 617
07.1992→ Reference	OM 364 955-956 364 200 01 01 364 200 09 01 364 200 20 01			50 005 633 <small>NEW</small>

U 120



569

01.1976→12.1976 Reference	OM 353 960, 973 314 180 10 01 352 180 24 01 352 180 63 01 352 180 70 01 364 180 01 01		50 005 843	
------------------------------	---	--	------------	--

M



U 125

570

10.1970→12.1976 Reference	OM 353 907 314 180 10 01 352 180 24 01 352 180 63 01 352 180 70 01 364 180 01 01		50 005 843	
10.1970→12.1976 Reference	OM 353 907 353 200 36 01 353 200 37 01			50 005 617

U 130

571

09.1995→ 07.1992→ Reference	OM 354 926 OM 364 982 314 180 10 01 352 180 24 01 352 180 63 01 352 180 70 01 364 180 01 01		50 005 843	
09.1995→ 07.1992→ Reference	OM 354 926 OM 364 982 364 200 01 01 364 200 09 01 364 200 20 01			50 005 633 <small>NEW</small>



U 140

572

09.1995→ 07.1992→	OM 354 926 OM 364 982, 985, 989					50 005 843	
Reference	314 180 10 01 364 180 01 01	352 180 24 01	352 180 63 01	352 180 70 01			
09.1995→ 07.1992→	OM 354 926 OM 364 982, 985, 989						50 005 633 <small>NEW</small>
Reference	364 200 01 01	364 200 09 01	364 200 20 01				

U 150

573

02.1976→12.1976	OM 353 958					50 005 836	
Reference	366 180 01 01	366 180 04 01					

U 300

574

08.1995→	OM 904 927-928						50 005 627
Reference	904 200 04 01 904 200 22 01 904 201 07 01	904 200 06 01 904 200 26 01	904 200 08 01 904 200 49 01	904 200 20 01 904 201 02 01			

U 400

575

08.1995→ 04.2000→	OM 904 927-928 OM 906 935						50 005 627
Reference	904 200 04 01 904 200 22 01 904 201 07 01	904 200 06 01 904 200 26 01	904 200 08 01 904 200 49 01	904 200 20 01 904 201 02 01			

U 404

576

10.1969→12.1976	OM 615 932 Lager/bearing/coussinet/cojinete/подшипник: 30 mm						50 005 932
10.1969→12.1976	OM 615 932 110 200 01 20 Lager/bearing/coussinet/cojinete/подшипник: 36 mm						50 005 032
01.1968→12.1976	OM 615 911, 932						50 005 033
Reference	115 200 01 20 121 200 11 20	115 200 12 20 127 200 01 20	115 200 16 20 127 200 02 20	121 200 06 20			
10.1969→12.1976	OM 615 932 110 200 01 20 115 200 15 20 Lager/bearing/coussinet/cojinete/подшипник: 40 mm	110 200 09 20 115 200 18 20	110 200 17 20 121 200 09 20	115 200 00 20			50 005 035

U 406

577

Reference	OM 341 934 314 180 10 01 364 180 01 01	352 180 24 01	352 180 63 01	352 180 70 01		50 005 843	
-----------	--	---------------	---------------	---------------	--	------------	--

M



U 416

578

05.1966→04.1969 05.1969→12.1985	OM 352 984 OM 353 901, 905						
Reference	314 180 10 01 364 180 01 01	352 180 24 01	352 180 63 01	352 180 70 01		50 005 843	
05.1966→04.1969 05.1969→12.1985	OM 352 984 OM 353 901, 905						
Reference	353 200 36 01	353 200 37 01					50 005 617

U 421

579

	OM 616 912, 916 Lager/bearing/coussinet/cojinete/подшипник: 30 mm						50 005 932
Reference	OM 616 912, 916 110 200 01 20 Lager/bearing/coussinet/cojinete/подшипник: 36 mm						50 005 032
Reference	OM 616 912, 916 110 200 01 20 110 200 09 20 110 200 17 20 115 200 00 20 115 200 15 20 115 200 18 20 121 200 09 20 Lager/bearing/coussinet/cojinete/подшипник: 40 mm						50 005 035

M

U 425

580

07.1976→12.1976	OM 353 973						
Reference	314 180 10 01 364 180 01 01	352 180 24 01	352 180 63 01	352 180 70 01		50 005 843	
02.1976→12.1976	OM 353 958						
Reference	366 180 01 01	366 180 04 01				50 005 836	

U 426

581

Reference	OM 341 918 (AMS) 314 180 10 01 364 180 01 01	352 180 24 01	352 180 63 01	352 180 70 01			50 005 843
-----------	--	---------------	---------------	---------------	--	--	------------

U 435

582

1971 → Reference	OM 353 977 353 200 56 01						50 005 618
---------------------	-----------------------------	--	--	--	--	--	------------



MERCEDES-BENZ

1971 → Reference	OM 353 977 366 180 01 01 366 180 04 01			50 005 836	
U 500					583
02.2001 → Reference	OM 906 935, 955 904 200 04 01 904 200 06 01 904 200 08 01 904 200 20 01 904 200 22 01 904 200 26 01 904 200 49 01 904 201 02 01 904 201 07 01				50 005 627
U 600					584
	OM 616 912, 916 Lager/bearing/coussinet/cojinete/подшипник: 30 mm				50 005 932
Reference 	OM 616 912, 916 110 200 01 20 Lager/bearing/coussinet/cojinete/подшипник: 36 mm				50 005 032
08.1973 → 02.2001 Reference	OM 616 911, 915, 930-933, 942-944 115 200 01 20 115 200 12 20 115 200 16 20 121 200 06 20 121 200 11 20 127 200 01 20 127 200 02 20				50 005 033
Reference 	OM 616 912, 916 110 200 01 20 110 200 09 20 110 200 17 20 115 200 00 20 115 200 15 20 115 200 18 20 121 200 09 20 Lager/bearing/coussinet/cojinete/подшипник: 40 mm				50 005 035
U 650					585
05.1988 → 02.2001 Reference	OM 616 943-944 115 200 01 20 115 200 12 20 115 200 16 20 121 200 06 20 121 200 11 20 127 200 01 20 127 200 02 20				50 005 033
U 800					586
01.1977 → 03.1990 Reference	OM 314 917 314 180 10 01 352 180 24 01 352 180 63 01 352 180 70 01 364 180 01 01			50 005 843	
U 900					587
11.1988 → 02.2001 01.1988 → 02.2001 Reference	OM 352 919 OM 353 901-902, 930, 940 OM 356 912 OM 366 939 314 180 10 01 352 180 24 01 352 180 63 01 352 180 70 01 364 180 01 01			50 005 843	
Reference	OM 352 919 OM 353 901-902, 930, 940 353 200 36 01 353 200 37 01				50 005 617

M



U 1000

588

07.1976→05.1988	OM 353	962, 973, 980			
09.1991→12.1992	OM 356	914			
01.1988→	OM 366	911 (TUR), 915			
Reference	314 180 10 01	352 180 24 01	352 180 63 01	352 180 70 01	
	364 180 01 01				

**50 005 843**

U 1100

589

Reference	OM 353	901-902, 905, 907, 922-923, 931-933, 936, 940, 962, 980			
	314 180 10 01	352 180 24 01	352 180 63 01	352 180 70 01	
	364 180 01 01				

**50 005 843**

Reference	OM 353	901-902, 905, 907, 922-923, 931-933, 936, 940			
	353 200 36 01	353 200 37 01			

**50 005 617**

U 1150

590

01.1988→02.2001	OM 353	902, 907, 940			
	OM 356	912			
	OM 366	939			
Reference	314 180 10 01	352 180 24 01	352 180 63 01	352 180 70 01	
	364 180 01 01				

**50 005 843**

Reference	OM 353	902, 907, 940			
	353 200 36 01	353 200 37 01			

**50 005 617**

U 1200

591

02.1982→05.1988	OM 353	961, 995			
01.1988→02.2001	OM 366	949			
Reference	314 180 10 01	352 180 24 01	352 180 63 01	352 180 70 01	
	364 180 01 01				

**50 005 843**

09.1991→	OM 356	950, 954-955			
07.1994→04.2000	OM 357	912			
01.1988→02.2001	OM 366	949			
Reference	366 180 01 01	366 180 04 01			

**50 005 836**

U 1250

592

01.1988→02.2001	OM 353	961, 995			
	OM 366	947, 949			
Reference	314 180 10 01	352 180 24 01	352 180 63 01	352 180 70 01	
	364 180 01 01				

**50 005 843**



04.1983→05.1988	OM 353	958			
01.1988→	OM 356	950, 954-955			
	OM 357	912-913			
01.1988→02.2001	OM 366	947, 949			
Reference	366 180 01 01	366 180 04 01			

**50 005 836****M**





U 1300

593

01.1977→05.1988 09.1987→02.2001	OM 353 937, 960-961, 973 OM 366 955 OM 382 916 (TUR)					50 005 843	
Reference	314 180 10 01 364 180 01 01	352 180 24 01	352 180 63 01	352 180 70 01			
01.1992→ 11.1986→	OM 353 921, 958-959 OM 356 955 OM 366 955-956					50 005 836	
Reference	366 180 01 01	366 180 04 01					
Reference	OM 353 921, 937 353 200 36 01	353 200 37 01					50 005 617

U 1350



594

05.1988→02.2001	OM 366 955					50 005 843	
Reference	314 180 10 01 364 180 01 01	352 180 24 01	352 180 63 01	352 180 70 01			
09.1991→ 05.1988→02.2001	OM 356 955 OM 366 955					50 005 836	
Reference	366 180 01 01	366 180 04 01					

M



U 1400

595

01.1988→02.2001	OM 366 947, 949, 955					50 005 843	
Reference	314 180 10 01 364 180 01 01	352 180 24 01	352 180 63 01	352 180 70 01			
09.1991→04.2000 07.1994→04.2000 01.1988→02.2001	OM 356 954-956 OM 357 912-913 OM 366 947-949, 955-956, 963					50 005 836	
Reference	366 180 01 01	366 180 04 01					

U 1450

596

01.1988→04.2000	OM 366 947, 955					50 005 843	
Reference	314 180 10 01 364 180 01 01	352 180 24 01	352 180 63 01	352 180 70 01			
09.1991→04.2000 07.1994→04.2000 01.1988→04.2000	OM 356 950, 954-956 OM 357 912-913 OM 366 947-948, 955-956, 963					50 005 836	
Reference	366 180 01 01	366 180 04 01					





U 1500

597

Reference	OM 353 921, 958 366 180 01 01 366 180 04 01		50 005 836	
Reference	OM 353 921 353 200 36 01 353 200 37 01			50 005 617



U 1550

598

05.1988→ Reference	OM 353 961, 995 OM 366 955 314 180 10 01 352 180 24 01 352 180 63 01 352 180 70 01 364 180 01 01		50 005 843	
04.1986→05.1988 03.1990→ 07.1994→04.2000 05.1988→ Reference	OM 353 958 OM 356 955-956, 980, 997-998 OM 357 912-913, 924, 945 OM 366 955-956, 963, 984 366 180 01 01 366 180 04 01		50 005 836	



U 1600

599

01.1988→04.2000 Reference	OM 366 947, 949 314 180 10 01 352 180 24 01 352 180 63 01 352 180 70 01 364 180 01 01		50 005 843	
05.1991→ 07.1994→02.2001 01.1988→04.2000 Reference	OM 356 954-956, 980, 997-998 OM 357 912-913, 924, 945 OM 366 947-949 366 180 01 01 366 180 04 01		50 005 836	

U 1650

600

01.1988→02.2001 Reference	OM 366 947, 949 314 180 10 01 352 180 24 01 352 180 63 01 352 180 70 01 364 180 01 01		50 005 843	
01.1991→02.2001 07.1994→02.2001 01.1988→02.2001 Reference	OM 356 954-956, 980, 997-998 OM 357 912-913, 924, 945 OM 366 947-949 366 180 01 01 366 180 04 01		50 005 836	

U 1700

601

05.1978→09.1988 01.1992→ 09.1988→02.2001 Reference	OM 353 958-959 OM 356 957 OM 366 963 366 180 01 01 366 180 04 01		50 005 836	
---	---	---	------------	--

M



U 1750

602

05.1991→
09.1988→02.2001
Reference

OM 356 957, 981
OM 366 963, 984
366 180 01 01 366 180 04 01

**50 005 836**

U 1800

603

Reference

OM 356 997-998
OM 357 924
366 180 01 01 366 180 04 01

**50 005 836**

U 1850

604

04.1992→
Reference

OM 356 998
366 180 01 01 366 180 04 01

**50 005 836**

U 2100

605

05.1991→
09.1989→
Reference

OM 356 980, 997
OM 357 924, 945
OM 366 984
366 180 01 01 366 180 04 01

**50 005 836**

U 2150

606

05.1991→
09.1989→02.2001
Reference

OM 356 980, 997
OM 357 924, 945
OM 366 984
366 180 01 01 366 180 04 01

**50 005 836**

U 2400

607

05.1991→
07.1993→
Reference

OM 356 980
OM 357 945
366 180 01 01 366 180 04 01

**50 005 836**

U 2450

608

07.1993→
07.1993→08.2002
Reference

OM 356 980
OM 357 945
366 180 01 01 366 180 04 01

**50 005 836**

U 3000

609

09.2002→
Reference

OM 904 952-953
904 200 04 01 904 200 06 01 904 200 08 01 904 200 20 01
904 200 22 01 904 200 26 01 904 200 49 01 904 201 02 01
904 201 07 01

**50 005 627**

U 4000

610

09.2002→
Reference

OM 904 952-953
904 200 04 01 904 200 06 01 904 200 08 01 904 200 20 01
904 200 22 01 904 200 26 01 904 200 49 01 904 201 02 01
904 201 07 01

**50 005 627****M**



U 5000

611

02.2001→ 09.2002→	OM 906 935 OM 924 911					
Reference	904 200 04 01 904 200 22 01 904 201 07 01	904 200 06 01 904 200 26 01	904 200 08 01 904 200 49 01	904 200 20 01 904 201 02 01		50 005 627

Series UX 100



612



08.1996→	OM 602 989					
Reference	602 200 00 20	602 200 01 20	602 200 02 20			50 005 439

Series 206 D 2.0

613

01.1971→07.1977	OM 615 915, 943 (ITA)						
	Lager/bearing/coussinet/cojinete/подшипник: 30 mm						50 005 932

01.1971→07.1977	OM 615 915, 943 (ITA)					
Reference	110 200 01 20					50 005 032
	Lager/bearing/coussinet/cojinete/подшипник: 36 mm					

01.1971→07.1977	OM 615 915, 943 (ITA)					
Reference	110 200 01 20 115 200 15 20	110 200 09 20 115 200 18 20	110 200 17 20 121 200 09 20	115 200 00 20		50 005 035
	Lager/bearing/coussinet/cojinete/подшипник: 40 mm					

M

Series 206 D 2.2

614

03.1973→07.1977	OM 615 917						
	Lager/bearing/coussinet/cojinete/подшипник: 30 mm						50 005 932



03.1973→07.1977	OM 615 917					
Reference	110 200 01 20					50 005 032
	Lager/bearing/coussinet/cojinete/подшипник: 36 mm					

03.1973→07.1977	OM 615 917					
Reference	110 200 01 20 115 200 15 20	110 200 09 20 115 200 18 20	110 200 17 20 121 200 09 20	115 200 00 20		50 005 035
	Lager/bearing/coussinet/cojinete/подшипник: 40 mm					

Series 207 D 2.0

615

08.1977→01.1989	OM 615 944						
	Lager/bearing/coussinet/cojinete/подшипник: 30 mm						50 005 932

08.1977→01.1989	OM 615 944					
Reference	110 200 01 20					50 005 032
	Lager/bearing/coussinet/cojinete/подшипник: 36 mm					

08.1977→01.1989	OM 615 944					
Reference	110 200 01 20 115 200 15 20	110 200 09 20 115 200 18 20	110 200 17 20 121 200 09 20	115 200 00 20		50 005 035
	Lager/bearing/coussinet/cojinete/подшипник: 40 mm					



Series 207 D 2.4

616

09.1982→01.1989 Reference	OM 616 937, 939 616 200 04 20 616 200 07 20			50 005 428
	OM 616 912, 916-917, 934 Lager/bearing/coussinete/cojinete/подшипник: 30 mm			50 005 932
Reference 	OM 616 912, 916-917, 934 110 200 01 20 Lager/bearing/coussinete/cojinete/подшипник: 36 mm			50 005 032
Reference 	OM 616 912, 916-917, 934 110 200 01 20 110 200 09 20 110 200 17 20 115 200 15 20 115 200 18 20 121 200 09 20 Lager/bearing/coussinete/cojinete/подшипник: 40 mm			50 005 035

Series 208 2.3

617

07.1982→06.1995 Reference	M 102 942 102 200 03 01 102 200 03 20 102 200 04 01 102 200 04 20 102 200 11 01 102 200 43 01			50 005 028
05.1977→08.1982 	M 115 955, 972 Lager/bearing/coussinete/cojinete/подшипник: 30 mm			50 005 932
07.1982→06.1995 Reference	M 102 942 102 200 01 20 102 200 08 01 102 200 09 01 102 200 42 01			50 005 029
05.1977→08.1982 Reference 	M 115 955, 972 110 200 01 20 Lager/bearing/coussinete/cojinete/подшипник: 36 mm			50 005 032
05.1977→08.1982 Reference 	M 115 955, 972 110 200 01 20 110 200 09 20 110 200 17 20 115 200 15 20 115 200 18 20 121 200 09 20 Lager/bearing/coussinete/cojinete/подшипник: 40 mm			50 005 035

Series 208 D 2.3

618

10.1988→06.1995 Reference	OM 601 940 602 200 00 20 602 200 01 20 602 200 02 20			50 005 439
------------------------------	---	--	--	-------------------

Series 209 D 2.9

619





01.1994→ Reference	OM 602 940 602 200 00 20 602 200 01 20 602 200 02 20			50 005 439
-----------------------	---	--	--	-------------------

M



Series 210 2.3

620

08.1982→06.1995	M 102	942						
Reference	102 200 03 01 102 200 11 01	102 200 03 20 102 200 43 01	102 200 04 01	102 200 04 20				50 005 028
05.1977→08.1982	M 115	955, 972						
		Lager/bearing/coussinet/cojinete/подшипник: 30 mm						50 005 932
08.1982→06.1995	M 102	942						
Reference	102 200 01 20	102 200 08 01	102 200 09 01	102 200 42 01				50 005 029
05.1977→08.1982	M 115	955, 972						
Reference	110 200 01 20	Lager/bearing/coussinet/cojinete/подшипник: 36 mm						50 005 032
05.1977→08.1982	M 115	955, 972						
Reference	110 200 01 20 115 200 15 20	110 200 09 20 115 200 18 20	110 200 17 20 121 200 09 20	115 200 00 20				50 005 035

M

Series 210 D 2.9

621

10.1988→06.1995	OM 602	940						
Reference	602 200 00 20	602 200 01 20	602 200 02 20					50 005 439



Series 306 D 2.0

622

01.1971→02.1973	OM 615	915						
		Lager/bearing/coussinet/cojinete/подшипник: 30 mm						50 005 932
01.1971→02.1973	OM 615	915						
Reference	110 200 01 20	Lager/bearing/coussinet/cojinete/подшипник: 36 mm						50 005 032
01.1971→02.1973	OM 615	915						
Reference	110 200 01 20 115 200 15 20	110 200 09 20 115 200 18 20	110 200 17 20 121 200 09 20	115 200 00 20				50 005 035

Series 306 D 2.2

623

03.1973→07.1977	OM 615	939						
		Lager/bearing/coussinet/cojinete/подшипник: 30 mm						50 005 932
03.1973→07.1977	OM 615	937, 939						
Reference	110 200 01 20	Lager/bearing/coussinet/cojinete/подшипник: 36 mm						50 005 032



MERCEDES-BENZ

03.1973→07.1977 Reference 	OM 615 937, 939 110 200 01 20 110 200 09 20 110 200 17 20 115 200 00 20 115 200 15 20 115 200 18 20 121 200 09 20 Lager/bearing/coussinete/cojinete/подшипник: 40 mm			50 005 035
Series 307 D 2.0				624
08.1977→10.1985 	OM 615 944 Lager/bearing/coussinete/cojinete/подшипник: 30 mm			50 005 932
08.1977→10.1985 Reference 	OM 615 944 110 200 01 20 Lager/bearing/coussinete/cojinete/подшипник: 36 mm			50 005 032
08.1977→10.1985 Reference 	OM 615 944 110 200 01 20 110 200 09 20 110 200 17 20 115 200 00 20 115 200 15 20 115 200 18 20 121 200 09 20 Lager/bearing/coussinete/cojinete/подшипник: 40 mm			50 005 035
Series 307 D 2.3				625
10.1988→06.1995 Reference	OM 601 940 602 200 00 20 602 200 01 20 602 200 02 20			50 005 439
Series 307 D 2.4				626
09.1982→01.1989 Reference	OM 616 937, 939 616 200 04 20 616 200 07 20			50 005 428
	OM 616 912, 916, 934 Lager/bearing/coussinete/cojinete/подшипник: 30 mm			50 005 932
Reference 	OM 616 912, 916, 934 110 200 01 20 Lager/bearing/coussinete/cojinete/подшипник: 36 mm			50 005 032
Reference 	OM 616 912, 916, 934 110 200 01 20 110 200 09 20 110 200 17 20 115 200 00 20 115 200 15 20 115 200 18 20 121 200 09 20 Lager/bearing/coussinete/cojinete/подшипник: 40 mm			50 005 035
Series 308 2.3				627
08.1982→06.1995 Reference	M 102 942 102 200 03 01 102 200 03 20 102 200 04 01 102 200 04 20 102 200 11 01 102 200 43 01			50 005 028

M



05.1977→08.1982 	M 115 972 Lager/bearing/coussinet/cojinete/подшипник: 30 mm			50 005 932
08.1982→06.1995 Reference	M 102 942 102 200 01 20 102 200 08 01 102 200 09 01 102 200 42 01			50 005 029
05.1977→08.1982 Reference 	M 115 972 110 200 01 20 Lager/bearing/coussinet/cojinete/подшипник: 36 mm			50 005 032
05.1977→08.1982 Reference 	M 115 972 110 200 01 20 110 200 09 20 110 200 17 20 115 200 00 20 115 200 15 20 115 200 18 20 121 200 09 20 Lager/bearing/coussinet/cojinete/подшипник: 40 mm			50 005 035
Series 308 D 2.3				628
10.1988→06.1995 Reference	OM 601 940 602 200 00 20 602 200 01 20 602 200 02 20			50 005 439
Series 308 D 2.4				629
M Reference	OM 616 939 616 200 04 20 616 200 07 20			50 005 428
05.1977→08.1982 	OM 616 934 Lager/bearing/coussinet/cojinete/подшипник: 30 mm			50 005 932
05.1977→08.1982 Reference 	OM 616 934 110 200 01 20 Lager/bearing/coussinet/cojinete/подшипник: 36 mm			50 005 032
05.1977→08.1982 Reference 	OM 616 934 110 200 01 20 110 200 09 20 110 200 17 20 115 200 00 20 115 200 15 20 115 200 18 20 121 200 09 20 Lager/bearing/coussinet/cojinete/подшипник: 40 mm			50 005 035
Series 309 D 2.9				630
Reference	OM 602 940 602 200 00 20 602 200 01 20 602 200 02 20			50 005 439
Series 310 2.3				631
08.1982→06.1995 Reference	M 102 942 102 200 03 01 102 200 03 20 102 200 04 01 102 200 04 20 102 200 11 01 102 200 43 01			50 005 028



MERCEDES-BENZ

05.1977→08.1982 	M 115 972 Lager/bearing/coussinete/cojinete/подшипник: 30 mm					50 005 932
08.1982→06.1995 Reference	M 102 942 102 200 01 20 102 200 08 01 102 200 09 01 102 200 42 01					50 005 029
05.1977→08.1982 Reference 	M 115 972 110 200 01 20 Lager/bearing/coussinete/cojinete/подшипник: 36 mm					50 005 032
05.1977→08.1982 Reference 	M 115 972 110 200 01 20 110 200 09 20 110 200 17 20 115 200 00 20 115 200 15 20 115 200 18 20 121 200 09 20 Lager/bearing/coussinete/cojinete/подшипник: 40 mm					50 005 035
Series 310 D 2.9						632
10.1988→06.1995 Reference	OM 602 940 602 200 00 20 602 200 01 20 602 200 02 20					50 005 439
Series 311						633
1964 → Reference	OM 352 979, 981, 983, 992 314 180 10 01 352 180 24 01 352 180 63 01 352 180 70 01 364 180 01 01					50 005 843
1964 → Reference	OM 352 979, 981, 983, 992 314 180 05 01 314 180 10 01 352 180 63 01					50 005 835
1964 → Reference	OM 352 979, 981, 983, 992 353 200 36 01 353 200 37 01					50 005 617
Series 312						634
1964 → Reference	OM 352 979, 981, 983, 992 314 180 10 01 352 180 24 01 352 180 63 01 352 180 70 01 364 180 01 01					50 005 843
1964 → Reference	OM 352 979, 981, 983, 992 314 180 05 01 314 180 10 01 352 180 63 01					50 005 835













M



1964 → Reference	OM 352 353 200 36 01	979, 981, 983, 992 353 200 37 01				50 005 617
Series 319 1.9						635
1955 →08.1965 Reference	M 121 115 200 01 20 121 200 11 20	922, 926, 929 115 200 12 20 127 200 01 20	115 200 16 20 127 200 02 20	121 200 06 20		50 005 033
Series 319 2.0						636
08.1965→02.1968 Reference	M 121 115 200 01 20 121 200 11 20	941-942 115 200 12 20 127 200 01 20	115 200 16 20 127 200 02 20	121 200 06 20		50 005 033
Series 319 D						637
08.1961→12.1966 Reference	OM 621 115 200 01 20 121 200 11 20	913, 915, 919, 930 115 200 12 20 127 200 01 20	115 200 16 20 127 200 02 20	121 200 06 20		50 005 033
Series 321						638
1974 →1982 Reference	OM 352 314 180 10 01 364 180 01 01	982 352 180 24 01	352 180 63 01	352 180 70 01		50 005 843
1974 →1982 Reference	OM 352 314 180 05 01	982 314 180 10 01	352 180 63 01			50 005 835
1974 →1982 Reference	OM 352 353 200 36 01	982 353 200 37 01				50 005 617
Series 322						639
1964 → Reference	OM 352 314 180 10 01 364 180 01 01	912-913, 944, 949-950, 953-955 352 180 24 01	352 180 63 01	352 180 70 01		50 005 843
1964 → Reference	OM 352 314 180 05 01	912-913, 944, 949-950, 953-955 314 180 10 01	352 180 63 01			50 005 835

M



				
1964 → Reference	OM 352 353 200 36 01	912-913, 944, 949-950, 953-955 353 200 37 01		50 005 617
Series 323				640
07.1964→1982 Reference	OM 352 314 180 10 01 364 180 01 01	910, 932-933, 942, 972-973 352 180 24 01 352 180 63 01 352 180 70 01		50 005 843
07.1964→1982 Reference	OM 352 314 180 05 01	910, 932, 942, 972-973 314 180 10 01 352 180 63 01		50 005 835
07.1964→1982 Reference	OM 352 353 200 36 01	910, 932-933, 942, 972-973 353 200 37 01		50 005 617
Series 327				641
1964 →1982 Reference	OM 352 314 180 10 01 364 180 01 01	901, 912-913, 930-931, 945-946, 976, 978 352 180 24 01 352 180 63 01 352 180 70 01		50 005 843
1964 →1982 Reference	OM 352 314 180 05 01	901, 912-913, 930-931, 945-946, 976, 978 314 180 10 01 352 180 63 01		50 005 835
1964 →1982 Reference	OM 352 353 200 36 01	901, 912-913, 930-931, 945-946, 976, 978 353 200 37 01		50 005 617
Series 328				642
1964 →1982 Reference	OM 352 314 180 10 01 364 180 01 01	911-912, 943-944, 974-975 352 180 24 01 352 180 63 01 352 180 70 01		50 005 843
1964 →1982 Reference	OM 352 314 180 05 01	911-912, 943-944, 974-975 314 180 10 01 352 180 63 01		50 005 835

M



1964 → 1982 Reference	OM 352 353 200 36 01	911-912, 943-944, 974-975 353 200 37 01				50 005 617
Series 329						643
1964 → 1981 Reference	OM 352 314 180 10 01 364 180 01 01	948 352 180 24 01	352 180 63 01	352 180 70 01		50 005 843
1964 → 1981 Reference	OM 352 314 180 05 01	948 314 180 10 01	352 180 63 01			50 005 835
1964 → 1981 Reference	OM 352 353 200 36 01	948 353 200 37 01				50 005 617
Series 405 D 2.0						644
09.1963 → 08.1965 Reference	OM 621 115 200 01 20 121 200 11 20	913, 915, 919, 930 115 200 12 20 127 200 01 20	115 200 16 20 127 200 02 20	121 200 06 20		50 005 033
Series 406 2.0						645
08.1965 → 02.1968 Reference	M 121 115 200 01 20 121 200 11 20	943 115 200 12 20 127 200 01 20	115 200 16 20 127 200 02 20	121 200 06 20		50 005 033
Series 406 D 2.0						646
09.1965 → 12.1966 Reference	OM 621 115 200 01 20 121 200 11 20	913, 915, 919, 930, 932 115 200 12 20 127 200 01 20	115 200 16 20 127 200 02 20	121 200 06 20		50 005 033
Series 406 D 2.2						647
01.1968 → 12.1980 	OM 615 Lager/bearing/coussinet/cojinete/подшипник: 30 mm OM 615.938: 002248 → OM 615.910: 088767 →	910, 938				50 005 932
01.1968 → 12.1980 Reference 	OM 615 110 200 01 20 Lager/bearing/coussinet/cojinete/подшипник: 36 mm OM 615.938: 002248 → OM 615.910: 088767 →	910, 938				50 005 032

M



01.1968→12.1980 1961 →1968 Reference	OM 615 910, 938 OM 621 919, 932 115 200 01 20 115 200 12 20 115 200 16 20 121 200 06 20 121 200 11 20 127 200 01 20 127 200 02 20 OM 615.938: →002247 OM 615.910: →088766					50 005 033
01.1968→12.1980 Reference	OM 615 910, 938 110 200 01 20 110 200 09 20 110 200 17 20 115 200 00 20 115 200 15 20 115 200 18 20 121 200 09 20 Lager/bearing/coussinete/cojinete/подшипник: 40 mm OM 615.938: 002248→ OM 615.910: 088767→					50 005 035
Series 406 D 2.4						648
01.1975→12.1988 Reference	OM 616 910 Lager/bearing/coussinete/cojinete/подшипник: 30 mm					50 005 932
01.1975→12.1988 Reference	OM 616 910 110 200 01 20 Lager/bearing/coussinete/cojinete/подшипник: 36 mm					50 005 032
01.1975→12.1988 Reference	OM 616 910 110 200 01 20 110 200 09 20 110 200 17 20 115 200 00 20 115 200 15 20 115 200 18 20 121 200 09 20 Lager/bearing/coussinete/cojinete/подшипник: 40 mm					50 005 035
Series 407 1.9						649
1955 →08.1965 Reference	M 121 922, 926, 929 115 200 01 20 115 200 12 20 115 200 16 20 121 200 06 20 121 200 11 20 127 200 01 20 127 200 02 20					50 005 033
Series 407 2.0						650
08.1965→02.1968 Reference	M 121 941-942 115 200 01 20 115 200 12 20 115 200 16 20 121 200 06 20 121 200 11 20 127 200 01 20 127 200 02 20					50 005 033
Series 407 D 2.0						651
09.1965→12.1966 Reference	OM 621 932 115 200 01 20 115 200 12 20 115 200 16 20 121 200 06 20 121 200 11 20 127 200 01 20 127 200 02 20					50 005 033
Series 407 D 2.2						652
01.1968→07.1977 Reference	OM 615 910, 938 Lager/bearing/coussinete/cojinete/подшипник: 30 mm OM 615.938: 002248→ OM 615.910: 088767→					50 005 932
01.1968→07.1977 Reference	OM 615 910, 938 110 200 01 20 Lager/bearing/coussinete/cojinete/подшипник: 36 mm OM 615.938: 002248→ OM 615.910: 088767→					50 005 032

M



01.1968→07.1977 Reference	OM 615 910, 938 115 200 01 20 115 200 12 20 115 200 16 20 121 200 06 20 121 200 11 20 127 200 01 20 127 200 02 20 OM 615.938: →002247 OM 615.910: →088766					50 005 033
01.1968→07.1977 Reference	OM 615 910, 938 110 200 01 20 110 200 09 20 110 200 17 20 115 200 00 20 115 200 15 20 115 200 18 20 121 200 09 20 Lager/bearing/coussinet/cojinete/подшипник: 40 mm OM 615.938: 002248→ OM 615.910: 088767→					50 005 035
Series 407 D 2.4						653
08.1981→01.1989 Reference	OM 616 939 616 200 04 20 616 200 07 20					50 005 428
01.1975→01.1989	OM 616 910, 913 Lager/bearing/coussinet/cojinete/подшипник: 30 mm					50 005 932
01.1975→01.1989 Reference	OM 616 910, 913 110 200 01 20 Lager/bearing/coussinet/cojinete/подшипник: 36 mm					50 005 032
01.1975→01.1989 Reference	OM 616 910, 913 110 200 01 20 110 200 09 20 110 200 17 20 115 200 00 20 115 200 15 20 115 200 18 20 121 200 09 20 Lager/bearing/coussinet/cojinete/подшипник: 40 mm					50 005 035
Series 408 1.9						654
1955→08.1965 Reference	M 121 922, 926, 929 115 200 01 20 115 200 12 20 115 200 16 20 121 200 06 20 121 200 11 20 127 200 01 20 127 200 02 20					50 005 033
Series 408 2.0						655
08.1965→02.1968 Reference	M 121 941-943 115 200 01 20 115 200 12 20 115 200 16 20 121 200 06 20 121 200 11 20 127 200 01 20 127 200 02 20					50 005 033
Series 408 2.2						656
01.1968→12.1974 Reference	M 115 921, 928 115 200 01 20 115 200 12 20 115 200 16 20 121 200 06 20 121 200 11 20 127 200 01 20 127 200 02 20					50 005 033
Series 408 2.3						657
08.1982→06.1995 Reference	M 102 943 102 200 03 01 102 200 03 20 102 200 04 01 102 200 04 20 102 200 11 01 102 200 43 01					50 005 028

M



01.1975→08.1982 	M 115 952, 971 Lager/bearing/coussinnet/cojinete/подшипник: 30 mm					50 005 932
08.1982→06.1995 Reference	M 102 943 102 200 01 20 102 200 08 01 102 200 09 01 102 200 42 01					50 005 029
01.1975→08.1982 Reference 	M 115 952, 971 110 200 01 20 Lager/bearing/coussinnet/cojinete/подшипник: 36 mm					50 005 032
01.1975→08.1982 Reference 	M 115 952, 971 110 200 01 20 110 200 09 20 110 200 17 20 115 200 00 20 115 200 15 20 115 200 18 20 121 200 09 20 Lager/bearing/coussinnet/cojinete/подшипник: 40 mm					50 005 035
Series 408 D 2.3						658
11.1988→12.1995 Reference	OM 601 940 602 200 00 20 602 200 01 20 602 200 02 20					50 005 439
Series 408 D 3.8						659
01.1968→12.1974 Reference 	OM 314 946, 948 314 180 10 01 364 180 01 01 352 180 24 01 352 180 63 01 352 180 70 01 020056→					50 005 843
01.1968→12.1974 Reference 	OM 314 946, 948 314 180 05 01 314 180 10 01 352 180 63 01 →020055					50 005 835
Series 409 2.2						660
01.1968→12.1974 Reference	M 115 921, 928 115 200 01 20 115 200 12 20 115 200 16 20 121 200 06 20 121 200 11 20 127 200 01 20 127 200 02 20					50 005 033
Series 409 2.3						661
08.1982→06.1995 Reference	M 102 943 102 200 03 01 102 200 03 20 102 200 04 01 102 200 04 20 102 200 11 01 102 200 43 01					50 005 028
01.1975→08.1982 	M 115 952, 971 Lager/bearing/coussinnet/cojinete/подшипник: 30 mm					50 005 932

M























08.1982→06.1995 Reference	M 102 102 200 01 20	943 102 200 08 01	102 200 09 01	102 200 42 01			50 005 029
01.1975→08.1982 Reference 	M 115 110 200 01 20	952, 971 Lager/bearing/coussinet/cojinete/подшипник: 36 mm					50 005 032
01.1975→08.1982 Reference 	M 115 110 200 01 20	952, 971 110 200 09 20 115 200 15 20 115 200 18 20 121 200 09 20	110 200 17 20	115 200 00 20			50 005 035
Series 410 2.2							662
01.1968→12.1974 Reference	M 115 115 200 01 20 121 200 11 20	921, 928 115 200 12 20 127 200 01 20	115 200 16 20 127 200 02 20	121 200 06 20			50 005 033
Series 410 2.3							663
08.1982→06.1995 Reference	M 102 102 200 03 01 102 200 11 01	942-943 102 200 03 20 102 200 43 01	102 200 04 01	102 200 04 20			50 005 028
01.1975→08.1982 	M 115 110 200 01 20	952, 971 Lager/bearing/coussinet/cojinete/подшипник: 30 mm					50 005 932
08.1982→06.1995 Reference	M 102 102 200 01 20	942-943 102 200 08 01	102 200 09 01	102 200 42 01			50 005 029
01.1975→08.1982 Reference 	M 115 110 200 01 20	952, 971 Lager/bearing/coussinet/cojinete/подшипник: 36 mm					50 005 032
01.1975→08.1982 Reference 	M 115 110 200 01 20	952, 971 110 200 09 20 115 200 15 20 115 200 18 20 121 200 09 20	110 200 17 20	115 200 00 20			50 005 035
Series 410 D 2.9							664
11.1988→12.1995 Reference	OM 602 602 200 00 20	940 602 200 01 20	602 200 02 20				50 005 439
Series 507 D 2.4							665
04.1986→04.1989 	OM 616 110 200 01 20	914 Lager/bearing/coussinet/cojinete/подшипник: 30 mm					50 005 932

M



MERCEDES-BENZ

				
04.1986→04.1989 Reference 	OM 616 914 110 200 01 20 Lager/bearing/coussinnet/cojinete/подшипник: 36 mm			50 005 032
04.1986→04.1989 Reference 	OM 616 914 110 200 01 20 110 200 09 20 110 200 17 20 115 200 00 20 115 200 15 20 115 200 18 20 121 200 09 20 Lager/bearing/coussinnet/cojinete/подшипник: 40 mm			50 005 035
Series 508 3.8				666
Reference 	OM 314 922, 946, 948, 959, 961-963 314 180 10 01 352 180 24 01 352 180 63 01 352 180 70 01 364 180 01 01 OM 314.946, OM 314.948, OM 314.959, OM 314.961: 020056→			50 005 843
01.1970→02.1989 Reference 	OM 314 946, 948, 959, 961 314 180 05 01 314 180 10 01 352 180 63 01 →020055			50 005 835
Series 508 D 2.3				667
03.1989→02.2001 Reference	OM 601 941 602 200 00 20 602 200 01 20 602 200 02 20			50 005 439
Series 508 D 3.8				668
01.1970→12.1988 Reference 	OM 314 946 OM 394 900 005 (AFS) 314 180 10 01 352 180 24 01 352 180 63 01 352 180 70 01 364 180 01 01 OM 314.946: 020056→			50 005 843
01.1970→12.1988 Reference 	OM 314 946 314 180 05 01 314 180 10 01 352 180 63 01 →020055			50 005 835
Series 608				669
Reference 	OM 314 910, 922, 944, 946, 948, 959, 961-963, 967 OM 394 900 005 (AFS) 314 180 10 01 352 180 24 01 352 180 63 01 352 180 70 01 364 180 01 01 OM 314.910, OM 314.944, OM 314.946, OM 314.948, OM 314.959, OM 314.961: 020056→			50 005 843
01.1968→02.1989 Reference 	OM 314 910, 944, 946, 948, 959, 961 314 180 05 01 314 180 10 01 352 180 63 01 →020055			50 005 835

M



Series 609

670

04.1986→09.2001 OM 364 906, 913, 919
 Reference 314 180 10 01 352 180 24 01 352 180 63 01 352 180 70 01
 364 180 01 01

**50 005 843**

04.1986→09.2001 OM 364 906, 913, 919
 Reference 364 200 01 01 364 200 09 01 364 200 20 01

**50 005 633**
NEW

Series 610

671

06.1994→ OM 354 902
 Reference 314 180 10 01 352 180 24 01 352 180 63 01 352 180 70 01
 364 180 01 01

**50 005 843**

06.1994→ OM 354 902
 06.1985→ OM 374 953
 Reference 364 200 01 01 364 200 09 01 364 200 20 01

**50 005 633**
NEW**M**

Series 611

672

06.1994→ OM 354 902
 07.1987→12.1992 OM 364 954
 Reference 314 180 10 01 352 180 24 01 352 180 63 01 352 180 70 01
 364 180 01 01

**50 005 843**

06.1994→ OM 354 902
 07.1987→12.1992 OM 364 954
 Reference 364 200 01 01 364 200 09 01 364 200 20 01

**50 005 633**
NEW

Series 613

673

04.1977→12.1988 OM 353 963, 966, 968-969
 Reference 353 200 56 01

**50 005 618**

04.1977→12.1988 OM 353 963, 966, 968-969
 Reference 314 180 10 01 352 180 24 01 352 180 63 01 352 180 70 01
 364 180 01 01

**50 005 843**

Series 614

674

06.1994→ OM 354 924
 Reference 314 180 10 01 352 180 24 01 352 180 63 01 352 180 70 01
 364 180 01 01

**50 005 843**



MERCEDES-BENZ

Reference	OM 906 914 904 200 04 01 904 200 22 01 904 201 07 01	904 200 06 01 904 200 26 01	904 200 08 01 904 200 49 01	904 200 20 01 904 201 02 01			50 005 627
06.1994→ Reference	OM 354 924 364 200 01 01	364 200 09 01	364 200 20 01				50 005 633 NEW
Series 615							675
Reference	OM 904 955 904 200 04 01 904 200 22 01 904 201 07 01	904 200 06 01 904 200 26 01	904 200 08 01 904 200 49 01	904 200 20 01 904 201 02 01			50 005 627
Series 709							676
11.1977→12.1984 Reference	OM 314 910, 944, 964-965 OM 364 906-907, 912-913, 918-919, 921 314 180 10 01 352 180 24 01 352 180 63 01 352 180 70 01 364 180 01 01 OM 314.910, OM 314.944: 020056→						50 005 843
11.1977→12.1984 Reference	OM 314 910, 944 314 180 05 01 314 180 10 01 352 180 63 01 →020055						50 005 835
Reference	OM 364 906-907, 912-913, 918-919, 921 OM 374 905 364 200 01 01 364 200 09 01 364 200 20 01						50 005 633 NEW
Series 710							677
07.1964→1982 06.1994→ Reference	OM 352 910, 932-933, 942, 972-973 OM 354 902-903 314 180 10 01 352 180 24 01 352 180 63 01 352 180 70 01 364 180 01 01						50 005 843
07.1964→1982 Reference	OM 352 910, 932, 942, 972-973 314 180 05 01 314 180 10 01 352 180 63 01						50 005 835
07.1964→1982 Reference	OM 352 910, 932-933, 942, 972-973 353 200 36 01 353 200 37 01						50 005 617

M



06.1994→	OM 354 902-903 OM 370 905, 952 OM 374 905, 953, 986, 988					50 005 633 <small>NEW</small>
Reference	364 200 01 01 364 200 09 01 364 200 20 01					
Series 711						678
03.1994→ 04.1986→	OM 354 900 OM 364 950, 952, 957					50 005 843
Reference	314 180 10 01 352 180 24 01 352 180 63 01 352 180 70 01 364 180 01 01					
03.1996→	OM 904 905					50 005 627
Reference	904 200 04 01 904 200 06 01 904 200 08 01 904 200 20 01 904 200 22 01 904 200 26 01 904 200 49 01 904 201 02 01 904 201 07 01					
03.1994→ 04.1986→	OM 354 900 OM 364 950, 952, 957					50 005 633 <small>NEW</small>
Reference	364 200 01 01 364 200 09 01 364 200 20 01					
Series 712						679
Reference	OM 904 918 904 200 04 01 904 200 06 01 904 200 08 01 904 200 20 01 904 200 22 01 904 200 26 01 904 200 49 01 904 201 02 01 904 201 07 01					50 005 627
06.1985→	OM 374 951					50 005 633 <small>NEW</small>
Reference	364 200 01 01 364 200 09 01 364 200 20 01					
Series 714						680
06.1994→	OM 354 923					50 005 843
Reference	314 180 10 01 352 180 24 01 352 180 63 01 352 180 70 01 364 180 01 01					
06.1994→	OM 354 923					50 005 633 <small>NEW</small>
Reference	364 200 01 01 364 200 09 01 364 200 20 01					
Series 808						681
10.1969→10.1977	OM 314 910, 944					50 005 843
Reference	314 180 10 01 352 180 24 01 352 180 63 01 352 180 70 01 364 180 01 01 020056→					

M



10.1969→10.1977 Reference 	OM 314 910, 944 314 180 05 01 314 180 10 01 352 180 63 01 →020055		50 005 835	
Series 809				682
11.1977→12.1984 Reference 	OM 314 910, 944, 964-965 OM 364 906-907, 911-913, 918, 920-921 314 180 10 01 352 180 24 01 352 180 63 01 352 180 70 01 364 180 01 01 OM 314.910, OM 314.944: 020056→		50 005 843	
11.1977→12.1984 Reference 	OM 314 910, 944 314 180 05 01 314 180 10 01 352 180 63 01 →020055		50 005 835	
Reference	OM 364 906-907, 911-913, 918, 920-921 OM 374 907-908 364 200 01 01 364 200 09 01 364 200 20 01		50 005 633 NEW	
Series 810				683
Reference	OM 352 907, 909, 934, 985-986, 996 OM 353 909, 983 353 200 56 01		50 005 618	
06.1994→ Reference	OM 352 907, 934, 985-986, 996 OM 353 909, 983 OM 354 903 314 180 10 01 352 180 24 01 352 180 63 01 352 180 70 01 364 180 01 01		50 005 843	
Reference	OM 352 907, 909, 934, 985-986, 996 314 180 05 01 314 180 10 01 352 180 63 01		50 005 835	
06.1994→ Reference	OM 354 903 364 200 01 01 364 200 09 01 364 200 20 01		50 005 633 NEW	
Series 811				684
1964 → Reference	OM 353 903, 915, 941, 965 353 200 56 01		50 005 618	

M



1964 → 03.1994 → 04.1986 → Reference	OM 353 903, 915, 941, 965 OM 354 900-901, 903 OM 364 950, 952, 954, 958	314 180 10 01 364 180 01 01 OM 353.941, OM 353.965: 067708 →	352 180 24 01 352 180 63 01 352 180 70 01	 50 005 843			
03.1996 → Reference	OM 904 905	904 200 04 01 904 200 22 01 904 201 07 01	904 200 06 01 904 200 26 01	904 200 08 01 904 200 49 01	904 200 20 01 904 201 02 01	 50 005 627	
03.1994 → 04.1986 → Reference	OM 354 900-901, 903 OM 364 950, 952, 954, 958	364 200 01 01	364 200 09 01	364 200 20 01		 50 005 633 NEW	
Series 812							685
06.1985 → Reference	OM 374 950, 952	364 200 01 01	364 200 09 01	364 200 20 01		 50 005 633 NEW	
Series 813							686
10.1969 → 12.1984 Reference	OM 353 904, 965, 981-982	353 200 56 01				 50 005 618	
10.1969 → 12.1984 Reference	OM 353 904, 965, 981-982	314 180 10 01 364 180 01 01 OM 353.904, OM 353.965: 067708 →	352 180 24 01	352 180 63 01	352 180 70 01	 50 005 843	
06.1985 → Reference	OM 370 951	364 200 01 01	364 200 09 01	364 200 20 01		 50 005 633 NEW	
Series 814							687
03.1994 → 02.1992 → 11.1987 → 03.1984 → 02.1993 Reference	OM 354 920-922, 924-925 OM 356 901-902, 911 OM 364 981, 984, 986-987 OM 366 905, 907, 910, 919, 932	314 180 10 01 364 180 01 01	352 180 24 01	352 180 63 01	352 180 70 01	 50 005 843	
02.1992 → 03.1984 → 02.1993 Reference	OM 356 901-902, 911 OM 366 905, 907, 910, 919, 932	366 200 09 01	366 200 59 01			 50 005 629	

M



03.1994→ 11.1987→ Reference	OM 354 OM 364 OM 374 364 200 01 01	920-922, 924-925 981, 984, 986-987 980, 984, 987 364 200 09 01 364 200 20 01		50 005 633 NEW
Series 817				688
02.1992→ 03.1994→ 03.1984→ Reference	OM 356 OM 357 OM 366 366 180 01 01	948, 951 900, 904, 908, 916-917, 936-938 942-943, 966-969, 973 366 180 04 01		50 005 836
02.1992→ 03.1994→ 03.1984→ Reference	OM 356 OM 357 OM 366 366 200 09 01	948, 951 900, 904, 908, 916-917, 936-938 942-943, 966-969, 973 366 200 59 01		50 005 629
03.1996→ Reference	OM 904 904 200 04 01 904 200 22 01 904 201 07 01	907 904 200 06 01 904 200 08 01 904 200 20 01 904 200 26 01 904 200 49 01 904 201 02 01		50 005 627
Series 911				689
Reference	OM 352 OM 353 353 200 56 01	907, 909, 934, 985-986, 996 909, 983-984		50 005 618
Reference	OM 352 OM 353 OM 396 314 180 10 01 364 180 01 01 OM 353.900: 067374→	904, 906-908, 911-912, 934, 936, 943-944, 948, 969, 974-975, 985-986, 989-990, 996 900, 909, 911, 934, 983-984 900 005, 900 007 352 180 24 01 352 180 63 01 352 180 70 01		50 005 843
Reference	OM 352 314 180 05 01	906-909, 911-912, 934, 936, 943-944, 948, 969, 974-975, 985-986, 989-990, 996 314 180 10 01 352 180 63 01		50 005 835
01.1972→02.2001 Reference	OM 353 366 180 01 01	911 366 180 04 01		50 005 836
1964 →02.2001 Reference	OM 352 OM 353 353 200 36 01	904, 906, 908, 911-912, 936, 943-944, 948, 969, 974-975, 989-990 900, 911, 934 353 200 37 01		50 005 617

M



Series 912

690

06.1985→ Reference	OM 374 950 364 200 01 01 364 200 09 01 364 200 20 01			50 005 633 NEW
-----------------------	---	---	--	---------------------------------

Series 913





691

1964 → Reference	OM 353 903-904, 915, 941, 965, 981-982 353 200 56 01			50 005 618
1964 → Reference	OM 353 903-904, 915, 941, 965, 981-982 314 180 10 01 352 180 24 01 352 180 63 01 352 180 70 01 364 180 01 01 OM 353.904, OM 353.941, OM 353.965: 067708→		50 005 843	
06.1985→ 06.1985→ Reference	OM 370 950 OM 374 950 364 200 01 01 364 200 09 01 364 200 20 01			50 005 633 NEW

M

Series 914

692

02.1992→ 03.1984→ Reference	OM 356 901, 903, 911 OM 366 905, 907, 914, 918, 930, 932, 940 314 180 10 01 352 180 24 01 352 180 63 01 352 180 70 01 364 180 01 01		50 005 843	
02.1992→ 03.1984→ Reference	OM 356 901, 903, 911 OM 366 905, 907, 914, 918, 930, 932, 940 366 200 09 01 366 200 59 01			50 005 629
Reference	OM 904 906, 919, 924, 957 904 200 04 01 904 200 06 01 904 200 08 01 904 200 20 01 904 200 22 01 904 200 26 01 904 200 49 01 904 201 02 01 904 201 07 01			50 005 627
Reference	OM 374 980-982, 984 364 200 01 01 364 200 09 01 364 200 20 01			50 005 633 NEW

Series 917

693

Reference	OM 353 991 353 200 56 01			50 005 618
-----------	-----------------------------	--	--	-------------------



12.1992→ 03.1994→ 08.1984→02.1993 Reference	OM 353 991 OM 356 941, 952 OM 357 900-901, 906, 909-910, 916, 918, 961 OM 366 944-945, 966, 974, 978 366 180 01 01 366 180 04 01		50 005 836	
12.1992→ 03.1994→ 08.1984→02.1993 Reference	OM 356 941, 952 OM 357 900-901, 906, 916, 918 OM 366 944-945, 966, 974, 978 366 200 09 01 366 200 59 01			50 005 629
03.1996→ Reference	OM 904 906-907 904 200 04 01 904 200 06 01 904 200 08 01 904 200 20 01 904 200 22 01 904 200 26 01 904 200 49 01 904 201 02 01 904 201 07 01			50 005 627
Series 1013				694
09.1965→03.1977 Reference	OM 352 964, 996 OM 353 904, 909, 942-946, 965, 981-982, 989 353 200 56 01			50 005 618
09.1965→03.1977 Reference 	OM 352 964, 996 OM 353 904, 909, 942-946, 965, 981-982, 989 314 180 10 01 352 180 24 01 352 180 63 01 352 180 70 01 364 180 01 01 OM 353.904, OM 353.965: 067708→		50 005 843	
09.1965→03.1977 Reference	OM 352 964, 996 314 180 05 01 314 180 10 01 352 180 63 01		50 005 835	
Series 1014				695
Reference	OM 306 900 018 (ZA) 314 180 10 01 352 180 24 01 352 180 63 01 352 180 70 01 364 180 01 01		50 005 843	
Series 1017				696
09.1975→02.1991 Reference	OM 353 950-954, 970-972, 975, 997 353 200 56 01			50 005 618
09.1975→02.1991 Reference	OM 353 950-954, 970-972 314 180 10 01 352 180 24 01 352 180 63 01 352 180 70 01 364 180 01 01		50 005 843	
09.1975→02.1991 04.1984→ Reference	OM 353 950-954, 970-972, 975, 997 OM 366 951, 981 366 180 01 01 366 180 04 01		50 005 836	

M



04.1984→ Reference	OM 366 366 200 09 01	951, 981 366 200 59 01		50 005 629
Series 1019				697
04.1972→09.1984 Reference	OM 401 403 200 76 01	919, 922, 924 403 200 77 01		50 005 615
04.1972→09.1984 Reference	OM 401 403 200 27 01 403 200 49 01	919, 922, 924 403 200 32 01 403 200 70 01	403 200 34 01 403 200 35 01 	50 005 207
04.1972→09.1984 Reference	OM 401 403 200 44 01	919, 922, 924 403 200 51 01 403 200 71 01		50 005 210
Series 1113				698
1968 →1977 Reference	OM 360 360 200 03 01	937-938, 951-952, 962 360 200 09 01 360 200 37 01 360 200 45 01		50 005 203
1968 →1977 Reference	OM 360 360 180 06 01 360 180 20 01	935-938, 951-952, 962 360 180 07 01 360 180 24 01 360 180 15 01 360 180 18 01 360 180 26 01		50 005 830
10.1967→12.1992 Reference	OM 352 OM 353 353 200 56 01	905, 964, 996-998 904, 909, 938, 965, 982		50 005 618
	M 352 OM 352 OM 353 OM 396 Reference 314 180 10 01 364 180 01 01 OM 353.904, OM 353.965: 067708→	924 904-905, 908, 912-914, 949-950, 953, 955, 963-964, 968, 990, 994, 996-998 904, 909, 911, 913, 933, 938, 965, 982 900 005, 900 012 352 180 24 01 352 180 63 01 352 180 70 01		50 005 843
Reference	OM 352 314 180 05 01	905, 908, 912-914, 949-950, 953, 955, 963-964, 968, 990, 994, 996-998 314 180 10 01 352 180 63 01		50 005 835

M



01.1972→02.2001 Reference	OM 344 912, 937 OM 353 911, 913 366 180 01 01 366 180 04 01			50 005 836
Reference	OM 352 904-905, 908, 912-914, 949-950, 953, 955, 963, 968, 990, 994 OM 353 911, 913, 933 353 200 36 01 353 200 37 01			50 005 617
Series 1114				699
08.1984→ Reference	OM 306 900 016 (ZA) OM 356 903-904, 907, 916 OM 366 906-907, 914, 918, 930-931, 933, 935 314 180 10 01 352 180 24 01 352 180 63 01 352 180 70 01 364 180 01 01			50 005 843
Reference	OM 356 903-904, 907, 916 OM 366 906-907, 914, 918, 930-931, 933, 935 366 200 09 01 366 200 59 01			50 005 629
03.1996→ Reference	OM 904 906-907 904 200 04 01 904 200 06 01 904 200 08 01 904 200 20 01 904 200 22 01 904 200 26 01 904 200 49 01 904 201 02 01 904 201 07 01			50 005 627
Reference	OM 374 980, 984 364 200 01 01 364 200 09 01 364 200 20 01			50 005 633 <small>NEW</small>
Series 1115				700
Reference	OM 904 925 904 200 04 01 904 200 06 01 904 200 08 01 904 200 20 01 904 200 22 01 904 200 26 01 904 200 49 01 904 201 02 01 904 201 07 01			50 005 627
Series 1116				701
06.1973→ Reference	OM 344 937 366 180 01 01 366 180 04 01			50 005 836
Series 1117				702
02.1992→ 03.1994→ 04.1984→ Reference	OM 356 947, 949, 959 OM 357 901-902, 906-907, 918-919, 961 OM 366 941, 953, 962, 966, 970-971, 975-976 366 180 01 01 366 180 04 01			50 005 836

M



02.1992→ 03.1994→ 04.1984→ Reference	OM 356 OM 357 OM 366 366 200 09 01	947, 949, 959 901-902, 906, 918-919 941, 953, 962, 966, 970-971, 975-976 366 200 59 01		50 005 629
03.1996→ Reference	OM 904 904 200 04 01 904 200 22 01 904 201 07 01	906-907 904 200 06 01 904 200 26 01 904 200 08 01 904 200 49 01 904 200 20 01 904 201 02 01		50 005 627
Series 1120				703
02.1992→ 06.1994→ 04.1984→ Reference	OM 356 OM 357 OM 366 366 180 01 01	983, 986, 993-996 920-921, 927, 929, 932 962, 980, 988, 990, 992-994, 999 366 180 04 01		50 005 836
02.1992→ 06.1994→ 04.1984→ Reference	OM 356 OM 357 OM 366 366 200 09 01	983, 986, 993-996 920-921, 927, 929 962, 980, 988, 990, 992-994, 999 366 200 59 01		50 005 629
Series 1121				704
04.1984→ Reference	OM 366 366 180 01 01	941, 962 366 180 04 01		50 005 836
04.1984→ Reference	OM 366 366 200 09 01	941, 962 366 200 59 01		50 005 629
Series 1124				705
03.1992→08.1993 06.1994→ Reference	OM 356 OM 357 366 180 01 01	979, 983, 989, 991 933, 942-944 366 180 04 01		50 005 836
03.1992→08.1993 Reference	OM 356 366 200 09 01	979, 983, 989, 991 366 200 59 01		50 005 629
Series 1213				706
09.1965→12.1966 Reference	OM 352 OM 353 353 200 56 01	939, 964, 987 909, 935, 943-946, 989		50 005 618













M



09.1965→12.1966 Reference	OM 352 OM 353 OM 396 314 180 10 01 364 180 01 01	939, 964, 987 909, 935, 943-946, 989 900 008 (AFS), 900 020 (AFS) 352 180 24 01 352 180 63 01 352 180 70 01		50 005 843
09.1965→12.1966 Reference	OM 352 314 180 05 01	939, 964, 987 314 180 10 01 352 180 63 01		50 005 835
Series 1214				707
03.1984→ Reference	OM 306 OM 341 OM 366 314 180 10 01 364 180 01 01	900 016 (ZA) 941 913 352 180 24 01 352 180 63 01 352 180 70 01		50 005 843
03.1984→ Reference	OM 366 366 200 09 01	913 366 200 59 01		50 005 629
Reference	OM 374 364 200 01 01	985 364 200 09 01 364 200 20 01		50 005 633 <small>NEW</small>
Series 1215				708
Reference	OM 904 904 200 04 01 904 200 22 01 904 201 07 01	925 904 200 06 01 904 200 26 01 904 200 08 01 904 200 49 01 904 200 20 01 904 201 02 01		50 005 627
Series 1216				709
1968 →1977 Reference	OM 360 360 200 03 01	939, 944, 946, 949-950, 961, 964-965, 972 360 200 09 01 360 200 37 01 360 200 45 01		50 005 203
1968 →1977 Reference	OM 360 360 180 06 01 360 180 20 01	939, 944, 946, 949-950, 961, 964-965, 972 360 180 07 01 360 180 24 01 360 180 15 01 360 180 26 01 360 180 18 01		50 005 830
Series 1217				710
09.1975→09.1985 06.1983→06.1985 Reference	OM 353 OM 362 353 200 56 01	950-953, 970-971, 997 906		50 005 618















M



					
09.1975→09.1985 Reference	OM 353 314 180 10 01 364 180 01 01	950-953, 970-971 352 180 24 01 352 180 63 01 352 180 70 01		50 005 843	
09.1975→09.1985 06.1983→06.1985 10.1984→ Reference	OM 353 OM 362 OM 366 366 180 01 01	950-953, 970-971, 997 906 960 366 180 04 01		50 005 836	
10.1984→ Reference	OM 366 366 200 09 01	960 366 200 59 01		50 005 629	
Series 1218				711	
Reference	OM 904 904 200 04 01 904 200 22 01 904 201 07 01	912, 938 904 200 06 01 904 200 26 01	904 200 08 01 904 200 49 01	904 200 20 01 904 201 02 01	 50 005 627
Series 1219				712	
04.1972→01.1987 Reference	OM 401 403 200 76 01	905-906, 914-915, 918-919, 921-922, 924-925 403 200 77 01		50 005 615	
04.1972→01.1987 Reference	OM 401 403 200 27 01 403 200 49 01	905-906, 914-915, 918-919, 921-922, 924-925 403 200 32 01 403 200 70 01	403 200 34 01 403 200 35 01	50 005 207	
04.1972→01.1987 Reference	OM 401 403 200 44 01	905-906, 914-915, 918-919, 921-922, 924-925 403 200 51 01 403 200 71 01		50 005 210	
Series 1222				713	
02.1993→08.1994 1979 → Reference	OM 401 OM 422 401 180 00 01	975 907, 909, 913 401 180 01 01	403 180 06 01 403 180 17 01	 50 005 837	
02.1993→08.1994 05.1982→12.1991 1979 → Reference	OM 401 OM 421 OM 422 403 200 76 01	975 905-906, 909 907, 909, 913 403 200 77 01		50 005 615	
12.1988→08.1994 Reference	OM 441 441 200 01 01	905, 913-915, 917, 920, 923, 925-927 441 200 02 01		50 005 616	

M



				
02.1993→ Reference	OM 366 999 366 180 01 01 366 180 04 01			50 005 836
02.1993→ Reference	OM 366 999 366 200 09 01 366 200 59 01			50 005 629
02.1993→08.1994 05.1982→12.1991 1979 → 12.1988→08.1994 Reference	OM 401 975 OM 421 905-906, 909 OM 422 907, 909, 913 OM 441 905, 913-915, 917, 920, 923, 925-927 403 200 44 01 403 200 51 01 403 200 71 01			50 005 210
Series 1224				714
12.1990→ Reference	OM 401 975, 984, 990 401 180 00 01 401 180 01 01 403 180 06 01 403 180 17 01			50 005 837
12.1990→ Reference	OM 401 975, 984, 990 403 200 76 01 403 200 77 01			50 005 615
1988 → Reference	OM 441 927 441 200 01 01 441 200 02 01			50 005 616
02.1993→ 01.1994→ 02.1993→ Reference	OM 356 999 OM 357 946 OM 366 999 366 180 01 01 366 180 04 01			50 005 836
02.1993→ Reference	OM 366 999 366 200 09 01 366 200 59 01			50 005 629
12.1990→ 1988 → Reference	OM 401 975, 984, 990 OM 441 927 403 200 44 01 403 200 51 01 403 200 71 01			50 005 210
Series 1225				715
1979 → 1988 → Reference	OM 422 909, 913, 923 OM 442 907 401 180 00 01 401 180 01 01 403 180 06 01 403 180 17 01			50 005 837

M



MERCEDES-BENZ

1979 → Reference	OM 421 909 OM 422 909, 913, 923 403 200 76 01 403 200 77 01			50 005 615
1988 → Reference	OM 442 907 441 200 01 01 441 200 02 01			50 005 616
1979 → 1988 → Reference	OM 421 909 OM 422 909, 913, 923 OM 442 907 403 200 44 01 403 200 51 01 403 200 71 01			50 005 210

Series 1226

716

02.1993→ 07.1995→ 02.1990→09.1993 Reference	OM 401 973, 984, 989 OM 441 986, 989 OM 442 907, 920, 926, 933 401 180 00 01 401 180 01 01 403 180 06 01 403 180 17 01		50 005 837	
02.1993→ 07.1995→ Reference	OM 401 973, 984, 989 OM 441 986, 989 403 200 76 01 403 200 77 01			50 005 615
02.1990→09.1993 Reference	OM 442 907, 920, 926, 933 441 200 01 01 441 200 02 01			50 005 616
02.1993→ 07.1995→ 02.1990→09.1993 Reference	OM 401 973, 984, 989 OM 441 986, 989 OM 442 907 403 200 44 01 403 200 51 01 403 200 71 01			50 005 210















Series 1227

717

01.1992→ 1988 → 01.1994→ Reference	OM 401 973, 978, 989 OM 442 907, 914, 920, 926, 932-933 OM 445 933 401 180 00 01 401 180 01 01 403 180 06 01 403 180 17 01		50 005 837	
01.1992→ 01.1994→ Reference	OM 401 973, 978, 989 OM 445 933 403 200 76 01 403 200 77 01			50 005 615
1988 → Reference	OM 442 907, 914, 920, 926, 932-933 441 200 01 01 441 200 02 01			50 005 616

M





					
01.1992→ 1988 → 01.1994→ Reference	OM 401 OM 442 OM 445 403 200 44 01	973, 978, 989 907, 914 933 403 200 51 01	403 200 71 01		50 005 210
Series 1228					718
1979 → 1988 → Reference	OM 422 OM 442 401 180 00 01	907, 909, 913 907 401 180 01 01	403 180 06 01 403 180 17 01		50 005 837
1979 → Reference	OM 422 403 200 76 01	907, 909, 913 403 200 77 01			50 005 615
1988 → Reference	OM 442 441 200 01 01	907 441 200 02 01			50 005 616
1979 → 1988 → Reference	OM 422 OM 442 403 200 44 01	907, 909, 913 907 403 200 51 01	403 200 71 01		50 005 210
Series 1231					719
05.1991→ Reference	OM 401 401 180 00 01	974, 986 401 180 01 01	403 180 06 01 403 180 17 01		50 005 837
05.1991→ Reference	OM 401 403 200 76 01	974, 986 403 200 77 01			50 005 615
02.1993→ 02.1993→ Reference	OM 356 OM 366 366 180 01 01	999 999 366 180 04 01			50 005 836
02.1993→ Reference	OM 366 366 200 09 01	999 366 200 59 01			50 005 629
05.1991→ Reference	OM 401 403 200 44 01	974, 986 403 200 51 01	403 200 71 01		50 005 210

M





Series 1234

720

07.1995→05.1998 01.1994→	OM 441 989, 993 OM 445 923, 933					50 005 837	
Reference	401 180 00 01	401 180 01 01	403 180 06 01	403 180 17 01			
07.1995→05.1998 01.1994→	OM 441 989, 993 OM 445 923, 933						50 005 615
Reference	403 200 76 01	403 200 77 01					
07.1995→05.1998 01.1994→	OM 441 989, 993 OM 445 923, 933						50 005 210
Reference	403 200 44 01	403 200 51 01	403 200 71 01				





Series 1245

721

1985 →02.1991	OM 442 953					50 005 834	
Reference	403 180 33 01	423 180 01 01	423 180 05 01				
1985 →02.1991	OM 442 953						50 005 615
Reference	403 200 76 01	403 200 77 01					
1985 →02.1991	OM 442 953						50 005 210
Reference	403 200 44 01	403 200 51 01	403 200 71 01				













Series 1313

722

1968 →1977	OM 360 937-938, 951-952, 962						50 005 203
Reference	360 200 03 01	360 200 09 01	360 200 37 01	360 200 45 01			
1968 →1977	OM 360 935-938, 951-952, 962					50 005 830	
Reference	360 180 06 01 360 180 20 01	360 180 07 01 360 180 24 01	360 180 15 01 360 180 26 01	360 180 18 01			
1964 → 01.1970→03.1977	OM 352 905, 939, 964, 987, 997 OM 353 909-910						50 005 618
Reference	353 200 56 01						
1964 → 01.1970→	OM 352 905, 938-939, 963-964, 968, 987, 991, 994, 997 OM 353 909-914					50 005 843	
Reference	314 180 10 01 364 180 01 01	352 180 24 01	352 180 63 01	352 180 70 01			

M



				
1964 → Reference	OM 352 314 180 05 01	905, 938-939, 963-964, 968, 987, 991, 994, 997 314 180 10 01 352 180 63 01		50 005 835
06.1973→ 01.1972→ Reference	OM 344 OM 353 366 180 01 01	937, 939, 951 911-914 366 180 04 01		50 005 836
01.1967→ 01.1972→ Reference	OM 352 OM 353 353 200 36 01	905, 938, 963, 968, 991, 994 911-914 353 200 37 01		50 005 617
Series 1314				723
12.1992→ 07.1984→ Reference	OM 306 OM 356 OM 366 314 180 10 01 364 180 01 01	900 016 (ZA) 908-910 906-907, 914, 918, 936-938 352 180 24 01 352 180 63 01 352 180 70 01		50 005 843
06.1973→ 07.1984→12.1993 Reference	OM 344 OM 366 366 180 01 01	937, 939 962, 966 366 180 04 01		50 005 836
12.1992→ 07.1984→ Reference	OM 356 OM 366 366 200 09 01	908-910 906-907, 914, 918, 936-938, 962, 966 366 200 59 01		50 005 629
Series 1316				724
06.1973→ Reference	OM 344 366 180 01 01	937, 939, 951 366 180 04 01		50 005 836
Series 1317				725
1968 →1977 Reference	OM 360 360 200 03 01	937-939, 944, 946, 949-952, 961-962, 964-965, 972 360 200 09 01 360 200 37 01 360 200 45 01		50 005 203
1968 →1977 Reference	OM 360 360 180 06 01 360 180 20 01	935-939, 944, 946, 949-952, 961-962, 964-965, 972 360 180 07 01 360 180 15 01 360 180 18 01 360 180 24 01 360 180 26 01		50 005 830

M



10.1967→ Reference	OM 352 905, 997 353 200 56 01			50 005 618
10.1967→ Reference	OM 352 905, 997 314 180 10 01 352 180 24 01 352 180 63 01 352 180 70 01 364 180 01 01			50 005 843
10.1967→ Reference	OM 352 905, 997 314 180 05 01 314 180 10 01 352 180 63 01			50 005 835
12.1992→ 03.1994→ 04.1984→ Reference	OM 356 944-945, 995 OM 357 902-903, 907, 961-962 OM 366 944, 946, 953, 962, 966, 988, 997 366 180 01 01 366 180 04 01			50 005 836
10.1967→03.1977 Reference	OM 352 905 353 200 36 01 353 200 37 01			50 005 617
12.1992→ 03.1994→ 04.1984→ Reference	OM 356 944-945, 995 OM 357 902 OM 366 944, 946, 953, 962, 966, 988, 997 366 200 09 01 366 200 59 01			50 005 629
03.1996→ Reference	OM 904 907 904 200 04 01 904 200 06 01 904 200 08 01 904 200 20 01 904 200 22 01 904 200 26 01 904 200 49 01 904 201 02 01 904 201 07 01			50 005 627
Series 1318				726
06.1973→ 06.1973→ Reference	OM 341 947 OM 344 937 366 180 01 01 366 180 04 01			50 005 836
Reference	OM 904 938 904 200 04 01 904 200 06 01 904 200 08 01 904 200 20 01 904 200 22 01 904 200 26 01 904 200 49 01 904 201 02 01 904 201 07 01			50 005 627
Series 1320				727
02.1992→ 03.1994→ 07.1984→02.1993 Reference	OM 356 983, 992-993, 995 OM 357 902, 921, 930, 932 OM 366 962, 966, 980, 988, 992, 997 366 180 01 01 366 180 04 01			50 005 836

M



02.1992→ 03.1994→ 07.1984→02.1993 Reference	OM 356 OM 357 OM 366 366 200 09 01	983, 992-993, 995 902, 921 962, 966, 980, 988, 992, 997 366 200 59 01		50 005 629
Series 1324				728
01.1991→02.2001 03.1994→ 01.1991→ Reference	OM 356 OM 357 OM 366 366 180 01 01	983 907, 940, 947-948 999 366 180 04 01		50 005 836
01.1991→02.2001 03.1994→ 01.1991→ Reference	OM 356 OM 357 OM 366 366 200 09 01	983 940 999 366 200 59 01		50 005 629
Series 1413				729
1968 →1977 Reference	OM 360 360 200 03 01	937-938, 951-952, 962 360 200 09 01 360 200 37 01 360 200 45 01		50 005 203
1968 →1977 Reference	OM 360 360 180 06 01 360 180 20 01	937-938, 951-952, 962 360 180 07 01 360 180 15 01 360 180 18 01 360 180 24 01 360 180 26 01		50 005 830
01.1975→12.1984 Reference	OM 352 OM 353 353 200 56 01	997 935, 944, 946, 964		50 005 618
01.1967→12.1984 Reference	OM 352 OM 353 OM 396 314 180 10 01 364 180 01 01	901, 912-913, 930-931, 945-946, 976, 978, 997 935, 944, 946, 964 900 008 (AFS), 900 016 (AFS) 352 180 24 01 352 180 63 01 352 180 70 01		50 005 843
01.1967→12.1984 Reference	OM 352 314 180 05 01	901, 912-913, 930-931, 945-946, 976, 978, 997 314 180 10 01 352 180 63 01		50 005 835
01.1967→12.1984 Reference	OM 352 353 200 36 01	901, 912-913, 930-931, 945-946, 976, 978 353 200 37 01		50 005 617

M



Series 1414

730

04.1984→03.1991	OM 306 900 017 (ZA) OM 366 906, 909 OM 382 912					50 005 843	
Reference	314 180 10 01 364 180 01 01	352 180 24 01	352 180 63 01	352 180 70 01			
04.1984→03.1991	OM 366 906, 909 OM 382 912						50 005 629
Reference	366 200 09 01	366 200 59 01					















Series 1417

731

1968 →1977	OM 360 937-938, 951-952, 962						50 005 203
Reference	360 200 03 01	360 200 09 01	360 200 37 01	360 200 45 01			
1968 →1977	OM 360 937-938, 951-952, 962					50 005 830	
Reference	360 180 06 01 360 180 20 01	360 180 07 01 360 180 24 01	360 180 15 01 360 180 26 01	360 180 18 01			
01.1975→ 01.1975→	OM 352 997 OM 353 920, 951, 953, 971						50 005 618
Reference	353 200 56 01						
01.1975→ 01.1975→07.1985	OM 352 997 OM 353 951, 953, 971					50 005 843	
Reference	314 180 10 01 364 180 01 01	352 180 24 01	352 180 63 01	352 180 70 01			
01.1975→	OM 352 997					50 005 835	
Reference	314 180 05 01	314 180 10 01	352 180 63 01				
01.1975→ 09.1989→ 03.1994→ 04.1984→07.1992	OM 353 920, 951, 953, 971 OM 356 940, 943, 958 OM 357 915, 946 OM 366 951-952, 957					50 005 836	
Reference	366 180 01 01	366 180 04 01					
09.1989→ 04.1984→07.1992	OM 356 940, 943, 958 OM 366 951-952, 957						50 005 629
Reference	366 200 09 01	366 200 59 01					

M



					
Reference	OM 904 920, 962 904 200 04 01 904 200 06 01 904 200 08 01 904 200 20 01 904 200 22 01 904 200 26 01 904 200 49 01 904 201 02 01 904 201 07 01				50 005 627
Series 1418					732
Reference	OM 345 900 (USA), 947 (USA) 355 180 01 01				50 005 829
06.1973→ Reference	OM 341 947 366 180 01 01 366 180 04 01				50 005 836
Reference	OM 904 912, 938 904 200 04 01 904 200 06 01 904 200 08 01 904 200 20 01 904 200 22 01 904 200 26 01 904 200 49 01 904 201 02 01 904 201 07 01				50 005 627
Series 1419					733
05.1983→06.1985 Reference	OM 362 906, 909-910 353 200 56 01				50 005 618
Reference	OM 409 906-907 (AFS) OM 495 900 001 (AFS), 900 002 (AFS), 900 009 (AFS), 900 010 (AFS) 401 180 00 01 401 180 01 01 403 180 06 01 403 180 17 01				50 005 837
04.1972→01.1987 Reference	OM 401 905, 914, 919, 922-924 403 200 76 01 403 200 77 01				50 005 615
05.1983→06.1985 04.1984→ Reference	OM 362 906, 909-910 OM 366 952, 981, 983 366 180 01 01 366 180 04 01				50 005 836
04.1972→01.1987 Reference	OM 401 905, 914, 919, 922-924 OM 409 906-907 (AFS) 403 200 27 01 403 200 32 01 403 200 34 01 403 200 35 01 403 200 49 01 403 200 70 01				50 005 207
04.1984→ Reference	OM 366 952, 981, 983 366 200 09 01 366 200 59 01				50 005 629

M

















04.1972→01.1987 Reference	OM 401 OM 409 403 200 44 01	905, 914, 919, 922-924 906-907 (AFS) 403 200 51 01 403 200 71 01		50 005 210
Series 1420				734
06.1983→06.1985 Reference	OM 362 353 200 56 01	909-910		50 005 618
07.1985→ 06.1983→06.1985 07.1985→03.1991 Reference	OM 356 OM 362 OM 366 366 180 01 01	984, 987 909-910 983 366 180 04 01		50 005 836
07.1985→ 07.1985→03.1991 Reference	OM 356 OM 366 366 200 09 01	984, 987 983 366 200 59 01		50 005 629
Series 1422				735
02.1993→08.1994 1979 → Reference	OM 401 OM 422 401 180 00 01	973, 975, 977, 979 908-909, 913, 923 401 180 01 01 403 180 06 01 403 180 17 01		50 005 837
02.1993→08.1994 05.1982→10.1990 1979 → Reference	OM 401 OM 421 OM 422 403 200 76 01	973, 975, 977, 979 905-906 908-909, 913, 923 403 200 77 01		50 005 615
08.1982→08.1994 Reference	OM 441 441 200 01 01	905, 913, 920, 923 441 200 02 01		50 005 616
02.1993→08.1994 05.1982→10.1990 1979 → 08.1982→08.1994 Reference	OM 401 OM 421 OM 422 OM 441 403 200 44 01	973, 975, 977, 979 905-906 908-909, 913, 923 905, 913, 920, 923 403 200 51 01 403 200 71 01		50 005 210
Series 1424				736
02.1993→ 04.1972→01.1987 01.1995→ Reference	OM 401 OM 402 OM 445 401 180 00 01	973, 975, 994 910-911, 919, 921 924, 926, 938 401 180 01 01 403 180 06 01 403 180 17 01		50 005 837
02.1993→ 04.1972→01.1987 01.1995→ Reference	OM 401 OM 402 OM 445 403 200 76 01	973, 975, 994 910-911, 919, 921 924, 926, 938 403 200 77 01		50 005 615

M



MERCEDES-BENZ





				
03.1994→ Reference	OM 356 988, 999 OM 357 946 366 180 01 01 366 180 04 01			50 005 836
04.1972→01.1987 Reference	OM 402 910-911, 919, 921 403 200 27 01 403 200 32 01 403 200 34 01 403 200 35 01 403 200 49 01 403 200 70 01			50 005 207
02.1993→ 04.1972→01.1987 01.1995→ Reference	OM 401 973, 975, 994 OM 402 910-911, 919, 921 OM 445 924, 926, 938 403 200 44 01 403 200 51 01 403 200 71 01			50 005 210
Series 1425				737
1979 → Reference	OM 422 908-909, 913, 923 401 180 00 01 401 180 01 01 403 180 06 01 403 180 17 01			50 005 837
1979 → Reference	OM 422 908-909, 913, 923 403 200 76 01 403 200 77 01			50 005 615
1979 → Reference	OM 422 908-909, 913, 923 403 200 44 01 403 200 51 01 403 200 71 01			50 005 210
Series 1426				738
06.1989→09.1993 Reference	OM 442 914, 932 401 180 00 01 401 180 01 01 403 180 06 01 403 180 17 01			50 005 837
06.1989→09.1993 Reference	OM 442 914, 932 441 200 01 01 441 200 02 01			50 005 616
12.1992→ Reference	OM 356 999 366 180 01 01 366 180 04 01			50 005 836
06.1989→09.1993 Reference	OM 442 914 403 200 44 01 403 200 51 01 403 200 71 01			50 005 210

M







Series 1427

739

03.1991 → 01.1994 → Reference	OM 401 OM 445 401 180 00 01	973, 977-978, 985, 991 926, 936 401 180 01 01	403 180 06 01	403 180 17 01		50 005 837	
03.1991 → 01.1994 → Reference	OM 401 OM 445 403 200 76 01	973, 977-978, 985, 991 926, 936 403 200 77 01					50 005 615
12.1992 → Reference	OM 356 366 180 01 01	999 366 180 04 01				50 005 836	
03.1991 → 01.1994 → Reference	OM 401 OM 445 403 200 44 01	973, 977-978, 985, 991 926, 936 403 200 51 01	403 200 71 01				50 005 210



Series 1428

740

1979 → 1988 → Reference	OM 422 OM 442 401 180 00 01	907, 909, 913 907 401 180 01 01	403 180 06 01	403 180 17 01		50 005 837	
1979 → Reference	OM 422 403 200 76 01	907, 909, 913 403 200 77 01					50 005 615
1988 → Reference	OM 442 441 200 01 01	907 441 200 02 01					50 005 616
1979 → 1988 → Reference	OM 422 OM 442 403 200 44 01	907, 909, 913 907 403 200 51 01	403 200 71 01				50 005 210

Series 1429















741

1991 → 1979 → 1988 → Reference	OM 401 OM 422 OM 442 401 180 00 01	973 907, 909, 913 907, 926, 933 401 180 01 01	403 180 06 01	403 180 17 01		50 005 837	
1991 → 1979 → Reference	OM 401 OM 422 403 200 76 01	973 907, 909, 913 403 200 77 01					50 005 615

M



MERCEDES-BENZ

					
1988 → Reference	OM 442 441 200 01 01	907, 926, 933 441 200 02 01			50 005 616
1991 → 1979 → 1988 → Reference	OM 401 OM 422 OM 442 403 200 44 01	973 907, 909, 913 907 403 200 51 01 403 200 71 01			50 005 210
Series 1431					742
02.1993→08.1994 Reference	OM 401 401 180 00 01	979 401 180 01 01 403 180 06 01 403 180 17 01			50 005 837
02.1993→08.1994 Reference	OM 401 403 200 76 01	979 403 200 77 01			50 005 615
02.1993→ Reference	OM 356 366 180 01 01	999 366 180 04 01			50 005 836
02.1993→08.1994 Reference	OM 401 403 200 44 01	979 403 200 51 01 403 200 71 01			50 005 210
Series 1442					743
1979 → 1988 → Reference	OM 422 OM 442 401 180 00 01	913 907 401 180 01 01 403 180 06 01 403 180 17 01			50 005 837
1979 → Reference	OM 422 403 200 76 01	913 403 200 77 01			50 005 615
1988 → Reference	OM 442 441 200 01 01	907 441 200 02 01			50 005 616
1979 → 1988 → Reference	OM 422 OM 442 403 200 44 01	913 907 403 200 51 01 403 200 71 01			50 005 210

M



Series 1513

744

1964 →1981 01.1972→03.1977 Reference	OM 352 935 OM 353 910 353 200 56 01				50 005 618
1964 →02.2001 01.1972→02.2001 Reference	OM 352 912-913, 930, 935-937 OM 353 910, 912 314 180 10 01 352 180 24 01 352 180 63 01 352 180 70 01 364 180 01 01				50 005 843
1964 →02.2001 Reference	OM 352 912-913, 930, 935-937 314 180 05 01 314 180 10 01 352 180 63 01				50 005 835
01.1972→ Reference	OM 353 912, 939 366 180 01 01 366 180 04 01				50 005 836
01.1967→02.2001 01.1972→ Reference	OM 352 912-913, 930, 936-937 OM 353 912, 939 353 200 36 01 353 200 37 01				50 005 617

M

Series 1514

745

12.1992→ 01.1989→12.1992 Reference	OM 356 908 OM 366 936 314 180 10 01 352 180 24 01 352 180 63 01 352 180 70 01 364 180 01 01				50 005 843
12.1992→ 01.1989→12.1992 Reference	OM 356 908 OM 366 936 366 200 09 01 366 200 59 01				50 005 629















Series 1517

746

09.1969→12.1976 Reference	OM 360 940-941, 948 360 200 03 01 360 200 09 01 360 200 37 01 360 200 45 01				50 005 203
09.1969→12.1976 Reference	OM 360 935-936, 940-942, 948, 960 360 180 06 01 360 180 07 01 360 180 15 01 360 180 18 01 360 180 20 01 360 180 24 01 360 180 26 01				50 005 830



MERCEDES-BENZ



					
10.1967→03.1977 Reference	OM 352 905 353 200 56 01				50 005 618
10.1967→03.1977 01.1972→ Reference	OM 352 905 OM 353 912 314 180 10 01 352 180 24 01 352 180 63 01 352 180 70 01 364 180 01 01				50 005 843
10.1967→03.1977 Reference	OM 352 905 314 180 05 01 314 180 10 01 352 180 63 01				50 005 835
01.1995→ Reference	OM 445 924 401 180 00 01 401 180 01 01 403 180 06 01 403 180 17 01				50 005 837
01.1995→ Reference	OM 445 924 403 200 76 01 403 200 77 01				50 005 615
06.1973→ 01.1972→ 12.1992→ 03.1994→ 07.1984→02.1993 Reference	OM 341 937 OM 353 912, 939 OM 356 946, 953 OM 357 903, 962-963 OM 366 945, 953, 962, 979 366 180 01 01 366 180 04 01				50 005 836
10.1967→03.1977 01.1972→ Reference	OM 352 905 OM 353 912, 939 353 200 36 01 353 200 37 01				50 005 617
12.1992→ 07.1984→02.1993 Reference	OM 356 946, 953 OM 366 945, 953, 962, 979 366 200 09 01 366 200 59 01				50 005 629
03.1996→ Reference	OM 904 907 904 200 04 01 904 200 06 01 904 200 08 01 904 200 20 01 904 200 22 01 904 200 26 01 904 200 49 01 904 201 02 01 904 201 07 01				50 005 627
01.1995→ Reference	OM 445 924 403 200 44 01 403 200 51 01 403 200 71 01				50 005 210

M



**Series 1518****747**

06.1973→ Reference	OM 341 937 366 180 01 01 366 180 04 01		50 005 836
-----------------------	---	---	------------

Series 1519**748**

06.1971→12.1976 Reference	OM 360 940-941, 948 360 200 03 01 360 200 09 01 360 200 37 01 360 200 45 01		50 005 203
06.1971→12.1976 Reference	OM 360 940-941, 948 360 180 06 01 360 180 07 01 360 180 15 01 360 180 18 01 360 180 20 01 360 180 24 01 360 180 26 01		50 005 830
05.1984→04.1987 Reference	OM 345 915 (BRA) 355 180 01 01		50 005 829

M**Series 1520****749**

Reference	OM 345 915 (BRA) 355 180 01 01		50 005 829
12.1992→ 03.1994→ 01.1989→12.1992 Reference	OM 356 990, 999 OM 357 922, 930 OM 366 995 366 180 01 01 366 180 04 01		50 005 836
12.1992→ 01.1989→12.1992 Reference	OM 356 990 OM 366 995 366 200 09 01 366 200 59 01		50 005 629













Series 1521**750**

Reference	OM 347 915 355 180 01 01		50 005 829
-----------	-----------------------------	---	------------

Series 1524**751**

12.1992→08.1994 03.1994→ 02.1991→02.2001 Reference	OM 356 999 OM 357 941, 947 OM 366 999 366 180 01 01 366 180 04 01		50 005 836
---	--	---	------------



					
02.1991→02.2001 Reference	OM 366 999 366 200 09 01 366 200 59 01				50 005 629
Series 1525					752
01.1985→12.2001 Reference	OM 429 951 (USA), 953 (USA), 955 (USA) 401 180 00 01 401 180 01 01 403 180 06 01 403 180 17 01				50 005 837
Series 1613					753
01.1975→07.1985 Reference	OM 353 944, 946, 951, 964 353 200 56 01				50 005 618
01.1975→07.1985 Reference	OM 353 944, 946, 951, 964 314 180 10 01 352 180 24 01 352 180 63 01 352 180 70 01 364 180 01 01				50 005 843
01.1975→07.1985 Reference	OM 353 951 366 180 01 01 366 180 04 01				50 005 836
Series 1614					754
04.1984→03.1991 Reference	OM 366 906, 909 314 180 10 01 352 180 24 01 352 180 63 01 352 180 70 01 364 180 01 01				50 005 843
04.1984→03.1991 Reference	OM 366 906, 909 366 200 09 01 366 200 59 01				50 005 629
Series 1617					755
1968 →1977 Reference	OM 360 937-938, 951-952, 962, 983 360 200 03 01 360 200 09 01 360 200 37 01 360 200 45 01				50 005 203
1968 →1977 Reference	OM 360 937-938, 951-952, 962, 983 360 180 06 01 360 180 07 01 360 180 15 01 360 180 18 01 360 180 20 01 360 180 24 01 360 180 26 01				50 005 830

M



01.1975→ 01.1975→07.1985 06.1983→06.1985 Reference	OM 352 997 OM 353 951, 953, 964, 971, 978 OM 362 906 353 200 56 01			50 005 618
01.1975→ 01.1975→07.1985 Reference	OM 352 997 OM 353 951, 953, 964, 971 314 180 10 01 352 180 24 01 352 180 63 01 352 180 70 01 364 180 01 01			50 005 843
01.1975→ Reference	OM 352 997 314 180 05 01 314 180 10 01 352 180 63 01			50 005 835
01.1975→07.1985 06.1983→06.1985 04.1984→ Reference	OM 353 951, 953, 971, 978 OM 362 906 OM 366 951-952, 981, 983 366 180 01 01 366 180 04 01			50 005 836
04.1984→ Reference	OM 366 951-952, 981, 983 366 200 09 01 366 200 59 01			50 005 629
Series 1618				756
Reference	OM 904 912, 938 904 200 04 01 904 200 06 01 904 200 08 01 904 200 20 01 904 200 22 01 904 200 26 01 904 200 49 01 904 201 02 01 904 201 07 01			50 005 627
Series 1619				757
06.1983→06.1985 Reference	OM 362 906 353 200 56 01			50 005 618
Reference	OM 409 907 (AFS) OM 495 900 002 (AFS) 401 180 00 01 401 180 01 01 403 180 06 01 403 180 17 01			50 005 837
04.1972→05.1987 Reference	OM 401 905, 914, 923-924, 928 403 200 76 01 403 200 77 01			50 005 615
06.1983→06.1985 07.1985→03.1991 Reference	OM 362 906 OM 366 983 366 180 01 01 366 180 04 01			50 005 836

M



MERCEDES-BENZ

04.1972→05.1987 Reference	OM 401 OM 409	905, 914, 923-924, 928 907 (AFS)	403 200 27 01 403 200 49 01	403 200 32 01 403 200 70 01	403 200 34 01	403 200 35 01			50 005 207
07.1985→03.1991 Reference	OM 366	983	366 200 09 01	366 200 59 01					50 005 629
04.1972→05.1987 Reference	OM 401 OM 409	905, 914, 923-924, 928 907 (AFS)	403 200 44 01	403 200 51 01	403 200 71 01				50 005 210
Series 1620									758
06.1983→09.1985 Reference	OM 362	909-910	353 200 56 01						50 005 618
09.1969→12.1974 Reference	OM 355	912	355 180 01 01					50 005 829	
06.1983→09.1985 07.1985→ Reference	OM 362 OM 366	909-910 981, 983	366 180 01 01	366 180 04 01				50 005 836	
07.1985→ Reference	OM 366	981, 983	366 200 09 01	366 200 59 01					50 005 629
Series 1621									759
06.1978→ Reference	OM 360	982	360 200 03 01	360 200 09 01	360 200 37 01	360 200 45 01			50 005 203
06.1978→ Reference	OM 360	982	360 180 06 01 360 180 20 01	360 180 07 01 360 180 24 01	360 180 15 01 360 180 26 01	360 180 18 01		50 005 830	

M



09.1969→12.1972 Reference	OM 355 966 355 180 01 01			
09.1969→12.1972 Reference	OM 355 966 355 200 01 01 355 200 05 01 355 200 06 01 355 200 08 01 355 200 09 01 355 200 11 01 355 200 15 01 wartungsfrei maintenance-free sans entretien sin necesidad de mantenimiento не нуждающийся в обслуживании			
Series 1622				760
1979 → 01.1985→02.1991 Reference	OM 422 909 OM 441 961 401 180 00 01 401 180 01 01 403 180 06 01 403 180 17 01			
1982 → 1979 → 01.1985→02.1991 Reference	OM 421 905, 910 OM 422 909 OM 441 961 403 200 76 01 403 200 77 01			
08.1982→ Reference	OM 441 905-907, 914, 917, 919 441 200 01 01 441 200 02 01			
05.2001→ Reference	OM 924 910 904 200 04 01 904 200 06 01 904 200 08 01 904 200 20 01 904 200 22 01 904 200 26 01 904 200 49 01 904 201 02 01 904 201 07 01			
1982 → 1979 → 08.1982→ Reference	OM 421 905, 910 OM 422 909 OM 441 905-907, 914, 917, 919, 961 403 200 44 01 403 200 51 01 403 200 71 01			
Series 1624				761
09.1967→05.1977 Reference	OM 355 912, 960, 962-963, 983 355 180 01 01			
07.1975→01.1987 01.1995→ Reference	OM 402 910-911, 923 OM 407 931 (AFS) OM 445 924 OM 496 900 002 (AFS), 900 023 (AFS), 900 034 (AFS), 900 035 (AFS) 401 180 00 01 401 180 01 01 403 180 06 01 403 180 17 01			
07.1975→01.1987 01.1995→ Reference	OM 402 910-911, 923 OM 445 924 403 200 76 01 403 200 77 01			

M



07.1975→01.1987 Reference	OM 402 OM 407 403 200 27 01 403 200 49 01	910-911, 923 931 (AFS) 403 200 32 01 403 200 70 01	403 200 34 01	403 200 35 01		50 005 207
09.1967→05.1977 Reference	OM 355 355 200 01 01 355 200 09 01 wartungsfrei maintenance-free sans entretien sin necesidad de mantenimiento не нуждающийся в обслуживании	960, 962-963, 983 355 200 05 01 355 200 11 01	355 200 06 01 355 200 15 01	355 200 08 01		50 005 211
07.1975→01.1987 01.1995→ Reference	OM 402 OM 407 OM 445 403 200 44 01	910-911, 923 931 (AFS) 924 403 200 51 01	403 200 71 01			50 005 210
Series 1625						762
1979 → 03.1987→02.1990 Reference	OM 422 OM 442 OM 475 401 180 00 01	909, 911-913, 915 905, 908-909 950-951 (BRA), 976 (AFS/LAM), 986 (AFS/LAM), 994 401 180 01 01	403 180 06 01	403 180 17 01		50 005 837
1979 → Reference	OM 422 403 200 76 01	909, 911-913, 915 403 200 77 01				50 005 615
03.1987→02.1990 Reference	OM 442 441 200 01 01	905, 908-909 441 200 02 01				50 005 616
1979 → 03.1987→02.1990 Reference	OM 422 OM 442 403 200 44 01	909, 911-913, 915 905, 908-909 403 200 51 01	403 200 71 01			50 005 210
Series 1626						763
04.1972→1985 Reference	OM 402 401 180 00 01	905-906, 912, 916, 924 401 180 01 01	403 180 06 01	403 180 17 01		50 005 837
04.1972→1985 Reference	OM 402 403 200 76 01	905-906, 912, 916, 924 403 200 77 01				50 005 615
04.1972→1985 Reference	OM 402 403 200 27 01 403 200 49 01	905-906, 912, 916, 924 403 200 32 01 403 200 70 01	403 200 34 01	403 200 35 01		50 005 207

M



04.1972→1985 Reference	OM 402 403 200 44 01	905-906, 912, 916, 924 403 200 51 01 403 200 71 01		50 005 210
Series 1627				764
08.1992→ 08.1992→ 07.1995→ 08.1988→09.1993 01.1994→ Reference	OM 401 OM 440 OM 441 OM 442 OM 445 401 180 00 01	984 907 986 926 934-935 401 180 01 01 403 180 06 01 403 180 17 01		50 005 837
08.1992→ 07.1995→ 01.1994→ Reference	OM 401 OM 441 OM 445 403 200 76 01	984 986 934-935 403 200 77 01		50 005 615
08.1992→ 08.1988→09.1993 Reference	OM 440 OM 442 441 200 01 01	907 926 441 200 02 01		50 005 616
08.1992→ 07.1995→ 01.1994→ Reference	OM 401 OM 441 OM 445 403 200 44 01	984 986 934-935 403 200 51 01 403 200 71 01		50 005 210
Series 1628				765
1981 → Reference	OM 423 403 180 33 01	905, 908 423 180 01 01 423 180 05 01		50 005 834
01.1980→05.1989 07.1987→02.1990 1988 → Reference	OM 422 OM 441 OM 442 OM 475 401 180 00 01	905-906, 911, 913, 916, 918 951 908-909 974 (AFS/LAM), 976 (AFS/LAM), 986 (AFS/LAM), 994 401 180 01 01 403 180 06 01 403 180 17 01		50 005 837
1982 → 01.1980→05.1989 1981 → 07.1987→02.1990 Reference	OM 421 OM 422 OM 423 OM 441 403 200 76 01	910 905-906, 911, 913, 916, 918 905, 908 951 403 200 77 01		50 005 615
1988 → Reference	OM 442 441 200 01 01	908-909 441 200 02 01		50 005 616
1982 → 01.1980→05.1989 1981 → 07.1987→02.1990 1988 → Reference	OM 421 OM 422 OM 423 OM 441 OM 442 403 200 44 01	910 905-906, 911, 913, 916, 918 905, 908 951 908-909 403 200 51 01 403 200 71 01		50 005 210

M



Series 1629

766

1988 →
Reference

OM 442 907
401 180 00 01 401 180 01 01 403 180 06 01 403 180 17 01

**50 005 837**

1988 →
Reference

OM 442 907
441 200 01 01 441 200 02 01

**50 005 616**

1988 →
Reference

OM 442 907
403 200 44 01 403 200 51 01 403 200 71 01

**50 005 210**

Series 1630

767

Reference

OM 475 982 (AFS/LAM), 985 (AFS/LAM), 989 (AFS/LAM)
401 180 00 01 401 180 01 01 403 180 06 01 403 180 17 01

**50 005 837**

Series 1632

768

09.1970→1985
12.1983→03.1991
Reference

OM 403 915-916, 931-932, 934-935
OM 423 905
403 180 33 01 423 180 01 01 423 180 05 01
OM 403.915, OM 403.916, OM 403.931, OM 403.932, OM 403.934, OM 403.935:
121800→

**50 005 834**

09.1970→1985
01.1980→05.1989
10.1998→
Reference

OM 403 915-916, 931-932, 934-935
OM 422 905
OM 475 979 (AFS/LAM)
401 180 00 01 401 180 01 01 403 180 06 01 403 180 17 01
OM 403.915, OM 403.916, OM 403.931, OM 403.932, OM 403.934, OM 403.935:
→121799

**50 005 837**

09.1970→1985
01.1980→05.1989
12.1983→03.1991
Reference

OM 403 915-916, 931-932, 934-935
OM 422 905
OM 423 905
403 200 76 01 403 200 77 01

**50 005 615**

09.1970→1985
Reference

OM 403 915-916, 931-932, 934-935
403 200 27 01 403 200 32 01 403 200 34 01 403 200 35 01
403 200 49 01 403 200 70 01

**50 005 207**

09.1970→1985
01.1980→05.1989
12.1983→03.1991
Reference

OM 403 915-916, 931-932, 934-935
OM 422 905
OM 423 905
403 200 44 01 403 200 51 01 403 200 71 01

**50 005 210**

Series 1633

769















10.1980→05.1987
09.1984→03.1991
Reference

OM 422 952, 954, 956-958
OM 423 908
403 180 33 01 423 180 01 01 423 180 05 01

**50 005 834****M**



MERCEDES-BENZ

						
01.1989→02.1991 Reference	OM 441 951 OM 475 982 (AFS/LAM) OM 485 980 (BRA) 401 180 00 01 401 180 01 01 403 180 06 01 403 180 17 01				50 005 837	
10.1980→05.1987 09.1984→03.1991 01.1989→02.1991 Reference	OM 422 952, 954, 956-958 OM 423 908 OM 441 951 403 200 76 01 403 200 77 01					50 005 615
10.1980→05.1987 09.1984→03.1991 01.1989→02.1991 Reference	OM 422 952, 954, 956-958 OM 423 908 OM 441 951 403 200 44 01 403 200 51 01 403 200 71 01					50 005 210
Series 1634						770
01.1992→ Reference	OM 440 945 403 180 33 01 423 180 01 01 423 180 05 01				50 005 834	
01.1995→ 11.1995→ Reference	OM 445 934 OM 476 971 (BRA) 401 180 00 01 401 180 01 01 403 180 06 01 403 180 17 01				50 005 837	
01.1992→ 01.1995→ Reference	OM 440 945 OM 445 934 403 200 76 01 403 200 77 01					50 005 615
01.1992→ 01.1995→ Reference	OM 440 945 OM 445 934 403 200 44 01 403 200 51 01 403 200 71 01					50 005 210
Series 1635						771
02.1986→08.1994 1988 → Reference	OM 442 950, 952, 963 OM 443 905 403 180 33 01 423 180 01 01 423 180 05 01				50 005 834	
Reference	OM 476 978 (BRA), 988 (BRA), 991 (BRA) 401 180 00 01 401 180 01 01 403 180 06 01 403 180 17 01				50 005 837	
02.1986→08.1994 1988 → Reference	OM 442 950, 952, 963 OM 443 905 403 200 76 01 403 200 77 01					50 005 615
02.1986→08.1994 1988 → Reference	OM 442 950, 952, 963 OM 443 905 403 200 44 01 403 200 51 01 403 200 71 01					50 005 210

M



Series 1636

772

12.1983→03.1991 1988 → Reference	OM 423 905, 908 OM 443 905 403 180 33 01 423 180 01 01 423 180 05 01		50 005 834
Reference	OM 476 978 (BRA), 988 (BRA) 401 180 00 01 401 180 01 01 403 180 06 01 403 180 17 01		50 005 837
12.1983→03.1991 1988 → Reference	OM 423 905, 908 OM 443 905 403 200 76 01 403 200 77 01		50 005 615
12.1983→03.1991 1988 → Reference	OM 423 905, 908 OM 443 905 403 200 44 01 403 200 51 01 403 200 71 01		50 005 210

Series 1638

773

11.1980→12.1986 Reference	OM 422 953, 955, 959 403 180 33 01 423 180 01 01 423 180 05 01		50 005 834
11.1980→12.1986 Reference	OM 422 953, 955, 959 403 200 76 01 403 200 77 01		50 005 615
11.1980→12.1986 Reference	OM 422 953, 955, 959 403 200 44 01 403 200 51 01 403 200 71 01		50 005 210

Series 1644

774

01.1984→1992 Reference	OM 423 950 422 200 05 01 422 200 10 01		50 005 205
06.1986→07.1992 Reference	OM 442 951, 953, 980, 982 403 180 33 01 423 180 01 01 423 180 05 01		50 005 834
06.1986→07.1992 Reference	OM 442 951, 953, 980, 982 403 200 76 01 403 200 77 01		50 005 615

M



06.1986→07.1992 Reference	OM 442 403 200 44 01	951, 953, 980, 982 403 200 51 01 403 200 71 01		50 005 210
Series 1650				775
01.1984→1989 Reference	OM 423 422 200 05 01	950 422 200 10 01		50 005 205
Series 1713				776
1964 →1981 Reference	OM 352 314 180 10 01 364 180 01 01	931 352 180 24 01 352 180 63 01 352 180 70 01		50 005 843
1964 →1981 Reference	OM 352 314 180 05 01	931 314 180 10 01 352 180 63 01		50 005 835
1964 →1981 Reference	OM 352 353 200 36 01	931 353 200 37 01		50 005 617
Series 1717				777
09.1989→08.1993 09.1989→08.1993 Reference	OM 356 OM 366 366 180 01 01	940 952 366 180 04 01		50 005 836
09.1989→08.1993 09.1989→08.1993 Reference	OM 356 OM 366 366 200 09 01	940 952 366 200 59 01		50 005 629
Series 1718				778
Reference	OM 904 904 200 04 01 904 200 22 01 904 201 07 01	938 904 200 06 01 904 200 26 01		50 005 627
Series 1719				779
09.1973→08.1982 Reference	OM 401 403 200 76 01	909, 916, 924 403 200 77 01		50 005 615















M



09.1973→08.1982 Reference	OM 401 403 200 27 01 403 200 49 01	909, 916, 924 403 200 32 01 403 200 70 01	403 200 34 01	403 200 35 01			50 005 207
09.1973→08.1982 Reference	OM 401 403 200 44 01	909, 916, 924 403 200 51 01	403 200 71 01				50 005 210
Series 1720							780
02.1990→ 01.1994→ 07.1985→ Reference	OM 356 OM 357 OM 366 366 180 01 01	978, 984-985 925 983, 995-996 366 180 04 01				50 005 836	
02.1990→ 07.1985→ Reference	OM 356 OM 366 366 200 09 01	984-985 983, 995-996 366 200 59 01					50 005 629
Series 1722							781
Reference	OM 441 401 180 00 01	901 401 180 01 01	403 180 06 01	403 180 17 01		50 005 837	
Reference	OM 441 403 200 76 01	901 403 200 77 01					50 005 615
12.1988→08.1994 Reference	OM 441 441 200 01 01	905, 913-914, 916, 920, 923, 926, 932-933 441 200 02 01					50 005 616
12.1988→08.1994 Reference	OM 366 366 180 01 01	983 366 180 04 01				50 005 836	
12.1988→08.1994 Reference	OM 366 366 200 09 01	983 366 200 59 01					50 005 629
05.2001→ Reference	OM 924 904 200 04 01 904 200 22 01 904 201 07 01	912, 914 904 200 06 01 904 200 26 01	904 200 08 01 904 200 49 01	904 200 20 01 904 201 02 01			50 005 627

M



				
Reference	OM 441 403 200 44 01	901, 905, 913-914, 916, 920, 923, 926, 932-933 403 200 51 01 403 200 71 01		50 005 210
Series 1724				782
Reference	OM 466 401 180 00 01	900 005 (AFS) 401 180 01 01 403 180 06 01 403 180 17 01		50 005 837
12.1992→08.1994 03.1994→ 02.1991→02.2001 Reference	OM 356 OM 357 OM 366 366 180 01 01	999 941 999 366 180 04 01		50 005 836
02.1991→02.2001 Reference	OM 366 366 200 09 01	999 366 200 59 01		50 005 629
Series 1725				783
Reference	OM 475 401 180 00 01	951 (BRA) 401 180 01 01 403 180 06 01 403 180 17 01		50 005 837
2000 → Reference	OM 906 904 200 04 01 904 200 22 01 904 201 07 01	975 904 200 06 01 904 200 08 01 904 200 20 01 904 200 26 01 904 200 49 01 904 201 02 01		50 005 627
Series 1726				784
02.1993→08.1994 07.1988→08.1994 12.1988→08.1994 12.1988→08.1994 Reference	OM 401 OM 440 OM 441 OM 442 401 180 00 01	973 909 960 906-907, 914, 922-923, 932, 935 401 180 01 01 403 180 06 01 403 180 17 01		50 005 837
02.1993→08.1994 12.1988→08.1994 Reference	OM 401 OM 441 403 200 76 01	973 960 403 200 77 01		50 005 615
07.1988→08.1994 12.1988→08.1994 Reference	OM 440 OM 442 441 200 01 01	909 906-907, 914, 922-923, 932, 935 441 200 02 01		50 005 616
02.1993→08.1994 12.1988→08.1994 12.1988→08.1994 Reference	OM 401 OM 441 OM 442 403 200 44 01	973 960 906-907, 914, 922-923 403 200 51 01 403 200 71 01		50 005 210

M



Series 1727

785

03.1991→ Reference	OM 401 973, 978 401 180 00 01 401 180 01 01 403 180 06 01 403 180 17 01		50 005 837	
03.1991→ Reference	OM 401 973, 978 403 200 76 01 403 200 77 01			50 005 615
03.1991→ Reference	OM 401 973, 978 403 200 44 01 403 200 51 01 403 200 71 01			50 005 210

Series 1728

786

07.1988→ Reference	OM 442 923, 925 401 180 00 01 401 180 01 01 403 180 06 01 403 180 17 01		50 005 837	
07.1988→ Reference	OM 442 923, 925 441 200 01 01 441 200 02 01			50 005 616
Reference	OM 906 933, 953, 974, 977 904 200 04 01 904 200 06 01 904 200 08 01 904 200 20 01 904 200 22 01 904 200 26 01 904 200 49 01 904 201 02 01 904 201 07 01			50 005 627
07.1988→08.1994 Reference	OM 442 923 403 200 44 01 403 200 51 01 403 200 71 01			50 005 210

M

Series 1729

787

1979 → 03.1987→08.1994 Reference	OM 422 907, 916 OM 442 906-908, 922-923, 925-926 401 180 00 01 401 180 01 01 403 180 06 01 403 180 17 01		50 005 837	
1979 → Reference	OM 422 907, 916 403 200 76 01 403 200 77 01			50 005 615
03.1987→08.1994 Reference	OM 442 906-908, 922-923, 925-926 441 200 01 01 441 200 02 01			50 005 616



1979 → 03.1987 → 08.1994 Reference	OM 422 907, 916 OM 442 906-908, 922-923 403 200 44 01 403 200 51 01 403 200 71 01			50 005 210
Series 1732				788
01.1989 → 07.1992 Reference	OM 441 960 401 180 00 01 401 180 01 01 403 180 06 01 403 180 17 01			50 005 837
01.1989 → 07.1992 Reference	OM 441 960 403 200 76 01 403 200 77 01			50 005 615
01.1989 → 07.1992 Reference	OM 441 960 403 200 44 01 403 200 51 01 403 200 71 01			50 005 210
Series 1733				789
01.1989 → 01.1994 → Reference	OM 441 951, 960-962, 981, 983, 991 OM 445 939 401 180 00 01 401 180 01 01 403 180 06 01 403 180 17 01			50 005 837
01.1989 → 01.1994 → Reference	OM 441 951, 960-962, 981, 983, 991 OM 445 939 403 200 76 01 403 200 77 01			50 005 615
01.1989 → 07.1992 Reference	OM 441 923 441 200 01 01 441 200 02 01			50 005 616
01.1989 → 01.1994 → Reference	OM 441 923, 951, 960-962, 981, 983, 991 OM 445 939 403 200 44 01 403 200 51 01 403 200 71 01			50 005 210
Series 1735				790
07.1991 → 08.1994 07.1988 → 08.1994 12.1991 → Reference	OM 440 940 OM 442 942, 944, 963-964, 966, 971, 976 OM 462 900 410 (AFS) 403 180 33 01 423 180 01 01 423 180 05 01			50 005 834
08.1989 → 08.1994 Reference	OM 442 906 401 180 00 01 401 180 01 01 403 180 06 01 403 180 17 01			50 005 837













M



07.1991→08.1994 07.1988→08.1994 Reference	OM 440 940 OM 442 942, 944, 963-964, 966, 971, 976 403 200 76 01 403 200 77 01			50 005 615
08.1989→08.1994 Reference	OM 442 906 441 200 01 01 441 200 02 01			50 005 616
07.1991→08.1994 07.1988→08.1994 Reference	OM 440 940 OM 442 906, 942, 944, 963-964, 966, 971, 976 403 200 44 01 403 200 51 01 403 200 71 01			50 005 210
Series 1748				791
07.1988→07.1992 Reference	OM 442 985, 989, 992 403 180 33 01 423 180 01 01 423 180 05 01		50 005 834	
07.1988→07.1992 Reference	OM 442 985, 989, 992 403 200 76 01 403 200 77 01			50 005 615
07.1988→07.1992 Reference	OM 442 985, 989, 992 403 200 44 01 403 200 51 01 403 200 71 01			50 005 210
Series 1750				792
07.1995→ 1985→02.1991 Reference	OM 440 971 OM 442 989 403 180 33 01 423 180 01 01 423 180 05 01		50 005 834	
07.1995→ 1985→02.1991 Reference	OM 440 971 OM 442 989 403 200 76 01 403 200 77 01			50 005 615
07.1995→ 1985→02.1991 Reference	OM 440 971 OM 442 989 403 200 44 01 403 200 51 01 403 200 71 01			50 005 210
Series 1813				793
01.1968→ 01.1972→07.1983 Reference	OM 352 963, 994 OM 353 911 314 180 10 01 352 180 24 01 352 180 63 01 352 180 70 01 364 180 01 01		50 005 843	













M



				
01.1968→ Reference	OM 352 963, 994 314 180 05 01 314 180 10 01 352 180 63 01		50 005 835	
01.1972→07.1983 Reference	OM 353 911 366 180 01 01 366 180 04 01		50 005 836	
01.1968→ 01.1972→07.1983 Reference	OM 352 963, 994 OM 353 911 353 200 36 01 353 200 37 01			50 005 617
Series 1814				794
04.1984→03.1991 Reference	OM 366 906 OM 382 912 314 180 10 01 352 180 24 01 352 180 63 01 352 180 70 01 364 180 01 01		50 005 843	
04.1984→03.1991 Reference	OM 366 906 OM 382 912 366 200 09 01 366 200 59 01			50 005 629
Series 1816				795
09.1989→08.1994 Reference	OM 366 952 366 180 01 01 366 180 04 01		50 005 836	
09.1989→08.1994 Reference	OM 366 952 366 200 09 01 366 200 59 01			50 005 629
Series 1817				796
1968 →12.1976 Reference	OM 360 943, 963 360 180 06 01 360 180 07 01 360 180 15 01 360 180 18 01 360 180 20 01 360 180 24 01 360 180 26 01		50 005 830	
05.1988→ Reference	OM 382 913 366 180 01 01 366 180 04 01		50 005 836	

M





					
05.1988→ Reference	OM 382 913 366 200 09 01 366 200 59 01				50 005 629
Series 1819					797
01.1972→12.1976 Reference	OM 360 963 360 180 06 01 360 180 07 01 360 180 15 01 360 180 18 01 360 180 20 01 360 180 24 01 360 180 26 01				50 005 830
Reference	OM 345 915 (BRA) 355 180 01 01				50 005 829
11.1974→05.1987 Reference	OM 401 905 403 200 76 01 403 200 77 01				50 005 615
11.1974→05.1987 Reference	OM 401 905 403 200 27 01 403 200 32 01 403 200 34 01 403 200 35 01 403 200 49 01 403 200 70 01				50 005 207
11.1974→05.1987 Reference	OM 401 905 403 200 44 01 403 200 51 01 403 200 71 01				50 005 210
Series 1820					798
Reference	OM 345 915 (BRA) 355 180 01 01				50 005 829
05.1992→ 01.1994→ Reference	OM 356 987 OM 357 925 366 180 01 01 366 180 04 01				50 005 836
05.1992→ Reference	OM 356 987 366 200 09 01 366 200 59 01				50 005 629

M







Series 1821

799

07.1985→ Reference	OM 382 919, 971 366 180 01 01 366 180 04 01		50 005 836	
07.1985→ Reference	OM 382 919, 971 366 200 09 01 366 200 59 01			50 005 629



Series 1824

800

12.1990→ 01.1994→ Reference	M 476 920 OM 401 973, 975, 984, 990 OM 445 924-925, 930, 933, 938, 941 401 180 00 01 401 180 01 01 403 180 06 01 403 180 17 01		50 005 837	
12.1990→ 01.1994→ Reference	OM 401 973, 975, 984, 990 OM 445 924-925, 930, 933, 938, 941 403 200 76 01 403 200 77 01			50 005 615
1988 → Reference	OM 441 908-909 441 200 01 01 441 200 02 01			50 005 616
12.1992→08.1994 Reference	OM 356 999 366 180 01 01 366 180 04 01		50 005 836	
12.1990→ 1988 → 01.1994→ Reference	OM 401 973, 975, 984, 990 OM 441 908-909 OM 445 924-925, 930, 933, 938, 941 403 200 44 01 403 200 51 01 403 200 71 01			50 005 210

Series 1825

801

08.1997→ Reference	OM 457 942 403 180 28 01 ohne Antriebsrad, without impeller, sans roue motrice, sin rueda motriz, без ведущего колеса		50 005 828	
08.1997→ Reference	OM 457 942 403 180 27 01 mit Antriebsrad, with impeller, avec roue motrice, con rueda motriz, с приводным колесом		50 005 827	

Series 1827















802

12.1990→ 01.1994→ Reference	OM 401 973, 977-978, 989, 991 OM 445 926, 933, 936 401 180 00 01 401 180 01 01 403 180 06 01 403 180 17 01		50 005 837	
-----------------------------------	--	---	------------	--

M



MERCEDES-BENZ





				
12.1990→ 01.1994→ Reference	OM 401 OM 445 403 200 76 01	973, 977-978, 989, 991 926, 933, 936 403 200 77 01		50 005 615
12.1992→08.1994 Reference	OM 356 366 180 01 01	999 366 180 04 01		50 005 836
12.1990→ 01.1994→ Reference	OM 401 OM 445 403 200 44 01	973, 977-978, 989, 991 926, 933, 936 403 200 51 01 403 200 71 01		50 005 210
Series 1829				803
08.1992→ 01.1994→ Reference	OM 440 OM 445 401 180 00 01	907 934-935 401 180 01 01 403 180 06 01 403 180 17 01		50 005 837
01.1994→ Reference	OM 445 403 200 76 01	934-935 403 200 77 01		50 005 615
08.1992→ Reference	OM 440 441 200 01 01	907 441 200 02 01		50 005 616
01.1994→ Reference	OM 445 403 200 44 01	934-935 403 200 51 01 403 200 71 01		50 005 210
Series 1831				804
12.1990→ 07.1995→ 01.1994→ Reference	OM 401 OM 441 OM 445 401 180 00 01	972, 979, 986, 993 986, 993, 997 929-930, 937 401 180 01 01 403 180 06 01 403 180 17 01		50 005 837
12.1990→ 07.1995→ 01.1994→ Reference	OM 401 OM 441 OM 445 403 200 76 01	972, 979, 986, 993 986, 993, 997 929-930, 937 403 200 77 01		50 005 615
12.1990→ 07.1995→ 01.1994→ Reference	OM 401 OM 441 OM 445 403 200 44 01	972, 979, 986, 993 986, 993, 997 929-930, 937 403 200 51 01 403 200 71 01		50 005 210

M







Series 1834

805

01.1992→ Reference	OM 440 945 403 180 33 01 423 180 01 01 423 180 05 01		50 005 834	
01.1989→ 01.1994→ Reference	OM 441 960, 986-987, 989, 993, 996, 999 OM 445 920-921, 934, 939 401 180 00 01 401 180 01 01 403 180 06 01 403 180 17 01		50 005 837	
01.1992→ 01.1989→ 01.1994→ Reference	OM 440 945 OM 441 960, 986-987, 989, 993, 996, 999 OM 445 920-921, 934, 939 403 200 76 01 403 200 77 01			50 005 615
01.1992→ 01.1989→ 01.1994→ Reference	OM 440 945 OM 441 960, 986-987, 989, 993, 996, 999 OM 445 920-921, 934, 939 403 200 44 01 403 200 51 01 403 200 71 01			50 005 210



Series 1835

806

01.1996→ Reference	OM 446 946 403 180 33 01 423 180 01 01 423 180 05 01		50 005 834	
Reference	OM 466 900 405, 900 505 401 180 00 01 401 180 01 01 403 180 06 01 403 180 17 01		50 005 837	
01.1996→ Reference	OM 446 946 403 200 76 01 403 200 77 01			50 005 615
01.1996→ Reference	OM 446 946 403 200 44 01 403 200 51 01 403 200 71 01			50 005 210

Series 1836

807

Reference	OM 457 944 403 180 28 01 ohne Antriebsrad, without impeller, sans roue motrice, sin rueda motriz, без ведущего колеса		50 005 828	
Reference	OM 457 944 403 180 27 01 mit Antriebsrad, with impeller, avec roue motrice, con rueda motriz, с приводным колесом		50 005 827	

Series 1838

808

12.1990→ 01.1994→ Reference	OM 402 971-972, 975, 985-986, 996 OM 440 978-979, 982, 989, 991 OM 446 920, 924-925, 927, 935-936, 943, 946 403 180 33 01 423 180 01 01 423 180 05 01		50 005 834	
-----------------------------------	--	---	------------	--

M



12.1990→ 01.1994→ Reference	OM 402 OM 440 OM 446 403 200 76 01	971-972, 975, 985-986, 996 978-979, 982, 989, 991 920, 924-925, 927, 935-936, 943, 946 403 200 77 01			50 005 615
12.1990→ 01.1994→ Reference	OM 402 OM 440 OM 446 403 200 44 01	971-972, 975, 985-986, 996 978-979, 982, 989, 991 920, 924-925, 927, 935-936, 943, 946 403 200 51 01 403 200 71 01			50 005 210
Series 1840					809
07.1991→07.1992 Reference	OM 402 403 180 33 01	971 423 180 01 01 423 180 05 01		50 005 834	
07.1991→07.1992 Reference	OM 402 403 200 76 01	971 403 200 77 01			50 005 615
07.1991→07.1992 Reference	OM 402 403 200 44 01	971 403 200 51 01 403 200 71 01			50 005 210
Series 1842					810
Reference 	OM 457 403 180 28 01	944 ohne Antriebsrad, without impeller, sans roue motrice, sin rueda motriz, без ведущего колеса		50 005 828	
Reference 	OM 457 403 180 27 01	944 mit Antriebsrad, with impeller, avec roue motrice, con rueda motriz, с приводным колесом		50 005 827	
Series 1844					811
07.1991→07.1992 11.1991→02.2001 01.1996→ Reference	OM 402 OM 440 OM 446 403 180 33 01	996 970, 978-979, 982 920, 922, 936, 946 423 180 01 01 423 180 05 01		50 005 834	
07.1991→07.1992 11.1991→02.2001 01.1996→ Reference	OM 402 OM 440 OM 446 403 200 76 01	996 970, 978-979, 982 920, 922, 936, 946 403 200 77 01			50 005 615
07.1991→07.1992 11.1991→02.2001 01.1996→ Reference	OM 402 OM 440 OM 446 403 200 44 01	996 970, 978-979, 982 920, 922, 936, 946 403 200 51 01 403 200 71 01			50 005 210

M



Series 1850

812

07.1995→ 1985→05.1998 01.1996→ Reference	OM 440 973 OM 442 985, 989, 997 OM 446 920 403 180 33 01 423 180 01 01 423 180 05 01		50 005 834	
07.1995→ 1985→05.1998 01.1996→ Reference	OM 440 973 OM 442 985, 989, 997 OM 446 920 403 200 76 01 403 200 77 01			50 005 615
07.1995→ 1985→05.1998 01.1996→ Reference	OM 440 973 OM 442 985, 989, 997 OM 446 920 403 200 44 01 403 200 51 01 403 200 71 01			50 005 210

Series 1853

813

1991 → 07.1995→06.1995 01.1996→ Reference	OM 402 996 OM 440 979, 982 OM 446 920, 936 403 180 33 01 423 180 01 01 423 180 05 01		50 005 834	
1991 → 07.1995→06.1995 01.1996→ Reference	OM 402 996 OM 440 979, 982 OM 446 920, 936 403 200 76 01 403 200 77 01			50 005 615
1991 → 07.1995→06.1995 01.1996→ Reference	OM 402 996 OM 440 979, 982 OM 446 920, 936 403 200 44 01 403 200 51 01 403 200 71 01			50 005 210

Series 1916

814



02.1977→01.1987 Reference	OM 401 923 403 200 76 01 403 200 77 01			50 005 615
02.1977→01.1987 Reference	OM 401 923 403 200 27 01 403 200 32 01 403 200 34 01 403 200 35 01 403 200 49 01 403 200 70 01			50 005 207
02.1977→01.1987 Reference	OM 401 923 403 200 44 01 403 200 51 01 403 200 71 01			50 005 210

M





Series 1919

815

05.1974→08.1982	OM 401	909, 916						50 005 615
Reference	403 200 76 01	403 200 77 01						
05.1974→08.1982	OM 401	909, 916						50 005 207
Reference	403 200 27 01 403 200 49 01	403 200 32 01 403 200 70 01	403 200 34 01	403 200 35 01				
05.1974→08.1982	OM 401	909, 916						50 005 210
Reference	403 200 44 01	403 200 51 01	403 200 71 01					

Series 1920





816

02.1990→ 07.1985→	OM 356 OM 366	978, 985 996					50 005 836	
Reference	366 180 01 01	366 180 04 01						
02.1990→ 07.1985→	OM 356 OM 366	985 996						50 005 629
Reference	366 200 09 01	366 200 59 01						

M

Series 1921

817













09.1969→12.1972	OM 335 OM 355	930 (IRN) 966					50 005 829	
Reference	355 180 01 01							
Reference	OM 357	926					50 005 836	
	366 180 01 01	366 180 04 01						
09.1969→12.1972	OM 355	966						50 005 211
Reference	355 200 01 01 355 200 09 01	355 200 05 01 355 200 11 01	355 200 06 01 355 200 15 01	355 200 08 01				
		wartungsfrei maintenance-free sans entretien sin necesidad de mantenimiento не нуждающийся в обслуживании						

Series 1922

818

02.1993→ 1979 →	OM 401 OM 422	975 909					50 005 837	
Reference	401 180 00 01	401 180 01 01	403 180 06 01	403 180 17 01				



				
02.1993→ 10.1981→03.1991 1979 → Reference	OM 401 975 OM 421 905 OM 422 909 403 200 76 01 403 200 77 01			50 005 615
05.1989→08.1994 Reference	OM 441 905, 914, 923, 926, 932 441 200 01 01 441 200 02 01			50 005 616
02.1993→ 10.1981→03.1991 1979 → 05.1989→08.1994 Reference	OM 401 975 OM 421 905 OM 422 909 OM 441 905, 914, 923, 926, 932 OM 481 902 (TUR) 403 200 44 01 403 200 51 01 403 200 71 01			50 005 210
Series 1923				819
1967 →1978 Reference	OM 355 913-914 355 180 01 01		50 005 829	
Series 1924				820
10.1975→ Reference	OM 345 910 (BRA), 912-913 (BRA) OM 355 960, 963-964, 968, 983-984 355 180 01 01		50 005 829	
04.1972→1985 Reference	OM 402 917 OM 407 930 (AFS) OM 496 900 001 (AFS), 900 026 (AFS), 900 027 (AFS) 401 180 00 01 401 180 01 01 403 180 06 01 403 180 17 01		50 005 837	
04.1972→1985 Reference	OM 402 917 403 200 76 01 403 200 77 01			50 005 615
Reference	OM 357 949 366 180 01 01 366 180 04 01		50 005 836	
04.1972→1985 Reference	OM 402 917 OM 407 930 (AFS) 403 200 27 01 403 200 32 01 403 200 34 01 403 200 35 01 403 200 49 01 403 200 70 01			50 005 207

M



MERCEDES-BENZ

Reference	OM 355 960, 963-964, 968, 977 (MEX), 983-984	355 200 01 01 355 200 05 01 355 200 06 01 355 200 08 01 355 200 09 01 355 200 11 01 355 200 15 01		50 005 211
	wartungsfrei maintenance-free sans entretien sin necesidad de mantenimiento не нуждающийся в обслуживании			
04.1972→1985	OM 402 917 OM 407 930 (AFS)			50 005 210
Reference	403 200 44 01 403 200 51 01 403 200 71 01			
Series 1925				821
1979 →1988	OM 422 909			50 005 837
Reference	401 180 00 01 401 180 01 01 403 180 06 01 403 180 17 01			
1979 →1988	OM 422 909			50 005 615
Reference	403 200 76 01 403 200 77 01			
1979 →1988	OM 422 909			50 005 210
Reference	403 200 44 01 403 200 51 01 403 200 71 01			
Series 1926				822
08.1973→12.1980 07.1988→	OM 402 906, 912, 916 OM 442 922			50 005 837
Reference	401 180 00 01 401 180 01 01 403 180 06 01 403 180 17 01			
08.1973→12.1980	OM 402 906, 912, 916			50 005 615
Reference	403 200 76 01 403 200 77 01			
07.1988→	OM 442 922			50 005 616
Reference	441 200 01 01 441 200 02 01			
08.1973→12.1980	OM 402 906, 912, 916			50 005 207
Reference	403 200 27 01 403 200 32 01 403 200 34 01 403 200 35 01 403 200 49 01 403 200 70 01			
08.1973→12.1980 07.1988→	OM 402 906, 912, 916 OM 442 922			50 005 210
Reference	403 200 44 01 403 200 51 01 403 200 71 01			

M



Series 1927

823

1991 → Reference	OM 401 973 401 180 00 01 401 180 01 01 403 180 06 01 403 180 17 01		50 005 837
1991 → Reference	OM 401 973 403 200 76 01 403 200 77 01		50 005 615
1991 → Reference	OM 401 973 403 200 44 01 403 200 51 01 403 200 71 01		50 005 210

Series 1928

824









1985 →02.1991 Reference	OM 442 952, 962 403 180 33 01 423 180 01 01 423 180 05 01		50 005 834
01.1980→03.1991 03.1987→05.1989 Reference	OM 407 952 (AFS), 956 (AFS) OM 422 905-907, 911, 913, 916 OM 442 908 OM 482 912 (TUR) OM 492 900 002 (AFS) OM 496 900 401 (AFS), 900 426 (AFS), 900 430 (AFS) 401 180 00 01 401 180 01 01 403 180 06 01 403 180 17 01		50 005 837
01.1980→03.1991 1985 →02.1991 Reference	OM 422 905-907, 911, 913, 916 OM 442 952, 962 403 200 76 01 403 200 77 01		50 005 615
03.1987→05.1989 Reference	OM 442 908 441 200 01 01 441 200 02 01		50 005 616
10.1979→ Reference	OM 407 952 (AFS) 403 200 27 01 403 200 32 01 403 200 34 01 403 200 35 01 403 200 49 01 403 200 70 01		50 005 207
05.1979→02.2001 Reference	OM 355 969 355 200 01 01 355 200 05 01 355 200 06 01 355 200 08 01 355 200 09 01 355 200 11 01 355 200 15 01 wartungsfrei maintenance-free sans entretien sin necesidad de mantenimiento не нуждающийся в обслуживании		50 005 211
01.1980→03.1991 1985 →02.1991 Reference	OM 407 952 (AFS), 956 (AFS) OM 422 905-907, 911, 913, 916 OM 442 908, 952, 962 403 200 44 01 403 200 51 01 403 200 71 01		50 005 210

M



Series 1929

825

1985 →08.1994 Reference	OM 442 403 180 33 01	966, 971 423 180 01 01	423 180 05 01		50 005 834	
10.1975→ Reference	OM 345 OM 355 355 180 01 01	913 (BRA) 968			50 005 829	
01.1980→05.1989 03.1987→ Reference	OM 422 OM 442 OM 476 401 180 00 01	916 906-909, 923-926 950 (BRA)	403 180 06 01		50 005 837	
01.1980→05.1989 1985 →08.1994 Reference	OM 422 OM 442 403 200 76 01	916 966, 971	403 200 77 01			50 005 615
03.1987→ Reference	OM 442 441 200 01 01	906-909, 923-926 441 200 02 01				50 005 616
Reference 	OM 355 355 200 01 01 355 200 09 01 wartungsfrei maintenance-free sans entretien sin necesidad de mantenimiento не нуждающийся в обслуживании	968, 977 (MEX) 355 200 05 01 355 200 11 01	355 200 06 01 355 200 15 01	355 200 08 01		50 005 211
01.1980→05.1989 1985 → Reference	OM 422 OM 442 403 200 44 01	916 906-909, 923-924, 966, 971	403 200 51 01 403 200 71 01			50 005 210

M



Series 1930

826

10.1975→ Reference	OM 345 355 180 01 01	913 (BRA)			50 005 829	
-----------------------	-------------------------	-----------	--	---	------------	--

Series 1932

827

09.1970→1985 Reference 	OM 403 403 180 33 01 121800→	915-916, 931-935 423 180 01 01	423 180 05 01		50 005 834	
Reference	OM 345 355 180 01 01	950 (BRA)			50 005 829	



09.1970→1985 Reference 	OM 403 401 180 00 01 →121799	915-916, 931-935 401 180 01 01 403 180 06 01 403 180 17 01		50 005 837
09.1970→1985 Reference	OM 403 403 200 76 01	915-916, 931-935 403 200 77 01		50 005 615
09.1970→1985 Reference	OM 403 403 200 27 01 403 200 49 01	915-916, 931-935 403 200 32 01 403 200 70 01	403 200 34 01 403 200 35 01 	50 005 207
09.1970→1985 Reference	OM 403 403 200 44 01	915-916, 931-935 403 200 51 01 403 200 71 01		50 005 210
Series 1933				828
11.1980→03.1991 10.1984→ Reference	OM 422 OM 492 403 180 33 01	952, 954, 956-958 900 409 (AFS) 423 180 01 01 423 180 05 01		50 005 834
Reference	OM 345 355 180 01 01	950 (BRA)		50 005 829
11.1980→03.1991 Reference	OM 422 403 200 76 01	952, 954, 956-958 403 200 77 01		50 005 615
11.1980→03.1991 Reference	OM 422 403 200 44 01	952, 954, 956-958 403 200 51 01 403 200 71 01		50 005 210
Series 1934				829
Reference	OM 345 355 180 01 01	953 (BRA)		50 005 829
Series 1935				830
07.1991→08.1994 1985→08.1994 Reference	OM 440 OM 442 403 180 33 01	940-942 942-944, 950, 952, 962-964, 966, 971-972, 976-978 423 180 01 01 423 180 05 01		50 005 834

M



MERCEDES-BENZ



Reference	OM 476 973, 979-980 (BRA), 983 (BRA) 401 180 00 01 401 180 01 01 403 180 06 01 403 180 17 01		50 005 837	
07.1991→08.1994 1985→08.1994 Reference	OM 440 940-942 OM 442 942-944, 950, 952, 962-964, 966, 971-972, 976-978 403 200 76 01 403 200 77 01			50 005 615
07.1991→08.1994 1985→08.1994 Reference	OM 440 940-942 OM 442 942-944, 950, 952, 962-964, 966, 971-972, 976-978 403 200 44 01 403 200 51 01 403 200 71 01			50 005 210
Series 1936				831
10.1981→03.1991 02.1986→02.1991 1988→ Reference	OM 423 905-908 OM 442 950, 952, 959, 962 OM 443 905 403 180 33 01 423 180 01 01 423 180 05 01		50 005 834	
10.1981→03.1991 02.1986→02.1991 1988→ Reference	OM 423 905-908 OM 442 950, 952, 959, 962 OM 443 905 403 200 76 01 403 200 77 01			50 005 615
10.1981→03.1991 02.1986→02.1991 1988→ Reference	OM 423 905-908 OM 442 950, 952, 959, 962 OM 443 905 403 200 44 01 403 200 51 01 403 200 71 01			50 005 210
Series 1938				832
11.1980→06.1990 Reference	OM 402 985 OM 422 953, 955, 959 403 180 33 01 423 180 01 01 423 180 05 01		50 005 834	
Reference	OM 476 979-980 (BRA) 401 180 00 01 401 180 01 01 403 180 06 01 403 180 17 01		50 005 837	
11.1980→06.1990 Reference	OM 402 985 OM 422 953, 955, 959 403 200 76 01 403 200 77 01			50 005 615
11.1980→06.1990 Reference	OM 402 985 OM 422 953, 955, 959 403 200 44 01 403 200 51 01 403 200 71 01			50 005 210
Series 1941				833
Reference	OM 476 982 (BRA) 401 180 00 01 401 180 01 01 403 180 06 01 403 180 17 01		50 005 837	

M







Series 1944

834

10.1985→12.1989 Reference	OM 442 951, 953, 980 403 180 33 01 423 180 01 01 423 180 05 01		50 005 834	
10.1985→12.1989 Reference	OM 442 951, 953, 980 403 200 76 01 403 200 77 01			50 005 615
10.1985→12.1989 Reference	OM 442 951, 953, 980 403 200 44 01 403 200 51 01 403 200 71 01			50 005 210



Series 1945

835

10.1985→12.1989 Reference	OM 442 953, 962, 966, 971 403 180 33 01 423 180 01 01 423 180 05 01		50 005 834	
Reference	OM 476 982 (BRA) 401 180 00 01 401 180 01 01 403 180 06 01 403 180 17 01		50 005 837	
10.1985→12.1989 Reference	OM 442 953, 962, 966, 971 403 200 76 01 403 200 77 01			50 005 615
10.1985→12.1989 Reference	OM 442 953, 962, 966, 971 403 200 44 01 403 200 51 01 403 200 71 01			50 005 210

Series 1948

836



09.1988→ Reference	OM 442 985, 989, 992, 997 403 180 33 01 423 180 01 01 423 180 05 01		50 005 834	
09.1988→ Reference	OM 442 985, 989, 992, 997 403 200 76 01 403 200 77 01			50 005 615
09.1988→ Reference	OM 442 985, 989, 992, 997 403 200 44 01 403 200 51 01 403 200 71 01			50 005 210

M









Series 2020

837

03.1994→ Reference	OM 357 930 OM 366 995, 997 366 180 01 01 366 180 04 01		50 005 836
Reference	OM 366 995, 997 366 200 09 01 366 200 59 01		50 005 629

Series 2024

838



09.1969→12.1974 Reference	OM 355 962 355 180 01 01		50 005 829
02.1993→ 01.1994→ Reference	OM 401 975, 984 OM 445 924-925 401 180 00 01 401 180 01 01 403 180 06 01 403 180 17 01		50 005 837
02.1993→ 01.1994→ Reference	OM 401 975, 984 OM 445 924-925 403 200 76 01 403 200 77 01		50 005 615
02.1991→02.2001 Reference	OM 366 999 366 180 01 01 366 180 04 01		50 005 836
09.1969→12.1974 Reference	OM 355 962 355 200 01 01 355 200 05 01 355 200 06 01 355 200 08 01 355 200 09 01 355 200 11 01 355 200 15 01 wartungsfrei maintenance-free sans entretien sin necesidad de mantenimiento не нуждающийся в обслуживании		50 005 211
02.1991→02.2001 Reference	OM 366 999 366 200 09 01 366 200 59 01		50 005 629
02.1993→ 01.1994→ Reference	OM 401 975, 984 OM 445 924-925 403 200 44 01 403 200 51 01 403 200 71 01		50 005 210

M







Series 2025

839

08.1983→03.1991 Reference	OM 422 909 401 180 00 01 401 180 01 01 403 180 06 01 403 180 17 01		50 005 837	
08.1983→03.1991 Reference	OM 422 909 403 200 76 01 403 200 77 01			50 005 615
08.1983→03.1991 Reference	OM 422 909 403 200 44 01 403 200 51 01 403 200 71 01			50 005 210



Series 2026

840

08.1973→03.1981 Reference	OM 402 912, 916 401 180 00 01 401 180 01 01 403 180 06 01 403 180 17 01		50 005 837	
08.1973→03.1981 Reference	OM 402 912, 916 403 200 76 01 403 200 77 01			50 005 615
08.1973→03.1981 Reference	OM 402 912, 916 403 200 27 01 403 200 32 01 403 200 34 01 403 200 35 01 403 200 49 01 403 200 70 01			50 005 207
08.1973→03.1981 Reference	OM 402 912, 916 403 200 44 01 403 200 51 01 403 200 71 01			50 005 210

Series 2027

841

01.1992→07.1992 01.1994→ Reference	OM 401 989 OM 445 933 401 180 00 01 401 180 01 01 403 180 06 01 403 180 17 01		50 005 837	
01.1992→07.1992 01.1994→ Reference	OM 401 989 OM 445 933 403 200 76 01 403 200 77 01			50 005 615
01.1992→07.1992 01.1994→ Reference	OM 401 989 OM 445 933 403 200 44 01 403 200 51 01 403 200 71 01			50 005 210

M



Series 2028

842

11.1981→03.1991 1985→02.1991 Reference	OM 423 907 OM 442 962 403 180 33 01 423 180 01 01 423 180 05 01		50 005 834	
01.1980→06.1989 01.1989→02.1991 Reference	OM 422 905-907, 910-911, 913, 916 OM 441 951 401 180 00 01 401 180 01 01 403 180 06 01 403 180 17 01		50 005 837	
01.1980→06.1989 11.1981→03.1991 01.1989→02.1991 1985→02.1991 Reference	OM 422 905-907, 910-911, 913, 916 OM 423 907 OM 441 951 OM 442 962 403 200 76 01 403 200 77 01			50 005 615
01.1980→06.1989 11.1981→03.1991 01.1989→02.1991 1985→02.1991 Reference	OM 422 905-907, 910-911, 913, 916 OM 423 907 OM 441 951 OM 442 962 403 200 44 01 403 200 51 01 403 200 71 01			50 005 210

Series 2031

843

05.1991→ 03.1992→06.1995 Reference	OM 402 996 OM 440 979 403 180 33 01 423 180 01 01 423 180 05 01		50 005 834	
05.1991→ 07.1995→ 01.1994→ Reference	OM 401 972, 979, 986, 993 OM 441 997-998 OM 445 929-930 401 180 00 01 401 180 01 01 403 180 06 01 403 180 17 01		50 005 837	
05.1991→ 05.1991→ 03.1992→06.1995 07.1995→ 01.1994→ Reference	OM 401 972, 979, 986, 993 OM 402 996 OM 440 979 OM 441 997-998 OM 445 929-930 403 200 76 01 403 200 77 01			50 005 615
05.1991→ 05.1991→ 03.1992→06.1995 07.1995→ 01.1994→ Reference	OM 401 972, 979, 986, 993 OM 402 996 OM 440 979 OM 441 997-998 OM 445 929-930 403 200 44 01 403 200 51 01 403 200 71 01			50 005 210

Series 2032

844

09.1970→1985 Reference	OM 403 915, 931-932, 935 403 180 33 01 423 180 01 01 423 180 05 01 121800→		50 005 834	
09.1970→1985 Reference	OM 403 915, 931-932, 935 401 180 00 01 401 180 01 01 403 180 06 01 403 180 17 01 →121799		50 005 837	
09.1970→1985 Reference	OM 403 915, 931-932, 935 403 200 76 01 403 200 77 01			50 005 615

M



09.1970→1985 Reference	OM 403 403 200 27 01 403 200 49 01	915, 931-932, 935 403 200 32 01 403 200 70 01	403 200 34 01	403 200 35 01			50 005 207
09.1970→1985 Reference	OM 403 403 200 44 01	915, 931-932, 935 403 200 51 01	403 200 71 01				50 005 210
Series 2033							845
12.1981→05.1987 Reference	OM 422 403 180 33 01	952, 954, 956-958 423 180 01 01	423 180 05 01			50 005 834	
12.1981→05.1987 Reference	OM 422 403 200 76 01	952, 954, 956-958 403 200 77 01					50 005 615
12.1981→05.1987 Reference	OM 422 403 200 44 01	952, 954, 956-958 403 200 51 01	403 200 71 01				50 005 210
Series 2035							846
1981 → 06.1986→07.1989 Reference	OM 423 OM 442 403 180 33 01	907 950, 952, 958, 962, 967 423 180 01 01	423 180 05 01			50 005 834	
1981 → 06.1986→07.1989 Reference	OM 423 OM 442 403 200 76 01	907 950, 952, 958, 962, 967 403 200 77 01					50 005 615
1981 → 06.1986→07.1989 Reference	OM 423 OM 442 403 200 44 01	907 950, 952, 958, 962, 967 403 200 51 01	403 200 71 01				50 005 210
Series 2036							847
03.1984→03.1991 1985 →03.1991 Reference	OM 423 OM 442 403 180 33 01	905-908 950, 962 423 180 01 01	423 180 05 01			50 005 834	
08.1983→03.1991 Reference	OM 422 401 180 00 01	907 401 180 01 01	403 180 06 01	403 180 17 01		50 005 837	

M



08.1983→03.1991 03.1984→03.1991 1985 →03.1991 Reference	OM 422 907 OM 423 905-908 OM 442 950, 962 403 200 76 01 403 200 77 01			50 005 615
08.1983→03.1991 03.1984→03.1991 1985 →03.1991 Reference	OM 422 907 OM 423 905-908 OM 442 950, 962 403 200 44 01 403 200 51 01 403 200 71 01			50 005 210
Series 2038				848
11.1991→ 01.1994→ Reference	OM 402 971-972, 978, 985-986, 996 OM 440 978-979, 989-990 OM 446 924-925, 927, 935-936 403 180 33 01 423 180 01 01 423 180 05 01		50 005 834	
11.1991→ 01.1994→ Reference	OM 402 971-972, 978, 985-986, 996 OM 440 978-979, 989-990 OM 446 924-925, 927, 935-936 403 200 76 01 403 200 77 01			50 005 615
11.1991→ 01.1994→ Reference	OM 402 971-972, 978, 985-986, 996 OM 440 978-979, 989-990 OM 446 924-925, 927, 935-936 403 200 44 01 403 200 51 01 403 200 71 01			50 005 210
Series 2044				849
01.1991→05.1998 07.1995→05.1998 01.1994→ Reference	OM 440 970, 979 OM 442 997 OM 446 922, 927, 936 403 180 33 01 423 180 01 01 423 180 05 01		50 005 834	
01.1991→05.1998 07.1995→05.1998 01.1994→ Reference	OM 440 970, 979 OM 442 997 OM 446 922, 927, 936 403 200 76 01 403 200 77 01			50 005 615
01.1991→05.1998 07.1995→05.1998 01.1994→ Reference	OM 440 970, 979 OM 442 997 OM 446 922, 927, 936 403 200 44 01 403 200 51 01 403 200 71 01			50 005 210
Series 2050				850
07.1995→05.1998 1985 →05.1998 01.1996→ Reference	OM 440 976 OM 442 989, 997 OM 446 920 403 180 33 01 423 180 01 01 423 180 05 01		50 005 834	
07.1995→05.1998 1985 →05.1998 01.1996→ Reference	OM 440 976 OM 442 989, 997 OM 446 920 403 200 76 01 403 200 77 01			50 005 615

M

















07.1995→05.1998 1985→05.1998 01.1996→ Reference	OM 440 976 OM 442 989, 997 OM 446 920 403 200 44 01 403 200 51 01 403 200 71 01			50 005 210
Series 2053				851
01.1996→ Reference	OM 446 920 403 180 33 01 423 180 01 01 423 180 05 01			50 005 834
01.1996→ Reference	OM 446 920 403 200 76 01 403 200 77 01			50 005 615
01.1996→ Reference	OM 446 920 403 200 44 01 403 200 51 01 403 200 71 01			50 005 210
Series 2219				852
02.1983→09.1985 Reference	OM 362 906, 910 353 200 56 01			50 005 618
01.1976→04.1987 Reference	OM 345 915 (BRA), 973 (BRA) 355 180 01 01			50 005 829
Reference	OM 409 906 (AFS), 908 (AFS) OM 495 900 001 (AFS), 900 003 (AFS), 900 009 (AFS), 900 010 (AFS) 401 180 00 01 401 180 01 01 403 180 06 01 403 180 17 01			50 005 837
04.1972→06.1987 Reference	OM 401 905, 914, 923-928 403 200 76 01 403 200 77 01			50 005 615
02.1983→09.1985 07.1985→03.1991 Reference	OM 362 906, 910 OM 366 983 366 180 01 01 366 180 04 01			50 005 836
04.1972→06.1987 Reference	OM 401 905, 914, 923-928 OM 409 906 (AFS), 908 (AFS) 403 200 27 01 403 200 32 01 403 200 34 01 403 200 35 01 403 200 49 01 403 200 70 01			50 005 207

M



MERCEDES-BENZ

				
07.1985→03.1991 Reference	OM 366 983 366 200 09 01 366 200 59 01			50 005 629
04.1972→06.1987 Reference	OM 401 905, 914, 923-928 OM 409 906 (AFS), 908 (AFS) 403 200 44 01 403 200 51 01 403 200 71 01			50 005 210
Series 2220				853
07.1983→09.1985 Reference	OM 362 909-910 353 200 56 01			50 005 618
1967 →1978 Reference	OM 345 915 (BRA), 973 (BRA) OM 355 910 355 180 01 01		50 005 829	
07.1983→09.1985 07.1985→03.1991 Reference	OM 362 909-910 OM 366 983 366 180 01 01 366 180 04 01		50 005 836	
07.1985→03.1991 Reference	OM 366 983 366 200 09 01 366 200 59 01			50 005 629
Series 2222				854
1979 → 01.1989→02.1991 Reference	OM 422 911, 913 OM 441 961 401 180 00 01 401 180 01 01 403 180 06 01 403 180 17 01		50 005 837	
05.1982→03.1991 1979 → 01.1989→02.1991 Reference	OM 421 905, 907 OM 422 911, 913 OM 441 961 403 200 76 01 403 200 77 01			50 005 615
1988 → Reference	OM 441 914, 919 441 200 01 01 441 200 02 01			50 005 616
07.1985→03.1991 Reference	OM 366 983 366 180 01 01 366 180 04 01		50 005 836	

M



07.1985→03.1991 Reference	OM 366 983 366 200 09 01 366 200 59 01			50 005 629
05.1982→03.1991 1979 → 1988 → Reference	OM 421 905, 907 OM 422 911, 913 OM 441 914, 919, 961 OM 481 902 (TUR) 403 200 44 01 403 200 51 01 403 200 71 01			50 005 210
Series 2223				855
09.1969→12.1974 Reference	OM 355 962 355 180 01 01			50 005 829
09.1969→12.1974 Reference 	OM 355 962 355 200 01 01 355 200 05 01 355 200 06 01 355 200 08 01 355 200 09 01 355 200 11 01 355 200 15 01 wartungsfrei maintenance-free sans entretien sin necesidad de mantenimiento не нуждающийся в обслуживании			50 005 211
Series 2224				856
09.1967→12.1974 Reference	OM 355 912, 962 355 180 01 01			50 005 829
04.1972→1985 Reference	OM 402 910-911, 914, 927-928 401 180 00 01 401 180 01 01 403 180 06 01 403 180 17 01			50 005 837
04.1972→1985 Reference	OM 402 910-911, 914, 927-928 403 200 76 01 403 200 77 01			50 005 615
04.1972→1985 Reference	OM 402 910-911, 914, 927-928 403 200 27 01 403 200 32 01 403 200 34 01 403 200 35 01 403 200 49 01 403 200 70 01			50 005 207
09.1969→12.1974 Reference 	OM 355 962 355 200 01 01 355 200 05 01 355 200 06 01 355 200 08 01 355 200 09 01 355 200 11 01 355 200 15 01 wartungsfrei maintenance-free sans entretien sin necesidad de mantenimiento не нуждающийся в обслуживании			50 005 211

M



04.1972→1985 Reference	OM 402 403 200 44 01	910-911, 914, 927-928 403 200 51 01 403 200 71 01		50 005 210
Series 2225				857
1979 → 01.1989→02.1991 03.1987→ Reference	OM 422 OM 441 OM 442 OM 475 OM 492 401 180 00 01	909, 911-913, 923 961 905, 908-909 954 (BRA) 900 001 (AFS) 401 180 01 01 403 180 06 01 403 180 17 01		50 005 837
1979 → 01.1989→02.1991 Reference	OM 422 OM 441 403 200 76 01	909, 911-913, 923 961 403 200 77 01		50 005 615
02.1987→03.1991 03.1987→ Reference	OM 441 OM 442 441 200 01 01	906 905, 908-909 441 200 02 01		50 005 616
1979 → 02.1987→03.1991 03.1987→ Reference	OM 422 OM 441 OM 442 403 200 44 01	909, 911-913, 923 906, 961 905, 908-909 403 200 51 01 403 200 71 01		50 005 210
Series 2226				858
04.1972→1985 Reference	OM 402 401 180 00 01	905, 912, 916, 924 401 180 01 01 403 180 06 01 403 180 17 01		50 005 837
04.1972→1985 Reference	OM 402 403 200 76 01	905, 912, 916, 924 403 200 77 01		50 005 615
04.1972→1985 Reference	OM 402 403 200 27 01 403 200 49 01	905, 912, 916, 924 403 200 32 01 403 200 70 01 403 200 34 01 403 200 35 01		50 005 207
04.1972→1985 Reference	OM 402 403 200 44 01	905, 912, 916, 924 403 200 51 01 403 200 71 01		50 005 210
Series 2228				859
09.1982→03.1991 1985 →02.1991 Reference	OM 423 OM 442 403 180 33 01	905, 908 962 423 180 01 01 423 180 05 01		50 005 834

M



1979 → 01.1989→02.1991 1988 → Reference	OM 422 905-906, 911, 913, 916 OM 441 951, 961 OM 442 909 401 180 00 01 401 180 01 01 403 180 06 01 403 180 17 01		50 005 837	
1982 → 1979 → 09.1982→03.1991 01.1989→02.1991 1985 →02.1991 Reference	OM 421 910 OM 422 905-906, 911, 913, 916 OM 423 905, 908 OM 441 951, 961 OM 442 962 403 200 76 01 403 200 77 01			50 005 615
1988 → Reference	OM 442 909 441 200 01 01 441 200 02 01			50 005 616
1982 → 1979 → 09.1982→03.1991 01.1989→02.1991 1985 → Reference	OM 421 910 OM 422 905-906, 911, 913, 916 OM 423 905, 908 OM 441 951, 961 OM 442 909, 962 403 200 44 01 403 200 51 01 403 200 71 01			50 005 210

Series 2229

860

1988 → Reference	OM 442 907 401 180 00 01 401 180 01 01 403 180 06 01 403 180 17 01		50 005 837	
1988 → Reference	OM 442 907 441 200 01 01 441 200 02 01			50 005 616
1988 → Reference	OM 442 907 403 200 44 01 403 200 51 01 403 200 71 01			50 005 210

Series 2232















861

09.1970→1985 Reference 	OM 403 915, 931-932, 934-935 403 180 33 01 423 180 01 01 423 180 05 01 121800→		50 005 834	
09.1970→1985 Reference 	OM 403 915, 931-932, 934-935 401 180 00 01 401 180 01 01 403 180 06 01 403 180 17 01 →121799		50 005 837	
09.1970→1985 Reference	OM 403 915, 931-932, 934-935 403 200 76 01 403 200 77 01			50 005 615

M



MERCEDES-BENZ

						
09.1970→1985 Reference	OM 403 403 200 27 01 403 200 49 01	915, 931-932, 934-935 403 200 32 01 403 200 70 01	403 200 34 01	403 200 35 01		50 005 207
09.1970→1985 Reference	OM 403 403 200 44 01	915, 931-932, 934-935 403 200 51 01	403 200 71 01			50 005 210
Series 2233						862
11.1980→05.1987 09.1982→03.1991 10.1984→ Reference	OM 422 OM 423 OM 492 403 180 33 01	952, 954, 956-958 908 900 405 (AFS) 423 180 01 01	423 180 05 01			50 005 834
01.1989→02.1991 Reference	OM 441 401 180 00 01	951 401 180 01 01	403 180 06 01	403 180 17 01		50 005 837
11.1980→05.1987 09.1982→03.1991 01.1989→02.1991 Reference	OM 422 OM 423 OM 441 403 200 76 01	952, 954, 956-958 908 951 403 200 77 01				50 005 615
11.1980→05.1987 09.1982→03.1991 01.1989→02.1991 Reference	OM 422 OM 423 OM 441 403 200 44 01	952, 954, 956-958 908 951 403 200 51 01	403 200 71 01			50 005 210
Series 2235						863
03.1986→07.1989 Reference	OM 442 403 180 33 01	950, 952 423 180 01 01	423 180 05 01			50 005 834
01.1980→06.1989 Reference	OM 422 401 180 00 01	916 401 180 01 01	403 180 06 01	403 180 17 01		50 005 837
01.1980→06.1989 03.1986→07.1989 Reference	OM 422 OM 442 403 200 76 01	916 950, 952 403 200 77 01				50 005 615
01.1980→06.1989 03.1986→07.1989 Reference	OM 422 OM 442 403 200 44 01	916 950, 952 403 200 51 01	403 200 71 01			50 005 210
Series 2236						864
11.1981→03.1991 1985→02.1991 Reference	OM 423 OM 442 403 180 33 01	905-906, 908 950, 952, 962 423 180 01 01	423 180 05 01			50 005 834















M



01.1989→02.1991 Reference	OM 441 951 401 180 00 01 401 180 01 01 403 180 06 01 403 180 17 01		50 005 837	
11.1981→03.1991 01.1989→02.1991 1985→02.1991 Reference	OM 423 905-906, 908 OM 441 951 OM 442 950, 952, 962 403 200 76 01 403 200 77 01			50 005 615
11.1981→03.1991 01.1989→02.1991 1985→02.1991 Reference	OM 423 905-906, 908 OM 441 951 OM 442 950, 952, 962 403 200 44 01 403 200 51 01 403 200 71 01			50 005 210
Series 2238				865
01.1981→12.1986 Reference	OM 422 953, 955, 959 403 180 33 01 423 180 01 01 423 180 05 01		50 005 834	
01.1981→12.1986 Reference	OM 422 953, 955, 959 403 200 76 01 403 200 77 01			50 005 615
01.1981→12.1986 Reference	OM 422 953, 955, 959 403 200 44 01 403 200 51 01 403 200 71 01			50 005 210
Series 2244				866
1985→02.1991 Reference	OM 442 951, 953, 980 403 180 33 01 423 180 01 01 423 180 05 01		50 005 834	
1985→02.1991 Reference	OM 442 951, 953, 980 403 200 76 01 403 200 77 01			50 005 615
1985→02.1991 Reference	OM 442 951, 953, 980 403 200 44 01 403 200 51 01 403 200 71 01			50 005 210
Series 2320				867
02.1990→ Reference	OM 356 984, 987 366 180 01 01 366 180 04 01		50 005 836	

M



				
02.1990→ Reference	OM 356 984, 987 366 200 09 01 366 200 59 01			50 005 629
Series 2325				868
Reference	OM 475 951 (BRA), 954 (BRA) 401 180 00 01 401 180 01 01 403 180 06 01 403 180 17 01			50 005 837
Series 2327				869
01.1994→ Reference	OM 445 926 401 180 00 01 401 180 01 01 403 180 06 01 403 180 17 01			50 005 837
01.1994→ Reference	OM 445 926 403 200 76 01 403 200 77 01			50 005 615
01.1994→ Reference	OM 445 926 403 200 44 01 403 200 51 01 403 200 71 01			50 005 210
Series 2420				870
02.1990→08.1994 07.1985→03.1991 Reference	OM 356 984 OM 366 983 366 180 01 01 366 180 04 01			50 005 836
02.1990→08.1994 07.1985→03.1991 Reference	OM 356 984 OM 366 983 366 200 09 01 366 200 59 01			50 005 629
Series 2422				871
1991 → 07.1987→ Reference	OM 401 973, 977, 979 OM 442 914 401 180 00 01 401 180 01 01 403 180 06 01 403 180 17 01			50 005 837
1991 → 05.1986→06.1989 Reference	OM 401 973, 977, 979 OM 421 905 403 200 76 01 403 200 77 01			50 005 615
1988 → 07.1987→ Reference	OM 441 905, 912, 914, 920, 923-924 OM 442 914 441 200 01 01 441 200 02 01			50 005 616

M

















MERCEDES-BENZ

1991 → 05.1986→06.1989 1988 → 07.1987→ Reference	OM 401 OM 421 OM 441 OM 442 403 200 44 01	973, 977, 979 905 905, 912, 914, 920, 923-924 914 403 200 51 01	403 200 71 01	 50 005 210
Series 2423				872
Reference	OM 906 904 200 04 01 904 200 22 01 904 201 07 01	924 904 200 06 01 904 200 26 01	904 200 08 01 904 200 49 01	904 200 20 01 904 201 02 01 50 005 627
Series 2425				873
1979 → Reference	OM 422 OM 475 401 180 00 01	909, 911-913 951 (BRA), 954 (BRA) 401 180 01 01	403 180 06 01 403 180 17 01	 50 005 837
1979 → Reference	OM 422 403 200 76 01	909, 911-913 403 200 77 01		 50 005 615
1979 → Reference	OM 422 403 200 44 01	909, 911-913 403 200 51 01	403 200 71 01	 50 005 210
Series 2426				874
03.1991→ 09.1989→07.1992 07.1988→08.1994 Reference	OM 401 OM 441 OM 442 OM 462 401 180 00 01	973, 977-978 960 909, 914, 921-923, 932, 934 900 011 (AFS), 900 013 (AFS) 401 180 01 01	403 180 06 01 403 180 17 01	 50 005 837
03.1991→ 09.1989→07.1992 Reference	OM 401 OM 441 403 200 76 01	973, 977-978 960 403 200 77 01		 50 005 615
07.1988→08.1994 Reference	OM 442 441 200 01 01	909, 914, 921-923, 932, 934 441 200 02 01		 50 005 616
03.1991→ 09.1989→07.1992 07.1988→08.1994 Reference	OM 401 OM 441 OM 442 403 200 44 01	973, 977-978 960 909, 914, 922-923 403 200 51 01	403 200 71 01	 50 005 210
Series 2427				875
03.1991→ 07.1987→ Reference	OM 401 OM 442 401 180 00 01	973, 977-978 914 401 180 01 01	403 180 06 01 403 180 17 01	 50 005 837

M



					
03.1991→ Reference	OM 401 403 200 76 01	973, 977-978 403 200 77 01			50 005 615
07.1987→ Reference	OM 442 441 200 01 01	914 441 200 02 01			50 005 616
03.1991→ 07.1987→ Reference	OM 401 OM 442	973, 977-978 914	403 200 44 01 403 200 51 01 403 200 71 01		50 005 210
Series 2428					876
10.1981→03.1991 1985→02.1991 Reference	OM 423 OM 442	908 952, 962	403 180 33 01 423 180 01 01 423 180 05 01		50 005 834
1979 → 01.1989→02.1991 Reference	OM 422 OM 441	911, 913, 916 951	401 180 00 01 401 180 01 01 403 180 06 01 403 180 17 01		50 005 837
1979 → 10.1981→03.1991 01.1989→02.1991 1985 →02.1991 Reference	OM 422 OM 423 OM 441 OM 442	911, 913, 916 908 951 952, 962	403 200 76 01 403 200 77 01		50 005 615
Reference	OM 906	953	904 200 04 01 904 200 06 01 904 200 08 01 904 200 20 01 904 200 22 01 904 200 26 01 904 200 49 01 904 201 02 01 904 201 07 01		50 005 627
1979 → 10.1981→03.1991 01.1989→02.1991 1985 →02.1991 Reference	OM 422 OM 423 OM 441 OM 442	911, 913, 916 908 951 952, 962	403 200 44 01 403 200 51 01 403 200 71 01		50 005 210
Series 2429					877
01.1980→05.1989 03.1987→08.1994 Reference	OM 422 OM 442	916 906-908, 922-923, 925	401 180 00 01 401 180 01 01 403 180 06 01 403 180 17 01		50 005 837
01.1980→05.1989 Reference	OM 422	916	403 200 76 01 403 200 77 01		50 005 615

M



03.1987→08.1994 Reference	OM 442 441 200 01 01	906-908, 922-923, 925 441 200 02 01		50 005 616
01.1980→05.1989 03.1987→09.1993 Reference	OM 422 OM 442 403 200 44 01	916 906-908, 922-923 403 200 51 01	403 200 71 01 	50 005 210
Series 2433				878
1979 → Reference	OM 422 403 180 33 01	954, 957 423 180 01 01	423 180 05 01 	50 005 834
05.1989→ Reference	OM 441 401 180 00 01	951, 960-962, 981, 983, 991 401 180 01 01	403 180 06 01 403 180 17 01 	50 005 837
1979 → 05.1989→ Reference	OM 422 OM 441 403 200 76 01	954, 957 951, 960-962, 981, 983, 991 403 200 77 01		50 005 615
1979 → 05.1989→ Reference	OM 422 OM 441 403 200 44 01	954, 957 951, 960-962, 981, 983, 991 403 200 51 01	403 200 71 01 	50 005 210
Series 2434				879
07.1995→ Reference	OM 441 401 180 00 01	986, 989 401 180 01 01	403 180 06 01 403 180 17 01 	50 005 837
07.1995→ Reference	OM 441 403 200 76 01	986, 989 403 200 77 01		50 005 615
07.1995→ Reference	OM 441 403 200 44 01	986, 989 403 200 51 01	403 200 71 01 	50 005 210
Series 2435				880
09.1982→03.1991 07.1991→08.1994 1985 →08.1994 12.1991→ Reference	OM 423 OM 440 OM 442 OM 462 403 180 33 01	905 940 941, 943-944, 952, 962-965, 968, 976 900 410 (AFS), 900 411 (AFS) 423 180 01 01	423 180 05 01 	50 005 834















M



09.1982→03.1991 07.1991→08.1994 1985→08.1994 Reference	OM 423 905 OM 440 940 OM 442 941, 943-944, 952, 962-965, 968, 976 403 200 76 01 403 200 77 01			50 005 615
09.1982→03.1991 07.1991→08.1994 1985→08.1994 Reference	OM 423 905 OM 440 940 OM 442 941, 943-944, 952, 962-965, 968, 976 403 200 44 01 403 200 51 01 403 200 71 01			50 005 210
Series 2436				881
1981 → 1985 →02.1991 Reference	OM 423 907 OM 442 950, 952, 962 403 180 33 01 423 180 01 01 423 180 05 01		50 005 834	
1981 → 1985 →02.1991 Reference	OM 423 907 OM 442 950, 952, 962 403 200 76 01 403 200 77 01			50 005 615
1981 → 1985 →02.1991 Reference	OM 423 907 OM 442 950, 952, 962 403 200 44 01 403 200 51 01 403 200 71 01			50 005 210
Series 2438				882
11.1980→12.1986 Reference	OM 422 959 403 180 33 01 423 180 01 01 423 180 05 01		50 005 834	
11.1980→12.1986 Reference	OM 422 959 403 200 76 01 403 200 77 01			50 005 615
11.1980→12.1986 Reference	OM 422 959 403 200 44 01 403 200 51 01 403 200 71 01			50 005 210
Series 2444				883
01.1984→1992 Reference	OM 423 950 422 200 05 01 422 200 10 01			50 005 205
1985 →02.1991 01.1996→ Reference	OM 442 951, 953, 980 OM 446 920 OM 462 900 510 (AFS), 900 511 (AFS) 403 180 33 01 423 180 01 01 423 180 05 01		50 005 834	

M



				
1985 →02.1991 01.1996→ Reference	OM 442 951, 953, 980 OM 446 920 403 200 76 01 403 200 77 01			50 005 615
1985 →02.1991 01.1996→ Reference	OM 442 951, 953, 980 OM 446 920 403 200 44 01 403 200 51 01 403 200 71 01			50 005 210
Series 2445				884
12.1991→ Reference	OM 462 900 411 (AFS) 403 180 33 01 423 180 01 01 423 180 05 01		50 005 834	
Series 2448				885
07.1988→ Reference	OM 442 985, 989, 992, 998 403 180 33 01 423 180 01 01 423 180 05 01		50 005 834	
07.1988→ Reference	OM 442 985, 989, 992, 998 403 200 76 01 403 200 77 01			50 005 615
07.1988→ Reference	OM 442 985, 989, 992, 998 403 200 44 01 403 200 51 01 403 200 71 01			50 005 210
Series 2517				886
05.1988→ Reference	OM 382 913 366 180 01 01 366 180 04 01		50 005 836	
05.1988→ Reference	OM 382 913 366 200 09 01 366 200 59 01			50 005 629
Series 2521				887
07.1985→ Reference	OM 382 919 366 180 01 01 366 180 04 01		50 005 836	
07.1985→ Reference	OM 382 919 366 200 09 01 366 200 59 01			50 005 629

M







Series 2522

888

09.1989→ Reference	OM 441 923 441 200 01 01 441 200 02 01			50 005 616
09.1989→ Reference	OM 441 923 403 200 44 01 403 200 51 01 403 200 71 01			50 005 210





Series 2524

889

06.1992→ 07.1995→ 01.1994→ Reference	M 476 920 OM 401 975 OM 441 986 OM 445 924, 941 401 180 00 01 401 180 01 01 403 180 06 01 403 180 17 01		50 005 837	
06.1992→ 07.1995→ 01.1994→ Reference	OM 401 975 OM 441 986 OM 445 924, 941 403 200 76 01 403 200 77 01			50 005 615
03.1992→ Reference	OM 356 977 (TUR) 366 180 01 01 366 180 04 01		50 005 836	
06.1992→ 07.1995→ 01.1994→ Reference	OM 401 975 OM 441 986 OM 445 924, 941 403 200 44 01 403 200 51 01 403 200 71 01			50 005 210

Series 2527

890

03.1991→ 07.1987→ 01.1994→ Reference	OM 401 973, 977-978, 980 OM 442 914, 932 OM 445 926-927, 936, 940 401 180 00 01 401 180 01 01 403 180 06 01 403 180 17 01		50 005 837	
03.1991→ 01.1994→ Reference	OM 401 973, 977-978, 980 OM 445 926-927, 936, 940 403 200 76 01 403 200 77 01			50 005 615
07.1987→ Reference	OM 442 914, 932 441 200 01 01 441 200 02 01			50 005 616
03.1991→ 07.1987→ 01.1994→ Reference	OM 401 973, 977-978, 980 OM 442 914 OM 445 926-927, 936, 940 403 200 44 01 403 200 51 01 403 200 71 01			50 005 210

M



Series 2528

891

1985 →02.1991 Reference	OM 442 403 180 33 01	952, 962 423 180 01 01	423 180 05 01		50 005 834	
01.1980→12.1992 Reference	OM 422 401 180 00 01	911, 913, 916 401 180 01 01	403 180 06 01	403 180 17 01		50 005 837
01.1980→12.1992 1985 →02.1991 Reference	OM 422 403 200 76 01	911, 913, 916 952, 962 403 200 77 01				50 005 615
01.1980→12.1992 1985 →02.1991 Reference	OM 422 403 200 44 01	911, 913, 916 952, 962 403 200 51 01	403 200 71 01			50 005 210

Series 2529

892

1985 →02.1991 Reference	OM 442 403 180 33 01	971 423 180 01 01	423 180 05 01		50 005 834	
1988 → Reference	OM 442 401 180 00 01	906, 924, 929 401 180 01 01	403 180 06 01	403 180 17 01		50 005 837
1985 →02.1991 Reference	OM 442 403 200 76 01	971 403 200 77 01				50 005 615
1988 → Reference	OM 442 441 200 01 01	906, 924, 929 441 200 02 01				50 005 616
1985 → Reference	OM 442 403 200 44 01	906, 924, 971 403 200 51 01	403 200 71 01			50 005 210

Series 2531















893

12.1990→ 01.1994→ Reference	OM 401 401 180 00 01	972, 979, 993 930, 940 401 180 01 01	403 180 06 01	403 180 17 01		50 005 837
-----------------------------------	-------------------------	--	---------------	---------------	--	------------

M

















MERCEDES-BENZ

				
12.1990→ 01.1994→ Reference	OM 401 972, 979, 993 OM 445 930, 940 403 200 76 01 403 200 77 01			50 005 615
12.1990→ 01.1994→ Reference	OM 401 972, 979, 993 OM 445 930, 940 403 200 44 01 403 200 51 01 403 200 71 01			50 005 210
Series 2532				894
01.1994→ Reference	OM 445 929 401 180 00 01 401 180 01 01 403 180 06 01 403 180 17 01		50 005 837	
01.1994→ Reference	OM 445 929 403 200 76 01 403 200 77 01			50 005 615
01.1994→ Reference	OM 445 929 403 200 44 01 403 200 51 01 403 200 71 01			50 005 210
Series 2534				895
01.1991→ 01.1994→ Reference	OM 441 960, 986-987, 989 OM 445 920-921, 939-940 401 180 00 01 401 180 01 01 403 180 06 01 403 180 17 01		50 005 837	
01.1991→ 01.1994→ Reference	OM 441 960, 986-987, 989 OM 445 920-921, 939-940 403 200 76 01 403 200 77 01			50 005 615
01.1991→ 01.1994→ Reference	OM 441 960, 986-987, 989 OM 445 920-921, 939-940 403 200 44 01 403 200 51 01 403 200 71 01			50 005 210
Series 2535				896
1985 →02.1991 Reference	OM 442 952, 962 403 180 33 01 423 180 01 01 423 180 05 01		50 005 834	
1985 →02.1991 Reference	OM 442 952, 962 403 200 76 01 403 200 77 01			50 005 615

M



				
1985 →02.1991 Reference	OM 442 403 200 44 01	952, 962 403 200 51 01	403 200 71 01	 50 005 210
Series 2536				897
01.1986→12.1992 1985 →02.1991 Reference	OM 423 OM 442 403 180 33 01	907 950, 952, 962 423 180 01 01	423 180 05 01	 50 005 834
01.1986→12.1992 1985 →02.1991 Reference	OM 423 OM 442 403 200 76 01	907 950, 952, 962 403 200 77 01		 50 005 615
01.1986→12.1992 1985 →02.1991 Reference	OM 423 OM 442 403 200 44 01	907 950, 952, 962 403 200 51 01	403 200 71 01	 50 005 210
Series 2538				898
03.1991→ 03.1991→02.2001 06.1995→ Reference	OM 402 OM 440 OM 446 403 180 33 01	971-972, 975, 985-986, 989-990, 996 978-979, 982, 986 920, 924-925, 928-929, 935-936, 942, 948 423 180 01 01	423 180 05 01	 50 005 834
03.1991→ 03.1991→02.2001 06.1995→ Reference	OM 402 OM 440 OM 446 403 200 76 01	971-972, 975, 985-986, 989-990, 996 978-979, 982, 986 920, 924-925, 928-929, 935-936, 942, 948 403 200 77 01		 50 005 615
03.1991→ 03.1991→02.2001 06.1995→ Reference	OM 402 OM 440 OM 446 403 200 44 01	971-972, 975, 985-986, 989-990, 996 978-979, 982, 986 920, 924-925, 928-929, 935-936, 942, 948 403 200 51 01	403 200 71 01	 50 005 210
Series 2539				899
1985 →02.1991 Reference	OM 442 403 180 33 01	966 423 180 01 01	423 180 05 01	 50 005 834
1985 →02.1991 Reference	OM 442 403 200 76 01	966 403 200 77 01		 50 005 615
1985 →02.1991 Reference	OM 442 403 200 44 01	966 403 200 51 01	403 200 71 01	 50 005 210

M



Series 2540

900

Reference	OM 402 971 403 180 33 01 423 180 01 01 423 180 05 01		50 005 834	
Reference	OM 402 971 403 200 76 01 403 200 77 01			50 005 615
Reference	OM 402 971 403 200 44 01 403 200 51 01 403 200 71 01			50 005 210

Series 2544

901

03.1991→ 12.1991→ 07.1995→ 01.1996→ Reference	OM 402 996 OM 440 970, 972, 978-982 OM 442 997 OM 446 920, 922, 946 403 180 33 01 423 180 01 01 423 180 05 01		50 005 834	
03.1991→ 12.1991→ 07.1995→ 01.1996→ Reference	OM 402 996 OM 440 970, 972, 978-982 OM 442 997 OM 446 920, 922, 946 403 200 76 01 403 200 77 01			50 005 615
03.1991→ 12.1991→ 07.1995→ 01.1996→ Reference	OM 402 996 OM 440 970, 972, 978-982 OM 442 997 OM 446 920, 922, 946 403 200 44 01 403 200 51 01 403 200 71 01			50 005 210

M

Series 2545

902

07.1987→ Reference	OM 462 900 511 (AFS) 403 180 33 01 423 180 01 01 423 180 05 01		50 005 834	
-----------------------	---	--	------------	--

Series 2550



903

07.1995→ 1985 → 01.1996→ Reference	OM 440 971, 973 OM 442 985, 989, 997-998 OM 446 920 403 180 33 01 423 180 01 01 423 180 05 01		50 005 834	
07.1995→ 1985 → 01.1996→ Reference	OM 440 971, 973 OM 442 985, 989, 997-998 OM 446 920 403 200 76 01 403 200 77 01			50 005 615
07.1995→ 1985 → 01.1996→ Reference	OM 440 971, 973 OM 442 985, 989, 997-998 OM 446 920 403 200 44 01 403 200 51 01 403 200 71 01			50 005 210



Series 2553

904

01.1994→ Reference	OM 446 920, 927, 945 403 180 33 01 423 180 01 01 423 180 05 01		50 005 834	
01.1994→ Reference	OM 446 920, 927, 945 403 200 76 01 403 200 77 01			50 005 615
01.1994→ Reference	OM 446 920, 927, 945 403 200 44 01 403 200 51 01 403 200 71 01			50 005 210





Series 2622

905

05.1982→ Reference	OM 421 905 403 200 76 01 403 200 77 01			50 005 615
05.1982→ Reference	OM 421 905 OM 481 902 (TUR) 403 200 44 01 403 200 51 01 403 200 71 01			50 005 210

Series 2624

906

1967 → Reference	OM 355 910, 912, 960, 963, 975-976, 981-982 (SUI), 983-984 355 180 01 01		50 005 829	
03.1991→ Reference	OM 401 975, 978 OM 407 930 (AFS), 932 (AFS) OM 496 900 001 (AFS), 900 003 (AFS), 900 026 (AFS), 900 027 (AFS) 401 180 00 01 401 180 01 01 403 180 06 01 403 180 17 01		50 005 837	
03.1991→ Reference	OM 401 975, 978 403 200 76 01 403 200 77 01			50 005 615
Reference	OM 407 930 (AFS), 932 (AFS) 403 200 27 01 403 200 32 01 403 200 34 01 403 200 35 01 403 200 49 01 403 200 70 01			50 005 207

M



MERCEDES-BENZ

09.1969→ Reference	OM 355 355 200 01 01 355 200 09 01	960, 963, 975-976, 981-982 (SUI), 983-984 355 200 05 01 355 200 11 01	355 200 06 01 355 200 15 01	355 200 08 01		50 005 211		
		wartungsfrei maintenance-free sans entretien sin necesidad de mantenimiento не нуждающийся в обслуживании						
03.1991→ Reference	OM 401 OM 407	975, 978 930 (AFS), 932 (AFS)	403 200 44 01	403 200 51 01	403 200 71 01		50 005 210	
Series 2626							907	
04.1972→1985 Reference	OM 402 401 180 00 01	906, 912, 916, 925-926 401 180 01 01	403 180 06 01	403 180 17 01		50 005 837		
04.1972→1985 Reference	OM 402 403 200 76 01	906, 912, 916, 925-926 403 200 77 01				50 005 615		
04.1972→1985 Reference	OM 402 403 200 27 01 403 200 49 01	906, 912, 916, 925-926 403 200 32 01 403 200 70 01	403 200 34 01	403 200 35 01		50 005 207		
04.1972→1985 Reference	OM 402 403 200 44 01	906, 912, 916, 925-926 403 200 51 01	403 200 71 01			50 005 210		
Series 2627							908	
03.1991→ Reference	OM 401 401 180 00 01	975, 978 401 180 01 01	403 180 06 01	403 180 17 01		50 005 837		
03.1991→ Reference	OM 401 403 200 76 01	975, 978 403 200 77 01				50 005 615		
03.1991→ Reference	OM 401 403 200 44 01	975, 978 403 200 51 01	403 200 71 01			50 005 210		
Series 2628							909	
1981 → 1985 →02.1991 Reference	OM 423 OM 442 403 180 33 01	908 950, 952, 962 423 180 01 01	423 180 05 01			50 005 834		

M



















1979 → 1988 →	OM 407 OM 422 OM 442 OM 482 OM 492 OM 496	952-953 (AFS), 956 (AFS) 905, 907, 911, 913, 922 908 912 (TUR) 900 002 (AFS) 900 401 (AFS), 900 402 (AFS), 900 426 (AFS)		50 005 837
Reference	401 180 00 01	401 180 01 01	403 180 06 01	403 180 17 01
1979 → 1981 → 1985 →02.1991	OM 422 OM 423 OM 442	905, 907, 911, 913, 922 908 950, 952, 962		50 005 615
Reference	403 200 76 01	403 200 77 01		
1988 →	OM 442	908		50 005 616
Reference	441 200 01 01	441 200 02 01		
10.1979 →	OM 407	952-953 (AFS)		50 005 207
Reference	403 200 27 01 403 200 49 01	403 200 32 01 403 200 70 01	403 200 34 01	403 200 35 01
11.1978 →02.2001	OM 355	969		50 005 211
Reference	355 200 01 01 355 200 09 01	355 200 05 01 355 200 11 01	355 200 06 01 355 200 15 01	355 200 08 01
	wartungsfrei maintenance-free sans entretien sin necesidad de mantenimiento не нуждающийся в обслуживании			
1979 → 1981 → 1985 →	OM 407 OM 422 OM 423 OM 442	952-953 (AFS), 956 (AFS) 905, 907, 911, 913, 922 908 908, 950, 952, 962		50 005 210
Reference	403 200 44 01	403 200 51 01	403 200 71 01	
Series 2629				910
1985 →02.1991 01.1996 →	OM 442 OM 446	942, 959, 966 933		50 005 834
Reference	403 180 33 01	423 180 01 01	423 180 05 01	
03.1992 → 07.1988 →08.1994	OM 401 OM 442 OM 462	979 906-907, 917, 925-926, 929 900 011 (AFS)		50 005 837
Reference	401 180 00 01	401 180 01 01	403 180 06 01	403 180 17 01
03.1992 → 1985 →02.1991 01.1996 →	OM 401 OM 442 OM 446	979 942, 959, 966 933		50 005 615
Reference	403 200 76 01	403 200 77 01		
07.1988 →08.1994	OM 442	906-907, 917, 925-926, 929		50 005 616
Reference	441 200 01 01	441 200 02 01		

M



MERCEDES-BENZ

				
03.1992→ 1985 →08.1994 01.1996→ Reference	OM 401 979 OM 442 906-907, 917, 942, 959, 966 OM 446 933 403 200 44 01 403 200 51 01 403 200 71 01			50 005 210
Series 2631				911
06.1992→ 07.1995→ 01.1994→ Reference	OM 401 972, 979, 981, 986-987, 993 OM 441 997 OM 445 929-931 401 180 00 01 401 180 01 01 403 180 06 01 403 180 17 01		50 005 837	
06.1992→ 07.1995→ 01.1994→ Reference	OM 401 972, 979, 981, 986-987, 993 OM 441 997 OM 445 929-931 403 200 76 01 403 200 77 01			50 005 615
06.1992→ 07.1995→ 01.1994→ Reference	OM 401 972, 979, 981, 986-987, 993 OM 441 997 OM 445 929-931 403 200 44 01 403 200 51 01 403 200 71 01			50 005 210
Series 2632				912
08.1973→09.1983 Reference 	OM 403 916, 931-933, 935 403 180 33 01 423 180 01 01 423 180 05 01 121800→		50 005 834	
08.1973→09.1983 Reference 	OM 403 916, 931-933, 935 OM 407 954 (AFS) OM 496 900 501 (AFS) 401 180 00 01 401 180 01 01 403 180 06 01 403 180 17 01 OM 403.916, OM 403.931, OM 403.932, OM 403.933, OM 403.935: →121799		50 005 837	
08.1973→09.1983 Reference	OM 403 916, 931-933, 935 403 200 76 01 403 200 77 01			50 005 615
08.1973→09.1983 Reference	OM 403 916, 931-933, 935 OM 407 954 (AFS) 403 200 27 01 403 200 32 01 403 200 34 01 403 200 35 01 403 200 49 01 403 200 70 01			50 005 207
08.1973→09.1983 Reference	OM 403 916, 931-933, 935 OM 407 954 (AFS) 403 200 44 01 403 200 51 01 403 200 71 01			50 005 210
Series 2633				913
05.1982→05.1987 10.1984→ Reference	OM 422 952, 954, 956 OM 492 900 406 (AFS) 403 180 33 01 423 180 01 01 423 180 05 01		50 005 834	

M



05.1982→05.1987 Reference	OM 422 403 200 76 01	952, 954, 956 403 200 77 01		50 005 615
05.1982→05.1987 Reference	OM 422 403 200 44 01	952, 954, 956 403 200 51 01 403 200 71 01		50 005 210
Series 2634				914
07.1995→ 01.1994→ Reference	OM 441 OM 445 401 180 00 01	986, 989 920 401 180 01 01 403 180 06 01 403 180 17 01		50 005 837
07.1995→ 01.1994→ Reference	OM 441 OM 445 403 200 76 01	986, 989 920 403 200 77 01		50 005 615
07.1995→ 01.1994→ Reference	OM 441 OM 445 403 200 44 01	986, 989 920 403 200 51 01 403 200 71 01		50 005 210
Series 2635				915
07.1991→ 07.1991→ 04.1986→ 12.1991→ Reference	OM 402 OM 440 OM 442 OM 482 403 180 33 01	971 940-942, 973 942, 944, 950, 952, 959, 962, 964, 966, 971-972, 978 940 (TUR) 423 180 01 01 423 180 05 01		50 005 834
01.1980→06.1989 07.1988→08.1994 Reference	OM 422 OM 442 OM 476 401 180 00 01	916 909 983 (BRA) 401 180 01 01 403 180 06 01 403 180 17 01		50 005 837
07.1991→ 01.1980→06.1989 07.1991→ 04.1986→ Reference	OM 402 OM 422 OM 440 OM 442 403 200 76 01	971 916 940-942, 973 942, 944, 950, 952, 959, 962, 964, 966, 971-972, 978 403 200 77 01		50 005 615
07.1988→08.1994 Reference	OM 442 441 200 01 01	909 441 200 02 01		50 005 616
07.1991→ 01.1980→06.1989 07.1991→ 04.1986→ Reference	OM 402 OM 422 OM 440 OM 442 403 200 44 01	971 916 940-942, 973 909, 942, 944, 950, 952, 959, 962, 964, 966, 971-972, 978 403 200 51 01 403 200 71 01		50 005 210

M

**Series 2636****916**

1989 →02.1991 OM 443 980
Reference 422 200 05 01 422 200 10 01

**50 005 205**

11.1981 →03.1991 OM 423 905-907
1985 →02.1991 OM 442 950, 952
OM 493 900 001 (AFS)
Reference 403 180 33 01 423 180 01 01 423 180 05 01

**50 005 834**

11.1981 →03.1991 OM 423 905-907
1985 →02.1991 OM 442 950, 952
Reference 403 200 76 01 403 200 77 01

**50 005 615**

11.1981 →03.1991 OM 423 905-907
1985 →02.1991 OM 442 950, 952
Reference 403 200 44 01 403 200 51 01 403 200 71 01

**50 005 210****Series 2637****917**

12.1991 → OM 482 941 (TUR)
Reference 403 180 33 01 423 180 01 01 423 180 05 01

**50 005 834****Series 2638****918**

03.1991 → OM 402 971-972, 974-975, 978, 984-986
01.1981 →12.1986 OM 422 953, 955
OM 440 978-979, 981, 989-990
1985 →02.1991 OM 442 950
01.1994 → OM 446 920, 924-927, 935-936
10.1984 → OM 492 900 501 (AFS)
Reference 403 180 33 01 423 180 01 01 423 180 05 01

**50 005 834**

03.1991 → OM 402 971-972, 974-975, 978, 985-986
01.1981 →12.1986 OM 422 953, 955
OM 440 978-979, 981, 989-990
1985 →02.1991 OM 442 950
01.1994 → OM 446 920, 924-927, 935-936
Reference 403 200 76 01 403 200 77 01

**50 005 615**

05.1992 → OM 402 984
Reference 403 200 53 01 403 200 73 01

**50 005 632**



03.1991 → OM 402 971-972, 974-975, 978, 985-986
01.1981 →12.1986 OM 422 953, 955
OM 440 978-979, 981, 989-990
1985 →02.1991 OM 442 950
01.1994 → OM 446 920, 924-927, 935-936
Reference 403 200 44 01 403 200 51 01 403 200 71 01

**50 005 210****M**







Series 2644

919

03.1991→ 12.1991→02.2001 10.1985→07.1992 01.1996→ 07.1987→	OM 402 996 OM 440 970, 978, 981-982 OM 442 951, 953, 980, 983 OM 446 922, 936, 946 OM 462 900 511 (AFS)			50 005 834	
Reference	403 180 33 01 423 180 01 01 423 180 05 01				
03.1991→ 12.1991→02.2001 10.1985→07.1992 01.1996→	OM 402 996 OM 440 970, 978, 981-982 OM 442 951, 953, 980, 983 OM 446 922, 936, 946				50 005 615
Reference	403 200 76 01 403 200 77 01				
03.1991→ 12.1991→02.2001 10.1985→07.1992 01.1996→	OM 402 996 OM 440 970, 978, 981-982 OM 442 951, 953, 980, 983 OM 446 922, 936, 946				50 005 210
Reference	403 200 44 01 403 200 51 01 403 200 71 01				



Series 2645

920

1989 →02.1991	OM 443 980				
Reference	422 200 05 01 422 200 10 01			50 005 205	
1985 →02.1991	OM 442 953			50 005 834	
Reference	403 180 33 01 423 180 01 01 423 180 05 01				
1985 →02.1991	OM 442 953				50 005 615
Reference	403 200 76 01 403 200 77 01				
1985 →02.1991	OM 442 953				50 005 210
Reference	403 200 44 01 403 200 51 01 403 200 71 01				

Series 2648

921

07.1995→ 12.1988→	OM 440 973 OM 442 985, 989, 992, 994, 997			50 005 834	
Reference	403 180 33 01 423 180 01 01 423 180 05 01				
07.1995→ 12.1988→	OM 440 973 OM 442 985, 989, 992, 994, 997				50 005 615
Reference	403 200 76 01 403 200 77 01				
07.1995→ 12.1988→	OM 440 973 OM 442 985, 989, 992, 994, 997				50 005 210
Reference	403 200 44 01 403 200 51 01 403 200 71 01				

M



Series 2650

922

07.1992→ 1985 →05.1998 01.1996→ Reference	OM 440 971, 973, 975, 982 OM 442 942, 985, 989, 994, 997 OM 446 920 403 180 33 01 423 180 01 01 423 180 05 01		50 005 834	
07.1992→ 1985 →05.1998 01.1996→ Reference	OM 440 971, 973, 975, 982 OM 442 942, 985, 989, 994, 997 OM 446 920 403 200 76 01 403 200 77 01			50 005 615
07.1992→ 1985 →05.1998 01.1996→ Reference	OM 440 971, 973, 975, 982 OM 442 942, 985, 989, 994, 997 OM 446 920 403 200 44 01 403 200 51 01 403 200 71 01			50 005 210

Series 2653

923

07.1995→06.1995 01.1996→ Reference	OM 440 979, 981-982 OM 446 920, 933, 936, 945-946 403 180 33 01 423 180 01 01 423 180 05 01		50 005 834	
07.1995→06.1995 01.1996→ Reference	OM 440 979, 981-982 OM 446 920, 933, 936, 945-946 403 200 76 01 403 200 77 01			50 005 615
07.1995→06.1995 01.1996→ Reference	OM 440 979, 981-982 OM 446 920, 933, 936, 945-946 403 200 44 01 403 200 51 01 403 200 71 01			50 005 210

Series 2822

924

05.1982→ Reference	OM 421 905 403 200 76 01 403 200 77 01			50 005 615
05.1982→ Reference	OM 421 905 403 200 44 01 403 200 51 01 403 200 71 01			50 005 210

Series 2825

925





05.1982→ Reference	OM 421 905 403 200 76 01 403 200 77 01			50 005 615
05.1982→ Reference	OM 421 905 403 200 44 01 403 200 51 01 403 200 71 01			50 005 210

M





Series 2828

926

1981 → Reference	OM 423 908 403 180 33 01 423 180 01 01 423 180 05 01		50 005 834
1979 → Reference	OM 422 911, 913 401 180 00 01 401 180 01 01 403 180 06 01 403 180 17 01		50 005 837
05.1982 → 1979 → 1981 → Reference	OM 421 905 OM 422 911, 913 OM 423 908 403 200 76 01 403 200 77 01		50 005 615
2000 → Reference	OM 906 953 904 200 04 01 904 200 06 01 904 200 08 01 904 200 20 01 904 200 22 01 904 200 26 01 904 200 49 01 904 201 02 01 904 201 07 01		50 005 627
05.1982 → 1979 → 1981 → Reference	OM 421 905 OM 422 911, 913 OM 423 908 403 200 44 01 403 200 51 01 403 200 71 01		50 005 210



Series 2833

927

04.1984 → Reference	OM 422 954 403 180 33 01 423 180 01 01 423 180 05 01		50 005 834
04.1984 → Reference	OM 422 954 403 200 76 01 403 200 77 01		50 005 615
04.1984 → Reference	OM 422 954 403 200 44 01 403 200 51 01 403 200 71 01		50 005 210

Series 3025

928

12.1985 → 07.1987 Reference	OM 422 909, 912, 920 401 180 00 01 401 180 01 01 403 180 06 01 403 180 17 01		50 005 837
12.1985 → 07.1987 Reference	OM 422 909, 912, 920 403 200 76 01 403 200 77 01		50 005 615
12.1985 → 07.1987 Reference	OM 422 909, 912, 920 403 200 44 01 403 200 51 01 403 200 71 01		50 005 210

M

**Series 3028****929**

1981 →
1985 →02.1991
Reference

OM 423 908
OM 442 950, 952
403 180 33 01 423 180 01 01 423 180 05 01

**50 005 834**

12.1985→03.1991
01.1989→02.1991
Reference

OM 422 911, 913, 919, 921
OM 441 951
401 180 00 01 401 180 01 01 403 180 06 01 403 180 17 01

**50 005 837**

12.1985→03.1991
1981 →
01.1989→02.1991
1985 →02.1991
Reference

OM 422 911, 913, 919, 921
OM 423 908
OM 441 951
OM 442 950, 952
403 200 76 01 403 200 77 01

**50 005 615**

12.1985→03.1991
1981 →
01.1989→02.1991
1985 →02.1991
Reference

OM 422 911, 913, 919, 921
OM 423 908
OM 441 951
OM 442 950, 952
403 200 44 01 403 200 51 01 403 200 71 01

**50 005 210****Series 3031****930**

03.1991→
Reference

OM 401 979
401 180 00 01 401 180 01 01 403 180 06 01 403 180 17 01

**50 005 837**

03.1991→
Reference

OM 401 979
403 200 76 01 403 200 77 01

**50 005 615**

03.1991→
Reference

OM 401 979
403 200 44 01 403 200 51 01 403 200 71 01

**50 005 210****Series 3033****931**

04.1984→
Reference

OM 422 954
403 180 33 01 423 180 01 01 423 180 05 01

**50 005 834**

04.1984→
Reference

OM 422 954
403 200 76 01 403 200 77 01

**50 005 615**

04.1984→
Reference





OM 422 954
403 200 44 01 403 200 51 01 403 200 71 01

**50 005 210****M**







Series 3035

932

1985 →02.1991 Reference	OM 442 952 403 180 33 01 423 180 01 01 423 180 05 01		50 005 834
01.1980→06.1989 Reference	OM 422 916 401 180 00 01 401 180 01 01 403 180 06 01 403 180 17 01		50 005 837
01.1980→06.1989 1985 →02.1991 Reference	OM 422 916 OM 442 952 403 200 76 01 403 200 77 01		50 005 615
01.1980→06.1989 1985 →02.1991 Reference	OM 422 916 OM 442 952 403 200 44 01 403 200 51 01 403 200 71 01		50 005 210



Series 3036

933

10.1989→02.1991 Reference	OM 443 980 422 200 05 01 422 200 10 01		50 005 205
1981 → 1985 →02.1991 Reference	OM 423 907 OM 442 950, 952 403 180 33 01 423 180 01 01 423 180 05 01		50 005 834
1981 → 1985 →02.1991 Reference	OM 423 907 OM 442 950, 952 403 200 76 01 403 200 77 01		50 005 615
1981 → 1985 →02.1991 Reference	OM 423 907 OM 442 950, 952 403 200 44 01 403 200 51 01 403 200 71 01		50 005 210

Series 3038

934

11.1980→12.1986 Reference	OM 422 959 403 180 33 01 423 180 01 01 423 180 05 01		50 005 834
11.1980→12.1986 Reference	OM 422 959 403 200 76 01 403 200 77 01		50 005 615

M



MERCEDES-BENZ

11.1980→12.1986 Reference	OM 422 959 403 200 44 01	403 200 51 01	403 200 71 01			50 005 210
Series 3050						935
07.1995→05.1998 1985→05.1998 01.1996→ Reference	OM 440 976 OM 442 989, 997 OM 446 932-933 403 180 33 01	423 180 01 01	423 180 05 01		50 005 834	
07.1995→05.1998 1985→05.1998 01.1996→ Reference	OM 440 976 OM 442 989, 997 OM 446 932-933 403 200 76 01	403 200 77 01				50 005 615
07.1995→05.1998 1985→05.1998 01.1996→ Reference	OM 440 976 OM 442 989, 997 OM 446 932-933 403 200 44 01	403 200 51 01	403 200 71 01			50 005 210
Series 3053						936
07.1995→05.1998 Reference	OM 440 976 403 180 33 01	423 180 01 01	423 180 05 01		50 005 834	
07.1995→05.1998 Reference	OM 440 976 403 200 76 01	403 200 77 01				50 005 615
07.1995→05.1998 Reference	OM 440 976 403 200 44 01	403 200 51 01	403 200 71 01			50 005 210
Series 3228						937
1981 → 1988 → Reference	OM 423 908 OM 442 950, 952 403 180 33 01	423 180 01 01	423 180 05 01		50 005 834	
07.1987→03.1991 01.1989→ Reference	OM 422 911, 913, 919, 921 OM 441 951, 960 401 180 00 01	401 180 01 01	403 180 06 01 403 180 17 01		50 005 837	
07.1987→03.1991 1981 → 01.1989→ 1988 → Reference	OM 422 911, 913, 919, 921 OM 423 908 OM 441 951, 960 OM 442 950, 952 403 200 76 01	403 200 77 01				50 005 615

M





07.1987→03.1991 1981 → 01.1989→ 1988 → Reference	OM 422 OM 423 OM 441 OM 442 403 200 44 01	911, 913, 919, 921 908 951, 960 950, 952 403 200 51 01	403 200 71 01	 50 005 210
Series 3229				938
07.1988→ Reference	OM 442 401 180 00 01	915-916, 923, 927-928 401 180 01 01	403 180 06 01 403 180 17 01	 50 005 837
07.1988→ Reference	OM 442 441 200 01 01	915-916, 923, 927-928 441 200 02 01		 50 005 616
07.1988→ Reference	OM 442 403 200 44 01	915-916, 923 403 200 51 01	403 200 71 01	 50 005 210
Series 3231				939
03.1991→ Reference	OM 401 401 180 00 01	972, 979, 993 401 180 01 01	403 180 06 01 403 180 17 01	 50 005 837
03.1991→ Reference	OM 401 403 200 76 01	972, 979, 993 403 200 77 01		 50 005 615
03.1991→ Reference	OM 401 403 200 44 01	972, 979, 993 403 200 51 01	403 200 71 01	 50 005 210
Series 3233				940
10.1990→ 01.1994→ Reference	OM 441 OM 445 401 180 00 01	960, 982, 985, 988, 990, 992 922 401 180 01 01	403 180 06 01 403 180 17 01	 50 005 837
10.1990→ 01.1994→ Reference	OM 441 OM 445 403 200 76 01	960, 982, 985, 988, 990, 992 922 403 200 77 01		 50 005 615
10.1990→ 01.1994→ Reference	OM 441 OM 445 403 200 44 01	960, 982, 985, 988, 990, 992 922 403 200 51 01	403 200 71 01	 50 005 210

M







Series 3234

941

05.1989→05.1998 01.1994→	OM 441 981, 985, 988, 990, 992 OM 445 922			50 005 837	
Reference	401 180 00 01 401 180 01 01 403 180 06 01 403 180 17 01				
05.1989→05.1998 01.1994→	OM 441 981, 985, 988, 990, 992 OM 445 922				50 005 615
Reference	403 200 76 01 403 200 77 01				
05.1989→05.1998 01.1994→	OM 441 981, 985, 988, 990, 992 OM 445 922				50 005 210
Reference	403 200 44 01 403 200 51 01 403 200 71 01				

Series 3235



942

09.1982→03.1991 07.1987→09.1993	OM 402 983 OM 423 905 OM 442 944-945, 950, 952, 959, 966, 971			50 005 834	
Reference	403 180 33 01 423 180 01 01 423 180 05 01				
01.1980→06.1989 07.1987→01.1989	OM 422 916 OM 441 951			50 005 837	
Reference	401 180 00 01 401 180 01 01 403 180 06 01 403 180 17 01				
01.1980→06.1989 09.1982→03.1991 07.1987→01.1989 07.1987→09.1993	OM 402 983 OM 422 916 OM 423 905 OM 441 951 OM 442 944-945, 950, 952, 959, 966, 971				50 005 615
Reference	403 200 76 01 403 200 77 01				
01.1980→06.1989 09.1982→03.1991 07.1987→01.1989 07.1987→09.1993	OM 402 983 OM 422 916 OM 423 905 OM 441 951 OM 442 944-945, 950, 952, 959, 966, 971				50 005 210
Reference	403 200 44 01 403 200 51 01 403 200 71 01				

M

Series 3238

943

10.1990→ 07.1995→06.1995 1988 →02.1991 06.1995→	OM 402 971, 973, 977, 982, 985, 987 OM 440 980 OM 442 950 OM 446 920, 924, 926, 939			50 005 834	
Reference	403 180 33 01 423 180 01 01 423 180 05 01				
1991 →	OM 441 960			50 005 837	
Reference	401 180 00 01 401 180 01 01 403 180 06 01 403 180 17 01				
10.1990→ 07.1995→06.1995 1991 → 1988 →02.1991 06.1995→	OM 402 971, 973, 977, 982, 985, 987 OM 440 980 OM 441 960 OM 442 950 OM 446 920, 924, 926, 939				50 005 615
Reference	403 200 76 01 403 200 77 01				



10.1990→ 07.1995→06.1995 1991→ 1988→02.1991 06.1995→ Reference	OM 402 OM 440 OM 441 OM 442 OM 446 403 200 44 01	971, 973, 977, 982, 985, 987 980 960 950 920, 924, 926, 939 403 200 51 01	403 200 71 01	 50 005 210
Series 3240				944
1985→02.1991 Reference	OM 442 403 180 33 01	989 423 180 01 01	423 180 05 01	 50 005 834
1985→02.1991 Reference	OM 442 403 200 76 01	989 403 200 77 01		 50 005 615
1985→02.1991 Reference	OM 442 403 200 44 01	989 403 200 51 01	403 200 71 01	 50 005 210
Series 3244				945
12.1990→ 07.1995→ 01.1996→ Reference	OM 440 OM 442 OM 446 403 180 33 01	970, 975, 978, 980-981 997 922 423 180 01 01	423 180 05 01	 50 005 834
12.1990→ 07.1995→ 01.1996→ Reference	OM 440 OM 442 OM 446 403 200 76 01	970, 975, 978, 980-981 997 922 403 200 77 01		 50 005 615
12.1990→ 07.1995→ 01.1996→ Reference	OM 440 OM 442 OM 446 403 200 44 01	970, 975, 978, 980-981 997 922 403 200 51 01	403 200 71 01	 50 005 210
Series 3248				946
1985→02.1991 Reference	OM 442 403 180 33 01	985 423 180 01 01	423 180 05 01	 50 005 834
1985→02.1991 Reference	OM 442 403 200 76 01	985 403 200 77 01		 50 005 615
1985→02.1991 Reference	OM 442 403 200 44 01	985 403 200 51 01	403 200 71 01	 50 005 210

M

**Series 3250****947**

09.1985→08.1994 01.1990→09.1993 Reference	OM 423 950 OM 443 980 422 200 05 01 422 200 10 01		50 005 205
07.1995→ 1985→02.1991 Reference	OM 440 971 OM 442 985, 989 403 180 33 01 423 180 01 01 423 180 05 01		50 005 834
07.1995→ 1985→02.1991 Reference	OM 440 971 OM 442 985, 989 403 200 76 01 403 200 77 01		50 005 615
07.1995→ 1985→02.1991 Reference	OM 440 971 OM 442 985, 989 403 200 44 01 403 200 51 01 403 200 71 01		50 005 210

Series 3253**948**

















01.1996→ Reference	OM 446 920, 939, 945 403 180 33 01 423 180 01 01 423 180 05 01		50 005 834
01.1996→ Reference	OM 446 920, 939, 945 403 200 76 01 403 200 77 01		50 005 615
01.1996→ Reference	OM 446 920, 939, 945 403 200 44 01 403 200 51 01 403 200 71 01		50 005 210

Series 3328**949**

1981 → 1985 →1996 Reference	OM 423 908 OM 442 950, 952, 962 403 180 33 01 423 180 01 01 423 180 05 01		50 005 834
01.1980→03.1991 1988 → Reference	OM 422 911, 913-914, 916, 919, 921 OM 442 905 401 180 00 01 401 180 01 01 403 180 06 01 403 180 17 01		50 005 837
01.1980→03.1991 1981 → 1985 →1996 Reference	OM 422 911, 913-914, 916, 919, 921 OM 423 908 OM 442 950, 952, 962 403 200 76 01 403 200 77 01		50 005 615

M



				
1988 → Reference	OM 442 905 441 200 01 01 441 200 02 01			50 005 616
01.1980→03.1991 1981 → 1985 → Reference	OM 422 911, 913-914, 916, 919, 921 OM 423 908 OM 442 905, 950, 952, 962 403 200 44 01 403 200 51 01 403 200 71 01			50 005 210
Series 3332				950
08.1973→09.1983 Reference 	OM 403 931-932 403 180 33 01 423 180 01 01 423 180 05 01 121800→			50 005 834
08.1973→09.1983 Reference 	OM 403 931-932 401 180 00 01 401 180 01 01 403 180 06 01 403 180 17 01 →121799			50 005 837
08.1973→09.1983 Reference	OM 403 931-932 403 200 76 01 403 200 77 01			50 005 615
08.1973→09.1983 Reference	OM 403 931-932 403 200 27 01 403 200 32 01 403 200 34 01 403 200 35 01 403 200 49 01 403 200 70 01			50 005 207
08.1973→09.1983 Reference	OM 403 931-932 403 200 44 01 403 200 51 01 403 200 71 01			50 005 210
Series 3333				951
12.1982→11.1991 Reference	OM 422 954, 957 403 180 33 01 423 180 01 01 423 180 05 01			50 005 834
12.1982→11.1991 Reference	OM 422 954, 957 403 200 76 01 403 200 77 01			50 005 615
12.1982→11.1991 Reference	OM 422 954, 957 403 200 44 01 403 200 51 01 403 200 71 01			50 005 210

M

**Series 3335****952**

1985 →02.1991 Reference	OM 442 403 180 33 01	950, 952, 962 423 180 01 01	423 180 05 01		50 005 834	
01.1980→06.1989 Reference	OM 422 401 180 00 01	916 401 180 01 01	403 180 06 01	403 180 17 01		50 005 837
01.1980→06.1989 1985 →02.1991 Reference	OM 422 403 200 76 01	916 403 200 77 01				50 005 615
01.1980→06.1989 1985 →02.1991 Reference	OM 422 403 200 44 01	916 403 200 51 01	403 200 71 01			50 005 210

Series 3336**953**















10.1989→02.1991 Reference	OM 443 422 200 05 01	980 422 200 10 01				50 005 205
12.1982→11.1991 1985 →02.1991 Reference	OM 423 403 180 33 01	905-907 423 180 01 01	423 180 05 01			50 005 834
12.1982→11.1991 1985 →02.1991 Reference	OM 423 403 200 76 01	905-907 403 200 77 01				50 005 615
12.1982→11.1991 1985 →02.1991 Reference	OM 423 403 200 44 01	905-907 403 200 51 01	403 200 71 01			50 005 210

Series 3338**954**

01.1980→ 1985 →02.1991 Reference	OM 422 403 180 33 01	955 423 180 01 01	423 180 05 01			50 005 834
01.1980→ 1985 →02.1991 Reference	OM 422 403 200 76 01	955 403 200 77 01				50 005 615

M



				
01.1980 → 1985 →02.1991 Reference	OM 422 955 OM 442 950 403 200 44 01 403 200 51 01 403 200 71 01			50 005 210
Series 3344				955
1985 →02.1991 Reference	OM 442 951, 953 403 180 33 01 423 180 01 01 423 180 05 01		50 005 834	
1985 →02.1991 Reference	OM 442 951, 953 403 200 76 01 403 200 77 01			50 005 615
1985 →02.1991 Reference	OM 442 951, 953 403 200 44 01 403 200 51 01 403 200 71 01			50 005 210
Series 3528				956
1981 → 1985 →1996 Reference	OM 423 908 OM 442 950, 952, 962 403 180 33 01 423 180 01 01 423 180 05 01		50 005 834	
07.1987 →09.1989 1988 → Reference	OM 422 911, 913, 919 OM 442 905 401 180 00 01 401 180 01 01 403 180 06 01 403 180 17 01		50 005 837	
07.1987 →09.1989 1981 → 1985 →1996 Reference	OM 422 911, 913, 919 OM 423 908 OM 442 950, 952, 962 403 200 76 01 403 200 77 01			50 005 615
1988 → Reference	OM 442 905 441 200 01 01 441 200 02 01			50 005 616
07.1987 →09.1989 1981 → 1985 → Reference	OM 422 911, 913, 919 OM 423 908 OM 442 905, 950, 952, 962 403 200 44 01 403 200 51 01 403 200 71 01			50 005 210
Series 3529				957
10.1988 →02.1991 Reference	OM 442 959 403 180 33 01 423 180 01 01 423 180 05 01		50 005 834	
1988 → Reference	OM 442 907, 915 401 180 00 01 401 180 01 01 403 180 06 01 403 180 17 01		50 005 837	

M

















MERCEDES-BENZ

10.1988→02.1991 Reference	OM 442 959 403 200 76 01 403 200 77 01			50 005 615
1988 → Reference	OM 442 907, 915 441 200 01 01 441 200 02 01			50 005 616
1988 → Reference	OM 442 907, 915, 959 403 200 44 01 403 200 51 01 403 200 71 01			50 005 210
Series 3534				958
05.1989→ 01.1994→ Reference	OM 441 981, 988 OM 445 922 401 180 00 01 401 180 01 01 403 180 06 01 403 180 17 01		50 005 837	
05.1989→ 01.1994→ Reference	OM 441 981, 988 OM 445 922 403 200 76 01 403 200 77 01			50 005 615
05.1989→ 01.1994→ Reference	OM 441 981, 988 OM 445 922 403 200 44 01 403 200 51 01 403 200 71 01			50 005 210
Series 3535				959
1991 → 1985 →08.1994 Reference	OM 402 983 OM 442 942, 944-946, 950, 952, 957, 959, 962, 966, 989 403 180 33 01 423 180 01 01 423 180 05 01		50 005 834	
1988 → Reference	OM 442 905, 909 401 180 00 01 401 180 01 01 403 180 06 01 403 180 17 01		50 005 837	
1991 → 1985 →08.1994 Reference	OM 402 983 OM 442 942, 944-946, 950, 952, 957, 959, 962, 966, 989 403 200 76 01 403 200 77 01			50 005 615
1988 → Reference	OM 442 905, 909 441 200 01 01 441 200 02 01			50 005 616

M



MERCEDES-BENZ

				
1991 → 1985 → Reference	OM 402 983 OM 442 905, 909, 942, 944-946, 950, 952, 957, 959, 962, 966, 989 403 200 44 01 403 200 51 01 403 200 71 01			50 005 210
Series 3536				960
1989 →02.1991 Reference	OM 443 980 422 200 05 01 422 200 10 01			50 005 205
1981 → 1985 →02.1991 Reference	OM 423 906-907 OM 442 950, 952, 962 403 180 33 01 423 180 01 01 423 180 05 01		50 005 834	
1981 → 1985 →02.1991 Reference	OM 423 906-907 OM 442 950, 952, 962 403 200 76 01 403 200 77 01			50 005 615
1981 → 1985 →02.1991 Reference	OM 423 906-907 OM 442 950, 952, 962 403 200 44 01 403 200 51 01 403 200 71 01			50 005 210
Series 3538				961
10.1990 → 01.1996 → Reference	OM 402 973-974, 977-978, 982-984, 987 OM 440 975, 979-980, 982-985, 987-988 OM 446 926, 930-931, 939-941 403 180 33 01 423 180 01 01 423 180 05 01		50 005 834	
10.1990 → 01.1996 → Reference	OM 402 973-974, 977-978, 982-983, 987 OM 440 975, 979-980, 982-985, 987-988 OM 446 926, 930-931, 939-941 403 200 76 01 403 200 77 01			50 005 615
05.1992 → Reference	OM 402 984 403 200 53 01 403 200 73 01			50 005 632
10.1990 → 01.1996 → Reference	OM 402 973-974, 977-978, 982-983, 987 OM 440 975, 979-980, 982-985, 987-988 OM 446 926, 930-931, 939-941 403 200 44 01 403 200 51 01 403 200 71 01			50 005 210
Series 3544				962
1985 → 01.1996 → Reference	OM 440 970, 975, 979, 982-985, 987 OM 442 951, 953, 980 OM 446 920, 939, 945 403 180 33 01 423 180 01 01 423 180 05 01		50 005 834	

M



MERCEDES-BENZ

1985 → 01.1996 → Reference	OM 440 OM 442 OM 446 403 200 76 01	970, 975, 979, 982-985, 987 951, 953, 980 920, 939, 945 403 200 77 01		50 005 615
1985 → 01.1996 → Reference	OM 440 OM 442 OM 446 403 200 44 01	970, 975, 979, 982-985, 987 951, 953, 980 920, 939, 945 403 200 51 01 403 200 71 01		50 005 210
Series 3548				963
1985 →02.1991 01.1996 → Reference	OM 442 OM 446 403 180 33 01	945, 985 932 423 180 01 01 423 180 05 01		50 005 834
1985 →02.1991 01.1996 → Reference	OM 442 OM 446 403 200 76 01	945, 985 932 403 200 77 01		50 005 615
1985 →02.1991 01.1996 → Reference	OM 442 OM 446 403 200 44 01	945, 985 932 403 200 51 01 403 200 71 01		50 005 210
Series 3550				964
1985 → 01.1996 → Reference	OM 440 OM 442 OM 446 403 180 33 01	971, 975-976, 983, 987 989, 993, 997, 999 932 423 180 01 01 423 180 05 01		50 005 834
1985 → 01.1996 → Reference	OM 440 OM 442 OM 446 403 200 76 01	971, 975-976, 983, 987 989, 993, 997, 999 932 403 200 77 01		50 005 615
1985 → 01.1996 → Reference	OM 440 OM 442 OM 446 403 200 44 01	971, 975-976, 983, 987 989, 993, 997, 999 932 403 200 51 01 403 200 71 01		50 005 210
Series 3553				965
07.1995 →05.1998 01.1996 → Reference	OM 440 OM 446 403 180 33 01	976, 983 920, 932, 939, 945 423 180 01 01 423 180 05 01		50 005 834
07.1995 →05.1998 01.1996 → Reference	OM 440 OM 446 403 200 76 01	976, 983 920, 932, 939, 945 403 200 77 01		50 005 615















M



07.1995→05.1998 01.1996→ Reference	OM 440 976, 983 OM 446 920, 932, 939, 945 403 200 44 01 403 200 51 01 403 200 71 01			50 005 210
Series 3636				966
1981 → 1985 →02.1991 Reference	OM 423 906-907 OM 442 952 403 180 33 01 423 180 01 01 423 180 05 01		50 005 834	
1981 → 1985 →02.1991 Reference	OM 423 906-907 OM 442 952 403 200 76 01 403 200 77 01			50 005 615
1981 → 1985 →02.1991 Reference	OM 423 906-907 OM 442 952 403 200 44 01 403 200 51 01 403 200 71 01			50 005 210
Series 3820				967
09.1985→09.1994 Reference	OM 423 950 422 200 05 01 422 200 10 01			50 005 205
Series 3833				968
12.1982→11.1991 Reference	OM 422 957 403 180 33 01 423 180 01 01 423 180 05 01		50 005 834	
12.1982→11.1991 Reference	OM 422 957 403 200 76 01 403 200 77 01			50 005 615
12.1982→11.1991 Reference	OM 422 957 403 200 44 01 403 200 51 01 403 200 71 01			50 005 210
Series 3835				969
10.1989→02.1991 Reference	OM 442 952 403 180 33 01 423 180 01 01 423 180 05 01		50 005 834	
10.1989→02.1991 Reference	OM 442 952 403 200 76 01 403 200 77 01			50 005 615















M



					
10.1989→02.1991 Reference	OM 442 952 403 200 44 01	403 200 51 01	403 200 71 01		50 005 210
Series 3836					970
1981 → Reference	OM 423 907 403 180 33 01	423 180 01 01	423 180 05 01		50 005 834
1981 → Reference	OM 423 907 403 200 76 01	403 200 77 01			50 005 615
1981 → Reference	OM 423 907 403 200 44 01	403 200 51 01	403 200 71 01		50 005 210
Series 3850					971
09.1985→08.1994 Reference	OM 423 950 422 200 05 01	422 200 10 01			50 005 205
Series 4044					972
1985 →02.1991 Reference	OM 442 951, 953 403 180 33 01	423 180 01 01	423 180 05 01		50 005 834
1985 →02.1991 Reference	OM 442 951, 953 403 200 76 01	403 200 77 01			50 005 615
1985 →02.1991 Reference	OM 442 951, 953 403 200 44 01	403 200 51 01	403 200 71 01		50 005 210
Series 4050					973
01.1984→ Reference	OM 423 950 422 200 05 01	422 200 10 01			50 005 205
07.1995→05.1998 Reference	OM 440 975 403 180 33 01	423 180 01 01	423 180 05 01		50 005 834

M



				
07.1995→05.1998 Reference	OM 440 975 403 200 76 01 403 200 77 01			50 005 615
07.1995→05.1998 Reference	OM 440 975 403 200 44 01 403 200 51 01 403 200 71 01			50 005 210
Series 4150				974
12.1990→02.2001 Reference	OM 440 978, 981 403 180 33 01 423 180 01 01 423 180 05 01		50 005 834	
12.1990→02.2001 Reference	OM 440 978, 981 403 200 76 01 403 200 77 01			50 005 615
12.1990→02.2001 Reference	OM 440 978, 981 403 200 44 01 403 200 51 01 403 200 71 01			50 005 210
Series 4435				975
1985 →02.2001 Reference	OM 442 944-945, 950, 952, 962, 966 403 180 33 01 423 180 01 01 423 180 05 01		50 005 834	
1985 →02.2001 Reference	OM 442 944-945, 950, 952, 962, 966 403 200 76 01 403 200 77 01			50 005 615
1985 →02.2001 Reference	OM 442 944-945, 950, 952, 962, 966 403 200 44 01 403 200 51 01 403 200 71 01			50 005 210
Series 4436				976
10.1989→02.2001 Reference	OM 443 980 422 200 05 01 422 200 10 01			50 005 205
1981 → 1985 →02.2001 Reference	OM 423 906-907 OM 442 950, 952, 962 403 180 33 01 423 180 01 01 423 180 05 01		50 005 834	

M



1981 → 1985 →02.2001 Reference	OM 423 906-907 OM 442 950, 952, 962 403 200 76 01 403 200 77 01			50 005 615
1981 → 1985 →02.2001 Reference	OM 423 906-907 OM 442 950, 952, 962 403 200 44 01 403 200 51 01 403 200 71 01			50 005 210
Series 4445				977
10.1989→02.1991 Reference	OM 442 962 403 180 33 01 423 180 01 01 423 180 05 01		50 005 834	
10.1989→02.1991 Reference	OM 442 962 403 200 76 01 403 200 77 01			50 005 615
10.1989→02.1991 Reference	OM 442 962 403 200 44 01 403 200 51 01 403 200 71 01			50 005 210
Series 4635				978
10.1989→02.2001 Reference	OM 442 952 403 180 33 01 423 180 01 01 423 180 05 01		50 005 834	
10.1989→02.2001 Reference	OM 442 952 403 200 76 01 403 200 77 01			50 005 615
10.1989→02.2001 Reference	OM 442 952 403 200 44 01 403 200 51 01 403 200 71 01			50 005 210
Series 4645				979
1985 →02.2001 Reference	OM 442 942, 950, 952-953, 959, 962, 966 403 180 33 01 423 180 01 01 423 180 05 01		50 005 834	
1985 →02.2001 Reference	OM 442 942, 950, 952-953, 959, 962, 966 403 200 76 01 403 200 77 01			50 005 615

M



1985 → 02.2001 Reference	OM 442 403 200 44 01	942, 950, 952-953, 959, 962, 966 403 200 51 01 403 200 71 01		50 005 210
Series 4648				980
10.1989 → 02.2001 Reference	OM 442 403 180 33 01	942, 959, 966 423 180 01 01 423 180 05 01		50 005 834
10.1989 → 02.2001 Reference	OM 442 403 200 76 01	942, 959, 966 403 200 77 01		50 005 615
10.1989 → 02.2001 Reference	OM 442 403 200 44 01	942, 959, 966 403 200 51 01 403 200 71 01		50 005 210
Series 4836				981
1981 → 1985 → 02.1991 Reference	OM 423 OM 442 403 180 33 01	906-907 962 423 180 01 01 423 180 05 01		50 005 834
1981 → 1985 → 02.1991 Reference	OM 423 OM 442 403 200 76 01	906-907 962 403 200 77 01		50 005 615
1981 → 1985 → 02.1991 Reference	OM 423 OM 442 403 200 44 01	906-907 962 403 200 51 01 403 200 71 01		50 005 210
Series 4838				982
07.1995 → 06.1995 01.1996 → Reference	OM 440 OM 446 403 180 33 01	983 939 423 180 01 01 423 180 05 01		50 005 834
07.1995 → 06.1995 01.1996 → Reference	OM 440 OM 446 403 200 76 01	983 939 403 200 77 01		50 005 615
07.1995 → 06.1995 01.1996 → Reference	OM 440 OM 446 403 200 44 01	983 939 403 200 51 01 403 200 71 01		50 005 210

M



Series 4844

983

1985 →02.1991 01.1996→ Reference	OM 440 975, 979, 982, 984-985 OM 442 951, 953 OM 446 920 403 180 33 01 423 180 01 01 423 180 05 01		50 005 834	
1985 →02.1991 01.1996→ Reference	OM 440 975, 979, 982, 984-985 OM 442 951, 953 OM 446 920 403 200 76 01 403 200 77 01			50 005 615
1985 →02.1991 01.1996→ Reference	OM 440 975, 979, 982, 984-985 OM 442 951, 953 OM 446 920 403 200 44 01 403 200 51 01 403 200 71 01			50 005 210

Series 4850

984

01.1984→ Reference	OM 423 950 422 200 05 01 422 200 10 01			50 005 205
07.1995→ Reference	OM 440 971, 985 OM 442 997 403 180 33 01 423 180 01 01 423 180 05 01		50 005 834	
07.1995→ Reference	OM 440 971, 985 OM 442 997 403 200 76 01 403 200 77 01			50 005 615
07.1995→ Reference	OM 440 971, 985 OM 442 997 403 200 44 01 403 200 51 01 403 200 71 01			50 005 210

Series 4853

985

01.1996→ Reference	OM 440 975, 979, 982, 984-985 OM 446 920, 940 403 180 33 01 423 180 01 01 423 180 05 01		50 005 834	
01.1996→ Reference	OM 440 975, 979, 982, 984-985 OM 446 920, 940 403 200 76 01 403 200 77 01			50 005 615
01.1996→ Reference	OM 440 975, 979, 982, 984-985 OM 446 920, 940 403 200 44 01 403 200 51 01 403 200 71 01			50 005 210

M

**Series 4936****986**

1985 →02.1991 Reference	OM 442 952 403 180 33 01 423 180 01 01 423 180 05 01		50 005 834	
1985 →02.1991 Reference	OM 442 952 403 200 76 01 403 200 77 01			50 005 615
1985 →02.1991 Reference	OM 442 952 403 200 44 01 403 200 51 01 403 200 71 01			50 005 210

Series 5035**987**

1985 →02.1991 Reference	OM 442 942, 966 403 180 33 01 423 180 01 01 423 180 05 01		50 005 834	
1985 →02.1991 Reference	OM 442 942, 966 403 200 76 01 403 200 77 01			50 005 615
1985 →02.1991 Reference	OM 442 942, 966 403 200 44 01 403 200 51 01 403 200 71 01			50 005 210

Series 5038**988**

Reference	OM 440 985, 988 403 180 33 01 423 180 01 01 423 180 05 01		50 005 834	
Reference	OM 440 985, 988 403 200 76 01 403 200 77 01			50 005 615
Reference	OM 440 985, 988 403 200 44 01 403 200 51 01 403 200 71 01			50 005 210

Series 5248**989**

1985 →02.1991 Reference	OM 442 985 403 180 33 01 423 180 01 01 423 180 05 01		50 005 834	

M









1985 →02.1991 Reference	OM 442 985 403 200 76 01 403 200 77 01			50 005 615
1985 →02.1991 Reference	OM 442 985 403 200 44 01 403 200 51 01 403 200 71 01			50 005 210
Series 5436				990
1989 →02.1991 Reference	OM 443 980 422 200 05 01 422 200 10 01			50 005 205
1981 → 1985 →02.1992 Reference	OM 423 907 OM 442 950, 952 403 180 33 01 423 180 01 01 423 180 05 01		50 005 834	
1981 → 1985 →02.1992 Reference	OM 423 907 OM 442 950, 952 403 200 76 01 403 200 77 01			50 005 615
1981 → 1985 →02.1992 Reference	OM 423 907 OM 442 950, 952 403 200 44 01 403 200 51 01 403 200 71 01			50 005 210
Series 6036				991
10.1989→02.1991 Reference	OM 443 980 422 200 05 01 422 200 10 01			50 005 205
1981 → 1985 →02.1991 Reference	OM 423 907 OM 442 950, 952 403 180 33 01 423 180 01 01 423 180 05 01		50 005 834	
1981 → 1985 →02.1991 Reference	OM 423 907 OM 442 950, 952 403 200 76 01 403 200 77 01			50 005 615
1981 → 1985 →02.1991 Reference	OM 423 907 OM 442 950, 952 403 200 44 01 403 200 51 01 403 200 71 01			50 005 210

M



Engine

992

09.1983→06.1995 Reference	OM 601 601 200 02 20	911-912 601 200 07 20	601 200 09 20			50 005 031
Reference	OM 360 360 200 03 01	937-941, 944, 946, 948-952, 961-962, 964-965, 971-972, 982-983 360 200 09 01	360 200 37 01	360 200 45 01		50 005 203
10.1983→01.1996 Reference	OM 616 616 200 04 20	963 616 200 07 20				50 005 428
01.1996→ 06.1996→ 06.1996→ Reference	OM 521 OM 522 OM 541 OM 542 OM 941 OM 942 542 200 05 01	940 940-943, 950 920-928, 940-952 920-926, 940-945, 947 910, 920-921, 929-930, 940, 960, 970, 980-981, 990 900, 910-912, 925, 930, 960, 967, 970, 980, 990 542 200 15 01	542 200 19 01			50 005 619
04.1999→ Reference	OM 611 611 200 04 01	980 611 200 10 01				50 005 776
Reference	OM 360 360 180 06 01 360 180 20 01	910, 930, 935-944, 946, 948-952, 960-973, 975, 982-983 360 180 07 01 360 180 24 01	360 180 15 01 360 180 26 01	360 180 18 01		50 005 830
1964 →12.1992 Reference	OM 352 OM 353 OM 362 353 200 56 01	905, 907, 909, 934-935, 939, 964, 985-987, 996-998 903-904, 909-910, 915-917, 920, 935, 938, 941-946, 950-954, 963-966, 968-972, 974-975, 977-978, 981-984, 989, 991, 997 906, 909-910				50 005 618









M



	<p>M 352 921, 923-924, 929</p> <p>OM 304 900 001, 900 401</p> <p>OM 306 900 016 (ZA), 900 017 (ZA), 900 018 (ZA)</p> <p>OM 314 910, 914, 916-922, 940-951, 953-954, 956-957, 958 (TUR), 959, 960 (TUR), 961-965, 967</p> <p>OM 341 918 (AMS), 934, 938, 941</p> <p>OM 352 900 000, 900 001, 900 002, 900 003, 900 004, 900 005, 900 006, 900 007, 900 008, 900 009, 900 010, 900 011, 900 012, 900 013, 900 014, 900 015, 900 016, 900 017, 900 018, 900 019, 900 020, 900 021, 900 400, 900 410, 900 411, 900 412, 900 413, 900 414, 900 415, 900 416, 900 417, 900 418, 900 419, 900 420, 900 421, 900 422, 900 423, 900 424, 900 425, 900 426, 900 427, 900 428, 900 429, 900 430, 900-908, 910-914, 919, 930-939, 942-946, 948-950, 953-976, 978-979, 981-992, 994, 996-999</p> <p>OM 353 900-905, 907, 909-917, 922-923, 930-938, 940-946, 949-954, 957, 960-966, 968-973, 980-985, 989, 995</p> <p>OM 354 900-903, 920-926</p> <p>OM 356 901-916</p> <p>OM 364 906-909, 911-913, 916-921, 950-952, 954-959, 981-987, 989</p> <p>OM 366 905-910, 911 (TUR), 912-915, 918-919, 930-933, 935-940, 947, 949, 955, 958, 977</p> <p>OM 382 912, 916 (TUR)</p> <p>OM 394 900 005 (AFS), 900 006 (AFS), 900 007 (AFS), 900 009 (AFS)</p> <p>OM 396 900 005, 900 007, 900 008 (AFS), 900 009, 900 010, 900 011, 900 012, 900 013, 900 014, 900 015, 900 016 (AFS), 900 017, 900 020 (AFS), 900 021, 900 024, 900 026</p>			50 005 843
Reference	314 180 10 01 352 180 24 01 352 180 63 01 352 180 70 01 364 180 01 01			
03.1993→08.1995	OM 601 913			50 005 036
Reference	601 200 11 20			
	OM 423 950 OM 443 980			50 005 205
Reference	422 200 05 01 422 200 10 01			
04.1986→	OM 402 901 -504, 971-975, 977-978, 982-987, 989-990, 996			50 005 834
	OM 403 910 -000, 910 001, 910 002, 910 003, 910 004, 910 005, 910 006, 911 -000, 915-917, 919, 930-935			
	OM 422 901 400, 901 410, 901 500, 901, 952-959			
	OM 423 900 -000, 905-908			
	OM 440 940-942, 945, 948, 970-973, 975-976, 978-991			
	OM 442 901 -400, 901 404, 901 500, 901 501, 901 502, 901 504, 901 505, 901 506, 901 507, 901 508, 901 520, 941-946, 950-953, 957-959, 962-968, 969 502 (USA), 969 503 (USA), 969 504 (USA), 971-972, 976-978, 980, 982-983, 985, 989, 993-994, 997-999			
	OM 443 900 -000, 905			
	OM 446 920, 922-932, 934-936, 939-943, 945-946, 948			
	OM 462 900 410 (AFS), 900 411 (AFS), 900 414, 900 510 (AFS), 900 511 (AFS)			
	OM 463 900 010			
	OM 482 940-941 (TUR)			
	OM 492 900 405 (AFS), 900 406 (AFS), 900 409 (AFS), 900 411 (AFS), 900 501 (AFS)			
	OM 493 900 001 (AFS)			
Reference	403 180 33 01 423 180 01 01 423 180 05 01			

M



				
	<p>OM 314 900 000, 900 001, 900 002, 900 003, 900 004, 900 005, 900 006, 900 007, 900 008, 900 010, 900 011, 900 012, 900 013, 900 014, 900 015, 900 016, 900 017, 900 018, 900 019, 900 020, 900 021, 900 022, 900 023, 900 025, 900, 910, 940, 942-944, 946, 948, 959, 961</p> <p>OM 352 900 000, 900 001, 900 002, 900 003, 900 004, 900 005, 900 006, 900 007, 900 008, 900 009, 900 010, 900 011, 900 012, 900 013, 900 014, 900 015, 900 016, 900 017, 900 018, 900 019, 900 020, 900 021, 900 400, 900 410, 900 411, 900 412, 900 413, 900 414, 900 415, 900 416, 900 417, 900 418, 900 419, 900 420, 900 421, 900 422, 900 423, 900 424, 900 425, 900 426, 900 427, 900 428, 900 429, 900 430, 900-901, 905-914, 930-932, 934-939, 942-946, 948-950, 953-961, 963-965, 967-976, 978-979, 981-983, 985-992, 994, 996-999</p>		50 005 835	
Reference	314 180 05 01 314 180 10 01 352 180 63 01			
	<p>M 115 951, 954</p> <p>OM 615 913, 963</p> <p>OM 616 912, 916-917</p> <p>OM 617 910, 912</p>			50 005 932
12.1997→ 06.1999→	<p>OM 611 960-962</p> <p>OM 612 961-963, 966-967</p>			50 005 455
Reference	611 200 02 01 611 200 12 01			
03.1998→	<p>OM 407 920, 951</p> <p>OM 447 903, 952-953, 982-983, 988, 994</p> <p>OM 457 936-937</p> <p>OM 458 960, 970, 980</p>		50 005 828	
Reference	403 180 28 01			
1961 →1967	<p>OM 335 910 (IRN), 930 (IRN), 932</p> <p>OM 345 900 (USA), 910 (BRA), 912-913 (BRA), 915 (BRA), 950 (BRA), 953 (BRA), 973 (BRA)</p> <p>OM 346 951</p> <p>OM 347 915</p> <p>OM 355 910, 912-914, 916, 918, 960, 962-964, 966, 968, 970, 974-976, 979-980 (ITA), 981-982 (SUI), 983-984</p>		50 005 829	
Reference	355 180 01 01			

M















02.1984→	<p>M 476 921</p> <p>OM 401 901 504, 972-975, 977-981, 984-987, 989-991, 993-994</p> <p>OM 402 900 -000, 900 001, 900 003, 900 004, 900 400, 901 -000, 905-906, 910-914, 916-917, 919, 921, 923-928</p> <p>OM 403 910 -000, 910 001, 910 002, 910 003, 910 004, 910 005, 910 006, 911 -000, 915-917, 919, 930-935</p> <p>OM 407 900 -000, 900 001, 900 002, 901 400, 901 500, 901 600, 901, 930-932 (AFS), 952-954 (AFS), 956 (AFS)</p> <p>OM 409 906-908 (AFS)</p> <p>OM 421 901 -400, 901 410, 901 500, 901 510</p> <p>OM 422 900 -000, 905-916, 918-923</p> <p>OM 427 900 -000, 902 -400, 902 500</p> <p>OM 429 951 (USA), 953 (USA), 955 (USA)</p> <p>OM 440 907, 909-911</p> <p>OM 441 901 400, 901 500, 901 504, 901 505, 901 505, 901 507, 901 520, 901 530, 901, 951, 960-962, 981-983, 985-993, 996-999</p> <p>OM 442 900 -000, 900 004, 905-909, 914-917, 920-929, 932-935</p> <p>OM 445 920-927, 929-931, 933, 936-941</p> <p>OM 447 900 -000, 902 400, 902 500, 902 501, 902 520, 902 521, 902, 969 501 (USA), 969 502 (USA), 969 503 (USA)</p> <p>OM 462 900 010, 900 011 (AFS), 900 012, 900 013 (AFS)</p> <p>OM 466 900 005 (AFS), 900 405, 900 505</p> <p>OM 475 907 505, 907 506, 907, 950-951 (BRA), 954 (BRA), 974 (AFS/LAM), 976-979 (AFS/LAM), 982 (AFS/LAM), 985-986 (AFS/LAM), 989 (AFS/LAM), 991 (AFS/LAM), 994</p> <p>OM 476 916 405, 916 406, 916, 917 505, 917 506, 917, 950 (BRA), 971 (BRA), 973, 978-980 (BRA), 982-983 (BRA), 988 (BRA), 991 (BRA)</p> <p>OM 482 912 (TUR)</p> <p>OM 485 980 (BRA)</p> <p>OM 492 900 001 (AFS), 900 002 (AFS), 900 004 (AFS), 900 005, 900 007, 900 008, 900 009, 900 010, 900 013</p> <p>OM 495 900 001 (AFS), 900 002 (AFS), 900 003 (AFS), 900 009 (AFS), 900 010 (AFS)</p> <p>OM 496 900 001 (AFS), 900 002 (AFS), 900 003 (AFS), 900 023 (AFS), 900 026 (AFS), 900 027 (AFS), 900 030 (AFS), 900 031 (AFS), 900 034 (AFS), 900 035 (AFS), 900 401 (AFS), 900 402 (AFS), 900 425 (AFS), 900 426 (AFS), 900 429 (AFS), 900 430 (AFS), 900 431 (AFS), 900 501 (AFS)</p> <p>Reference 401 180 00 01 401 180 01 01 403 180 06 01 403 180 17 01</p>		50 005 837	
1980 →	<p>OM 401 905-906, 909, 914-916, 918-919, 921-928, 972-975, 977-981, 984-987, 989-991, 993-994</p> <p>OM 402 905-906, 910-914, 916-917, 919, 921, 923-928, 971-975, 977-978, 982-983, 985-987, 989-990, 996</p> <p>OM 403 915-917, 919, 930-935</p> <p>OM 407 901, 951</p> <p>OM 421 900, 905-907, 909-910</p> <p>OM 422 901, 905-916, 918-923, 952-959</p> <p>OM 423 901, 905-908</p> <p>OM 424 901</p> <p>OM 440 940-942, 945, 948, 970-973, 975-976, 978-991</p> <p>OM 441 901, 951, 960-962, 981-983, 985-993, 996-999</p> <p>OM 442 941-946, 950-953, 957-959, 962-968, 971-972, 976-978, 980, 982-983, 985, 989, 993-994, 997-999</p> <p>OM 443 905</p> <p>OM 445 920-927, 929-931, 933, 936-941</p> <p>OM 446 920, 922-932, 934-936, 939-943, 945-946, 948</p> <p>OM 447 902-903</p> <p>Reference 403 200 76 01 403 200 77 01</p>		50 005 615	
Reference	<p>OM 440 907, 909-911</p> <p>OM 441 905-907, 912-920, 923-927, 932-933</p> <p>OM 442 905-909, 914-917, 920-929, 932-935</p> <p>Reference 441 200 01 01 441 200 02 01</p>		50 005 616	

M















MERCEDES-BENZ

				
01.1996→ Reference	OM 521 940 OM 541 920-928, 940-952 OM 941 910, 920-921, 929-930, 940, 960, 970, 980-981, 990 541 200 01 01 541 200 11 01 541 200 12 01			50 005 628
04.2000→ 04.2000→ Reference	OM 611 981 OM 612 981 611 200 05 01 611 200 11 01			50 005 782 <small>NEW</small>
06.1973→ Reference	OM 341 937, 947 OM 344 912, 937, 939, 951 OM 353 911-914, 920-921, 939, 950-954, 958-959, 970-972, 974-978, 991, 997 OM 356 940-941, 943-959, 977 (TUR), 978-981, 983-999 OM 357 900-904, 906-910, 912-913, 915-922, 924-927, 929-933, 936-938, 940-949, 961-963 OM 362 906, 909-910 OM 366 941-949, 951-958, 960, 962-963, 966-971, 973-981, 983-984, 988, 990, 992-997, 999 OM 382 913, 919, 971 366 180 01 01 366 180 04 01			50 005 836
Reference	M 115 951, 954 OM 615 913, 916, 963 OM 616 912, 916-917 OM 617 910, 912 110 200 01 20			50 005 032
Reference	OM 401 905-906, 909, 914-916, 918-919, 921-928 OM 402 905-906, 910-914, 916-917, 919, 921, 923-928 OM 403 915-917, 919, 930-935 OM 407 901, 930-932 (AFS), 951, 952-954 (AFS) OM 409 906-908 (AFS) 403 200 27 01 403 200 32 01 403 200 34 01 403 200 35 01 403 200 49 01 403 200 70 01			50 005 207
Reference	OM 335 932 OM 355 960, 962-964, 966, 968-970, 974-976, 979-980 (ITA), 981-982 (SUI), 983-984 355 200 01 01 355 200 05 01 355 200 06 01 355 200 08 01 355 200 09 01 355 200 11 01 355 200 15 01			50 005 211
12.1984→ 12.1984→06.1996 01.1996→ Reference	OM 601 912, 940-943, 970 OM 602 911-912, 930-931, 938-942, 946-947, 961, 991, 993 OM 603 912-913, 931, 960, 963, 971-972 OM 661 911 OM 662 911 602 200 00 20 602 200 01 20 602 200 02 20			50 005 439
Reference	OM 352 900-906, 908, 910-914, 919, 930-933, 936-938, 942-946, 948-950, 953-963, 965-976, 978-979, 981-984, 988-992, 994, 999 OM 353 900-902, 905, 907, 911-914, 921-923, 930-934, 936-937, 939-940, 949, 957, 976 353 200 36 01 353 200 37 01			50 005 617
Reference	OM 422 900 -000 422 200 11 01			50 005 625





M



				
Reference	OM 356 OM 357 OM 366 OM 382	901-911, 913, 915-916, 940-941, 943-949, 951-953, 958-959, 979, 983-987, 989-996 900-902, 904, 906, 908, 916-921, 927, 929, 936-938, 940 905-910, 912-914, 918-919, 930-933, 935-938, 940-946, 951-954, 957-958, 960, 962, 966-971, 973-981, 983, 988, 990, 992-997, 999 912-913, 919, 971		50 005 629
01.1996→ Reference	OM 521 OM 541 OM 941	940 920-922, 924-928, 940-952 910, 920-921, 929-930, 940, 960, 970, 980-981, 990		50 005 831
06.1996→ 06.1996→ Reference	OM 522 OM 542 OM 942	940-943, 950 920-926, 940-945, 947 900, 910-912, 925, 930, 960, 967, 970, 980, 990		50 005 838
01.1988→06.1996 Reference	OM 602 OM 603	993 960, 971-972		50 005 490
Reference	OM 422	900 -000		50 005 626
Reference	OM 904 OM 906 OM 907 OM 909 OM 924 OM 926	904-912, 914-925, 927-931, 936, 938, 941-943, 950-953, 955, 957, 959, 961-962 910-928, 930-931, 933-935, 937-941, 947, 951-956, 960-965, 974-975, 977, 982-983 910, 920, 930, 940-941, 960, 970, 980, 990 900-901, 910-911, 920-921, 960, 970-971 910-912, 914 911-912, 914-915		50 005 627
08.1980→ 03.1991→ Reference	OM 402 OM 407 OM 447	984 920 952-953, 982-983, 988, 994		50 005 632
Reference	OM 354 OM 364 OM 370 OM 374	900-903, 920-926 906-909, 911-913, 916-921, 950-952, 954-959, 981-987, 989 905, 950-952 905, 907-908, 950-953, 980-982, 984-988		50 005 633 <small>NEW</small>
1980 → 03.1998→ Reference	OM 407 OM 424 OM 447 OM 457 OM 458	920, 951 901 903, 952-953, 982-983, 988, 994 936-937 960, 970, 980		50 005 827

M

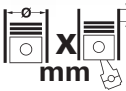

			Cyl	 mm	cm ³		Comp. Ratio ε	kW	PS	Pos
W10B16 (66 kW)	B		4	77 x 85,8	1598	4	10,6:1	66	90	1, 2

M



MINI (BMW)



One 1.6i (R52)

1

01.2005→

W10B16 (66 kW)



50 005 044

NEW

One 1.6i (R50)

2

06.2001→09.2006

W10B16 (66 kW)







50 005 044

NEW

M

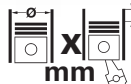

			Cyl	 mm	cm ³		Comp. Ratio ε	kW	PS	Pos
4D55T	D	(A)	4	91,1 x 90	2346	2	21:1	62-70	84-95	1, 28, 60, 69, 72, 81, 83
4D56T (62 kW)	D	(A)	4	91,1 x 94,7	2469	2	22:1	62-64	84-87	2, 22, 61, 70, 73, 82, 85
4D56T (64 kW)	D	(LA)	4	91,1 x 90	2346	2	21:1	64-73	87-99	56, 61, 73, 79, 82, 85, 86
4D56T (77 kW)	D	(LA)	4	91,1 x 95	2477	2	21:1	77	105	22, 61
4D56T (85 kW)	D	(LA)	4	91,1 x 95	2477	2	21:1	85	115	61
4D68	D	(AN)	4	82,7 x 93	1998	2	22,4:1	50-54	68-73	10, 34, 46, 55
4D68T	D	(LA)	4	82,7 x 93	1998	2	22,4:1	60-69	82-94	11, 13, 25, 27, 35, 47, 49, 66, 74, 78
4G11	B		4	69,5 x 82	1244	2	9:1	40	54	12, 32, 48
4G12	B		4	74 x 82	1411	2	9:1	50	68	17, 39, 52, 80
4G13 (51 kW)	B		4	71 x 82	1299	2	8,6/8,8:1	51	70	14, 36, 50
4G13 (55 kW)	B		4	71 x 82	1299	3	9,5:1	55-58	75-79	15, 37, 43, 45, 51
4G13 (60 kW)	B		4	71 x 82	1299	4	9,5/10:1	60-63	82-86	4, 16, 38, 75
4G15 (62 kW)	B		4	75,5 x 82	1468	2	9,4:1	62-66	84-90	19, 41
4G15 (69 kW)	B		4	75,5 x 82	1468	2	9,4:1	69	94	19, 41
4G63T (125 kW)	B	(A)	4	85 x 88	1997	2	7,6:1	125	170	23, 31, 33, 54, 65, 67
4G92 (66 kW)	B		4	81 x 77,5	1597	2	10:1	66	90	20
4G92 (73 kW)	B		4	81 x 77,5	1597	4	10:1	66-73	90-99	5, 21, 42
4G92 (76 kW)	B		4	81 x 77,5	1597	4	10:1	76	103	5, 21
4G92 (83 kW)	B		4	81 x 77,5	1597	4	11:1	83	113	21, 42
4G92 (91 kW)	B		4	81 x 77,5	1597	4	10:1	91	124	42
4G93 (100 kW)	B		4	81 x 89	1834	4	10,5:1	100-103	136-140	6
4G93 (82 kW)	B		4	81 x 89	1834	4	10:1	82-84	112-114	58
4G93 (85 kW)	B		4	81 x 89	1834	4	10:1	85	116	6
4G93 (96 kW)	B		4	81 x 89	1834	4	10:1	96	130	58
4G93H	B		4	81 x 89	1834	4	12,5:1	88-92	120-125	7, 57, 58, 76
4M40	D	(AN)	4	95 x 100	2835	2	21:1	69	94	3, 62
4M41	D	(LA)	4	98,5 x 105	3200	4	17:1	118-121	160-165	64
6A12	B		6	78,4 x 69	1999	4	10:1	110	150	24, 26, 44, 71
6A13	B		6	83,5 x 76	2497	4	9,5:1	120	163	30
6G72 (104 kW)	B		6	91,1 x 76	2972	2	8,9:1	104	141	63
F8Q 784	D	(A)	4	80 x 93	1870	2	20,5:1	66-70	90-95	8
F9Q 1	D	(LA)	4	80 x 93	1870	2	18,3:1	75	102	8, 77
F9Q 680	D	(LA)	4	80 x 93	1870	2	18,3:1	85	116	9, 77
G15B	B		4	75,5 x 82	1468	2	9,5:1	51-57	70-77	18, 40, 53
G63B (62 kW)	B		4	85 x 88	1997	2	8,6:1	62-66	84-90	59
G64B	B		4	86,5 x 100	2351	2	8,5:1	80-82	109-112	29, 68, 84



Canter 2.3 TD

1

05.1984→

4D55T

Reference

MD168048
MD972001
MD997160MD168050
MD997084
MD997170MD301847
MD997150
MD997618MD664616
MD997151**50 005 123****NEW**

Canter 2.5 TD

2

10.1989→

4D56T (62 kW)

Reference

MD168048
MD972001
MD997160MD168050
MD997084
MD997170MD301847
MD997150
MD997618MD664616
MD997151**50 005 123****NEW**

Canter 2.8 D

3

10.1996→

4M40

Reference

ME200411

ME993473

ME996789

**50 005 127****NEW**

Carisma 1.3i 16V

4

07.2001→

4G13 (60 kW)

Reference

MD323372

MD365087

**50 005 133****NEW****M**

Carisma 1.6i 16V

5

05.1995→

4G92 (73 kW), 4G92 (76 kW)

Reference

MD313301

**50 005 134****NEW**

Carisma 1.8i 16V

6

05.1995→02.1999

4G93 (100 kW), 4G93 (85 kW)

Reference

MD313301

**50 005 134****NEW**

Carisma 1.8 GDi 16V

7

05.1997→

4G93H

Reference

MD313301

**50 005 134****NEW**

Carisma 1.9 TD

8

05.1996→06.2000

F8Q 784

Reference

M 345 611

M 855 991

**50 005 301**



07.2000→ Reference	F9Q 1 MW30620725			50 005 756
Carisma 1.9 CDi				9
06.1999→ Reference	F9Q 680 MW30620725			50 005 756
Chariot 2.0 D				10
07.1992→ Reference	4D68 MD971539 MD972006 MD972054			50 005 126 <small>NEW</small>
Chariot 2.0 TD				11
07.1992→ Reference	4D68T MD971539 MD972006 MD972054			50 005 126 <small>NEW</small>
Colt 1.2				12
07.1980→10.1983 Reference	4G11 MD030863 MD974649 MD997076 MD997609			50 005 095 <small>NEW</small>
Colt 2.0 TD				13
08.1992→ Reference	4D68T MD971539 MD972006 MD972054			50 005 126 <small>NEW</small>
Colt 1.3				14
04.1988→05.1992 Reference	4G13 (51 kW) MD030863 MD974649 MD997076 MD997609			50 005 095 <small>NEW</small>
Colt 1.3i 12V				15
12.1991→05.2000 Reference	4G13 (55 kW) MD323372 MD365087			50 005 133 <small>NEW</small>

M



Colt 1.3i 16V

16

11.1995→
Reference 4G13 (60 kW)
MD323372 MD365087



50 005 133
NEW

Colt 1.4

17

07.1980→10.1983 4G12
Reference MD030863 MD974649 MD997076 MD997609



50 005 095
NEW

Colt 1.5

18

06.1986→05.1987 G15B
Reference MD030863 MD974649 MD997076 MD997609



50 005 095
NEW

Colt 1.5i

19

04.1988→05.1992 4G15 (62 kW)
Reference MD030863 MD974649 MD997076 MD997609



50 005 095
NEW

11.1995→05.2000 4G15 (69 kW)
Reference MD323372 MD365087



50 005 133
NEW

Colt 1.6i

20

12.1991→12.1996 4G92 (66 kW)
Reference MD309756 MD346790



50 005 125
NEW

Colt 1.6i 16V

21

12.1991→
Reference 4G92 (73 kW), 4G92 (76 kW), 4G92 (83 kW)
MD309756 MD346790



50 005 125
NEW

Delica 2.5 TD

22

04.1986→
Reference 4D56T (62 kW), 4D56T (77 kW)
MD168048 MD168050 MD301847 MD664616
MD972001 MD997084 MD997150 MD997151
MD997160 MD997170 MD997618



50 005 123
NEW







M



Eterna 2.0i Turbo					23
11.1980→	4G63T (125 kW)				
Reference	MD972003	MD972004	MD980000	MD997244	50 005 128 <small>NEW</small>
Eterna 2.0i 24V					24
02.1992→	6A12				
Reference	MD302010				50 005 129 <small>NEW</small>
Eterna 2.0 TD					25
02.1992→	4D68T				
Reference	MD971539	MD972006	MD972054		50 005 126 <small>NEW</small>
Galant 2.0i 24V					26
11.1992→05.1996	6A12				
Reference	MD302010				50 005 129 <small>NEW</small>
Galant 2.0 TD					27
11.1992→02.2000	4D68T				
Reference	MD971539	MD972006	MD972054		50 005 126 <small>NEW</small>
Galant 2.3 TD					28
05.1980→05.1984	4D55T				
Reference	MD168048 MD972001 MD997160	MD168050 MD997084 MD997170	MD301847 MD997150 MD997618	MD664616 MD997151	50 005 123 <small>NEW</small>
Galant 2.4					29
07.1985→12.1987	G64B				
Reference	MD168048 MD972001 MD997160	MD168050 MD997084 MD997170	MD301847 MD997150 MD997618	MD664616 MD997151	50 005 123 <small>NEW</small>
Galant 2.5i V6 24V					30
10.1996→	6A13				
Reference	MD302010				50 005 129 <small>NEW</small>
Galant 2.0i Turbo					31
03.1981→05.1984	4G63T (125 kW)				
Reference	MD972003	MD972004	MD980000	MD997244	50 005 128 <small>NEW</small>

M



Lancer 1.2							32
08.1979→01.1984	4G11						
Reference	MD030863	MD974649	MD997076	MD997609			50 005 095 <small>NEW</small>
Lancer 2.0i Turbo							33
03.1981→10.1983	4G63T (125 kW)						
Reference	MD972003	MD972004	MD980000	MD997244			50 005 128 <small>NEW</small>
Lancer 2.0 D							34
05.1992→05.1996	4D68						
Reference	MD971539	MD972006	MD972054				50 005 126 <small>NEW</small>
Lancer 2.0 TD							35
08.1992→	4D68T						
Reference	MD971539	MD972006	MD972054				50 005 126 <small>NEW</small>
Lancer 1.3							36
04.1988→07.1995	4G13 (51 kW)						
Reference	MD030863	MD974649	MD997076	MD997609			50 005 095 <small>NEW</small>
Lancer 1.3i 12V							37
04.1992→06.1996	4G13 (55 kW)						
Reference	MD323372	MD365087					50 005 133 <small>NEW</small>
Lancer 1.3i 16V							38
06.2003→	4G13 (60 kW)						
Reference	MD323372	MD365087					50 005 133 <small>NEW</small>
Lancer 1.4							39
03.1978→10.1983	4G12						
Reference	MD030863	MD974649	MD997076	MD997609			50 005 095 <small>NEW</small>

M



Lancer 1.5

40

01.1986→06.1988

G15B

Reference

MD030863

MD974649

MD997076

MD997609

**50 005 095****NEW**

Lancer 1.5i

41

04.1988→05.1992

4G15 (62 kW)

Reference

MD030863

MD974649

MD997076

MD997609

**50 005 095****NEW**

10.1995→09.2000

4G15 (69 kW)

Reference

MD323372

MD365087

**50 005 133****NEW**

Lancer 1.6i 16V

42

12.1993→

4G92 (73 kW), 4G92 (91 kW)

Reference

MD030863

MD974649

MD997076

MD997609

**50 005 095****NEW**

05.1992→12.1996

4G92 (83 kW)

Reference

MD309756

MD346790

**50 005 125****NEW**

Legnum 1.3i 12V

43

05.1992→

4G13 (55 kW)

Reference

MD323372

MD365087

**50 005 133****NEW**

Legnum 2.0i 24 V

44

08.1996→

6A12

Reference

MD302010

**50 005 129****NEW**

Libero 1.3i 12V

45

04.1992→

4G13 (55 kW)









Reference

MD323372

MD365087







**50 005 133****NEW****M**



Libero 2.0 D							46
04.1992→ Reference	4D68 MD971539	MD972006	MD972054				50 005 126 <small>NEW</small>
Libero 2.0 TD							47
04.1992→ Reference	4D68T MD971539	MD972006	MD972054				50 005 126 <small>NEW</small>
Mirage 1.2							48
04.1978→10.1983 Reference	4G11 MD030863	MD974649	MD997076	MD997609			50 005 095 <small>NEW</small>
Mirage 2.0 TD							49
08.1992→ Reference	4D68T MD971539	MD972006	MD972054				50 005 126 <small>NEW</small>
Mirage 1.3							50
10.1987→10.1995 Reference	4G13 (51 kW) MD030863	MD974649	MD997076	MD997609			50 005 095 <small>NEW</small>
Mirage 1.3i 12V							51
12.1993→ Reference	4G13 (55 kW) MD323372	MD365087					50 005 133 <small>NEW</small>
Mirage 1.4							52
03.1976→12.1981 Reference	4G12 MD030863	MD974649	MD997076	MD997609			50 005 095 <small>NEW</small>
Mirage 1.5							53
10.1983→10.1991 Reference	G15B MD030863	MD974649	MD997076	MD997609			50 005 095 <small>NEW</small>

M



Mirage 2.0i Turbo										54
08.1992→10.1995	4G63T (125 kW)									50 005 128
Reference	MD972003	MD972004	MD980000	MD997244						NEW
Mirage 2.0 D										55
→	4D68									
Reference	MD971539	MD972006	MD972054							50 005 126 NEW
Montero 2.5 TD										56
08.1998→	4D56T (64 kW)									
Reference	MD168048 MD972001 MD997160	MD168050 MD997084 MD997170	MD301847 MD997150 MD997618	MD664616 MD997151						50 005 123 NEW
Pajero io 1.8 GDI 16V										57
06.1998→	4G93H									
Reference	MD313301									50 005 134 NEW
Pajero Pinin 1.8 GDi 16V										58
07.2000→	4G93 (82 kW), 4G93 (96 kW)									
Reference	MD309756	MD346790								50 005 125 NEW
06.1998→08.2001	4G93H									
Reference	MD313301									50 005 134 NEW
Pajero 2.0										59
04.1982→08.1988	G63B (62 kW)									
Reference	MD972003	MD972004	MD980000	MD997244						50 005 128 NEW
Pajero 2.3 TD										60
09.1984→04.1986	4D55T									
Reference	MD168048 MD972001 MD997160	MD168050 MD997084 MD997170	MD301847 MD997150 MD997618	MD664616 MD997151						50 005 123 NEW
Pajero 2.5 TD										61
05.1986→05.2001	4D56T (62 kW), 4D56T (64 kW), 4D56T (77 kW)									
Reference	MD168048 MD972001 MD997160	MD168050 MD997084 MD997170	MD301847 MD997150 MD997618	MD664616 MD997151						50 005 123 NEW

M



05.1986→ Reference	4D56T (62 kW), 4D56T (85 kW) MD972002	MD974999	MD997686				50 005 124 NEW
Pajero 2.8 D							62
04.1996→ Reference	4M40 ME200411	ME993473	ME996789				50 005 127 NEW
Pajero 3.0							63
11.1988→06.1991 Reference	6G72 (104 kW) MD972003	MD972004	MD980000	MD997244			50 005 128 NEW
Pajero 3.2 TD							64
02.2000→ Reference	4M41 ME200411	ME993473	ME996789				50 005 127 NEW
RVR 2.0i Turbo							65
01.1991→ Reference	4G63T (125 kW) MD972003	MD972004	MD980000	MD997244			50 005 128 NEW
RVR 2.0 TD							66
06.1992→ Reference	4D68T MD971539	MD972006	MD972054				50 005 126 NEW
Sapporo 2.0 Turbo							67
03.1981→11.1984 Reference	4G63T (125 kW) MD972003	MD972004	MD980000	MD997244			50 005 128 NEW
Sapporo 2.4i							68
10.1980→08.1989 Reference	G64B MD168048 MD972001 MD997160	MD168050 MD997084 MD997170	MD301847 MD997150 MD997618	MD664616 MD997151			50 005 123 NEW
Shogun 2.3 TD							69
1983 → 1986 Reference	4D55T MD168048 MD972001 MD997160	MD168050 MD997084 MD997170	MD301847 MD997150 MD997618	MD664616 MD997151			50 005 123 NEW

M



Shogun 2.5 TD					70
03.1986→ Reference	4D56T (62 kW) MD168048 MD972001 MD997160	MD168050 MD997084 MD997170	MD301847 MD997150 MD997618	MD664616 MD997151	 50 005 123 NEW
Sigma 2.0i 24 V					71
10.1992→ Reference	6A12 MD302010				 50 005 129 NEW
Sigma 2.3 TD					72
1981 → 1986 Reference	4D55T MD168048 MD972001 MD997160	MD168050 MD997084 MD997170	MD301847 MD997150 MD997618	MD664616 MD997151	 50 005 123 NEW
Space Gear 2.5 TD					73
06.1994→03.2001 Reference	4D56T (62 kW), 4D56T (64 kW) MD168048 MD972001 MD997160	MD168050 MD997084 MD997170	MD301847 MD997150 MD997618	MD664616 MD997151	 50 005 123 NEW
Space Runner 2.0 TD					74
06.1992→12.2002 Reference	4D68T MD971539	MD972006	MD972054		 50 005 126 NEW
Space Star 1.3i 16V					75
06.1998→ Reference	4G13 (60 kW) MD323372	MD365087			 50 005 133 NEW
Space Star 1.8 GD i 16V					76
08.1998→ Reference	4G93H MD313301				 50 005 134 NEW
Space Star 1.9 CDi					77
06.2000→ Reference	F9Q 1, F9Q 680 MW30620725				 50 005 756

M



Space Wagon 2.0 TD

78

06.1992→11.2000

4D68T

Reference

MD971539

MD972006

MD972054

**50 005 126****NEW**

Strada Gear 2.5 TD

79

03.1991→

4D56T (64 kW)

Reference

MD168048

MD168050

MD301847

MD664616

MD972001

MD997084

MD997150

MD997151

MD997160

MD997170

MD997618

**50 005 123****NEW**

Tredia 1.4

80

10.1982→08.1984

4G12

Reference

MD030863

MD974649

MD997076

MD997609

**50 005 095****NEW**

L 200 2.3 TD

81

1982 → 10.1986

4D55T

Reference

MD168048

MD168050

MD301847

MD664616

MD972001

MD997084

MD997150

MD997151

MD997160

MD997170

MD997618

**50 005 123****NEW**

L 200 2.5 TD

82

11.1992→03.2001

4D56T (64 kW)

Reference

MD168048

MD168050

MD301847

MD664616

MD972001

MD997084

MD997150

MD997151

MD997160

MD997170

MD997618

**50 005 123****NEW**

11.1992→08.1996

4D56T (62 kW)

Reference

MD972002

MD974999

MD997686

**50 005 124****NEW**

L 300 2.3 TD

83

04.1983→10.1986

4D55T

Reference

MD168048

MD168050

MD301847

MD664616

MD972001

MD997084

MD997150

MD997151

MD997160

MD997170

MD997618

**50 005 123****NEW**

L 300 2.4i

84

11.1986→10.1988

G64B

Reference

MD168048

MD168050

MD301847

MD664616

MD972001

MD997084

MD997150

MD997151

MD997160

MD997170

MD997618

**50 005 123****NEW****M**



L 300 2.5 TD

85

11.1988→12.2001 4D56T (62 kW), 4D56T (64 kW)

Reference

MD168048	MD168050	MD301847	MD664616
MD972001	MD997084	MD997150	MD997151
MD997160	MD997170	MD997618	



50 005 123

NEW

L 400 2.5 TD

86

12.1994→03.2001 4D56T (64 kW)

Reference

MD168048	MD168050	MD301847	MD664616
MD972001	MD997084	MD997150	MD997151
MD997160	MD997170	MD997618	







50 005 123

NEW

M

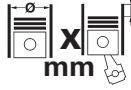

			Cyl	 mm	cm ³		Comp. Ratio ε	kW	PS	Pos
CD20	D	(AN)	4	84,5 x 88	1974	2	22,2:1	55	75	8, 41, 57
CD20T	D	(A)	4	84,5 x 88	1974	2	22,2:1	66	90	42, 47
CG10DE (40 kW)	B		4	71 x 63	998	4	9,5:1	40-44	55-60	23
CG10DE (48 kW)	B		4	71 x 63	998	4	10,2:1	48	65	23
CG12DE	B		4	71 x 78,3	1240	4	9,9:1	48-59	65-80	24
CG13DE	B		4	71 x 80,5	1275	4	9,5:1	55	75	25
CGA3DE (65 kW)	B		4	73 x 82,8	1386	4	9,9:1	65-72	88-98	15, 26
D7F 722	B		4	69 x 76,8	1149	2	9,6:1	43-44	58-60	20
F4R 720	B		4	82,7 x 93	1998	4	9,8:1	88	120	35
F4R 722	B		4	82,7 x 93	1998	4	9,8:1	88	120	35
F9Q 772	D	(A)	4	80 x 93	1870	2	18,3:1	60	82	16
F9Q 780	D	(A)	4	80 x 93	1870	2	18,3:1	59	80	17
F9Q 800	D	(A)	4	80 x 93	1870	2	18,3:1	88	120	40
G9T 722	D	(A)	4	87 x 92	2188	4	18:1	66	90	18
G9U 630	D	(LA)	4	87 x 92	2464	4	18,1:1	107	145	36
G9U 720	D	(LA)	4	89 x 99	2463	4	21,25:1	73-84	99-115	19
GA16DE	B		4	76 x 88	1597	4	9,8:1	62-81	84-110	1, 5, 38, 45, 49, 52, 56, 66
GA16DS	B		4	76 x 88	1597	4	9,8:1	66-70	90-95	2, 37, 55
K4M 752	B		4	79,5 x 80,5	1598	4	10:1	70	95	22
K9K 700	D	(LA)	4	76 x 80,5	1461	2	18,8:1	48-50	65-68	21, 28
K9K 704	D	(LA)	4	76 x 80,5	1461	2	18,8:1	48-50	65-68	21
K9K 722	D	(A)	4	76 x 80,5	1461	2	18,8:1	60-63	82-86	21
K9K 750	D	(LA)	4	76 x 80,5	1461	2	18,3:1	60-65	82-88	4, 28
LD20 (43 kW)	D	(AN)	4	85 x 86	1952	2	21,3:1	43-49	58-67	13, 54, 67
LD20 (55 kW)	D	(AN)	4	85 x 86	1952	2	21,3:1	55	75	54
QG18DE	B		4	80 x 88	1769	4	9,5:1	83-92	113-126	6, 10, 39, 46, 51, 68
RD28T	D	(A)	6	85 x 83	2825	2	21,2:1	85	115	30, 31
SR20DE (103 kW)	B		4	86 x 86	1998	4	10:1	103-112	140-152	43, 48
SR20DE (85 kW)	B		4	86 x 86	1998	4	9,5:1	85-107	116-145	3, 7, 11, 34, 43, 48, 50, 53, 58
TD25	D	(AN)	4	92,9 x 92	2494	2	22,2:1	55-63	75-86	14, 32, 63, 64
TD27	D	(AN)	4	96 x 92	2664	2	21,8:1	62-73	85-99	33, 59, 65
TD27T	D	(A)	4	96 x 92	2664	2	21,9:1	74	101	29, 60, 61
TD27Ti	D	(LA)	4	96 x 92	2664	2	21,9:1	92	125	62
TUD 5	D	(AN)	4	77 x 82	1527	2	23:1	40-42	54-57	27
YD22DDT	D	(A)	4	86 x 94	2184	4	18:1	81-93	110-126	9, 12, 44
YD22DDTi	D	(LA)	4	86 x 94	2184	4	16,7:1	100	136	70
YD22ETi	D	(LA)	4	86 x 94	2184	4	16,3:1	84	114	69



100 NX 1.6i 16V

1

10.1992→10.1994	GA16DE							
Reference	21010-0M300 21010-71J00	21010-0M301	21010-53Y00	21010-53Y01				50 005 172 NEW

100 NX 1.6 16V

2

10.1990→10.1992	GA16DS							
Reference	21010-0M300 21010-71J00	21010-0M301	21010-53Y00	21010-53Y01				50 005 172 NEW

100 NX 2.0 GTI

3

10.1990→10.1993	SR20DE (85 kW)							
Reference	21010-53J00 21010-70J00	21010-53J01 21010-9F501	21010-53J03	21010-53J04				50 005 136 NEW

Almera 1.5 dCi

4

10.2002→	K9K 750							
Reference	21010-00QAS	21010-00QAT	21010-BN700					50 005 171 NEW

Almera 1.6i 16V

5

07.1995→04.2000	GA16DE							
Reference	21010-0M300 21010-71J00	21010-0M301	21010-53Y00	21010-53Y01				50 005 172 NEW

Almera 1.8i 16V

6

01.2000→	QG18DE							
Reference	21010-4M525	21010-4M526	21010-9F600	21010-9F605				50 005 141 NEW

Almera 2.0i 16V

7

04.1996→04.2000	SR20DE (85 kW)							
Reference	21010-53J00 21010-70J00	21010-53J01 21010-9F501	21010-53J03	21010-53J04				50 005 136 NEW

Almera 2.0 D

8

07.1995→04.2000	CD20							
Reference	21010-57J01 21010-57J26	21010-57J02	21010-57J03	21010-57J25				50 005 169 NEW

N

**NISSAN****Almera 2.2 DTi 16V****9**

01.2000→02.2003 YD22DDT
 Reference 21010-AD200 21010-AD201 21010-AD225 21010-AD226

**50 005 753****Almera Tino 1.8i 16V****10**

05.2000→ QG18DE
 Reference 21010-4M525 21010-4M526 21010-9F600 21010-9F605

**50 005 141**
NEW**Almera Tino 2.0 16V****11**

05.2000→01.2003 SR20DE (85 kW)
 Reference 21010-53J00 21010-53J01 21010-53J03 21010-53J04
 21010-70J00 21010-9F501

**50 005 136**
NEW**Almera Tino 2.2 DTi 16V****12**

05.2000→01.2003 YD22DDT
 Reference 21010-AD200 21010-AD201 21010-AD225 21010-AD226

**50 005 753****Bluebird 2.0 D****13**

01.1980→05.1990 LD20 (43 kW)
 Reference 21010-G5510 21010-G5585 21010-G5586 21010-G5594
 21010-G8125 BA010-G5586 BA010-G8125

**50 005 174**
NEW**Cabstar 2.5 D****14**

1986 → TD25
 Reference 21010-35V26 21010-43G02 21010-43G25 21010-43G26
 21010-43G27 21010-43G28 21010-43G29 21010-43G86

**50 005 173**
NEW**Cube 1.4i 16V****15**

10.2002→ CGA3DE (65 kW)
 Reference 21010-BX000

**50 005 763****Interstar 1.9 dCi****16**







07.2002→ F9Q 772
 Reference 21010-00QAC

**50 005 756****Interstar 1.9 DTi****17**

07.2002→ F9Q 780

**50 005 301****N**



Interstar 2.2 dCi 16V										18	
07.2002→	G9T 722									50 005 794	
Interstar 2.5 dCi 16V										19	
07.2002→	G9U 720									50 005 794	
Kubistar 1.1i										20	
07.2003→	D7F 722									50 005 335	
07.2003→	D7F 722									50 005 934 <small>NEW</small>	
Kubistar 1.5 dCi										21	
08.2003→	K9K 700, K9K 704, K9K 722									50 005 171 <small>NEW</small>	
Reference	21010-00QAS	21010-00QAT	21010-BN700								
Kubistar 1.6i 16V										22	
08.2003→	K4M 752									50 005 170 <small>NEW</small>	
Micra 1.0i 16V										23	
11.2002→	CG10DE (48 kW)									50 005 763	
Reference	21010-BX000										
08.1992→10.2002	CG10DE (40 kW)									50 005 791	
Reference	21010-41B00	21010-41B03	21010-99B00								
Micra 1.2i 16V										24	
11.2002→	CG12DE									50 005 763	
Reference	21010-BX000										
Micra 1.3i 16V										25	
08.1992→07.2000	CG13DE									50 005 791	
Reference	21010-41B00	21010-41B03	21010-99B00								

N

**NISSAN****Micra 1.4i 16V****26**11.2002→
ReferenceCGA3DE (65 kW)
21010-BX000

50 005 763

Micra 1.5 D**27**02.1998→
ReferenceTUD 5
21010-6F900 21010-6F906 21010-6F907

50 005 339

Micra 1.5 dCi**28**02.2003→
ReferenceK9K 700, K9K 750
21010-00QAS 21010-00QAT 21010-BN70050 005 171
NEW**Patrol 2.7 TD****29**05.1998→
ReferenceTD27T
21010-G5510 21010-G5585 21010-G5586 21010-G5594
21010-G8125 BA010-G5586 BA010-G812550 005 174
NEW**Patrol 2.8 TD****30**04.1989→05.1998
ReferenceRD28T
21010-22J00 21010-22J25 21010-22J26 21010-28J25
21010-28J26 BA010-22J2550 005 135
NEW**Patrol GR 2.8 TD****31**09.1988→09.1997
ReferenceRD28T
21010-22J00 21010-22J25 21010-22J26 21010-28J25
21010-28J26 BA010-22J2550 005 135
NEW**Pick-up 2.5 D****32**08.1987→11.2001
ReferenceTD25
21010-35V26 21010-43G02 21010-43G25 21010-43G26
21010-43G27 21010-43G28 21010-43G29 21010-43G8650 005 173
NEW**Pick-up 2.7 D****33**08.1987→01.1997
ReferenceTD27
21010-35V26 21010-43G02 21010-43G25 21010-43G26
21010-43G27 21010-43G28 21010-43G29 21010-43G8650 005 173
NEW**N**

**Prairie 2.0i 16V****34**

10.1995→	SR20DE (85 kW)							
Reference	21010-53J00 21010-70J00	21010-53J01 21010-9F501	21010-53J03	21010-53J04				50 005 136 <small>NEW</small>

Primastar 2.0i 16V**35**

02.2003→	F4R 720, F4R 722							
Reference	21010-00QAC							50 005 756

Primastar 2.5 dCi 16V**36**

07.2006→	G9U 630							
								50 005 794

Primera 1.6 16V**37**

06.1990→05.1993	GA16DS							
Reference	21010-0M300 21010-71J00	21010-0M301	21010-53Y00	21010-53Y01				50 005 172 <small>NEW</small>

Primera 1.6i 16V**38**

06.1990→12.1997	GA16DE							
Reference	21010-0M300 21010-71J00	21010-0M301	21010-53Y00	21010-53Y01				50 005 172 <small>NEW</small>

Primera 1.8i 16V**39**

06.1999→	QG18DE							
Reference	21010-4M525	21010-4M526	21010-9F600	21010-9F605				50 005 141 <small>NEW</small>

Primera 1.9 dCi**40**

01.2003→	F9Q 800							
Reference	21010-AW300							50 005 795

Primera 2.0 D**41**

07.1990→06.1996	CD20							
Reference	21010-57J01 21010-57J26	21010-57J02	21010-57J03	21010-57J25				50 005 169 <small>NEW</small>

**NISSAN****Primera 2.0 TD****42**

09.1996→12.2001

CD20T

Reference

21010-57J01
21010-57J26

21010-57J02

21010-57J03

21010-57J25

**50 005 169****NEW****Primera 2.0i 16V****43**

06.1990→12.2001

SR20DE (103 kW), SR20DE (85 kW)

Reference

21010-53J00
21010-70J0021010-53J01
21010-9F501

21010-53J03

21010-53J04

**50 005 136****NEW****Primera 2.2 DTi 16V****44**

01.2000→

YD22DDT

Reference

21010-AD200

21010-AD201

21010-AD225

21010-AD226

**50 005 753****Primera Traveller 1.6i 16V****45**

01.1998→

GA16DE

Reference

21010-0M300
21010-71J00

21010-0M301

21010-53Y00

21010-53Y01

**50 005 172****NEW****Primera Traveller 1.8i 16V****46**

06.1999→

QG18DE

Reference

21010-4M525

21010-4M526

21010-9F600

21010-9F605

**50 005 141****NEW****Primera Traveller 2.0 TD****47**

01.1998→

CD20T

Reference

21010-57J01
21010-57J26

21010-57J02

21010-57J03

21010-57J25

**50 005 169****NEW****Primera Traveller 2.0i 16V****48**

01.1998→

SR20DE (103 kW), SR20DE (85 kW)

Reference

21010-53J00
21010-70J0021010-53J01
21010-9F501

21010-53J03

21010-53J04

**50 005 136****NEW****Pulsar 1.6i 16V****49**

08.1995→

GA16DE

Reference

21010-0M300
21010-71J00

21010-0M301

21010-53Y00

21010-53Y01

**50 005 172****NEW****N**



Pulsar 2.0i 16V

50

08.1995→	SR20DE (85 kW)						
Reference	21010-53J00 21010-70J00	21010-53J01 21010-9F501	21010-53J03	21010-53J04			50 005 136 <small>NEW</small>

Sentra 1.8i 16V

51

→	QG18DE						
Reference	21010-4M525	21010-4M526	21010-9F600	21010-9F605			50 005 141 <small>NEW</small>

Serena 1.6i 16V

52

02.1993→	GA16DE						
Reference	21010-0M300 21010-71J00	21010-0M301	21010-53Y00	21010-53Y01			50 005 172 <small>NEW</small>

Serena 2.0 16V

53

07.1992→	SR20DE (85 kW)						
Reference	21010-53J00 21010-70J00	21010-53J01 21010-9F501	21010-53J03	21010-53J04			50 005 136 <small>NEW</small>

Serena 2.0 D

54

07.1992→	LD20 (43 kW), LD20 (55 kW)						
Reference	21010-G5510 21010-G8125	21010-G5585 BA010-G5586	21010-G5586 BA010-G8125	21010-G5594			50 005 174 <small>NEW</small>

Sunny 1.6 16V

55

11.1990→07.1995	GA16DS						
Reference	21010-0M300 21010-71J00	21010-0M301	21010-53Y00	21010-53Y01			50 005 172 <small>NEW</small>

Sunny 1.6i 16V

56

10.1992→03.2000	GA16DE						
Reference	21010-0M300 21010-71J00	21010-0M301	21010-53Y00	21010-53Y01			50 005 172 <small>NEW</small>

Sunny 2.0 D

57

10.1990→03.2000	CD20						
Reference	21010-57J01 21010-57J26	21010-57J02	21010-57J03	21010-57J25			50 005 169 <small>NEW</small>

**NISSAN****Sunny 2.0i 16V****58**

10.1990→05.1995 SR20DE (85 kW)

Reference 21010-53J00 21010-53J01 21010-53J03 21010-53J04
21010-70J00 21010-9F501**50 005 136**
NEW**Terrano 2.7 D****59**

08.1987→11.1995 TD27

Reference 21010-35V26 21010-43G02 21010-43G25 21010-43G26
21010-43G27 21010-43G28 21010-43G29 21010-43G86
→12.1993**50 005 173**
NEW**Terrano 2.7 TD****60**

02.1989→10.1993 TD27T

Reference 21010-G5510 21010-G5585 21010-G5586 21010-G5594
21010-G8125 BA010-G5586 BA010-G8125**50 005 174**
NEW**Terrano II 2.7 TD****61**

02.1993→02.2002 TD27T

Reference 21010-G5510 21010-G5585 21010-G5586 21010-G5594
21010-G8125 BA010-G5586 BA010-G8125**50 005 174**
NEW**N****Terrano II 2.7 TDi****62**

05.1996→

TD27TI

Reference 21010-0F001 21010-0F002 21010-0F003 21010-7F400
21010-80G25 21010-80G26 21010-80G27 21010-80G28
21010-80G85 21010-G2404**50 005 175**
NEW**Trade 2.5 D****63**

12.1988→05.1997 TD25

Reference 21010-35V26 21010-43G02 21010-43G25 21010-43G26
21010-43G27 21010-43G28 21010-43G29 21010-43G86**50 005 173**
NEW**Urvan 2.5 D****64**

12.1988→06.1997 TD25

Reference 21010-35V26 21010-43G02 21010-43G25 21010-43G26
21010-43G27 21010-43G28 21010-43G29 21010-43G86**50 005 173**
NEW**Urvan 2.7 D****65**

11.1986→06.1997 TD27

Reference 21010-35V26 21010-43G02 21010-43G25 21010-43G26
21010-43G27 21010-43G28 21010-43G29 21010-43G86**50 005 173**
NEW



Vanette 1.6i 16V

66

07.1992→	GA16DE						50 005 172 <small>NEW</small>
Reference	21010-0M300 21010-71J00	21010-0M301	21010-53Y00	21010-53Y01			

Vanette 2.0 D

67

06.1981→09.1994	LD20 (43 kW)						50 005 174 <small>NEW</small>
Reference	21010-G5510 21010-G8125	21010-G5585 BA010-G5586	21010-G5586 BA010-G8125	21010-G5594			

Wingroad 1.8 16V

68

→	QG18DE						50 005 141 <small>NEW</small>
Reference	21010-4M525	21010-4M526	21010-9F600	21010-9F605			

X-Trail 2.2 TDi 16V

69

06.2001→	YD22ETi						50 005 753
Reference	21010-AD200	21010-AD201	21010-AD225	21010-AD226			





X-Trail 2.2 dCi 16V

70





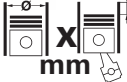



01.2004→	YD22DDTi						50 005 753
Reference	21010-AD200	21010-AD201	21010-AD225	21010-AD226			

N



			Cyl	 mm	cm ³		Comp. Ratio ε	kW	PS	Pos
8060.02.000	D	(AN)	6	100 x 110	5184	2	17:1	90	122	1
8140.21.200	D	(A)	4	93 x 90	2445	2	18:1	68	92	3, 8, 10
8140.21.214	D	(A)	4	93 x 90	2445	2	18:1	77	105	10
8140.43.3700	D	(LA)	4	94,4 x 100	2798	2	18,5:1	85	115	4, 6, 9, 11, 12
8140.43.3731	D	(LA)	4	94,4 x 100	2798	2	18,5:1	90	122	4, 6, 9, 11, 12
8140.47.2700	D	(LA)	4	93 x 92	2499	2	18,5:1	85	116	4, 6, 9, 11, 12
8140.47.2721	D	(LA)	4	93 x 92	2499	2	18,5:1	85	116	9, 11, 12
8140.61.200	D	(AN)	4	93 x 90	2445	2	21:1	53	72	2, 5, 7
8140.61.300	D	(AN)	4	93 x 90	2445	2	21:1	53	72	5, 7



110					1
01.1973→12.1981 Reference	8060.02.000 93191101				50 005 620
Grinta 30.8					2
04.1978→06.1989 Reference	8140.61.200 4714636 4754850 4764761 7303009				50 005 321
Grinta 35.10					3
02.1985→06.1989 Reference	8140.21.200 4714636 4754850 4764761 7303009				50 005 321
Grinta 35.12					4
10.1990→05.1999 Reference	8140.43.3700, 8140.43.3731, 8140.47.2700 99438900				50 005 621
Grinta 35.8					5
04.1978→06.1989 Reference	8140.61.200, 8140.61.300 4714636 4754850 4764761 7303009				50 005 321
Grinta 40.12					6
10.1990→05.1999 Reference	8140.43.3700, 8140.43.3731, 8140.47.2700 99438900				50 005 621
Grinta 40.8					7
04.1978→06.1989 Reference	8140.61.200, 8140.61.300 4714636 4754850 4764761 7303009				50 005 321
Grinta 45.10					8
02.1985→06.1989 Reference	8140.21.200 4714636 4754850 4764761 7303009				50 005 321
Grinta 45.12					9
06.1990→05.1999 Reference	8140.43.3700, 8140.43.3731, 8140.47.2700, 8140.47.2721 99438900				50 005 621



Grinta 49.10

10

02.1985→06.1989	8140.21.200, 8140.21.214
Reference	4714636 4754850 4764761 7303009



50 005 321

Grinta 49.12

11

06.1990→05.1999	8140.43.3700, 8140.43.3731, 8140.47.2700, 8140.47.2721
Reference	99438900



50 005 621

Grinta 59.12





12

05.1991→05.1999	8140.43.3700, 8140.43.3731, 8140.47.2700, 8140.47.2721
Reference	99438900



50 005 621







			Cyl	 mm	cm ³		Comp. Ratio ε	kW	PS	Pos
1.5L	B		4	82,5 x 69,8	1475	2	8,2:1	43	58	180
10 N	B		4	72 x 61	993	2	8,8:1	29	40	115, 119
10 S	B		4	72 x 61	993	2	9,2:1	33-37	45-50	77, 115
11 N	B		4	75 x 61	1078	2	7,8:1	33	45	116
11 S	B		4	75 x 61	1078	2	8,8:1	40	55	116
11 SR	B		4	75 x 61	1078	2	7,8:1	44	60	113, 116
12 N	B		4	79 x 61	1196	2	7,8:1	33-40	45-54	9, 120, 123
12 NC	B		4	79 x 61	1196	2	7,8:1	33	45	78
12 NV	B		4	77,8 x 62,9	1196	2	8/9,1:1	40	54	78
12 NZ	B		4	72 x 73,4	1195	2	9:1	33	45	62, 87
12 S OHC	B		4	79 x 61	1196	2	9,1:1	44	60	9, 123, 146
12 S OHV	B		4	79 x 61	1196	2	9,1:1	44	60	6, 9, 117, 120, 123, 143, 146
12 SC	B		4	79 x 61	1196	2	9:1	40	55	128
12 ST	B		4	77,8 x 62,9	1196	2	9,2:1	37-43	50-58	78, 123, 128
13 N	B		4	75 x 73,4	1297	2	8,2:1	44	60	10, 16, 124, 129, 147
13 NB	B		4	75 x 73,4	1297	2	8,2:1	44	60	80, 129
13 S	B		4	75 x 73,4	1297	2	9,2:1	50-55	68-75	10, 16, 80, 124, 129, 147
13 SB	B		4	75 x 73,4	1297	2	9,2:1	51	70	80
14 NV	B		4	77,6 x 73,4	1389	2	9,4:1	53-55	72-75	23, 82, 131, 212
14 SE	B		4	77,6 x 73,4	1389	2	9,8:1	60	82	24
15 D	D	(AN)	4	76 x 82	1487	2	23:1	37	50	84, 90
15 TD	D	(A)	4	76 x 82	1487	2	22,5:1	49-53	67-72	85, 91, 133
16 D	D	(AN)	4	80 x 79,5	1598	2	23:1	40	54	19, 126, 136
16 DA	D	(AN)	4	80 x 79,5	1598	2	23:1	40	54	19, 136
16 LZ2	B		4	79 x 79,5	1598	2	9,6:1	55	75	26, 223
16 N	B		4	80 x 79,5	1598	2	8,2:1	50	68	7, 144, 148
16 N CIH	B		4	85 x 69,8	1584	2	8:1	44	60	11, 144, 148
16 N OHC	B		4	80 x 79,5	1598	2	8,2:1	51-55	69-75	17
16 NZ2	B		4	80 x 79,5	1598	2	9,6:1	55	75	26
16 S	B		4	80 x 79,5	1598	2	9/9,5:1	55-60	75-82	7, 11, 17, 121, 134, 144, 148
16 S CIH	B		4	85 x 69,8	1584	2	8,8:1	55	75	11, 148
16 SH	B		4	80 x 79,5	1598	2	9,2:1	66	90	17, 125
16 SV	B		4	79 x 81,5	1598	2	10:1	60	82	17, 134, 213
17 D	D	(AN)	4	82,5 x 79,5	1699	2	23:1	42	57	28, 137, 215
17 DR	D	(AN)	4	82,5 x 79,5	1699	2	23:1	42-44	57-60	28, 215
17 N	B		4	88 x 69,8	1698	2	8:1	44	60	181, 183, 188
17 S	B		4	88 x 69,8	1698	2	8,8:1	55	75	181, 183
17 TD	D	(LA)	4	79 x 86	1686	2	22:1	60	82	29, 216
18 E	B		4	84,8 x 79,5	1796	2	9,5:1	85	115	21, 127, 139
18 N	B		4	84,8 x 79,5	1796	2	8,2:1	55	75	189
18 NV	B		4	84,8 x 79,5	1796	2	9,2:1	60	82	163
18 S	B		4	84,8 x 79,5	1796	2	9,2:1	66	90	149, 189
18 SE	B		4	84,8 x 79,5	1796	2	10:1	82-85	112-116	21, 30, 139
18 SEH	B		4	84,8 x 79,5	1796	2	10:1	85	116	164
18 SV	B		4	84,8 x 79,5	1796	2	10:1	66	90	163, 217
19 N	B		4	93 x 69,8	1897	2	7,6:1	52-55	71-75	12, 150, 184
19 S	B		4	92 x 71,4	1897	2	8,8:1	65-77	88-105	8, 114, 118, 145, 150, 182
19 S CIH	B		4	93 x 69,8	1897	2	8,8/9:1	66	90	8, 12, 150
19 SH	B		4	92 x 71,4	1897	2	9,8:1	66-71	90-97	184
2.8 L	B		6	92 x 69,8	2784	2	9:1	114	155	75
20 D	D	(AN)	4	86,5 x 85	1998	2	22:1	40-49	54-67	15, 56, 186, 192
20 E	B		4	95 x 69,8	1979	2	9,4:1	81	110	14, 122
20 N	B		4	95 x 69,8	1979	2	8:1	56-66	76-90	13, 151, 191
20 NE	B		4	86 x 86	1998	2	9,2:1	85	116	22, 140, 219
20 NEJ	B		4	86 x 86	1998	2	9,2:1	82	111	226
20 S	B		4	95 x 69,8	1979	2	9:1	74	101	13, 151, 185, 191
20 SE	B		4	86 x 86	1998	2	10:1	85	116	165, 172
20 SEH	B		4	86 x 86	1998	2	10:1	95	129	22, 140, 219
20 SER	B		4	86 x 86	1998	2	10:1	91	124	140
20 XE	B		4	86 x 86	1998	4	10,5:1	110-115	150-156	141
21 D	D	(AN)	4	88 x 85	2068	2	22:1	44	60	187, 193
23 D	D	(AN)	4	92 x 85	2260	2	22:1	46-52	63-71	57, 194
23 DTR	D	(LA)	4	92 x 85	2260	2	23:1	74	100	167
23 YD	D	(AN)	4	92 x 85	2260	2	22:1	54	73	166
23 YDT	D	(A)	4	92 x 85	2260	2	23:1	66	90	167
25 H	B		6	87 x 69,8	2490	4	9:1	96	130	73
25 NE	B		6	87 x 69,8	2490	2	9,2:1	103	140	196



			Cyl	 mm	cm ³	 Comp. Ratio ε	kW	PS	Pos
25 S	B		6	87 x 69,8	2490	2 9/9,2:1	85	116	72, 76
28 EC	B		6	92 x 69,8	2784	2 9:1	114	155	75
28 HC	B		6	92 x 69,8	2784	2 9:1	103	140	74
28 S	B		6	92 x 69,8	2784	2 9/9,5:1	92-106	125-145	1, 2, 71, 142
30 NE	B		6	95 x 69,8	2969	2 9,4:1	130-135	177-184	170, 195, 198
4JB1-TC	D	(LA)	4	93 x 102	2771	2 17,5:1	78-85	108-115	111
C 12 NZ	B		4	72 x 73,4	1196	2 9,1:1	33	45	62, 79, 87
C 13 N	B		4	75 x 73,4	1297	2 9:1	44	60	81, 130
C 14 NZ	B		4	77,6 x 73,4	1389	2 9,4:1	40-44	54-60	24, 64, 83, 89, 132
C 14 SE	B		4	77,6 x 73,4	1389	2 9,8:1	60	82	24, 64, 83, 89
C 14 SEL	B		4	77,6 x 73,4	1389	4 9,8:1	60-66	82-90	88, 207
C 16 LZ	B		4	79 x 81,5	1598	2 9,2:1	55	75	18, 135
C 16 LZ2	B		4	79 x 81,5	1598	2 9,2:1	55	75	214
C 16 NZ	B		4	79 x 81,5	1598	2 9,2:1	55	75	17, 26, 86, 135, 214
C 16 NZ2	B		4	79 x 81,5	1598	2 9,2:1	55	75	214
C 16 SE	B		4	79 x 81,5	1598	2 10:1	74	100	26, 86
C 16 SEL	B		4	79 x 81,5	1598	4 9,8:1	74	100	36, 92, 208
C 16 XE	B		4	79 x 81,5	1598	4 10,5:1	80	109	92
C 18 NE	B		4	84,8 x 79,5	1796	2 8,9:1	74	101	21, 139
C 18 NT	B		4	84,8 x 79,5	1796	2 9,2:1	66	90	138
C 18 NV	B		4	84,8 x 79,5	1796	2 8,9:1	74	100	190
C 18 NZ	B		4	84,8 x 79,5	1796	2 9,2:1	66	90	30, 139, 218
C 18 SEL	B		4	84,8 x 79,5	1796	4 10,8:1	85	116	31
C 18 XE	B		4	81,6 x 86	1796	4 10,8:1	92	125	31
C 18 XEL	B		4	81,6 x 86	1796	4 10,8:1	85	116	31
C 20 LET	B	(LA)	4	86 x 86	1998	4 9:1	150	204	60, 221
C 20 NE	B		4	86 x 86	1998	2 9,2:1	85	116	22, 32, 58, 107, 140, 165, 219
C 20 SEL	B		4	86 x 86	1998	4 9,6:1	100	136	227
C 20 XE	B		4	86 x 86	1998	4 10,5:1	110	150	33, 59, 141, 220
C 22 SEL	B		4	86 x 94,6	2198	4 10:1	106	144	230
C 24 NE	B		4	95 x 85	2410	2 9,2:1	92	125	110, 168
C 25 XE	B		6	81,6 x 79,6	2498	4 10,8:1	125	170	61, 222
C 26 NE	B		6	88,8 x 69,8	2594	4 9,2:1	110	150	169, 197
C 30 LE	B		6	95 x 69,8	2969	2 8,6:1	115	156	159, 170, 195, 198
C 30 NE	B		6	95 x 69,8	2969	2 9,2:1	130	177	159, 170, 195, 198
C 30 SE	B		6	95 x 69,8	2969	4 10:1	150	204	171, 199
E 12 GV	B		4	79 x 61	1196	2 8:1	33	45	78
E 16 NZ	B		4	79 x 81,5	1598	2 9,2:1	55-60	75-82	18, 135, 214
E 16 SE	B		4	79 x 81,5	1598	2 10:1	74	100	86
E 18 NV	B		4	84,8 x 79,5	1796	2 9,2:1	62	84	20, 138
E 18 NVR	B		4	84,8 x 79,5	1796	2 8,8:1	65	88	163, 217
F4R 720	B		4	82,7 x 93	1998	4 9,8:1	88	120	240
F9Q 760	D	(A)	4	80 x 93	1870	2 19:1	74	101	239
F9Q 762	D	(A)	4	80 x 93	1870	2 19:1	60	82	238
F9Q 770	D	(A)	4	80 x 93	1870	2 18,3:1	58	79	160
F9Q 772	D	(A)	4	80 x 93	1870	2 18,3:1	60	82	160
F9Q 774	D	(A)	4	80 x 93	1870	2 18,3:1	58-60	79-82	160
G9T 722	D	(A)	4	87 x 92	2188	4 18:1	66	90	161
G9U 630	D	(LA)	4	87 x 92	2464	4 18,1:1	107	145	241
G9U 720	D	(LA)	4	89 x 99	2463	4 21,25:1	73-84	99-115	162
G9U 730	D	(LA)	4	89 x 99	2463	4 18:1	99	135	241
S 18 NV	B		4	84,8 x 79,5	1796	2 9,2:1	60-62	82-84	20, 138, 163
X 12 SZ	B		4	72 x 73,4	1195	2 10:1	33	45	62, 87
X 14 NZ	B		4	77,6 x 73,4	1389	2 9,6:1	44	60	24, 53
X 14 SZ	B		4	77,6 x 73,4	1389	2 9,6:1	44	60	64, 89
X 14 XE	B		4	77,6 x 73,4	1389	4 10,5:1	66	90	25, 34, 65, 88, 207
X 16 SZ	B		4	79 x 81,5	1598	2 10:1	52	71	26, 214
X 16 SZR	B		4	79 x 81,5	1598	2 9,6:1	55	75	26, 35, 54, 223
X 16 XE	B		4	79 x 81,5	1598	4 10,5:1	78	106	92, 208
X 16 XEL	B		4	79 x 81,5	1598	4 10,5:1	74	100	27, 36, 55, 224, 242
X 17 D	D	(AN)	4	79 x 86	1686	2 22:1	44	60	67, 93
X 17 DTL	D	(LA)	4	82,5 x 79,5	1699	2 22:1	50	68	29, 38
X 18 XE	B		4	81,6 x 86	1796	4 10,8:1	85	116	31, 225
X 18 XE1	B		4	80,5 x 88,2	1796	4 10,5:1	85	116	40, 225, 244
X 20 DTH	D	(LA)	4	84 x 90	1995	4 18,5:1	74	101	174, 229
X 20 DTL	D	(A)	4	84 x 90	1995	4 18,5:1	60	82	43, 228, 247
X 20 SE	B		4	86 x 86	1998	4 10:1	85	116	108, 173
X 20 XER	B		4	86 x 86	1998	4 10,8:1	118	160	41, 245

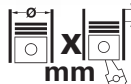

			Cyl	 mm	cm ³		Comp. Ratio ε	kW	PS	Pos
X 20 XEV	B		4	86 x 86	1998	4	10,8:1	100	136	33, 41, 59, 173, 220, 227, 245
X 22 DTH	D	(LA)	4	84 x 98	2172	4	18,5:1	85-92	116-125	112, 203
X 22 XE	B		4	86 x 94,6	2198	4	10,5:1	104	141	109
X 25 TD	D	(LA)	6	80 x 82,8	2498	2	22:1	96	131	178
X 25 XE	B		6	81,6 x 79,6	2498	4	10,8:1	125	170	61, 177, 231, 232
X 30 XE	B		6	86 x 85	2962	4	10,8:1	148	201	179, 204
Y 16 XE	B		4	79 x 81,5	1598	4	10,5:1	74	101	224
Y 16 YNG	G		4	79 x 81,5	1598	4	12,5:1	71	97	99
Y 17 DT	D	(LA)	4	79 x 86	1686	4	18,4:1	55	75	39, 69, 101, 156
Y 17 DTL	D	(LA)	4	79 x 86	1686	4	18,4:1	48	65	68, 100
Y 20 DTH	D	(LA)	4	84 x 90	1995	4	18,5:1	74	100	44, 201, 229, 236, 248
Y 22 DTH	D	(LA)	4	84 x 98	2172	4	18,5:1	85	116	112, 176
Y 22 XE	B		4	86 x 94,6	2198	4	10,5:1	106	144	175
Z 10 XEP	B		3	73,4 x 78,6	998	4	10,5:1	44	60	3, 94, 104
Z 12 XEP	B		4	73,4 x 72,6	1229	4	10,5:1	59	80	4, 46, 95, 105
Z 13 DT	D	(LA)	4	69,6 x 82	1248	4	18:1	51	69	5, 63, 96, 152, 209
Z 14 XE	B		4	77,6 x 73,4	1389	4	10,5:1	66	90	34, 97
Z 14 XEP	B		4	73,4 x 80,6	1364	4	10,5:1	66	90	34, 47, 65, 97, 106, 153, 211
Z 16 SE	B		4	79 x 81,5	1598	2	9,6:1	62	84	35, 66, 98, 154
Z 16 XE	B		4	79 x 81,5	1598	4	10,5:1	74	100	36, 155, 224, 233, 242
Z 16 XEP	B		4	79 x 81,5	1598	4	10,5:1	76	104	36, 48, 155, 233, 250
Z 16 YNG	G		4	79 x 81,5	1598	4	12,5:1	71	97	37, 99, 243
Z 17 DTH	D	(LA)	4	79 x 86	1686	4	18,4:1	74	100	49, 70, 102, 157
Z 18 XE	B		4	80,5 x 88,2	1796	4	10,5:1	90-92	122-125	40, 50, 103, 158, 200, 210, 225, 234, 244
Z 18 XER	B		4	80,5 x 88,2	1796	4	10,5:1	103	140	50, 200, 234, 251
Z 19 DTH	D	(LA)	4	82 x 90,4	1910	4	17,5:1	110	150	51, 202, 235, 252
Z 19 DTJ	D	(LA)	4	82 x 90,4	1910	4	17,5:1	88	120	51
Z 20 LEL	B	(LA)	4	86 x 86	1998	4	8,8:1	125	170	52, 253
Z 20 LER	B	(LA)	4	86 x 86	1988	4	8,8:1	147	200	52, 253
Z 20 LET	B	(LA)	4	86 x 86	1998	4	8,8:1	141	192	42, 205, 246
Z 22 SE	B		4	86 x 94,6	2198	4	10:1	108	147	45, 206, 230, 237, 249

**OPEL****Admiral A 2.8****1**

10.1965→03.1969

28 S

Reference

13 34 032 13 34 035 28 98 355



Lager/bearing/coussinet/cojinete/подшипник: 30 mm



50 005 043

Admiral B 2.8**2**

03.1969→01.1978

28 S

Reference

13 34 032 13 34 035 28 98 355



Lager/bearing/coussinet/cojinete/подшипник: 30 mm



50 005 043

Agila 1.0i 12V**3**

09.2003→

Z 10 XEP

Reference

13 34 145 24469102



50 005 003

NEW

Agila 1.2i 16V**4**

07.2004→

Z 12 XEP

Reference

13 34 145 24469102



50 005 003

NEW

Agila 1.3 CDTI 16V**5**

09.2003→

Z 13 DT

Reference

63 34 001 93177340



50 005 760

O**Ascona A 1.2****6**

04.1972→08.1975

12 S OHV

Reference

13 34 029 28 66 233



50 005 042

Ascona A 1.6**7**

10.1970→08.1975

16 N, 16 S

Reference

13 34 032 13 34 035 28 98 355



Lager/bearing/coussinet/cojinete/подшипник: 30 mm



50 005 043

Ascona A 1.9**8**

03.1971→08.1975

19 S, 19 S CIH

Reference

13 34 032 13 34 035 28 98 355



Lager/bearing/coussinet/cojinete/подшипник: 30 mm



50 005 043

Ascona B 1.2**9**

09.1975→02.1979

12 N, 12 S OHC, 12 S OHV

Reference

13 34 058 92 92 375



50 005 045

**Ascona B 1.3****10**

03.1979→08.1981

13 N, 13 S

Reference

13 34 004
9018327313 34 023
90349241

13 34 070

90076952



50 005 052

Ascona B 1.6**11**

09.1975→08.1981

16 N CIH, 16 S, 16 S CIH

Reference

13 34 032

13 34 035

28 98 355

Lager/bearing/coussinet/cojinete/подшипник: 30 mm



50 005 043

Ascona B 1.9**12**

09.1975→08.1981

19 N, 19 S CIH

Reference

13 34 032

13 34 035

28 98 355

Lager/bearing/coussinet/cojinete/подшипник: 30 mm



50 005 043

Ascona B 2.0**13**

09.1975→08.1981

20 N, 20 S

Reference

13 34 032

13 34 035

28 98 355

Lager/bearing/coussinet/cojinete/подшипник: 30 mm



50 005 043

Ascona B 2.0i**14**

09.1975→08.1981

20 E

Reference

13 34 032

13 34 035

28 98 355

Lager/bearing/coussinet/cojinete/подшипник: 30 mm



50 005 043

Ascona B 2.0 D**15**

08.1978→08.1981

20 D

Reference

13 34 045
90096415
→10268513 34 074
90136382

13 34 087

34 69 874



50 005 053

Ascona C 1.3**16**

09.1981→08.1988

13 N, 13 S

Reference

13 34 004
9018327313 34 023
90349241

13 34 070

90076952



50 005 052

Ascona C 1.6**17**

09.1981→08.1988

16 N OHC, 16 SH

Reference

13 34 008

90220568

90272361

16 N OHC: 14054371→
16 SH: 14391115→

50 005 735

09.1981→08.1988

16 S

Reference

13 34 032

13 34 035

28 98 355

Lager/bearing/coussinet/cojinete/подшипник: 30 mm





50 005 043



**OPEL**

09.1986→08.1988 Reference	16 SV , C 16 NZ 6 46 029 90231887 90273981					50 005 817
09.1986→08.1988 Reference	16 SV , C 16 NZ 13 34 011 13 34 024 90234200 90325661 90349240					50 005 733
09.1981→08.1988 Reference 	16 N OHC, 16 S, 16 SH 6 46 027 6 46 030 90233175 90271451 90295214 16 N OHC: 14054371→ 16 SH : 14387790→ 16 SH : 14391115→					50 005 823
09.1981→08.1988 Reference 	16 N OHC, 16 SH 13 34 013 13 34 084 90106656 90273924 90284802 16 N OHC: →14054370 16 SH : →14391114					50 005 049
Ascona C 1.6i						18
09.1986→08.1988 Reference	C 16 LZ, E 16 NZ 6 46 029 90231887 90273981					50 005 817
09.1986→08.1988 Reference	C 16 LZ 13 34 011 13 34 024 90234200 90325661 90349240					50 005 733
Ascona C 1.6 D						19
03.1982→08.1988 Reference 	16 D, 16 DA 13 34 014 90284913 90295078 14478631→					50 005 736
03.1982→08.1988 Reference 	16 D, 16 DA 13 34 012 13 34 015 13 34 099 90106450 90285418 90295077 →14478630					50 005 055
Ascona C 1.8						20
09.1987→08.1988 Reference	E 18 NV, S 18 NV 13 34 008 90220568 90272361					50 005 735
09.1987→08.1988 Reference	E 18 NV, S 18 NV 6 46 027 6 46 030 90233175 90271451 90295214					50 005 823



**Ascona C 1.8i****21**

09.1986→08.1988	18 SE						
Reference	13 34 008 14237770→	90220568	90272361				50 005 735
09.1982→08.1988	18 E, 18 SE, C 18 NE					50 005 823	
Reference	6 46 027 90295214 18 SE, C 18 NE : 14056061→ 18 SE, C 18 NE : 14237770→	6 46 030	90233175	90271451			
09.1982→08.1988	18 E, 18 SE, C 18 NE						50 005 049
Reference	13 34 013 90284802 18 SE: →14237769	13 34 084	90106656	90273924			

Ascona C 2.0i**22**

09.1986→08.1988	20 NE, 20 SEH, C 20 NE						50 005 735
Reference	13 34 008 20 NE, C 20 NE: →14608700	90220568	90272361				
09.1986→08.1988	20 NE, C 20 NE						50 005 732
Reference	13 34 054 14608701→	90444123					
09.1986→08.1988	20 NE, 20 SEH, C 20 NE					50 005 823	
Reference	6 46 027 90295214	6 46 030	90233175	90271451			

Astra F 1.4**23**

09.1991→09.1993	14 NV						50 005 059
Reference	13 34 025 90325660 19307806→	13 34 065 90349239	13 34 098 9192793	90144227			
09.1991→09.1993	14 NV					50 005 818	
Reference	6 46 009 90369451 14 NV : 02X38362→ 14 NV : 19994743→	6 46 041 90442241	6 46 132 90444316	6 46 133 90541505			
09.1991→09.1993	14 NV						50 005 733
Reference	13 34 011 90349240 →19307805	13 34 024	90234200	90325661			

Astra F 1.4i**24**

09.1991→02.1998	C 14 NZ, C 14 SE						50 005 059
Reference	13 34 025 90325660	13 34 065 90349239	13 34 098 9192793	90144227			

**OPEL**

09.1991→02.1998 Reference	14 SE, C 14 NZ, C 14 SE, X 14 NZ	6 46 009 90369451	6 46 041 90442241	6 46 132 90444316	6 46 133 90541505	 50 005 818
	14 SE, C 14 NZ, C 14 SE, X 14 NZ: 02X38362→ 14 SE, C 14 NZ, C 14 SE, X 14 NZ: 19994743→					
Astra F 1.4i 16V						25
04.1996→02.1998 Reference	X 14 XE	13 34 046	13 34 066	90444079	9192797	 50 005 738
04.1996→02.1998 Reference	X 14 XE	6 46 009 90369451	6 46 041 90442241	6 46 132 90444316	6 46 133 90541505	 50 005 818
04.1996→02.1998 Reference	X 14 XE	13 34 077	63 34 035	9199592	93182038	 50 005 793
	02MV7225/20U75999→					
Astra F 1.6i						26
09.1994→02.1998 Reference	16 LZ2, 16 NZ2	6 46 001	6 46 042	90442362	90541506	 50 005 850
09.1991→02.1998 Reference	C 16 NZ, C 16 SE, X 16 SZ, X 16 SZR	13 34 025 90325660	13 34 065 90349239	13 34 098 9192793	90144227	 50 005 059
	C 16 NZ: 02j22350→					
09.1991→08.1994 Reference	C 16 NZ	13 34 011 90349240	13 34 024	90234200	90325661	 50 005 733
	→02J22349					
Astra F 1.6i 16V						27
08.1994→09.1998 Reference	X 16 XEL	13 34 046	13 34 066	90444079	9192797	 50 005 738
08.1994→09.1998 Reference	X 16 XEL	6 46 009 90369451	6 46 041 90442241	6 46 132 90444316	6 46 133 90541505	 50 005 818
Astra F 1.7 D						28
12.1991→08.1994 Reference	17 D, 17 DR	13 34 014	90284913	90295078		 50 005 736
	→14363651					



12.1991→08.1994 Reference 	17 D, 17 DR 13 34 041 90444311 14363652→	13 34 050	13 34 053	90443549		50 005 734
Astra F 1.7 TD						29
12.1991→02.1998 Reference 	17 TD 13 34 031 13 34 105 97101320 →00855805	13 34 034 94341998 97110387	13 34 052 94386207	13 34 102 97101319		50 005 741
09.1994→02.1998 Reference	X 17 DTL 13 34 041 90444311	13 34 050	13 34 053	90443549		50 005 734
12.1991→02.1998 Reference 	17 TD 13 34 069 00855806→	13 34 115	97114682			50 005 746
Astra F 1.8i						30
09.1991→02.1998 Reference 	C 18 NZ 6 46 001 14254439→	6 46 042	90442362	90541506		50 005 850
09.1991→02.1998 Reference 	18 SE, C 18 NZ 13 34 008 18 SE: 14237770→ C 18 NZ: →14254438	90220568	90272361			50 005 735
09.1991→02.1998 Reference 	C 18 NZ 13 34 054 14254439→	90444123				50 005 732
09.1991→02.1998 Reference 	C 18 NZ 6 46 027 90295214 →14254438	6 46 030	90233175	90271451		50 005 823
09.1995→09.1996 Reference 	18 SE 13 34 013 90284802 →14237769	13 34 084	90106656	90273924		50 005 049
Astra F 1.8i 16V						31
09.1993→02.1998 Reference 	C 18 XE, C 18 XEL, X 18 XE 6 46 001 C 18 XE, X 18 XE: →14261174	6 46 042	90442362	90541506		50 005 850



09.1993→02.1998	C 18 SEL, C 18 XE, C 18 XEL, X 18 XE			50 005 851
Reference	6 46 036 6 46 046 90511958 90541510			
	C 18 XEL: 14056061→ C 18 XE, X 18 XE: 14056061→14261174			
09.1993→02.1998	C 18 XE, C 18 XEL, X 18 XE			50 005 734
Reference	13 34 041 13 34 050 13 34 053 90443549			
	90444311			



Astra F 2.0i**32**

09.1991→09.1998	C 20 NE			50 005 850
Reference	6 46 001 6 46 042 90442362 90541506			
	14608701→			
09.1991→09.1998	C 20 NE			50 005 735
Reference	13 34 008 90220568 90272361			
	→14608700			
09.1991→09.1998	C 20 NE			50 005 732
Reference	13 34 054 90444123			
	14608701→			
09.1991→09.1998	C 20 NE			50 005 823
Reference	6 46 027 6 46 030 90233175 90271451			
	90295214 →14608700			



Astra F 2.0i 16V**33**

01.1995→02.1998	X 20 XEV			50 005 850
Reference	6 46 001 6 46 042 90442362 90541506			
	→14003331			
01.1995→02.1998	X 20 XEV			50 005 851
Reference	6 46 036 6 46 046 90511958 90541510			
	14003332→14315275			
09.1991→02.1998	C 20 XE, X 20 XEV			50 005 734
Reference	13 34 041 13 34 050 13 34 053 90443549			
	90444311 C 20 XE: 14142840→			
01.1995→02.1998	X 20 XEV			50 005 848
Reference	24406585 6 46 052 6 46 056 6 46 067			
	90542273 9118202			
	14315276→			
09.1991→02.1998	C 20 XE			50 005 737
Reference	13 34 017 13 34 038 90281612 90442207			
	→14142839			





**Astra G 1.4i 16V****34**

09.1997→09.2000	X 14 XE							50 005 738
Reference	13 34 046	13 34 066	90444079	9192797				
09.1997→09.2004	X 14 XE, Z 14 XE						50 005 818	
Reference	6 46 009 90369451	6 46 041 90442241	6 46 132 90444316	6 46 133 90541505				
09.2003→03.2004	Z 14 XEP							50 005 003 <small>NEW</small>
Reference	13 34 145	24469102						

Astra G 1.6i**35**

09.1997→08.2000	X 16 SZR							50 005 059
Reference	13 34 025 90325660	13 34 065 90349239	13 34 098 9192793	90144227				
09.1997→06.2004	X 16 SZR, Z 16 SE						50 005 818	
Reference	6 46 009 90369451	6 46 041 90442241	6 46 132 90444316	6 46 133 90541505				
09.2000→06.2004	Z 16 SE							50 005 900
Reference	13 34 078	63 34 039	9199595	93182042				

Astra G 1.6i 16V**36**

09.1997→08.2000	X 16 XEL							50 005 738
Reference	13 34 046	13 34 066	90444079	9192797				
03.2003→06.2004	Z 16 XEP							50 005 006 <small>NEW</small>
Reference	13 34 142	24405895						
09.1997→06.2004	C 16 SEL, X 16 XEL, Z 16 XE, Z 16 XEP						50 005 818	
Reference	6 46 009 90369451	6 46 041 90442241	6 46 132 90444316	6 46 133 90541505				
09.1997→06.2004	X 16 XEL, Z 16 XE							50 005 793
Reference	13 34 077 	63 34 035	9199592	93182038				
	X 16 XEL: 02MV7225/20U75999→							

**OPEL****Astra G 1.6i 16V (Gas)****37**

09.2002→06.2004 Z 16 YNG

Reference 6 46 009 6 46 041 6 46 132 6 46 133
90369451 90442241 90444316 90541505**50 005 818****Astra G 1.7 TD****38**

03.1998→08.2000 X 17 DTL

Reference 13 34 041 13 34 050 13 34 053 90443549
90444311**50 005 734****Astra G 1.7 DTi 16V****39**

09.2000→01.2004 Y 17 DT

Reference 13 34 073 13 34 143 63 34 024 93182028
97251178 97287175**50 005 755****Astra G 1.8i 16V****40**

09.1997→06.2004 X 18 XE1, Z 18 XE

Reference 13 34 135 90543935

**50 005 747****Astra G 2.0i 16V****41**

07.1997→06.2004 X 20 XEV

Reference 13 34 041 13 34 050 13 34 053 90443549
90444311**50 005 734**

07.1997→06.2004 X 20 XER, X 20 XEV

Reference 24406585 6 46 052 6 46 056 6 46 067
90542273 9118202**50 005 848****Astra G 2.0i Turbo 16V****42**

09.2000→06.2004 Z 20 LET

Reference 13 34 041 13 34 050 13 34 053 90443549
90444311**50 005 734****Astra G 2.0 DI 16V****43**

03.1998→08.2000 X 20 DTL

Reference 13 34 117 90540478

**50 005 748****Astra G 2.0 DTi 16V****44**

09.2000→01.2004 Y 20 DTH

Reference 13 34 117 90540478

**50 005 748****O**

**Astra G 2.2i 16V****45**

09.2000→06.2004

Z 22 SE

Reference

13 34 067
93178602

13 34 083

63 34 002

91 94 747



50 005 792

Astra H 1.2i 16V**46**

03.2004→

Z 12 XEP

Reference

13 34 145

24469102



50 005 003

NEW

Astra H 1.4i 16V**47**

03.2004→

Z 14 XEP

Reference

13 34 145

24469102



50 005 003

NEW

Astra H 1.6i 16V**48**

03.2004→

Z 16 XEP

Reference

13 34 142

24405895



50 005 006

NEW

Astra H 1.7 CDTI 16V**49**

03.2004→

Z 17 DTH

Reference

13 34 073
9725117813 34 143
97287175

63 34 024

93182028



50 005 755

Astra H 1.8i 16V**50**

03.2004→

Z 18 XER

Reference

13 34 142

24405895



50 005 006

NEW

03.2004→

Z 18 XER

Reference

13 34 145
→01.2007

24469102



50 005 003

NEW

03.2004→

Z 18 XE

Reference

13 34 135

90543935



50 005 747

**OPEL****Astra H 1.9 CDTI 16V****51**04.2004→
ReferenceZ 19 DTH, Z 19 DTJ
13 34 147**50 005 056**
NEW**Astra H 2.0i Turbo 16V****52**03.2004→
ReferenceZ 20 LEL, Z 20 LER
13 34 139**50 005 074**
NEW**Astra Classic 1.4i****53**09.1997→08.2000
ReferenceX 14 NZ
6 46 009 6 46 041 6 46 132 6 46 133
90369451 90442241 90444316 90541505**50 005 818****Astra Classic 1.6i****54**09.1997→08.2000
ReferenceX 16 SZR
13 34 025 13 34 065 13 34 098 90144227
90325660 90349239 9192793**50 005 059**09.1997→08.2000
ReferenceX 16 SZR
6 46 009 6 46 041 6 46 132 6 46 133
90369451 90442241 90444316 90541505**50 005 818****Astra Classic 1.6i 16V****55**09.1997→08.2000
ReferenceX 16 XEL
13 34 046 13 34 066 90444079 9192797**50 005 738**09.1997→08.2000
ReferenceX 16 XEL
6 46 009 6 46 041 6 46 132 6 46 133
90369451 90442241 90444316 90541505**50 005 818**09.1997→08.2000
ReferenceX 16 XEL
13 34 077 63 34 035 9199592 93182038
02MV7225/20U75999→**50 005 793****Bedford-Blitz 2.0 D****56**10.1978→12.1980
Reference20 D
13 34 045 13 34 074 13 34 087 34 69 874
90096415 90136382
→102685**50 005 053**

O

**Bedford-Blitz 2.3 D****57**

09.1980→07.1987	23 D							
Reference	13 34 045 90096415 →55082	13 34 074 90136382	13 34 087	34 69 874				50 005 053

Calibra 2.0i**58**

06.1990→03.1997	C 20 NE						50 005 850	
Reference	6 46 001	6 46 042	90442362	90541506				
06.1990→03.1997	C 20 NE							50 005 735
Reference	13 34 008 →14608700	90220568	90272361					
06.1990→03.1997	C 20 NE							50 005 732
Reference	13 34 054 14608701→	90444123						
06.1990→03.1997	C 20 NE						50 005 823	
Reference	6 46 027 90295214 N1299999→N9299999	6 46 030	90233175	90271451				

Calibra 2.0i 16V**59**

09.1993→08.1999	X 20 XEV						50 005 850	
Reference	6 46 001 →14003331	6 46 042	90442362	90541506				
09.1993→08.1999	X 20 XEV						50 005 851	
Reference	6 46 036 14003332→14315275	6 46 046	90511958	90541510				
06.1990→08.1999	C 20 XE, X 20 XEV							50 005 734
Reference	13 34 041 90444311 C 20 XE: 14142840→	13 34 050	13 34 053	90443549				
09.1993→08.1999	X 20 XEV						50 005 848	
Reference	24406585 90542273 14315276→	6 46 052 9118202	6 46 056	6 46 067				
06.1990→03.1997	C 20 XE							50 005 737
Reference	13 34 017 →14142839	13 34 038	90281612	90442207				

**Calibra 2.0i Turbo 16V****60**

03.1992→03.1997	C 20 LET							
Reference	13 34 041 90444311 14002935→	13 34 050	13 34 053	90443549				50 005 734

03.1992→03.1997	C 20 LET							
Reference	13 34 017 →14002934	13 34 038	90281612	90442207				50 005 737

Calibra 2.5i 24V**61**

04.1993→03.1997	C 25 XE , X 25 XE							
Reference	13 34 059	13 34 131	90444649	90543277				50 005 224

Combo 1.2i**62**

09.1994→10.2001	12 NZ, C 12 NZ, X 12 SZ							
Reference	13 34 025 90325660	13 34 065 90349239	13 34 098 9192793	90144227				50 005 059

Combo 1.3 CDTi 16V**63**

09.2004→	Z 13 DT							
Reference	63 34 001	93177340						50 005 760

Combo 1.4i**64**

09.1994→10.2001	C 14 NZ , C 14 SE, X 14 SZ							
Reference	13 34 025 90325660	13 34 065 90349239	13 34 098 9192793	90144227				50 005 059

Combo 1.4i 16V**65**

08.1999→10.2001	X 14 XE							
Reference	13 34 046	13 34 066	90444079	9192797				50 005 738

09.2004→	Z 14 XEP							
Reference	13 34 145	24469102						50 005 003 <small>NEW</small>

Combo 1.6i**66**

10.2001→08.2004	Z 16 SE							
Reference	13 34 078	63 34 039	9199595	93182042				50 005 900

**Combo 1.7 D****67**

09.1994→10.2001	X 17 D							
Reference	13 34 031 13 34 105 97101320 →00877697	13 34 034 94341998 97110387	13 34 052 94386207	13 34 102 97101319				50 005 741
09.1994→10.2001	X 17 D							
Reference	13 34 069 00877698→	13 34 115	97114682					50 005 746

Combo 1.7 DI 16V**68**

10.2001→08.2004	Y 17 DTL							
Reference	13 34 073 97251178	13 34 143 97287175	63 34 024	93182028				50 005 755

Combo 1.7 DTI 16V**69**

10.2001→08.2004	Y 17 DT							
Reference	13 34 073 97251178	13 34 143 97287175	63 34 024	93182028				50 005 755

Combo 1.7 CDTi 16V**70**

09.2004→	Z 17 DTH							
Reference	13 34 073 97251178	13 34 143 97287175	63 34 024	93182028				50 005 755

Commodore A 2.8**71**

1965 → 1978	28 S							
Reference	13 34 032 Lager/bearing/coussinet/cojinete/подшипник: 30 mm	13 34 035	28 98 355					50 005 043

Commodore B 2.5**72**

01.1972→07.1978	25 S							
Reference	13 34 032 Lager/bearing/coussinet/cojinete/подшипник: 30 mm	13 34 035	28 98 355					50 005 043

Commodore B 2.5 24V**73**

01.1972→08.1975	25 H							
Reference	13 34 032 Lager/bearing/coussinet/cojinete/подшипник: 30 mm	13 34 035	28 98 355					50 005 043

Commodore B 2.8**74**

03.1975→07.1978	28 HC							
Reference	13 34 032 Lager/bearing/coussinet/cojinete/подшипник: 30 mm	13 34 035	28 98 355					50 005 043

**OPEL****Commodore B 2.8i****75**

01.1969→07.1978 2.8 L, 28 EC

Reference 13 34 032 13 34 035 28 98 355
Lager/bearing/coussinet/cojinete/подшипник: 30 mm**50 005 043****Commodore C 2.5****76**

08.1978→12.1982 25 S

Reference 13 34 032 13 34 035 28 98 355
Lager/bearing/coussinet/cojinete/подшипник: 30 mm**50 005 043****Corsa A 1.0****77**

09.1982→08.1994 10 S

Reference 13 34 027 13 34 071 90091035 90409912

**50 005 051****Corsa A 1.2****78**

09.1982→08.1994 12 NV, 12 ST

Reference 13 34 025 13 34 065 13 34 098 90144227
90325660 90349239 9192793**50 005 059**

01.1985→08.1994 12 NC, E 12 GV

Reference 13 34 027 13 34 071 90091035 90409912

**50 005 051****Corsa A 1.2i****79**

09.1990→08.1994 C 12 NZ

Reference 13 34 025 13 34 065 13 34 098 90144227
90325660 90349239 9192793**50 005 059****Corsa A 1.3****80**

09.1982→08.1994 13 NB, 13 S, 13 SB

Reference 13 34 004 13 34 023 13 34 070 90076952
90183273 90349241**50 005 052****Corsa A 1.3i****81**

09.1985→12.1992 C 13 N

Reference 13 34 004 13 34 023 13 34 070 90076952
90183273 90349241**50 005 052****Corsa A 1.4****82**

01.1990→08.1994 14 NV

Reference 13 34 025 13 34 065 13 34 098 90144227
90325660 90349239 9192793
19307806→**50 005 059****O**



01.1990→08.1994 Reference 	14 NV 6 46 029 14 NV : →02J22349 14 NV : →19307805	90231887	90273981			50 005 817
01.1990→08.1994 Reference 	14 NV 13 34 011 90349240 →19307805	13 34 024	90234200	90325661		50 005 733
Corsa A 1.4i						83
01.1990→08.1994 Reference 	C 14 NZ , C 14 SE 13 34 025 90325660 C 14 NZ : 19311738→	13 34 065 90349239	13 34 098 9192793	90144227		50 005 059
01.1990→08.1994 Reference 	C 14 NZ , C 14 SE 6 46 029 C 14 NZ : →02J22349 C 14 NZ : →19311373	90231887	90273981			50 005 817
01.1990→08.1994 Reference 	C 14 NZ 13 34 011 90349240 →19311737	13 34 024	90234200	90325661		50 005 733
Corsa A 1.5 D						84
09.1987→08.1994 Reference 	15 D 13 34 031 13 34 105 97101320 804795→	13 34 034 94341998 97110387	13 34 052 94386207	13 34 102 97101319		50 005 741
09.1987→08.1994 Reference 	15 D 13 34 016 →804794	94124093				50 005 739
Corsa A 1.5 TD						85
03.1988→08.1994 Reference 	15 TD 13 34 031 13 34 105 97101320 804795→	13 34 034 94341998 97110387	13 34 052 94386207	13 34 102 97101319		50 005 741
03.1988→08.1994 Reference 	15 TD 13 34 121 →76351	13 34 756	97113499	97135548		50 005 749
03.1988→08.1994 Reference 	15 TD 13 34 016 →804794	94124093				50 005 739

**Corsa A 1.6i****86**

05.1988→08.1994	C 16 SE, E 16 SE					50 005 059
Reference	13 34 025 90325660	13 34 065 90349239	13 34 098 9192793	90144227		
05.1988→08.1994	C 16 NZ, C 16 SE, E 16 SE					50 005 817
Reference	6 46 029	90231887	90273981	C 16 NZ, E 16 SE: →02J22349		
05.1988→08.1994	E 16 SE					50 005 733
Reference	13 34 011 90349240	13 34 024	90234200	90325661 →02J22349		

Corsa B 1.2i**87**

09.1994→08.2000	12 NZ, C 12 NZ, X 12 SZ					50 005 059
Reference	13 34 025 90325660	13 34 065 90349239	13 34 098 9192793	90144227		
09.1994→08.2000	12 NZ, C 12 NZ, X 12 SZ					50 005 818
Reference	6 46 009 90369451	6 46 041 90442241	6 46 132 90444316	6 46 133 90541505		

Corsa B 1.4i 16V**88**

09.1994→08.1999	X 14 XE					50 005 738
Reference	13 34 046	13 34 066	90444079	9192797		
09.1994→08.2000	C 14 SEL, X 14 XE					50 005 818
Reference	6 46 009 90369451	6 46 041 90442241	6 46 132 90444316	6 46 133 90541505		



Corsa B 1.4i**89**

09.1994→09.2000	C 14 NZ, C 14 SE, X 14 SZ					50 005 059
Reference	13 34 025 90325660	13 34 065 90349239	13 34 098 9192793	90144227		
09.1994→09.2000	C 14 NZ, C 14 SE, X 14 SZ					50 005 818
Reference	6 46 009 90369451	6 46 041 90442241	6 46 132 90444316	6 46 133 90541505		



Corsa B 1.5 D**90**

09.1994→08.2000	15 D					50 005 741
Reference	13 34 031 13 34 105 97101320	13 34 034 94341998 97110387	13 34 052 94386207	13 34 102 97101319		



**Corsa B 1.5 TD****91**

09.1994→08.2000	15 TD							
Reference	13 34 031 13 34 105 971101320	13 34 034 94341998 97110387	13 34 052 94386207	13 34 102 97101319				50 005 741
09.1994→08.2000	15 TD							
Reference	13 34 121	13 34 756	97113499	97135548				50 005 749

Corsa B 1.6i 16V**92**

09.1994→08.2000	C 16 XE, X 16 XE							
Reference	13 34 046	13 34 066	90444079	9192797				50 005 738
09.1994→08.2000	C 16 SEL, C 16 XE, X 16 XE							
Reference	6 46 009 90369451	6 46 041 90442241	6 46 132 90444316	6 46 133 90541505			50 005 818	

Corsa B 1.7 D**93**

04.1996→08.2000	X 17 D							
Reference	13 34 031 13 34 105 971101320 →00877697	13 34 034 94341998 97110387	13 34 052 94386207	13 34 102 97101319				50 005 741
04.1996→08.2000	X 17 D							
Reference	13 34 069 00877698→	13 34 115	97114682					50 005 746

Corsa C 1.0i 12V**94**

09.2003→	Z 10 XEP							
Reference	13 34 145	24469102						50 005 003 <small>NEW</small>



Corsa C 1.2i 16V**95**

07.2004→	Z 12 XEP							
Reference	13 34 145	24469102						50 005 003 <small>NEW</small>



Corsa C 1.3 CDTi 16V**96**

09.2003→	Z 13 DT							
Reference	63 34 001	93177340						50 005 760

**OPEL****Corsa C 1.4i 16V****97**

09.2000→08.2003	Z 14 XE						50 005 818	
Reference	6 46 009 90369451	6 46 041 90442241	6 46 132 90444316	6 46 133 90541505				
09.2003→	Z 14 XEP							50 005 003 <small>NEW</small>
Reference	13 34 145	24469102						

Corsa C 1.6i**98**

09.2001→11.2006	Z 16 SE						50 005 818	
Reference	6 46 009 90369451	6 46 041 90442241	6 46 132 90444316	6 46 133 90541505				
09.2001→11.2006	Z 16 SE							50 005 900
Reference	13 34 078	63 34 039	9199595	93182042				

Corsa C 1.6i 16V (Gas)**99**

01.2002→	Y 16 YNG, Z 16 YNG						50 005 818	
Reference	6 46 009 90369451	6 46 041 90442241	6 46 132 90444316	6 46 133 90541505				

Corsa C 1.7 DI 16V**100**

09.2000→09.2003	Y 17 DTL							50 005 755
Reference	13 34 073 97251178	13 34 143 97287175	63 34 024	93182028				

Corsa C 1.7 DTI 16V**101**

09.2000→	Y 17 DT							50 005 755
Reference	13 34 073 97251178	13 34 143 97287175	63 34 024	93182028				

Corsa C 1.7 CDTi 16V**102**

06.2003→	Z 17 DTH							50 005 755
Reference	13 34 073 97251178	13 34 143 97287175	63 34 024	93182028				

Corsa C 1.8i 16V**103**

09.2001→	Z 18 XE							50 005 747
Reference	13 34 135	90543935						

O

**Corsa D 1.0i 16V****104**

09.2006→ Reference	Z 10 XEP 13 34 145 24469102		50 005 003 NEW
-----------------------	-------------------------------------	--	--------------------------

Corsa D 1.2i 16V**105**

07.2006→ Reference	Z 12 XEP 13 34 145 24469102		50 005 003 NEW
-----------------------	-------------------------------------	--	--------------------------

Corsa D 1.4i 16V**106**

09.2006→ Reference	Z 14 XEP 13 34 145 24469102		50 005 003 NEW
-----------------------	-------------------------------------	--	--------------------------

Frontera A 2.0i**107**

09.1991→08.1995 Reference 	C 20 NE 6 46 001 6 46 042 90442362 90541506 14608701→		50 005 850
09.1991→08.1995 Reference 	C 20 NE 13 34 008 90220568 90272361 →14608700		50 005 735
09.1991→08.1995 Reference 	C 20 NE 13 34 054 90444123 14608701→		50 005 732
09.1991→08.1995 Reference 	C 20 NE 6 46 027 6 46 030 90233175 90271451 90295214 →14608700		50 005 823

Frontera A 2.0i 16V**108**

02.1995→08.1998 Reference	X 20 SE 13 34 054 90444123		50 005 732
------------------------------	------------------------------------	--	-------------------

Frontera A 2.2i 16V**109**

02.1995→08.1998 Reference 	X 22 XE 6 46 001 6 46 042 90442362 90541506 →TV899999		50 005 850
----------------------------------	--	--	-------------------



02.1995→08.1998 Reference	X 22 XE 13 34 041 90444311	13 34 050	13 34 053	90443549			50 005 734
Frontera A 2.4i							110
09.1991→08.1995 Reference	C 24 NE 13 34 009	13 34 021	90271492	90348231			50 005 740
Frontera A 2.8 TDI							111
02.1995→08.1998	4JB1-TC						50 005 100 <small>NEW</small>
Frontera B 2.2 DTI 16V							112
09.1998→ Reference	X 22 DTH, Y 22 DTH 13 34 117	90540478					50 005 748
GT 1.1							113
09.1968→12.1970 Reference	11 SR 13 34 029	28 66 233					50 005 042
GT 1.9							114
09.1968→08.1973 Reference 	19 S 13 34 032 Lager/bearing/coussinet/cojinete/подшипник: 30 mm	13 34 035	28 98 355				50 005 043
Kadett A 1.0							115
09.1962→08.1965 Reference 	10 N 13 34 058 910301→	92 92 375					50 005 045
09.1962→08.1965 Reference	10 S 13 34 027	13 34 071	90091035	90409912			50 005 051
09.1962→08.1965 Reference 	10 N 13 34 029 →910300	28 66 233					50 005 042

O

**Kadett B 1.1****116**

09.1965→08.1973 11 N, 11 S, 11 SR
 Reference 13 34 029 28 66 233



50 005 042

Kadett B 1.2**117**

08.1971→08.1973 12 S OHV
 Reference 13 34 029 28 66 233



50 005 042

Kadett B 1.9**118**

08.1967→08.1973 19 S
 Reference 13 34 032 13 34 035 28 98 355
 Lager/bearing/coussinet/cojinete/подшипник: 30 mm



50 005 043

Kadett C 1.0**119**

08.1973→07.1979 10 N
 Reference 13 34 058 92 92 375
 910301→



50 005 045

08.1973→07.1979 10 N
 Reference 13 34 029 28 66 233
 →910300



50 005 042

Kadett C 1.2**120**

08.1973→08.1984 12 N, 12 S OHV
 Reference 13 34 058 92 92 375
 910301→



50 005 045

08.1973→08.1984 12 N, 12 S OHV
 Reference 13 34 029 28 66 233
 →910300



50 005 042

Kadett C 1.6**121**

08.1973→07.1979 16 S
 Reference 13 34 032 13 34 035 28 98 355
 Lager/bearing/coussinet/cojinete/подшипник: 30 mm



50 005 043



Kadett C 2.0i**122**

08.1973→07.1979 20 E
 Reference 13 34 032 13 34 035 28 98 355
 Lager/bearing/coussinet/cojinete/подшипник: 30 mm



50 005 043



**Kadett D 1.2****123**

08.1982→08.1984	12 ST							
Reference	13 34 025 90325660	13 34 065 90349239	13 34 098 9192793	90144227				50 005 059
08.1979→07.1986	12 N, 12 S OHC, 12 S OHV							
Reference	13 34 027	13 34 071	90091035	90409912				50 005 051



Kadett D 1.3**124**

08.1979→08.1984	13 N, 13 S							
Reference	13 34 004 90183273	13 34 023 90349241	13 34 070	90076952				50 005 052

Kadett D 1.6**125**

09.1981→08.1984	16 SH							
Reference	13 34 008 14391115→	90220568	90272361					50 005 735
09.1981→08.1984	16 SH							
Reference	13 34 013 90284802 →14391114	13 34 084	90106656	90273924				50 005 049

Kadett D 1.6 D**126**

03.1982→08.1984	16 D							
Reference	13 34 014 14478631→	90284913	90295078					50 005 736
03.1982→08.1984	16 D							
Reference	13 34 012 90285418 →14478630	13 34 015 90295077	13 34 099	90106450				50 005 055

Kadett D 1.8i**127**

02.1983→08.1984	18 E							
Reference	13 34 013 90284802	13 34 084	90106656	90273924				50 005 049

Kadett E 1.2**128**





















09.1984→08.1988	12 ST							
Reference	13 34 025 90325660	13 34 065 90349239	13 34 098 9192793	90144227				50 005 059







09.1984→07.1986 Reference	12 SC 13 34 027	13 34 071	90091035	90409912				50 005 051
Kadett E 1.3								129
09.1984→08.1991 Reference	13 N, 13 NB, 13 S 13 34 004 90183273	13 34 023 90349241	13 34 070	90076952				50 005 052
Kadett E 1.3i								130
09.1985→08.1991 Reference	C 13 N 13 34 004 90183273	13 34 023 90349241	13 34 070	90076952				50 005 052
Kadett E 1.4								131
01.1990→08.1991 Reference 	14 NV 13 34 025 90325660 14 NV : 19307806→	13 34 065 90349239	13 34 098 9192793	90144227				50 005 059
01.1990→08.1991 Reference 	14 NV 6 46 029 14 NV : →02J22349 14 NV : →19307804	90231887	90273981				50 005 817	
01.1990→08.1991 Reference	14 NV 6 46 009 90369451	6 46 041 90442241	6 46 132 90444316	6 46 133 90541505			50 005 818	
01.1990→08.1991 Reference 	14 NV 13 34 011 90349240 →19307805	13 34 024	90234200	90325661				50 005 733
Kadett E 1.4i								132
01.1990→08.1991 Reference 	C 14 NZ 6 46 029 C 14 NZ : →02J22349 C 14 NZ : →19311737	90231887	90273981				50 005 817	
01.1990→08.1991 Reference	C 14 NZ 6 46 009 90369451	6 46 041 90442241	6 46 132 90444316	6 46 133 90541505			50 005 818	
Kadett E 1.5 TD								133
09.1988→08.1991 Reference 	15 TD 13 34 031 13 34 105 97101320 817253→	13 34 034 94341998 97110387	13 34 052 94386207	13 34 102 97101319				50 005 741

O



						
09.1988→08.1991 Reference 	15 TD 13 34 016 →817252	94124093				50 005 739
Kadett E 1.6						134
09.1986→08.1991 Reference 	16 SV 13 34 025 90325660 02j22350→	13 34 065 90349239	13 34 098 9192793	90144227		50 005 059
09.1984→08.1991 Reference 	16 S 13 34 032 Lager/bearing/coussinet/cojinete/подшипник: 30 mm	13 34 035	28 98 355			50 005 043
09.1986→08.1991 Reference 	16 SV 6 46 029 →02J22349	90231887	90273981			50 005 817
09.1986→08.1991 Reference	16 SV 6 46 009 90369451	6 46 041 90442241	6 46 132 90444316	6 46 133 90541505		50 005 818
09.1986→08.1991 Reference 	16 SV 13 34 011 90349240 →02J22349	13 34 024	90234200	90325661		50 005 733
09.1984→08.1991 Reference 	16 S 6 46 027 90295214 16 S: →14387790 16 S: →14391115	6 46 030	90233175	90271451		50 005 823
Kadett E 1.6i						135
09.1986→08.1993 Reference 	C 16 LZ, C 16 NZ, E 16 NZ 6 46 029 →02J22349	90231887	90273981			50 005 817
09.1986→08.1993 Reference	C 16 LZ, C 16 NZ, E 16 NZ 6 46 009 90369451	6 46 041 90442241	6 46 132 90444316	6 46 133 90541505		50 005 818
09.1986→08.1993 Reference	C 16 LZ 13 34 011 90349240	13 34 024	90234200	90325661		50 005 733

**Kadett E 1.6 D****136**

09.1984→01.1989	16 D, 16 DA						
Reference	13 34 014 14478631→	90284913	90295078				50 005 736
							
09.1984→01.1989	16 D, 16 DA						
Reference	13 34 012 90285418 →14478630	13 34 015 90295077	13 34 099	90106450			50 005 055
							



Kadett E 1.7 D**137**

02.1989→08.1991	17 D						
Reference	13 34 014	90284913	90295078				50 005 736























Kadett E 1.8**138**

06.1985→08.1991	C 18 NT, E 18 NV, S 18 NV						
Reference	6 46 001 C 18 NT: 14254439→	6 46 042	90442362	90541506		50 005 850	
							
09.1986→08.1991	E 18 NV, S 18 NV						
Reference	13 34 008	90220568	90272361				50 005 735
							
06.1985→08.1991	C 18 NT, E 18 NV, S 18 NV						
Reference	6 46 027 90295214 C 18 NT: →14254438	6 46 030	90233175	90271451		50 005 823	
							
06.1985→08.1986	C 18 NT						
Reference	13 34 013 90284802	13 34 084	90106656	90273924			50 005 049
							

Kadett E 1.8i**139**

06.1985→08.1991	C 18 NE , C 18 NZ						
Reference	6 46 001 C 18 NZ: 14254439→	6 46 042	90442362	90541506		50 005 850	
							
09.1986→08.1991	18 SE, C 18 NZ						
Reference	13 34 008 18 SE: 14237770→ C 18 NZ: →14254438	90220568	90272361				50 005 735
							
09.1990→08.1991	C 18 NZ						
Reference	13 34 054 14254439→	90444123					50 005 732
							

**OPEL**

						
09.1984→08.1991	18 E, 18 SE, C 18 NE, C 18 NZ					
Reference	6 46 027 90295214 C 18 NE : 14056061→ 18 SE: 14056061→14270601 C 18 NE : 14237770→ 18 SE: 14237770→14270601 C 18 NZ: →14254438	6 46 030	90233175	90271451		50 005 823
						
09.1984→08.1991	18 E, 18 SE, C 18 NE					
Reference	13 34 013 90284802 18 SE: →14237769	13 34 084	90106656	90273924		50 005 049
						
Kadett E 2.0i						140
09.1986→08.1991	20 NE, 20 SEH, 20 SER, C 20 NE					
Reference	6 46 001 20 NE, C 20 NE: 14608701→	6 46 042	90442362	90541506		50 005 850
						
09.1986→08.1991	20 NE, 20 SEH, C 20 NE					
Reference	13 34 008 20 NE, C 20 NE: →14608700	90220568	90272361			50 005 735
						
09.1986→08.1991	20 NE, C 20 NE					
Reference	13 34 054 14608701→	90444123				50 005 732
						
09.1986→08.1991	20 NE, 20 SEH, 20 SER, C 20 NE					
Reference	6 46 027 90295214 →14608700	6 46 030	90233175	90271451		50 005 823
						
Kadett E 2.0i 16V						141
03.1988→08.1991	20 XE, C 20 XE					
Reference	13 34 041 90444311 20 XE: 14142839→ C 20 XE: 14142840→	13 34 050	13 34 053	90443549		50 005 734
						
03.1988→08.1991	20 XE, C 20 XE					
Reference	13 34 017 20 XE: →14142838 C 20 XE: →14142839	13 34 038	90281612	90442207		50 005 737
						
Kapitän 2.8						142
1965 → 1978	28 S					
Reference	13 34 032 Lager/bearing/coussinet/cojinete/подшипник: 30 mm	13 34 035	28 98 355			50 005 043
						
Manta A 1.2						143
04.1972→08.1975	12 S OHV					
Reference	13 34 029	28 66 233				50 005 042

**Manta A 1.6****144**

09.1970→08.1975 16 N, 16 N CIH, 16 S
 Reference 13 34 032 13 34 035 28 98 355
 Lager/bearing/coussinet/cojinete/подшипник: 30 mm



50 005 043

Manta A 1.9**145**

09.1970→08.1975 19 S
 Reference 13 34 032 13 34 035 28 98 355
 Lager/bearing/coussinet/cojinete/подшипник: 30 mm



50 005 043

Manta B 1.2**146**

09.1975→08.1981 12 S OHC, 12 S OHV
 Reference 13 34 058 92 92 375



50 005 045

Manta B 1.3**147**

03.1979→08.1986 13 N, 13 S
 Reference 13 34 004 13 34 023 13 34 070 90076952
 90183273 90349241



50 005 052

Manta B 1.6**148**

09.1975→12.1981 16 N, 16 N CIH, 16 S, 16 S CIH
 Reference 13 34 032 13 34 035 28 98 355
 Lager/bearing/coussinet/cojinete/подшипник: 30 mm



50 005 043

Manta B 1.8**149**

07.1982→08.1987 18 S
 Reference 13 34 013 13 34 084 90106656 90273924
 90284802



50 005 049

Manta B 1.9**150**

09.1975→12.1980 19 N, 19 S, 19 S CIH
 Reference 13 34 032 13 34 035 28 98 355
 Lager/bearing/coussinet/cojinete/подшипник: 30 mm



50 005 043

Manta B 2.0**151**

09.1975→08.1985 20 N, 20 S
 Reference 13 34 032 13 34 035 28 98 355
 Lager/bearing/coussinet/cojinete/подшипник: 30 mm



50 005 043

Meriva 1.3 CDTi 16V**152**

09.2003→ Z 13 DT
 Reference 63 34 001 93177340





50 005 760



**Meriva 1.4i 16V****153**

09.2004→	Z 14 XEP							
Reference	13 34 145	24469102						50 005 003 <small>NEW</small>

Meriva 1.6i**154**

03.2003→	Z 16 SE							
Reference	6 46 009 90369451	6 46 041 90442241	6 46 132 90444316	6 46 133 90541505			50 005 818	
03.2003→	Z 16 SE							
Reference	13 34 078	63 34 039	9199595	93182042				50 005 900

Meriva 1.6i 16V**155**

02.2006→	Z 16 XEP							
Reference	13 34 142	24405895						50 005 006 <small>NEW</small>
03.2003→02.2006	Z 16 XE							
Reference	6 46 009 90369451	6 46 041 90442241	6 46 132 90444316	6 46 133 90541505			50 005 818	
03.2003→02.2006	Z 16 XE							
Reference	13 34 077	63 34 035	9199592	93182038				50 005 793

Meriva 1.7 DTI 16V**156**

03.2003→	Y 17 DT							
Reference	13 34 073 97251178	13 34 143 97287175	63 34 024	93182028				50 005 755

Meriva 1.7 CDTI 16V**157**

03.2003→	Z 17 DTH							
Reference	13 34 073 97251178	13 34 143 97287175	63 34 024	93182028				50 005 755













Meriva 1.8i 16V**158**

03.2003→	Z 18 XE							
Reference	13 34 135	90543935						50 005 747



Monza A 3.0i 159						
09.1985→08.1986 Reference	C 30 LE, C 30 NE 13 34 009	13 34 021	90271492	90348231		50 005 740
Movano 1.9 DTI 160						
01.1999→10.2001 Reference	F9Q 770 44 09 162					50 005 301
01.1999→ Reference	F9Q 770, F9Q 772, F9Q 774 44 08 028					50 005 756
Movano 2.2 DTI 16V 161						
09.2000→ Reference	G9T 722 44 01 595	45 06 045	9109595	9201450		50 005 794
Movano 2.5 CDTI 16V 162						
10.2001→ Reference	G9U 720 44 01 595	45 06 045	9109595	9201450		50 005 794
Omega A 1.8 163						
09.1986→03.1994 Reference 	18 NV, 18 SV, E 18 NVR, S 18 NV 6 46 001 14270601→	6 46 042	90442362	90541506		50 005 850
09.1986→03.1994 Reference	18 NV, 18 SV, S 18 NV 13 34 008	90220568	90272361			50 005 735
09.1986→03.1994 Reference 	18 NV, 18 SV, E 18 NVR, S 18 NV 6 46 027 90295214 →14270600	6 46 030	90233175	90271451		50 005 823
Omega A 1.8i 164						
09.1986→03.1994 Reference 	18 SEH 6 46 001 14270601→	6 46 042	90442362	90541506		50 005 850
09.1986→03.1994 Reference	18 SEH 13 34 008	90220568	90272361			50 005 735



							
09.1986→03.1994 Reference	18 SEH 6 46 027 90295214 →14270600	6 46 030	90233175	90271451		50 005 823	
Omega A 2.0i							165
09.1986→03.1994 Reference	20 SE, C 20 NE 6 46 001 14608701→	6 46 042	90442362	90541506		50 005 850	
09.1986→03.1994 Reference	20 SE, C 20 NE 13 34 008 →14608700	90220568	90272361				50 005 735
09.1986→03.1994 Reference	20 SE, C 20 NE 13 34 054 14608701→	90444123					50 005 732
09.1986→03.1994 Reference	20 SE, C 20 NE 6 46 027 90295214 →14608700	6 46 030	90233175	90271451		50 005 823	
Omega A 2.3 D							166
09.1986→03.1994 Reference	23 YD 13 34 009	13 34 021	90271492	90348231			50 005 740
Omega A 2.3 TD							167
09.1986→03.1994 Reference	23 DTR , 23 YDT 13 34 009	13 34 021	90271492	90348231			50 005 740
Omega A 2.4i							168
09.1988→03.1994 Reference	C 24 NE 13 34 009	13 34 021	90271492	90348231			50 005 740
Omega A 2.6i							169
09.1990→03.1994 Reference	C 26 NE 13 34 009	13 34 021	90271492	90348231			50 005 740

O

**Omega A 3.0i****170**

03.1987→03.1994	30 NE, C 30 LE, C 30 NE					50 005 740
Reference	13 34 009	13 34 021	90271492	90348231		

Omega A 3.0i 24V**171**

09.1989→03.1994	C 30 SE					50 005 740
Reference	13 34 009	13 34 021	90271492	90348231		

Omega B 2.0i**172**

04.1994→08.1998	20 SE					50 005 850
Reference	6 46 001	6 46 042	90442362	90541506		
04.1994→08.1998	20 SE					50 005 735
Reference	13 34 008 →14608700	90220568	90272361			
04.1994→08.1998	20 SE					50 005 732
Reference	13 34 054 14608701→	90444123				

Omega B 2.0i 16V**173**

09.1993→08.1999	X 20 SE, X 20 XEV					50 005 850
Reference	6 46 001	6 46 042	90442362	90541506		
09.1993→08.1999	X 20 XEV					50 005 851
Reference	6 46 036 →31000031	6 46 046	90511958	90541510		
04.1994→08.1998	X 20 SE					50 005 732
Reference	13 34 054	90444123				
09.1993→08.1999	X 20 XEV					50 005 734
Reference	13 34 041 90444311	13 34 050	13 34 053	90443549		
09.1993→08.1999	X 20 XEV					50 005 848
Reference	24406585 90542273 X 20 XEV: 14384800→ X 20 XEV: 31027954→	6 46 052 9118202	6 46 056	6 46 067		

**OPEL****Omega B 2.0 DTI 16V****174**09.1997→08.2000 X 20 DTH
Reference 13 34 117 90540478

50 005 748

Omega B 2.2i 16V**175**09.1999→09.2003 Y 22 XE
Reference 13 34 13950 005 074
NEW**Omega B 2.2 DTI 16V****176**06.2000→09.2003 Y 22 DTH
Reference 13 34 117 90540478

50 005 748

Omega B 2.5i 24V**177**04.1994→11.2000 X 25 XE
Reference 13 34 059 13 34 131 90444649 90543277

50 005 224

Omega B 2.5 TD**178**08.1996→02.2001 X 25 TD
Reference 13 34 101 13 34 112 13 34 124 90512535
90541671

50 005 516

Omega B 3.0i 24V**179**04.1994→02.2001 X 30 XE
Reference 13 34 059 13 34 131 90444649 90543277

50 005 224

Rekord C 1.5**180**08.1966→12.1971 1.5L
Reference 13 34 032 13 34 035 28 98 355
Lager/bearing/coussinet/cojinete/подшипник: 30 mm

50 005 043

Rekord C 1.7**181**08.1966→12.1971 17 N, 17 S
Reference 13 34 032 13 34 035 28 98 355
Lager/bearing/coussinet/cojinete/подшипник: 30 mm

50 005 043

Rekord C 1.9**182**08.1966→12.1971 19 S
Reference 13 34 032 13 34 035 28 98 355
Lager/bearing/coussinet/cojinete/подшипник: 30 mm

50 005 043

**Rekord D 1.7****183**

01.1972→08.1977

17 N, 17 S

Reference

13 34 032 13 34 035 28 98 355



Lager/bearing/coussinet/cojinete/подшипник: 30 mm



50 005 043

Rekord D 1.9**184**

01.1972→08.1977

19 N, 19 SH

Reference

13 34 032 13 34 035 28 98 355



Lager/bearing/coussinet/cojinete/подшипник: 30 mm



50 005 043

Rekord D 2.0**185**

09.1975→08.1977

20 S

Reference

13 34 032 13 34 035 28 98 355



Lager/bearing/coussinet/cojinete/подшипник: 30 mm



50 005 043

Rekord D 2.0 D**186**

08.1974→08.1977

20 D

Reference

13 34 045 13 34 074 13 34 087 34 69 874
90096415 90136382
→102685

50 005 053

Rekord D 2.1 D**187**

09.1972→08.1977

21 D

Reference

13 34 045 13 34 074 13 34 087 34 69 874
90096415 90136382

50 005 053

Rekord E 1.7**188**

09.1977→10.1982

17 N

Reference

13 34 032 13 34 035 28 98 355



Lager/bearing/coussinet/cojinete/подшипник: 30 mm



50 005 043

Rekord E 1.8**189**

11.1982→08.1986

18 N, 18 S

Reference

13 34 013 13 34 084 90106656 90273924
90284802

50 005 049

Rekord E 1.8i**190**

05.1985→08.1986

C 18 NV

Reference

13 34 013 13 34 084 90106656 90273924
90284802

50 005 049

Rekord E 2.0**191**

08.1979→08.1986

20 N, 20 S

Reference

13 34 032 13 34 035 28 98 355



Lager/bearing/coussinet/cojinete/подшипник: 30 mm



50 005 043

**Rekord E 2.0 D****192**

09.1977→10.1982

20 D

Reference

13 34 045
90096415
→10268513 34 074
90136382

13 34 087

34 69 874

**50 005 053****Rekord E 2.1 D****193**

09.1977→07.1978

21 D

Reference

13 34 045
9009641513 34 074
90136382

13 34 087

34 69 874

**50 005 053****Rekord E 2.3 D****194**

08.1978→08.1986

23 D

Reference

13 34 045
90096415
→5508213 34 074
90136382

13 34 087

34 69 874

**50 005 053****Senator A 3.0i****195**

09.1985→

30 NE, C 30 LE, C 30 NE

Reference

13 34 009

13 34 021

90271492

90348231

**50 005 740****Senator B 2.5i****196**

09.1987→12.1989

25 NE

Reference

13 34 009

13 34 021

90271492

90348231

**50 005 740****Senator B 2.6i****197**

09.1990→09.1993

C 26 NE

Reference

13 34 009

13 34 021

90271492

90348231

**50 005 740****Senator B 3.0i****198**

09.1987→09.1993

30 NE, C 30 LE, C 30 NE

Reference

13 34 009

13 34 021

90271492

90348231

**50 005 740****Senator B 3.0i 24V****199**

09.1989→09.1993

C 30 SE

Reference

13 34 009

13 34 021

90271492

90348231

**50 005 740**

O

**Signum 1.8i 16V****200**

10.2005→ Reference	Z 18 XER 13 34 142	24405895				50 005 006 <small>NEW</small>
05.2003→ Reference	Z 18 XE 13 34 135	90543935				50 005 747

Signum 2.0 16V DTI**201**

05.2003→ Reference	Y 20 DTH 13 34 117	90540478				50 005 748
-----------------------	-----------------------	----------	--	---	--	------------

Signum 1.9 CDTI 16V**202**

03.2004→ Reference	Z 19 DTH 13 34 147					50 005 056 <small>NEW</small>
-----------------------	-----------------------	--	--	--	--	----------------------------------

Sintra 2.2 TDI 16V**203**

09.1997→09.1999 Reference	X 22 DTH 13 34 117	90540478				50 005 748
------------------------------	-----------------------	----------	--	---	--	------------

Sintra 3.0i 24V**204**

09.1996→09.1999 Reference	X 30 XE 13 34 059	13 34 131	90444649	90543277		50 005 224
------------------------------	----------------------	-----------	----------	----------	---	------------

Speedster 2.0i Turbo 16V**205**

04.2003→ Reference	Z 20 LET 13 34 041 90444311	13 34 050	13 34 053	90443549		50 005 734
-----------------------	-----------------------------------	-----------	-----------	----------	---	------------

Speedster 2.2i 16V**206**

09.2000→ Reference	Z 22 SE 13 34 067 93178602	13 34 083	63 34 002	91 94 747		50 005 792
-----------------------	----------------------------------	-----------	-----------	-----------	---	------------

**OPEL****Tigra 1.4i 16V****207**

09.1994→08.1999	X 14 XE							
Reference	13 34 046	13 34 066	90444079	9192797				50 005 738

09.1994→08.1999	C 14 SEL, X 14 XE							
Reference	6 46 009 90369451	6 46 041 90442241	6 46 132 90444316	6 46 133 90541505				50 005 818

Tigra 1.6i 16V**208**

09.1994→08.1999	X 16 XE							
Reference	13 34 046	13 34 066	90444079	9192797				50 005 738

09.1994→08.1999	C 16 SEL, X 16 XE							
Reference	6 46 009 90369451	6 46 041 90442241	6 46 132 90444316	6 46 133 90541505				50 005 818

Tigra B 1.3 CDTi 16V**209**

12.2004→	Z 13 DT							
Reference	63 34 001	93177340						50 005 760

Tigra B 1.8i 16V**210**

09.2004→	Z 18 XE							
Reference	13 34 135	90543935						50 005 747

Tigra B 1.4i 16V**211**

09.2004→	Z 14 XEP							
Reference	13 34 145	24469102						50 005 003 <small>NEW</small>

Vectra A 1.4**212**

09.1988→09.1992	14 NV							
Reference	13 34 025 90325660 19307806→	13 34 065 90349239	13 34 098 9192793	90144227				50 005 059

09.1988→09.1992	14 NV							
Reference	6 46 029 14 NV : →02J22349 14 NV : →19307806	90231887	90273981					50 005 817



09.1988→09.1992 Reference 	14 NV 6 46 009 90369451 →02X38361	6 46 041 90442241	6 46 132 90444316	6 46 133 90541505		50 005 818
09.1988→09.1992 Reference 	14 NV 13 34 011 90349240 →19307805	13 34 024	90234200	90325661		50 005 733
Vectra A 1.6						213
09.1988→08.1995 Reference 	16 SV 13 34 025 90325660 02J22350→	13 34 065 90349239	13 34 098 9192793	90144227		50 005 059
09.1988→08.1995 Reference 	16 SV 6 46 029 16 SV : →02J22349 16 SV : →19307806	90231887	90273981			50 005 817
09.1988→08.1995 Reference 	16 SV 6 46 009 90369451 →02X38361	6 46 041 90442241	6 46 132 90444316	6 46 133 90541505		50 005 818
09.1988→08.1995 Reference 	16 SV 13 34 011 90349240 →02J22349	13 34 024	90234200	90325661		50 005 733
Vectra A 1.6i						214
09.1992→08.1995 Reference	C 16 LZ2, C 16 NZ2 6 46 001	6 46 042	90442362	90541506		50 005 850
09.1993→08.1995 Reference	X 16 SZ 13 34 025 90325660	13 34 065 90349239	13 34 098 9192793	90144227		50 005 059
09.1988→08.1995 Reference 	C 16 NZ, E 16 NZ, X 16 SZ 6 46 029 C 16 NZ, E 16 NZ, X 16 SZ: →02J22349 C 16 NZ, E 16 NZ, X 16 SZ: →19307806	90231887	90273981			50 005 817
09.1988→08.1995 Reference 	C 16 NZ, E 16 NZ, X 16 SZ 6 46 009 90369451 →02X38361	6 46 041 90442241	6 46 132 90444316	6 46 133 90541505		50 005 818

**OPEL****Vectra A 1.7 D****215**

10.1988→08.1995	17 D, 17 DR						
Reference	13 34 014	90284913	90295078				50 005 736
	→14333449						
10.1988→08.1995	17 D, 17 DR						
Reference	13 34 041	13 34 050	13 34 053	90443549			50 005 734
	90444311						
	14333450→						

Vectra A 1.7 TD**216**

03.1990→08.1995	17 TD						
Reference	13 34 069	13 34 115	97114682				50 005 746

Vectra A 1.8**217**

09.1988→08.1995	18 SV, E 18 NVR						
Reference	6 46 001	6 46 042	90442362	90541506			50 005 850
	18 SV: 14254439→						
	E 18 NVR: 14270601→						
09.1989→08.1995	18 SV						
Reference	13 34 008	90220568	90272361				50 005 735
09.1988→08.1995	18 SV, E 18 NVR						
Reference	6 46 027	6 46 030	90233175	90271451			50 005 823
	90295214						
	18 SV: →14254438						
	E 18 NVR: →14270600						



Vectra A 1.8i**218**

03.1990→08.1995	C 18 NZ						
Reference	6 46 001	6 46 042	90442362	90541506			50 005 850
	14270601→						
03.1990→08.1995	C 18 NZ						
Reference	13 34 008	90220568	90272361				50 005 735
	→14254438						
03.1990→08.1995	C 18 NZ						
Reference	13 34 054	90444123					50 005 732
	14254439→						
03.1990→08.1995	C 18 NZ						
Reference	6 46 027	6 46 030	90233175	90271451			50 005 823
	90295214						
	→14270600						



**Vectra A 2.0i****219**

09.1988→08.1995	20 NE, 20 SEH, C 20 NE						
Reference	6 46 001	6 46 042	90442362	90541506		50 005 850	
	14608701→						
09.1988→08.1995	20 NE, 20 SEH, C 20 NE						
Reference	13 34 008	90220568	90272361				50 005 735
	20 NE, 20 SEH: →ch. N5999999						
	C 20 NE: ch→N5999999						
09.1988→08.1995	20 NE, 20 SEH, C 20 NE						
Reference	13 34 054	90444123					50 005 732
	ch P1/5/7000001→						
09.1988→08.1995	20 NE, 20 SEH, C 20 NE						
Reference	6 46 027	6 46 030	90233175	90271451		50 005 823	
	90295214						
	→14608700						

Vectra A 2.0i 16V**220**

11.1993→08.1995	X 20 XEV						
Reference	6 46 001	6 46 042	90442362	90541506		50 005 850	
09.1989→08.1995	C 20 XE, X 20 XEV						
Reference	13 34 041	13 34 050	13 34 053	90443549			50 005 734
	90444311						
	C 20 XE: 14142840→						
09.1989→08.1995	C 20 XE						
Reference	13 34 017	13 34 038	90281612	90442207			50 005 737
	→14142839						



Vectra A 2.0i Turbo 16V**221**

09.1992→08.1995	C 20 LET						
Reference	13 34 041	13 34 050	13 34 053	90443549			50 005 734
	90444311						
	14142839→						
09.1992→08.1995	C 20 LET						
Reference	13 34 017	13 34 038	90281612	90442207			50 005 737
	→14142838						





Vectra A 2.5i 24V**222**

02.1993→08.1995	C 25 XE						
Reference	13 34 059	13 34 131	90444649	90543277			50 005 224

**Vectra B 1.6i****223**

09.1995→12.1998	16 LZ2							
Reference	6 46 001	6 46 042	90442362	90541506		50 005 850		
09.1996→09.2000	X 16 SZR							
Reference	13 34 025 90325660	13 34 065 90349239	13 34 098 9192793	90144227			50 005 059	
09.1996→09.2000	X 16 SZR							
Reference	6 46 009 90369451	6 46 041 90442241	6 46 132 90444316	6 46 133 90541505		50 005 818		

Vectra B 1.6i 16V**224**

09.1995→08.2000	X 16 XEL							
Reference	13 34 046	13 34 066	90444079	9192797			50 005 738	
09.1995→09.2002	X 16 XEL, Y 16 XE, Z 16 XE							
Reference	6 46 009 90369451	6 46 041 90442241	6 46 132 90444316	6 46 133 90541505		50 005 818		
09.1995→09.2002	X 16 XEL, Z 16 XE							
Reference	13 34 077  X 16 XEL: 02MZ5254/20U75999→	63 34 035	9199592	93182038			50 005 793	

Vectra B 1.8i 16V**225**

09.1995→08.2000	X 18 XE							
Reference	6 46 036  →14261174	6 46 046	90511958	90541510		50 005 851		
09.1995→08.2000	X 18 XE							
Reference	13 34 041 90444311	13 34 050	13 34 053	90443549			50 005 734	
09.1998→09.2002	X 18 XE1, Z 18 XE							
Reference	13 34 135	90543935					50 005 747	
09.1995→08.2000	X 18 XE							
Reference	24406585 90542273 14372573→ 	6 46 052 9118202	6 46 056	6 46 067		50 005 848		





Vectra B 2.0i							226
09.1995→09.1999 Reference	20 NEJ 6 46 036	6 46 046	90511958	90541510		50 005 851	
09.1995→09.1999 Reference	20 NEJ 13 34 054	90444123					50 005 732
Vectra B 2.0i 16V							227
09.1995→09.2002 Reference	C 20 SEL, X 20 XEV 6 46 036 6 46 046 C 20 SEL: →25001463 X 20 XEV: →31000031		90511958	90541510		50 005 851	
09.1995→08.2001 Reference	X 20 XEV 13 34 041 13 34 050 90444311		13 34 053	90443549			50 005 734
09.1995→09.2002 Reference	C 20 SEL, X 20 XEV 24406585 6 46 052 90542273 9118202 X 20 XEV: 14390219→ X 20 XEV: 31027954→		6 46 056	6 46 067		50 005 848	
Vectra B 2.0 DI 16V							228
09.1996→08.2000 Reference	X 20 DTL 13 34 117	90540478					50 005 748
Vectra B 2.0 DTI 16V							229
09.1997→09.2002 Reference	X 20 DTH, Y 20 DTH 13 34 117	90540478					50 005 748
Vectra B 2.2i 16V							230
09.2000→09.2002 Reference	Z 22 SE 13 34 067 13 34 083 93178602		63 34 002	91 94 747			50 005 792
06.2000→09.2002 Reference	C 22 SEL 24406585 6 46 052 90542273 9118202		6 46 056	6 46 067		50 005 848	
Vectra B 2.5i 24V							231
09.1995→09.2000 Reference	X 25 XE 13 34 059	13 34 131	90444649	90543277			50 005 224



**OPEL****Vectra B 500 2.5i 24V****232**

05.1998→09.2000	X 25 XE							
Reference	13 34 059	13 34 131	90444649	90543277				50 005 224

Vectra C 1.6i 16V**233**

09.2001→	Z 16 XEP							50 005 006 <small>NEW</small>
Reference	13 34 142	24405895						
09.2001→	Z 16 XE						50 005 818	
Reference	6 46 009 90369451	6 46 041 90442241	6 46 132 90444316	6 46 133 90541505				
09.2001→	Z 16 XE							50 005 793
Reference	13 34 077	63 34 035	9199592	93182038				

Vectra C 1.8i 16V**234**

01.2006→	Z 18 XER							50 005 006 <small>NEW</small>
Reference	13 34 142	24405895						
09.2001→	Z 18 XE							50 005 747
Reference	13 34 135	90543935						

Vectra C 1.9 CDTI 16V**235**

03.2004→	Z 19 DTH							50 005 056 <small>NEW</small>
Reference	13 34 147							

Vectra C 2.0 DTI 16V**236**

04.2002→	Y 20 DTH							50 005 748
Reference	13 34 117	90540478						

Vectra C 2.2i 16V**237**

09.2001→	Z 22 SE							50 005 792
Reference	13 34 067 93178602	13 34 083	63 34 002	91 94 747				

O

**Vivaro 1.9 DI****238**03.2001→
ReferenceF9Q 762
44 08 028**50 005 756****Vivaro 1.9 DTI****239**03.2001→
ReferenceF9Q 760
44 08 028**50 005 756****Vivaro 2.0i 16V****240**03.2001→
ReferenceF4R 720
44 08 028**50 005 756****Vivaro 2.5 CDTI 16V****241**09.2002→
ReferenceG9U 630, G9U 730
44 01 595 45 06 045 9109595 9201450**50 005 794****Zafira A 1.6i 16V****242**03.1999→08.1999
ReferenceX 16 XEL
13 34 046 13 34 066 90444079 9192797**50 005 738**03.1999→07.2005
ReferenceX 16 XEL, Z 16 XE
6 46 009 6 46 041 6 46 132 6 46 133
90369451 90442241 90444316 90541505**50 005 818**03.1999→07.2005
ReferenceX 16 XEL, Z 16 XE
13 34 077 63 34 035 9199592 93182038
X 16 XEL: 02MV7225/20U75999→**50 005 793****Zafira A 1.6i 16V (Gas)****243**09.2001→
ReferenceZ 16 YNG
6 46 009 6 46 041 6 46 132 6 46 133
90369451 90442241 90444316 90541505**50 005 818****Zafira A 1.8i 16V****244**03.1999→
ReferenceX 18 XE1, Z 18 XE
13 34 135 90543935**50 005 747**

**OPEL****Zafira A 2.0i 16V****245**

02.1999→07.2005	X 20 XEV							
Reference	13 34 041 90444311	13 34 050	13 34 053	90443549				50 005 734

02.1999→07.2005	X 20 XER, X 20 XEV							
Reference	24406585 90542273	6 46 052 9118202	6 46 056	6 46 067			50 005 848	

Zafira A 2.0i Turbo 16V**246**

09.2001→	Z 20 LET							
Reference	13 34 041 90444311	13 34 050	13 34 053	90443549				50 005 734

Zafira A 2.0 DI 16V**247**

03.1999→08.2000	X 20 DTL							
Reference	13 34 117	90540478						50 005 748

Zafira A 2.0 DTI 16V**248**

04.1999→07.2005	Y 20 DTH							
Reference	13 34 117	90540478						50 005 748

Zafira A 2.2i 16V**249**

09.2000→	Z 22 SE							
Reference	13 34 067 93178602	13 34 083	63 34 002	91 94 747				50 005 792

Zafira B 1.6i 16V**250**

07.2005→	Z 16 XEP							
Reference	13 34 142	24405895						50 005 006 <small>NEW</small>

07.2005→	Z 16 XEP							
Reference	6 46 009 90369451	6 46 041 90442241	6 46 132 90444316	6 46 133 90541505			50 005 818	

Zafira B 1.8i 16V**251**

03.2005→	Z 18 XER							
Reference	13 34 142	24405895						50 005 006 <small>NEW</small>

O



Zafira B 1.9 CDTI 16V

252

03.2005→
Reference

Z 19 DTH
13 34 147



50 005 056
NEW

Zafira B 2.0i Turbo 16V

253

03.2005→
Reference





Z 20 LEL, Z 20 LER
13 34 139



50 005 074
NEW

0

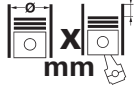









			Cyl	 mm	cm ³		Comp. Ratio ε	kW	PS	Pos
3.152	D	(AN)	3	91,48 x 126,3	2490	2	17,4:1	27-33	37-45	1
4.203	D	(AN)	4	91,48 x 126,9	3335	2	17,4:1	44	60	1
6.354	D	(AN)	6	98,48 x 126,8	5794	2	16:1	69-82	94-112	1
4.192	D	(AN)	4	88,925 x 126,8	3150	2	16,5:1	29-37	40-50	1
4.212	D	(AN)	4	98,48 x 114	3475	2	15,5:1	44-47	60-64	1
A 4.212	D	(AN)	4	98,48 x 114	3475	2	15,1:1	44	60	1
4.236	D	(AN)	4	98,48 x 126,8	3864	2	16:1	48-60	59-80	1
4.248	D	(AN)	4	101,054 x 126,8	4064	2	16:1	53-66	72-90	1
4.248.2	D	(AN)	4	101,054 x 126,8	4064	2	18.1	60	82	1
A 4.192	D	(AN)	4	88,925 x 126,8	3150	2	16,5:1	36-40	50-55	1
A 6.354.4	D	(A)	6	98,48 x 126,8	5794	2		67-87	91-118	1
D 3.152	D	(AN)	3	91,48 x 126,9	2503	2		35	47	1
T 6.354.2	D	(A)	6	98,48 x 126,8	5794	2	16:1	119	162	1















Engine

1

01.1968→06.1990 Reference	6.354 41314131		50 005 231 NEW	
01.1970→12.1980 Reference	D 3.152 41314187		50 005 234 NEW	
→ Reference	4.212, A 4.212 41314182		50 005 235 NEW	
01.1974→06.1990 Reference	4.236 4132F012		50 005 237 NEW	
01.1963→12.1968 Reference	A 4.192 U5MW0061			50 005 250 NEW
01.1963→12.1968 Reference	4.192 41314164		50 005 233 NEW	
→ Reference	3.152 U5MW0023			50 005 248 NEW
→ Reference	A 6.354.4 4132F016		50 005 239 NEW	
01.1963→12.1968 Reference	4.192 U5MW0089			50 005 251 NEW





P



				
01.1974→06.1990 Reference	4.236 41313237			50 005 246 NEW
1960 → Reference	T 6.354.2 41314067		50 005 232 NEW	
01.1974→06.1990 Reference	4.236 4131A013			50 005 245 NEW
→ Reference	A 6.354.4 4132F015		50 005 240 NEW	
01.1964→06.1990 Reference	4.203 41312892			50 005 247 NEW
01.1974→06.1990 Reference	4.236 4132F021		50 005 236 NEW	
→ Reference	3.152 41312487			50 005 249 NEW
01.1964→06.1990 Reference	4.203, 4.236 3641263M91			50 005 252 NEW
→ Reference	4.212, 4.248, 4.248.2 41314054		50 005 840	

P

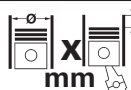

			Cyl		cm ³		Comp. Ratio ε	kW	PS	Pos
CRD 93	D	(AN)	4	93 x 92	2499	2	22,25:1	55	75	159
CRD 93 L	D	(AN)	4	93 x 92	2499	2	22,25:1	54-55	73-75	159, 163
CRD 93 LS	D	(A)	4	93 x 92	2499	2	22,5:1	70	95	160, 163
DJ5	D	(AN)	4	92 x 92	2446	3	22:1	63	86	147
DJ5 T	D	(LA)	4	92 x 92	2446	3	22:1	76	104	148
DJ5 TED	D	(LA)	4	92 x 92	2446	2	21:1	76-79	103-107	149
DK5 ATE	D	(LA)	4	92 x 92	2446	3	22:1	94-96	128-130	121
DV4 TD	D	(LA)	4	73,7 x 82	1398	2	17,9:1	40-50	54-68	9, 26, 34, 53, 139
DV6 TED4	D	(LA)	4	75 x 88,3	1560	4	17,6:1	80	109	28, 35, 54, 60, 96, 141, 167
DW10 ATED3	D	(LA)	4	85 x 88	1997	2	17,6:1	80	109	56, 92, 123, 131, 155
DW10 ATED4	D	(LA)	4	85 x 88	1997	4	17,6:1	79-80	107-109	132, 135, 156
DW10 BTED	D	(LA)	4	85 x 88	1997	2	17,6:1	70	95	155
DW10 BTED4	D	(LA)	4	85 x 88	1997	4	17,6:1	100	136	57, 59, 61, 99, 124, 135, 156
DW10 TD	D	(LA)	4	85 x 88	1997	2	17,6:1	66	90	32, 50, 56, 92, 146, 151, 171
DW12 TED4	D	(LA)	4	85 x 96	2179	4	17,6:1	94-100	128-136	95, 126, 137
DW8	D	(AN)	4	82,2 x 88	1868	2	23:1	51	69	29, 46, 153, 170, 173
DW8 B	D	(AN)	4	82,2 x 88	1868	2	23:1	51	69	29, 46, 153, 170
ET3 J4	B		4	75 x 77	1361	4	10,2:1	65	88	25, 33, 52, 140
EW10 D	B		4	85 x 88	1997	4	11,4:1	100-105	136-143	31, 93
EW10 J4	B		4	85 x 88	1997	4	10,8:1	99-100	135-136	30, 55, 58, 90, 98, 122, 130, 134, 157
EW12 J4	B		4	86 x 96	2230	4	10,8:1	116-120	158-163	100, 125, 136
EW7J4	B		4	82,7 x 81,4	1749	4	10,8:1	85	116	88, 97
TU 1	B		4	72 x 69	1124	2	9,4:1	34-40	46-54	12
TU 1JP	B		4	72 x 69	1124	2	9,7/ 10,2:1	44	60	3, 23, 164
TU 1M	B		4	72 x 69	1124	2	9,2:1	40-44	54-60	3, 13, 39, 164
TU 1MZ	B		4	72 x 69	1124	2	9,4:1	40-44	54-60	13
TU 2J4.4A	B		4	75 x 73,2	1294	2	9,6:1	74	101	14
TU 3	B		4	75 x 77	1361	2	9,3:1	44-47	60-64	4, 15, 40, 62, 73
TU 3-2	B		4	75 x 77	1361	2	9,3:1	51-55	69-75	40, 165
TU 3.2/K	B		4	75 x 77	1361	2	9,3:1	55	75	4, 40, 73
TU 3A (44 kW)	B		4	75 x 77	1361	2	9,3:1	44-50	60-68	15, 73
TU 3A/K	B		4	75 x 77	1361	2	9,3:1	49-53	67-72	15
TU 3CP	B		4	75 x 77	1361	2	9,3:1	44	60	6, 16
TU 3F2K	B		4	75 x 77	1361	2	9,3:1	55	75	16, 63, 74
TU 3FJ2	B		4	75 x 77	1361	2	9,3:1	69	94	6
TU 3FM	B		4	75 x 77	1361	2	9,3:1	55-58	75-79	6, 16, 63
TU 3J2/Z	B		4	75 x 77	1361	2	9,9:1	69	94	6
TU 3JP	B		4	75 x 77	1361	2	10,2:1	54-55	73-75	6, 24, 41, 51, 138, 166, 172
TU 3M	B		4	75 x 77	1361	2	9,3:1	55-58	75-79	16
TU 3MC	B		4	75 x 77	1361	2	9,3:1	55	75	16, 41, 63, 74
TU 3S	B		4	75 x 77	1361	2	9,3:1	62	85	15
TU 5J2	B		4	78,5 x 82	1587	2	10,2:1	76-77	103-105	8
TU 5JP	B		4	78,5 x 82	1587	2	10,2:1	65-74	88-101	8, 27, 42
TU 9A	B		4	70 x 62	954	2	9,4:1	33	45	1, 10
TU 9K	B		4	70 x 62	954	2	9,4:1	33	45	1, 10
TU 9M	B		4	70 x 62	954	2	9,4:1	33-37	45-50	2, 11
TU 9M/Z	B		4	70 x 62	954	2	9,4:1	31-33	42-45	10
TUD 3Y	D	(AN)	4	75 x 77	1361	2	22:1	37	50	5
TUD 5	D	(AN)	4	77 x 82	1527	2	23:1	40-42	54-57	7
XC	B		4	84 x 73	1618	2	7,2:1	53	72	71
XC5 A	B		4	84 x 73	1618	2	7,6:1	53	72	71
XC6	B		4	84 x 73	1618	2	8,3:1	51	69	71
XC7	B		4	84 x 73	1618	2	7,6:1	54	73	71
XC7 P	B		4	84 x 73	1618	2	7,6:1	43-45	58-61	101
XD 2	D	(AN)	4	94 x 83	2304	2	22,2:1	44-51	60-69	106, 110, 162
XD 2P	D	(AN)	4	94 x 83	2304	2	22,2:1	49	67	162
XD 2P94	D	(AN)	4	94 x 83	2304	2	22,2:1	49	67	161
XD 2S	D	(A)	4	94 x 83	2304	2	21:1	54-59	73-80	111, 114
XD 3	D	(AN)	4	94 x 90	2498	2	23:1	51-56	70-76	107, 112
XD 3T	D	(LA)	4	94 x 90	2498	2	21:1	66-70	90-95	113, 115
XD 94	D	(AN)	4	94 x 83	2304	2	22,2:1	53	72	162
XD P 4.88	D	(AN)	4	88 x 80	1948	2	21,8:1	40	54	72, 105
XM	B		4	84 x 81	1796	2	8,35:1	56	76	102



			Cyl		mm	cm ³	Comp. Ratio	ε	kW	PS	Pos
XN 1	B		4	88 x 81	1971	2	8,35:1	60-71	82-97	103, 108	
XN 2	B		4	88 x 81	1971	2	8,3/9:1	74-78	101-106	104	
XN 6	B		4	88 x 81	1971	2	8,35:1	71	97	109	
XU 10 2C	B		4	86 x 86	1998	2	8,8:1	79-85	107-115	116, 144	
XU 10 MZ	B		4	86 x 86	1998	2	8,8:1	79	108	117	
XU 10J2	B		4	86 x 86	1998	2	8,8:1	89	121	48, 83, 129	
XU 10J2CTE	B	(LA)	4	86 x 86	1998	2	8:1	104-110	141-150	91	
XU 10J2CZ	B		4	86 x 86	1998	2	9,5:1	89	121	48, 83, 129	
XU 10J2U	B		4	86 x 86	1998	2	9,5:1	80	109	145, 150	
XU 10J2Z	B		4	86 x 86	1998	2	8,8:1	89-94	121-128	116	
XU 10J4	B		4	86 x 86	1998	4	10,4:1	110-118	150-160	49, 84	
XU 10J4R	B		4	86 x 86	1998	4	10,4:1	97-99	132-135	49, 90, 118, 130	
XU 10J4TE/Z	B	(LA)	4	86 x 86	1998	4	8:1	144-159	196-216	85	
XU 51C	B		4	83 x 73	1581	2	9,3:1	53-59	72-80	17, 64, 75	
XU 52C (65 kW)	B		4	83 x 73	1581	2	9,2:1	65-68	88-92	65, 76	
XU 5CP	B		4	83 x 73	1581	2	8,95:1	53-55	72-75	17, 75	
XU 5J	B		4	83 x 73	1581	2	9,8:1	76	103	18, 65	
XU 5JA	B		4	83 x 73	1581	2	10,2:1	84-90	115-122	18, 65	
XU 5JP	B		4	83 x 73	1581	2	9,25:1	65	88	76, 86	
XU 5M	B		4	83 x 73	1581	2	9,3:1	65	88	18, 65, 76	
XU 5S	B		4	83 x 73	1581	2	9,5:1	66-71	90-97	36	
XU 7JB	B		4	83 x 81,4	1762	2	9,25:1	66	90	87, 168	
XU 7JP	B		4	83 x 81,4	1762	2	9,25:1	73-76	99-103	43, 77, 87, 127, 152	
XU 7JP4	B		4	83 x 81,4	1762	4	10,4:1	81	110	44, 88	
XU 7JPZ	B		4	83 x 81,4	1762	2	9,25:1	74-76	101-103	43, 77	
XU 9C	B		4	83 x 88	1905	2		73-95	100-129	68, 79	
XU 9J1	B		4	83 x 88	1905	2	8,4:1	72-77	98-105	21, 37, 68, 79	
XU 9J2	B		4	83 x 88	1905	2	9,3:1	89-92	121-125	79	
XU 9J4	B		4	83 x 88	1905	4	10,4:1	116	158	69, 80	
XU 9J4Z	B		4	83 x 88	1905	4	9,7:1	108-111	147-151	80	
XU 9JA/K	B		4	83 x 88	1905	2	9,2:1	92-94	125-128	21, 68	
XU 9JAZ	B		4	83 x 88	1905	2	9,25:1	88-90	120-122	21, 68, 79	
XU 9M	B		4	83 x 88	1905	2	9,2:1	80	109	68, 79	
XU 9S	B		4	83 x 88	1905	2	9,3:1	75-77	102-105	37, 68	
XUD 11A	D	(AN)	4	86 x 92	2138	3	22,5:1	60	82	119	
XUD 11ATE	D	(LA)	4	85 x 92	2088	3	21,5:1	80	109	120	
XUD 11BTE	D	(LA)	4	85 x 92	2088	3	21,5:1	80-81	109-110	94, 133	
XUD 7	D	(AN)	4	80 x 88	1769	2	23:1	44	60	19, 45, 66, 169	
XUD 7T	D	(A)	4	80 x 88	1769	2	22:1	57	78	20, 67	
XUD 7TE	D	(LA)	4	80 x 88	1769	2	22,5:1	64-66	88-90	78	
XUD 9 (47 kW)	D	(AN)	4	83 x 88	1905	2	23,5:1	47-52	64-71	38, 70	
XUD 9A	D	(AN)	4	83 x 88	1905	2	23:1	47-52	64-71	46, 81, 142, 153, 158, 170	
XUD 9AU	D	(AN)	4	83 x 88	1905	2	23:1	51	69	142, 153	
XUD 9B	D	(AN)	4	83 x 88	1905	2	23:1	51	71	46, 70, 81, 170	
XUD 9BSD	D	(LA)	4	83 x 88	1905	2	21,8:1	55	75	47	
XUD 9K	D	(AN)	4	83 x 88	1905	2	23,5:1	47	64	70, 81	
XUD 9SD	D	(LA)	4	83 x 88	1905	2	23:1	51-55	71-75	89	
XUD 9TE	D	(LA)	4	83 x 88	1905	2	21,8:1	66-68	90-92	47, 82, 89, 128	
XUD 9TF	D	(LA)	4	83 x 88	1905	2	21,8:1	68	92	89, 128, 154	
XUD 9UTF	D	(LA)	4	83 x 88	1905	2	21,8:1	68	92	143	
XUD 9Y	D	(AN)	4	83 x 88	1905	2	23,5:1	47-50	64-68	22, 46, 70, 81	

P



106 1.0

1

09.1991→04.1996

TU 9A, TU 9K

Reference

1201 E3
9617376980

1207 18

1207 23

9451001263



50 005 310

106 1.0i

2

07.1992→05.2005

TU 9M

Reference

1201 E3
9617376980

1207 18

1207 23

9451001263



50 005 310

106 1.1i

3

03.2000→05.2005

TU 1JP

Reference

1201-G0



50 005 757

09.1991→05.2005

TU 1M

Reference

1201 E3
9617376980

1207 18

1207 23

9451001263



50 005 310

106 1.4

4

09.1991→04.1996

TU 3

Reference

1001 69

1001 69



50 005 853

09.1991→05.2005

TU 3, TU 3.2/K

Reference

1201 E3
9617376980

1207 18

1207 23

9451001263



50 005 310

09.1991→04.1996

TU 3

Reference

1201 58
9608564280

1201 E4

1201 E6

1207 25



50 005 339

106 1.4 D

5

09.1992→04.1996

TUD 3Y

Reference

1001 50
→12.1991

1001 50



50 005 820

09.1992→04.1996

TUD 3Y

Reference

1201 E3
9617376980

1207 18

1207 23

9451001263





50 005 310





106 1.4i

6

07.1992→05.2005	TU 3CP, TU 3JP						
Reference	1201 E3 9617376980	1207 18	1207 23	9451001263			50 005 310
09.1991→04.1996	TU 3FJ2, TU 3FM, TU 3J2/Z						
Reference	1201 58 9608564280	1201 E4	1201 E6	1207 25			50 005 339



106 1.5 D

7

07.1994→05.2005	TUD 5						
Reference	1001 69	1001 69				50 005 853	
07.1994→05.2005	TUD 5						
Reference	1201 58 9608564280	1201 E4	1201 E6	1207 25			50 005 339

106 1.6i

8

06.1993→05.2005	TU 5J2, TU 5JP						
Reference	1001 69	1001 69				50 005 853	
06.1993→05.2005	TU 5JP						
Reference	1201 58 9608564280	1201 E4	1201 E6	1207 25			50 005 339

P



107 1.4 HDI

9

06.2005→03.2008	DV4 TD						
Reference	1201 F9	1201 G8					50 005 758

205 1.0

10

10.1987→09.1998	TU 9A, TU 9K, TU 9M/Z						
Reference	1001 50 →12.1991	1001 50				50 005 820	
10.1987→09.1998	TU 9A, TU 9K, TU 9M/Z						
Reference	1201 E3 9617376980	1207 18	1207 23	9451001263			50 005 310



205 1.0i

11

07.1992→09.1998	TU 9M							
Reference	1201 E3 9617376980	1207 18	1207 23	9451001263				50 005 310



205 1.1

12

10.1987→12.1990	TU 1							
Reference	1001 50 →12.1991	1001 50					50 005 820	

205 1.1i

13

07.1989→09.1998	TU 1M, TU 1MZ							
Reference	1001 50 →12.1991	1001 50					50 005 820	
07.1989→09.1998	TU 1M							
Reference	1201 E3 9617376980	1207 18	1207 23	9451001263				50 005 310





205 1.3

14

10.1987→12.1994	TU 2J4.4A							
Reference	1201 E3 9617376980	1207 18	1207 23	9451001263				50 005 310

205 1.4

15

10.1987→12.1994	TU 3							
Reference	1001 69	1001 69					50 005 853	
06.1987→12.1994	TU 3, TU 3A (44 kW), TU 3A/K, TU 3S							
Reference	1001 50 →12.1991	1001 50					50 005 820	
06.1987→12.1994	TU 3, TU 3S							
Reference	1201 E3 9617376980	1207 18	1207 23	9451001263				50 005 310
10.1987→12.1994	TU 3							
Reference	1201 58 9608564280	1201 E4	1201 E6	1207 25				50 005 339

205 1.4i

16

09.1992→09.1998	TU 3MC							
Reference	1001 69	1001 69					50 005 853	

P







07.1988→09.1998 Reference 	TU 3M 1001 50 →12.1991	1001 50					50 005 820
10.1987→10.1990 Reference	TU 3CP 1201 E3 9617376980	1207 18	1207 23	9451001263			50 005 310
06.1991→12.1994 Reference	TU 3F2K, TU 3FM 1201 58 9608564280	1201 E4	1201 E6	1207 25			50 005 339
205 1.6							17
02.1983→09.1998 Reference	XU 51C, XU 5CP 1001 56	1001 56					50 005 815
205 1.6i							18
10.1985→09.1998 Reference 	XU 5JA 1201 50 95656567 01.1992→	1201 61	95625017	95655208			50 005 319
10.1983→09.1998 Reference	XU 5J, XU 5M 1001 56	1001 56					50 005 815
10.1985→09.1998 Reference 	XU 5JA 1201 39 95641148 →12.1991	1201 63 95655207	91511136 95656566	9401201390			50 005 307
205 1.8 D							19
10.1983→09.1998 Reference 	XUD 7 1201 48 9401201480 95655210 11.1986→	1201 51 95641149 95656568	1201 60 95643824 95656569	1201 62 95655209			50 005 320
10.1983→09.1998 Reference	XUD 7 1001 56	1001 56					50 005 815
10.1983→09.1998 Reference 	XUD 7 1201 39 95641148 →10.1986	1201 63 95655207	91511136 95656566	9401201390			50 005 307

P







205 1.8 TD

20

01.1990→09.1998	XUD 7T							
Reference	1201 48 9401201480 95655210 →12.1993	1201 51 95641149 95656568	1201 60 95643824 95656569	1201 62 95655209				50 005 320
								
01.1990→09.1998	XUD 7T							
Reference	1201 52 1201 A4 01.1994→	1201 65 95650955	1201 67 95666768	1201 91				50 005 313
								

205 1.9i

21

10.1986→09.1998	XU 9J1, XU 9JA/K, XU 9JAZ							
Reference	1201 50 95656567 01.1992→	1201 61	95625017	95655208				50 005 319
								
10.1986→09.1998	XU 9J1, XU 9JA/K, XU 9JAZ							
Reference	1001 56	1001 56					50 005 815	
10.1986→09.1998	XU 9J1, XU 9JA/K, XU 9JAZ							
Reference	1201 39 95641148 →12.1991	1201 63 95655207	91511136 95656566	9401201390				50 005 307
								

205 1.9 D

22

10.1987→09.1998	XUD 9Y							
Reference	1001 56	1001 56					50 005 815	

206 1.1i

23

06.1998→	TU 1JP							
Reference	1201-G0							50 005 757

206 1.4i

24









06.1998→12.2005	TU 3JP							
Reference	1201 E3 9617376980	1207 18	1207 23	9451001263				50 005 310

206 1.4i 16V

25









10.2003→	ET3 J4							
Reference	1201 G2							50 005 766



206 1.4 HDi					26	
09.2001→ Reference	DV4 TD 1201 F9	1201 G8			50 005 758	
206 1.6i					27	
06.1998→ Reference	TU 5JP 1001 69	1001 69			50 005 853	
06.1998→ Reference	TU 5JP 1201 58 9608564280	1201 E4	1201 E6	1207 25		50 005 339
206 1.6 HDi 16V					28	
04.2004→ Reference	DV6 TED4 1201 G1	1201 G9			50 005 762	
206 1.9 D					29	
06.1998→ Reference	DW8, DW8 B 1201 C4				50 005 329	
206 2.0i 16V					30	
01.1999→ Reference	EW10 J4 1201 E1	1201 F4	1201 G4		50 005 761	
206 2.0 HPi 16V					31	
10.2000→ Reference	EW10 D 1201 E1	1201 F4	1201 G4		50 005 761	
206 2.0 HDi					32	
04.1999→ Reference	DW10 TD 1201 C4				50 005 329	

P





207 1.4i 16V					33
12.2005→03.2008 Reference	ET3 J4 1201 G2				50 005 766
207 1.4 HDi					34
02.2006→ Reference	DV4 TD 1201 F9	1201 G8			50 005 758
207 1.6 HDi 16V					35
02.2006→ Reference	DV6 TED4 1201 G1	1201 G9			50 005 762
305 1.6					36
10.1982→07.1990 Reference	XU 5S 1201 39 95641148	1201 63 95655207	91511136 95656566	9401201390	 50 005 307
305 1.9i					37
10.1982→07.1990 Reference	XU 9J1 1201 50 95656567 01.1992→	1201 61	95625017	95655208	 50 005 319
10.1982→07.1990 Reference	XU 9J1, XU 9S 1201 39 95641148 XU 9J1: →12.1991	1201 63 95655207	91511136 95656566	9401201390	 50 005 307
305 1.9 D					38
10.1982→07.1990 Reference	XUD 9 (47 kW) 1201 48 9401201480 95655210 10.1986→	1201 51 95641149 95656568	1201 60 95643824 95656569	1201 62 95655209	 50 005 320
10.1982→07.1990 Reference	XUD 9 (47 kW) 1201 39 95641148 →09.1986	1201 63 95655207	91511136 95656566	9401201390	 50 005 307
306 1.1i					39
01.1993→04.1997 Reference	TU 1M 1201 E3 9617376980	1207 18	1207 23	9451001263	 50 005 310

P



306 1.4

40

01.1993→04.1997	TU 3, TU 3-2, TU 3.2/K						
Reference	1201 E3 9617376980	1207 18	1207 23	9451001263			50 005 310
01.1993→04.1997	TU 3, TU 3-2						
Reference	1201 58 9608564280	1201 E4	1201 E6	1207 25			50 005 339



306 1.4i

41

01.1993→10.2003	TU 3JP, TU 3MC						
Reference	1201 E3 9617376980	1207 18	1207 23	9451001263			50 005 310

306 1.6i

42

01.1993→10.2003	TU 5JP						
Reference	1001 69	1001 69				50 005 853	
01.1993→10.2003	TU 5JP						
Reference	1201 58 9608564280	1201 E4	1201 E6	1207 25			50 005 339

306 1.8i

43

01.1993→10.2003	XU 7JP, XU 7JPZ						
Reference	1201 50 95656567	1201 61	95625017	95655208			50 005 319
01.1993→10.2003	XU 7JP						
Reference	1001 77	1001 77				50 005 854	

306 1.8i 16V

44

05.1997→10.2003	XU 7JP4						
Reference	1001 77 →ORGA 08133	1001 77				50 005 854	

306 1.8 D

45

05.1993→10.2003	XUD 7						
Reference	1001 56	1001 56				50 005 815	

P



306 1.9 D

46

05.1993→10.2003 Reference	XUD 9B 1201 48 9401201480 95655210 →04.1994	1201 51 95641149 95656568	1201 60 95643824 95656569	1201 62 95655209		50 005 320
05.1993→10.2003 Reference	XUD 9B 1201 52 1201 A4 05.1994→	1201 65 95650955	1201 67 95666768	1201 91		50 005 313
05.1993→10.2003 Reference	XUD 9A, XUD 9Y 1001 56	1001 56				50 005 815
09.1998→10.2003 Reference	DW8, DW8 B 1201 C4					50 005 329
09.1998→10.2003 Reference	DW8, DW8 B 1001 91	1001 91				50 005 826









306 1.9 TD

47

05.1993→10.2003 Reference	XUD 9TE 1001 68	1001 68				50 005 825
05.1993→10.2003 Reference	XUD 9TE 1201 48 9401201480 95655210 →04.1994	1201 51 95641149 95656568	1201 60 95643824 95656569	1201 62 95655209		50 005 320
05.1993→10.2003 Reference	XUD 9TE 1201 52 1201 A4 05.1994→, →7389	1201 65 95650955	1201 67 95666768	1201 91		50 005 313
06.1998→10.2003 Reference	XUD 9BSD 1001 56	1001 56				50 005 815
05.1993→10.2003 Reference	XUD 9TE 1201 A8 7390→					50 005 333

P



306 2.0i					48
08.1993→04.1997 Reference	XU 10J2 1001 77	1001 77			 50 005 854
08.1993→04.1997 Reference	XU 10J2CZ 1201 52 1201 A4	1201 65 95650955	1201 67 95666768	1201 91	 50 005 313
306 2.0i 16V					49
08.1993→10.2003 Reference	XU 10J4, XU 10J4R 1001 77	1001 77			 50 005 854
08.1993→04.1997 Reference	XU 10J4 1201 52 1201 A4	1201 65 95650955	1201 67 95666768	1201 91	 50 005 313
306 2.0 HDi					50
06.1999→10.2003 Reference	DW10 TD 1201 C4				 50 005 329
307 1.4i					51
01.2002→02.2005 Reference	TU 3JP 1201 E3 9617376980	1207 18	1207 23	9451001263	 50 005 310
307 1.4i 16V					52
07.2003→12.2008 Reference	ET3 J4 1201 G2				 50 005 766
307 1.4 HDi					53
01.2002→02.2005 Reference	DV4 TD 1201 F9	1201 G8			 50 005 758
307 1.6 HDi 16V					54
02.2004→ Reference	DV6 TED4 1201 G1	1201 G9			 50 005 762

P



307 2.0i 16V

55

 01.2002→02.2005
Reference

 EW10 J4
1201 E1

1201 F4

1201 G4



50 005 761

307 2.0 HDi

56

 08.2000→05.2005
Reference

 DW10 ATED3, DW10 TD
1201 C4

50 005 329

307 2.0 HDi 16V

57

 10.2003→12.2008
Reference

 DW10 BTED4
1201E8

50 005 779

307 CC 2.0i 16V

58

 06.2003→02.2005
Reference

 EW10 J4
1201 E1

1201 F4

1201 G4



50 005 761

307 CC 2.0 HDi 16V

59

 06.2005→12.2008
Reference

 DW10 BTED4
1201E8

50 005 779

308 1.6 HDi 16V

60

 09.2007→
Reference

 DV6 TED4
1201 G1

1201 G9



50 005 762

308 2.0 HDi 16V

61

 09.2007→12.2007
Reference

 DW10 BTED4
1201E8

50 005 779

309 1.4

62

 07.1989→12.1993
Reference

 TU 3
1001 69

1001 69



50 005 853

P







07.1989→12.1993 Reference	TU 3 1201 E3 9617376980	1207 18	1207 23	9451001263			50 005 310
07.1989→12.1993 Reference	TU 3 1201 58 9608564280	1201 E4	1201 E6	1207 25			50 005 339
309 1.4i							63
10.1988→12.1993 Reference	TU 3MC 1001 69	1001 69				50 005 853	
10.1988→12.1993 Reference	TU 3F2K, TU 3FM 1201 58 9608564280	1201 E4	1201 E6	1207 25			50 005 339
309 1.6							64
10.1985→12.1990 Reference	XU 51C 1001 56	1001 56				50 005 815	
10.1985→12.1990 Reference	XU 51C 1201 39 95641148	1201 63 95655207	91511136 95656566	9401201390			50 005 307
309 1.6i							65
11.1985→12.1993 Reference 	XU 5JA 1201 50 95656567 01.1992→	1201 61	95625017	95655208			50 005 319
11.1985→12.1993 Reference	XU 52C (65 kW), XU 5J, XU 5M 1001 56	1001 56				50 005 815	
11.1985→12.1993 Reference 	XU 5JA 1201 39 95641148 →12.1991	1201 63 95655207	91511136 95656566	9401201390			50 005 307
309 1.8 D							66
07.1989→12.1993 Reference	XUD 7 1001 56	1001 56				50 005 815	

P









309 1.8 TD

67

11.1989→12.1993	XUD 7T							
Reference	1201 48 9401201480 95655210 →12.1993	1201 51 95641149 95656568	1201 60 95643824 95656569	1201 62 95655209				50 005 320
								
11.1989→12.1993	XUD 7T							
Reference	1201 52 1201 A4 01.1994→	1201 65 95650955	1201 67 95666768	1201 91				50 005 313
								

309 1.9i

68

10.1985→12.1993	XU 9C, XU 9J1, XU 9JA/K							
Reference	1201 50 95656567 01.1992→	1201 61	95625017	95655208				50 005 319
								
10.1985→12.1993	XU 9J1, XU 9JA/K, XU 9JAZ, XU 9M, XU 9S							
Reference	1001 56	1001 56					50 005 815	
								
10.1985→12.1993	XU 9C, XU 9J1, XU 9JA/K							
Reference	1201 39 95641148 →12.1991	1201 63 95655207	91511136 95656566	9401201390				50 005 307
								





309 1.9i 16V

69

02.1990→12.1993	XU 9J4							
Reference	1001 56	1001 56					50 005 815	
								

309 1.9 D

70

06.1986→12.1993	XUD 9 (47 kW), XUD 9B, XUD 9K							
Reference	1201 48 9401201480 95655210	1201 51 95641149 95656568	1201 60 95643824 95656569	1201 62 95655209				50 005 320
								
06.1986→12.1993	XUD 9 (47 kW), XUD 9Y							
Reference	1001 56	1001 56					50 005 815	
								

404 1.6

71

1960 →	XC, XC5 A, XC6, XC7							
Reference	1001 29						50 005 852	
								

404 2.0 D



72

1971 →	XD P 4.88							
Reference	1001 32	1001 37					50 005 814	
								





405 1.4

73

07.1988→12.1992	TU 3, TU 3A (44 kW)					50 005 820	
Reference	1001 50	1001 50	→12.1991				
07.1988→04.1997	TU 3, TU 3.2/K, TU 3A (44 kW)					50 005 310	
Reference	1201 E3 9617376980	1207 18	1207 23	9451001263			
07.1988→12.1992	TU 3, TU 3A (44 kW)					50 005 339	
Reference	1201 58 9608564280	1201 E4	1201 E6	1207 25			



405 1.4i

74

08.1991→04.1997	TU 3F2K, TU 3MC					50 005 853	
Reference	1001 69	1001 69					
08.1991→09.1992	TU 3F2K					50 005 339	
Reference	1201 58 9608564280	1201 E4	1201 E6	1207 25			

405 1.6

75

07.1987→12.1992	XU 51C, XU 5CP					50 005 815	
Reference	1001 56	1001 56					
07.1987→12.1992	XU 51C					50 005 307	
Reference	1201 39 95641148	1201 63 95655207	91511136 95656566	9401201390			

405 1.6i

76

09.1994→04.1997	XU 5JP					50 005 854	
Reference	1001 77	1001 77					
07.1987→04.1997	XU 52C (65 kW), XU 5JP, XU 5M					50 005 815	
Reference	1001 56	1001 56					

405 1.8i

77

06.1992→04.1997	XU 7JP, XU 7JPZ					50 005 319	
Reference	1201 50 95656567	1201 61	95625017	95655208			

P



06.1992→04.1997 Reference	XU 7JP 1001 77	1001 77				50 005 854
06.1992→04.1997 Reference	XU 7JP 1001 56	1001 56				50 005 815
405 1.8 TD						78
03.1988→12.1992 Reference	XUD 7TE 1201 48 9401201480 95655210	1201 51 95641149 95656568	1201 60 95643824 95656569	1201 62 95655209		50 005 320
405 1.9i						79
07.1987→04.1997 Reference	XU 9C, XU 9J1 1201 50 95656567 01.1992→	1201 61	95625017	95655208		50 005 319
07.1987→04.1997 Reference	XU 9J1, XU 9J2, XU 9JAZ, XU 9M 1001 56	1001 56				50 005 815
07.1987→04.1997 Reference	XU 9C, XU 9J1, XU 9J2, XU 9JAZ, XU 9M 1201 39 95641148 XU 9C, XU 9J1: →12.1991	1201 63 95655207	91511136 95656566	9401201390		50 005 307
405 1.9i 16V						80
07.1987→12.1992 Reference	XU 9J4, XU 9J4Z 1001 56	1001 56				50 005 815
405 1.9 D						81
03.1988→04.1997 Reference	XUD 9A, XUD 9B, XUD 9K 1201 48 9401201480 95655210	1201 51 95641149 95656568	1201 60 95643824 95656569	1201 62 95655209		50 005 320
03.1988→04.1997 Reference	XUD 9A, XUD 9Y 1001 56	1001 56				50 005 815
405 1.9 TD						82
06.1992→04.1997 Reference	XUD 9TE 1001 68	1001 68				50 005 825
06.1992→04.1997 Reference	XUD 9TE 1201 48 9401201480 95655210 →06.1994	1201 51 95641149 95656568	1201 60 95643824 95656569	1201 62 95655209		50 005 320

P



06.1992→04.1997 Reference 	XUD 9TE 1201 52 1201 A4 07.1994→02.1997	1201 65 95650955	1201 67 95666768	1201 91			50 005 313
405 2.0i							83
06.1992→04.1997 Reference	XU 10J2 1001 77	1001 77				50 005 854	
08.1992→10.1995 Reference	XU 10J2CZ 1201 52 1201 A4	1201 65 95650955	1201 67 95666768	1201 91			50 005 313
405 2.0i 16 V							84
01.1993→04.1997 Reference	XU 10J4 1001 77	1001 77				50 005 854	
01.1993→04.1997 Reference	XU 10J4 1201 52 1201 A4	1201 65 95650955	1201 67 95666768	1201 91			50 005 313
405 2.0i Turbo 16V							85
09.1992→04.1997 Reference	XU 10J4TE/Z 1201 52 1201 A4	1201 65 95650955	1201 67 95666768	1201 91			50 005 313
406 1.6i							86
10.1995→06.2004 Reference	XU 5JP 1001 77	1001 77				50 005 854	
406 1.8i							87
12.1995→03.1999 Reference	XU 7JP 1201 50 95656567	1201 61	95625017	95655208			50 005 319
12.1995→06.2004 Reference	XU 7JB, XU 7JP 1001 77	1001 77				50 005 854	
406 1.8i 16V							88
10.1995→06.2004 Reference 	XU 7JP4 1001 77 →ORGA 08133	1001 77				50 005 854	

P



10.2000→06.2004 Reference	EW7J4 1201 E1	1201 F4	1201 G4				50 005 761
406 1.9 TD							89
12.1995→03.1999 Reference 	XUD 9SD, XUD 9TE 1001 68 1001 68 XUD 9SD: ORGA 08120→					50 005 825	
12.1995→ Reference 	XUD 9TE, XUD 9TF 1201 52 1201 65 1201 67 1201 91 1201 A4 95650955 95666768 →7389						50 005 313
06.1996→03.1999 Reference 	XUD 9SD 1001 56 1001 56 →08119					50 005 815	
12.1995→ Reference 	XUD 9TE, XUD 9TF 1201 A8 7390→						50 005 333
406 2.0i 16V							90
10.1995→09.1999 Reference	XU 10J4R 1001 77 1001 77					50 005 854	
04.1999→02.2005 Reference	EW10 J4 1201 E1 1201 F4 1201 G4						50 005 761
406 2.0i Turbo							91
10.1996→04.1999 Reference	XU 10J2CTE 1201 52 1201 65 1201 67 1201 91 1201 A4 95650955 95666768						50 005 313
406 2.0 HDi							92
10.1998→06.2004 Reference	DW10 ATED3, DW10 TD 1001 92 1001 92					50 005 824	
10.1998→06.2004 Reference	DW10 ATED3, DW10 TD 1201 C4						50 005 329

P



406 2.0 HPi 16V

93

10.2000→06.2004 EW10 D
Reference 1201 E1 1201 F4 1201 G4

50 005 761

406 2.1 TD 12V

94

12.1995→03.1999 XUD 11BTE
Reference 1201 54 1201 55 1201 A7 1201 C6
1336 L5 96047088

50 005 322

406 2.2 HDi 16V

95

03.2000→02.2005 DW12 TED4
Reference 1201E8

50 005 779

407 1.6 HDi 16V

96

05.2004→ DV6 TED4
Reference 1201 G1 1201 G9

50 005 762

407 1.8i 16V

97

05.2004→ EW7J4
Reference 1201 E1 1201 F4 1201 G4

50 005 761
P

407 2.0i 16V

98

05.2004→ EW10 J4
Reference 1201 E1 1201 F4 1201 G4

50 005 761

407 2.0 HDi 16V

99

05.2004→ DW10 BTED4
Reference 1201E8

50 005 779

407 2.2i 16V

100

05.2004→ EW12 J4
Reference 1201 E7 1201 F5 1201 G5

50 005 765

**504 1.6****101**10.1979→12.1990
ReferenceXC7 P
1001 29

50 005 852

504 1.8**102**07.1968→02.1971
ReferenceXM
1001 30 1001 30 1001 40 1001 40

50 005 863

504 2.0**103**01.1971→12.1989
ReferenceXN 1
1001 30 1001 30 1001 40 1001 40

50 005 863

504 2.0i**104**01.1971→08.1984
ReferenceXN 2
1001 30 1001 30 1001 40 1001 40

50 005 863

504 2.0 D**105**1971 →
ReferenceXD P 4.88
1001 32 1001 37

50 005 814

504 2.3 D**106**08.1976→12.1989
ReferenceXD 2
1001 32 1001 37

50 005 814

504 2.5 D**107**07.1987→12.1989
ReferenceXD 3
1001 32 1001 37

50 005 814

505 2.0**108**05.1979→12.1993
ReferenceXN 1
1001 30 1001 30 1001 40 1001 40

50 005 863

P

**505 2.0i****109**

01.1980→06.1987

XN 6

Reference

1001 30

1001 30

1001 40

1001 40



50 005 863

505 2.3 D**110**

09.1979→09.1986

XD 2

Reference

1001 32

1001 37



50 005 814

505 2.3 TD**111**

09.1980→06.1986

XD 2S

Reference

1001 32

1001 37



50 005 814

09.1980→06.1986

XD 2S

Reference

1201 42

1201 76

→ch. 1.633.872



50 005 304

505 2.5 D**112**

06.1981→12.1993

XD 3

Reference

1001 32

1001 37



50 005 814

P

06.1981→12.1993

XD 3

Reference

1201 35

1201 74



50 005 314

505 2.5 TD**113**

10.1983→12.1993

XD 3T

Reference

1201 42

1201 76



50 005 304

604 2.3 TD**114**

02.1979→06.1983

XD 2S

Reference

1001 32

1001 37



50 005 814

604 2.5 TD**115**

06.1983→06.1986

XD 3T

Reference

1201 42

1201 76



50 005 304



605 2.0

116

06.1989→05.1999

XU 10 2C, XU 10J2Z

Reference

1201 52
1201 A41201 65
956509551201 67
95666768

1201 91



50 005 313

605 2.0i

117

06.1989→06.1994

XU 10 MZ

Reference

1201 52
1201 A41201 65
956509551201 67
95666768

1201 91



50 005 313

605 2.0i 16V

118

07.1994→05.1999

XU 10J4R

Reference

1001 77

1001 77



50 005 854

605 2.1 D 12V

119

06.1989→06.1994

XUD 11A

Reference

1201 52
1201 A41201 65
956509551201 67
95666768

1201 91



50 005 313

605 2.1 TD 12V

120

06.1989→10.1996

XUD 11ATE

Reference

1201 54
1336 L51201 55
96047088

1201 A7

1201 C6



50 005 322

605 2.4 TD

121

07.1994→05.1999

DK5 ATE

Reference

1201 70
→7143

1201 A3



50 005 330

07.1994→05.1999

DK5 ATE

Reference

1201 A5
7144→

50 005 331

607 2.0i 16V

122

03.2000→11.2004

EW10 J4

Reference

1201 E1

1201 F4

1201 G4



50 005 761



607 2.0 HDi

12303.2000→
ReferenceDW10 ATED3
1201 C4

50 005 329

607 2.0 HDi 16V

12412.2005→
ReferenceDW10 BTED4
1201E8

50 005 779

607 2.2i 16V

12503.2000→
ReferenceEW12 J4
1201 E7 1201 F5 1201 G5

50 005 765

607 2.2 HDi Biturbo 16V

12603.2000→
ReferenceDW12 TED4
1201E8

50 005 779

806 1.8i

12707.1995→08.2002
ReferenceXU 7JP
1201 50 1201 61 95625017 95655208
95656567

50 005 319

07.1995→08.2002
ReferenceXU 7JP
1001 77 1001 77

50 005 854

806 1.9 TD

12812.1994→08.2002
ReferenceXUD 9TE, XUD 9TF
1201 52 1201 65 1201 67 1201 91
1201 A4 95650955 95666768
→7389









50 005 313

12.1994→08.2002
ReferenceXUD 9TE, XUD 9TF
1201 A8
7390→

50 005 333

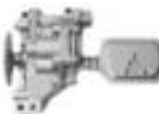
P



806 2.0i						129
05.1994→08.2002 Reference	XU 10J2 1001 77	1001 77				 50 005 854
06.1994→08.2002 Reference	XU 10J2CZ 1201 52 1201 A4	1201 65 95650955	1201 67 95666768	1201 91		 50 005 313
806 2.0i 16V						130
05.1998→09.2000 Reference	XU 10J4R 1001 77	1001 77				 50 005 854
09.2000→08.2002 Reference	EW10 J4 1201 E1	1201 F4	1201 G4			 50 005 761
806 2.0 HDI						131
08.1999→08.2002 Reference	DW10 ATED3 1001 92	1001 92				 50 005 824
08.1999→08.2002 Reference	DW10 ATED3 1201 C4					 50 005 329
806 2.0 HDI 16V						132
08.1999→08.2002 Reference	DW10 ATED4 1001 92	1001 92				 50 005 824
08.1999→08.2002 Reference	DW10 ATED4 1201 C4					 50 005 329
806 2.1 TD 12V						133
04.1996→08.2000 Reference	XUD 11BTE 1201 54 1336 L5	1201 55 96047088	1201 A7	1201 C6		 50 005 322

P



807 2.0i 16V

134

 06.2002→
Reference

 EW10 J4
1201 E1 1201 F4 1201 G4

50 005 761

807 2.0 HDi 16V

135

 12.2005→
Reference

 DW10 BTED4
1201E8

50 005 779

 06.2002→
Reference

 DW10 ATED4
1201 C4

50 005 329

807 2.2i 16V

136

 06.2002→
Reference

 EW12 J4
1201 E7 1201 F5 1201 G5

50 005 765

807 2.2 HDi 16V

137

 06.2002→
Reference

 DW12 TED4
1201E8

50 005 779

P

1007 1.4i

138

 10.2004→03.2008
Reference

 TU 3JP
1201 E3 1207 18 1207 23 9451001263
9617376980

50 005 310

1007 1.4 HDI

139

 10.2004→03.2008
Reference

 DV4 TD
1201 F9 1201 G8

50 005 758

1007 1.4i 16V

140

 10.2005→06.2007
Reference

 ET3 J4
1201 G2

50 005 766

**1007 1.6 HDi 16V****141**

01.2007→ Reference	DV6 TED4 1201 G1	1201 G9					50 005 762
-----------------------	---------------------	---------	--	--	---	--	------------

Boxer 1.9 D**142**

02.1994→02.2002 Reference	XUD 9A, XUD 9AU 1201 52 1201 A4	1201 65 95650955	1201 67 95666768	1201 91			50 005 313
------------------------------	---------------------------------------	---------------------	---------------------	---------	---	--	------------

Boxer 1.9 TD**143**

02.1994→02.2002 Reference	XUD 9UTF 1201 52 1201 A4	1201 65 95650955	1201 67 95666768	1201 91			50 005 313
------------------------------	--------------------------------	---------------------	---------------------	---------	---	--	------------

Boxer 2.0**144**

10.1989→02.2002 Reference	XU 10 2C 1201 52 1201 A4	1201 65 95650955	1201 67 95666768	1201 91			50 005 313
------------------------------	--------------------------------	---------------------	---------------------	---------	--	--	------------

Boxer 2.0i**145**

02.1994→02.2002 Reference	XU 10J2U 1201 52 1201 A4	1201 65 95650955	1201 67 95666768	1201 91			50 005 313
------------------------------	--------------------------------	---------------------	---------------------	---------	---	--	------------

Boxer 2.0 HDI**146**

09.2001→02.2002 Reference	DW10 TD 1201 C4						50 005 329
------------------------------	--------------------	--	--	--	---	--	------------

Boxer 2.5 D**147**

02.1994→02.2002 Reference 	DJ5 1201 70 →05.1996	1201 A3					50 005 330
02.1994→02.2002 Reference 	DJ5 1201 A5 06.1996→						50 005 331















P



02.1994→02.2002 Reference	DJ5 1001 84			50 005 860 NEW
Boxer 2.5 TD				148
07.1994→04.2002 Reference	DJ5 T 1201 70 1201 A3			50 005 330
07.1994→04.2002 Reference	DJ5 T 1201 A5			50 005 331
07.1994→04.2002 Reference	DJ5 T 1001 84			50 005 860 NEW
Boxer 2.5 DI TD				149
10.1996→02.2002 Reference	DJ5 TED 1201 A5			50 005 331
10.1996→02.2002 Reference	DJ5 TED 1001 84			50 005 860 NEW
Boxer II 2.0i				150
02.2002→ Reference	XU 10J2U 1201 52 1201 65 1201 67 1201 91 1201 A4 95650955 95666768			50 005 313
Boxer II 2.0 HDI				151
02.2002→ Reference	DW10 TD 1201 C4			50 005 329
Expert 1.8i				152
09.1996→ Reference	XU 7JP 1201 50 1201 61 95625017 95655208 95656567			50 005 319

P



						
09.1996→ Reference	XU 7JP 1201 77	1001 77				50 005 854
Expert 1.9 D 153						
09.1995→ Reference	XUD 9A, XUD 9AU 1201 52 1201 A4	1201 65 95650955	1201 67 95666768	1201 91		50 005 313
09.1995→ Reference	XUD 9AU 1001 56	1001 56				50 005 815
06.1998→ Reference	DW8, DW8 B 1201 C4					50 005 329
06.1998→ Reference	DW8 1001 91	1001 91				50 005 826
Expert 1.9 TD 154						
02.1996→ Reference	XUD 9TF 1201 52 1201 A4	1201 65 95650955	1201 67 95666768	1201 91		50 005 313
Expert 2.0 HDi 155						
10.1999→ Reference	DW10 ATED3, DW10 BTED 1201 C4					50 005 329
Expert 2.0 HDI 16V 156						
01.2007→ Reference	DW10 BTED4 1201E8					50 005 779
10.1999→ Reference	DW10 ATED4 1001 92	1001 92				50 005 824
10.1999→ Reference	DW10 ATED4 1201 C4					50 005 329

P



Expert 2.0i 16V

157

03.2000→	EW10 J4							
Reference	1201 E1	1201 F4	1201 G4					50 005 761

J5 1.9 D

158

11.1987→12.1993	XUD 9A							
Reference	1201 48 9401201480 95655210	1201 51 95641149 95656568	1201 60 95643824 95656569	1201 62 95655209				50 005 320

J5 2.5 D

159

09.1981→12.1993	CRD 93, CRD 93 L							
Reference	1201 36	75530147						50 005 306

J5 2.5 TD

160

07.1987→12.1993	CRD 93 LS							
Reference	1201 36	75530147						50 005 306

J 7 2.3 D

161

10.1978→09.1980	XD 2P94							
Reference	1001 32	1001 37						50 005 814

J9 2.3 D

162

09.1976→09.1987	XD 2, XD 2P, XD 94							
Reference	1001 32	1001 37						50 005 814

J9 2.5 D

163

09.1981→12.1993	CRD 93 L, CRD 93 LS							
Reference	1201 36	75530147						50 005 306

Partner 1.1i

164

07.1996→	TU 1JP							
Reference	1201-G0							50 005 757



P







07.1996→ Reference 	TU 1JP 1001 50 →ORGA 09687	1001 50					50 005 820	
07.1996→08.2002 Reference	TU 1M 1201 E3 9617376980	1207 18	1207 23	9451001263				50 005 310
Partner 1.4								165
11.1996→08.2002 Reference	TU 3-2 1201 E3 9617376980	1207 18	1207 23	9451001263				50 005 310
11.1996→08.2002 Reference	TU 3-2 1201 58 9608564280	1201 E4	1201 E6	1207 25				50 005 339
Partner 1.4i								166
07.1996→ Reference 	TU 3JP 1001 50 →ORGA 09687	1001 50					50 005 820	
07.1996→ Reference	TU 3JP 1201 E3 9617376980	1207 18	1207 23	9451001263				50 005 310
Partner 1.6 HDi 16V								167
07.2005→ Reference	DV6 TED4 1201 G1	1201 G9						50 005 762
Partner 1.8i								168
03.1997→08.2002 Reference	XU 7JB 1201 50 95656567	1201 61	95625017	95655208				50 005 319
03.1997→08.2002 Reference	XU 7JB 1001 77	1001 77					50 005 854	

P

**Partner 1.8 D****169**

07.1996→08.2002	XUD 7							
Reference	1201 52 1201 A4	1201 65 95650955	1201 67 95666768	1201 91				50 005 313
07.1996→08.2002	XUD 7							
Reference	1001 56	1001 56						50 005 815

Partner 1.9 D**170**

06.1996→08.2002	XUD 9A, XUD 9B							
Reference	1201 52 1201 A4 →7389	1201 65 95650955	1201 67 95666768	1201 91				50 005 313
07.1996→08.2002	XUD 9A							
Reference	1001 56	1001 56						50 005 815
11.1998→	DW8, DW8 B							
Reference	1201 C4							50 005 329
06.1996→08.2002	XUD 9A, XUD 9B							
Reference	1201 A8 XUD 9B: 7389→ XUD 9A: 7390→							50 005 333
11.1998→	DW8, DW8 B							
Reference	1001 91 DW8 B: ORGA 07910FV→ DW8: ORGA 08028FL→	1001 91						50 005 826

Partner 2.0 HDi**171**

12.1999→08.2005	DW10 TD							
Reference	1201 C4							50 005 329

Ranch 1.4i**172**

07.1997→	TU 3JP							
Reference	1201 E3 9617376980	1207 18	1207 23	9451001263				50 005 310

P



Ranch 1.9 D

173

11.1998→
Reference

DW8
1201 C4



50 005 329





P



			Cyl		mm	cm ³	Comp. Ratio ϵ	kW	PS	Pos
688 711	B		4	70 x 72	1108	2	9,5:1	25	34	147
688 712	B		4	70 x 72	1108	2	9,5:1	25	34	147, 217
688 713	B		4	70 x 72	1108	2	9,5:1	33	45	149
688.10	B		4	70 x 72	1108	2	9,5:1	26	35	161, 217
688.12	B		4	70 x 72	1108	2	9,5:1	25	34	147, 161
689 710	B		4	65 x 72	956	2	9,75:1	32	44	148
810 719	B		4	73 x 77	1289	2	8,2:1	33	45	151
810 725	B		4	73 x 77	1289	2	9,5:1	47	64	151
810 726	B		4	73 x 77	1289	2	9,5:1	31	42	146, 151
810 729	B		4	73 x 77	1289	2	9,6:1	40	54	151
8140.43.3700	D	(LA)	4	94,4 x 100	2798	2	18,5:1	85	115	93
8140.47.2700	D	(LA)	4	93 x 92	2499	2	18,5:1	85	116	92
8140.47.2721	D	(LA)	4	93 x 92	2499	2	18,5:1	85	116	92
8140.47.2785	D	(LA)	4	93 x 92	2499	2	18,5:1	85	116	92
8140.61.200	D	(AN)	4	93 x 90	2445	2	21:1	53	72	101
8140.61.2300	D	(AN)	4	93 x 90	2445	2	21:1	52-55	71-75	94, 97, 99, 101
8140.67.2500	D	(AN)	4	93 x 92	2499	2	22:1	55	75	256
829 720	B		4	88 x 82	1995	2	9,2:1	63	86	252
829.01	B		4	88 x 82	1995	2	9,2:1	76	103	176
829.710	B		4	88 x 82	1995	2	9,2:1	80	109	49, 189
840.725	B		4	76 x 77	1397	2	10:1	68	92	154
840 730	B	(LA)	4	76 x 77	1397	2	7:1	118	160	156, 157
847 712	B		4	76 x 77	1397	2	9,25:1	44	60	152
852 700	D	(AN)	4	86 x 89	2068	2	21,5:1	46	63	190
852 710	D	(AN)	4	86 x 89	2068	2	21,5:1	49	67	177
852 720	D	(AN)	4	86 x 89	2068	2	21,5:1	43	58	254
852 750	D	(AN)	4	86 x 89	2068	2	21,5:1	43	58	254
B1B 705	B		4	58 x 80	845	2	8:1	22	30	145
B1B 707	B		4	58 x 80	845	2	8:1	22	30	145
C1C 700	B		4	65 x 72	956	2	9/9,2:1	30-31	41-42	148
C1C 706	B		4	65 x 72	956	2	8,6:1	27	37	42
C1C 708	B		4	65 x 72	956	2	8,3:1	25	34	146
C1C 754	B		4	65 x 72	956	2	8,6:1	24	33	42
C1E 700	B		4	70 x 72	1108	2	8,8:1	36	49	3
C1E 714	B		4	70 x 72	1108	2	8,3:1	25	34	147
C1E 715	B		4	70 x 72	1108	2	9,25:1	35	48	162, 169
C1E 718	B		4	70 x 72	1108	2	8,3:1	25	34	147
C1E 719	B		4	70 x 72	1108	2	8,3:1	25	34	147
C1E 720	B		4	70 x 72	1108	2	9,25:1	35	48	162, 169
C1E 750	B		4	70 x 72	1108	2	9,5:1	33-36	45-47	43, 149, 210
C1E 752	B		4	70 x 72	1108	2	9,5:1	33-35	45-47	43, 149, 210
C1E 754	B		4	70 x 72	1108	2	8,8:1	34-36	46-49	43, 149, 210
C1E 756	B		4	70 x 72	1108	2	8,8:1	33-36	45-49	43, 149, 210
C1E 760	B		4	70 x 72	1108	2	8,8:1	34-36	46-49	149, 210
C1E 762	B		4	70 x 72	1108	2	8,8:1	34-36	46-49	43, 210
C1E 764	B		4	70 x 72	1108	2	8,8:1	34	46	43
C1E 792	B		4	70 x 72	1108	2	8,8:1	34	46	210
C1G 700	B		4	71,5 x 77	1237	2	9,25:1	40	54	150, 163, 170
C1G 710	B		4	71,5 x 77	1237	2	9,25:1	40	54	163, 170
C1G 720	B		4	71,5 x 77	1237	2	9,25:1	40	54	150, 163
C1G 726	B		4	71,5 x 77	1237	2	9,25:1	40	54	211
C1G 730	B		4	71,5 x 77	1237	2	9,25:1	40	54	179
C1J 715	B		4	76 x 77	1397	2	9,25:1	44	60	45, 213
C1J 742	B		4	76 x 77	1397	2	9,25:1	43	58	181
C1J 760	B	(LA)	4	76 x 77	1397	2	8,05:1	77	105	165, 172
C1J 764	B	(LA)	4	76 x 77	1397	2	8,05:1	77	105	165, 172
C1J 768	B		4	76 x 77	1397	2	9,25:1	44	60	45, 152, 164, 213
C1J 780	B		4	76 x 77	1397	2	9,25:1	43-44	58-60	45, 152, 213
C1J 782	B	(LA)	4	76 x 77	1397	2	8,05:1	77-85	105-116	153
C1J 784	B	(A)	4	76 x 77	1397	2	7,9:1	77-85	105-116	153
C1J 788	B	(LA)	4	76 x 77	1397	2	7,9:1	88	120	153
C1J 792	B		4	76 x 77	1397	2	9,25:1	44	60	164
C1J 796	B		4	76 x 77	1397	2	9,25:1	44	60	164
C2J 700	B		4	76 x 77	1397	2	9,25:1	50-53	68-72	152
C2J 713	B		4	76 x 77	1397	2	9,25:1	46	63	152
C2J 717	B		4	76 x 77	1397	2	9,25:1	44-53	60-72	152, 164, 171, 192
C2J 718	B		4	76 x 77	1397	2	9,25:1	49-53	67-72	152, 164, 171
C2J 720	B		4	76 x 77	1397	2	9,25:1	47-49	63-67	152, 164, 171
C2J 730	B		4	76 x 77	1397	2	9,25:1	44-49	60-67	164, 171

R

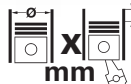





			Cyl		cm ³		Comp. Ratio ε	kW	PS	Pos
C2J 756	B		4	76 x 77	1397	2	9,25:1	47-49	63-67	164, 171
C2J 766	B		4	76 x 77	1397	2	9,25:1	47-49	63-67	152, 164, 171
C2J 767	B		4	76 x 77	1397	2	9,25:1	49-52	67-71	152, 164, 171
C2J 768	B		4	76 x 77	1397	2	9,25:1	47-49	63-67	164, 171
C2J 770	B		4	76 x 77	1397	2	9,25:1	50-51	67-70	192
C2J 772	B		4	76 x 77	1397	2	9,25:1	43	58	181
C2J 776	B		4	76 x 77	1397	2	9,25:1	50	68	181
C2J 780	B		4	76 x 77	1397	2	9,25:1	49	67	152
C2J 781	B		4	76 x 77	1397	2	9,25:1	49	67	152
C2J 784	B		4	76 x 77	1397	2	9:1	44	60	45, 213
C2J 788	B		4	76 x 77	1397	2	9,25:1	49	67	152
C2J 789	B		4	76 x 77	1397	2	9,25:1	49-53	67-72	152
C2J 792	B		4	76 x 77	1397	2	9,25:1	53	72	164
C2J 794	B		4	76 x 77	1397	2	9,25:1	47-49	63-67	164, 171
C2J 796	B		4	76 x 77	1397	2	9,25:1	53	72	164
C2J 798	B		4	76 x 77	1397	2	9,25:1	49-53	67-72	152
C3G 700	B		4	74 x 72	1239	2	9,2:1	40	54	5, 44, 212, 258
C3G 702	B		4	74 x 72	1239	2	9,2:1	40	54	258
C3G 710	B		4	74 x 72	1239	2	9,2:1	40	54	44, 212
C3G 712	B		4	74 x 72	1239	2	9,2:1	40	54	44, 212
C3G 720	B		4	74 x 72	1239	2	9,2:1	40	54	5
C3G 750	B		4	74 x 72	1239	2	9,2:1	40	54	5
C3J 700	B		4	76 x 77	1397	2	9:1	43-44	58-60	45, 152, 213
C3J 702	B		4	76 x 77	1397	2	9:1	44	60	45, 152, 213
C3J 710	B		4	75,8 x 77	1397	2	9:1	40-44	54-60	181
C3J 760	B		4	76 x 77	1397	2	9:1	44	60	46, 155, 182, 214
C3J 762	B		4	76 x 77	1397	2	9:1	44	60	46, 214
C6J 726	B	(A)	4	76 x 77	1397	2	8,6:1	81	110	156
D4F 740	B		4	69 x 76,8	1149	4	9,8:1	55	75	22, 141
D7F 700	B		4	69 x 76,8	1149	2	9,6:1	43-44	58-60	13, 258
D7F 701	B		4	69 x 76,8	1149	2	9,6:1	43-44	58-60	54, 258
D7F 702	B		4	69 x 76,8	1149	2	9,6:1	43-44	58-60	258
D7F 703	B		4	69 x 76,8	1149	2	9,6:1	43-44	58-60	258
D7F 704	B		4	69 x 76,8	1149	2	9,6:1	43-44	58-60	258
D7F 710	B		4	69 x 76,8	1149	2	9,6:1	43-44	58-60	13, 54
D7F 720	B		4	69 x 76,8	1149	2	9,6:1	43-44	58-60	13, 54
D7F 722	B		4	69 x 76,8	1149	2	9,6:1	43-44	58-60	13, 54
D7F 726	B		4	69 x 76,8	1149	2	9,6:1	43-44	58-60	13, 54
D7F 730	B		4	69 x 76,8	1149	2	9,6:1	40-43	54-58	5
E5F 710	B		4	75,8 x 64,9	1171	2	8,8:1	40	54	4
E5F 716	B		4	75,8 x 64,9	1171	2	8,8:1	40-44	54-60	4
E6J 700	B		4	75,8 x 77	1390	2	9,5:1	59	80	7, 181, 182
E6J 701	B		4	75,8 x 77	1390	2	9,5:1	58-59	79-80	182
E6J 706	B		4	75,8 x 77	1390	2	9,5:1	58-59	79-80	182
E6J 713	B		4	75,8 x 77	1390	2	9,5:1	55-57	75-77	6
E6J 718	B		4	75,8 x 77	1390	2	9,5:1	55-57	75-77	6
E6J 734	B		4	75,8 x 77	1390	2	8,9:1	40-44	55-60	46
E6J 738	B		4	75,8 x 77	1390	2	8,9:1	43	58	46
E6J 760	B		4	75,8 x 77	1390	2	9,5:1	55-57	75-77	6
E7F 700	B		4	75,8 x 64,9	1171	2	9,5:1	43	58	5
E7F 704	B		4	75,8 x 64,9	1171	2	9,25:1	44	60	5
E7F 706	B		4	75,8 x 64,9	1171	2	9,5:1	40	54-60	5
E7F 708	B		4	75,8 x 64,9	1171	2	9,25:1	43	58	5, 180
E7F 730	B		4	75,8 x 64,9	1171	2	9,25:1	40	55	180
E7F 750	B		4	75,8 x 64,9	1171	2	9,5:1	40	54	5
E7J 601	B		4	75,8 x 77	1390	2	9,5:1	58-59	79-80	7
E7J 624	B		4	75,8 x 77	1390	2	9,5:1	51	69	105
E7J 626	B		4	75,8 x 77	1390	2	9,5:1	51	69	105, 116, 125
E7J 634	B		4	75,8 x 77	1390	2	9,5:1	55	75	14, 55
E7J 635	B		4	75,8 x 77	1390	2	9,5:1	55	75	14, 55
E7J 700	B		4	75,8 x 77	1390	2	9,5:1	55-59	75-80	182
E7J 706	B		4	75,8 x 77	1390	2	9,5:1	55-59	75-80	182
E7J 710	B		4	75,8 x 77	1390	2	9,5:1	58-59	79-80	7
E7J 711	B		4	75,8 x 77	1390	2	9,5:1	58-59	79-80	7
E7J 716	B		4	75,8 x 77	1390	2	9,5:1	55-59	75-80	7
E7J 718	B		4	75,8 x 77	1390	2	9,5:1	58	79	7
E7J 719	B		4	75,8 x 77	1390	2	9,5:1	58	79	7
E7J 720	B		4	75,8 x 77	1390	2	9,5:1	55-59	75-80	46, 214
E7J 724	B		4	75,8 x 77	1390	2	9,5:1	55-59	75-80	46, 214



			Cyl		mm	cm ³	Comp. Ratio ϵ	kW	PS	Pos
E7J 726	B		4	75,8 x 77	1390	2	9,5:1	55-59	75-80	46, 214
E7J 728	B		4	75,8 x 77	1390	2	9,5:1	55-59	75-80	46, 214
E7J 742	B		4	75,8 x 77	1390	2	9,5:1	55-59	75-80	182
E7J 745	B		4	75,8 x 77	1390	2	9,5:1	55-59	75-80	182
E7J 754	B		4	75,8 x 77	1390	2	9,5:1	58	79	7, 46
E7J 756	B		4	75,8 x 77	1390	2	9,5:1	55	75	7
E7J 757	B		4	75,8 x 77	1390	2	9,5:1	55	75	7
E7J 764	B		4	75,8 x 77	1390	2	9,5:1	55	75	105, 116, 125, 222
E7J 770	B		4	75,8 x 77	1390	2	9,5:1	55-59	75-80	46, 214
E7J 771	B		4	75,8 x 77	1390	2	9,5:1	55-59	75-80	46, 214
E7J 773	B		4	75,8 x 77	1390	2	9,5:1	55-59	75-80	46, 214
E7J 780	B		4	75,8 x 77	1390	2	9,5:1	55	75	14, 55
F1N 720	B		4	81 x 83,5	1721	2	9,5:1	50-58	68-79	248
F1N 722	B		4	81 x 83,5	1721	2	9,5:1	58	79	248
F1N 724	B		4	81 x 83,5	1721	2	9,5:1	50	68	248
F2N 700	B		4	81 x 83,5	1721	2	10:1	59	80	167, 174
F2N 704	B		4	81 x 83,5	1721	2	10:1	59	80	167, 174
F2N 708	B		4	81 x 83,5	1721	2	10:1	60-66	82-90	167, 174
F2N 710	B		4	81 x 83,5	1721	2	10:1	60-66	82-90	159, 167, 174, 193
F2N 711	B		4	81 x 83,5	1721	2	10:1	66-68	90-92	193
F2N 712	B		4	81 x 83,5	1721	2	9,2:1	53-56	72-76	167, 174, 193
F2N 716	B		4	81 x 83,5	1721	2	9,2:1	55-56	75-76	193
F2N 720	B		4	81 x 83,5	1721	2	9,5:1	68	92	183, 193
F2N 721	B		4	81 x 83,5	1721	2	9,5:1	68	92	183
F2N 722	B		4	81 x 83,5	1721	2	9,5:1	66	90	183
F2N 724	B		4	81 x 83,5	1721	2	9,2:1	55-56	75-76	183
F2N 726	B		4	81 x 83,5	1721	2	9,5:1	68	92	183
F2N 727	B		4	81 x 83,5	1721	2	9,5:1	68	92	183
F2N 728	B		4	81 x 83,5	1721	2	9,2:1	55	75	183
F2N 730	B		4	81 x 83,5	1721	2	9,2:1	54	73	167, 174
F2N 732	B		4	81 x 83,5	1721	2	9,5:1	64	87	168, 175
F2N 740	B		4	81 x 83,5	1721	2	10:1	64-66	87-90	159
F2N 742	B		4	81 x 83,5	1721	2	10:1	64-66	87-90	159, 174
F2N 750	B		4	81 x 83,5	1721	2	10:1	66	90	193
F2N 752	B		4	81 x 83,5	1721	2	10:1	70	95	193
F2N 754	B		4	81 x 83,5	1721	2	9,5:1	70	95	194
F2N 758	B		4	81 x 83,5	1721	2	9,5:1	70	95	194
F2N 770	B		4	81 x 83,5	1721	2	9,5:1	68	92	8
F2N 786	B		4	81 x 83,5	1721	2	9,2:1	56	76	193
F2N 796	B		4	81 x 83,5	1721	2	10:1	59	80	168, 175
F2N 797	B		4	81 x 83,5	1721	2	10:1	59	80	168, 175
F2N 798	B		4	81 x 83,5	1721	2	9,5:1	55	75	168, 175
F2R 702	B		4	81 x 83,5	1721	2	9,5:1	70	95	194
F3N 716	B		4	81 x 83,5	1721	2	9,5:1	55	75	160
F3N 717	B		4	81 x 83,5	1721	2	9,5:1	55	75	160
F3N 718	B		4	81 x 83,5	1721	2	9,5:1	53-55	73-75	160, 168, 175, 184, 194
F3N 723	B		4	81 x 83,5	1721	2	10:1	66-70	90-95	194
F3N 726	B		4	81 x 83,5	1721	2	9,5:1	54	73	194
F3N 740	B		4	81 x 83,5	1721	2	9,5:1	54	73	184, 194
F3N 741	B		4	81 x 83,5	1721	2	9,5:1	54	73	184
F3N 742	B		4	81 x 83,5	1721	2	9,5:1	70	95	184
F3N 743	B		4	81 x 83,5	1721	2	9,5:1	66-70	90-95	184
F3N 746	B		4	81 x 83,5	1721	2	10:1	66-77	90-95	184
F3P 670	B		4	82,7 x 83	1783	2	9,7:1	69	94	63, 79
F3P 682	B		4	82,7 x 83	1783	2	9,8:1	79	107	185
F3P 700	B		4	82,7 x 83,5	1794	2	9,7:1	79	107	185
F3P 704	B		4	82,7 x 83,5	1794	2	9,7:1	65-70	88-95	185
F3P 705	B		4	82,7 x 83,5	1794	2	9,7:1	65-70	88-95	185
F3P 706	B		4	82,7 x 83,5	1794	2	9,7:1	65-68	88-92	185
F3P 707	B		4	82,7 x 83,5	1794	2	9,7:1	65	88	185
F3P 708	B		4	82,7 x 83,5	1794	2	9,7:1	65	88	185
F3P 710	B		4	82,7 x 83,5	1794	2	9,7:1	65	88	9, 63, 185
F3P 712	B		4	82,7 x 83,5	1794	2	9,8:1	80	109	9
F3P 714	B		4	82,7 x 83,5	1794	2	9,8:1	65	88	9
F3P 720	B		4	82,7 x 83	1783	2	9,7:1	69	94	63
F3P 724	B		4	82,7 x 83	1783	2	9,7:1	66-70	90-95	63, 79
F3P 754	B		4	82,7 x 83	1783	2	9,7:1	66	90	9, 185
F3P 755	B		4	82,7 x 83	1783	2	9,7:1	66	90	9
F3P 758	B		4	82,7 x 83	1783	2	9,8:1	79	107	9

R

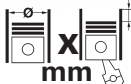





			Cyl		cm ³		Comp. Ratio ε	kW	PS	Pos
F3P 760	B		4	82,7 x 83,5	1794	2	9,7:1	65	88	185
F3P 765	B		4	82,7 x 83,5	1794	2	9,7:1	79	107	185
F3R 200	B		4	82,7 x 93	1998	2	9,8:1	84	114	261
F3R 722	B		4	82,7 x 93	1998	2	9,5:1	83	113	67, 83
F3R 723	B		4	82,7 x 93	1998	2	9,5:1	83	113	67, 83
F3R 728	B		4	82,7 x 93	1998	2	9,8:1	84	114	34
F3R 729	B		4	82,7 x 93	1998	2	9,8:1	84	114	34
F3R 742	B		4	82,7 x 93	1998	2	9,8:1	84	114	34
F3R 750	B		4	82,7 x 93	1998	2	9,7:1	84	114	67, 114, 124, 133, 231
F3R 751	B		4	82,7 x 93	1998	2	9,7:1	84	114	114, 124, 133, 231
F3R 768	B		4	82,7 x 93	1998	2	9,8:1	84	114	34, 83
F3R 769	B		4	82,7 x 93	1998	2	9,8:1	84	114	34, 83
F3R 797	B		4	82,7 x 93	1998	2	9,7:1	84	114	114
F3R 798	B		4	82,7 x 93	1998	2	9,7:1	84	114	114
F4P 720	B		4	82,7 x 83	1783	4	9,8:1	85	116	109, 226
F4P 722	B		4	82,7 x 83	1783	4	9,8:1	85	116	109, 226
F4P 760	B		4	82,7 x 83	1783	4	9,8:1	88	120	64
F4P 770	B		4	82,7 x 83	1783	4	9,8:1	88	120	73, 80
F4P 771	B		4	82,7 x 83	1783	4	9,8:1	85	116	73, 80
F4P 772	B		4	82,7 x 83	1783	4	9,8:1	88	120	73
F4P 773	B		4	82,7 x 83	1783	4	9,8:1	85	116	73, 80
F4P 774	B		4	82,7 x 83	1783	4	9,8:1	85	116	73, 80
F4P 775	B		4	82,7 x 83	1783	4	9,8:1	85	116	73, 80
F4R 700	B		4	82,7 x 93	1998	4	9,8:1	103	140	35
F4R 701	B		4	82,7 x 93	1998	4	9,8:1	102-103	139-140	35
F4R 712	B		4	82,7 x 93	1998	4	10:1	103	140	75, 84
F4R 713	B		4	82,7 x 93	1998	4	9,8/10:1	99	135	75, 84
F4R 714	B		4	82,7 x 93	1998	4	10:1	103	140	75, 84
F4R 715	B		4	82,7 x 93	1998	4	9,8/10:1	99	135	75, 84
F4R 720	B		4	82,7 x 93	1998	4	9,8:1	88	120	253
F4R 722	B		4	82,7 x 93	1998	4	9,8:1	88	120	253
F4R 730	B		4	82,7 x 93	1998	4	11:1	124	169	21
F4R 732	B		4	82,7 x 93	1998	4	11:1	124	169	21
F4R 736	B		4	82,7 x 93	1998	4	11:1	124	169	21
F4R 738	B		4	82,7 x 93	1998	4	11:1	124	169	21
F4R 740	B		4	82,7 x 93	1998	4	9,8:1	102	139	115, 232
F4R 741	B		4	82,7 x 93	1998	4	9,8:1	102	139	232
F4R 744	B		4	82,7 x 93	1998	4	9,8:1	99-103	135-140	232
F4R 746	B		4	82,7 x 93	1998	4	9,8:1	103	140	115
F4R 747	B		4	82,7 x 93	1998	4	9,8:1	99-103	135-140	232
F4R 760	B	(LA)	4	82,7 x 93	1998	4	9,5:1	120	163	2
F4R 761	B	(LA)	4	82,7 x 93	1998	4	9,5:1	120	163	2
F4R 762	B	(LA)	4	82,7 x 93	1998	4	9,5:1	120	163	259
F4R 763	B	(LA)	4	82,7 x 93	1998	4	9,5:1	120	163	259
F4R 764	B	(LA)	4	82,7 x 93	1998	4	9,5:1	120-125	163-170	76, 85, 139, 238, 259
F4R 765	B	(LA)	4	82,7 x 93	1998	4	9,5:1	120-125	163-170	76
F4R 766	B	(LA)	4	82,7 x 93	1998	4	9,5:1	120	163	259
F4R 767	B	(LA)	4	82,7 x 93	1998	4	9,5:1	120	163	259
F4R 770	B		4	82,7 x 93	1998	4	9,8:1	99-103	135-140	53, 138, 237
F4R 771	B		4	82,7 x 93	1998	4	9,8:1	99-103	135-140	53, 138, 237
F4R 774	B	(LA)	4	82,7 x 93	1998	4	9:1	165	225	140
F4R 776	B		4	82,7 x 93	1998	4	9,8:1	99-103	135-140	138, 237
F4R 780	B		4	82,7 x 93	1998	4	9,8:1	100-102	136-140	68, 84
F4R 786	B	(LA)	4	82,7 x 93	1998	4	9,5:1	120-125	163-170	76
F4R 787	B	(LA)	4	82,7 x 93	1998	4	9,5:1	150	204	76, 85
F4R 790	B		4	82,7 x 93	1998	4	9,8:1	100	136	39
F4R 791	B		4	82,7 x 93	1998	4	9,8:1	100	136	39
F4R 792	B		4	82,7 x 93	1998	4	9,8:1	100	136	39
F4R 794	B	(LA)	4	82,7 x 93	1998	4	9,5:1	120	163	40
F4R 795	B	(LA)	4	82,7 x 93	1998	4	9,5:1	120	163	40
F4R 796	B	(LA)	4	82,7 x 93	1998	4	9,5:1	125	170	40
F4R 797	B	(LA)	4	82,7 x 93	1998	4	9,5:1	125	170	40
F5R 700	B		4	82,7 x 93	1998	4	10:1	103	140	75, 84
F5R 740	B		4	82,7 x 93	1998	4	10:1	103	140	115
F7P 700	B		4	82 x 83,5	1764	4	10:1	103	140	186
F7P 704	B		4	82 x 83,5	1764	4	10:1	99-101	135-137	186
F7P 720	B		4	82,7 x 83,5	1794	4	10:1	99-103	135-140	10
F7P 722	B		4	82,7 x 83,5	1794	4	10:1	99	135	10
F7R 700	B		4	82,7 x 93	1998	4	10:1	108	147	12



			Cyl		mm	cm ³	Comp. Ratio ϵ	kW	PS	Pos
F7R 710	B		4	82,7 x 93	1998	4	9,8:1	110	150	115, 239
F7R 714	B		4	82,7 x 93	1998	4	9,8:1	110	150	115
F7R 720	B		4	82,7 x 93	1998	4	9,8:1	110	150	239
F8M 700	D	(AN)	4	78 x 83,5	1596	2	22,5:1	40	54	166, 173
F8M 720	D	(AN)	4	78 x 83,5	1596	2	22,5:1	40	54	47, 158, 215
F8M 730	D	(AN)	4	78 x 83,5	1596	2	22,5:1	40	55	47, 215
F8M 736	D	(AN)	4	78 x 83,5	1596	2	22,5:1	40	54	47, 215
F8M 760	D	(AN)	4	78 x 83,5	1596	2	22,5:1	40	54	215
F8Q 600	D	(AN)	4	80 x 93	1870	2	21,5:1	44-48	60-65	249
F8Q 606	D	(AN)	4	80 x 93	1870	2	21,5:1	44-48	60-65	249
F8Q 610	D	(A)	4	80 x 93	1870	2	20,5:1	66-68	90-92	188
F8Q 620	D	(AN)	4	80 x 93	1870	2	21,5:1	47	64	110, 120, 129
F8Q 622	D	(AN)	4	80 x 93	1870	2	21,5:1	47	64	110
F8Q 624	D	(AN)	4	80 x 93	1870	2	21,5:1	47	64	110
F8Q 630	D	(AN)	4	80 x 93	1870	2	21,5:1	47	64	19, 59
F8Q 632	D	(AN)	4	80 x 93	1870	2	21,5:1	47-48	64-65	19, 59
F8Q 640	D	(AN)	4	80 x 93	1870	2	21,5:1	40	54	216
F8Q 644	D	(AN)	4	80 x 93	1870	2	21,5:1	40	54	216
F8Q 646	D	(AN)	4	80 x 93	1870	2	21,5:1	47-48	64-65	216
F8Q 648	D	(AN)	4	80 x 93	1870	2	21,5:1	47-48	64-65	216
F8Q 662	D	(AN)	4	80 x 93	1870	2	21,5:1	40-48	54-65	19, 59
F8Q 672	D	(AN)	4	80 x 93	1870	2	21,5:1	47-48	64	11
F8Q 676	D	(AN)	4	80 x 93	1870	2	21,5:1	48	65	11
F8Q 678	D	(AN)	4	80 x 93	1870	2	21,5:1	47-48	64-65	11
F8Q 680	D	(AN)	4	80 x 93	1870	2	21,5:1	47-48	64-65	216
F8Q 682	D	(AN)	4	80 x 93	1870	2	21,5:1	40	54	216
F8Q 684	D	(AN)	4	80 x 93	1870	2	21,5:1	40-48	54-65	216
F8Q 692	D	(AN)	4	80 x 93	1870	2	21,5:1	47-48	64-65	11
F8Q 696	D	(AN)	4	80 x 93	1870	2	21,5:1	48	65	11
F8Q 706	D	(AN)	4	80 x 93	1870	2	21,5:1	47-48	64-65	187
F8Q 714	D	(AN)	4	80 x 93	1870	2	21,5:1	48	65	11
F8Q 722	D	(AN)	4	80 x 93	1870	2	21,5:1	47-48	64-65	48, 216
F8Q 724	D	(AN)	4	80 x 93	1870	2	21,5:1	47-48	64-65	48, 216
F8Q 730	D	(AN)	4	80 x 93	1870	2	21,5:1	47-48	64-65	11, 48, 216
F8Q 732	D	(AN)	4	80 x 93	1870	2	21,5:1	47-48	64-65	11, 48, 216
F8Q 740	D	(A)	4	80 x 93	1870	2	20,5:1	68	92	188
F8Q 742	D	(AN)	4	80 x 93	1870	2	21,5:1	47-48	64-65	187
F8Q 744	D	(A)	4	80 x 93	1870	2	20,5:1	66	90	188
F8Q 764	D	(AN)	4	80 x 93	1870	2	21,5:1	47-48	64-65	187
F8Q 768	D	(A)	4	80 x 93	1870	2	20,5:1	66-68	90-92	188
F8Q 774	D	(AN)	4	80 x 93	1870	2	21,5:1	47-48	64-65	48, 216
F8Q 776	D	(AN)	4	80 x 93	1870	2	21,5:1	47-48	64-65	48, 216
F8Q 784	D	(A)	4	80 x 93	1870	2	20,5:1	66-70	90-95	113, 121, 130, 188, 195, 228
F8Q 786	D	(A)	4	80 x 93	1870	2	20,5:1	66-70	90-95	113, 228
F8Q 788	D	(AN)	4	80 x 93	1870	2	20,5:1	47	64	227
F8Q 790	D	(AN)	4	80 x 93	1870	2	21,45:1	47	64	110, 227
F9Q 650	D	(A)	4	80 x 93	1870	2	18,3:1	88	120	74
F9Q 664	D	(LA)	4	80 x 93	1870	2	18,3:1	68	92	74, 91
F9Q 680	D	(LA)	4	80 x 93	1870	2	18,3:1	85	116	38
F9Q 710	D	(A)	4	80 x 93	1870	2	18,3:1	72	98	66
F9Q 716	D	(A)	4	80 x 93	1870	2	18,3:1	72	98	66, 81
F9Q 717	D	(A)	4	80 x 93	1870	2	18,3:1	72	98	66, 103
F9Q 718	D	(A)	4	80 x 93	1870	2	19:1	79	110	65, 82
F9Q 722	D	(A)	4	80 x 93	1870	2	18,3:1	72	98	1, 33
F9Q 730	D	(A)	4	80 x 93	1870	2	18,3:1	69-74	94-101	112, 122, 131, 229
F9Q 731	D	(A)	4	80 x 93	1870	2	18,3:1	72	98	112, 122, 131, 229
F9Q 732	D	(A)	4	80 x 93	1870	2	19:1	72-79	98-107	111, 123, 132, 230
F9Q 733	D	(A)	4	80 x 93	1870	2	19:1	72-79	98-107	111, 123, 132, 230
F9Q 734	D	(A)	4	80 x 93	1870	2	18,3:1	69-74	94-101	33, 66, 112, 122, 131, 229
F9Q 736	D	(A)	4	80 x 93	1870	2	18,3:1	72	98	112, 122, 131, 229
F9Q 738	D	(A)	4	80 x 93	1870	2	19:1	74-79	101-107	111, 230
F9Q 740	D	(A)	4	80 x 93	1870	2	19:1	75-79	102-107	111, 230
F9Q 744	D	(A)	4	80 x 93	1870	2	19:1	72-79	98-107	111, 230
F9Q 748	D	(A)	4	80 x 93	1870	2	19:1	75-79	102-107	230
F9Q 750	D	(A)	4	80 x 93	1870	2	18,3:1	88	120	74
F9Q 752	D	(A)	4	80 x 93	1870	2	19:1	74	101	74, 82
F9Q 754	D	(A)	4	80 x 93	1870	2	19:1	74-79	101-107	74, 82
F9Q 756	D	(A)	4	80 x 93	1870	2	18,3:1	88	120	74, 236

R

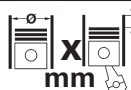





			Cyl	 X mm	cm ³		Comp. Ratio ε	kW	PS	Pos
F9Q 760	D	(A)	4	80 x 93	1870	2	19:1	74	101	251
F9Q 762	D	(A)	4	80 x 93	1870	2	19:1	60	82	250
F9Q 770	D	(A)	4	80 x 93	1870	2	18,3:1	58	79	103
F9Q 772	D	(A)	4	80 x 93	1870	2	18,3:1	60	82	91
F9Q 774	D	(A)	4	80 x 93	1870	2	18,3:1	58-60	79-82	91
F9Q 780	D	(A)	4	80 x 93	1870	2	18,3:1	59	80	20, 60
F9Q 782	D	(A)	4	80 x 93	1870	2	18,3:1	59	80	20, 60
F9Q 790	D	(A)	4	80 x 93	1870	2	19:1	62	84	61
F9Q 800	D	(A)	4	80 x 93	1870	2	18,3:1	88	120	137
F9Q 808	D	(A)	4	80 x 93	1870	2	18,3:1	66	95	137
F9Q 812	D	(LA)	4	80 x 93	1870	2	18,3:1	88	120	236
F9Q 820	D	(LA)	4	80 x 93	1870	2	18,3:1	88	120	38
F9Q 826	D	(LA)	4	80 x 93	1870	2	18,3:1	88	120	38
G8T 706	D	(AN)	4	87 x 92	2188	3	23:1	61-63	83-86	69, 86
G8T 714	D	(LA)	4	87 x 92	2188	3	22:1	83	113	37
G8T 716	D	(LA)	4	87 x 92	2188	3	22:1	83	113	37
G8T 740	D	(LA)	4	87 x 92	2188	3	22:1	83	113	37, 221
G8T 752	D	(AN)	4	87 x 92	2188	3	23:1	61-63	83-86	69, 86
G8T 760	D	(LA)	4	87 x 92	2188	3	22:1	83	113	37, 70, 88
G8T 790	D	(AN)	4	87 x 92	2188	3	23:1	61-63	83-86	69, 87
G8T 794	D	(AN)	4	87 x 92	2188	3	23:1	61-63	83-86	69, 87
G9T 702	D	(LA)	4	87 x 92	2188	4	18/19:1	110	150	77, 89, 260
G9T 710	D	(LA)	4	87 x 92	2188	4	18:1	85	115	36
G9T 722	D	(A)	4	87 x 92	2188	4	18:1	66	90	95
G9T 742	D	(LA)	4	87 x 92	2188	4	18:1	110	150	41
G9T 743	D	(LA)	4	87 x 92	2188	4	18:1	110	150	41
G9U 630	D	(LA)	4	87 x 92	2464	4	18,1:1	107	145	104, 257
G9U 720	D	(LA)	4	89 x 99	2463	4	21,25:1	73-84	99-115	104
G9U 730	D	(LA)	4	89 x 99	2463	4	18:1	99	135	257
J5R 716	B		4	88 x 82	1995	2	9,3:1	59	80	252
J5R 726	B		4	88 x 82	1995	2	9,2:1	58	79	252
J6R 234	B		4	88 x 82	1995	2	9,2:1	76-81	103-110	26
J6R 236	B		4	88 x 82	1995	2	9,2:1	74-80	101-109	26
J6R 706	B		4	88 x 82	1995	2	9,2:1	74-79	101-108	203
J6R 707	B		4	88 x 82	1995	2	9,2:1	74-79	101-108	203
J6R 710	B		4	88 x 82	1995	2	9,2:1	80	109	49
J6R 712	B		4	88 x 82	1995	2	9,2:1	80-81	109-110	49
J6R 715	B		4	88 x 82	1995	2	9,2:1	76-81	103-110	49, 176
J6R 716	B		4	88 x 82	1995	2	9,2:1	74	101	176
J6R 726	B		4	88 x 82	1995	2	9,2:1	80-81	109-110	49
J6R 734	B		4	88 x 82	1995	2	9,2:1	74	101	26
J6R 758	B		4	88 x 82	1995	2	9,2:1	75	102	196
J6R 759	B		4	88 x 82	1992	2	9,2:1	75	102	196
J6R 762	B		4	88 x 82	1995	2	9,2:1	74-79	101-108	203
J6R 763	B		4	88 x 82	1995	2	9,2:1	74-79	101-108	203
J6R 792	B		4	88 x 82	1995	2	9,2:1	75	102	196
J6R 793	B		4	88 x 82	1995	2	9,2:1	75	102	196
J6T 790	B		4	88 x 89	2165	2	9,2:1	81-85	110-116	202
J6T 791	B		4	88 x 89	2165	2	9,2:1	81-85	110-116	202
J7R 720	B		4	88 x 82	1995	3	9,3:1	100-103	136-140	205
J7R 721	B		4	88 x 82	1995	3	9,3:1	103	140	205
J7R 722	B		4	88 x 82	1995	2	10:1	88	120	204
J7R 723	B		4	88 x 82	1195	2	10:1	88	120	204
J7R 726	B		4	88 x 82	1995	3	9,3:1	99-100	135-136	205
J7R 732	B		4	88 x 82	1995	2	9,2:1	77-79	105-107	197, 218
J7R 740	B		4	88 x 82	1995	3	9,3:1	103	140	198
J7R 746	B		4	88 x 82	1995	2	10:1	88	120	197
J7R 747	B		4	88 x 82	1995	2	10:1	88	120	197
J7R 750	B		4	88 x 82	1995	2	10:1	86-88	117-120	197
J7R 751	B		4	88 x 82	1995	2	10:1	85-86	116-117	197
J7R 752	B	(LA)	4	88 x 82	1995	2	8:1	119-129	162-175	199
J7R 754	B		4	88 x 82	1995	3	9,3:1	99-100	135-136	198
J7R 756	B	(LA)	4	88 x 82	1995	2	8,5:1	119-121	162-165	199
J7R 760	B		4	88 x 82	1995	2	10:1	88	120	27
J7R 768	B		4	88 x 82	1995	2	9,2:1	76-77	103-105	30
J7T 600	B		4	88 x 89	2165	2	9,2:1	74	101	255
J7T 730	B		4	88 x 89	2165	2	9,9:1	90-93	123-126	208
J7T 731	B		4	88 x 89	2165	2	9,9:1	90-93	123-126	208
J7T 732	B		4	88 x 89	2165	2	9,2:1	79-81	107-110	208



			Cyl		mm	cm ³	Comp. Ratio ϵ	kW	PS	Pos
J7T 733	B		4	88 x 89	2165	2	9,2:1	79-81	107-110	208
J7T 754	B		4	88 x 89	2165	3	9,2:1	79-81	107-110	202
J7T 755	B		4	88 x 89	2165	2	9,2:1	77-81	105-110	202
J7T 761	B		4	88 x 89	2165	3	9,2:1	101-103	137-140	220
J7T 770	B		4	88 x 89	2165	2	9,2:1	79-81	107-110	29
J7T 772	B		4	88 x 89	2165	2	9,2:1	81	110	32
J7T 773	B		4	88 x 89	2165	2	9,2:1	81	110	32
J7T 776	B		4	88 x 89	2165	2	9,2:1	79-81	108-110	32
J7T 780	B		4	88 x 89	2165	2	9,2:1	69-71	94-97	255
J7T 782	B		4	88 x 89	2165	2	8,6:1	67	91	96
J7T 788	B		4	88 x 89	2165	2	8,6:1	67	91	96
J8S 174	D	(A)	4	86 x 89	2068	2	21,5:1	65	88	178
J8S 240	D	(LA)	4	86 x 89	2068	2	21,5:1	63-65	86-88	28, 191
J8S 600	D	(AN)	4	86 x 89	2068	2	21,5:1	46-56	63-76	200
J8S 604	D	(A)	4	86 x 89	2068	2	21,5:1	65-68	88-92	201
J8S 610	D	(LA)	4	86 x 89	2068	2	21:1	65	88	31
J8S 612	D	(LA)	4	86 x 89	2068	2	21:1	68	92	31
J8S 620	D	(AN)	4	86 x 89	2068	2	21,5:1	47	64	254
J8S 622	D	(AN)	4	86 x 89	2068	2	21,5:1	47	64	254
J8S 702	D	(A)	4	86 x 89	2068	2	21,5:1	63	86	209
J8S 704	D	(AN)	4	86 x 89	2068	2	21,5:1	49	67	200
J8S 706	D	(AN)	4	86 x 89	2068	2	21,5:1	47	64	206
J8S 708	D	(LA)	4	86 x 89	2068	2	21,5:1	63-65	88	207
J8S 711	D	(AN)	4	86 x 89	2068	2	21,5:1	49	67	177
J8S 712	D	(AN)	4	86 x 89	2068	2	21,5:1	65	88	50, 178
J8S 714	D	(LA)	4	86 x 89	2068	2	21/ 21,5:1	65	88	201
J8S 736	D	(AN)	4	86 x 89	2068	2	21,5:1	51	70	206
J8S 738	D	(LA)	4	86 x 89	2068	2	21,5:1	63	86	207
J8S 740	D	(AN)	4	86 x 89	2068	2	21,5:1	53	72	200
J8S 742	D	(A)	4	86 x 89	2068	2	21,5:1	65	88	201
J8S 746	D	(A)	4	86 x 89	2068	2	21,5:1	65	88	201
J8S 758	D	(AN)	4	86 x 89	2068	2	21,5:1	47	64	254
J8S 772	D	(LA)	4	86 x 89	2068	2	21,5:1	65	88	31
J8S 774	D	(LA)	4	86 x 89	2068	2	21,5:1	65	88	28
J8S 776	D	(LA)	4	86 x 89	2068	2	21:1	65-66	88-90	31
J8S 778	D	(LA)	4	86 x 89	2068	2	21:1	65-66	88-90	31
J8S 786	D	(A)	4	86 x 89	2068	2	21,5:1	65	88	201
J8S 788	D	(A)	4	86 x 89	2068	2	21,5:1	65	88	201
K4J 700	B		4	79,5 x 70	1390	4	10:1	72	98	15, 106
K4J 710	B		4	79,5 x 70	1390	4	10:1	72	98	15
K4J 711	B		4	79,5 x 70	1390	4	10:1	72	98	15
K4J 712	B		4	79,5 x 70	1390	4	10:1	70	95	15, 241, 245
K4J 713	B		4	79,5 x 70	1390	4	10:1	70	95	15, 241, 245
K4J 714	B		4	79,5 x 70	1390	4	10:1	70	95	15, 106, 117, 126, 223
K4J 730	B		4	79,5 x 70	1390	4	10:1	72	98	134, 233
K4J 732	B		4	79,5 x 70	1390	4	10:1	60	82	134
K4J 740	B		4	79,5 x 70	1390	4	10:1	72	98	134
K4J 750	B		4	79,5 x 70	1390	4	10:1	70-72	95-98	15, 106, 117, 126, 223, 233
K4J 770	B		4	79,5 x 70	1390	4	10:1	72	98	142
K4J 780	B		4	79,5 x 70	1390	4	10:1	72	98	23, 142
K4M 700	B		4	79,5 x 80,5	1598	4	10:1	79	110	108, 119, 128, 225
K4M 701	B		4	79,5 x 80,5	1598	4	10:1	79	107	108, 119, 128, 225
K4M 704	B		4	79,5 x 80,5	1598	4	10:1	79	107	108, 119, 128, 225
K4M 706	B		4	79,5 x 80,5	1598	4	10:1	79	107	108, 225
K4M 708	B		4	79,5 x 80,5	1598	4	10:1	70-79	95-107	18, 58, 108, 119, 128, 225
K4M 709	B		4	79,5 x 80,5	1598	4	10:1	79	107	108, 225
K4M 710	B		4	79,5 x 80,5	1598	4	10:1	79	107	72, 78
K4M 712	B		4	79,5 x 80,5	1598	4	10:1	79	107	108, 225
K4M 714	B		4	79,5 x 80,5	1598	4	10:1	79	107	72
K4M 720	B		4	79,5 x 80,5	1598	4	10:1	79	107	18, 62, 78, 108
K4M 724	B		4	79,5 x 80,5	1598	4	10:1	75-77	102-105	62, 78
K4M 730	B		4	79,5 x 80,5	1598	4	10:1	70	95	58
K4M 732	B		4	79,5 x 80,5	1598	4	10:1	66-70	90-95	18, 58
K4M 734	B		4	79,5 x 80,5	1598	4	10:1	66	90	17, 243, 247
K4M 744	B		4	79,5 x 80,5	1598	4	10:1	79	107	18
K4M 745	B		4	79,5 x 80,5	1598	4	10:1	79	107	18
K4M 746	B		4	79,5 x 80,5	1598	4	10:1	79	107	18

R

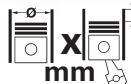

			Cyl		mm	cm ³		Comp. Ratio	ε	kW	PS	Pos
K4M 748	B		4	79,5 x 80,5	1598	4	10:1	79	107			18
K4M 750	B		4	79,5 x 80,5	1598	4	10:1	70	95			58
K4M 752	B		4	79,5 x 80,5	1598	4	10:1	70	95			58
K4M 753	B		4	79,5 x 80,5	1598	4	10:1	70	95			58
K4M 760	B		4	79,5 x 80,5	1598	4	10:1	82-85	110-116			136, 235
K4M 761	B		4	79,5 x 80,5	1598	4	10:1	82-85	110-116			52, 136, 235
K4M 764	B		4	79,5 x 80,5	1598	4	10:1	82-85	110-116			136, 235
K4M 782	B		4	79,5 x 80,5	1598	4	10:1	83	113			52, 235
K4M 790	B		4	79,5 x 80,5	1598	4	10:1	82	112			144
K4M 791	B		4	79,5 x 80,5	1598	4	10:1	82	112			144
K4M 794	B		4	79,5 x 80,5	1598	4	10:1	65	88			144
K4M 800	B		4	79,5 x 80,5	1598	4	10:1	82	112			25, 144
K4M 801	B		4	79,5 x 80,5	1598	4	10:1	82	112			25, 144
K4M 804	B		4	79,5 x 80,5	1598	4	10:1	65	88			25
K7J 700	B		4	75,8 x 77	1390	2	9,5:1	55	75			14, 55, 240, 244
K7J 701	B		4	75,8 x 77	1390	2	9,5:1	55	75			55
K7M 702	B		4	79,5 x 80,5	1598	2	9:1	55	75			107, 118, 127, 224
K7M 703	B		4	79,5 x 80,5	1598	2	9,6:1	66	90			107, 224
K7M 704	B		4	79,5 x 80,5	1598	2	9,6:1	66	90			107
K7M 720	B		4	79,5 x 80,5	1598	2	9:1	55	75			107, 118, 127, 224
K7M 744	B		4	79,5 x 80,5	1598	2	9,7:1	66	90			17
K7M 745	B		4	79,5 x 80,5	1598	2	9,7:1	66	90			17
K7M 746	B		4	79,5 x 80,5	1598	2	9,7:1	66	90			17, 57
K7M 790	B		4	79,5 x 80,5	1598	2	9,5:1	66	90			107, 118, 127
K9K 700	D	(LA)	4	76 x 80,5	1461	2	18,8:1	48-50	65-68			16, 56, 242, 246
K9K 702	D	(LA)	4	76 x 80,5	1461	2	18,8:1	60-62	82-85			16, 56
K9K 704	D	(LA)	4	76 x 80,5	1461	2	18,8:1	48-50	65-68			16, 56
K9K 706	D	(LA)	4	76 x 80,5	1461	2	18,8:1	48-50	65-68			16
K9K 710	D	(A)	4	76 x 80,5	1461	2	18,8:1	48-50	65-68			16, 56
K9K 712	D	(A)	4	76 x 80,5	1461	2	18,8:1	74	100			16
K9K 722	D	(A)	4	76 x 80,5	1461	2	18,8:1	60-63	82-86			135, 234
K9K 724	D	(LA)	4	76 x 80,5	1461	2	18,8:1	63	86			135, 143, 234
K9K 728	D	(LA)	4	76 x 80,5	1461	2	18,8:1	74-78	101-106			51, 135, 234
K9K 729	D	(LA)	4	76 x 80,5	1461	2	18,8:1	74-78	101-106			51, 135, 234
K9K 750	D	(LA)	4	76 x 80,5	1461	2	18,3:1	60-65	82-88			24, 143
K9K 752	D	(LA)	4	76 x 80,5	1461	2	18,8:1	48	65			24, 143
K9K 764	D	(LA)	4	76 x 80,5	1461	2	18,8:1	78	106			24, 143
K9K 766	D	(LA)	4	76 x 80,5	1461	2	17,9:1	63	86			24, 143
K9K 768	D	(A)	4	76 x 80,5	1461	2	18,8:1	50	68			24, 143
N7Q 700	B		4	83 x 90	1948	4	10,5:1	102-103	139-140			68, 84
N7Q 704	B		4	83 x 90	1948	4	10,5:1	102-103	139-140			68, 84
N7Q 710	B		4	83 x 90	1948	4	10,5:1	100	136			219
N7Q 711	B		4	83 x 90	1948	4	10,5:1	100	136			219
S8U 720	D	(AN)	4	93 x 90	2445	2	23:1	52-55	71-75			256
S8U 722	D	(AN)	4	93 x 90	2445	2	21:1	51	69			256
S8U 731	D	(AN)	4	93 x 90	2445	2	21:1	52-55	71-75			97, 99, 101
S8U 742	D	(AN)	4	93 x 92	2499	2	21:1	53	72			98, 100, 102, 256
S9U	D	(A)	4	93 x 92	2499	2	17,5:1	55	75			261
Z7X 765	B		6	93 x 72,7	2963	2	9,6:1	123-125	167-170			71, 90





Avantime 1.9 dTi

1

09.2001→12.2003	F9Q	722					
Reference	77 01 669 290 82 00 279 948 →11.2000	77 01 693 577	82 00 194 608	82 00 222 704		50 005 858	
09.2001→12.2003	F9Q	722					
Reference	77 01 462 809 77 01 465 816 77 01 473 365	77 01 463 111 77 01 466 578	77 01 463 397 77 01 468 491	77 01 464 736 77 01 468 492			50 005 301
09.2001→12.2003	F9Q	722					
Reference	82 00 199 281 12.2000→	82 00 243 154	82 00 279 953	82 00 741 635		50 005 254 NEW	

Avantime 2.0i Turbo 16V

2

09.2001→12.2003	F4R	760, 761					
Reference	77 01 693 588	82 00 194 613				50 005 862	
09.2001→12.2003	F4R	760, 761					
Reference	77 00 111 675	77 01 472 182					50 005 756
09.2001→12.2003	F4R	760, 761					
Reference	77 01 693 588	82 00 194 613	82 00 243 153	82 00 279 956		50 005 861	

Clio I 1.1

3

06.1990→03.1996	C1E	700					
Reference	77 01 588 187					50 005 856	
06.1990→03.1996	C1E	700					
Reference	77 01 462 145 89 82 775 051 ohne Gegengehäuse/without backhousing/sans demi-corps/sin remate/без заднего корпуса	77 01 462 491	77 01 463 377	77 01 466 419			50 005 302
06.1990→03.1996	C1E	700					
Reference	77 01 462 145 mit Gegengehäuse/with backhousing/avec demi-corps/con remate/с задним корпусом	77 01 462 491	77 01 463 377	77 01 466 419			50 005 326

Clio I 1.2

4

06.1990→02.1998	E5F	710, 716					
Reference	77 01 643 206	77 01 669 305	77 01 693 574	77 01 693 578		50 005 253 NEW	

R



06.1990→02.1998 Reference	E5F 77 00 736 091	710, 716 77 01 633 125		50 005 308
06.1990→02.1998 Reference	E5F 77 01 643 206	710, 716		50 005 847
Clio I 1.2i				5
04.1996→02.1998 Reference	D7F 77 00 864 596	730 82 00 037 686 82 00 088 660 82 00 088 663		50 005 335
06.1990→02.1998 Reference	E7F 77 01 643 206	700, 704, 706, 708, 750 77 01 669 305 77 01 693 574 77 01 693 578		50 005 253 <small>NEW</small>
09.1995→09.1998 Reference	C3G 77 01 467 153	700, 720, 750		50 005 759
04.1996→02.1998 Reference	D7F 82 00 266 947	730		50 005 934 <small>NEW</small>
01.1994→02.1998 Reference	E7F 77 00 736 091	708 77 01 633 125		50 005 308
09.1995→03.1996 Reference	C3G 77 01 588 187	720		50 005 856
06.1990→02.1998 Reference	E7F 77 01 643 206	700, 704, 706, 708, 750		50 005 847
Clio I 1.4				6
06.1990→02.1998 Reference	E6J 77 01 643 206	713, 718, 760 77 01 669 305 77 01 693 574 77 01 693 578		50 005 253 <small>NEW</small>

R



06.1990→02.1998 Reference	E6J 77 01 643 206	713, 718, 760			50 005 847
Clio I 1.4i					7
06.1990→02.1998 Reference	E7J 77 01 643 206	601, 710, 711, 716, 718, 719, 754, 756 77 01 669 305 77 01 693 574 77 01 693 578			50 005 253 <small>NEW</small>
06.1990→12.1992 01.1994→02.1998 Reference	E6J E7J 77 00 736 091	700 754, 756 77 01 633 125			50 005 308
04.1996→02.1998 Reference	E7J 77 01 669 300	757 77 01 693 575			50 005 859
06.1990→02.1998 Reference	E7J 77 01 643 206	601, 710, 711, 716, 718, 719, 754, 756			50 005 847
06.1990→02.1998 Reference	E7J 77 00 866 518	718, 719, 757 82 00 146 301			50 005 040 <small>NEW</small>
Clio I 1.7					8
06.1990→03.1996 Reference	F2N 77 00 859 570 77 01 611 364	770 77 00 864 218 77 00 864 220 77 01 590 269			50 005 865
06.1990→03.1996 Reference	F2N 77 01 462 809 77 01 465 816 77 01 473 365	770 77 01 463 111 77 01 466 578 77 01 463 397 77 01 468 491 77 01 464 736 77 01 468 492			50 005 301
Clio I 1.8i					9
06.1990→02.1998 Reference	F3P 77 00 859 570 77 01 611 364	710, 712, 714, 754, 755, 758 77 00 864 218 77 00 864 220 77 01 590 269			50 005 865
		F3P 710, F3P 712, F3P 714: 05.1993→			
06.1990→02.1998 Reference	F3P 77 01 462 809 77 01 465 816 77 01 473 365	710, 712, 714, 754, 758 77 01 463 111 77 01 466 578 77 01 463 397 77 01 468 491 77 01 464 736 77 01 468 492			50 005 301

R



Clio I 1.8i 16V

10

03.1991→03.1996	F7P	720, 722						
Reference	77 00 859 570	77 00 864 218	77 00 864 220	77 01 590 269				
	77 01 611 364							
	F7P 722: →06.1993					50 005 865		
03.1991→03.1996	F7P	720, 722						
Reference	77 01 462 809	77 01 463 111	77 01 463 397	77 01 464 736				
	77 01 465 816	77 01 466 578	77 01 468 491	77 01 468 492				50 005 301
	77 01 473 365							

Clio I 1.9 D

11

09.1996→02.1998	F8Q	692, 696						
Reference	77 01 669 290	77 01 693 577	82 00 194 608	82 00 222 704				
	82 00 279 948					50 005 858		
06.1990→02.1998	F8Q	676, 678, 714, 730, 732						
Reference	77 00 859 570	77 00 864 218	77 00 864 220	77 01 590 269				
	77 01 611 364					50 005 865		
06.1990→02.1998	F8Q	672, 676, 678, 692, 696, 730, 732						
Reference	77 01 462 809	77 01 463 111	77 01 463 397	77 01 464 736				
	77 01 465 816	77 01 466 578	77 01 468 491	77 01 468 492				50 005 301
	77 01 473 365							

Clio I 2.0i Williams 16V

12

07.1992→03.1996	F7R	700						
Reference	77 01 462 809	77 01 463 111	77 01 463 397	77 01 464 736				
	77 01 465 816	77 01 466 578	77 01 468 491	77 01 468 492				50 005 301
	77 01 473 365							

Clio II 1.2i

13

03.1996→	D7F	700, 710, 720, 722, 726						
Reference	77 00 864 596	82 00 037 686	82 00 088 660	82 00 088 663				
								50 005 335
03.1996→	D7F	700, 710, 720, 722, 726						
Reference	82 00 266 947							50 005 934
								NEW

Clio II 1.4i

14

03.1998→10.2007	E7J	634, 635, 780						
10.1999→10.2007	K7J	700						
Reference	77 01 669 300	77 01 693 575						
	E7J 634, E7J 635, E7J 780: →02.2002					50 005 859		
	K7J 700: →10.2001							
03.1998→10.2007	E7J	634, 635, 780						
Reference	77 00 866 518	82 00 146 301						50 005 040
								NEW

R



Clio II 1.4i 16V

15

10.1999→ Reference 	K4J 710, 711, 712, 713 82 00 101 970 82 00 227 686 07.2001→		50 005 849	
10.1999→ Reference	K4J 700, 712, 713, 714, 750 77 00 105 176 77 00 105 378 77 00 274 330 82 00 146 297 82 00 428 447 82 00 582 675			50 005 170 NEW
10.1999→ Reference 	K4J 710, 711, 712, 713 77 01 693 576 →06.2001		50 005 846	

Clio II 1.5 dCi

16

06.2000→ Reference 	K9K 700, 702, 704, 706, 710, 712 82 00 101 970 82 00 227 686 K9K 700, K9K 704: 07.2001→02.2006 K9K 702, K9K 706: →02.2006		50 005 849	
03.2003→ Reference	K9K 712 77 01 475 995 77 01 478 031			50 005 027 NEW
06.2000→ Reference 	K9K 700, 704 77 01 693 576 →06.2001		50 005 846	
06.2000→ Reference	K9K 700, 702, 704, 710 77 01 473 327 77 01 476 496			50 005 171 NEW

R

Clio II 1.6i

17

03.1998→ Reference	K7M 744, 745 77 00 864 596 82 00 037 686 82 00 088 660 82 00 088 663			50 005 335
11.2001→ Reference	K4M 734 82 00 101 970 82 00 227 686		50 005 849	
03.1998→ Reference	K7M 744, 745 82 00 266 947			50 005 934 NEW



03.1998→ Reference 	K7M 744, 745, 746 77 01 669 300 77 01 693 575 K7M 746: →10.2001				50 005 859
Clio II 1.6i 16V					18
08.2000→ Reference 	K4M 708, 732, 744, 745, 746 82 00 101 970 82 00 227 686 K4M 708, K4M 744: 07.2001→ K4M 746: →09.2006				50 005 849
06.1998→ Reference	K4M 708, 748 82 00 266 947				50 005 934 NEW
03.1998→ Reference	K4M 708, 720, 748 77 00 105 176 77 00 105 378 77 00 274 330 82 00 146 297 82 00 428 447 82 00 582 675				50 005 170 NEW
06.1998→ Reference 	K4M 708, 744, 748 77 01 693 576 K4M 708, K4M 744: →06.2001				50 005 846
Clio II 1.9 D					19
03.1998→ Reference	F8Q 630, 632, 662 77 01 669 290 77 01 693 577 82 00 194 608 82 00 222 704 82 00 279 948				50 005 858
03.1998→ Reference	F8Q 630, 662 77 01 462 809 77 01 463 111 77 01 463 397 77 01 464 736 77 01 465 816 77 01 466 578 77 01 468 491 77 01 468 492 77 01 473 365				50 005 301
Clio II 1.9 DTi					20
03.1999→10.2007 Reference 	F9Q 780, 782 77 01 669 290 77 01 693 577 82 00 194 608 82 00 222 704 82 00 279 948 F9Q 782: →09.2000 F9Q 780: →11.2000				50 005 858
03.1999→10.2007 Reference	F9Q 780 77 01 462 809 77 01 463 111 77 01 463 397 77 01 464 736 77 01 465 816 77 01 466 578 77 01 468 491 77 01 468 492 77 01 473 365				50 005 301
03.1999→10.2007 Reference 	F9Q 780, 782 82 00 199 281 82 00 243 154 82 00 279 953 82 00 741 635 F9Q 782: 10.2000→ F9Q 780: 12.2000→				50 005 254 NEW
Clio II 2.0i 16V					21
03.1999→ Reference	F4R 730, 732, 736, 738 77 01 669 290 77 01 693 577 82 00 194 608 82 00 222 704 82 00 279 948				50 005 858

R



Clio III 1.2i 16V

22

06.2005→	D4F	740						
Reference	77 00 864 596	82 00 037 686	82 00 088 660	82 00 088 663				50 005 335
06.2005→	D4F	740						50 005 934
Reference	82 00 266 947							NEW

Clio III 1.4i 16V

23

06.2005→	K4J	780						
Reference	82 00 101 970	82 00 227 686				50 005 849		
	→09.2006							
06.2005→	K4J	780						50 005 170
Reference	77 00 105 176	77 00 105 378	77 00 274 330	82 00 146 297				NEW
	82 00 428 447	82 00 582 675						

Clio III 1.5 dCi

24

06.2005→	K9K	764, 766, 768						
Reference	77 01 475 995	77 01 478 031						50 005 027
								NEW
06.2005→	K9K	750, 752						50 005 171
Reference	77 01 473 327	77 01 476 496						NEW



Clio III 1.6i 16V

25

06.2005→	K4M	800, 801, 804						
Reference	82 00 101 970	82 00 227 686				50 005 849		
	→09.2006							
06.2005→	K4M	800, 801, 804						50 005 170
Reference	77 00 105 176	77 00 105 378	77 00 274 330	82 00 146 297				NEW
	82 00 428 447	82 00 582 675						

Espace I 2.0

26

07.1984→12.1990	J6R	234, 236, 734						
Reference	77 01 461 405	77 01 463 182						50 005 325
07.1984→12.1990	J6R	234, 236, 734						
Reference	77 01 465 119	77 01 465 761	77 01 585 084	79 46 004 571		50 005 857		













Espace I 2.0i

27

06.1987→12.1990	J7R	760						
Reference	77 01 461 405	77 01 463 182						50 005 325

R



				
06.1987→12.1990 Reference	J7R 760 77 01 465 119 77 01 465 761 77 01 585 084 79 46 004 571		50 005 857	
Espace I 2.1 TD				28
10.1984→12.1990 Reference	J8S 240 77 01 461 405 77 01 463 182			50 005 325
10.1984→12.1990 Reference	J8S 240, 774 77 01 465 119 77 01 465 761 77 01 585 084 79 46 004 571		50 005 857	
Espace I 2.2i				29
07.1986→12.1990 Reference	J7T 770 77 01 461 405 77 01 463 182			50 005 325
07.1986→12.1990 Reference	J7T 770 77 01 465 119 77 01 465 761 77 01 585 084 79 46 004 571		50 005 857	
Espace II 2.0i				30
01.1991→09.1996 Reference	J7R 768 77 01 465 513			50 005 341
01.1991→09.1996 Reference	J7R 768 77 01 465 119 77 01 465 761 77 01 585 084 79 46 004 571		50 005 857	
Espace II 2.1 TD				31
01.1991→09.1996 Reference	J8S 610, 612, 772, 776, 778 77 01 466 571			50 005 317
01.1991→09.1996 Reference	J8S 610, 612, 772, 776, 778 77 01 465 119 77 01 465 761 77 01 585 084 79 46 004 571		50 005 857	

R



Espace II 2.2i

32

01.1991→09.1996	J7T	772, 773, 776					
Reference	77 01 465 513						50 005 341
01.1991→09.1996	J7T	772, 773, 776					
Reference	77 01 465 119	77 01 465 761	77 01 585 084	79 46 004 571			50 005 857

Espace III 1.9 dTi

33

02.1999→10.2002	F9Q	722					
Reference	77 01 669 290 82 00 279 948 →11.2000	77 01 693 577	82 00 194 608	82 00 222 704			50 005 858
02.1999→10.2002	F9Q	722, 734					
Reference	77 01 462 809 77 01 465 816 77 01 473 365	77 01 463 111 77 01 466 578	77 01 463 397 77 01 468 491	77 01 464 736 77 01 468 492			50 005 301
02.1999→10.2002	F9Q	722					
Reference	82 00 199 281 12.2000→	82 00 243 154	82 00 279 953	82 00 741 635			50 005 254 NEW

Espace III 2.0i

34

11.1996→10.2000	F3R	742, 768, 769					
Reference	77 01 669 290 82 00 279 948	77 01 693 577	82 00 194 608	82 00 222 704			50 005 858
11.1996→10.2000	F3R	728, 729					
Reference	77 00 859 570 77 01 611 364	77 00 864 218	77 00 864 220	77 01 590 269			50 005 865
11.1996→10.2000	F3R	768, 769					
Reference	77 01 462 809 77 01 465 816 77 01 473 365	77 01 463 111 77 01 466 578	77 01 463 397 77 01 468 491	77 01 464 736 77 01 468 492			50 005 301

Espace III 2.0i 16V

35

10.1998→10.2002	F4R	700, 701					
Reference	77 01 462 809 77 01 465 816 77 01 473 365	77 01 463 111 77 01 466 578	77 01 463 397 77 01 468 491	77 01 464 736 77 01 468 492			50 005 301
10.1998→10.2002	F4R	700, 701					
Reference	77 01 693 588	82 00 194 613					50 005 862
10.1998→10.2002	F4R	700, 701					
Reference	77 01 693 588	82 00 194 613	82 00 243 153	82 00 279 956			50 005 861

R



Espace III 2.2 dCi 16V

36

07.2000→10.2002	G9T	710						
Reference	77 01 472 625	77 01 474 190	82 00 129 206					50 005 794

Espace III 2.2 TD 12V

37

10.1996→10.2002	G8T	714, 716, 740, 760						
Reference	77 00 106 101 82 00 042 514	77 00 107 845	77 00 111 841	77 00 861 627				50 005 336





Espace IV 1.9 dCi

38

11.2002→12.2006	F9Q	820						
Reference	82 00 199 281 →08.2007	82 00 243 154	82 00 279 953	82 00 741 635			50 005 254 <small>NEW</small>	
11.2002→	F9Q	680, 820, 826						
Reference	77 00 111 675	77 01 472 182						50 005 756





Espace IV 2.0i 16V

39

07.2004→	F4R	792						
Reference	77 01 669 290 82 00 279 948	77 01 693 577	82 00 194 608	82 00 222 704			50 005 858	
11.2002→	F4R	790						
Reference	77 01 693 588	82 00 194 613					50 005 862	
11.2002→	F4R	790, 791						
Reference	77 00 111 675	77 01 472 182						50 005 756
11.2002→	F4R	790						
Reference	77 01 693 588	82 00 194 613	82 00 243 153	82 00 279 956			50 005 861	

Espace IV 2.0i Turbo 16V

40

06.2004→	F4R	796, 797						
Reference	77 01 669 290 82 00 279 948	77 01 693 577	82 00 194 608	82 00 222 704			50 005 858	
11.2002→12.2006	F4R	794, 795						
Reference	77 01 693 588 F4R 794: →01.2007	82 00 194 613					50 005 862	
11.2002→	F4R	794, 795, 797						
Reference	77 00 111 675	77 01 472 182						50 005 756
11.2002→12.2006	F4R	794, 795						
Reference	77 01 693 588 F4R 794: →01.2007	82 00 194 613	82 00 243 153	82 00 279 956			50 005 861	

R





Espace IV 2.2 dCi 16V

41

11.2002→ Reference	G9T 77 01 472 625	742, 743 77 01 474 190	82 00 129 206		50 005 794
-----------------------	----------------------	---------------------------	---------------	---	------------

Express 1.0

42

03.1986→08.1991 Reference	C1C 77 01 588 187	706 , 754			50 005 856
03.1986→08.1991 Reference	C1C 77 01 462 145 89 82 775 051	706 , 754 77 01 462 491	77 01 463 377 77 01 466 419		50 005 302
	ohne Gegengehäuse/without backhousing/sans demi-corps/sin remate/без заднего корпуса				
03.1986→08.1991 Reference	C1C 77 01 462 145	706 , 754 77 01 462 491	77 01 463 377 77 01 466 419		50 005 326
	mit Gegengehäuse/with backhousing/avec demi-corps/con remate/с задним корпусом				

Express 1.1

43

03.1986→10.1997 Reference	C1E 77 01 588 187	750, 752, 754, 756, 762, 764			50 005 856
03.1986→10.1997 Reference	C1E 77 01 462 145 89 82 775 051	750, 752, 754, 756, 762, 764 77 01 462 491	77 01 463 377 77 01 466 419		50 005 302
	ohne Gegengehäuse/without backhousing/sans demi-corps/sin remate/без заднего корпуса				
03.1986→10.1997 Reference	C1E 77 01 462 145	750, 752, 754, 756, 762, 764 77 01 462 491	77 01 463 377 77 01 466 419		50 005 326
	mit Gegengehäuse/with backhousing/avec demi-corps/con remate/с задним корпусом				

Express 1.2i

44

09.1991→10.1997 Reference	C3G 77 01 467 153	700, 710, 712			50 005 759
07.1993→06.1997 Reference	C3G 77 01 588 187	710, 712			50 005 856

R









Express 1.4

45

03.1986→09.1997 06.1987→09.1997 03.1986→08.1991 Reference	C1J C2J C3J 77 01 588 187	715, 768, 780 784 700, 702		50 005 856	
03.1986→08.1991 06.1987→09.1997 03.1986→08.1991 Reference	C1J C2J C3J 77 01 462 145 89 82 775 051	768, 780 784 700, 702 77 01 462 491 77 01 463 377 77 01 466 419		50 005 302	
					ohne Gegengehäuse/without backhousing/sans demi-corps/sin remate/без заднего корпуса
03.1986→08.1991 06.1987→09.1997 03.1986→08.1991 Reference	C1J C2J C3J 77 01 462 145 89 82 775 051	768, 780 784 700, 702 77 01 462 491 77 01 463 377 77 01 466 419		50 005 326	
					mit Gegengehäuse/with backhousing/avec demi-corps/con remate/с задним корпусом

Express 1.4i

46

03.1986→09.1997 09.1991→10.1997 Reference	E6J E7J 77 01 643 206 77 01 669 305 77 01 693 574 77 01 693 578	734, 738 720, 724, 726, 728, 773		50 005 253 <small>NEW</small>	
09.1991→10.1997 Reference	E7J 77 00 736 091 77 01 633 125	720, 724, 726, 728, 754		50 005 308	
06.1987→03.1997 Reference	C3J 77 01 588 187	760, 762		50 005 856	
09.1991→03.1997 Reference	C3J 77 01 462 145 89 82 775 051	762 77 01 462 491 77 01 463 377 77 01 466 419		50 005 302	
					ohne Gegengehäuse/without backhousing/sans demi-corps/sin remate/без заднего корпуса
03.1996→09.1997 Reference	E7J 77 01 669 300 77 01 693 575	770, 771		50 005 859	
09.1991→03.1997 Reference	C3J 77 01 462 145 89 82 775 051	762 77 01 462 491 77 01 463 377 77 01 466 419		50 005 326	
					mit Gegengehäuse/with backhousing/avec demi-corps/con remate/с задним корпусом

R



03.1986→09.1997 09.1991→10.1997 Reference	E6J E7J 77 01 643 206	734, 738 720, 724, 726, 728, 773			50 005 847
03.1996→09.1997 Reference	E7J 77 00 866 518	770, 771 82 00 146 301			50 005 040 NEW
Express 1.6 D					47
03.1986→03.1997 Reference	F8M 77 00 859 570 77 01 611 364	720, 730, 736 77 00 864 218 77 00 864 220 77 01 590 269			50 005 865
03.1986→03.1997 Reference	F8M 77 01 462 809 77 01 465 816 77 01 473 365	720, 730, 736 77 01 463 111 77 01 466 578 77 01 463 397 77 01 468 491 77 01 464 736 77 01 468 492			50 005 301
Express 1.9 D					48
09.1991→10.1997 Reference	F8Q 77 00 859 570 77 01 611 364	722, 724, 774, 776 77 00 864 218 77 00 864 220 77 01 590 269			50 005 865
09.1991→10.1997 Reference	F8Q 77 01 462 809 77 01 465 816 77 01 473 365	722, 724, 730, 732, 774 77 01 463 111 77 01 466 578 77 01 463 397 77 01 468 491 77 01 464 736 77 01 468 492			50 005 301
Fuego 2.0					49
10.1980→10.1985 10.1980→10.1985 Reference	829.710 J6R 77 01 461 405	710, 712, 715, 726 77 01 463 182			50 005 325
Fuego 2.1 TD					50
10.1982→07.1984 Reference	J8S 77 01 461 405	712 77 01 463 182			50 005 325
Grand Scénic 1.5 dCi					51
04.2004→ Reference	K9K 77 01 475 995	728, 729 77 01 478 031			50 005 027 NEW
Grand Scénic 1.6i 16V					52
04.2004→ Reference	K4M 77 00 105 176 82 00 428 447	761, 782 77 00 105 378 82 00 582 675 77 00 274 330 82 00 146 297			50 005 170 NEW

R



Grand Scénic 2.0i 16V

53

04.2004→ Reference	F4R 770, 771 77 00 111 675 77 01 472 182			50 005 756
-----------------------	--	---	--	------------

Kangoo 1.2i

54

10.1997→ Reference	D7F 701, 710, 720, 722, 726 77 00 864 596 82 00 037 686 82 00 088 660 82 00 088 663			50 005 335
10.1997→ Reference	D7F 701, 710, 720, 722, 726 82 00 266 947			50 005 934 <small>NEW</small>





Kangoo 1.4i

55

10.1997→ 06.2000→ Reference 	E7J K7J 634, 635, 780 700, 701 77 01 669 300 77 01 693 575 E7J 634, E7J 635, E7J 780: →02.2002 K7J 700, K7J 701: →10.2001		50 005 859	
10.1997→ Reference	E7J 634, 635, 780 77 00 866 518 82 00 146 301			50 005 040 <small>NEW</small>

Kangoo 1.5 dCi

56

05.2000→ Reference 	K9K 700, 702, 704, 710 82 00 101 970 82 00 227 686 K9K 700, K9K 704: 07.2001→02.2006 K9K 702: →02.2006		50 005 849	
05.2000→ Reference	K9K 702, 710 77 00 105 176 77 00 105 378 77 00 274 330 82 00 146 297 82 00 428 447 82 00 582 675			50 005 170 <small>NEW</small>
05.2000→ Reference 	K9K 700, 704 77 01 693 576 →06.2001		50 005 846	
05.2000→ Reference	K9K 700, 704 77 01 473 327 77 01 476 496			50 005 171 <small>NEW</small>

Kangoo 1.6i

57

09.1999→ Reference 	K7M 746 77 01 669 300 77 01 693 575 →10.2001		50 005 859	
--	---	---	------------	--

Kangoo 1.6i 16V

58

06.2000→ Reference 	K4M 708, 730, 732, 750, 752, 753 82 00 101 970 82 00 227 686 K4M 708, K4M 750, K4M 752: 07.2001→		50 005 849	
--	---	---	------------	--

R





06.2000→ Reference	K4M 82 00 266 947	708			50 005 934 NEW
06.2000→ Reference	K4M 77 00 105 176 82 00 428 447	708, 750, 752, 753 77 00 105 378 82 00 582 675	77 00 274 330	82 00 146 297	50 005 170 NEW
06.2000→ Reference 	K4M 77 01 693 576 →06.2001	708, 750, 752			50 005 846
Kangoo 1.9 D					59
10.1997→ Reference	F8Q 77 01 669 290 82 00 279 948	630, 632, 662 77 01 693 577	82 00 194 608	82 00 222 704	 50 005 858
10.1997→ Reference	F8Q 77 01 462 809 77 01 465 816 77 01 473 365	630, 662 77 01 463 111 77 01 466 578	77 01 463 397 77 01 468 491	77 01 464 736 77 01 468 492	 50 005 301
Kangoo 1.9 dTi					60
09.1998→ Reference 	F9Q 77 01 669 290 82 00 279 948 F9Q 782: →09.2000 F9Q 780: →11.2000	780, 782 77 01 693 577	82 00 194 608	82 00 222 704	 50 005 858
09.1998→ Reference	F9Q 77 01 462 809 77 01 465 816 77 01 473 365	780 77 01 463 111 77 01 466 578	77 01 463 397 77 01 468 491	77 01 464 736 77 01 468 492	 50 005 301
09.1998→ Reference 	F9Q 82 00 199 281	780, 782 82 00 243 154	82 00 279 953	82 00 741 635	50 005 254 NEW
Kangoo 1.9 dCi					61
05.2000→ Reference	F9Q 77 01 462 809 77 01 465 816 77 01 473 365	790 77 01 463 111 77 01 466 578	77 01 463 397 77 01 468 491	77 01 464 736 77 01 468 492	 50 005 301
05.2000→ Reference	F9Q 82 00 199 281	790 82 00 243 154	82 00 279 953	82 00 741 635	50 005 254 NEW
Laguna I 1.6i 16V					62
05.1998→02.2001 Reference	K4M 77 00 105 176 82 00 428 447	720, 724 77 00 105 378 82 00 582 675	77 00 274 330	82 00 146 297	50 005 170 NEW
05.1998→02.2001 Reference	K4M 77 01 693 576	720			50 005 846





Laguna I 1.8i

63

01.1994→02.2001	F3P	670, 720, 724						
Reference	77 00 859 570 77 01 611 364	77 00 864 218	77 00 864 220	77 01 590 269		50 005 865		
12.1993→02.2001	F3P	670, 710, 720, 724						
Reference	77 01 462 809 77 01 465 816 77 01 473 365	77 01 463 111 77 01 466 578	77 01 463 397 77 01 468 491	77 01 464 736 77 01 468 492		50 005 301		

Laguna I 1.8i 16V

64

05.1998→02.2001	F4P	760						
Reference	77 01 693 588	82 00 194 613				50 005 862		
05.1998→02.2001	F4P	760						
Reference	77 01 693 588	82 00 194 613	82 00 243 153	82 00 279 956		50 005 861		



Laguna I 1.9 dCi

65

09.1999→03.2001	F9Q	718						
Reference	77 01 669 290 82 00 279 948 →11.2000	77 01 693 577	82 00 194 608	82 00 222 704		50 005 858		
09.1999→03.2001	F9Q	718						
Reference	82 00 199 281 12.2000→	82 00 243 154	82 00 279 953	82 00 741 635		50 005 254 <small>NEW</small>		
09.1999→03.2001	F9Q	718						
Reference	77 00 111 675	77 01 472 182				50 005 756		

Laguna I 1.9 dTi

66

10.1997→02.2001	F9Q	710, 716, 717						
Reference	77 01 669 290 82 00 279 948 →11.2000	77 01 693 577	82 00 194 608	82 00 222 704		50 005 858		
10.1997→02.2001	F9Q	716, 734						
Reference	77 01 462 809 77 01 465 816 77 01 473 365	77 01 463 111 77 01 466 578	77 01 463 397 77 01 468 491	77 01 464 736 77 01 468 492		50 005 301		
10.1997→02.2001	F9Q	710, 716, 717						
Reference	82 00 199 281 12.2000→	82 00 243 154	82 00 279 953	82 00 741 635		50 005 254 <small>NEW</small>		

Laguna I 2.0i

67

01.1994→02.2001	F3R	722, 723						
Reference	77 00 859 570 77 01 611 364	77 00 864 218	77 00 864 220	77 01 590 269		50 005 865		



01.1994→03.2001	F3R	722, 723, 750				
Reference	77 01 462 809 77 01 465 816 77 01 473 365	77 01 463 111 77 01 466 578	77 01 463 397 77 01 468 491	77 01 464 736 77 01 468 492		50 005 301
Laguna I 2.0i 16V						68
09.1999→02.2001	F4R	780				
Reference	77 01 693 588	82 00 194 613				50 005 862
03.1995→02.2001	N7Q	700, 704				
Reference	74 38 610 006					50 005 107
09.1999→02.2001	F4R	780				
Reference	77 00 111 675	77 01 472 182				50 005 756
09.1999→02.2001	F4R	780				
Reference	77 01 693 588	82 00 194 613	82 00 243 153	82 00 279 956		50 005 861
Laguna I 2.2 D 12V						69
01.1994→02.2001	G8T	752, 794				
Reference	77 00 106 101 82 00 042 514	77 00 107 845	77 00 111 841	77 00 861 627		50 005 336
01.1994→04.1998	G8T	706, 790				
Reference	77 00 859 931	77 00 871 801	77 01 467 622			50 005 337
Laguna I 2.2 TD 12V						70
02.1996→02.2001	G8T	760				
Reference	77 00 106 101 82 00 042 514	77 00 107 845	77 00 111 841	77 00 861 627		50 005 336
Laguna I 3.0i						71
06.1994→02.2001	Z7X	765				
						50 005 223
Laguna II 1.6i 16V						72
03.2001→	K4M	710, 714				
Reference	82 00 101 970 K4M 710: 07.2001→	82 00 227 686				50 005 849
03.2001→	K4M	710				
Reference	77 00 105 176 82 00 428 447	77 00 105 378 82 00 582 675	77 00 274 330	82 00 146 297		50 005 170 NEW













R



03.2001→ Reference	K4M 77 01 693 576	710		50 005 846
Laguna II 1.8i 16V 73				
03.2001→ Reference 	F4P 77 01 693 588 F4P 774: →01.2007	770 , 771, 772, 774, 775 82 00 194 613		50 005 862
03.2001→ Reference	F4P 77 00 111 675	770 , 771, 773 , 774, 775 77 01 472 182		50 005 756
03.2001→ Reference 	F4P 77 01 693 588 F4P 774: →01.2007	770 , 771, 772, 774, 775 82 00 194 613 82 00 243 153 82 00 279 956		50 005 861
Laguna II 1.9 dCi 74				
03.2001→ Reference 	F9Q 77 01 669 290 82 00 279 948 →09.2000	752 77 01 693 577 82 00 194 608 82 00 222 704		50 005 858
03.2001→ Reference 	F9Q 82 00 199 281 F9Q 750, F9Q 752: 10.2000→ F9Q 650, F9Q 664: →08.2007	650, 664, 750, 752, 754 82 00 243 154 82 00 279 953 82 00 741 635		50 005 254 NEW
03.2001→ Reference	F9Q 77 00 111 675	750, 752, 754, 756 77 01 472 182		50 005 756
Laguna II 2.0i 16V 75				
09.2001→ Reference	F4R 77 01 669 290 82 00 279 948	714, 715 77 01 693 577 82 00 194 608 82 00 222 704		50 005 858
03.2001→ 03.2001→ Reference 	F4R F5R 77 01 693 588 F4R 712: →01.2007	712, 713 700 82 00 194 613		50 005 862
03.2001→ 03.2001→ Reference	F4R F5R 77 00 111 675	712, 713, 714, 715 700 77 01 472 182		50 005 756
03.2001→ 03.2001→ Reference 	F4R F5R 77 01 693 588 F4R 712: →01.2007	712, 713 700 82 00 194 613 82 00 243 153 82 00 279 956		50 005 861
Laguna II 2.0i Turbo 16V 76				
04.2004→ Reference	F4R 77 01 669 290 82 00 279 948	786, 787 77 01 693 577 82 00 194 608 82 00 222 704		50 005 858

R





						
07.2002→ Reference	F4R 77 01 693 588	764, 765 82 00 194 613				50 005 862
07.2002→ Reference	F4R 77 00 111 675	764, 787 77 01 472 182				50 005 756
07.2002→ Reference	F4R 77 01 693 588	764, 765 82 00 194 613	82 00 243 153	82 00 279 956		50 005 861
Laguna II 2.2 dCi 16V						77
03.2001→ Reference	G9T 77 01 472 625	702 77 01 474 190	82 00 129 206			50 005 794
Laguna Grandtour 1.6i 16V						78
05.1998→ Reference	K4M 77 00 105 176 82 00 428 447	710, 720, 724 77 00 105 378 82 00 582 675	77 00 274 330	82 00 146 297		50 005 170 NEW
Laguna Grandtour 1.8i						79
09.1995→02.2001 Reference	F3P 77 01 462 809 77 01 465 816 77 01 473 365	670, 724 77 01 463 111 77 01 466 578	77 01 463 397 77 01 468 491	77 01 464 736 77 01 468 492		50 005 301
Laguna Grandtour 1.8i 16V						80
03.2001→ Reference	F4P 77 00 111 675	770, 771, 773, 774, 775 77 01 472 182				50 005 756
Laguna Grandtour 1.9 dTi						81
10.1997→02.2001 Reference	F9Q 77 01 462 809 77 01 465 816 77 01 473 365	716 77 01 463 111 77 01 466 578	77 01 463 397 77 01 468 491	77 01 464 736 77 01 468 492		50 005 301
Laguna Grandtour 1.9 dCi						82
09.1999→ Reference	F9Q 77 00 111 675	718, 752, 754 77 01 472 182				50 005 756
Laguna Grandtour 2.0i						83
09.1995→02.2001 Reference	F3R 77 01 462 809 77 01 465 816 77 01 473 365	722, 723, 768, 769 77 01 463 111 77 01 466 578	77 01 463 397 77 01 468 491	77 01 464 736 77 01 468 492		50 005 301



Laguna Grandtour 2.0i 16V

84

09.1995→02.2001	N7Q	700, 704							
Reference	74 38 610 006								50 005 107
09.1999→ 03.2001→	F4R F5R	712, 713, 714, 715, 780 700							50 005 756
Reference	77 00 111 675	77 01 472 182							

Laguna Grandtour 2.0i Turbo16V

85

07.2002→	F4R	764, 787							
Reference	77 00 111 675	77 01 472 182							50 005 756

Laguna Grandtour 2.2 D

86

11.1995→02.2001	G8T	752							
Reference	77 00 106 101 82 00 042 514	77 00 107 845	77 00 111 841	77 00 861 627					50 005 336
02.1995→10.1995	G8T	706							
Reference	77 00 859 931	77 00 871 801	77 01 467 622						50 005 337

Laguna Grandtour 2.2 D 12V

87

11.1995→02.2001	G8T	794							
Reference	77 00 106 101 82 00 042 514	77 00 107 845	77 00 111 841	77 00 861 627					50 005 336
06.1995→10.1995	G8T	790							
Reference	77 00 859 931	77 00 871 801	77 01 467 622						50 005 337

Laguna Grandtour 2.2 TD 12V

88

02.1996→02.2001	G8T	760							
Reference	77 00 106 101 82 00 042 514	77 00 107 845	77 00 111 841	77 00 861 627					50 005 336

Laguna Grandtour 2.2 dCi 16V

89

03.2001→	G9T	702							
Reference	77 01 472 625	77 01 474 190	82 00 129 206						50 005 794

Laguna Grandtour 3.0i

90

03.1996→02.2001	Z7X	765							
									50 005 223



Master 1.9 dCi

91

Reference	F9Q 664 82 00 199 281 82 00 243 154 82 00 279 953 82 00 741 635 →08.2007			50 005 254 NEW	
05.2000→ Reference	F9Q 772, 774 77 00 111 675 77 01 472 182				50 005 756

Master 2.5 TD

92

	8140.47.2700 8140.47.2721 8140.47.2785				50 005 621
--	--	---	--	--	------------

Master 2.8 dTi

93

05.1996→	8140.43.3700				50 005 621
----------	--------------	---	--	--	------------

Master P28 2.4 D

94

09.1980→11.1990 Reference	8140.61.2300 50 01 001 274 77 01 462 808 77 01 468 342				50 005 321
------------------------------	---	---	--	--	------------

Master T28 2.2 dCi 16V

95

05.2000→ Reference	G9T 722 77 01 472 625 77 01 474 190 82 00 129 206				50 005 794
-----------------------	--	---	--	--	------------

Master T28 2.2i

96

09.1980→09.1997 Reference	J7T 782, 788 77 01 465 513 f305273→				50 005 341
------------------------------	---	---	--	--	------------

Master T28 2.4 D

97

09.1980→09.1997 09.1980→09.1997 Reference	8140.61.2300 S8U 731 50 01 001 274 77 01 462 808 77 01 468 342				50 005 321
---	--	---	--	--	------------

Master T28 2.5 D

98

09.1980→09.1997 Reference	S8U 742 50 01 001 274 77 01 462 808 77 01 468 342				50 005 321
------------------------------	--	---	--	--	------------

R

**Master T30 2.4 D****99**

01.1985→09.1997 8140.61.2300
 08.1980→08.1989 S8U 731
 Reference 50 01 001 274 77 01 462 808 77 01 468 342



50 005 321

Master T30 2.5 D**100**

09.1980→09.1997 S8U 742
 Reference 50 01 001 274 77 01 462 808 77 01 468 342



50 005 321

Master T35 2.4 D**101**

08.1980→08.1989 8140.61.200
 08.1980→08.1989 8140.61.2300
 S8U 731
 Reference 50 01 001 274 77 01 462 808 77 01 468 342



50 005 321

Master T35 2.5 D**102**

09.1980→09.1997 S8U 742
 Reference 50 01 001 274 77 01 462 808 77 01 468 342



50 005 321

Master 1.9 dTi**103**

Reference F9Q 717, 770
 77 01 669 290 77 01 693 577 82 00 194 608 82 00 222 704
 82 00 279 948
 →11.2000



50 005 858

01.2000→ F9Q 770
 Reference 77 01 462 809 77 01 463 111 77 01 463 397 77 01 464 736
 77 01 465 816 77 01 466 578 77 01 468 491 77 01 468 492
 77 01 473 365



50 005 301

01.2000→ F9Q 770
 Reference 82 00 199 281 82 00 243 154 82 00 279 953 82 00 741 635
 12.2000→

50 005 254
NEW

01.2000→ F9Q 770
 Reference 77 00 111 675 77 01 472 182



50 005 756

Master 2.5 dCi 16V**104**

05.2000→ G9U 630, 720
 Reference 77 01 472 625 77 01 474 190 82 00 129 206



50 005 794

R



Mégane 1.4i

105

01.1996→09.2003 E7J 624, 626, 764
 Reference 77 01 669 300 77 01 693 575
 E7J 626, E7J 764: →02.2002

50 005 859

01.1996→09.2003 E7J 624, 626, 764
 Reference 77 00 866 518 82 00 146 301

50 005 040
 NEW

Mégane 1.4i 16V

106

06.1998→09.2003 K4J 714, 750
 Reference 82 00 101 970 82 00 227 686
 07.2001→

50 005 849

06.1998→09.2003 K4J 700, 714, 750
 Reference 77 00 105 176 77 00 105 378 77 00 274 330 82 00 146 297
 82 00 428 447 82 00 582 675

50 005 170
 NEW

06.1998→09.2003 K4J 714, 750
 Reference 77 01 693 576
 →06.2001

50 005 846

Mégane 1.6i

107

01.1996→03.1999 K7M 702, 703, 720, 790
 Reference 77 00 861 686

50 005 340

01.1996→09.2003 K7M 702, 703, 704, 720, 790
 Reference 77 01 669 300 77 01 693 575

50 005 859
R

Mégane 1.6i 16V

108

06.1998→09.2003 K4M 700, 701, 706, 708, 709, 712
 Reference 82 00 101 970 82 00 227 686
 K4M 700, K4M 701, K4M 708, K4M 712: 07.2001→
 K4M 706: 12.2001→

50 005 849

05.2000→09.2003 K4M 708
 Reference 82 00 266 947

50 005 934
 NEW

06.1998→ K4M 700, 701, 704, 708, 720
 Reference 77 00 105 176 77 00 105 378 77 00 274 330 82 00 146 297
 82 00 428 447 82 00 582 675

50 005 170
 NEW



06.1998→09.2003 K4M 700, 701, 704, 706, 708, 712
 Reference 77 01 693 576
 K4M 700, K4M 701, K4M 708, K4M 712: →06.2001
 K4M 706: →11.2001

50 005 846





Mégane 1.8i 16V

109

03.1999→09.2003	F4P	720, 722					50 005 862	
Reference	77 01 693 588	82 00 194 613						
03.1999→09.2003	F4P	720, 722					50 005 861	
Reference	77 01 693 588	82 00 194 613	82 00 243 153	82 00 279 956				
	F4P 722: →01.2007							



Mégane 1.9 D

110

09.1996→09.2003	F8Q	622, 624, 790					50 005 858	
Reference	77 01 669 290	77 01 693 577	82 00 194 608	82 00 222 704				
	82 00 279 948							
01.1996→02.1999	F8Q	620					50 005 865	
Reference	77 00 859 570	77 00 864 218	77 00 864 220	77 01 590 269				
	77 01 611 364							
01.1996→02.1999	F8Q	620						50 005 301
Reference	77 01 462 809	77 01 463 111	77 01 463 397	77 01 464 736				
	77 01 465 816	77 01 466 578	77 01 468 491	77 01 468 492				
	77 01 473 365							



Mégane 1.9 dCi

111

06.1997→09.2003	F9Q	732, 740					50 005 858	
Reference	77 01 669 290	77 01 693 577	82 00 194 608	82 00 222 704				
	82 00 279 948							
	→11.2000							
06.1997→09.2003	F9Q	732, 733, 738, 740, 744					50 005 254	
Reference	82 00 199 281	82 00 243 154	82 00 279 953	82 00 741 635			NEW	
	F9Q 732, F9Q 740: 12.2000→							
	F9Q 733, F9Q 738: →08.2007							
06.1997→09.2003	F9Q	732, 733, 740						50 005 756
Reference	77 00 111 675	77 01 472 182						

Mégane 1.9 dTi

112

06.1997→09.2003	F9Q	731, 736					50 005 858	
Reference	77 01 669 290	77 01 693 577	82 00 194 608	82 00 222 704				
	82 00 279 948							
	→11.2000							
06.1997→09.2003	F9Q	730					50 005 865	
Reference	77 00 859 570	77 00 864 218	77 00 864 220	77 01 590 269				
	77 01 611 364							
06.1997→02.1999	F9Q	734						50 005 301
Reference	77 01 462 809	77 01 463 111	77 01 463 397	77 01 464 736				
	77 01 465 816	77 01 466 578	77 01 468 491	77 01 468 492				
	77 01 473 365							

R



06.1997→09.2003	F9Q	731, 736				
Reference	82 00 199 281	82 00 243 154	82 00 279 953	82 00 741 635		50 005 254 <small>NEW</small>
	12.2000→					
06.1997→09.2003	F9Q	730, 731, 736				50 005 756
Reference	77 00 111 675	77 01 472 182				
Mégane 1.9 TD						113
01.1996→02.1999	F8Q	786				50 005 858
Reference	77 01 669 290 82 00 279 948	77 01 693 577	82 00 194 608	82 00 222 704		
01.1996→02.1999	F8Q	784				50 005 865
Reference	77 00 859 570 77 01 611 364	77 00 864 218	77 00 864 220	77 01 590 269		
01.1996→02.1999	F8Q	784				50 005 301
Reference	77 01 462 809 77 01 465 816 77 01 473 365	77 01 463 111 77 01 466 578	77 01 463 397 77 01 468 491	77 01 464 736 77 01 468 492		
Mégane 2.0i						114
03.1997→	F3R	797, 798				50 005 858
Reference	77 01 669 290 82 00 279 948	77 01 693 577	82 00 194 608	82 00 222 704		
01.1996→	F3R	750, 751				50 005 301
Reference	77 01 462 809 77 01 465 816 77 01 473 365	77 01 463 111 77 01 466 578	77 01 463 397 77 01 468 491	77 01 464 736 77 01 468 492		
Mégane 2.0i 16V						115
05.1997→09.2003	F7R	714				50 005 858
Reference	77 01 669 290 82 00 279 948	77 01 693 577	82 00 194 608	82 00 222 704		
01.1996→04.1997	F7R	710				50 005 301
Reference	77 01 462 809 77 01 465 816 77 01 473 365	77 01 463 111 77 01 466 578	77 01 463 397 77 01 468 491	77 01 464 736 77 01 468 492		
05.2000→09.2003	F4R	740, 746				50 005 862
03.1999→09.2003	F5R	740				
Reference	77 01 693 588	82 00 194 613				
05.2000→09.2003	F4R	740, 746				50 005 861
03.1999→09.2003	F5R	740				
Reference	77 01 693 588	82 00 194 613	82 00 243 153	82 00 279 956		
	F4R 746: →01.2007					
Mégane Classic 1.4i						116
09.1996→	E7J	626, 764				50 005 040 <small>NEW</small>
Reference	77 00 866 518	82 00 146 301				

R

**Mégane Classic 1.4i 16V****117**

	K4J	714, 750			
Reference	77 00 105 176 82 00 428 447	77 00 105 378 82 00 582 675	77 00 274 330	82 00 146 297	

50 005 170
NEW**Mégane Classic 1.6i****118**

09.1996→03.1999	K7M	702, 720, 790			
Reference	77 00 861 686				

**50 005 340****Mégane Classic 1.6i 16V****119**

	K4M	700, 701, 704, 708			
Reference	77 00 105 176 82 00 428 447	77 00 105 378 82 00 582 675	77 00 274 330	82 00 146 297	

50 005 170
NEW

	K4M	708			
Reference	82 00 266 947				

50 005 934
NEW**Mégane Classic 1.9 D****120**

09.1996→	F8Q	620			
Reference	77 01 462 809 77 01 465 816 77 01 473 365	77 01 463 111 77 01 466 578	77 01 463 397 77 01 468 491	77 01 464 736 77 01 468 492	

**50 005 301****Mégane Classic 1.9 TD****121**

09.1996→	F8Q	784			
Reference	77 01 462 809 77 01 465 816 77 01 473 365	77 01 463 111 77 01 466 578	77 01 463 397 77 01 468 491	77 01 464 736 77 01 468 492	

**50 005 301****Mégane Classic 1.9 dTi****122**

03.1997→02.2001	F9Q	734			
Reference	77 01 462 809 77 01 465 816 77 01 473 365	77 01 463 111 77 01 466 578	77 01 463 397 77 01 468 491	77 01 464 736 77 01 468 492	

**50 005 301**

03.1997→02.2001	F9Q	730, 731, 736			
Reference	77 00 111 675	77 01 472 182			

**50 005 756****Mégane Classic 1.9 dCi****123**

02.2001→	F9Q	732, 733			
Reference	77 00 111 675	77 01 472 182			

**50 005 756****Mégane Classic 2.0i****124**

03.1996→	F3R	750, 751			
Reference	77 01 462 809 77 01 465 816 77 01 473 365	77 01 463 111 77 01 466 578	77 01 463 397 77 01 468 491	77 01 464 736 77 01 468 492	

**50 005 301****Mégane Grandtour 1.4i****125**

	E7J	626, 764			
Reference	77 00 866 518	82 00 146 301			

50 005 040
NEW



Mégane Grandtour 1.4i 16V

126

Reference	K4J	714, 750			
	77 00 105 176	77 00 105 378	77 00 274 330	82 00 146 297	
	82 00 428 447	82 00 582 675			

50 005 170
NEW

Mégane Grandtour 1.6i

127

Reference	K7M	702, 720, 790			
	77 00 861 686				

50 005 340

Mégane Grandtour 1.6i 16V

128

03.1999→	K4M	700, 701, 704, 708			
Reference	77 00 105 176	77 00 105 378	77 00 274 330	82 00 146 297	
	82 00 428 447	82 00 582 675			

50 005 170
NEW

03.1999→	K4M	708			
Reference	82 00 266 947				

50 005 934
NEW

Mégane Grandtour 1.9 D

129

Reference	F8Q	620			
	77 01 462 809	77 01 463 111	77 01 463 397	77 01 464 736	
	77 01 465 816	77 01 466 578	77 01 468 491	77 01 468 492	
	77 01 473 365				

50 005 301

Mégane Grandtour 1.9 TD

130

Reference	F8Q	784			
	77 01 462 809	77 01 463 111	77 01 463 397	77 01 464 736	
	77 01 465 816	77 01 466 578	77 01 468 491	77 01 468 492	
	77 01 473 365				

50 005 301

Mégane Grandtour 1.9 dTi

131

Reference	F9Q	734			
	77 01 462 809	77 01 463 111	77 01 463 397	77 01 464 736	
	77 01 465 816	77 01 466 578	77 01 468 491	77 01 468 492	
	77 01 473 365				

50 005 301

Reference	F9Q	730, 731, 736			
	77 00 111 675	77 01 472 182			

50 005 756

Mégane Grandtour 1.9 dCi

132

Reference	F9Q	732, 733			
	77 00 111 675	77 01 472 182			

50 005 756

Mégane Grandtour 2.0i

133

Reference	F3R	750, 751			
	77 01 462 809	77 01 463 111	77 01 463 397	77 01 464 736	
	77 01 465 816	77 01 466 578	77 01 468 491	77 01 468 492	
	77 01 473 365				

50 005 301











Mégane II 1.4i 16V

134

11.2002→	K4J	730, 732, 740			
Reference	82 00 101 970	82 00 227 686			
	K4J 740: →09.2006				

50 005 849
R





					
11.2002→	K4J	730, 732			
Reference	77 00 105 176 82 00 428 447	77 00 105 378 82 00 582 675	77 00 274 330	82 00 146 297	50 005 170 <small>NEW</small>
Mégane II 1.5 dCi					135
11.2002→	K9K	722, 729			
Reference	82 00 101 970 K9K 722: →02.2006 K9K 729: →05.2007	82 00 227 686			50 005 849
11.2002→	K9K	728, 729			
Reference	77 01 475 995	77 01 478 031			50 005 027 <small>NEW</small>
11.2002→	K9K	722, 724			
Reference	77 01 473 327	77 01 476 496			50 005 171 <small>NEW</small>
Mégane II 1.6i 16V					136
11.2002→	K4M	760, 761, 764			
Reference	82 00 101 970	82 00 227 686			50 005 849
11.2002→	K4M	760, 761			
Reference	77 00 105 176 82 00 428 447	77 00 105 378 82 00 582 675	77 00 274 330	82 00 146 297	50 005 170 <small>NEW</small>
Mégane II 1.9 dCi					137
11.2002→	F9Q	800			
Reference	77 01 474 435				50 005 795
11.2002→	F9Q	800, 808			
Reference	82 00 199 281 →08.2007	82 00 243 154	82 00 279 953	82 00 741 635	50 005 254 <small>NEW</small>
Mégane II 2.0i 16V					138
11.2002→	F4R	770, 771, 776			
Reference	77 01 669 290 82 00 279 948	77 01 693 577	82 00 194 608	82 00 222 704	50 005 858
11.2002→	F4R	770, 771, 776			
Reference	77 00 111 675	77 01 472 182			50 005 756
Mégane II 2.0i Turbo 16V					139
05.2004→	F4R	764			
Reference	77 00 111 675	77 01 472 182			50 005 756

R



Mégane II 2.0i 16V Sport

140

03.2003→	F4R	774						
Reference	77 01 669 290 82 00 279 948	77 01 693 577	82 00 194 608	82 00 222 704		50 005 858		
03.2003→	F4R	774						
Reference	77 00 111 675	77 01 472 182					50 005 756	

Modus 1.2i 16V

141

09.2004→	D4F	740						
Reference	77 00 864 596	82 00 037 686	82 00 088 660	82 00 088 663			50 005 335	
09.2004→	D4F	740						
Reference	82 00 266 947						50 005 934	NEW



Modus 1.4i 16V

142

06.2004→	K4J	770						
Reference	82 00 101 970 →09.2006	82 00 227 686				50 005 849		
06.2004→	K4J	770, 780						
Reference	77 00 105 176 82 00 428 447	77 00 105 378 82 00 582 675	77 00 274 330	82 00 146 297			50 005 170	NEW

Modus 1.5 dCi

143

09.2004→	K9K	750, 752						
Reference	82 00 101 970 →02.2006	82 00 227 686				50 005 849		
05.2005→	K9K	764, 766, 768						
Reference	77 01 475 995	77 01 478 031					50 005 027	NEW
09.2004→	K9K	724, 750, 752						
Reference	77 01 473 327	77 01 476 496					50 005 171	NEW

Modus 1.6i 16V

144

09.2004→	K4M	790, 791, 794, 800, 801						
Reference	82 00 101 970 →09.2006	82 00 227 686				50 005 849		
09.2004→	K4M	790, 800, 801						
Reference	77 00 105 176 82 00 428 447	77 00 105 378 82 00 582 675	77 00 274 330	82 00 146 297			50 005 170	NEW

R

**R 4 0.85****145**

10.1982→12.1993 B1B 705, 707
Reference 77 01 458 594



50 005 855

R 4 1.0**146**

10.1986→12.1993 C1C 708
Reference 77 01 508 491



50 005 864

12.1985→06.1993 810 726
Reference 77 01 457 671 77 01 505 397



50 005 311

R 4 1.1**147**

10.1975→12.1993 688 711, 712
10.1976→12.1993 C1E 714, 718, 719
Reference 77 01 508 491



50 005 864

10.1978→12.1993 688.12
10.1975→12.1993 688 712
10.1976→12.1993 C1E 718, 719
Reference 77 01 457 671 77 01 505 397
688.12: →12.1985



50 005 311

R 5 1.0**148**

10.1984→12.1996 C1C 700
Reference 77 01 588 187



50 005 856

01.1972→08.1980 689 710
Reference 77 01 457 671 77 01 505 397



50 005 311

R 5 1.1**149**

10.1984→12.1996 C1E 750, 752, 754, 756, 760
Reference 77 01 588 187



50 005 856

09.1980→12.1985 688 713
Reference 77 01 457 671 77 01 505 397
→79999



50 005 311



09.1980→12.1985 Reference 	688 713 77 02 118 708 77 02 120 972 80000→			50 005 312
R 5 1.2				150
10.1984→10.1997 Reference 	C1G 700, 720 77 01 462 145 77 01 462 491 77 01 463 377 77 01 466 419 89 82 775 051 ohne Gegengehäuse/without backhousing/sans demi-corps/sin remate/без заднего корпуса			50 005 302
10.1984→10.1997 Reference 	C1G 700, 720 77 01 462 145 77 01 462 491 77 01 463 377 77 01 466 419 mit Gegengehäuse/with backhousing/avec demi-corps/con remate/с задним корпусом			50 005 326
R 5 1.3				151
09.1975→09.1984 Reference 	810 719, 725, 726, 729 77 01 457 671 77 01 505 397 810 729: →19000			50 005 311
09.1976→09.1984 Reference 	810 729 77 02 118 708 77 02 120 972 19001→			50 005 312
R 5 1.4				152
10.1984→12.1996 10.1984→12.1996 10.1984→02.1988 Reference	C1J 768, 780 C2J 700, 717, 718, 766, 767, 780, 781, 788, 789, 798 C3J 700, 702 77 01 588 187		50 005 856	
10.1984→12.1996 Reference 	C2J 717, 720 77 01 462 145 77 01 462 491 77 01 463 377 77 01 466 419 89 82 775 051 ohne Gegengehäuse/without backhousing/sans demi-corps/sin remate/без заднего корпуса			50 005 302
10.1980→03.1985 Reference	C2J 713 77 01 457 671 77 01 505 397			50 005 311
10.1984→12.1996 Reference 	C2J 717, 720 77 01 462 145 77 01 462 491 77 01 463 377 77 01 466 419 mit Gegengehäuse/with backhousing/avec demi-corps/con remate/с задним корпусом			50 005 326

R



08.1982→09.1984 Reference	847 712 77 02 118 708 77 02 120 972			50 005 312
R 5 1.4 Turbo				153
10.1984→12.1996 Reference	C1J 782, 784, 788 77 01 588 187			50 005 856
R 5 1.4 Alpine				154
03.1976→09.1981 Reference	840.725 77 01 457 671 77 01 505 397			50 005 311
R 5 1.4i				155
10.1985→12.1996 Reference	C3J 760 77 01 588 187			50 005 856
R 5 1.4i Turbo				156
06.1980→01.1985 09.1981→ Reference	840 730 C6J 726 77 01 457 671 77 01 505 397			50 005 311
R 5 1.4i Alpine Turbo				157
12.1979→12.1985 Reference	840 730 77 01 457 671 77 01 505 397			50 005 311
R 5 1.6 D				158
10.1984→12.1996 Reference	F8M 720 77 00 859 570 77 00 864 218 77 00 864 220 77 01 590 269 77 01 611 364			50 005 865
R 5 1.7				159
06.1987→12.1996 Reference	F2N 740, 742 77 00 859 570 77 00 864 218 77 00 864 220 77 01 590 269 77 01 611 364			50 005 865
06.1987→12.1996 Reference	F2N 710 77 01 462 809 77 01 463 111 77 01 463 397 77 01 464 736 77 01 465 816 77 01 466 578 77 01 468 491 77 01 468 492 77 01 473 365			50 005 301

R



R 5 1.7i				160
10.1986→12.1996 Reference	F3N 77 00 859 570 77 01 611 364	716, 717 77 00 864 218 77 00 864 220 77 01 590 269		50 005 865
10.1986→12.1996 Reference	F3N 77 01 462 809 77 01 465 816 77 01 473 365	718 77 01 463 111 77 01 466 578 77 01 463 397 77 01 468 491 77 01 464 736 77 01 468 492		50 005 301
R 6 1.1				161
09.1971→08.1980 1976 → Reference	688.10 688.12 77 01 457 671 688.12: →12.1985	77 01 505 397		50 005 311
R 9 1.1				162
09.1981→10.1987 Reference	C1E 77 01 462 145 89 82 775 051 ohne Gegengehäuse/without backhousing/sans demi-corps/sin remate/без заднего корпуса	715, 720 77 01 462 491 77 01 463 377 77 01 466 419		50 005 302
09.1981→10.1987 Reference	C1E 77 01 462 145 mit Gegengehäuse/with backhousing/avec demi-corps/con remate/с задним корпусом	715, 720 77 01 462 491 77 01 463 377 77 01 466 419		50 005 326
R 9 1.2				163
09.1985→03.1991 Reference	C1G 77 01 462 145 89 82 775 051 ohne Gegengehäuse/without backhousing/sans demi-corps/sin remate/без заднего корпуса	700, 710, 720 77 01 462 491 77 01 463 377 77 01 466 419		50 005 302
09.1985→03.1991 Reference	C1G 77 01 462 145 mit Gegengehäuse/with backhousing/avec demi-corps/con remate/с задним корпусом	700, 710, 720 77 01 462 491 77 01 463 377 77 01 466 419		50 005 326
R 9 1.4				164
09.1981→03.1991 09.1981→12.1995 Reference	C1J C2J 77 01 462 145 89 82 775 051 ohne Gegengehäuse/without backhousing/sans demi-corps/sin remate/без заднего корпуса	768, 792, 796 717, 718, 720, 730, 756, 766, 767, 768, 792, 794, 796 77 01 462 491 77 01 463 377 77 01 466 419		50 005 302
09.1981→03.1991 09.1981→12.1995 Reference	C1J C2J 77 01 462 145 mit Gegengehäuse/with backhousing/avec demi-corps/con remate/с задним корпусом	768, 792, 796 717, 718, 720, 730, 756, 766, 767, 768, 792, 794, 796 77 01 462 491 77 01 463 377 77 01 466 419		50 005 326

R



R 9 1.4 Turbo

165

09.1984→03.1991	C1J	760, 764						
Reference	77 01 462 145	77 01 462 491	77 01 463 377	77 01 466 419				50 005 302
	89 82 775 051							
	ohne Gegengehäuse/without backhousing/sans demi-corps/sin remate/без заднего корпуса							

09.1984→03.1991	C1J	760, 764						
Reference	77 01 462 145	77 01 462 491	77 01 463 377	77 01 466 419				50 005 326
	mit Gegengehäuse/with backhousing/avec demi-corps/con remate/c задним корпусом							

R 9 1.6 D

166

09.1982→03.1991	F8M	700						
Reference	77 01 462 809	77 01 463 111	77 01 463 397	77 01 464 736				50 005 301
	77 01 465 816	77 01 466 578	77 01 468 491	77 01 468 492				
	77 01 473 365							

R 9 1.7

167

09.1984→03.1991	F2N	700, 704, 708, 710, 712, 730						
Reference	77 01 462 809	77 01 463 111	77 01 463 397	77 01 464 736				50 005 301
	77 01 465 816	77 01 466 578	77 01 468 491	77 01 468 492				
	77 01 473 365							

R 9 1.7i

168

09.1984→03.1991	F2N	732, 796, 797, 798						
09.1984→03.1991	F3N	718						
Reference	77 01 462 809	77 01 463 111	77 01 463 397	77 01 464 736				50 005 301
	77 01 465 816	77 01 466 578	77 01 468 491	77 01 468 492				
	77 01 473 365							

R 11 1.1

169

03.1983→03.1991	C1E	715, 720						
Reference	77 01 462 145	77 01 462 491	77 01 463 377	77 01 466 419				50 005 302
	89 82 775 051							
	ohne Gegengehäuse/without backhousing/sans demi-corps/sin remate/без заднего корпуса							

03.1983→03.1991	C1E	715, 720						
Reference	77 01 462 145	77 01 462 491	77 01 463 377	77 01 466 419				50 005 326
	mit Gegengehäuse/with backhousing/avec demi-corps/con remate/c задним корпусом							

R 11 1.2

170

10.1984→03.1991	C1G	700, 710						
Reference	77 01 462 145	77 01 462 491	77 01 463 377	77 01 466 419				50 005 302
	89 82 775 051							
	ohne Gegengehäuse/without backhousing/sans demi-corps/sin remate/без заднего корпуса							

10.1984→03.1991	C1G	700, 710						
Reference	77 01 462 145	77 01 462 491	77 01 463 377	77 01 466 419				50 005 326
	mit Gegengehäuse/with backhousing/avec demi-corps/con remate/c задним корпусом							



R 11 1.4					171
03.1983→03.1995	C2J	717, 718, 720, 730, 756, 766, 767, 768, 794			
Reference	77 01 462 145	77 01 462 491	77 01 463 377	77 01 466 419	50 005 302
	89 82 775 051	ohne Gegengehäuse/without backhousing/sans demi-corps/sin remate/без заднего корпуса			
03.1983→03.1995	C2J	717, 718, 720, 730, 756, 766, 767, 768, 794			
Reference	77 01 462 145	77 01 462 491	77 01 463 377	77 01 466 419	50 005 326
		mit Gegengehäuse/with backhousing/avec demi-corps/con remate/с задним корпусом			
R 11 1.4 Turbo					172
09.1983→03.1991	C1J	760, 764			
Reference	77 01 462 145	77 01 462 491	77 01 463 377	77 01 466 419	50 005 302
	89 82 775 051	ohne Gegengehäuse/without backhousing/sans demi-corps/sin remate/без заднего корпуса			
09.1983→03.1991	C1J	760, 764			
Reference	77 01 462 145	77 01 462 491	77 01 463 377	77 01 466 419	50 005 326
		mit Gegengehäuse/with backhousing/avec demi-corps/con remate/с задним корпусом			
R 11 1.6 D					173
03.1983→03.1991	F8M	700			
Reference	77 01 462 809	77 01 463 111	77 01 463 397	77 01 464 736	50 005 301
	77 01 465 816	77 01 466 578	77 01 468 491	77 01 468 492	
	77 01 473 365				
R 11 1.7					174
10.1983→03.1991	F2N	700, 704, 708, 710, 712, 730, 742			
Reference	77 01 462 809	77 01 463 111	77 01 463 397	77 01 464 736	50 005 301
	77 01 465 816	77 01 466 578	77 01 468 491	77 01 468 492	
	77 01 473 365				
R 11 1.7i					175
10.1983→03.1991	F2N	732, 796, 797, 798			
10.1984→03.1991	F3N	718			
Reference	77 01 462 809	77 01 463 111	77 01 463 397	77 01 464 736	50 005 301
	77 01 465 816	77 01 466 578	77 01 468 491	77 01 468 492	
	77 01 473 365				
R 18 2.0					176
11.1979→1985	829.01				
10.1981→02.1986	J6R	715, 716			
Reference	77 01 461 405	77 01 463 182			50 005 325
R 18 2.1 D					177
10.1980→02.1986	852	710			
10.1980→02.1986	J8S	711			
Reference	77 01 461 405	77 01 463 182			50 005 325
R 18 2.1 TD					178
04.1984→03.1992	J8S	174, 712			
Reference	77 01 461 405	77 01 463 182			50 005 325



R 19 1.2

179

09.1988→12.2001 C1G 730
Reference 77 01 588 187

50 005 856

R 19 1.2i

180

05.1992→12.2001 E7F 730
Reference 77 01 643 206 77 01 669 305 77 01 693 574 77 01 693 578

50 005 253
NEW

05.1992→12.2001 E7F 708
Reference 77 00 736 091 77 01 633 125

50 005 308

05.1992→12.2001 E7F 730
Reference 77 01 643 206

50 005 847

R 19 1.4

181

Reference E6J 700
77 00 736 091 77 01 633 125



50 005 308

09.1988→12.2001 C1J 742
09.1988→12.2001 C2J 772, 776
09.1988→12.2001 C3J 710
Reference 77 01 588 187

50 005 856

09.1988→12.2001 C1J 742
09.1988→12.2001 C2J 772
09.1988→12.2001 C3J 710
Reference 77 01 462 145 77 01 462 491 77 01 463 377 77 01 466 419
89 82 775 051
 ohne Gegengehäuse/without backhousing/sans demi-corps/sin remate/без заднего корпуса

50 005 302

09.1988→12.2001 C1J 742
09.1988→12.2001 C2J 772
09.1988→12.2001 C3J 710
Reference 77 01 462 145 77 01 462 491 77 01 463 377 77 01 466 419
 mit Gegengehäuse/with backhousing/avec demi-corps/con remate/с задним корпусом

50 005 326

R 19 1.4i

182

09.1988→12.2001 E6J 700, 701, 706
05.1990→12.2001 E7J 700, 706, 742, 745
Reference 77 01 643 206 77 01 669 305 77 01 693 574 77 01 693 578

50 005 253
NEW





09.1988→12.2001 09.1994→12.2001 Reference	E6J E7J	700 742				50 005 308
09.1988→04.1992 Reference	C3J	760				50 005 302
			77 01 462 145 77 01 462 491 77 01 463 377 77 01 466 419 89 82 775 051 ohne Gegengehäuse/without backhousing/sans demi-corps/sin remate/без заднего корпуса			
09.1988→04.1992 Reference	C3J	760				50 005 326
			77 01 462 145 77 01 462 491 77 01 463 377 77 01 466 419 mit Gegengehäuse/with backhousing/avec demi-corps/con remate/с задним корпусом			
09.1988→12.2001 05.1990→12.2001 Reference	E6J E7J	700, 701, 706 700, 706, 742, 745				50 005 847
			77 01 643 206			
R 19 1.7						183
09.1988→12.1995 Reference	F2N	720, 721, 722, 724, 726, 727, 728				50 005 865
			77 00 859 570 77 00 864 218 77 00 864 220 77 01 590 269 77 01 611 364			
09.1988→12.1995 Reference	F2N	720, 724, 726, 728				50 005 301
			77 01 462 809 77 01 463 111 77 01 463 397 77 01 464 736 77 01 465 816 77 01 466 578 77 01 468 491 77 01 468 492 77 01 473 365			
R 19 1.7i						184
09.1988→12.1995 Reference	F3N	740, 741, 742, 743, 746				50 005 865
			77 00 859 570 77 00 864 218 77 00 864 220 77 01 590 269 77 01 611 364			
09.1988→12.1995 Reference	F3N	718, 740, 741, 743, 746				50 005 301
			77 01 462 809 77 01 463 111 77 01 463 397 77 01 464 736 77 01 465 816 77 01 466 578 77 01 468 491 77 01 468 492 77 01 473 365			
R 19 1.8i						185
04.1992→12.1995 Reference	F3P	682, 700, 704, 705, 706, 707, 708, 760, 765				50 005 865
			77 00 859 570 77 00 864 218 77 00 864 220 77 01 590 269 77 01 611 364			
04.1992→12.1995 Reference	F3P	682, 700, 704, 705, 706, 707, 708, 710, 754, 760, 765				50 005 301
			77 01 462 809 77 01 463 111 77 01 463 397 77 01 464 736 77 01 465 816 77 01 466 578 77 01 468 491 77 01 468 492 77 01 473 365			

R





R 19 1.8i 16V

186

06.1989→12.1995	F7P	700, 704					
Reference	77 00 859 570 77 01 611 364	77 00 864 218	77 00 864 220	77 01 590 269		50 005 865	
	F7P 704: →05.1993						
06.1989→12.1995	F7P	704					
Reference	77 01 462 809 77 01 465 816 77 01 473 365	77 01 463 111 77 01 466 578	77 01 463 397 77 01 468 491	77 01 464 736 77 01 468 492		50 005 301	

R 19 1.9 D

187

09.1988→12.2001	F8Q	706, 742					
Reference	77 00 859 570 77 01 611 364	77 00 864 218	77 00 864 220	77 01 590 269		50 005 865	
09.1988→12.2001	F8Q	706, 742, 764					
Reference	77 01 462 809 77 01 465 816 77 01 473 365	77 01 463 111 77 01 466 578	77 01 463 397 77 01 468 491	77 01 464 736 77 01 468 492		50 005 301	

R 19 1.9 TD

188

09.1990→12.2001	F8Q	610, 740, 744, 768					
Reference	77 00 859 570 77 01 611 364	77 00 864 218	77 00 864 220	77 01 590 269		50 005 865	
09.1990→12.2001	F8Q	610, 740, 744, 784					
Reference	77 01 462 809 77 01 465 816 77 01 473 365	77 01 463 111 77 01 466 578	77 01 463 397 77 01 468 491	77 01 464 736 77 01 468 492		50 005 301	



R 20 2.0

189

10.1977→12.1983	829.710						
Reference	77 01 461 405	77 01 463 182				50 005 325	

R 20 2.1 D

190

12.1979→12.1983	852	700					
Reference	77 01 461 336					50 005 323	
12.1979→12.1983	852	700					
Reference	77 01 461 405	77 01 463 182				50 005 325	

R 20 2.1 TD

191

10.1982→12.1983	J8S	240					
Reference	77 01 461 336					50 005 323	

**RENAULT****R 21 1.4****192**

06.1988→03.1993 Reference	C2J 770 77 01 588 187				50 005 856	
06.1988→03.1993 Reference	C2J 717 77 01 462 145 77 01 462 491 77 01 463 377 77 01 466 419 89 82 775 051 ohne Gegengehäuse/without backhousing/sans demi-corps/sin remate/без заднего корпуса					50 005 302
06.1988→03.1993 Reference	C2J 717 77 01 462 145 77 01 462 491 77 01 463 377 77 01 466 419 mit Gegengehäuse/with backhousing/avec demi-corps/con remate/с задним корпусом					50 005 326

R 21 1.7**193**

03.1986→12.1994 Reference	F2N 710, 711, 750, 752, 786 77 00 859 570 77 00 864 218 77 00 864 220 77 01 590 269 77 01 611 364				50 005 865	
03.1986→12.1995 Reference	F2N 710, 712, 716, 720, 750, 752 77 01 462 809 77 01 463 111 77 01 463 397 77 01 464 736 77 01 465 816 77 01 466 578 77 01 468 491 77 01 468 492 77 01 473 365					50 005 301

R 21 1.7i**194**

01.1989→03.1993 03.1986→03.1992 Reference	F2N 754 F2R 702 77 00 859 570 77 00 864 218 77 00 864 220 77 01 590 269 77 01 611 364				50 005 865	
01.1989→12.1994 03.1986→12.1995 Reference	F2N 754, 758 F3N 718, 723, 726, 740 77 01 462 809 77 01 463 111 77 01 463 397 77 01 464 736 77 01 465 816 77 01 466 578 77 01 468 491 77 01 468 492 77 01 473 365					50 005 301

R 21 1.9 TD**195**

05.1989→12.1994 Reference	F8Q 784 77 01 462 809 77 01 463 111 77 01 463 397 77 01 464 736 77 01 465 816 77 01 466 578 77 01 468 491 77 01 468 492 77 01 473 365					50 005 301
------------------------------	---	--	--	--	--	------------

R 21 2.0**196**

03.1986→03.1993 Reference	J6R 758, 759, 792, 793 77 01 465 119 77 01 465 761 77 01 585 084 79 46 004 571				50 005 857	
------------------------------	--	--	--	--	------------	--

R



R 21 2.0i

197

10.1986→12.1995 Reference 	J7R 77 01 465 513 J7R 751: f197768→	746, 747 , 751			50 005 341
10.1986→12.1995 Reference 	J7R 77 01 464 030 →F197763	751 77 01 467 223			50 005 316
05.1991→03.1993 Reference	J7R 77 01 466 788	732			50 005 309
10.1986→12.1995 Reference	J7R 77 01 465 119	746, 747 , 750, 751 77 01 465 761 77 01 585 084 79 46 004 571			50 005 857

R 21 2.0i 12V

198

05.1989→12.1995 Reference	J7R 77 01 465 513	740, 754			50 005 341
05.1989→12.1995 Reference	J7R 77 01 465 119	740, 754 77 01 465 761 77 01 585 084 79 46 004 571			50 005 857

R 21 2.0i Turbo

199

04.1987→03.1992 Reference 	J7R 77 01 465 513 f209863→	752			50 005 341
05.1989→03.1993 Reference	J7R 77 01 465 119	756 77 01 465 761 77 01 585 084 79 46 004 571			50 005 857

R 21 2.1 D

200

05.1989→06.1994 Reference	J8S 77 01 464 030	740 77 01 467 223			50 005 316
03.1986→12.1994 Reference	J8S 77 01 465 119	600, 704, 740 77 01 465 761 77 01 585 084 79 46 004 571			50 005 857

R





R 21 2.1 TD

201

03.1986→12.1995	J8S	742, 746, 786, 788					50 005 316
Reference	77 01 464 030	77 01 467 223					
03.1986→12.1995	J8S	604, 714, 742, 746, 786, 788				50 005 857	
Reference	77 01 465 119	77 01 465 761	77 01 585 084	79 46 004 571			

R 21 2.2i

202

07.1986→12.1994	J7T	755					50 005 341
Reference	77 01 465 513	f241443→					
07.1986→12.1994	J7T	754, 755					50 005 316
Reference	77 01 464 030	77 01 467 223					
		→F241442					
03.1986→12.1994	J6T	790, 791				50 005 857	
07.1986→12.1994	J7T	754, 755					
Reference	77 01 465 119	77 01 465 761	77 01 585 084	79 46 004 571			

R 25 2.0

203

01.1984→12.1992	J6R	706, 707, 762, 763				50 005 857	
Reference	77 01 465 119	77 01 465 761	77 01 585 084	79 46 004 571			



R 25 2.0i

204

06.1987→12.1992	J7R	722, 723				50 005 857	
Reference	77 01 465 119	77 01 465 761	77 01 585 084	79 46 004 571			

R 25 2.0i 12V

205

06.1989→12.1992	J7R	726					50 005 341
Reference	77 01 465 513	f241853→					
10.1988→12.1992	J7R	720, 721, 726				50 005 857	
Reference	77 01 465 119	77 01 465 761	77 01 585 084	79 46 004 571			

R



R 25 2.1 D

206

01.1984→04.1988 Reference	J8S 706 77 01 461 336			50 005 323
04.1988→12.1992 Reference	J8S 736 77 01 465 119 77 01 465 761 77 01 585 084 79 46 004 571			50 005 857

R 25 2.1 TD

207

01.1984→12.1992 Reference	J8S 708 77 01 463 637 →397289			50 005 318
01.1984→12.1992 Reference	J8S 708, 738 77 01 465 119 77 01 465 761 77 01 585 084 79 46 004 571			50 005 857

R 25 2.2i

208

01.1984→12.1992 Reference	J7T 730, 731, 732, 733 77 01 465 513 J7T 732: f259469→ J7T 731: f259572→ J7T 730: f259594→ J7T 733: f259623→			50 005 341
01.1984→12.1992 Reference	J7T 730, 731, 732, 733 77 01 465 119 77 01 465 761 77 01 585 084 79 46 004 571			50 005 857

R 30 2.1 TD

209

10.1981→12.1983 Reference	J8S 702 77 01 461 336			50 005 323
------------------------------	--------------------------	--	--	------------

Rapid 1.1

210

03.1986→10.1997 Reference	C1E 750, 752, 754, 756, 760, 762, 792 77 01 588 187			50 005 856
03.1986→10.1997 Reference	C1E 750, 752, 754, 762 77 01 462 145 77 01 462 491 77 01 463 377 77 01 466 419 89 82 775 051 ohne Gegengehäuse/without backhousing/sans demi-corps/sin remate/без заднего корпуса			50 005 302

**RENAULT**

03.1986→10.1997 Reference 	C1E 750, 752, 754, 762 77 01 462 145 77 01 462 491 77 01 463 377 77 01 466 419 mit Gegengehäuse/with backhousing/avec demi-corps/con remate/c задним корпусом			50 005 326
Rapid 1.2				211
09.1991→09.1996 Reference	C1G 726 77 01 588 187		50 005 856	
Rapid 1.2i				212
09.1991→10.1997 Reference	C3G 700, 710, 712 77 01 467 153			50 005 759
09.1991→10.1997 Reference	C3G 710, 712 77 01 588 187		50 005 856	
Rapid 1.4				213
03.1986→09.1997 06.1987→09.1997 03.1986→08.1991 Reference	C1J 715, 768, 780 C2J 784 C3J 700, 702 77 01 588 187		50 005 856	
03.1986→08.1991 06.1987→09.1997 03.1986→08.1991 Reference 	C1J 768, 780 C2J 784 C3J 700, 702 77 01 462 145 77 01 462 491 77 01 463 377 77 01 466 419 89 82 775 051 ohne Gegengehäuse/without backhousing/sans demi-corps/sin remate/без заднего корпуса			50 005 302
03.1986→08.1991 06.1987→09.1997 03.1986→08.1991 Reference 	C1J 768, 780 C2J 784 C3J 700, 702 77 01 462 145 77 01 462 491 77 01 463 377 77 01 466 419 mit Gegengehäuse/with backhousing/avec demi-corps/con remate/c задним корпусом			50 005 326
Rapid 1.4i				214
09.1991→10.1997 Reference	E7J 720, 724, 726, 728, 773 77 01 643 206 77 01 669 305 77 01 693 574 77 01 693 578		50 005 253 NEW	
09.1991→10.1997 Reference	E7J 720, 724, 726, 728 77 00 736 091 77 01 633 125			50 005 308









R



06.1987→03.1997 Reference	C3J 77 01 588 187	760, 762			50 005 856
09.1991→03.1997 Reference 	C3J 77 01 462 145 89 82 775 051	762 77 01 462 491 77 01 463 377 77 01 466 419			50 005 302
03.1996→09.1997 Reference	E7J 77 01 669 300	770, 771 77 01 693 575			50 005 859
09.1991→03.1997 Reference 	C3J 77 01 462 145	762 77 01 462 491 77 01 463 377 77 01 466 419			50 005 326
09.1991→10.1997 Reference	E7J 77 01 643 206	720, 724, 726, 728, 773			50 005 847
03.1996→09.1997 Reference	E7J 77 00 866 518	770, 771 82 00 146 301			50 005 040 NEW
Rapid 1.6 D					215
03.1986→08.1998 Reference	F8M 77 00 859 570 77 01 611 364	720, 730, 736, 760 77 00 864 218 77 00 864 220 77 01 590 269			50 005 865
03.1986→03.1997 Reference	F8M 77 01 462 809 77 01 465 816 77 01 473 365	720, 730, 736 77 01 463 111 77 01 466 578 77 01 468 491 77 01 468 492			50 005 301
Rapid 1.9 D					216
04.1997→09.1997 Reference	F8Q 77 01 669 290 82 00 279 948	648, 680, 682, 684 77 01 693 577 82 00 194 608 82 00 222 704			50 005 858
09.1991→10.1997 Reference	F8Q 77 00 859 570 77 01 611 364	640, 644, 646, 722, 724, 774, 776 77 00 864 218 77 00 864 220 77 01 590 269			50 005 865
09.1991→10.1997 Reference	F8Q 77 01 462 809 77 01 465 816 77 01 473 365	722, 724, 730, 732, 774 77 01 463 111 77 01 466 578 77 01 468 491 77 01 468 492			50 005 301

R





Rodeo 5 1.1										217	
07.1971→04.1980	688.10										
09.1981→05.1987	688	712									
Reference	77 01 457 671	77 01 505 397								50 005 311	
Safrane 2.0i										218	
04.1992→09.1996	J7R	732									
Reference	77 01 466 788									50 005 309	
Safrane 2.0i 16V										219	
10.1996→12.2000	N7Q	710, 711									
Reference	74 38 610 006									50 005 107	
Safrane 2.2i 12V										220	
04.1992→09.1996	J7T	761									
Reference	77 01 466 788									50 005 309	
Safrane 2.2 TD 12V										221	
10.1996→12.2000	G8T	740									
Reference	77 00 106 101	77 00 107 845	77 00 111 841	77 00 861 627							
	82 00 042 514									50 005 336	
Scénic 1.4i										222	
11.1996→09.1999	E7J	764									
Reference	77 01 669 300	77 01 693 575									
	→02.2002									50 005 859	
11.1996→09.1999	E7J	764									
Reference	77 00 866 518	82 00 146 301								50 005 040	
										NEW	
Scénic 1.4i 16V										223	
08.1998→02.2002	K4J	714, 750									
Reference	82 00 101 970	82 00 227 686									
	07.2001→									50 005 849	
08.1998→02.2002	K4J	714, 750									
Reference	77 00 105 176	77 00 105 378	77 00 274 330	82 00 146 297							
	82 00 428 447	82 00 582 675								50 005 170	
										NEW	
08.1998→02.2002	K4J	714, 750									
Reference	77 01 693 576										
	→06.2001									50 005 846	







Scénic 1.6i

224

04.1997→ Reference	K7M 702, 720 77 00 861 686			50 005 340
01.1996→ Reference	K7M 702, 703, 720 77 01 669 300 77 01 693 575		50 005 859	





Scénic 1.6i 16V

225

08.1998→ Reference 	K4M 700, 701, 706, 708, 709, 712 82 00 101 970 82 00 227 686 K4M 700, K4M 701, K4M 708, K4M 712: 07.2001→ K4M 706: 12.2001→		50 005 849	
08.1999→ Reference	K4M 708 82 00 266 947			50 005 934 NEW
08.1998→ Reference	K4M 700, 701, 704, 708 77 00 105 176 77 00 105 378 77 00 274 330 82 00 146 297 82 00 428 447 82 00 582 675			50 005 170 NEW
08.1998→ Reference 	K4M 700, 701, 704, 706, 708, 712 77 01 693 576 K4M 700, K4M 701, K4M 708, K4M 712: →06.2001 K4M 706: →11.2001		50 005 846	

Scénic 1.8i 16V

226

09.2000→ Reference 	F4P 720, 722 77 01 693 588 82 00 194 613 F4P 722: →01.2007		50 005 862	
09.2000→ Reference 	F4P 720, 722 77 01 693 588 82 00 194 613 82 00 243 153 82 00 279 956 F4P 722: →01.2007		50 005 861	



Scénic 1.9 D

227

11.1996→ Reference	F8Q 788, 790 77 01 669 290 77 01 693 577 82 00 194 608 82 00 222 704 82 00 279 948		50 005 858	
-----------------------	--	---	------------	--

Scénic 1.9 TD

228

11.1996→03.1997 Reference	F8Q 786 77 01 669 290 77 01 693 577 82 00 194 608 82 00 222 704 82 00 279 948		50 005 858	
11.1996→03.1997 Reference	F8Q 784 77 00 859 570 77 00 864 218 77 00 864 220 77 01 590 269 77 01 611 364		50 005 865	

R



11.1996→03.1997	F8Q	784				
Reference	77 01 462 809 77 01 465 816 77 01 473 365	77 01 463 111 77 01 466 578	77 01 463 397 77 01 468 491	77 01 464 736 77 01 468 492		50 005 301
Scénic 1.9 dTi						229
06.1997→	F9Q	731, 734, 736				
Reference	77 01 669 290 82 00 279 948 →11.2000	77 01 693 577	82 00 194 608	82 00 222 704		50 005 858
06.1997→02.1999	F9Q	734				
Reference	77 01 462 809 77 01 465 816 77 01 473 365	77 01 463 111 77 01 466 578	77 01 463 397 77 01 468 491	77 01 464 736 77 01 468 492		50 005 301
06.1997→	F9Q	731, 734, 736				
Reference	82 00 199 281 12.2000→	82 00 243 154	82 00 279 953	82 00 741 635		50 005 254 NEW
04.1997→	F9Q	730, 731, 736				
Reference	77 00 111 675	77 01 472 182				50 005 756
Scénic 1.9 dCi						230
03.1999→08.2003	F9Q	732, 740				
Reference	77 01 669 290 82 00 279 948 →11.2000	77 01 693 577	82 00 194 608	82 00 222 704		50 005 858
03.1999→	F9Q	732, 733, 738, 740, 744, 748				
Reference	82 00 199 281 F9Q 732, F9Q 740: 12.2000→ F9Q 733, F9Q 738: →08.2007	82 00 243 154	82 00 279 953	82 00 741 635		50 005 254 NEW
03.1999→08.2003	F9Q	732, 733, 740				
Reference	77 00 111 675	77 01 472 182				50 005 756
Scénic 2.0i						231
01.1997→09.1999	F3R	750, 751				
Reference	77 01 462 809 77 01 465 816 77 01 473 365	77 01 463 111 77 01 466 578	77 01 463 397 77 01 468 491	77 01 464 736 77 01 468 492		50 005 301
Scénic 2.0i 16V						232
03.1999→	F4R	740, 741, 744, 747				
Reference	77 01 693 588 F4R 747: →01.2007	82 00 194 613				50 005 862
03.1999→	F4R	740, 741, 744, 747				
Reference	77 01 693 588 F4R 747: →01.2007	82 00 194 613	82 00 243 153	82 00 279 956		50 005 861





Scénic II 1.4i 16V

233

05.2003→ Reference	K4J 82 00 101 970	730 82 00 227 686			50 005 849	
05.2003→ Reference	K4J 77 00 105 176 82 00 428 447	730, 750 77 00 105 378 82 00 582 675	77 00 274 330	82 00 146 297		50 005 170 NEW

Scénic II 1.5 dCi

234

05.2003→ Reference	K9K 82 00 101 970	722, 728 82 00 227 686			50 005 849	
		→02.2006				
05.2003→ Reference	K9K 77 01 475 995	728, 729 77 01 478 031				50 005 027 NEW
Reference	K9K 77 01 473 327	722, 724 77 01 476 496				50 005 171 NEW

Scénic II 1.6i 16V

235

05.2003→ Reference	K4M 82 00 101 970	761, 764, 782 82 00 227 686			50 005 849	
05.2003→ Reference	K4M 77 00 105 176 82 00 428 447	760, 761, 782 77 00 105 378 82 00 582 675	77 00 274 330	82 00 146 297		50 005 170 NEW



Scénic II 1.9 dCi

236

05.2003→ Reference	F9Q 82 00 199 281	812 82 00 243 154	82 00 279 953	82 00 741 635		50 005 254 NEW
		→08.2007				
05.2003→ Reference	F9Q 77 00 111 675	756 77 01 472 182				50 005 756

Scénic II 2.0i 16V

237

05.2003→ Reference	F4R 77 01 669 290 82 00 279 948	770, 771 77 01 693 577	82 00 194 608	82 00 222 704		50 005 858
05.2003→ Reference	F4R 77 00 111 675	770, 771, 776 77 01 472 182				50 005 756



Scénic II 2.0i Turbo 16V

238

06.2003→ F4R 764
Reference 77 00 111 675 77 01 472 182

50 005 756

Spider 2.0i 16V

239

05.1996→ F7R 720
Reference 77 01 669 290 77 01 693 577 82 00 194 608 82 00 222 704
82 00 279 948

50 005 858

05.1996→ F7R 710
Reference 77 01 462 809 77 01 463 111 77 01 463 397 77 01 464 736
77 01 465 816 77 01 466 578 77 01 468 491 77 01 468 492
77 01 473 365

50 005 301

Symbol 1.4i

240

05.2001→ K7J 700
Reference 77 01 669 300 77 01 693 575
→10.2001

50 005 859

Symbol 1.4i 16V

241

06.2001→ K4J 712, 713
Reference 82 00 101 970 82 00 227 686
07.2001→

50 005 849

06.2001→ K4J 712, 713
Reference 77 00 105 176 77 00 105 378 77 00 274 330 82 00 146 297
82 00 428 447 82 00 582 675

50 005 170
NEW

06.2001→ K4J 712
Reference 77 01 693 576
→06.2001

50 005 846
R

Symbol 1.5 dCI

242

Reference K9K 700
82 00 101 970 82 00 227 686
07.2001→02.2006

50 005 849

Reference K9K 700
77 01 473 327 77 01 476 496

50 005 171
NEW

Symbol 1.6i

243

11.2001→ K4M 734
Reference 82 00 101 970 82 00 227 686

50 005 849





Thalia II 1.4i

244

05.2001→ Reference	K7J 700 77 01 669 300 77 01 693 575 →10.2001		50 005 859	
-----------------------	--	---	------------	--

Thalia II 1.4i 16V

245

06.2001→ Reference	K4J 712, 713 82 00 101 970 82 00 227 686 07.2001→		50 005 849	
06.2001→ Reference	K4J 712, 713 77 00 105 176 77 00 105 378 77 00 274 330 82 00 146 297 82 00 428 447 82 00 582 675			50 005 170 <small>NEW</small>
06.2001→ Reference	K4J 712 77 01 693 576 →06.2001		50 005 846	

Thalia II 1.5 dCi

246

09.2001→ Reference	K9K 700 82 00 101 970 82 00 227 686 07.2001→02.2006		50 005 849	
09.2001→ Reference	K9K 700 77 01 693 576 →06.2001		50 005 846	
09.2001→ Reference	K9K 700 77 01 473 327 77 01 476 496			50 005 171 <small>NEW</small>

Thalia II 1.6i

247

11.2001→ Reference	K4M 734 82 00 101 970 82 00 227 686		50 005 849	
-----------------------	--	---	------------	--

Trafic 1.7

248

10.1984→10.1997 Reference	F1N 720, 722, 724 77 00 859 570 77 00 864 218 77 00 864 220 77 01 590 269 77 01 611 364		50 005 865	
10.1984→10.1997 Reference	F1N 720, 724 77 01 462 809 77 01 463 111 77 01 463 397 77 01 464 736 77 01 465 816 77 01 466 578 77 01 468 491 77 01 468 492 77 01 473 365			50 005 301



Trafic 1.9 D

249

11.1997→05.2001	F8Q	600, 606			
Reference	77 01 669 290 82 00 279 948	77 01 693 577	82 00 194 608	82 00 222 704	



50 005 858

Trafic 1.9 dCi 80

250

05.2001→	F9Q	762			
Reference	82 00 199 281	82 00 243 154	82 00 279 953	82 00 741 635	

50 005 254

NEW

05.2001→	F9Q	762			
Reference	77 00 111 675	77 01 472 182			



50 005 756

Trafic 1.9 dCi 100

251

05.2001→	F9Q	760			
Reference	77 01 669 290 82 00 279 948 →09.2000	77 01 693 577	82 00 194 608	82 00 222 704	



50 005 858

05.2001→	F9Q	760			
Reference	82 00 199 281 10.2000→	82 00 243 154	82 00 279 953	82 00 741 635	



50 005 254

NEW

05.2001→	F9Q	760			
Reference	77 00 111 675	77 01 472 182			



50 005 756

Trafic 2.0

252

09.1980→02.1989	829	720			
Reference	77 01 461 336				



50 005 323

09.1980→10.1997	J5R	716, 726			
Reference	77 01 465 119	77 01 465 761	77 01 585 084	79 46 004 571	



50 005 857

R

Trafic 2.0i 16V

253

06.2001→	F4R	720			
Reference	77 01 693 588	82 00 194 613			



50 005 862

06.2001→	F4R	720, 722			
Reference	77 00 111 675	77 01 472 182			



50 005 756

06.2001→	F4R	720			
Reference	77 01 693 588	82 00 194 613	82 00 243 153	82 00 279 956	



50 005 861

Trafic 2.1 D

254

09.1994→10.1997	J8S	620			
Reference	77 01 464 030	77 01 467 223			



50 005 316







09.1980→10.1997 Reference	852 77 01 461 336	720, 750				50 005 323
09.1980→10.1997 09.1994→10.1997 Reference	852 J8S 77 01 465 119	720, 750 620, 622, 758 77 01 465 761	77 01 585 084	79 46 004 571		50 005 857
Trafic 2.2i						255
03.1989→10.1997 Reference 	J7T 77 01 465 513 f305273→	600, 780				50 005 341
03.1989→10.1997 Reference	J7T 77 01 465 119	600, 780	77 01 465 761	77 01 585 084	79 46 004 571	
Trafic 2.5 D						256
03.1989→10.1997 09.1980→ Reference	8140.67.2500 S8U 50 01 001 274	720, 722, 742 77 01 462 808	77 01 468 342			50 005 321
Trafic II 2.5 dCi 16V						257
06.2002→ Reference	G9U 77 01 472 625	630, 730	77 01 474 190	82 00 129 206		50 005 794
Twingo 1.2i						258
01.1996→ Reference	D7F 77 00 864 596	700, 701, 702, 703, 704	82 00 037 686	82 00 088 660	82 00 088 663	
03.1993→08.1997 Reference	C3G 77 01 467 153	700, 702				50 005 759
01.1996→ Reference	D7F 82 00 266 947	700, 701, 702, 703, 704				50 005 934 <small>NEW</small>
03.1993→08.1997 Reference	C3G 77 01 588 187	700, 702				50 005 856

R



Vel Satis 2.0i Turbo 16V

259

04.2002→	F4R	766, 767					
Reference	77 01 669 290 82 00 279 948	77 01 693 577	82 00 194 608	82 00 222 704		50 005 858	
04.2002→	F4R	762, 763					
Reference	77 01 693 588 F4R 762: →01.2007	82 00 194 613				50 005 862	
04.2002→	F4R	762, 763, 764					
Reference	77 00 111 675	77 01 472 182					50 005 756
04.2002→	F4R	762, 763					
Reference	77 01 693 588 F4R 762: →01.2007	82 00 194 613	82 00 243 153	82 00 279 956		50 005 861	



Vel Satis 2.2 dCi 16V

260





04.2002→	G9T	702					
Reference	77 01 472 625	77 01 474 190	82 00 129 206				50 005 794

Engine

261

Reference	F3R	200					
	77 01 462 809 77 01 465 816 77 01 473 365	77 01 463 111 77 01 466 578	77 01 463 397 77 01 468 491	77 01 464 736 77 01 468 492			50 005 301
Reference	S9U						
	50 01 001 274	77 01 462 808	77 01 468 342				50 005 321



			Cyl	 mm	cm ³		Comp. Ratio ε	kW	PS	Pos
4.236	D	(AN)	4	98,48 x 126,8	3864	2	16:1	48-60	59-80	1, 2, 3, 4, 5, 6, 7, 8, 9, 11, 12
8140.21.200	D	(A)	4	93 x 90	2445	2	18:1	68	92	10



RENAULT TRUCKS (RVI)



Series 350

1

09.1979→

4.236



50 005 246

NEW

09.1979→



4.236
mit Riemenscheibe
with pulley
avec poulie
con polea
с Ремснный шкив



50 005 245

NEW

09.1979→

4.236



50 005 252

NEW

Series 380

2

09.1979→

4.236



50 005 246

NEW

09.1979→



4.236
mit Riemenscheibe
with pulley
avec poulie
con polea
с Ремснный шкив



50 005 245

NEW

09.1979→

4.236



50 005 252

NEW

R

Series 440

3

09.1979→

4.236



50 005 246

NEW

09.1979→



4.236
mit Riemenscheibe
with pulley
avec poulie
con polea
с Ремснный шкив



50 005 245

NEW

09.1979→

4.236



50 005 252

NEW



RENAULT TRUCKS (RVI)



Series 450

4

09.1979→	4.236			50 005 246 NEW
09.1979→ 	4.236 mit Riemenscheibe with pulley avec poulie con polea с Ремснный шкив			50 005 245 NEW
09.1979→	4.236			50 005 252 NEW

Series 480

5

09.1979→	4.236			50 005 246 NEW
09.1979→ 	4.236 mit Riemenscheibe with pulley avec poulie con polea с Ремснный шкив			50 005 245 NEW
09.1979→	4.236			50 005 252 NEW

Series 500

6

09.1979→	4.236			50 005 246 NEW
09.1979→ 	4.236 mit Riemenscheibe with pulley avec poulie con polea с Ремснный шкив			50 005 245 NEW
09.1979→	4.236			50 005 252 NEW

R



RENAULT TRUCKS (RVI)



Series 530

7

09.1979→	4.236			50 005 246 NEW
09.1979→ 	4.236 mit Riemenscheibe with pulley avec poulie con polea с Ремснный шкив			50 005 245 NEW
09.1979→	4.236			50 005 252 NEW

Series 550

8

09.1979→	4.236			50 005 246 NEW
09.1979→ 	4.236 mit Riemenscheibe with pulley avec poulie con polea с Ремснный шкив			50 005 245 NEW
09.1979→	4.236			50 005 252 NEW

R

Series 560

9

09.1979→	4.236			50 005 246 NEW
09.1979→ 	4.236 mit Riemenscheibe with pulley avec poulie con polea с Ремснный шкив			50 005 245 NEW
09.1979→	4.236			50 005 252 NEW



RENAULT TRUCKS (RVI)



B 90

10

04.1986→09.1990 8140.21.200



50 005 321

OK 010 K

11

01.1973→09.1979 4.236



50 005 246
NEW

01.1973→09.1979 4.236
mit Riemenscheibe
with pulley
avec poulie
con polea
с Ремснный шкив



50 005 245
NEW

01.1973→09.1979 4.236



50 005 252
NEW

OK 05 K

12

01.1973→09.1979 4.236



50 005 246
NEW

01.1973→09.1979 4.236
mit Riemenscheibe
with pulley
avec poulie
con polea
с Ремснный шкив



50 005 245
NEW





01.1973→09.1979 4.236



50 005 252
NEW

R

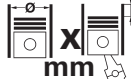

			Cyl		cm ³		Comp. Ratio ε	kW	PS	Pos
11 L	D	(LA)	4	90,475 x 97	2496	2	19,5:1	80	109	1, 2, 6, 7
12 L	D	(LA)	4	90,475 x 97	2496	2	19,5:1	83	113	6
16 K4F	B		4	80 x 79	1588	4	10,5:1	80-82	109-111	10, 11, 13, 21
16 L	D	(LA)	4	90,475 x 97	2496	2	19,5:1	83	113	1, 2, 4
19 L	D	(A)	4	90,475 x 97	2496	2	19,5:1	83-90	113-122	1, 6
20 T2N	D	(LA)	4	84,45 x 88,9	1994	2	19,5:1	77	105	17, 25, 29
20 T2R (63 kW)	D	(A)	4	84,45 x 88,9	1994	2	19,5:1	63	86	16, 24
20 T4G	B	(LA)	4	84,45 x 89	1994	4	8,5:1	132-147	180-200	19, 27, 32, 35
20 T4H	B		4	84,45 x 89	1994	4	10:1	99-103	134-140	5, 18, 26, 34
21 L	D	(LA)	4	90,475 x 97	2496	2	19,5:1	83	113	6
23 L	D	(LA)	4	90,475 x 97	2496	2	19,5:1	83	113	1, 2, 4
D16A8	B		4	75 x 90	1590	4	9,5:1	90-96	122-131	13, 21
D16Y3	B		4	75 x 90	1590	4	9,1:1	83	113	20
D16Z2 (81 kW)	B		4	75 x 90	1590	4	9,1:1	81-85	110-116	13, 21
F18A3	B		4	85 x 81,5	1850	4	8,9:1	85	115	28
F20A4	B		4	85 x 88	1997	4	9,5:1	98	133	30
F20Z1	B		4	85 x 88	1997	4	9,9,5:1	96	131	31
F20Z2	B		4	85 x 88	1997	4	9:1	85	115	31
F20Z3	B		4	85 x 88	1997	4	9,9,5:1	100	136	31
H23A2	B		4	87 x 95	2259	4	9,8:1	116	158	33
M57 D30 (135 kW)	D	(LA)	6	84 x 88	2926	4	18:1	135-142	184-193	9
M52 B28 TU	B		6	84 x 84	2793	4	10,2:1	142	193	3
TUD 3	D	(AN)	4	75 x 77	1361	2	22:1	39	53	12
TUD 3Y	D	(AN)	4	75 x 77	1361	2	22:1	37	50	12
TUD 5	D	(AN)	4	77 x 82	1527	2	23:1	40-42	54-57	8
XUD 7TE	D	(LA)	4	80 x 88	1769	2	22,5:1	64-66	88-90	15, 23
XUD 9 (47 kW)	D	(AN)	4	83 x 88	1905	2	23,5:1	47-52	64-71	14, 22

**Defender 90 2.5 TDi****1**

09.1994→12.1998 11 L, 16 L, 19 L, 23 L
Reference ERR 3290 PEB 500090 SCT 1086



50 005 901
NEW

Defender 110 2.5 TDi**2**

09.1994→12.1998 11 L, 16 L, 23 L
Reference ERR 3290 PEB 500090 SCT 1086



50 005 901
NEW

Defender 110 2.8i 24V**3**

09.2000→ M52 B28 TU



50 005 513

Defender 130 2.5 Tdi**4**

09.1994→12.1998 16 L, 23 L
Reference ERR 3290 PEB 500090 SCT 1086



50 005 901
NEW

Discovery 2.0i 16V**5**

10.1993→06.1998 20 T4H
Reference GWP193 GWP347 PEB102420



50 005 082
NEW

Discovery 2.5 TDi**6**

09.1989→12.1998 11 L, 12 L, 19 L, 21 L
Reference ERR 3290 PEB 500090 SCT 1086



50 005 901
NEW

Landrover 90 2.5 TDi**7**

07.1989→07.1990 11 L
Reference ERR 3290 PEB 500090 SCT 1086



50 005 901
NEW

Metro 1.5 D**8**

12.1994→12.1998 TUD 5
Reference GWP 346



50 005 339

R



Range Rover III 3.0 Td6

9

03.2002→

M57 D30 (135 kW)



50 005 785

25 1.6i 16V

10

02.2000→05.2005

16 K4F

Reference

GWP2157

GWP2161

GWP2163



50 005 084

NEW

45 1.6i 16V

11

02.2000→05.2005

16 K4F

Reference

GWP2157

GWP2161

GWP2163



50 005 084

NEW

114 D

12

1991 → 1996

TUD 3, TUD 3Y

Reference

GWP 195

GWP 341



50 005 310

216i 16V

13

10.1989→03.2000

16 K4F, D16A8, D16Z2 (81 kW)

Reference

GWP2157

GWP2161

GWP2163



50 005 084

NEW

218 D

14

10.1992→12.1994

XUD 9 (47 kW)

Reference

GWP 337

GWP 338

→10CU4N4014119



50 005 320

10.1992→12.1994

XUD 9 (47 kW)

10cu4n4014120→



50 005 313

218 TD

15

10.1992→02.1996

XUD 7TE

Reference

GWP 337

GWP 338

→10CV2L4016153



50 005 320















R



10.1992→02.1996 	XUD 7TE 10cv214016154→						50 005 313
220 SD							16
09.1995→03.2000 Reference	20 T2R (63 kW) GWP193 GWP347 PEB102420						50 005 082 NEW
220 SDi							17
09.1995→03.2000 Reference	20 T2N GWP193 GWP347 PEB102420						50 005 082 NEW
220i 16V							18
10.1992→03.1996 Reference	20 T4H GWP193 GWP347 PEB102420						50 005 082 NEW
220i Turbo 16V							19
01.1993→06.1996 Reference	20 T4G GWP193 GWP347 PEB102420						50 005 082 NEW
416i							20
05.1995→03.2000 Reference	D16Y3 GWP2157 GWP2161 GWP2163						50 005 084 NEW
416i 16V							21
04.1990→03.2000 Reference	16 K4F, D16A8, D16Z2 (81 kW) GWP2157 GWP2161 GWP2163						50 005 084 NEW
418 D							22
09.1991→04.1995 Reference 	XUD 9 (47 kW) GWP 337 GWP 338 →10CU4N4014119						50 005 320

R



				
09.1991→04.1995 	XUD 9 (47 kW) 10cu4n4014120→			50 005 313
418 TD 23				
09.1991→03.2000 Reference 	XUD 7TE GWP 337 GWP 338 →10CV2L4016153			50 005 320
09.1991→03.2000 	XUD 7TE 10cv2l4016154→			50 005 313
420 SD 24				
09.1995→03.2000 Reference	20 T2R (63 kW) GWP193 GWP347 PEB102420			50 005 082 NEW
420 SDi 25				
10.1995→03.2000 Reference	20 T2N GWP193 GWP347 PEB102420			50 005 082 NEW
420i 16V 26				
10.1995→03.2000 Reference	20 T4H GWP193 GWP347 PEB102420			50 005 082 NEW
420i Turbo 16V 27				
01.1993→02.1996 Reference	20 T4G GWP193 GWP347 PEB102420			50 005 082 NEW
618i 16V 28				
03.1996→06.1999	F18A3			50 005 080 NEW

R

**620 SDi****29**

03.1995→12.1998

20 T2N

Reference

GWP193

GWP347

PEB102420



50 005 082

NEW

620 Si**30**

09.1993→04.1999

F20A4



50 005 080

NEW

620i 16V**31**

04.1993→09.2000

F20Z1, F20Z2, F20Z3



50 005 080

NEW

620i Turbo 16V**32**

04.1993→12.1998

20 T4G

Reference

GWP193

GWP347

PEB102420



50 005 082

NEW

623i 16V**33**

04.1993→06.1999

H23A2

Reference

GWP343



50 005 090

NEW

820i 16V**34**

01.1992→09.1999

20 T4H

Reference

GWP193

GWP347

PEB102420



50 005 082

NEW

820i Turbo 16V**35**

01.1992→01.1999

20 T4G

Reference

GWP193

GWP347

PEB102420







50 005 082

NEW

R



			Cyl	 mm	cm ³		Comp. Ratio ε	kW	PS	Pos
B 20 I	B		4	90 x 78	1985	2	9,5:1	74	100	12, 13
B 201 C	B		4	90 x 78	1985	2	9,2:1	74	100	14
B 201 I	B		4	90 x 78	1985	2	9,25:1	81	110	14
B 201 S	B	(LA)	4	90 x 78	1985	2	8,5:1	102-110	139-150	15
B 201 T	B		4	90 x 78	1985	2		79	108	14
B 202 L	B	(LA)	4	90 x 78	1985	4	9:1	118-121	160-165	16
B 202 S	B	(LA)	4	90 x 78	1985	2	9:1	104-108	141-147	16, 21
B 202 XL	B	(LA)	4	90 x 78	1985	4	9:1	127-132	172-180	16, 21
B 204 I	B		4	90 x 78	1985	4	10,1:1	96	131	3
B 204 L	B	(LA)	4	90 x 78	1985	4	9,2:1	136	185	4, 18, 21
B 205 E	B	(LA)	4	90 x 78	1985	4	8,8:1	110	150	4, 21
B 206	B		4	90 x 78	1985	4	10,1:1	96	131	20
B 212 I	B		4	93 x 78	2119	4	10:1	100-103	136-140	17
B 234 E	B		4	90 x 90	2290	2		125	170	23
B 234 I	B		4	90 x 90	2290	4	10,5:1	108-118	147-160	6, 22
B 234 L (147 kW)	B		4	90 x 90	2290	2	9,25:1	147	200	22
B 234 R	B	(A)	4	90 x 90	2290	4	9,25:1	165	224	23
B 235 E	B	(A)	4	90 x 90	2290	4	9,25/ 9,3:1	125-136	170-185	7, 10
B 235 R (184 kW)	B	(A)	4	90 x 90	2290	4	9,3:1	184	250	10
B 258 I	B		6	81,6 x 79,6	2498	4	10,8:1	125	170	19
B 308 E	B	(LA)	6	86 x 85	2962	4	9,5:1	147	200	11
B 308 I	B		6	86 x 85	2962	4	10,8:1	155	211	24
D 223 L	D	(LA)	4	84 x 98	2172	4	18/ 19,5:1	88-95	120-129	5, 9
X 22 DTH	D	(LA)	4	84 x 98	2172	4	18,5:1	85-92	116-125	5
Y 22 DTH	D	(LA)	4	84 x 98	2172	4	18,5:1	85	116	5
Z 18 XE	B		4	80,5 x 88,2	1796	4	10,5:1	90-92	122-125	1
Z 19 DTH	D	(LA)	4	82 x 90,4	1910	4	17,5:1	110	150	2, 8

**9-3 1.8i 16V****1**

09.2004→

Z 18 XE



50 005 747

9-3 1.9 TiD 16V**2**

09.2004→

Z 19 DTH

Reference

93179114



50 005 056

NEW

9-3 2.0i 16V**3**

03.1998→08.2000

B 204 I

Reference

8822710

8822744

8822793

9321951



50 005 223

9-3 2.0i Turbo 16V**4**

03.1998→07.2003

B 204 L, B 205 E

Reference

8822710

8822744

8822793

9321951



50 005 223

9-3 2.2 TiD 16V**5**

02.1998→

D 223 L, X 22 DTH, Y 22 DTH

Reference

4772711



50 005 748

9-3 2.3i 16V**6**

03.1998→08.2000

B 234 I

Reference

8822710

8822744

8822793

9321951



50 005 223

9-3 2.3i Turbo 16V**7**

01.1999→08.2000

B 235 E

Reference

8822710

8822744

8822793

9321951



50 005 223

9-5 1.9 TiD 16V**8**

01.2006→

Z 19 DTH

Reference

93179114



50 005 056

NEW

**9-5 2.2 TiD 16V****9**09.2002→
ReferenceD 223 L
4772711

50 005 748

9-5 2.3i Turbo 16V**10**06.1997→
ReferenceB 235 E, B 235 R (184 kW)
8822710 8822744 8822793 9321951

50 005 223

9-5 3.0i Turbo 24V**11**06.1997→08.2003
ReferenceB 308 E
4770970 8821944

50 005 224

90 2.0**12**08.1984→08.1987
ReferenceB 20 I
7501547 7507460 8817900 9307893

50 005 221

99 2.0**13**09.1975→12.1984
ReferenceB 20 I
7501547 7507460 8817900 9307893

50 005 221

900 I 2.0**14**09.1979→08.1991
ReferenceB 201 C, B 201 I, B 201 T
7501547 7507460 8817900 9307893

50 005 221

S**900 I 2.0i Turbo****15**09.1985→08.1990
ReferenceB 201 S
7501547 7507460 8817900 9307893

50 005 221

900 I 2.0i Turbo 16V**16**02.1984→08.1993
ReferenceB 202 L, B 202 S, B 202 XL
7501547 7507460 8817900 9307893

50 005 221

**900 I 2.1 16V****17**

09.1990→08.1993

B 212 I

Reference

7501547

7507460

8817900

9307893



50 005 221

900 II 2.0i Turbio 16V**18**

09.1993→08.1998

B 204 L

Reference

8822710

8822744

8822793

9321951



50 005 223

900 II 2.5i 24V**19**

09.1993→10.1998

B 258 I

Reference

4770970

8821944



50 005 224

9000 2.0i 16V**20**

09.1989→08.1993

B 206

Reference

8819948

9321688



50 005 225

9000 2.0i Turbo 16V**21**

05.1988→12.1998

B 202 S, B 202 XL

Reference

7501547

7507460

8817900

9307893



50 005 221

09.1993→12.1998

B 204 L, B 205 E

Reference

8822710

8822744

8822793

9321951



50 005 223

9000 2.3i 16V**22**

09.1993→12.1998

B 234 I, B 234 L (147 kW)

Reference

8819948

9321688



50 005 225

9000 2.3i Turbo 16V**23**

09.1992→12.1998

B 234 E, B 234 R

Reference

8819948

9321688



50 005 225



9000 3.0i 16V

24

09.1994→12.1998

B 308 I

Reference





4770970

8821944



50 005 224

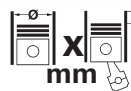

			Cyl	 mm	cm ³		Comp. Ratio ε	kW	PS	Pos
D 2555 M	D	(AN)	5	125 x 150	9199	2	17:1	124	168	1

S



SAVIEM



15.168

1

10.1973→07.1977





D 2555 M



50 005 833

S

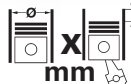

			Cyl	 mm	cm ³		Comp. Ratio ε	kW	PS	Pos
DS 11	D	(A)	6	127 x 145	11022	2		166-233	225-317	1, 2, 3, 4, 5, 6, 32, 34, 35, 36, 37, 38, 39, 40
DS 11.14	D	(A)	6	127 x 145	11022	2	15:1	206	280	7, 8, 10, 12, 13, 15
DS 11.15	D	(A)	6	127 x 145	11022	2	15:1	224	305	7, 8, 9, 10, 11, 12, 13, 14, 15, 41
DS 11.34	D	(A)	6	127 x 145	11022	2	16:1	228	310	16, 17, 18, 19, 20, 21, 22, 23, 24, 41
DS 11.75	D	(A)	6	127 x 145	11022	2	17:1	228	310	19, 22, 23, 24
DSC 11.06	D	(LA)	6	127 x 145	11022	2	17:1	228	310	12, 13, 15, 22, 23, 24
DSC 11.08	D	(LA)	6	127 x 145	11022	2	17:1	228	310	17, 19, 20, 21, 22, 23, 24
DSC 11.13	D	(LA)	6	127 x 145	11022	2	16:1	265-267	360-363	19, 22, 23, 24
DSC 11.16	D	(LA)	6	127 x 145	11022	2	16:1	230-239	313-325	22, 23, 24
DSC 11.17	D	(LA)	6	127 x 145	11022	2	16:1	235	320	19, 22, 23, 24
DSC 11.18	D	(LA)	6	127 x 145	11022	2	16:1	254-267	345-363	10, 12, 13, 19, 22, 23, 24, 41
DSC 11.21	D	(LA)	6	127 x 145	11022	2	17:1	235-266	320-362	19, 20, 21, 22, 23, 24
DSC 11.22	D	(LA)	6	127 x 145	11022	2	17:1	280	381	19, 23, 24
DSC 11.23	D	(LA)	6	127 x 145	11022	2	17:1	266	362	19, 22, 23, 24
DSC 11.30	D	(LA)	6	127 x 145	11022	2	17:1	265	360	22, 23
DTC 11.01	D	(LA)	6	127 x 145	11022	2	17:1	295	401	22, 23
DTC 11.02	D	(LA)	6	127 x 145	11022	2	17:1	295	401	22, 23
DSC 12.01	D	(LA)	6	127 x 154	11716	4	18:1	294	400	26, 27, 28
DSC 12.02	D	(LA)	6	127 x 154	11716	4	18:1	265	360	25, 26, 27, 28
DSC 12.03	D	(LA)	6	127 x 154	11716	4	18:1	309	420	28
DSC 12.05	D	(LA)	6	127 x 154	11716	4	18:1	309	420	25, 26, 27, 28, 33
DSC 12.06	D	(LA)	6	127 x 154	11716	4	18:1	309	420	41
DSC 14.13	D	(LA)	8	127 x 140	14181	2	18:1	390	530	29, 30, 31, 41
DSC 14.15	D	(LA)	8	127 x 140	14181	2	17:1	338	460	30, 31



LBT 111								1	
01.1975→12.1980	DS 11				50 005 832				
Reference	0301473	1318091							
LT 111								2	
01.1975→04.1980	DS 11				50 005 832				
Reference	0301473	1318091							
LBS 111								3	
01.1975→12.1980	DS 11				50 005 832				
Reference	0301473	1318091							
LS 111								4	
01.1975→04.1980	DS 11				50 005 832				
Reference	0301473	1318091							
LB 111								5	
01.1975→12.1980	DS 11				50 005 832				
Reference	0301473	1318091							
L 111								6	
01.1975→04.1980	DS 11				50 005 832				
Reference	0301473	1318091							
BR 112								7	
09.1978→12.1991	DS 11.14, DS 11.15				50 005 832				
Reference	0301473	1318091							
CR 112								8	
09.1978→12.1992	DS 11.14, DS 11.15				50 005 832				
Reference	0301473	1318091							
F 112								9	
10.1981→01.1995	DS 11.15				50 005 832				
Reference	0301473	1318091							
G 112								10	
01.1981→05.1988	DS 11.14, DS 11.15, DSC 11.18				50 005 832				
Reference	0301473	1318091							











S



K 112					11
04.1982→11.1990	DS 11.15			50 005 832	
Reference	0301473	1318091			
P 112					12
01.1981→05.1988	DS 11.14, DS 11.15, DSC 11.06, DSC 11.18			50 005 832	
Reference	0301473	1318091			
R 112					13
01.1981→05.1988	DS 11.14, DS 11.15, DSC 11.06, DSC 11.18			50 005 832	
Reference	0301473	1318091			
S 112					14
10.1981→10.1991	DS 11.15			50 005 832	
Reference	0301473	1318091			
T 112					15
01.1981→10.1992	DS 11.14, DS 11.15, DSC 11.06			50 005 832	
Reference	0301473	1318091			
BN 113					16
06.1990→08.1998	DS 11.34			50 005 832	
Reference	0301473	1318091			
CN 113					17
01.1990→09.1998	DS 11.34, DSC 11.08			50 005 832	
Reference	0301473	1318091			
F 113					18
06.1990→08.1998	DS 11.34			50 005 832	
Reference	0301473	1318091			
K 113					19
01.1990→	DS 11.34, DS 11.75, DSC 11.08, DSC 11.13, DSC 11.17, DSC 11.18, DSC 11.21, DSC 11.22, DSC 11.23			50 005 832	
Reference	0301473	1318091			
L 113					20
01.1990→08.1998	DS 11.34, DSC 11.08, DSC 11.21			50 005 832	
Reference	0301473	1318091			

S



N 113						21	
09.1991→08.1998	DS 11.34, DSC 11.08, DSC 11.21						
Reference	0301473 1318091				50 005 832		
P 113						22	
05.1988→12.2000	DS 11.34, DS 11.75, DSC 11.06, DSC 11.08, DSC 11.13, DSC 11.16, DSC 11.17, DSC 11.18, DSC 11.21, DSC 11.23, DSC 11.30, DTC 11.01, DTC 11.02						
Reference	0301473 1318091				50 005 832		
R 113						23	
05.1988→05.1997	DS 11.34, DS 11.75, DSC 11.06, DSC 11.08, DSC 11.13, DSC 11.16, DSC 11.17, DSC 11.18, DSC 11.21, DSC 11.22, DSC 11.23, DSC 11.30, DTC 11.01, DTC 11.02						
Reference	0301473 1318091				50 005 832		
T 113						24	
05.1988→05.2000	DS 11.34, DS 11.75, DSC 11.06, DSC 11.08, DSC 11.13, DSC 11.16, DSC 11.17, DSC 11.18, DSC 11.21, DSC 11.22, DSC 11.23						
Reference	0301473 1318091				50 005 832		
K 124						25	
08.1997→02.2002	DSC 12.02, DSC 12.05						
Reference	1353072 1508533					50 005 214	
P 124						26	
09.1995→09.2004	DSC 12.01, DSC 12.02, DSC 12.05						
Reference	1353072 1508533					50 005 214	
R 124						27	
09.1995→09.2004	DSC 12.01, DSC 12.02, DSC 12.05						
Reference	1353072 1508533					50 005 214	
T 124						28	
03.1995→	DSC 12.01, DSC 12.02, DSC 12.03, DSC 12.05						
Reference	1353072 1508533					50 005 214	
R 143						29	
12.1994→12.1996	DSC 14.13						
Reference	1365841 1508534					50 005 601	
R 144						30	
01.1996→08.2001	DSC 14.13, DSC 14.15						
Reference	1365841 1508534					50 005 601	

S

**T 144****31**

02.1997→08.2001 DSC 14.13, DSC 14.15
 Reference 1365841 1508534

**50 005 601****B 110****32**

10.1969→12.1976 DS 11
 Reference 0301473 1318091

**50 005 832****Century 12.35****33**

05.1996→ DSC 12.05
 Reference 1353072 1508533

**50 005 214****CR 110****34**

10.1969→04.1971 DS 11
 Reference 0301473 1318091

**50 005 832****L 110****35**

02.1968→12.1974 DS 11
 Reference 0301473 1318091

**50 005 832****LB 110****36**

02.1968→12.1974 DS 11
 Reference 0301473 1318091

**50 005 832****LBS 110****37**

02.1968→12.1974 DS 11
 Reference 0301473 1318091

**50 005 832****LBT 110****38**

02.1968→12.1974 DS 11
 Reference 0301473 1318091

**50 005 832****LS 110****39**

02.1968→12.1974 DS 11
 Reference 0301473 1318091

**50 005 832****LT 110****40**



02.1968→12.1974 DS 11
 Reference 0301473 1318091

**50 005 832****S**







Engine



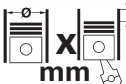

41

04.1981→ Reference	DS 11.15, DS 11.34, DSC 11.18 0301473 1318091		50 005 832	
→ Reference	DSC 12.06 1353072 1508533			50 005 214
10.1994→ Reference	DSC 14.13 1365841 1508534			50 005 601



			Cyl	 mm	cm ³		Comp. Ratio ε	kW	PS	Pos
100 GL.0N.0	B		4	65 x 68	903	2	9:1	33	45	1
100 GL.9N.0	B		4	65 x 68	903	2	9:1	33	45	1
146 A.000	B		4	65 x 68	903	2	9:1	33	45	38
1F	B		4	81 x 77,4	1595	2	9:1	55	75	18, 27, 48, 62, 82
1Y	D	(AN)	4	79,5 x 95,5	1896	2	22,5:1	47	64	32, 54, 64, 89
1Z	D	(LA)	4	79,5 x 95,5	1896	2	19,5:1	66	90	5, 34, 57, 91
2E	B		4	82,5 x 92,8	1984	2	10,5:1	85	115	36, 58, 92
2G	B		4	75 x 72	1272	2	9:1	40	54	22, 43
AAU	B		4	75 x 59	1043	2	10:1	33	45	41
AAV	B		4	75 x 72	1272	2	9,2:1	40	54	43
AAZ	D	(A)	4	79,5 x 95,5	1896	2	22,5:1	55	75	33, 56, 90
ABD	B		4	75 x 78,7	1391	2	9,2:1	44	60	23, 44
ABF	B		4	82,5 x 92,8	1984	4	10,4:1	110	150	37, 59, 93
ABN	B		4	81 x 77,4	1595	2	9:1	55	75	82
ABS	B		4	81 x 86,4	1781	2	10:1	66	90	29, 50, 85
ABU	B		4	76,5 x 86,9	1598	2	9,3:1	55	75	27, 48
ACC	B		4	81 x 86,4	1781	2	10:1	66	90	29, 50, 85
ADL	B		4	81 x 86,4	1781	4	10,5:1	95	129	30, 51
ADY	B		4	82,5 x 92,8	1984	2	10,4:1	85	115	6
ADZ	B		4	81 x 86,4	1781	2	9/10:1	66	90	29, 50, 85
AEE	B		4	76,5 x 86,9	1598	2	9,8:1	55	75	27, 48, 62
AEH	B		4	81 x 77,4	1595	2	10,3:1	74	101	27, 48, 68, 82
AER	B		4	67,1 x 70,6	999	2	10,5:1	37	50	13, 19, 39
AEX	B		4	76,5 x 75,6	1390	2	10,2:1	40-44	55-60	14, 23, 44, 60
AEY	D	(AN)	4	79,5 x 95,5	1896	2	19,5:1	47	64	35, 55, 65
AFH	B		4	76,5 x 75,6	1390	4	10,5:1	74	101	24, 45
AFK	B		4	76,5 x 75,6	1390	4	10,5:1	74	101	15
AFN	D	(LA)	4	79,5 x 95,5	1896	2	19,5:1	81	110	5, 34, 57, 91
AFT	B		4	81 x 77,4	1595	2	10,5:1	74	101	27, 48, 82
AGG	B		4	82,5 x 92,8	1984	2	10:1	85	115	36, 58, 92
AGN	B		4	81 x 86,4	1781	5		92	125	71, 87
AGP	D	(AN)	4	79,5 x 95,5	1896	2	22,5:1	50	68	35, 55
AGR	D	(LA)	4	79,5 x 95,5	1896	2	19,5:1	66	90	34, 57, 74, 91
AGZ	B		5	81 x 90,2	2324	4	10,1:1	110	150	96
AHB	D	(AN)	4	79,5 x 86,4	1716	2	19,5:1	42	57	63
AHF	D	(LA)	4	79,5 x 95,5	1896	2	19,5:1	81	110	74, 91
AHT	B		4	67,1 x 70,6	999	2	10,7:1	37	50	13
AHU	D	(A)	4	79,5 x 95,5	1896	2	19,5:1	66	90	5, 34, 57, 91
AHW	B		4	76,5 x 75,6	1390	4	10,5:1	55	75	66, 80
AJH	B	(LA)	4	81 x 86,4	1781	5	9,5:1	110	150	4
AJQ	B	(LA)	4	81 x 86,4	1781	5	9,5:1	132	180	72
AKK	B		4	76,5 x 75,6	1390	2	10,4:1	44	60	14, 23, 44
AKL	B		4	81 x 77,4	1595	2	10,2:1	74	101	27, 48, 68, 82
AKU	D	(AN)	4	79,5 x 86,4	1716	2	19,5:1	44	60	17
AKV	B		4	76,5 x 75,6	1390	2	10,2:1	44	60	14, 23, 44, 60
ALD	B		4	67,1 x 70,6	999	2	10,7:1	37	50	13, 19, 39
ALH	D	(A)	4	79,5 x 95,5	1896	2	19,5:1	66	90	34, 57, 74, 91
ALL	B		4	67,1 x 70,6	999	2	10,7:1	37	50	13
ALM	B			76,5 x 86,9	1598	2	9,8:1	55	75	27, 48
AMF	D	(LA)	3	79,5 x 95,5	1422	2	19,5:1	55	75	16, 26, 47
AMK	B	(LA)	4	81 x 86,4	1781	5	9,5:1	154	210	73
ANU	D	(LA)	4	79,5 x 95,5	1896	2	19,5:1	66	90	5
ANV	B		4	67,1 x 70,6	999	2	10,7:1	37	50	13, 19, 39
ANW	B		4	76,5 x 75,6	1390	2	10,4:1	44	60	14, 23, 44
ANX	B		4	76,5 x 75,6	1390	2	10,2:1	40	54	23, 44
APE	B		4	76,5 x 75,6	1390	4	10,5:1	55	75	24, 45, 66
APF	B		4	81 x 77,4	1595	2	10,3:1	74	101	27, 48
APG	B		4	81 x 86,4	1781	5	10,3:1	92	125	71, 87
APP	B	(LA)	4	81 x 86,4	1781	5	9,5:1	132	180	72
APQ	B		4	76,5 x 75,6	1390	2	10,2:1	44	60	14, 23, 44, 60
AQM	D	(LA)	4	79,5 x 95,5	1896	2	19,5:1	50	68	35, 55, 75
AQN	B		5	81 x 90,2	2324	5	10,8:1	125	170	97
AQQ	B		4	76,5 x 75,6	1390	4	10,5:1	74	101	15, 24, 45
AQX	B	(A)	4	81 x 86,4	1781	5	9,5:1	115	156	31, 52
ARL	D	(LA)	4	79,5 x 95,5	1896	2	19,5:1	110	150	74, 91
ARY	B	(LA)	4	81 x 86,4	1781	5	9,5:1	132	180	72
AST	B		4	67,1 x 70,6	999	4	10,5:1	51	70	20, 40
ASV	D	(LA)	4	79,5 x 95,5	1896	2	19,5:1	81	110	34, 57, 74, 91
ASY	D	(AN)	4	79,5 x 95,5	1896	2	19,5:1	47	64	35, 55

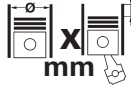

			Cyl	 mm	cm ³	 Comp. Ratio ε	kW	PS	Pos
ASZ	D	(LA)	4	79,5 x 95,5	1896	2 19:1	96	130	5, 34, 57, 74, 91
ATD	D	(LA)	4	79,5 x 95,5	1896	2 19:1	74	101	34, 57
ATM	B		4	82,5 x 92,8	1984	2 10:1	85	115	6
AUA	B		4	76,5 x 75,6	1390	4 10,5:1	55	75	24, 45, 61
AUB	B		4	76,5 x 75,6	1390	4 10,5:1	74	101	15, 24, 45
AUC	B		4	67,1 x 70,6	999	2 10,7:1	37	50	13, 19, 39
AUD	B		4	76,5 x 75,6	1390	2 10,4:1	44	60	14, 23, 44, 60
AUE	B		6	81 x 90,3	2792	4 10,75:1	150	204	7, 78
AUQ	B	(LA)	4	81 x 86,4	1781	5 9,5:1	132	180	72, 88
AUR	B		4	81 x 77,4	1595	2 10,3:1	74	101	27, 48
AUS	B		4	76,5 x 86,9	1598	4 11,5:1	77	105	70, 83
AUY	D	(LA)	4	79,5 x 95,5	1896	2 18:1	85	115	5
AVZ	B		4	67,1 x 70,6	999	4 10,5:1	51	70	20, 40
AWC	B	(LA)	4	81 x 86,4	1781	5 9,5:1	110	150	4
AXP	B		4	76,5 x 75,6	1390	4 10,5:1	55	75	66, 80
AXR	D	(LA)	4	79,5 x 95,5	1896	2 19:1	74	101	34, 57, 74
AYL	B		6	81 x 90,3	2792	4 10,5:1	150	204	7
AYP	B	(A)	4	81 x 86,4	1781	5 9,5:1	115	156	52
AYQ	D	(AN)	4	79,5 x 95,5	1896	2 19,5:1	47	64	65
AZD	B		4	76,5 x 86,9	1598	4 11,5:1	77	105	70, 83
AZL	B		4	82,5 x 92,8	1984	2 10,5:1	85	115	36, 58
AZQ	B		3	76,5 x 86,9	1198	4 10,5:1	47	64	21, 42
AZV	D	(LA)	4	81 x 95,5	1968	4 18:1	100	136	12, 77, 95
BAM	B	(LA)	4	81 x 86,4	1781	5 9:1	165	225	73
BBU	B	(LA)	4	81 x 86,4	1781	5 9,5:1	132	179	53
BBX	B		4	82,5 x 92,8	1984	2 10,5:1	85	116	36, 58
BBY	B		4	76,5 x 75,6	1390	4 10,5:1	55	75	24, 45
BBZ	B		4	76,5 x 75,6	1390	4 10,5:1	74	101	24, 45
BCA	B		4	76,5 x 75,6	1390	4	55	75	66
BCB	B		4	76,5 x 86,9	1598	4 11,5:1	77	105	70, 83
BDE	B		6	81 x 90,3	2792	4 10,75:1	150	204	78
BFQ	B		4	81 x 77,4	1595	2 10,2:1	75	102	68
BGU	B		4	81 x 77,4	1595	2 10,5:1	75	102	9, 84
BJB	D	(LA)	4	79,5 x 95,5	1896	2 19:1	77	105	10, 91
BJX	B	(LA)	4	81 x 86,4	1781	5 9,5:1	110	150	52
BKC	D	(LA)	4	79,5 x 95,5	1896	2 19:1	77	105	10, 74, 91
BKD	D	(LA)	4	81 x 95,5	1968	4 18:1	103	140	12, 77, 95
BKV	B		4	81 x 86,4	1781	5 9,5:1	110	150	52
BKY	B		4	76,5 x 75,6	1390	4 10,5:1	55	75	24, 45
BLR	B		4	82,5 x 92,8	1984	4 11,5:1	110	150	11, 76, 94
BLS	D	(LA)	4	79,5 x 95,5	1896	2 19:1	77	105	10, 57, 74, 91
BLT	D	(LA)	4	79,5 x 95,5	1896	2 19:1	96	130	34, 57
BLY	B		4	82,5 x 92,8	1984	4 11,5:1	110	150	11, 76, 94
BLZ	B	(LA)	4	81 x 86,4	1781	5 9,5:1	132	179	52
BMS	D	(LA)	3	79,5 x 95,5	1422	2 19,5:1	59	80	26, 47
BMT	D	(LA)	4	79,5 x 95,5	1896	2 19:1	74	101	34, 57
BNM	D	(LA)	3	79,5 x 95,5	1422	2 19,5:1	51	68	26, 47
BNV	D	(LA)	3	79,5 x 95,5	1422	2 19,5:1	58	80	26, 47
BSE	B		4	81 x 77,4	1595	2 10,3:1	75	102	9, 69, 84
BSF	B		4	81 x 77,4	1595	2 10,3:1	75	102	9, 69, 84
BTB	D	(LA)	4	79,5 x 95,5	1896	2 19:1	110	150	5
BTS	B		4	76,5 x 86,9	1598	4 11,5:1	77	105	28, 49
BVK	D	(LA)	4	79,5 x 95,5	1896	2 18:1	85	115	5
BVY	B		4	82,5 x 92,8	1984	4 11,5:1	110	150	11, 76, 94
BVZ	B		4	82,5 x 92,8	1984	4 11,5:1	110	150	11, 76, 94
BXE	D	(LA)	4	79,5 x 95,5	1896	2 19:1	77	105	10, 74, 91
BXF	D	(LA)	4	79,5 x 95,5	1896	2 19,5:1	66	90	74
BXJ	D	(LA)	4	79,5 x 95,5	1896	2 19,5:1	66	90	57
BXW	B		4	76,5 x 75,6	1390	4 10,5:1	63	86	8, 25, 46, 67, 81
EZ	B		4	81 x 77,4	1595	2 9:1	55	75	82
KR	B		4	81 x 86,4	1781	4 10:1	100	136	86
MN	D	(AN)	4	75 x 72	1272	2 22:1	33	45	79
OM 615.940	D	(AN)	4	87 x 83,6	1988	2	40	55	2, 3
PL	B		4	81 x 86,4	1781	4 10:1	95	129	86
RP	B		4	81 x 86,4	1781	2 10:1	66	90	85

**127****1**

05.1972→12.1980	100 GL.0N.0, 100 GL.9N.0						
Reference	4227634	4284907	46514517		50 005 816		



132 2.0 D**2**

05.1973→02.1979	OM 615.940 Lager/bearing/coussinet/cojinete/подшипник: 30 mm						50 005 932
05.1973→02.1979	OM 615.940 Lager/bearing/coussinet/cojinete/подшипник: 36 mm						50 005 032
05.1973→02.1979	OM 615.940 Lager/bearing/coussinet/cojinete/подшипник: 40 mm						50 005 035

2000 D**3**

05.1973→02.1979	OM 615.940 Lager/bearing/coussinet/cojinete/подшипник: 30 mm						50 005 932
05.1973→02.1979	OM 615.940 Lager/bearing/coussinet/cojinete/подшипник: 36 mm						50 005 032
05.1973→02.1979	OM 615.940 Lager/bearing/coussinet/cojinete/подшипник: 40 mm						50 005 035

Alhambra 1.8i Turbo 20V**4**

05.1998→	AJH, AWC						
Reference	06A 115 105	06A 115 105	06A 115 105	06A 115 105		50 005 819	
	06A 115 105 B	06A 115 105 B	06A 115 105 B	06A 115 105 B			
	06A 115 105 C	06A 115 105 C	06A 115 105 C	06A 115 105 C			
	06A 115 105 D	06A 115 105 D	06A 115 105 D	06A 115 105 D			
05.1998→	AJH, AWC						50 005 131

Alhambra 1.9 TDI**5**

03.1996→02.2000	1Z, AFN, AHU						
Reference	026 121 010	026 121 010 C	026 121 010 CV	026 121 010 CX			50 005 151
	026 121 010 F	026 121 010 FV	026 121 010 FX	026 121 010 V			
	026 121 010 X	037 121 010	037 121 010 A	037 121 010 AX			
	068 121 010 A	068 121 010 AX					
	mit Gegengehäuse/with backhousing/avec demi-corps/con remate/c задним корпусом						



SEAT



03.1996→02.2000 Reference	1Z, AFN, AHU 026 121 005 A 026 121 005 C 026 121 005 E 026 121 005 G 026 121 005 H 037 121 005 B 037 121 005 C 068 121 005 A ohne Gegengehäuse/without backhousing/sans demi-corps/sin remate/без заднего корпуса			50 005 148
06.2005→05.2007 Reference	BTB 045 121 011B 045 121 011F 045 121 011H 045 121 011HX			50 005 556
06.2000→ Reference	ANU 038 121 011 G			50 005 783
03.1996→02.2000 Reference	1Z, AFN, AHU 028 115 105 G 028 115 105 G 068 115 105 BK 068 115 105 BK			50 005 806
06.2000→ Reference	ANU, AUY, BVK 06A 115 105 06A 115 105 06A 115 105 06A 115 105 06A 115 105 B 06A 115 105 B 06A 115 105 B 06A 115 105 B 06A 115 105 C 06A 115 105 C 06A 115 105 C 06A 115 105 C 06A 115 105 D 06A 115 105 D 06A 115 105 D 06A 115 105 D			50 005 819
06.2000→ Reference	ASZ, AUY 038 121 001 C 038 121 011 C 038 121 011 D 038 121 011G 038 121 011J 038 121 011K 038 121 011KX			50 005 554
Alhambra 2.0i				6
03.1996→02.2000 Reference	ADY 026 121 010 026 121 010 C 026 121 010 CV 026 121 010 CX 026 121 010 F 026 121 010 FV 026 121 010 FX 026 121 010 V 026 121 010 X 037 121 010 037 121 010 A 037 121 010 AX 068 121 010 A 068 121 010 AX mit Gegengehäuse/with backhousing/avec demi-corps/con remate/с задним корпусом			50 005 151
03.1996→02.2000 Reference	ADY 026 121 005 A 026 121 005 C 026 121 005 E 026 121 005 G 026 121 005 H 037 121 005 B 037 121 005 C 068 121 005 A ohne Gegengehäuse/without backhousing/sans demi-corps/sin remate/без заднего корпуса			50 005 148
06.2000→ Reference	ATM 06A 115 105 06A 115 105 06A 115 105 06A 115 105 06A 115 105 B 06A 115 105 B 06A 115 105 B 06A 115 105 B 06A 115 105 C 06A 115 105 C 06A 115 105 C 06A 115 105 C 06A 115 105 D 06A 115 105 D 06A 115 105 D 06A 115 105 D			50 005 819
06.2000→ Reference	ATM			50 005 131

S





03.1996→02.2000 Reference	ADY 027 115 105 B 027 115 105 B			50 005 805
Alhambra 2.8i 24V				7
06.2000→ Reference 	AUE, AYL 021 121 004 021 121 004 A AYL: →ch. 7M-2-525 000			50 005 165
06.2000→ Reference 	AUE, AYL 022 121 011 AUE: F 7M-2-525 001→ AYL: ch. 7M-2-525 001→			50 005 008 NEW
Altea 1.4 SRE 16V				8
05.2006→ Reference	BXW 036 115 105 B 036 115 105 B 036 115 105 B 036 115 105 B 036 115 105 D 036 115 105 D 036 115 105 D 036 115 105 D			50 005 844
Altea 1.6 SRE				9
03.2004→ Reference	BGU, BSE, BSF 06B 121 011 H 06B 121 011 L 06B 121 011 LX 06B 121 011 M			50 005 775
03.2004→ Reference	BGU, BSE, BSF 06A 115 105 06A 115 105 06A 115 105 06A 115 105 06A 115 105 B 06A 115 105 B 06A 115 105 B 06A 115 105 B 06A 115 105 C 06A 115 105 C 06A 115 105 C 06A 115 105 C 06A 115 105 D 06A 115 105 D 06A 115 105 D 06A 115 105 D			50 005 819
Altea 1.9 TDI				10
04.2004→ Reference	BJB, BKC, BLS, BXE 045 121 011 B 045 121 011 F 045 121 011 H 045 121 011 HX			50 005 556
Altea 2.0 FSI 16V				11
05.2004→ Reference	BLR, BLY, BVY, BVZ 06B 121 011 H 06B 121 011 L 06B 121 011 LX 06B 121 011 M			50 005 775
Altea 2.0 TDI 16V				12
03.2004→ Reference	AZV, BKD 038 121 001 C 038 121 011 C 038 121 011 D 038 121 011 G 038 121 011 J 038 121 011 K 038 121 011 KX			50 005 554



**SEAT****Arosa 1.0i****13**

11.1998→02.2000 Reference	AHT 047 121 013 J						50 005 772
02.1997→06.2004 Reference	AER, ALD, ALL, ANV, AUC 030 121 005 S 030 121 008 A 030 121 008 C 030 121 008 CX 037 121 008 C						50 005 137
02.1997→06.2004 Reference	AER, ALL, AUC 036 115 105 B 036 115 105 B 036 115 105 B 036 115 105 B 036 115 105 D 036 115 105 D 036 115 105 D 036 115 105 D					50 005 844	

Arosa 1.4i**14**

07.1999→06.2004 Reference	AKK, ANW, AUD 030 121 005 S 030 121 008 A 030 121 008 C 030 121 008 CX 037 121 008 C						50 005 137
02.1997→09.1999 Reference	AEX, AKV, APQ 030 121 005 N 030 121 005 NV 030 121 005 NX 030 121 008 D 030 121 008 DX						50 005 139
02.1997→09.1999 Reference	AEX, AKV, APQ 036 115 105 B 036 115 105 B 036 115 105 B 036 115 105 B 036 115 105 D 036 115 105 D 036 115 105 D 036 115 105 D					50 005 844	

Arosa 1.4i 16V**15**

10.1999→06.2004 Reference	AFK, AQQ, AUB 036 121 005 B 036 121 005 E 036 121 005 Q 036 121 005 QX 036 121 005 S 036 121 008K 036 121 008L 036 121 008LX						50 005 154
10.1999→06.2004 Reference	AQQ, AUB 036 115 105 B 036 115 105 B 036 115 105 B 036 115 105 B 036 115 105 D 036 115 105 D 036 115 105 D 036 115 105 D					50 005 844	

Arosa 1.4 TDI**16**



10.1999→06.2004 Reference	AMF 045 121 011B 045 121 011F 045 121 011H 045 121 011HX →6H-3-000 001						50 005 556
------------------------------	---	--	--	--	---	--	------------

S







Arosa 1.7 SDI						17	
08.1997→10.2003 Reference	AKU 028 121 004	028 121 004 V	028 121 004 X				50 005 158
08.1997→10.2003 Reference	AKU 028 115 105 L					50 005 807	
City Golf 1.6i (CN)						18	
05.1994→06.1996 Reference	1F 026 121 010 026 121 010 F 026 121 010 X 068 121 010 A	026 121 010 C 026 121 010 FV 037 121 010 068 121 010 AX	026 121 010 CV 026 121 010 FX 037 121 010 A	026 121 010 CX 026 121 010 V 037 121 010 AX			50 005 151
	mit Gegengehäuse/with backhousing/avec demi-corps/con remate/c задним корпусом						
05.1994→06.1996 Reference	1F 026 121 005 A 026 121 005 H	026 121 005 C 037 121 005 B	026 121 005 E 037 121 005 C	026 121 005 G 068 121 005 A			50 005 148
	ohne Gegengehäuse/without backhousing/sans demi-corps/sin remate/без заднего корпуса						
Cordoba 1.0i						19	
06.1997→08.2002 Reference	AER, ALD, ANV, AUC 030 121 005 S 037 121 008 C	030 121 008 A	030 121 008 C	030 121 008 CX			50 005 137
Cordoba 1.0i 16V						20	
05.2000→08.2002 Reference	AST, AVZ 036 121 005 D	036 121 005 J	036 121 005 M				50 005 769
05.2000→08.2002 Reference	AST, AVZ 036 115 105 B 036 115 105 D	036 115 105 B 036 115 105 D	036 115 105 B 036 115 105 D	036 115 105 B 036 115 105 D		50 005 844	
	6K-X-400 000→6K-X-499 999						
Cordoba 1.2i 12V						21	
10.2002→ Reference	AZQ 03D 121 005	03D 121 013 B					50 005 770



**SEAT****Cordoba 1.3****22**

02.1993→07.1994	2G						
Reference	030 115 105 C 030 115 105 E	030 115 105 C 030 115 105 E	030 115 105 D	030 115 105 D		50 005 868	
02.1993→07.1994	2G						
Reference	030 121 004 A 030 121 005 LV	030 121 004 B 030 121 005 LX	030 121 005 H	030 121 005 L			50 005 153

Cordoba 1.4i**23**

06.1994→11.1995	ABD						
Reference	030 115 105 C 030 115 105 E →558154	030 115 105 C 030 115 105 E	030 115 105 D	030 115 105 D		50 005 868	
06.1994→11.1995	ABD						
Reference	030 121 004 A 030 121 005 LV	030 121 004 B 030 121 005 LX	030 121 005 H	030 121 005 L			50 005 153
08.1999→08.2002	AKK, ANW, AUD						
Reference	030 121 005 S 037 121 008 C	030 121 008 A	030 121 008 C	030 121 008 CX			50 005 137
09.1995→06.1999	AEX, AKV, ANX, APQ						
Reference	030 121 005 N 030 121 008 DX	030 121 005 NV	030 121 005 NX	030 121 008 D			50 005 139
12.1997→06.1999	ANX, APQ						
Reference	036 115 105 B 036 115 105 D	036 115 105 B 036 115 105 D	036 115 105 B 036 115 105 D	036 115 105 B 036 115 105 D		50 005 844	

S**Cordoba 1.4i 16V****24**

09.1999→	APE, AQQ, AUA, AUB, BBY, BBZ, BKY						
Reference	036 121 005 B 036 121 005 S	036 121 005 E 036 121 008K	036 121 005 Q 036 121 008L	036 121 005 QX 036 121 008LX			50 005 154
06.1997→06.1999	AFH						
Reference	036 121 005 D	036 121 005 J	036 121 005 M				50 005 769



09.1999→ Reference	APE, AUA, BBY, BBZ, BKY 036 115 105 B 036 115 105 B 036 115 105 B 036 115 105 B 036 115 105 D 036 115 105 D 036 115 105 D 036 115 105 D APE, AUA: 6K-X-400 000→6K-X-499 999		50 005 844	
Cordoba 1.4 SRE 16V				25
05.2006→ Reference	BXW 036 115 105 B 036 115 105 B 036 115 105 B 036 115 105 B 036 115 105 D 036 115 105 D 036 115 105 D 036 115 105 D		50 005 844	
Cordoba 1.4 TDI				26
10.2002→ Reference	AMF, BMS, BNM, BNV 045 121 011B 045 121 011F 045 121 011H 045 121 011HX			50 005 556
Cordoba 1.6i				27
09.1994→06.1999 Reference	1F, AFT 026 121 010 026 121 010 C 026 121 010 CV 026 121 010 CX 026 121 010 F 026 121 010 FV 026 121 010 FX 026 121 010 V 026 121 010 X 037 121 010 037 121 010 A 037 121 010 AX 068 121 010 A 068 121 010 AX mit Gegengehäuse/with backhousing/avec demi-corps/con remate/c задним корпусом			50 005 151
09.1994→06.1999 Reference	1F, AFT 027 115 105 027 115 105 027 115 105 E 027 115 105 E 049 115 105 A 049 115 105 A 055 115 105 D 055 115 105 D		50 005 808	
09.1994→06.1999 Reference	1F, AFT 026 121 005 A 026 121 005 C 026 121 005 E 026 121 005 G 026 121 005 H 037 121 005 B 037 121 005 C 068 121 005 A ohne Gegengehäuse/without backhousing/sans demi-corps/sin remate/без заднего корпуса			50 005 148
09.1993→08.1994 Reference	ABU 030 121 004 A 030 121 004 B 030 121 005 H 030 121 005 L 030 121 005 LV 030 121 005 LX			50 005 153
06.1999→08.2002 Reference	AEH, AKL, APF, AUR 06A 115 105 06A 115 105 06A 115 105 06A 115 105 06A 115 105 B 06A 115 105 B 06A 115 105 B 06A 115 105 B 06A 115 105 C 06A 115 105 C 06A 115 105 C 06A 115 105 C 06A 115 105 D 06A 115 105 D 06A 115 105 D 06A 115 105 D AEH, APF, AUR: 6K-X-400 000→6K-X-499 999		50 005 819	
05.1997→12.1998 Reference	AEE 030 121 005 N 030 121 005 NV 030 121 005 NX 030 121 008 D 030 121 008 DX			50 005 139



SEAT

09.1997→08.2002	ALM			
Reference	036 115 105 B 036 115 105 B 036 115 105 B 036 115 105 B 036 115 105 D 036 115 105 D 036 115 105 D 036 115 105 D 6K-X-400 000→6K-X-499 999			50 005 844
06.1999→08.2002	AEH, AKL, APF, AUR			50 005 130
Cordoba 1.6i 16V				28
11.2006→	BTS			
Reference	03C 121 005 B 03C 121 005 C			50 005 061 NEW
Cordoba 1.8i				29
09.1993→06.1999	ABS, ACC, ADZ			
Reference	026 121 010 026 121 010 C 026 121 010 CV 026 121 010 CX 026 121 010 F 026 121 010 FV 026 121 010 FX 026 121 010 V 026 121 010 X 037 121 010 037 121 010 A 037 121 010 AX 068 121 010 A 068 121 010 AX mit Gegengehäuse/with backhousing/avec demi-corps/con remate/c задним корпусом			50 005 151
09.1993→06.1999	ABS, ACC, ADZ			
Reference	027 115 105 027 115 105 027 115 105 E 027 115 105 E 049 115 105 A 049 115 105 A 055 115 105 D 055 115 105 D			50 005 808
09.1993→06.1999	ABS, ACC, ADZ			
Reference	026 121 005 A 026 121 005 C 026 121 005 E 026 121 005 G 026 121 005 H 037 121 005 B 037 121 005 C 068 121 005 A ohne Gegengehäuse/without backhousing/sans demi-corps/sin remate/без заднего корпуса			50 005 148
Cordoba 1.8i 16V				30
02.1994→06.1996	ADL			
Reference	026 121 010 026 121 010 C 026 121 010 CV 026 121 010 CX 026 121 010 F 026 121 010 FV 026 121 010 FX 026 121 010 V 026 121 010 X 037 121 010 037 121 010 A 037 121 010 AX 068 121 010 A 068 121 010 AX mit Gegengehäuse/with backhousing/avec demi-corps/con remate/c задним корпусом			50 005 151
02.1994→06.1996	ADL			
Reference	026 121 005 A 026 121 005 C 026 121 005 E 026 121 005 G 026 121 005 H 037 121 005 B 037 121 005 C 068 121 005 A ohne Gegengehäuse/without backhousing/sans demi-corps/sin remate/без заднего корпуса			50 005 148
02.1994→06.1996	ADL			
Reference	027 115 105 A 027 115 105 A 027 115 105 C 027 115 105 C 068 115 105 AG 068 115 105 AG 068 115 105 Q 068 115 105 Q			50 005 803

S



Cordoba 1.8i Turbo 20V								31	
12.1999→10.2000	AQX								
Reference	06A 115 105	06A 115 105	06A 115 105	06A 115 105			50 005 819		
	06A 115 105 B	06A 115 105 B	06A 115 105 B	06A 115 105 B					
	06A 115 105 C	06A 115 105 C	06A 115 105 C	06A 115 105 C					
	06A 115 105 D	06A 115 105 D	06A 115 105 D	06A 115 105 D					
	6K-X-400 000→6K-X-499 999								
12.1999→10.2000	AQX							50 005 131	
Cordoba 1.9 D								32	
09.1993→06.1999	1Y								
Reference	026 121 010	026 121 010 C	026 121 010 CV	026 121 010 CX			50 005 151		
	026 121 010 F	026 121 010 FV	026 121 010 FX	026 121 010 V					
	026 121 010 X	037 121 010	037 121 010 A	037 121 010 AX					
	068 121 010 A	068 121 010 AX							
	mit Gegengehäuse/with backhousing/avec demi-corps/con remate/c задним корпусом								
09.1993→06.1999	1Y								
Reference	026 121 005 A	026 121 005 C	026 121 005 E	026 121 005 G			50 005 148		
	026 121 005 H	037 121 005 B	037 121 005 C	068 121 005 A					
	ohne Gegengehäuse/without backhousing/sans demi-corps/sin remate/без заднего корпуса								
09.1993→06.1999	1Y								
Reference	028 115 105 G	028 115 105 G	068 115 105 BK	068 115 105 BK			50 005 806		
Cordoba 1.9 TD								33	
09.1993→08.1997	AAZ								
Reference	026 121 010	026 121 010 C	026 121 010 CV	026 121 010 CX			50 005 151		
	026 121 010 F	026 121 010 FV	026 121 010 FX	026 121 010 V					
	026 121 010 X	037 121 010	037 121 010 A	037 121 010 AX					
	068 121 010 A	068 121 010 AX							
	mit Gegengehäuse/with backhousing/avec demi-corps/con remate/c задним корпусом								
09.1993→08.1997	AAZ								
Reference	026 121 005 A	026 121 005 C	026 121 005 E	026 121 005 G			50 005 148		
	026 121 005 H	037 121 005 B	037 121 005 C	068 121 005 A					
	ohne Gegengehäuse/without backhousing/sans demi-corps/sin remate/без заднего корпуса								
09.1993→08.1997	AAZ								
Reference	028 115 105 G	028 115 105 G	068 115 105 BK	068 115 105 BK			50 005 806		
Cordoba 1.9 TDI								34	
07.1996→06.1999	1Z, AFN, AHU								
Reference	026 121 010	026 121 010 C	026 121 010 CV	026 121 010 CX			50 005 151		
	026 121 010 F	026 121 010 FV	026 121 010 FX	026 121 010 V					
	026 121 010 X	037 121 010	037 121 010 A	037 121 010 AX					
	068 121 010 A	068 121 010 AX							
	mit Gegengehäuse/with backhousing/avec demi-corps/con remate/c задним корпусом								



03.1999→08.2002 Reference	AGR, ALH, ASV	038 121 011	038 121 011 A	038 121 011 AV	038 121 011AX		50 005 132
07.1996→06.1999 Reference	1Z, AFN, AHU	026 121 005 A 026 121 005 H	026 121 005 C 037 121 005 B	026 121 005 E 037 121 005 C	026 121 005 G 068 121 005 A		50 005 148
		ohne Gegengehäuse/without backhousing/sans demi-corps/sin remate/без заднего корпуса					
09.2002→ Reference	ATD, BLT, BMT	045 121 011B	045 121 011F	045 121 011H	045 121 011HX		50 005 556
07.1996→06.1999 Reference	1Z, AFN, AHU	028 115 105 G	028 115 105 G	068 115 105 BK	068 115 105 BK		50 005 806
03.1999→ Reference	AGR, ALH, ASV, ATD, AXR	06A 115 105 06A 115 105 B 06A 115 105 C 06A 115 105 D	06A 115 105 06A 115 105 B 06A 115 105 C 06A 115 105 D	06A 115 105 06A 115 105 B 06A 115 105 C 06A 115 105 D	06A 115 105 06A 115 105 B 06A 115 105 C 06A 115 105 D		50 005 819
		ALH, ASV: 6K-X-400 000→6K-X-499 999					
10.2002→ Reference	ASZ	038 121 001 C 038 121 011J	038 121 011 C 038 121 011K	038 121 011 D 038 121 011KX	038 121 011G		50 005 554
Cordoba 1.9 SDI							35
09.1995→06.1999 Reference	AEY	026 121 010 026 121 010 F 026 121 010 X 068 121 010 A	026 121 010 C 026 121 010 FV 037 121 010 068 121 010 AX	026 121 010 CV 026 121 010 FX 037 121 010 A	026 121 010 CX 026 121 010 V 037 121 010 AX		50 005 151
		mit Gegengehäuse/with backhousing/avec demi-corps/con remate/с задним корпусом 09.1996→					
04.1999→08.2002 Reference	AGP, AQM	038 121 011	038 121 011 A	038 121 011 AV	038 121 011AX		50 005 132
09.1995→06.1999 Reference	AEY	026 121 005 A 026 121 005 H	026 121 005 C 037 121 005 B	026 121 005 E 037 121 005 C	026 121 005 G 068 121 005 A		50 005 148
		ohne Gegengehäuse/without backhousing/sans demi-corps/sin remate/без заднего корпуса					
09.1995→06.1999 Reference	AEY	028 115 105 G	028 115 105 G	068 115 105 BK	068 115 105 BK		50 005 806



04.1999→ Reference	AGP, AQM, ASY	06A 115 105 06A 115 105 B 06A 115 105 C 06A 115 105 D	06A 115 105 06A 115 105 B 06A 115 105 C 06A 115 105 D	06A 115 105 06A 115 105 B 06A 115 105 C 06A 115 105 D	06A 115 105 06A 115 105 B 06A 115 105 C 06A 115 105 D	 50 005 819
09.2002→ Reference	ASY	045 121 011 C	045 121 011 G			 50 005 750
Cordoba 2.0i						36
09.1993→06.1999 Reference	2E, AGG	026 121 010 026 121 010 F 026 121 010 X 068 121 010 A	026 121 010 C 026 121 010 FV 037 121 010 068 121 010 AX	026 121 010 CV 026 121 010 FX 037 121 010 A	026 121 010 CX 026 121 010 V 037 121 010 AX	 50 005 151
		mit Gegengehäuse/with backhousing/avec demi-corps/con remate/c задним корпусом				
09.1993→06.1999 Reference	2E, AGG	026 121 005 A 026 121 005 H	026 121 005 C 037 121 005 B	026 121 005 E 037 121 005 C	026 121 005 G 068 121 005 A	 50 005 148
		ohne Gegengehäuse/without backhousing/sans demi-corps/sin remate/без заднего корпуса				
09.2002→ Reference	AZL, BBX	06A 115 105 06A 115 105 B 06A 115 105 C 06A 115 105 D	06A 115 105 06A 115 105 B 06A 115 105 C 06A 115 105 D	06A 115 105 06A 115 105 B 06A 115 105 C 06A 115 105 D	06A 115 105 06A 115 105 B 06A 115 105 C 06A 115 105 D	 50 005 819
09.2002→	AZL, BBX					 50 005 131
09.1993→06.1999 Reference	2E, AGG	027 115 105 B	027 115 105 B			 50 005 805
Cordoba 2.0i 16V						37
07.1996→06.1999 Reference	ABF	026 121 010 026 121 010 F 026 121 010 X 068 121 010 A	026 121 010 C 026 121 010 FV 037 121 010 068 121 010 AX	026 121 010 CV 026 121 010 FX 037 121 010 A	026 121 010 CX 026 121 010 V 037 121 010 AX	 50 005 151
		mit Gegengehäuse/with backhousing/avec demi-corps/con remate/c задним корпусом				
07.1996→06.1999 Reference	ABF	051 115 105 A	051 115 105 A			 50 005 801
07.1996→06.1999 Reference	ABF	026 121 005 A 026 121 005 H	026 121 005 C 037 121 005 B	026 121 005 E 037 121 005 C	026 121 005 G 068 121 005 A	 50 005 148
		ohne Gegengehäuse/without backhousing/sans demi-corps/sin remate/без заднего корпуса				







SEAT



Ibiza 0.9 38				
08.1986→05.1993 Reference	146 A.000 4227634	4284907	46514517	 50 005 816
Ibiza 1.0i 39				
09.1996→05.2002 Reference	AER, ALD, ANV, AUC 030 121 005 S 037 121 008 C	030 121 008 A	030 121 008 C	030 121 008 CX 50 005 137
Ibiza 1.0i 16V 40				
05.2000→05.2002 Reference	AST, AVZ 036 121 005 D	036 121 005 J	036 121 005 M	 50 005 769
06.2000→05.2002 Reference	AST 036 115 105 B 036 115 105 D 6K-X-400 000→6K-X-499 999	036 115 105 B 036 115 105 D	036 115 105 B 036 115 105 D	036 115 105 B 036 115 105 D 50 005 844
Ibiza 1.05i 41				
02.1993→06.1996 Reference	AAU 030 115 105 C 030 115 105 E	030 115 105 C 030 115 105 E	030 115 105 D	030 115 105 D 50 005 868
02.1993→06.1996 Reference	AAU 030 121 004 A 030 121 005 LV	030 121 004 B 030 121 005 LX	030 121 005 H	030 121 005 L 50 005 153
Ibiza 1.2i 12V 42				
01.2002→ Reference	AZQ 03D 121 005 6L-2-000 001→	03D 121 013 B		 50 005 770
Ibiza 1.3 43				
02.1993→08.1994 Reference	2G, AAV 030 115 105 C 030 115 105 E	030 115 105 C 030 115 105 E	030 115 105 D	030 115 105 D 50 005 868
02.1993→08.1994 Reference	2G, AAV 030 121 004 A 030 121 005 LV	030 121 004 B 030 121 005 LX	030 121 005 H	030 121 005 L 50 005 153

S

**Ibiza 1.4i****44**

09.1993→11.1995	ABD							
Reference	030 115 105 C 030 115 105 E →558154	030 115 105 C 030 115 105 E	030 115 105 D	030 115 105 D		50 005 868		
09.1993→11.1995	ABD							
Reference	030 121 004 A 030 121 005 LV	030 121 004 B 030 121 005 LX	030 121 005 H	030 121 005 L			50 005 153	
08.1999→05.2002	AKK, ANW, AUD							
Reference	030 121 005 S 037 121 008 C	030 121 008 A	030 121 008 C	030 121 008 CX			50 005 137	
09.1995→06.1999	AEX, AKV, ANX, APQ							
Reference	030 121 005 N 030 121 008 DX	030 121 005 NV	030 121 005 NX	030 121 008 D			50 005 139	
12.1997→06.1999	ANX, APQ							
Reference	036 115 105 B 036 115 105 D	036 115 105 B 036 115 105 D	036 115 105 B 036 115 105 D	036 115 105 B 036 115 105 D		50 005 844		

Ibiza 1.4i 16V**45**

09.1999→	APE, AQQ, AUA, AUB, BBY, BBZ, BKY							
Reference	036 121 005 B 036 121 005 S	036 121 005 E 036 121 008K	036 121 005 Q 036 121 008L	036 121 005 QX 036 121 008LX			50 005 154	
06.1997→06.1999	AFH							
Reference	036 121 005 D	036 121 005 J	036 121 005 M				50 005 769	
09.1999→	APE, AQQ, AUA, AUB, BBY, BBZ, BKY							
Reference	036 115 105 B 036 115 105 D	036 115 105 B 036 115 105 D	036 115 105 B 036 115 105 D	036 115 105 B 036 115 105 D		50 005 844		
	APE, AQQ, AUA, AUB: 6K-X-400 000→6K-X-499 999 BBY, BBZ, BKY: 6L-2-000 001→							

Ibiza 1.4 SRE 16V**46**

05.2006→	BXW							
Reference	036 115 105 B 036 115 105 D	036 115 105 B 036 115 105 D	036 115 105 B 036 115 105 D	036 115 105 B 036 115 105 D		50 005 844		

**SEAT****Ibiza 1.4 TDI****47**

05.2002→

AMF, BMS, BNM, BNV

Reference

045 121 011B 045 121 011F 045 121 011H 045 121 011HX
AMF: 6L-3-000 001→**50 005 556****Ibiza 1.6i****48**

09.1994→06.1999

1F, AFT

Reference

026 121 010 026 121 010 C 026 121 010 CV 026 121 010 CX
026 121 010 F 026 121 010 FV 026 121 010 FX 026 121 010 V
026 121 010 X 037 121 010 037 121 010 A 037 121 010 AX
068 121 010 A 068 121 010 AX

mit Gegengehäuse/with backhousing/avec demi-corps/con remate/c задним корпусом

**50 005 151**

09.1994→06.1999

1F, AFT

Reference

027 115 105 027 115 105 027 115 105 E 027 115 105 E
049 115 105 A 049 115 105 A 055 115 105 D 055 115 105 D**50 005 808**

09.1994→06.1999

1F, AFT

Reference

026 121 005 A 026 121 005 C 026 121 005 E 026 121 005 G
026 121 005 H 037 121 005 B 037 121 005 C 068 121 005 A

ohne Gegengehäuse/without backhousing/sans demi-corps/sin remate/без заднего корпуса

**50 005 148**

02.1993→08.1994

ABU

Reference

030 121 004 A 030 121 004 B 030 121 005 H 030 121 005 L
030 121 005 LV 030 121 005 LX**50 005 153**

06.1999→05.2002

AEH, AKL, APF, AUR

Reference

06A 115 105 06A 115 105 06A 115 105 06A 115 105
06A 115 105 B 06A 115 105 B 06A 115 105 B 06A 115 105 B
06A 115 105 C 06A 115 105 C 06A 115 105 C 06A 115 105 C
06A 115 105 D 06A 115 105 D 06A 115 105 D 06A 115 105 D
6K-X-400 000→6K-X-499 999**50 005 819**

09.1997→12.1998

AEE

Reference

030 121 005 N 030 121 005 NV 030 121 005 NX 030 121 008 D
030 121 008 DX**50 005 139****S**

09.1997→05.2002

ALM

Reference

036 115 105 B 036 115 105 B 036 115 105 B 036 115 105 B
036 115 105 D 036 115 105 D 036 115 105 D 036 115 105 D
6K-X-400 000→6K-X-499 999**50 005 844**

06.1999→05.2002

AEH, AKL, APF, AUR

**50 005 130**

**Ibiza 1.6i 16V****49**

11.2006→ Reference	BTS 03C 121 005 B 03C 121 005 C			50 005 061 NEW
-----------------------	---------------------------------------	---	--	---------------------------------

Ibiza 1.8i**50**

02.1993→06.1999 Reference	ABS, ACC, ADZ 026 121 010 026 121 010 C 026 121 010 CV 026 121 010 CX 026 121 010 F 026 121 010 FV 026 121 010 FX 026 121 010 V 026 121 010 X 037 121 010 037 121 010 A 037 121 010 AX 068 121 010 A 068 121 010 AX mit Gegengehäuse/with backhousing/avec demi-corps/con remate/c задним корпусом			50 005 151
------------------------------	---	---	--	-------------------

02.1993→06.1999 Reference	ABS, ACC, ADZ 027 115 105 027 115 105 027 115 105 E 027 115 105 E 049 115 105 A 049 115 105 A 055 115 105 D 055 115 105 D			50 005 808
------------------------------	---	---	--	-------------------

02.1993→06.1999 Reference	ABS, ACC, ADZ 026 121 005 A 026 121 005 C 026 121 005 E 026 121 005 G 026 121 005 H 037 121 005 B 037 121 005 C 068 121 005 A ohne Gegengehäuse/without backhousing/sans demi-corps/sin remate/без заднего корпуса			50 005 148
------------------------------	---	--	--	-------------------

Ibiza 1.8i 16V**51**

02.1994→06.1996 Reference	ADL 026 121 010 026 121 010 C 026 121 010 CV 026 121 010 CX 026 121 010 F 026 121 010 FV 026 121 010 FX 026 121 010 V 026 121 010 X 037 121 010 037 121 010 A 037 121 010 AX 068 121 010 A 068 121 010 AX mit Gegengehäuse/with backhousing/avec demi-corps/con remate/c задним корпусом			50 005 151
------------------------------	---	---	--	-------------------

02.1994→06.1996 Reference	ADL 026 121 005 A 026 121 005 C 026 121 005 E 026 121 005 G 026 121 005 H 037 121 005 B 037 121 005 C 068 121 005 A ohne Gegengehäuse/without backhousing/sans demi-corps/sin remate/без заднего корпуса			50 005 148
------------------------------	---	---	--	-------------------

02.1994→06.1996 Reference	ADL 027 115 105 A 027 115 105 A 027 115 105 C 027 115 105 C 068 115 105 AG 068 115 105 AG 068 115 105 Q 068 115 105 Q			50 005 803
------------------------------	---	---	--	-------------------

Ibiza 1.8i Turbo 20V**52**

12.1999→ Reference	AQX, AYP, BJX, BKV, BLZ 06A 115 105 06A 115 105 06A 115 105 06A 115 105 06A 115 105 B 06A 115 105 B 06A 115 105 B 06A 115 105 B 06A 115 105 C 06A 115 105 C 06A 115 105 C 06A 115 105 C 06A 115 105 D 06A 115 105 D 06A 115 105 D 06A 115 105 D AQX, AYP: 6K-X-400 000→6K-X-499 999 BJX, BKV, BLZ: 6L-2-000 001→			50 005 819
-----------------------	--	---	--	-------------------

12.1999→	AQX, BJX			50 005 131
----------	----------	---	--	-------------------



SEAT

**Ibiza 1.8i Cupra 20V****53**

05.2004→	BBU						
Reference	06A 115 105 06A 115 105 B 06A 115 105 C 06A 115 105 D 6L-2-000 001→	06A 115 105 06A 115 105 B 06A 115 105 C 06A 115 105 D	06A 115 105 06A 115 105 B 06A 115 105 C 06A 115 105 D	06A 115 105 06A 115 105 B 06A 115 105 C 06A 115 105 D		50 005 819	
05.2004→	BBU						50 005 131

Ibiza 1.9 D**54**

02.1993→06.1999	1Y						
Reference	026 121 010 026 121 010 F 026 121 010 X 068 121 010 A mit Gegengehäuse/with backhousing/avec demi-corps/con remate/с задним корпусом	026 121 010 C 026 121 010 FV 037 121 010 068 121 010 AX	026 121 010 CV 026 121 010 FX 037 121 010 A	026 121 010 CX 026 121 010 V 037 121 010 AX		50 005 151	
02.1993→06.1999	1Y						50 005 148
Reference	026 121 005 A 026 121 005 H ohne Gegengehäuse/without backhousing/sans demi-corps/sin remate/без заднего корпуса	026 121 005 C 037 121 005 B	026 121 005 E 037 121 005 C	026 121 005 G 068 121 005 A			
02.1993→06.1999	1Y					50 005 806	
Reference	028 115 105 G 028 115 105 G 068 115 105 BK 068 115 105 BK						

Ibiza 1.9 SDI**55**

09.1995→06.1999	AEY						
Reference	026 121 010 026 121 010 F 026 121 010 X 068 121 010 A mit Gegengehäuse/with backhousing/avec demi-corps/con remate/с задним корпусом 09.1996→	026 121 010 C 026 121 010 FV 037 121 010 068 121 010 AX	026 121 010 CV 026 121 010 FX 037 121 010 A	026 121 010 CX 026 121 010 V 037 121 010 AX		50 005 151	
04.1999→05.2002	AGP, AQM						50 005 132
Reference	038 121 011 038 121 011 A 038 121 011 AV 038 121 011AX						
09.1995→06.1999	AEY						50 005 148
Reference	026 121 005 A 026 121 005 H ohne Gegengehäuse/without backhousing/sans demi-corps/sin remate/без заднего корпуса	026 121 005 C 037 121 005 B	026 121 005 E 037 121 005 C	026 121 005 G 068 121 005 A			
09.1995→06.1999	AEY					50 005 806	
Reference	028 115 105 G 028 115 105 G 068 115 105 BK 068 115 105 BK						

S



04.1999→ Reference	AGP, AQM, ASY	06A 115 105 06A 115 105 B 06A 115 105 C 06A 115 105 D	06A 115 105 06A 115 105 B 06A 115 105 C 06A 115 105 D	06A 115 105 06A 115 105 B 06A 115 105 C 06A 115 105 D		50 005 819		
		AGP, AQM: 6K-X-400 000→6K-X-499 999 ASY: 6L-2-000 001→						
01.2002→ Reference	ASY	045 121 011 C	045 121 011 G				50 005 750	
Ibiza 1.9 TD							56	
02.1993→08.1997 Reference	AAZ	026 121 010 026 121 010 F 026 121 010 X 068 121 010 A	026 121 010 C 026 121 010 FV 037 121 010 068 121 010 AX	026 121 010 CV 026 121 010 FX 037 121 010 A	026 121 010 CX 026 121 010 V 037 121 010 AX		50 005 151	
		mit Gegengehäuse/with backhousing/avec demi-corps/con remate/c задним корпусом						
02.1993→08.1997 Reference	AAZ	026 121 005 A 026 121 005 H	026 121 005 C 037 121 005 B	026 121 005 E 037 121 005 C	026 121 005 G 068 121 005 A		50 005 148	
		ohne Gegengehäuse/without backhousing/sans demi-corps/sin remate/без заднего корпуса						
02.1993→08.1997 Reference	AAZ	028 115 105 G	028 115 105 G	068 115 105 BK	068 115 105 BK		50 005 806	
Ibiza 1.9 TDI							57	
07.1996→06.1999 Reference	1Z, AFN, AHU	026 121 010 026 121 010 F 026 121 010 X 068 121 010 A	026 121 010 C 026 121 010 FV 037 121 010 068 121 010 AX	026 121 010 CV 026 121 010 FX 037 121 010 A	026 121 010 CX 026 121 010 V 037 121 010 AX		50 005 151	
		mit Gegengehäuse/with backhousing/avec demi-corps/con remate/c задним корпусом						
03.1997→06.1999 Reference	AFN	028 121 004	028 121 004 V	028 121 004 X			50 005 158	
03.1999→05.2002 Reference	AGR, ALH, ASV	038 121 011	038 121 011 A	038 121 011 AV	038 121 011 AX		50 005 132	
07.1996→06.1999 Reference	1Z, AFN, AHU	026 121 005 A 026 121 005 H	026 121 005 C 037 121 005 B	026 121 005 E 037 121 005 C	026 121 005 G 068 121 005 A		50 005 148	
		ohne Gegengehäuse/without backhousing/sans demi-corps/sin remate/без заднего корпуса						
09.2001→ Reference	ATD, AXR, BLS, BLT, BMT, BXJ	045 121 011B	045 121 011F	045 121 011H	045 121 011HX		50 005 556	



SEAT

07.1996→06.1999 Reference	1Z, AFN, AHU 028 115 105 G 028 115 105 G 068 115 105 BK 068 115 105 BK		50 005 806	
03.1999→ Reference	AGR, ALH, ASV, ATD, AXR 06A 115 105 06A 115 105 06A 115 105 06A 115 105 06A 115 105 B 06A 115 105 B 06A 115 105 B 06A 115 105 B 06A 115 105 C 06A 115 105 C 06A 115 105 C 06A 115 105 C 06A 115 105 D 06A 115 105 D 06A 115 105 D 06A 115 105 D AGR, ALH, ASV: 6K-X-400 000→6K-X-499 999 ATD: 6L-2-000 001→		50 005 819	
11.2001→ Reference	ASZ 038 121 001 C 038 121 011 C 038 121 011 D 038 121 011G 038 121 011J 038 121 011K 038 121 011KX			50 005 554
Ibiza 2.0i				58
02.1993→06.1999 Reference	2E, AGG 026 121 010 026 121 010 C 026 121 010 CV 026 121 010 CX 026 121 010 F 026 121 010 FV 026 121 010 FX 026 121 010 V 026 121 010 X 037 121 010 037 121 010 A 037 121 010 AX 068 121 010 A 068 121 010 AX mit Gegengehäuse/with backhousing/avec demi-corps/con remate/c задним корпусом			50 005 151
02.1993→06.1999 Reference	2E, AGG 026 121 005 A 026 121 005 C 026 121 005 E 026 121 005 G 026 121 005 H 037 121 005 B 037 121 005 C 068 121 005 A ohne Gegengehäuse/without backhousing/sans demi-corps/sin remate/без заднего корпуса			50 005 148
07.2002→ Reference	AZL, BBX 06A 115 105 06A 115 105 06A 115 105 06A 115 105 06A 115 105 B 06A 115 105 B 06A 115 105 B 06A 115 105 B 06A 115 105 C 06A 115 105 C 06A 115 105 C 06A 115 105 C 06A 115 105 D 06A 115 105 D 06A 115 105 D 06A 115 105 D 6L-2-000 001→		50 005 819	
07.2002→	AZL, BBX			50 005 131
02.1993→06.1999 Reference	2E, AGG 027 115 105 B 027 115 105 B		50 005 805	
Ibiza 2.0i 16V				59
07.1996→06.1999 Reference	ABF 026 121 010 026 121 010 C 026 121 010 CV 026 121 010 CX 026 121 010 F 026 121 010 FV 026 121 010 FX 026 121 010 V 026 121 010 X 037 121 010 037 121 010 A 037 121 010 AX 068 121 010 A 068 121 010 AX mit Gegengehäuse/with backhousing/avec demi-corps/con remate/c задним корпусом			50 005 151

S



07.1996→06.1999 Reference	ABF	051 115 105 A	051 115 105 A			50 005 801	
07.1996→06.1999 Reference	ABF	026 121 005 A 026 121 005 H	026 121 005 C 037 121 005 B	026 121 005 E 037 121 005 C	026 121 005 G 068 121 005 A		50 005 148
		ohne Gegengehäuse/without backhousing/sans demi-corps/sin remate/без заднего корпуса					
Inca 1.4i						60	
09.2000→06.2003 Reference	AUD	030 121 005 S 037 121 008 C	030 121 008 A	030 121 008 C	030 121 008 CX		50 005 137
11.1995→06.2003 Reference	AEX, AKV, APQ	030 121 005 N 030 121 008 DX	030 121 005 NV	030 121 005 NX	030 121 008 D		50 005 139
11.1995→06.2003 Reference	AEX, AKV, APQ	036 115 105 B 036 115 105 D	036 115 105 B 036 115 105 D	036 115 105 B 036 115 105 D	036 115 105 B 036 115 105 D		50 005 844
Inca 1.4i 16V						61	
09.2000→06.2003 Reference	AUA	036 121 005 B 036 121 005 S	036 121 005 E 036 121 008K	036 121 005 Q 036 121 008L	036 121 005 QX 036 121 008LX		50 005 154
09.2000→06.2003 Reference	AUA	036 115 105 B 036 115 105 D	036 115 105 B 036 115 105 D	036 115 105 B 036 115 105 D	036 115 105 B 036 115 105 D		50 005 844
Inca 1.6i						62	
11.1995→05.1997 Reference	1F	026 121 010 026 121 010 F 026 121 010 X 068 121 010 A	026 121 010 C 026 121 010 FV 037 121 010 068 121 010 AX	026 121 010 CV 026 121 010 FX 037 121 010 A	026 121 010 CX 026 121 010 V 037 121 010 AX		50 005 151
		mit Gegengehäuse/with backhousing/avec demi-corps/con remate/c задним корпусом					
11.1995→05.1997 Reference	1F	027 115 105 049 115 105 A	027 115 105 049 115 105 A	027 115 105 E 055 115 105 D	027 115 105 E 055 115 105 D		50 005 808
11.1995→05.1997 Reference	1F	026 121 005 A 026 121 005 H	026 121 005 C 037 121 005 B	026 121 005 E 037 121 005 C	026 121 005 G 068 121 005 A		50 005 148
		ohne Gegengehäuse/without backhousing/sans demi-corps/sin remate/без заднего корпуса					

**SEAT**

06.1997→09.2000 Reference	AEE 030 121 005 N 030 121 008 DX	030 121 005 NV	030 121 005 NX	030 121 008 D		50 005 139
06.1997→09.2000 Reference	AEE 036 115 105 B 036 115 105 D	036 115 105 B 036 115 105 D	036 115 105 B 036 115 105 D	036 115 105 B 036 115 105 D		50 005 844
Inca 1.7 SDI						63
07.1996→09.2000 Reference	AHB 026 121 010 026 121 010 F 026 121 010 X 068 121 010 A 	026 121 010 C 026 121 010 FV 037 121 010 068 121 010 AX	026 121 010 CV 026 121 010 FX 037 121 010 A	026 121 010 CX 026 121 010 V 037 121 010 AX		50 005 151 mit Gegengehäuse/with backhousing/avec demi-corps/con remate/с задним корпусом
07.1996→09.2000 Reference	AHB 026 121 005 A 026 121 005 H 	026 121 005 C 037 121 005 B	026 121 005 E 037 121 005 C	026 121 005 G 068 121 005 A		50 005 148 ohne Gegengehäuse/without backhousing/sans demi-corps/sin remate/без заднего корпуса
07.1996→09.2000 Reference	AHB 028 115 105 G	028 115 105 G	068 115 105 BK	068 115 105 BK		50 005 806
Inca 1.9 D						64
11.1995→06.2003 Reference	1Y 026 121 010 026 121 010 F 026 121 010 X 068 121 010 A 	026 121 010 C 026 121 010 FV 037 121 010 068 121 010 AX	026 121 010 CV 026 121 010 FX 037 121 010 A	026 121 010 CX 026 121 010 V 037 121 010 AX		50 005 151 mit Gegengehäuse/with backhousing/avec demi-corps/con remate/с задним корпусом
11.1995→06.2003 Reference	1Y 026 121 005 A 026 121 005 H 	026 121 005 C 037 121 005 B	026 121 005 E 037 121 005 C	026 121 005 G 068 121 005 A		50 005 148 ohne Gegengehäuse/without backhousing/sans demi-corps/sin remate/без заднего корпуса
11.1995→06.2003 Reference	1Y 028 115 105 G	028 115 105 G	068 115 105 BK	068 115 105 BK		50 005 806
Inca 1.9 SDI						65
11.1995→09.2000 Reference	AEY 026 121 010 026 121 010 F 026 121 010 X 068 121 010 A 	026 121 010 C 026 121 010 FV 037 121 010 068 121 010 AX	026 121 010 CV 026 121 010 FX 037 121 010 A	026 121 010 CX 026 121 010 V 037 121 010 AX		50 005 151 mit Gegengehäuse/with backhousing/avec demi-corps/con remate/с задним корпусом 09.1996→

S















09.2000→06.2003 Reference	AYQ 038 121 011	038 121 011 A	038 121 011 AV	038 121 011AX			50 005 132	
11.1995→09.2000 Reference	AEY 026 121 005 A 026 121 005 H	026 121 005 C 037 121 005 B	026 121 005 E 037 121 005 C	026 121 005 G 068 121 005 A			50 005 148	
	ohne Gegengehäuse/without backhousing/sans demi-corps/sin remate/без заднего корпуса							
11.1995→09.2000 Reference	AEY 028 115 105 G	028 115 105 G	068 115 105 BK	068 115 105 BK			50 005 806	
09.2000→06.2003 Reference	AYQ 06A 115 105 06A 115 105 B 06A 115 105 C 06A 115 105 D	06A 115 105 06A 115 105 B 06A 115 105 C 06A 115 105 D	06A 115 105 06A 115 105 B 06A 115 105 C 06A 115 105 D	06A 115 105 06A 115 105 B 06A 115 105 C 06A 115 105 D			50 005 819	
Leon 1.4i 16V							66	
11.1999→10.2005 Reference	AHW, APE, AXP, BCA 036 121 005 B 036 121 005 S	036 121 005 E 036 121 008K	036 121 005 Q 036 121 008L	036 121 005 QX 036 121 008LX			50 005 154	
11.1999→05.2002 Reference	AHW, APE, AXP 036 115 105 B 036 115 105 D	036 115 105 B 036 115 105 D	036 115 105 B 036 115 105 D	036 115 105 B 036 115 105 D			50 005 844	
Leon 1.4 SRE 16V							67	
06.2006→ Reference	BXW 036 115 105 B 036 115 105 D 1P-6-000 001→	036 115 105 B 036 115 105 D	036 115 105 B 036 115 105 D	036 115 105 B 036 115 105 D			50 005 844	
Leon 1.6i							68	
08.1999→06.2006 Reference	AEH, AKL, BFQ 06A 115 105 06A 115 105 B 06A 115 105 C 06A 115 105 D	06A 115 105 06A 115 105 B 06A 115 105 C 06A 115 105 D	06A 115 105 06A 115 105 B 06A 115 105 C 06A 115 105 D	06A 115 105 06A 115 105 B 06A 115 105 C 06A 115 105 D			50 005 819	
08.1999→10.2005	AEH, AKL						50 005 130	
Leon 1.6 SRE							69	
07.2005→ Reference	BSE, BSF 06B 121 011 H	06B 121 011L	06B 121 011LX	06B 121 011M			50 005 775	



07.2005→ Reference	BSE, BSF 06A 115 105 06A 115 105 B 06A 115 105 C 06A 115 105 D 1P-6-000 001→	06A 115 105 06A 115 105 B 06A 115 105 C 06A 115 105 D	06A 115 105 06A 115 105 B 06A 115 105 C 06A 115 105 D	06A 115 105 06A 115 105 B 06A 115 105 C 06A 115 105 D		50 005 819
Leon 1.6i 16V						70
06.2000→06.2006 Reference	AUS, AZD, BCB 036 121 005 F	036 121 005 P	036 121 008 G	036 121 008 GX		50 005 754
06.2000→06.2006 Reference	AUS, AZD, BCB 036 115 105 B 036 115 105 D	036 115 105 B 036 115 105 D	036 115 105 B 036 115 105 D	036 115 105 B 036 115 105 D		50 005 844
Leon 1.8i 20V						71
10.1998→10.2005 Reference	AGN, APG 06A 115 105 06A 115 105 B 06A 115 105 C 06A 115 105 D	06A 115 105 06A 115 105 B 06A 115 105 C 06A 115 105 D	06A 115 105 06A 115 105 B 06A 115 105 C 06A 115 105 D	06A 115 105 06A 115 105 B 06A 115 105 C 06A 115 105 D		50 005 819
10.1998→10.2005	AGN, APG					50 005 131
Leon 1.8i Turbo 20V						72
08.1999→10.2005 Reference	AJQ, APP, ARY, AUQ 06A 115 105 06A 115 105 B 06A 115 105 C 06A 115 105 D	06A 115 105 06A 115 105 B 06A 115 105 C 06A 115 105 D	06A 115 105 06A 115 105 B 06A 115 105 C 06A 115 105 D	06A 115 105 06A 115 105 B 06A 115 105 C 06A 115 105 D		50 005 819
08.1999→10.2005	AJQ, APP, ARY, AUQ					50 005 131
Leon 1.8i Cupra R 20V						73
05.2002→06.2006 Reference	AMK, BAM 06A 115 105 06A 115 105 B 06A 115 105 C 06A 115 105 D	06A 115 105 06A 115 105 B 06A 115 105 C 06A 115 105 D	06A 115 105 06A 115 105 B 06A 115 105 C 06A 115 105 D	06A 115 105 06A 115 105 B 06A 115 105 C 06A 115 105 D		50 005 819
05.2002→06.2006	AMK, BAM					50 005 131
Leon 1.9 TDI						74
10.1999→10.2005 Reference	AGR, AHF, ALH, ASV 038 121 011	038 121 011 A	038 121 011 AV	038 121 011AX		50 005 132

S



						
07.2005→ Reference	BKC, BLS, BXE, BXF 045 121 011B 045 121 011F 045 121 011H 045 121 011HX					50 005 556
10.1999→06.2006 Reference	AGR, AHF, ALH, ASV, AXR 06A 115 105 06A 115 105 06A 115 105 06A 115 105 06A 115 105 B 06A 115 105 B 06A 115 105 B 06A 115 105 B 06A 115 105 C 06A 115 105 C 06A 115 105 C 06A 115 105 C 06A 115 105 D 06A 115 105 D 06A 115 105 D 06A 115 105 D					50 005 819
09.2000→06.2006 Reference	ARL, ASZ 038 121 001 C 038 121 011 C 038 121 011 D 038 121 011 G 038 121 011 J 038 121 011 K 038 121 011 K X					50 005 554
Leon 1.9 SDi						75
06.2000→10.2003 Reference	AQM 038 121 011 038 121 011 A 038 121 011 AV 038 121 011 AX					50 005 132
06.2000→10.2003 Reference	AQM 06A 115 105 06A 115 105 06A 115 105 06A 115 105 06A 115 105 B 06A 115 105 B 06A 115 105 B 06A 115 105 B 06A 115 105 C 06A 115 105 C 06A 115 105 C 06A 115 105 C 06A 115 105 D 06A 115 105 D 06A 115 105 D 06A 115 105 D					50 005 819
Leon 2.0 FSI 16V						76
07.2005→ Reference	BLR, BLY, BVY, BVZ 06B 121 011 H 06B 121 011 L 06B 121 011 LX 06B 121 011 M					50 005 775
Leon 2.0 TDI 16V						77
07.2005→ Reference	AZV, BKD 038 121 001 C 038 121 011 C 038 121 011 D 038 121 011 G 038 121 011 J 038 121 011 K 038 121 011 K X					50 005 554
Leon 2.8i Cupra 4 24V						78
10.2000→07.2001 Reference	AUE 021 121 004 021 121 004 A					50 005 165
10.2000→04.2004 Reference	AUE, BDE 022 121 011 AUE: F 1M-2-050 001→					50 005 008 NEW



SEAT

**Terra 1.3 D****79**

1989 → 1991

MN

Reference

031 121 004	031 121 004 A	031 121 004 AV	031 121 004 AX
031 121 004 X	031 121 005 A	031 121 005 C	031 121 005 CV
031 121 005 CX			

**50 005 138****Toledo 1.4i 16V****80**

01.2000→05.2002

AHW, AXP

Reference

036 121 005 B	036 121 005 E	036 121 005 Q	036 121 005 QX
036 121 005 S	036 121 008K	036 121 008L	036 121 008LX

**50 005 154**

01.2000→05.2002

AHW, AXP

Reference

036 115 105 B	036 115 105 B	036 115 105 B	036 115 105 B
036 115 105 D	036 115 105 D	036 115 105 D	036 115 105 D
1M-X-000 001→1M-X-025 000			

**50 005 844****Toledo 1.4 SRE 16V****81**

05.2006→06.2007

BXW

Reference

036 115 105 B	036 115 105 B	036 115 105 B	036 115 105 B
036 115 105 D	036 115 105 D	036 115 105 D	036 115 105 D

**50 005 844****Toledo 1.6i****82**

05.1991→03.1999

1F, ABN, AFT, EZ

Reference

026 121 010	026 121 010 C	026 121 010 CV	026 121 010 CX
026 121 010 F	026 121 010 FV	026 121 010 FX	026 121 010 V
026 121 010 X	037 121 010	037 121 010 A	037 121 010 AX
068 121 010 A	068 121 010 AX		



mit Gegengehäuse/with backhousing/avec demi-corps/con remate/с задним корпусом

**50 005 151**

05.1991→03.1999

1F, ABN, AFT, EZ

Reference

027 115 105	027 115 105	027 115 105 E	027 115 105 E
049 115 105 A	049 115 105 A	055 115 105 D	055 115 105 D

**50 005 808**

05.1991→03.1999

1F, ABN, AFT, EZ

Reference

026 121 005 A	026 121 005 C	026 121 005 E	026 121 005 G
026 121 005 H	037 121 005 B	037 121 005 C	068 121 005 A



ohne Gegengehäuse/without backhousing/sans demi-corps/sin remate/без заднего корпуса

**50 005 148**

10.1998→07.2004

AEH, AKL

Reference

06A 115 105	06A 115 105	06A 115 105	06A 115 105
06A 115 105 B	06A 115 105 B	06A 115 105 B	06A 115 105 B
06A 115 105 C	06A 115 105 C	06A 115 105 C	06A 115 105 C
06A 115 105 D	06A 115 105 D	06A 115 105 D	06A 115 105 D
1M-X-000 001→1M-X-025 000			



**50 005 819**

10.1998→07.2004



AEH, AKL

**50 005 130****S**



**Toledo 1.6i 16V****83**

06.2000→07.2004	AUS, AZD, BCB						
Reference	036 121 005 F	036 121 005 P	036 121 008 G	036 121 008 GX			50 005 754
06.2000→07.2004	AUS, AZD, BCB						
Reference	036 115 105 B	036 115 105 B	036 115 105 B	036 115 105 B		50 005 844	
	036 115 105 D	036 115 105 D	036 115 105 D	036 115 105 D			
	AUS, AZD: 1M-X-000 001→1M-X-025 000						



Toledo 1.6 SRE**84**

09.2004→	BGU, BSE, BSF						
Reference	06B 121 011 H	06B 121 011 L	06B 121 011 LX	06B 121 011 M			50 005 775
09.2004→	BGU, BSE, BSF						
Reference	06A 115 105	06A 115 105	06A 115 105	06A 115 105		50 005 819	
	06A 115 105 B	06A 115 105 B	06A 115 105 B	06A 115 105 B			
	06A 115 105 C	06A 115 105 C	06A 115 105 C	06A 115 105 C			
	06A 115 105 D	06A 115 105 D	06A 115 105 D	06A 115 105 D			

Toledo 1.8i**85**

05.1991→03.1999	ABS, ACC, ADZ, RP						
Reference	026 121 010	026 121 010 C	026 121 010 CV	026 121 010 CX			50 005 151
	026 121 010 F	026 121 010 FV	026 121 010 FX	026 121 010 V			
	026 121 010 X	037 121 010	037 121 010 A	037 121 010 AX			
	068 121 010 A	068 121 010 AX					
	mit Gegengehäuse/with backhousing/avec demi-corps/con remate/c задним корпусом						
05.1991→03.1999	ABS, ACC, ADZ, RP						
Reference	027 115 105	027 115 105	027 115 105 E	027 115 105 E		50 005 808	
	049 115 105 A	049 115 105 A	055 115 105 D	055 115 105 D			
05.1991→03.1999	ABS, ACC, ADZ, RP						
Reference	026 121 005 A	026 121 005 C	026 121 005 E	026 121 005 G		50 005 148	
	026 121 005 H	037 121 005 B	037 121 005 C	068 121 005 A			
	ohne Gegengehäuse/without backhousing/sans demi-corps/sin remate/без заднего корпуса						

Toledo 1.8i 16V**86**

05.1991→03.1994	KR, PL						
Reference	026 121 010	026 121 010 C	026 121 010 CV	026 121 010 CX			50 005 151
	026 121 010 F	026 121 010 FV	026 121 010 FX	026 121 010 V			
	026 121 010 X	037 121 010	037 121 010 A	037 121 010 AX			
	068 121 010 A	068 121 010 AX					
	mit Gegengehäuse/with backhousing/avec demi-corps/con remate/c задним корпусом						
05.1991→03.1994	KR, PL						
Reference	026 121 005 A	026 121 005 C	026 121 005 E	026 121 005 G		50 005 148	
	026 121 005 H	037 121 005 B	037 121 005 C	068 121 005 A			
	ohne Gegengehäuse/without backhousing/sans demi-corps/sin remate/без заднего корпуса						

**SEAT**

05.1991→03.1994 Reference	KR, PL 027 115 105 A 068 115 105 AG	027 115 105 A 068 115 105 AG	027 115 105 C 068 115 105 Q	027 115 105 C 068 115 105 Q
				50 005 803
Toledo 1.8i 20V				87
10.1998→07.2004 Reference	AGN, APG 06A 115 105 06A 115 105 B 06A 115 105 C 06A 115 105 D	06A 115 105 06A 115 105 B 06A 115 105 C 06A 115 105 D	06A 115 105 06A 115 105 B 06A 115 105 C 06A 115 105 D	06A 115 105 06A 115 105 B 06A 115 105 C 06A 115 105 D
				50 005 819
10.1998→07.2004	AGN, APG			50 005 131
Toledo 1.8i Turbo 20V				88
05.2001→07.2004 Reference	AUQ 06A 115 105 06A 115 105 B 06A 115 105 C 06A 115 105 D	06A 115 105 06A 115 105 B 06A 115 105 C 06A 115 105 D	06A 115 105 06A 115 105 B 06A 115 105 C 06A 115 105 D	06A 115 105 06A 115 105 B 06A 115 105 C 06A 115 105 D
				50 005 819
05.2001→07.2004	AUQ			50 005 131
Toledo 1.9 D				89
05.1991→03.1999 Reference	1Y 026 121 010 026 121 010 F 026 121 010 X 068 121 010 A	026 121 010 C 026 121 010 FV 037 121 010 068 121 010 AX	026 121 010 CV 026 121 010 FX 037 121 010 A	026 121 010 CX 026 121 010 V 037 121 010 AX
				50 005 151
05.1991→03.1999 Reference	1Y 026 121 005 A 026 121 005 H	026 121 005 C 037 121 005 B	026 121 005 E 037 121 005 C	026 121 005 G 068 121 005 A
				50 005 148
05.1991→03.1999 Reference	1Y 028 115 105 G	028 115 105 G	068 115 105 BK	068 115 105 BK
				50 005 806
Toledo 1.9 TD				90
05.1991→04.1997 Reference	AAZ 026 121 010 026 121 010 F 026 121 010 X 068 121 010 A	026 121 010 C 026 121 010 FV 037 121 010 068 121 010 AX	026 121 010 CV 026 121 010 FX 037 121 010 A	026 121 010 CX 026 121 010 V 037 121 010 AX
				50 005 151

S



05.1991→04.1997 Reference	AAZ	026 121 005 A 026 121 005 H	026 121 005 C 037 121 005 B	026 121 005 E 037 121 005 C	026 121 005 G 068 121 005 A			50 005 148
	ohne Gegengehäuse/without backhousing/sans demi-corps/sin remate/без заднего корпуса							
05.1991→04.1997 Reference	AAZ	028 115 105 G	028 115 105 G	068 115 105 BK	068 115 105 BK			50 005 806
Toledo 1.9 TDI								91
04.1995→03.1999 Reference	1Z, AFN, AHU	026 121 010 026 121 010 F 026 121 010 X 068 121 010 A	026 121 010 C 026 121 010 FV 037 121 010 068 121 010 AX	026 121 010 CV 026 121 010 FX 037 121 010 A	026 121 010 CX 026 121 010 V 037 121 010 AX			50 005 151
	mit Gegengehäuse/with backhousing/avec demi-corps/con remate/c задним корпусом							
10.1998→07.2004 Reference	AGR, AHF, ALH, ASV	038 121 011	038 121 011 A	038 121 011 AV	038 121 011AX			50 005 132
04.1995→03.1999 Reference	1Z, AFN, AHU	026 121 005 A 026 121 005 H	026 121 005 C 037 121 005 B	026 121 005 E 037 121 005 C	026 121 005 G 068 121 005 A			50 005 148
	ohne Gegengehäuse/without backhousing/sans demi-corps/sin remate/без заднего корпуса							
09.2004→ Reference	BJB, BKC, BLS, BXE	045 121 011B	045 121 011F	045 121 011H	045 121 011HX			50 005 556
04.1995→03.1999 Reference	1Z, AFN, AHU	028 115 105 G	028 115 105 G	068 115 105 BK	068 115 105 BK			50 005 806
10.1998→07.2004 Reference	AGR, AHF, ALH, ASV	06A 115 105 06A 115 105 B 06A 115 105 C 06A 115 105 D 1M-X-000 001→1M-X-025 000	06A 115 105 06A 115 105 B 06A 115 105 C 06A 115 105 D	06A 115 105 06A 115 105 B 06A 115 105 C 06A 115 105 D	06A 115 105 06A 115 105 B 06A 115 105 C 06A 115 105 D			50 005 819
10.2000→06.2006 Reference	ARL, ASZ	038 121 001 C 038 121 011J	038 121 011 C 038 121 011K	038 121 011 D 038 121 011KX	038 121 011G			50 005 554



SEAT

Toledo 2.0i							92			
05.1991→03.1999	2E, AGG									
Reference	026 121 010	026 121 010 C	026 121 010 CV	026 121 010 CX						
	026 121 010 F	026 121 010 FV	026 121 010 FX	026 121 010 V						
	026 121 010 X	037 121 010	037 121 010 A	037 121 010 AX						
	068 121 010 A	068 121 010 AX								
	mit Gegengehäuse/with backhousing/avec demi-corps/con remate/c задним корпусом						50 005 151			
05.1991→03.1999	2E, AGG									
Reference	026 121 005 A	026 121 005 C	026 121 005 E	026 121 005 G						
	026 121 005 H	037 121 005 B	037 121 005 C	068 121 005 A						
	ohne Gegengehäuse/without backhousing/sans demi-corps/sin remate/без заднего корпуса						50 005 148			
05.1991→03.1999	2E, AGG									
Reference	027 115 105 B	027 115 105 B					50 005 805			
Toledo 2.0i 16V							93			
03.1994→03.1999	ABF									
Reference	026 121 010	026 121 010 C	026 121 010 CV	026 121 010 CX						
	026 121 010 F	026 121 010 FV	026 121 010 FX	026 121 010 V						
	026 121 010 X	037 121 010	037 121 010 A	037 121 010 AX						
	068 121 010 A	068 121 010 AX								
	mit Gegengehäuse/with backhousing/avec demi-corps/con remate/c задним корпусом						50 005 151			
03.1994→03.1999	ABF									
Reference	051 115 105 A	051 115 105 A					50 005 801			
03.1994→03.1999	ABF									
Reference	026 121 005 A	026 121 005 C	026 121 005 E	026 121 005 G						
	026 121 005 H	037 121 005 B	037 121 005 C	068 121 005 A						
	ohne Gegengehäuse/without backhousing/sans demi-corps/sin remate/без заднего корпуса						50 005 148			
Toledo 2.0 FSI 16V							94			
09.2004→	BLR, BLY, BVY, BVZ									
Reference	06B 121 011 H	06B 121 011 L	06B 121 011 LX	06B 121 011 M			50 005 775			
Toledo 2.0 TDI 16V							95			
04.2004→	AZV, BKD									
Reference	038 121 001 C	038 121 011 C	038 121 011 D	038 121 011 G						
	038 121 011 J	038 121 011 K	038 121 011 KX				50 005 554			
Toledo 2.3i 20V							96			
10.1998→11.2000	AGZ									
Reference	066 121 011 C	071 121 005					50 005 159			

S



Toledo 2.3i 25V

97

09.2000→11.2003

AQN

Reference

066 121 011 C





071 121 005





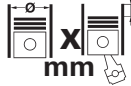

50 005 159

S



			Cyl	 mm	cm ³		Comp. Ratio ε	kW	PS	Pos
AEE	B		4	76,5 x 86,9	1598	2	9,8:1	55	75	12, 16
AEF	D	(AN)	4	79,5 x 95,5	1896	2	22,5:1	47	64	13
AEG	B		4	82,5 x 92,8	1984	2	10,5:1	85	115	23
AEH	B		4	81 x 77,4	1595	2	10,3:1	74	101	16
AGN	B		4	81 x 86,4	1781	5		92	125	18
AGP	D	(AN)	4	79,5 x 95,5	1896	2	22,5:1	50	68	22
AGR	D	(LA)	4	79,5 x 95,5	1896	2	19,5:1	66	90	21
AGU	B	(LA)	4	81 x 86,4	1781	5	9,5:1	110	150	20
AHF	D	(LA)	4	79,5 x 95,5	1896	2	19,5:1	81	110	21
AKL	B		4	81 x 77,4	1595	2	10,2:1	74	101	16
ALH	D	(A)	4	79,5 x 95,5	1896	2	19,5:1	66	90	21
AME	B		4	75,5 x 78	1397	2	10:1	50	68	4
AMF	D	(LA)	3	79,5 x 95,5	1422	2	19,5:1	55	75	7
AMX	B		6	82,5 x 86,4	2771	5	10,6:1	142	193	36
APK	B		4	82,5 x 92,8	1984	2	10,5:1	85	115	23
AQM	D	(LA)	4	79,5 x 95,5	1896	2	19,5:1	50	68	22
AQV	B		4	67,1 x 70,6	999	2	10:1	37	50	1
AQW	B		4	75,5 x 78	1397	2	10:1	50	68	4
AQY	B		4	82,5 x 92,8	1984	2	10,3:1	85	115	23
ARV	B		4	67,1 x 70,6	999	2	10:1	37	50	1
ARX	B	(A)	4	81 x 86,4	1781	5	9,5:1	110	150	20
ARZ	B	(A)	4	81 x 86,4	1781	5	9,5:1	110	150	20
ASV	D	(LA)	4	79,5 x 95,5	1896	2	19,5:1	81	110	21
ASY	D	(AN)	4	79,5 x 95,5	1896	2	19,5:1	47	64	9
ASZ	D	(LA)	4	79,5 x 95,5	1896	2	19:1	96	130	10, 21
ATD	D	(LA)	4	79,5 x 95,5	1896	2	19:1	74	101	10, 21
ATZ	B		4	75,5 x 78	1397	2	10:1	50	68	4
AUA	B		4	76,5 x 75,6	1390	4	10,5:1	55	75	5
AUB	B		4	76,5 x 75,6	1390	4	10,5:1	74	101	5
AUM	B	(LA)	4	81 x 86,4	1781	5	9,5:1	110	150	20
AUQ	B	(LA)	4	81 x 86,4	1781	5	9,5:1	132	180	19
AVB	D	(A)	4	79,5 x 95,5	1896	2	19:1	74	101	31
AVF	D	(LA)	4	79,5 x 95,5	1896	2	19:1	96	130	31
AVU	B		4	81 x 77,4	1595	2	10,3:1	75	102	16
AWT	B	(A)	4	81 x 86,4	1781	5	9,5:1	110	150	30
AWX	D	(A)	4	79,5 x 95,5	1896	2	19:1	96	130	31
AWY	B		3	76,5 x 86,9	1198	2	10,8:1	40	54	2
AXP	B		4	76,5 x 75,6	1390	4	10,5:1	55	75	14
AXR	D	(LA)	4	79,5 x 95,5	1896	2	19:1	74	101	10, 21
AYM	D	(LA)	6	78,3 x 86,4	2496	4	18,5:1	114	155	35
AZH	B		4	82,5 x 92,8	1984	2	10,5:1	85	115	23
AZJ	B		4	82,5 x 92,8	1984	2	10,4:1	85	116	23
AZL	B		4	82,5 x 92,8	1984	2	10,5:1	85	115	11
AZM	B		4	82,5 x 92,8	1984	2	10,5:1	85	115	32
AZQ	B		3	76,5 x 86,9	1198	4	10,5:1	47	64	3
AZV	D	(LA)	4	81 x 95,5	1968	4	18:1	100	136	25
BBY	B		4	76,5 x 75,6	1390	4	10,5:1	55	75	5
BBZ	B		4	76,5 x 75,6	1390	4	10,5:1	74	101	5
BCA	B		4	76,5 x 75,6	1390	4		55	75	14
BDG	D	(LA)	6	78,3 x 86,4	2496	4	18,5:1	120	163	35
BFQ	B		4	81 x 77,4	1595	2	10,2:1	75	102	16
BGU	B		4	81 x 77,4	1595	2	10,5:1	75	102	16
BJB	D	(LA)	4	79,5 x 95,5	1896	2	19:1	77	105	21
BKC	D	(LA)	4	79,5 x 95,5	1896	2	19:1	77	105	21
BKD	D	(LA)	4	81 x 95,5	1968	4	18:1	103	140	25, 34
BKY	B		4	76,5 x 75,6	1390	4	10,5:1	55	75	5
BLF	B		4	76,5 x 86,9	1598	4	12:1	85	115	17
BLR	B		4	82,5 x 92,8	1984	4	11,5:1	110	150	24
BLS	D	(LA)	4	79,5 x 95,5	1896	2	19:1	77	105	10, 21, 29
BLT	D	(LA)	4	79,5 x 95,5	1896	2	19:1	96	130	10
BLX	B		4	82,5 x 92,8	1984	4	11,5:1	110	150	24
BLY	B		4	82,5 x 92,8	1984	4	11,5:1	110	150	24
BMD	B		3	76,5 x 86,9	1198	2	10,3:1	40	54	2
BMP	D	(LA)	4	81 x 95,5	1968	2	18,5:1	103	140	34
BMS	D	(LA)	3	79,5 x 95,5	1422	2	19,5:1	59	80	7, 27
BNM	D	(LA)	3	79,5 x 95,5	1422	2	19,5:1	51	68	7, 27
BNV	D	(LA)	3	79,5 x 95,5	1422	2	19,5:1	58	80	7, 27
BPZ	D	(LA)	4	79,5 x 95,5	1896	2	19:1	85	116	31
BSE	B		4	81 x 77,4	1595	2	10,3:1	75	102	16

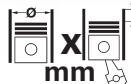

			Cyl	 mm	cm ³		Comp. Ratio ε	kW	PS	Pos
BSF	B		4	81 x 77,4	1595	2	10,3:1	75	102	16
BSS	D	(LA)	4	81 x 95,5	1968	2	18,5:1	103	140	33
BSV	D	(LA)	4	79,5 x 95,5	1896	2	19:1	77	105	31
BSW	D	(LA)	4	79,5 x 95,5	1896	2	18,5:1	77	105	10, 29
BTS	B		4	76,5 x 86,9	1598	4	11,5:1	77	105	8, 28
BUD	B		4	76,5 x 75,6	1390	4	10,5:1	59	80	6, 15
BVY	B		4	82,5 x 92,8	1984	4	11,5:1	110	150	24
BVZ	B		4	82,5 x 92,8	1984	4	11,5:1	110	150	24
BXE	D	(LA)	4	79,5 x 95,5	1896	2	19:1	77	105	21
BXW	B		4	76,5 x 75,6	1390	4	10,5:1	63	86	5, 26

**SKODA****Fabia 1.0i****1**

10.2000→08.2002	AQV, ARV							
Reference	047 121 013 L	047 121 013 M	047 121 013 P	047 121 013 R				50 005 768

Fabia 1.2i**2**

07.2001→12.2007	AWY, BMD							
Reference	03D 121 005	03D 121 013 B						50 005 770

Fabia 1.2i 12V**3**

01.2003→12.2004	AZQ							
Reference	03D 121 005	03D 121 013 B						50 005 770

Fabia 1.4i**4**

08.1999→05.2003	AME, AQW, ATZ							
Reference	047 121 013 L	047 121 013 M	047 121 013 P	047 121 013 R				50 005 768

Fabia 1.4i 16V**5**

10.1999→12.2007	AUA, AUB, BBY, BBZ, BKY							
Reference	036 121 005 B 036 121 005 S	036 121 005 E 036 121 008K	036 121 005 Q 036 121 008L	036 121 005 QX 036 121 008LX				50 005 154

10.1999→	AUA, AUB, BBY, BBZ, BKY, BXW							
Reference	036 115 105 B 036 115 105 D BXW: 5J-7-000 001→	036 115 105 B 036 115 105 D	036 115 105 B 036 115 105 D	036 115 105 B 036 115 105 D				50 005 844

**Fabia 1.4 FSI 16V****6**

05.2006→12.2007	BUD							
Reference	036 121 005 B 036 121 005 S	036 121 005 E 036 121 008K	036 121 005 Q 036 121 008L	036 121 005 QX 036 121 008LX				50 005 154

05.2006→12.2007	BUD							
Reference	036 115 105 B 036 115 105 D	036 115 105 B 036 115 105 D	036 115 105 B 036 115 105 D	036 115 105 B 036 115 105 D				50 005 844

S



**Fabia 1.4 TDI****7**

04.2003→ Reference	AMF, BMS, BNM, BNV 045 121 011B 045 121 011F 045 121 011H 045 121 011HX			50 005 556
-----------------------	---	---	--	-------------------





Fabia 1.6i 16V**8**

04.2007→ Reference	BTS 03C 121 005 B 03C 121 005 C			50 005 061 <small>NEW</small>
-----------------------	---------------------------------------	---	--	---



Fabia 1.9 SDI**9**

11.1999→03.2008 Reference	ASY 06A 115 105 06A 115 105 06A 115 105 06A 115 105 06A 115 105 B 06A 115 105 B 06A 115 105 B 06A 115 105 B 06A 115 105 C 06A 115 105 C 06A 115 105 C 06A 115 105 C 06A 115 105 D 06A 115 105 D 06A 115 105 D 06A 115 105 D		50 005 819	
11.1999→03.2008 Reference	ASY 045 121 011 C 045 121 011 G			50 005 750



Fabia 1.9 TDI**10**

01.2000→ Reference	ATD, AXR, BLS, BLT 045 121 011B 045 121 011F 045 121 011H 045 121 011HX			50 005 556
04.2007→ Reference	BSW 038 121 011 G 1C-6-499 000→			50 005 783
01.2000→ Reference	ATD, AXR, BSW 06A 115 105 06A 115 105 06A 115 105 06A 115 105 06A 115 105 B 06A 115 105 B 06A 115 105 B 06A 115 105 B 06A 115 105 C 06A 115 105 C 06A 115 105 C 06A 115 105 C 06A 115 105 D 06A 115 105 D 06A 115 105 D 06A 115 105 D		50 005 819	
06.2003→10.2005 Reference	ASZ 038 121 001 C 038 121 011 C 038 121 011 D 038 121 011G 038 121 011J 038 121 011K 038 121 011KX			50 005 554

Fabia 2.0i**11**

12.1999→12.2007 Reference	AZL 06A 115 105 06A 115 105 06A 115 105 06A 115 105 06A 115 105 B 06A 115 105 B 06A 115 105 B 06A 115 105 B 06A 115 105 C 06A 115 105 C 06A 115 105 C 06A 115 105 C 06A 115 105 D 06A 115 105 D 06A 115 105 D 06A 115 105 D		50 005 819	
12.1999→12.2007	AZL			50 005 131



**SKODA****Felicia 1.6i****12**

05.1995→08.2001	AEE							
Reference	030 121 005 N 030 121 008 DX	030 121 005 NV	030 121 005 NX	030 121 008 D				50 005 139
05.1995→08.2001	AEE							
Reference	036 115 105 B 036 115 105 D	036 115 105 B 036 115 105 D	036 115 105 B 036 115 105 D	036 115 105 B 036 115 105 D				50 005 844



Felicia 1.9 D**13**

10.1995→	AEF							
Reference	028 121 004	028 121 004 V	028 121 004 X					50 005 158
10.1995→	AEF							
Reference	028 115 105 L							50 005 807

Octavia 1.4i 16V**14**

08.2000→	AXP, BCA							
Reference	036 121 005 B 036 121 005 S	036 121 005 E 036 121 008K	036 121 005 Q 036 121 008L	036 121 005 QX 036 121 008LX				50 005 154
08.2000→	AXP, BCA							
Reference	036 115 105 B 036 115 105 D BCA: 01.2004→, 1Z-4-000 001→	036 115 105 B 036 115 105 D	036 115 105 B 036 115 105 D	036 115 105 B 036 115 105 D				50 005 844

Octavia 1.4 FSI 16V**15**















05.2006→	BUD							
Reference	036 121 005 B 036 121 005 S	036 121 005 E 036 121 008K	036 121 005 Q 036 121 008L	036 121 005 QX 036 121 008LX				50 005 154
05.2006→	BUD							
Reference	036 115 105 B 036 115 105 D BUD: 01.2009→, 1Z-9-000 001→ BUD: →12.2008, 1Z-4-000 001→	036 115 105 B 036 115 105 D	036 115 105 B 036 115 105 D	036 115 105 B 036 115 105 D				50 005 844

Octavia 1.6i**16**

05.2004→	BGU, BSE, BSF							
Reference	06B 121 011 H	06B 121 011 L	06B 121 011 LX	06B 121 011 M				50 005 775

S



							
02.1997→ Reference	AEH, AKL, AVU, BFQ, BGU, BSE, BSF	06A 115 105 06A 115 105 B 06A 115 105 C 06A 115 105 D	06A 115 105 06A 115 105 B 06A 115 105 C 06A 115 105 D	06A 115 105 06A 115 105 B 06A 115 105 C 06A 115 105 D	06A 115 105 06A 115 105 B 06A 115 105 C 06A 115 105 D	 50 005 819	
10.1996→09.2004 Reference	AEE	030 121 005 N 030 121 008 DX	030 121 005 NV	030 121 005 NX	030 121 008 D	 50 005 139	
10.1996→09.2004 Reference	AEE	036 115 105 B 036 115 105 D	036 115 105 B 036 115 105 D	036 115 105 B 036 115 105 D	036 115 105 B 036 115 105 D	 50 005 844	
02.1997→05.2007	AEH, AKL, AVU					 50 005 130	
Octavia 1.6 FSI 16V							17
02.2004→10.2008 Reference	BLF	03C 121 005 D	03C 121 005 K	03C 121 005 L		 50 005 001 <small>NEW</small>	
Octavia 1.8i 20V							18
10.1996→ Reference	AGN	06A 115 105 06A 115 105 B 06A 115 105 C 06A 115 105 D	06A 115 105 06A 115 105 B 06A 115 105 C 06A 115 105 D	06A 115 105 06A 115 105 B 06A 115 105 C 06A 115 105 D	06A 115 105 06A 115 105 B 06A 115 105 C 06A 115 105 D	 50 005 819	
10.1996→	AGN					 50 005 131	
Octavia 1.8i Turbo 16V							19
12.2000→01.2006 Reference	AUQ	06A 115 105 06A 115 105 B 06A 115 105 C 06A 115 105 D	06A 115 105 06A 115 105 B 06A 115 105 C 06A 115 105 D	06A 115 105 06A 115 105 B 06A 115 105 C 06A 115 105 D	06A 115 105 06A 115 105 B 06A 115 105 C 06A 115 105 D	 50 005 819	
12.2000→01.2006	AUQ					 50 005 131	
Octavia 1.8i Turbo 20V							20
05.1998→ Reference	AGU, ARX, ARZ, AUM	06A 115 105 06A 115 105 B 06A 115 105 C 06A 115 105 D	06A 115 105 06A 115 105 B 06A 115 105 C 06A 115 105 D	06A 115 105 06A 115 105 B 06A 115 105 C 06A 115 105 D	06A 115 105 06A 115 105 B 06A 115 105 C 06A 115 105 D	 50 005 819	



05.1998→	AGU, ARZ, AUM						50 005 131
Octavia 1.9 TDI							21
10.1996→	AGR, AHF, ALH, ASV						50 005 132
Reference	038 121 011	038 121 011 A	038 121 011 AV	038 121 011AX			
02.2004→	BJB, BKC, BLS, BXE						50 005 556
Reference	045 121 011B	045 121 011F	045 121 011H	045 121 011HX			
08.2000→	ASZ, ATD, AXR						50 005 783
Reference	038 121 011 G						
	AXR: 1U-3-634 882→1 U-6A007 490						
	ASZ, ATD: 1U-3-634 882→1U-6A007 490						
10.1996→	AGR, AHF, ALH, ASV, ATD, AXR					50 005 819	
Reference	06A 115 105	06A 115 105	06A 115 105	06A 115 105			
	06A 115 105 B	06A 115 105 B	06A 115 105 B	06A 115 105 B			
	06A 115 105 C	06A 115 105 C	06A 115 105 C	06A 115 105 C			
	06A 115 105 D	06A 115 105 D	06A 115 105 D	06A 115 105 D			
08.2000→01.2006	ASZ, ATD						50 005 554
Reference	038 121 001 C	038 121 011 C	038 121 011 D	038 121 011G			
	038 121 011J	038 121 011K	038 121 011KX				
Octavia 1.9 SDi							22
05.1997→	AGP, AQM						50 005 132
Reference	038 121 011	038 121 011 A	038 121 011 AV	038 121 011AX			
05.1997→	AGP, AQM					50 005 819	
Reference	06A 115 105	06A 115 105	06A 115 105	06A 115 105			
	06A 115 105 B	06A 115 105 B	06A 115 105 B	06A 115 105 B			
	06A 115 105 C	06A 115 105 C	06A 115 105 C	06A 115 105 C			
	06A 115 105 D	06A 115 105 D	06A 115 105 D	06A 115 105 D			
Octavia 2.0i							23
05.1999→	AEG, APK, AQY, AZH					50 005 819	
Reference	06A 115 105	06A 115 105	06A 115 105	06A 115 105			
	06A 115 105 B	06A 115 105 B	06A 115 105 B	06A 115 105 B			
	06A 115 105 C	06A 115 105 C	06A 115 105 C	06A 115 105 C			
	06A 115 105 D	06A 115 105 D	06A 115 105 D	06A 115 105 D			
05.1999→	AEG, APK, AQY, AZH, AZJ						50 005 131

**Octavia 2.0 FSI 16V****24**

11.2004→10.2008

BLR, BLX, BLY, BVY, BVZ

Reference

06B 121 011 H

06B 121 011 L

06B 121 011 LX

06B 121 011 M



50 005 775

Octavia 2.0 TDI 16V**25**

02.2004→

AZV, BKD

Reference

038 121 001 C

038 121 011 C

038 121 011 D

038 121 011 G

038 121 011 J

038 121 011 K

038 121 011 KX



50 005 554

Roomster 1.4i 16V**26**

05.2006→

BXW

Reference

036 115 105 B

036 115 105 B

036 115 105 B

036 115 105 B

036 115 105 D

036 115 105 D

036 115 105 D

036 115 105 D



50 005 844

Roomster 1.4 TDI**27**

05.2006→

BMS, BNM, BNV

Reference

045 121 011 B

045 121 011 F

045 121 011 H

045 121 011 HX



50 005 556

Roomster 1.6i 16V**28**

05.2006→

BTS

Reference

03C 121 005 B

03C 121 005 C



50 005 061

NEW

Roomster 1.9 TDI**29**

03.2008→

BLS

Reference

045 121 011 B

045 121 011 F

045 121 011 H

045 121 011 HX



50 005 556

05.2006→

BSW

Reference

038 121 011 G

1C-6-499 000→



50 005 783

05.2006→

BSW

Reference

06A 115 105

06A 115 105

06A 115 105

06A 115 105

06A 115 105 B

06A 115 105 B

06A 115 105 B

06A 115 105 B

06A 115 105 C

06A 115 105 C

06A 115 105 C

06A 115 105 C

06A 115 105 D

06A 115 105 D

06A 115 105 D

06A 115 105 D



50 005 819

Superb 1.8i Turbo 20V**30**

10.2001→03.2008

AWT

Reference

06A 115 105

06A 115 105

06A 115 105

06A 115 105

06A 115 105 B

06A 115 105 B

06A 115 105 B

06A 115 105 B

06A 115 105 C

06A 115 105 C

06A 115 105 C

06A 115 105 C

06A 115 105 D

06A 115 105 D

06A 115 105 D

06A 115 105 D



50 005 819



10.2001→03.2008	AWT				50 005 131
Superb 1.9 TDI					31
10.2005→05.2007	BSV 3U-29015 228→3U-6A300 290				50 005 738
12.2001→03.2008	AVB, AVF, AWX Reference 038 121 011 G 3U-29015 228→3U-6A300 290				50 005 783
06.2002→03.2008	AVB, BPZ, BSV Reference 06A 115 105 06A 115 105 06A 115 105 06A 115 105 06A 115 105 B 06A 115 105 B 06A 115 105 B 06A 115 105 B 06A 115 105 C 06A 115 105 C 06A 115 105 C 06A 115 105 C 06A 115 105 D 06A 115 105 D 06A 115 105 D 06A 115 105 D				50 005 819
12.2001→03.2008	AVB, AVF, AWX Reference 038 121 001 C 038 121 011 C 038 121 011 D 038 121 011 G 038 121 011 J 038 121 011 K 038 121 011 K X				50 005 554
Superb 2.0i					32
12.2001→03.2008	AZM Reference 06A 115 105 06A 115 105 06A 115 105 06A 115 105 06A 115 105 B 06A 115 105 B 06A 115 105 B 06A 115 105 B 06A 115 105 C 06A 115 105 C 06A 115 105 C 06A 115 105 C 06A 115 105 D 06A 115 105 D 06A 115 105 D 06A 115 105 D				50 005 819
12.2001→03.2008	AZM				50 005 131
Superb 2.0 TDI					33
10.2005→03.2008	BSS 3U-29015 228→3U-6A300 290				50 005 738
Superb 2.0 TDI 16V					34
03.2008→	BMP Reference 038 121 011 G				50 005 783
01.2009→	BKD Reference 038 121 001 C 038 121 011 C 038 121 011 D 038 121 011 G 038 121 011 J 038 121 011 K 038 121 011 K X				50 005 554



Superb 2.5 TDI 24V

35

12.2001→03.2008

AYM, BDG

Reference

059 121 004 B
059 121 004 EX

059 121 004 C

059 121 004 D

059 121 004 E



50 005 168

Superb 2.8i 30V

36

12.2001→03.2008

AMX

Reference

078 121 004 H
078 121 004 JV
078 121 006

078 121 004 HV
078 121 004 JX

078 121 004 HX
078 121 004 Q





078 121 004 J
078 121 004 QX



50 005 167

S





			Cyl	 mm	cm ³		Comp. Ratio ε	kW	PS	Pos
M 104.942	B		6	89,9 x 73,5	2799	4	10:1	142	193	2
M 161.950	B		4	89,9 x 78,7	1998	4	9,6:1	94	128	6, 11, 12
M 162.992	B		6	89,9 x 84	3199	4	10:1	162	220	1, 3, 8, 9, 10, 18, 20
M 162.996	B		6	89,9 x 84	3199	4	9,2:1	154	209	20
OM 602.982	D	(LA)	5	89 x 92,4	2874	2	19,5:1	95	129	19
OM 661.940	D	(AN)	4	89 x 92,4	2299	2	21:1	58	79	4, 13, 14
OM 662.940	D	(AN)	5	89 x 92,4	2874	2	21:1	70	95	5, 15, 17
OM 662.983	D	(LA)	5	89 x 92,4	2874	2	19,5:1	88	120	7, 16, 19



Actyon 3.2i 24V

1

03.2007→ Reference	M 162.992 104 200 28 01	104 200 45 01	104 200 49 01			50 005 434
03.2007→ Reference	M 162.992 104 200 33 01	104 200 44 01	104 200 47 01			50 005 436



Chairman 2.8 i 24V

2

10.1997→ Reference	M 104.942 104 200 28 01	104 200 45 01	104 200 49 01			50 005 434
10.1997→ Reference	M 104.942 104 200 33 01	104 200 44 01	104 200 47 01			50 005 436

Chairman 3.2 i 24V

3

10.1997→ Reference	M 162.992 104 200 28 01	104 200 45 01	104 200 49 01			50 005 434
10.1997→ Reference	M 162.992 104 200 33 01	104 200 44 01	104 200 47 01			50 005 436

Istana 2.3 D

4

07.1995→ Reference	OM 661.940 602 200 00 20	602 200 01 20	602 200 02 20			50 005 439
-----------------------	-----------------------------	---------------	---------------	---	--	------------

Istana 2.9 D

5

07.1995→ Reference	OM 662.940 602 200 00 20	602 200 01 20	602 200 02 20			50 005 439
-----------------------	-----------------------------	---------------	---------------	---	--	------------

Rexton 2.0i 16V

6

2001 → Reference	M 161.950 111 200 24 01	111 200 39 01				50 005 475
---------------------	----------------------------	---------------	--	---	--	------------

S



Rexton 2.9 TD

7

09.2002→
Reference OM 662.983
602 200 00 20 602 200 01 20 602 200 02 20

**50 005 439**

Rexton 3.2i 24V

8

09.2002→
Reference M 162.992
104 200 28 01 104 200 45 01 104 200 49 01

**50 005 434**

09.2002→
Reference M 162.992
104 200 33 01 104 200 44 01 104 200 47 01

**50 005 436**

Rodius 3.2i 24V

9

12.2004→
Reference M 162.992
104 200 28 01 104 200 45 01 104 200 49 01

**50 005 434**

12.2004→
Reference M 162.992
104 200 33 01 104 200 44 01 104 200 47 01

**50 005 436**

Stavic 3.2i 24V

10

12.2004→
Reference M 162.992
104 200 28 01 104 200 45 01 104 200 49 01

**50 005 434**

12.2004→
Reference M 162.992
104 200 33 01 104 200 44 01 104 200 47 01

**50 005 436**

Korando 2.0i 16V

11

07.1996→
Reference M 161.950
111 200 24 01 111 200 39 01

**50 005 475**

Musso 2.0i 16V

12

10.1996→
Reference M 161.950
111 200 24 01 111 200 39 01







**50 005 475****S**







Musso 2.3 D						13
07.1993→12.2000	OM 661.940					50 005 439
Reference	602 200 00 20	602 200 01 20	602 200 02 20			
Korando 2.3 D						14
10.1986→	OM 661.940					50 005 439
Reference	602 200 00 20	602 200 01 20	602 200 02 20			
Musso 2.9 D						15
07.1993→12.2000	OM 662.940					50 005 439
Reference	602 200 00 20	602 200 01 20	602 200 02 20			
Musso 2.9 TD						16
07.1996→	OM 662.983					50 005 439
Reference	602 200 00 20	602 200 01 20	602 200 02 20			
Korando 2.9 D						17
07.1996→	OM 662.940					50 005 439
Reference	602 200 00 20	602 200 01 20	602 200 02 20			
Musso 3.2i 24V						18
01.1996→12.2005	M 162.992					50 005 434
Reference	104 200 28 01	104 200 45 01	104 200 49 01			
01.1996→12.2005	M 162.992					50 005 436
Reference	104 200 33 01	104 200 44 01	104 200 47 01			
Korando 2.9 TD						19
07.1996→12.2000	OM 602.982, OM 662.983					50 005 439
Reference	602 200 00 20	602 200 01 20	602 200 02 20			
Korando 3.2i 24V						20
07.1996→12.2005	M 162.992					50 005 434
Reference	104 200 28 01	104 200 45 01	104 200 49 01			

S



				
12.1996→ Reference	M 162.996 104 200 27 01 104 200 32 01 104 200 48 01			50 005 437
07.1996→12.2005 Reference	M 162.992 104 200 33 01 104 200 44 01 104 200 47 01			50 005 436

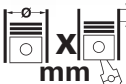

			Cyl	 mm	cm ³		Comp. Ratio ε	kW	PS	Pos
D 0826 LFL 03	D	(LA)	6	108 x 125	6871	2	16,5:1	162	220	1, 2
M 112.945	B		6	89,9 x 84	3199	3	9,2/10:1	158	215	5
M 113.962	B		8	97 x 84	4966	3	10:1	218-225	296-306	6
OM 606.964	D	(LA)	6	87 x 84	2996	4	22:1	130	177	4
OM 615.942	D	(AN)	4	87 x 83,6	1988	2	21:1	40	55	3

S

**STEYR****8 S 22****1**

D 0826 LFL 03
 Flügelrad Durchmesser 125 mm
 impeller diameter 125 mm
 roue à ailettes 125 mm
 roueda con paletas 135 mm
 Лопастное колесо диаметр 125 мм

**50 005 631****9 S 22****2**

D 0826 LFL 03
 Flügelrad Durchmesser 125 mm
 impeller diameter 125 mm
 roue à ailettes 125 mm
 roueda con paletas 135 mm
 Лопастное колесо диаметр 125 мм

**50 005 631****City Bus SC 6 F 55****3**

01.1975→12.1980

Reference

OM 615.942
 110 200 01 20
 Lager/bearing/coussinet/cojinete/подшипник: 36 mm

**50 005 032**

01.1975→12.1980

Reference

OM 615.942
 110 200 01 20 110 200 09 20 110 200 17 20 115 200 00 20
 115 200 15 20 115 200 18 20 121 200 09 20
 Lager/bearing/coussinet/cojinete/подшипник: 40 mm

**50 005 035****G 300 TD (Steyr)****4**

01.1998→

Reference

OM 606.964
 605 200 01 20 605 200 03 20 605 200 05 20 605 200 08 20

**50 005 490****G 320 (Steyr)****5**

01.1998→

Reference

M 112.945
 112 200 02 01 112 200 04 01 112 200 11 01 112 200 14 01
 →036808 / 033140 (USA)

**50 005 457**

01.1998→

Reference

M 112.945
 112 200 05 01 112 200 10 01 112 200 12 01 112 200 15 01
 036809 / 033141 (usa)→

**50 005 456****S****G 500 (Steyr)****6**

01.1998→

Reference

M 113.962
 112 200 02 01 112 200 04 01 112 200 11 01 112 200 14 01
 →000200

**50 005 457**





01.1998→

Reference

M 113.962
 112 200 05 01 112 200 10 01 112 200 12 01 112 200 15 01
 000201→

**50 005 456**

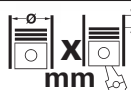

			Cyl	 X mm	cm ³		Comp. Ratio ε	kW	PS	Pos
EJ161	B		4	87,9 x 65,8	1597	4	10:1	70	95	3
EJ16E	B		4	87,9 x 65,8	1597	4	9,4:1	66	90	3
EJ16J	B		4	87,9 x 65,8	1597	4	10:1	66	90	3
EJ202	B		4	92 x 75	1994	4	10:1	90-92	122-125	1
EJ205 (125 kW)	B	(LA)	4	92 x 75	1994	4	8:1	125-130	170-177	2
EJ22 (94 kW)	B		4	96,9 x 75	2212	4	9,5:1	94-96	128-131	4
EZ30 (154 kW)	B		6	89,2 x 80	2999	4	10,7:1	154	209	6
G13B (50 kW)	B		4	74 x 75,5	1298	2	9,5:1	50	68	5
M13A (67 kW)	B		4	78 x 69,5	1328	4	9,5:1	66-69	90-94	7
M15A (73 kW)	B		4	78 x 78	1491	4	9,5:1	73-75	99-102	9
Z 13 DT	D	(LA)	4	69,6 x 82	1248	4	18:1	51	69	8



Forester 2.0i 16V

1

07.1997→

EJ202

Reference

21111-AA000	21111-AA001	21111-AA002	21111-AA003
21111-AA004	21111-AA005	21111-AA006	21111-AA007
21111-AA011			

**50 005 176**
NEW

Forester 2.0i Turbo 16V

2

07.1998→

EJ205 (125 kW)

Reference

21111-AA000	21111-AA001	21111-AA002	21111-AA003
21111-AA004	21111-AA005	21111-AA006	21111-AA007
21111-AA011			

**50 005 176**
NEW

Impreza 1.6i 16V

3

01.1993→06.2001

EJ161, EJ16E, EJ16J

Reference

21111-AA000	21111-AA001	21111-AA002	21111-AA003
21111-AA004	21111-AA005	21111-AA006	21111-AA007
21111-AA011			

**50 005 176**
NEW

Legacy 2.2i 16V

4

01.1994→05.1997

EJ22 (94 kW)

Reference

21111-AA000	21111-AA001	21111-AA002	21111-AA003
21111-AA004	21111-AA005	21111-AA006	21111-AA007
21111-AA011			

**50 005 176**
NEW

Justy 1.3i

5

10.1995→

G13B (50 kW)

**50 005 177**
NEW

Legacy 3.0i 24V

6

02.2000→03.2002

EZ30 (154 kW)

Reference

21111-AA000	21111-AA001	21111-AA002	21111-AA003
21111-AA004	21111-AA005	21111-AA006	21111-AA007
21111-AA011			

**50 005 176**
NEW

Justy 1.3i 16V

7

09.2003→

M13A (67 kW)

**50 005 180**
NEW

Justy 1.3 TDI 16V

8

2003 →

Z 13 DT

**50 005 760****S**



Justy 1.5 16V

9

09.2003→

M15A (73 kW)







50 005 180

NEW

S

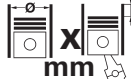

			Cyl	 mm	cm ³		Comp. Ratio ε	kW	PS	Pos
F10DN	B		4	68,5 x 72	1061	4	10:1	46	63	4
G10B (40 kW)	B		4	72 x 61	993	2	9,4:1	40	54	3
G13A (44 kW)	B		4	74 x 77	1324	2	8,9:1	44-47	60-64	25, 28
G13B (50 kW)	B		4	74 x 75,5	1298	2	8,9:1	50	68	32
G13B (63 kW)	B		4	74 x 75,5	1298	4	9,5:1	63	86	5
G13B (74 kW)	B		4	74 x 75,5	1298	4	10:1	74	101	33
G13BA	B		4	74 x 75,5	1298	2	8,9:1	50	68	26, 32
G13BB (58 kW)	B		4	74 x 75,5	1298	4	9,5:1	58	79	8, 14, 33, 40
G16A (59 kW)	B		4	75 x 90	1590	2	8,9:1	59-60	80-82	37
G16A (69 kW)	B		4	75 x 90	1590	4	9,5:1	69-70	94-95	10, 34, 38
G16B	B		4	75 x 90	1590	4	9,5:1	68-74	92-101	6, 34, 38, 42
G18A	B		4	84 x 83	1840	4	9,8:1	89	121	7
K9K 700	D	(LA)	4	76 x 80,5	1461	2	18,8:1	48-50	65-68	15
K9K 766	D	(LA)	4	76 x 80,5	1461	2	17,9:1	63	86	15
M13A (60 kW)	B		4	78 x 69,5	1328	4	9,5:1	60-62	82-85	12, 14, 16, 27
M13A (67 kW)	B		4	78 x 69,5	1328	4	9,5:1	66-69	90-94	1, 12, 16, 18, 24, 29, 33, 40
M15A (73 kW)	B		4	78 x 78	1491	4	9,5:1	73-75	99-102	20, 22, 35
M15A (81 kW)	B		4	78 x 78	1491	4	9,5:1	81	110	2, 17, 22
M16A (79 kW)	B		4	78 x 83	1586	4	10,5:1	79	107	9, 10, 23, 36, 38
RHZ	D	(LA)	4	85 x 88	1997	2	17,6:1	80-81	109-110	11, 39
Z 13 DT	D	(LA)	4	69,6 x 82	1248	4	18:1	51	69	13, 19, 21, 30, 31, 41

**Aerio 1.3i 16V****1**

10.2001→
Reference M13A (67 kW)
17400-69G00 17400-69G01



50 005 180
NEW

Aerio 1.5i 16V**2**

03.2001→
Reference M15A (81 kW)
17400-69G00 17400-69G01



50 005 180
NEW

Alto 1.0i**3**

10.1994→
Reference G10B (40 kW)
17400-82823 17400-82824 17400-82850 17400-82851



50 005 177
NEW

Alto 1.1i 16V**4**

02.2002→
Reference F10DN
17400-82823 17400-82824 17400-82850 17400-82851



50 005 177
NEW

Baleno 1.3i 16V**5**

04.1995→
Reference G13B (63 kW)
17400-82823 17400-82824 17400-82850 17400-82851



50 005 177
NEW

Baleno 1.6i 16V**6**

04.1995→
Reference G16B
17400-60810 17400-60811 17400-60812 17400-60813
17400-60814 17400-60815 17400-60A02 17400-60A04



50 005 179
NEW

Baleno 1.8i 16V**7**

09.1995→
Reference G18A
17400-60810 17400-60811 17400-60812 17400-60813
17400-60814 17400-60815 17400-60A02 17400-60A04



50 005 179
NEW

Carry 1.3i 16V**8**

1999 →
Reference G13BB (58 kW)
17400-82823 17400-82824 17400-82850 17400-82851



50 005 177
NEW

**SUZUKI****Escudo 1.6i 16V****9**

2005 → M16A (79 kW)
 Reference 17400-69G00 17400-69G01



50 005 180
NEW

Grand Vitara 1.6i 16V**10**

03.1998→ G16A (69 kW)
 Reference 17400-60810 17400-60811 17400-60812 17400-60813
 17400-60814 17400-60815 17400-60A02 17400-60A04



50 005 179
NEW

2005 → M16A (79 kW)
 Reference 17400-69G00 17400-69G01



50 005 180
NEW

Grand Vitara 2.0 HDI**11**

11.2000→ RHZ



50 005 329

Ignis 1.3i 16V**12**

10.2000→ M13A (60 kW), M13A (67 kW)
 Reference 17400-69G00 17400-69G01



50 005 180
NEW

Ignis 1.3 DDiS**13**

10.2003→ Z 13 DT
 Reference 17410-85E00



50 005 760

S**Jimny 1.3i 16V****14**

10.1998→ G13BB (58 kW)
 Reference 17400-82823 17400-82824 17400-82850 17400-82851



50 005 177
NEW

10.2000→ M13A (60 kW)
 Reference 17400-69G00 17400-69G01



50 005 180
NEW



Jimny 1.5 DDiS				15
→	K9K 766			50 005 027 NEW
12.2003→	K9K 700			50 005 171 NEW
Liana 1.3i 16V				16
03.2001→ Reference	M13A (60 kW), M13A (67 kW) 17400-69G00 17400-69G01			50 005 180 NEW
Liana 1.5i 16V				17
03.2001→ Reference	M15A (81 kW) 17400-69G00 17400-69G01			50 005 180 NEW
New Ignis 1.3i 16V				18
09.2003→ Reference	M13A (67 kW) 17400-69G00 17400-69G01			50 005 180 NEW
New Ignis 1.3 DDiS 16V				19
09.2003→ Reference	Z 13 DT 17410-85E00			50 005 760
New Ignis 1.5i 16V				20
09.2003→ Reference	M15A (73 kW) 17400-69G00 17400-69G01			50 005 180 NEW
New Swift 1.3 DDiS 16V				21
10.2004→ Reference	Z 13 DT 17410-85E00			50 005 760
New Swift 1.5i 16V				22
10.2004→ Reference	M15A (73 kW), M15A (81 kW) 17400-69G00 17400-69G01			50 005 180 NEW

S

**SUZUKI****New Swift 1.6i 16V****23**

2006 →
Reference M16A (79 kW)
17400-69G00 17400-69G01



50 005 180
NEW

New Swift R+ 1.3i 16V**24**

10.2004→
Reference M13A (67 kW)
17400-69G00 17400-69G01



50 005 180
NEW

Samurai 1.3**25**

03.1987→03.1995
Reference G13A (44 kW)
17400-82811 17400-82812 17400-83810 17400-83811
17400-83812 17400-83814



50 005 178
NEW

Samurai 1.3i**26**

06.1996→
Reference G13BA
17400-82823 17400-82824 17400-82850 17400-82851



50 005 177
NEW

Samurai 1.3i 16V**27**

→
Reference M13A (60 kW)
17400-69G00 17400-69G01



50 005 180
NEW

SJ 413 1.3**28**

11.1984→08.1990
Reference G13A (44 kW)
17400-82811 17400-82812 17400-83810 17400-83811
17400-83812 17400-83814



50 005 178
NEW

S**Solio 1.3i 16V****29**

2005 →
Reference M13A (67 kW)
17400-69G00 17400-69G01



50 005 180
NEW

Solio 1.3 DDiS 16V**30**

2005 →
Reference Z 13 DT
17410-85E00



50 005 760



**Swift 1.3 DDiS****31**

08.2005→ Reference	Z 13 DT 17410-85E00						50 005 760
-----------------------	------------------------	--	--	--	---	--	------------

Swift 1.3i**32**

03.1991→03.2001 Reference	G13B (50 kW), G13BA 17400-82823 17400-82824 17400-82850 17400-82851						50 005 177 NEW
------------------------------	---	--	--	--	---	--	--------------------------

Swift 1.3i 16V**33**

01.1989→ Reference	G13B (74 kW), G13BB (58 kW) 17400-82823 17400-82824 17400-82850 17400-82851						50 005 177 NEW
→ Reference	M13A (67 kW) 17400-69G00 17400-69G01						50 005 180 NEW

Swift 1.6i 16V**34**

09.1991→09.1995 Reference	G16A (69 kW), G16B 17400-60810 17400-60811 17400-60812 17400-60813 17400-60814 17400-60815 17400-60A02 17400-60A04						50 005 179 NEW
------------------------------	--	--	--	--	---	--	--------------------------

SX4 1.5i 16V**35**

06.2005→ Reference	M15A (73 kW) 17400-69G00 17400-69G01						50 005 180 NEW
-----------------------	--	--	--	--	---	--	--------------------------

SX4 1.6i 16V**36**

06.2005→ Reference	M16A (79 kW) 17400-69G00 17400-69G01						50 005 180 NEW
-----------------------	--	--	--	--	---	--	--------------------------

Vitara 1.6i**37**

03.1988→03.1998 Reference	G16A (59 kW) 17400-60810 17400-60811 17400-60812 17400-60813 17400-60814 17400-60815 17400-60A02 17400-60A04						50 005 179 NEW
------------------------------	--	--	--	--	---	--	--------------------------

**SUZUKI****Vitara 1.6i 16V****38**

07.1990→	G16A (69 kW), G16B					50 005 179 <small>NEW</small>
Reference	17400-60810 17400-60814	17400-60811 17400-60815	17400-60812 17400-60A02	17400-60813 17400-60A04		
2005 →	M16A (79 kW)					50 005 180 <small>NEW</small>
Reference	17400-69G00	17400-69G01				

Vitara 2.0 HDI**39**

11.2000→	RHZ					50 005 329

Wagon R+ 1.3i 16V**40**

05.2000→	G13BB (58 kW)					50 005 177 <small>NEW</small>
Reference	17400-82823	17400-82824	17400-82850	17400-82851		
09.2003→	M13A (67 kW)					50 005 180 <small>NEW</small>
Reference	17400-69G00	17400-69G01				





Wagon R+ 1.3 DDiS**41**

09.2003→	Z 13 DT					50 005 760
Reference	17410-85E00					

S**X-90 1.6i 16V****42**

09.1995→	G16B					50 005 179 <small>NEW</small>
Reference	17400-60810 17400-60814	17400-60811 17400-60815	17400-60812 17400-60A02	17400-60813 17400-60A04		

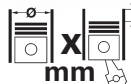

			Cyl	 mm	cm ³		Comp. Ratio ε	kW	PS	Pos
F 6 L 413 F	D	(AN)	6	125 x 130	9572	2	18:1	104-188	141-256	2
F 6 L 413 R	D	(AN)	6	120 x 130	8822	2	18:1	100-135	136-183	1
F 8 L 413 F	D	(AN)	8	125 x 130	12763	2	18:1	147-188	200-255	3



TAM



110 A 8

1

1973 → 1977

F 6 L 413 R



50 005 871

NEW

150

2

1978 →

F 6 L 413 F



50 005 874

260

3

1984 →





F 8 L 413 F





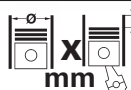

50 005 368

T



			Cyl	 mm	cm ³		Comp. Ratio ε	kW	PS	Pos
1AZ-FSE (110 kW)	B		4	86 x 86	1998	4	9,8:1	110	150	10
1AZ-FSE (114 kW)	B		4	86 x 86	1998	4	10,5:1	114	155	3, 10, 15, 18, 31, 100, 109, 114, 137, 140, 154, 165, 202, 207
1C	D	(AN)	4	83 x 85	1839	2	22,5:1	43-48	58-65	40, 69, 79, 125
1C-L	D	(AN)	4	83 x 85	1839	2	23:1	42-50	57-68	69, 177
1CD-FTV (66 kW)	D	(LA)	4	82,2 x 94	1995	4	18,6:1	66	90	71, 75
1CD-FTV (81 kW)	D	(LA)	4	82,2 x 94	1995	4	18,6:1	81-85	110-116	12, 16, 19, 71, 75, 110, 155, 166
1E-L	B		4	70,5 x 64	999	3	9:1	40	54	180
1HD-FTE	D	(LA)	6	94 x 100	4164	4	18,8:1	144-150	196-204	94, 123
1HD-T	D	(A)	6	94 x 100	4164	2	18,6:1	121-125	165-170	56, 122
1HZ	D	(AN)	6	94 x 100	4164	2	22,7:1	96-99	130-135	55, 121
1ND-TV (53 kW)	D	(LA)	4	73 x 81,5	1364	2	18,5:1	53-55	72-75	115, 200, 210, 212
1NZ-FE	B		4	75 x 84,7	1497	4	10,5:1	77-81	105-110	1, 6, 7, 23, 25, 26, 66, 98, 116, 146, 148, 152, 159, 162, 163, 167, 168, 169, 186, 191, 194, 201, 204, 211, 213
1NZ-FXE	B		4	75 x 84,7	1497	4	13:1	43-57	58-77	157
1SZ-FE	B		4	69 x 66,7	998	4	10:1	48-51	65-70	198, 208
1ZZ-FE	B		4	79 x 91,5	1794	4	10,5:1	92-107	125-145	2, 9, 30, 50, 68, 74, 113, 131, 139, 153, 164, 171, 195, 206
2AZ-FE (112 kW)	B		4	88,5 x 96	2362	4	9,6:1	112-125	152-170	4, 17, 37, 39, 72, 99, 102, 106, 112, 117, 132, 138, 156, 165, 187, 192
2AZ-FSE	B		4	88,5 x 96	2362	4	11:1	120	163	17, 27, 130
2C	D	(AN)	4	86 x 85	1974	2	23:1	53-54	72-73	34, 43, 47, 70, 81, 126, 133, 178
2C-E	D	(AN)	4	86 x 85	1974	2	23:1	53	72	70
2C-L	D	(AN)	4	86 x 85	1974	2	22,5/ 23:1	50-55	68-75	43, 81
2C-TE	D	(LA)	4	86 x 85	1975	2	23:1	66	90	11, 48
2E	B		4	73 x 77,4	1296	3	9,5:1	53-55	72-75	57, 61, 173, 183
2E-E	B		4	73 x 77,4	1296	3	9,5:1	55-60	75-82	62, 173, 183
2E-L	B		4	73 x 77,4	1296	3	9,5:1	55	75	60, 182
2E-LC	B		4	73 x 77,4	1296	2	9:1	53-55	72-75	60, 182
2K	B		4	72 x 61	993	2	8,5:1	33	45	160, 179
2L	D	(AN)	4	92 x 92	2466	2	22,3:1	53-62	72-85	28, 53, 85, 88, 90, 95, 96, 103, 107, 118, 128, 150, 190
2L-T	D	(A)	4	92 x 92	2446	2	20:1	62-71	85-96	29, 54, 86, 89, 91, 119, 129, 149
2L-T II	D	(A)	4	92 x 92	2446	2	22:1	66-71	90-97	29, 54, 89, 104, 108, 119, 129
2L-TE	D	(A)	4	92 x 92	2446	2	21/22:1	66-71	90-97	29, 54, 89, 104, 108, 119, 129, 149, 214
2NZ-FE	B		4	75 x 73,5	1299	4	10,5:1	64-66	87-90	22, 24, 63, 145, 147, 158, 193, 199, 203, 209
2ZZ-GE (132 kW)	B		4	82 x 85	1796	4	11,5:1	132-141	180-192	50, 68, 131
3C-TE	D	(LA)	4	86 x 94	2184	2	22,6:1	94	128	32, 36, 82, 101, 111, 144, 197
3E	B		4	73 x 87	1456	3	9,3:1	58-65	79-87	65, 76, 185, 188
3K-H	B		4	75 x 66	1166	2	9	40-43	54-58	59, 161, 172, 181
3L	D	(AN)	4	96 x 96	2779	2	22,2:1	67	91	97, 105, 120, 151, 215
3S-FE (89 kW)	B		4	86 x 86	1998	4	9,3:1	85-96	116-130	33, 42, 46, 51, 80, 134, 143, 165, 196
3S-FE (94 kW)	B		4	86 x 86	1998	4	9,5:1	85-96	116-131	10, 31, 42, 51, 80, 93, 100, 109, 136, 205
3S-GE (115 kW)	B		4	86 x 86	1998	4	10,3:1	115-132	156-180	46, 51, 93, 134
3S-GE (121 kW)	B		4	86 x 86	1998	4	10,1:1	121	165	42, 51, 80, 93, 196
3ZZ-FE	B		4	79 x 81,5	1598	4	10,5:1	81	110	8, 13, 67, 73
4A-FE (70 kW)	B		4	81 x 77	1587	4	9,5:1	70-84	95-114	8, 41, 44, 49, 58, 67, 77
4A-FE (84 kW)	B		4	81 x 77	1587	4	9,5:1	84	114	41, 44, 58, 77, 170, 175
4E-FE (55 kW)	B		4	74 x 77,4	1332	4	9,6:1	55	75	63, 83, 184
4E-FE (63 kW)	B		4	74 x 77,4	1332	4	10:1	63	86	63, 141
4E-FE (65 kW)	B		4	74 x 77,4	1332	4	9,8:1	65-73	88-99	63, 83, 174, 184
4K	B		4	75 x 73	1290	2	9:1	44-48	60-65	60, 124, 182
4K-C	B		4	75 x 73	1290	2	9:1	43	58	60, 124, 182

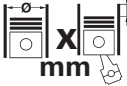

			Cyl	 mm	cm ³		Comp. Ratio ε	kW	PS	Pos
4S-FE	B		4	82,5 x 86	1839	4	9,5:1	88-92	120-125	78, 87, 92, 127
4ZZ-FE	B		4	79 x 71,3	1398	4	10,5:1	71	97	5, 64
5E-FE (67 kW)	B		4	74 x 87	1497	4	9,8:1	61-69	83-94	66, 84, 142, 163, 189
5S-FE (100 kW)	B		4	87,1 x 90,9	2164	4	9,5:1	96-101	131-135	35, 38, 52, 135
7A-FE	B		4	81 x 85,5	1762	4	9,5:1	78-89	105-120	9, 14, 30, 45, 50, 68, 78, 92, 176
DV4 TD	D	(LA)	4	73,7 x 82	1398	2	17,9:1	40-50	54-68	20
OM 314.910	D	(AN)	4	97 x 128	3780	2	17:1	63	85	21

**Allion 1.5i 16V****1**

01.2002→	1NZ-FE							
Reference	16100-29155	16100-29156	16100-29195					50 005 188 <small>NEW</small>

Allion 1.8i 16V**2**

05.2002→2006	1ZZ-FE							
Reference	16100-09080	16100-29095	16100-29175	16100-29415				50 005 183 <small>NEW</small>

Allion 2.0i 16V**3**

12.2001→05.2006	1AZ-FSE (114 kW)							
Reference	16100-0H010	16100-28040						50 005 799

Alphard 2.4i 16V**4**

2002 → 2004	2AZ-FE (112 kW)							
Reference	16100-0H010	16100-28040						50 005 799

Auris 1.4i 16V**5**

02.2007→	4ZZ-FE							
Reference	16100-09080	16100-29095	16100-29175	16100-29415				50 005 183 <small>NEW</small>

Auris 1.5i 16V**6**

→	1NZ-FE							
Reference	16100-29155	16100-29156	16100-29195					50 005 188 <small>NEW</small>

Avanza 1.5i 16V**7**

2003 →	1NZ-FE							
Reference	16100-29155	16100-29156	16100-29195					50 005 188 <small>NEW</small>

Avensis I 1.6i 16V**8**

10.1997→07.2000	4A-FE (70 kW)							
Reference	16100-19295 16110-19146	16100-19296 16110-19205	16110-19135 16110-19255	16110-19145				50 005 184 <small>NEW</small>

08.2000→01.2003	3ZZ-FE							
Reference	16100-09080	16100-29095	16100-29175	16100-29415				50 005 183 <small>NEW</small>

T



TOYOTA





Avensis I 1.8i 16V

9

10.1997→07.2000	7A-FE							
Reference	16110-19175	16110-19176	16110-19185					50 005 197 NEW
08.2000→03.2003	1ZZ-FE							
Reference	16100-09080	16100-29095	16100-29175	16100-29415				50 005 183 NEW

Avensis I 2.0i 16V

10

09.1997→10.2000	3S-FE (94 kW)							
Reference	16100-79075 16110-79026	16100-79185	16110-09010	16110-79025				50 005 187 NEW
1998 → 05.2006	1AZ-FSE (110 kW), 1AZ-FSE (114 kW)							
Reference	16100-0H010	16100-28040						50 005 799

Avensis I 2.0 D-4D

11

10.1997→07.2000	2C-TE							
Reference	16100-69295	16100-69296	16100-69335	16100-69435				50 005 182 NEW

Avensis I 2.0 D-4D 16V

12

08.1999→01.2003	1CD-FTV (81 kW)							
Reference	16100-29135							50 005 198 NEW

Avensis II 1.6i 16V

13

02.2003→12.2008	3ZZ-FE							
Reference	16100-09080	16100-29095	16100-29175	16100-29415				50 005 183 NEW

Avensis II 1.8i 16V

14

04.2003→12.2008	7A-FE							
Reference	16110-19175	16110-19176	16110-19185					50 005 197 NEW

Avensis II 2.0i 16V

15

06.2006→12.2008	1AZ-FSE (114 kW)							
Reference	16100-0H010	16100-28040						50 005 799

T

**Avensis II 2.0 D-4D 16V****16**

02.3003→12.2008 1CD-FTV (81 kW)
Reference 16100-29135



50 005 198
NEW

Avensis II 2.4i 16V**17**

2001 → 2AZ-FE (112 kW) , 2AZ-FSE
Reference 16100-0H010 16100-28040



50 005 799

Avensis Verso 2.0i 16V**18**

05.2001→07.2005 1AZ-FSE (114 kW)
Reference 16100-0H010 16100-28040



50 005 799

Avensis Verso 2.0 D-4D 16V**19**

05.2001→ 1CD-FTV (81 kW)
Reference 16100-29135



50 005 198
NEW

Aygo 1.4 D-4D**20**

07.2005→ DV4 TD



50 005 758

Bandeirante 3.8 D**21**

1984 → OM 314.910
020056 →



50 005 843

1984 → OM 314.910
→020055



50 005 835

bB 1.3i 16V**22**

2000 → 2005 2NZ-FE
Reference 16100-29155 16100-29156 16100-29195



50 005 188
NEW

T

**bB 1.5i 16V****23**

2000 → 2005

1NZ-FE

Reference

16100-29155

16100-29156

16100-29195

**50 005 188****NEW****Belta 1.3i 16V****24**

11.2005→

2NZ-FE

Reference

16100-29155

16100-29156

16100-29195

**50 005 188****NEW****Belta 1.5i 16V****25**

2007 →

1NZ-FE

Reference

16100-29155

16100-29156

16100-29195

**50 005 188****NEW****Blade 1.5i 16V****26**

02.2007→

1NZ-FE

Reference

16100-29155

16100-29156

16100-29195

**50 005 188****NEW****Blade 2.4i 16V****27**

12.2006→

2AZ-FSE

Reference

16100-0H010

16100-28040

**50 005 799****Blizzard 2.4 D****28**

07.1984→

2L

Reference

16100-59155

16100-59255

16100-59256

16100-59257

**50 005 186****NEW****Blizzard 2.4 TD****29**

08.1988→

2L-T II, 2L-TE

Reference

16100-59155

16100-59255

16100-59256

16100-59257

**50 005 186****NEW**

07.1984→08.1988

2L-T

Reference

16100-59135

16100-59136

16100-59137

16100-59138

**50 005 192****NEW****T**

**Caldina 1.8i 16V****30**

1997 → 08.2002

7A-FE

Reference

16110-19175

16110-19176

16110-19185

**50 005 197**

NEW

09.2002→2007

1ZZ-FE

Reference

16100-09080

16100-29095

16100-29175

16100-29415

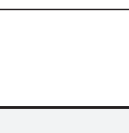
**50 005 183**

NEW

Caldina 2.0i 16V**31**

1997 → 2002

3S-FE (94 kW)

Reference

16100-79075

16100-79185

16110-09010

16110-79025

16110-79026

**50 005 187**

NEW

09.2002→2007

1AZ-FSE (114 kW)

Reference

16100-0H010

16100-28040

**50 005 799****Caldina 2.2 TD****32**

1997 → 03.2002

3C-TE

Reference

16100-69295

16100-69296

16100-69335

16100-69435

**50 005 182**

NEW

Camry 2.0i 16V**33**

12.1986→05.1991

3S-FE (89 kW)

Reference

16100-79075

16100-79185

16110-09010

16110-79025

16110-79026

**50 005 187**

NEW

Camry 2.0 D**34**

05.1984→

2C

Reference

16100-69295

16100-69296

16100-69335

16100-69435

**50 005 182**

NEW

Camry 2.2i**35**

09.1991→11.2001

5S-FE (100 kW)

Reference

16100-79075

16100-79185

16110-09010

16110-79025

16110-79026

**50 005 187**

NEW



TOYOTA



Camry 2.2 TD

36

07.1994→

3C-TE

Reference

16100-69295

16100-69296

16100-69335

16100-69435

50 005 182
NEW

Camry 2.4i 16V

37

08.2001→01.2006

2AZ-FE (112 kW)

Reference

16100-0H010

16100-28040

50 005 799

Camry Solara 2.2i 16V

38

10.1998→2003

5S-FE (100 kW)

Reference

16100-79075

16100-79185

16110-09010

16110-79025

16110-79026

50 005 187
NEW

Camry Solara 2.4i 16V

39

2002 → 11.2008

2AZ-FE (112 kW)

Reference

16100-0H010

16100-28040

50 005 799

Carina I 1.8 D

40

04.1982→09.1983

1C

Reference

16100-69295

16100-69296

16100-69335

16100-69435

50 005 182
NEW

Carina II 1.6i 16V

41

12.1987→1998

4A-FE (70 kW), 4A-FE (84 kW)

Reference

16100-19295

16100-19296

16110-19135

16110-19145

16110-19146

16110-19205

16110-19255

50 005 184
NEW
T

Carina II 2.0i 16V

42

12.1987→

3S-FE (89 kW), 3S-FE (94 kW), 3S-GE (121 kW)

Reference

16100-79075

16100-79185

16110-09010

16110-79025

16110-79026

50 005 187
NEW

Carina II 2.0 D

43

10.1983→01.1992

2C, 2C-L

Reference

16100-69295

16100-69296

16100-69335

16100-69435

50 005 182
NEW

**Carina E 1.6i 16V****44**

03.1992→10.1997	4A-FE (70 kW), 4A-FE (84 kW)					50 005 184 <small>NEW</small>
Reference	16100-19295 16110-19146	16100-19296 16110-19205	16110-19135 16110-19255	16110-19145		

Carina E 1.8i 16V**45**

12.1992→10.1997	7A-FE					50 005 197 <small>NEW</small>
Reference	16110-19175	16110-19176	16110-19185			

Carina E 2.0i 16V**46**

03.1992→09.1997	3S-FE (89 kW), 3S-GE (115 kW)					50 005 187 <small>NEW</small>
Reference	16100-79075 16110-79026	16100-79185	16110-09010	16110-79025		

Carina E 2.0 D**47**

02.1992→01.1996	2C					50 005 182 <small>NEW</small>
Reference	16100-69295	16100-69296	16100-69335	16100-69435		

Carina E 2.0 TD**48**

08.1997→10.1997	2C-TE					50 005 182 <small>NEW</small>
Reference	16100-69295	16100-69296	16100-69335	16100-69435		













Celica 1.6i 16V dopp**49**

10.1989→10.1993	4A-FE (70 kW)					50 005 184 <small>NEW</small>
Reference	16100-19295 16110-19146	16100-19296 16110-19205	16110-19135 16110-19255	16110-19145		

Celica 1.8i 16V**50****T**

11.1993→08.1999	7A-FE					50 005 197 <small>NEW</small>
Reference	16110-19175	16110-19176	16110-19185			
11.1999→11.2004	1ZZ-FE					50 005 183 <small>NEW</small>
Reference	16100-09080	16100-29095	16100-29175	16100-29415		

**TOYOTA**

				
11.1999→11.2004 Reference	2ZZ-GE (132 kW) 16100-29145			50 005 904
Celica 2.0i 16V 51				
01.1986→10.1999 Reference	3S-FE (89 kW), 3S-FE (94 kW), 3S-GE (115 kW), 3S-GE (121 kW) 16100-79075 16100-79185 16110-09010 16110-79025 16110-79026			50 005 187 NEW
Celica 2.2i 52				
11.1989→10.1999 Reference	5S-FE (100 kW) 16100-79075 16100-79185 16110-09010 16110-79025 16110-79026			50 005 187 NEW
Chaser 2.4 D 53				
08.1988→ Reference	2L 16100-59155 16100-59255 16100-59256 16100-59257			50 005 186 NEW
Chaser 2.4 TD 54				
08.1988→ Reference	2L-T II, 2L-TE 16100-59155 16100-59255 16100-59256 16100-59257			50 005 186 NEW
08.1980→08.1988 Reference	2L-T 16100-59135 16100-59136 16100-59137 16100-59138 16100-59139			50 005 192 NEW
Coaster 4.2 D 55				
01.1993→05.1997 Reference	1HZ 16100-19235			50 005 193 NEW
Coaster 4.2 TD 56				
01.1990→01.1993 Reference	1HD-T 16100-19235			50 005 193 NEW

T

**Conquest 1.3i 16V****57**

10.1988→	2E							
Reference	16110-19055 16110-19106	16110-19065	16110-19095	16110-19105				50 005 194 NEW

Conquest 1.6i 16V**58**

10.1988→07.2005	4A-FE (70 kW), 4A-FE (84 kW)							
Reference	16100-19295 16110-19146	16100-19296 16110-19205	16110-19135 16110-19255	16110-19145				50 005 184 NEW

Corolla 1.2**59**

03.1974→08.1979	3K-H							
Reference	16100-19015	16100-19016	16100-19017					50 005 196 NEW

Corolla 1.3**60**

09.1979→07.1987	4K, 4K-C							
Reference	16100-19015	16100-19016	16100-19017					50 005 196 NEW

10.1984→04.1987	2E-L, 2E-LC							
Reference	16110-19055 16110-19106	16110-19065	16110-19095	16110-19105				50 005 194 NEW

Corolla 1.3 12V**61**

05.1987→05.1995	2E							
Reference	16110-19055 16110-19106	16110-19065	16110-19095	16110-19105				50 005 194 NEW

Corolla 1.3i 12V**62**

08.1989→04.1992	2E-E							
Reference	16110-19055 16110-19106	16110-19065	16110-19095	16110-19105				50 005 194 NEW

Corolla 1.3i 16V**63**

08.2000→	2NZ-FE							
Reference	16100-29155	16100-29156	16100-29195					50 005 188 NEW



TOYOTA

07.1992→02.2000 Reference	4E-FE (55 kW), 4E-FE (63 kW), 4E-FE (65 kW) 16110-19055 16110-19106	16110-19065	16110-19095	16110-19105		50 005 194 NEW
Corolla 1.4i 16V						64
10.1999→ Reference	4ZZ-FE 16100-09080	16100-29095	16100-29175	16100-29415		50 005 183 NEW
Corolla 1.5 12V						65
05.1986→1994 Reference	3E 16110-19055 16110-19106	16110-19065	16110-19095	16110-19105		50 005 194 NEW
Corolla 1.5i 16V						66
10.2006→ Reference	1NZ-FE 16100-29155	16100-29156	16100-29195			50 005 188 NEW
10.1994→1998 Reference	5E-FE (67 kW) 16110-19055 16110-19106	16110-19065	16110-19095	16110-19105		50 005 194 NEW
Corolla 1.6i 16V						67
05.1987→02.2000 Reference	4A-FE (70 kW) 16100-19295 16110-19146	16100-19296 16110-19205	16110-19135 16110-19255	16110-19145		50 005 184 NEW
10.1999→12.2001 Reference	3ZZ-FE 16100-09080	16100-29095	16100-29175	16100-29415		50 005 183 NEW
Corolla 1.8i 16V						68
05.1987→04.1997 Reference	7A-FE 16110-19175	16110-19176	16110-19185			50 005 197 NEW
10.2001→ Reference	1ZZ-FE 16100-09080	16100-29095	16100-29175	16100-29415		50 005 183 NEW
10.2001→2005 Reference	2ZZ-GE (132 kW) 16100-29145					50 005 904

T



Corolla 1.8 D 69						
02.1983→04.1992 Reference	1C, 1C-L 16100-69295	16100-69296	16100-69335	16100-69435		50 005 182 <small>NEW</small>
Corolla 2.0 D 70						
05.1992→09.1999 Reference	2C, 2C-E 16100-69295	16100-69296	16100-69335	16100-69435		50 005 182 <small>NEW</small>
Corolla 2.0 4-4D 16V 71						
09.2000→2007 Reference	1CD-FTV (66 kW), 1CD-FTV (81 kW) 16100-29135					50 005 198 <small>NEW</small>
Corolla 2.4i 16V 72						
11.2006→ Reference	2AZ-FE (112 kW) 16100-0H010	16100-28040				50 005 799
Corolla Verso 1.6i 16V 73						
09.2001→ Reference	3ZZ-FE 16100-09080	16100-29095	16100-29175	16100-29415		50 005 183 <small>NEW</small>
Corolla Verso 1.8i 16V 74						
03.2003→ Reference	1ZZ-FE 16100-09080	16100-29095	16100-29175	16100-29415		50 005 183 <small>NEW</small>
Corolla Verso 2.0 D-4D 16V 75						
10.2001→2006 Reference	1CD-FTV (66 kW), 1CD-FTV (81 kW) 16100-29135					50 005 198 <small>NEW</small>
Corona 1.5 12V 76						
12.1987→02.1992 Reference	3E 16110-19055 16110-19106	16110-19065	16110-19095	16110-19105		50 005 194 <small>NEW</small>
Corona 1.6i 16V 77						
08.1988→02.1998 Reference	4A-FE (70 kW), 4A-FE (84 kW) 16100-19295 16110-19146	16100-19296 16110-19205	16110-19135 16110-19255	16110-19145		50 005 184 <small>NEW</small>

T

**Corona 1.8i 16V****78**

11.1989→01.1996	4S-FE						
Reference	16100-79075 16110-79026	16100-79185	16110-09010	16110-79025			50 005 187 NEW
03.1992→01.1996	7A-FE						
Reference	16110-19175	16110-19176	16110-19185				50 005 197 NEW

Corona 1.8 D**79**

12.1986→11.1991	1C						
Reference	16100-69295	16100-69296	16100-69335	16100-69435			50 005 182 NEW

Corona 2.0i 16V**80**

12.1987→01.1996	3S-FE (89 kW), 3S-FE (94 kW), 3S-GE (121 kW)						
Reference	16100-79075 16110-79026	16100-79185	16110-09010	16110-79025			50 005 187 NEW

Corona 2.0 D**81**

10.1983→12.1987	2C, 2C-L						
Reference	16100-69295	16100-69296	16100-69335	16100-69435			50 005 182 NEW

Corona 2.2 TD**82**

06.1999→	3C-TE						
Reference	16100-69295	16100-69296	16100-69335	16100-69435			50 005 182 NEW

Corsa 1.3 16V**83**

12.1989→	4E-FE (55 kW), 4E-FE (65 kW)						
Reference	16110-19055 16110-19106	16110-19065	16110-19095	16110-19105			50 005 194 NEW

Corsa 1.5i 16V**84**

10.1994→	5E-FE (67 kW)						
Reference	16110-19055 16110-19106	16110-19065	16110-19095	16110-19105			50 005 194 NEW

T

**Cressida 2.4 D****85**

08.1984→08.1996

2L

Reference

16100-59155

16100-59255

16100-59256

16100-59257

**50 005 186**

NEW

Cressida 2.4 TD**86**

08.1984→08.1986

2L-T

Reference

16100-59135

16100-59136

16100-59137

16100-59138

16100-59139

**50 005 192**

NEW

Cresta 1.8i 16V**87**

10.1992→08.1996

4S-FE

Reference

16100-79075

16100-79185

16110-09010

16110-79025

16110-79026

**50 005 187**

NEW

Cresta 2.4 D**88**

03.1980→

2L

Reference

16100-59155

16100-59255

16100-59256

16100-59257

**50 005 186**

NEW

Cresta 2.4 TD**89**

08.1988→

2L-T II, 2L-TE

Reference

16100-59155

16100-59255

16100-59256

16100-59257

**50 005 186**

NEW

03.1980→08.1988

2L-T

Reference

16100-59135

16100-59136

16100-59137

16100-59138

16100-59139

**50 005 192**

NEW

Crown 2.4 D**90**

08.1983→

2L

Reference

16100-59155

16100-59255

16100-59256

16100-59257

**50 005 186**

NEW

Crown 2.4 TD**91**

08.1982→08.1986

2L-T

Reference

16100-59135

16100-59136

16100-59137

16100-59138

16100-59139

**50 005 192**

NEW

**TOYOTA****Curren 1.8i 16V****92**

01.1994→1998

4S-FE

Reference

16100-79075
16110-79026

16100-79185

16110-09010

16110-79025

**50 005 187****NEW**

1994 → 1999

7A-FE

Reference

16110-19175

16110-19176

16110-19185

**50 005 197****NEW****Curren 2.0i 16V****93**

1994 → 1998

3S-FE (94 kW), 3S-GE (115 kW), 3S-GE (121 kW)

Reference

16100-79075
16110-79026

16100-79185

16110-09010

16110-79025

**50 005 187****NEW****Cygnus 4.2 TD****94**

2003 →

1HD-FTE

Reference

16100-19235

**50 005 193****NEW****Dyna 100 2.5 D****95**

08.1985→05.1995

2L

Reference

16100-59155

16100-59255

16100-59256

16100-59257

**50 005 186****NEW****Dyna 150 2.5 D****96**

08.1985→08.1988

2L

Reference

16100-59155

16100-59255

16100-59256

16100-59257

**50 005 186****NEW****Dyna 150 2.8 D****97**

08.1988→05.1995

3L

Reference

16100-59155

16100-59255

16100-59256

16100-59257

**50 005 186****NEW****Echo 1.5i 16V****98**

08.1999→

1NZ-FE

Reference

16100-29155

16100-29156

16100-29195

**50 005 188****NEW****T**

**Estima 2.4i 16V****99**

09.2000→ Reference	2AZ-FE (112 kW) 16100-0H010 16100-28040			50 005 799
-----------------------	---	---	--	------------

Gaia 2.0i 16V**100**

10.1998→ Reference	3S-FE (94 kW) 16100-79075 16100-79185 16110-09010 16110-79025 16110-79026			50 005 187 <small>NEW</small>
→ Reference	1AZ-FSE (114 kW) 16100-0H010 16100-28040			50 005 799

Gaia 2.2 TD**101**

06.1999→ Reference	3C-TE 16100-69295 16100-69296 16100-69335 16100-69435			50 005 182 <small>NEW</small>
-----------------------	---	---	--	----------------------------------

Harrier 2.4i 16V**102**

1997 → 2003 Reference	2AZ-FE (112 kW) 16100-0H010 16100-28040			50 005 799
--------------------------	---	---	--	------------

HiAce 2.4 D**103**

01.1984→07.1995 Reference	2L 16100-59155 16100-59255 16100-59256 16100-59257			50 005 186 <small>NEW</small>
------------------------------	--	---	--	----------------------------------

HiAce 2.4 TD**104**





08.1995→08.2001 Reference	2L-T II, 2L-TE 16100-59155 16100-59255 16100-59256 16100-59257			50 005 186 <small>NEW</small>
------------------------------	--	---	--	----------------------------------

HiAce 2.8 D**105**

08.1988→08.1995 Reference	3L 16100-59155 16100-59255 16100-59256 16100-59257			50 005 186 <small>NEW</small>
------------------------------	--	---	--	----------------------------------

**TOYOTA****Highlander 2.4i 16V****106**01.2001→2003
Reference2AZ-FE (112 kW)
16100-0H010 16100-28040**50 005 799****HiLux 2.4 D****107**1978 → 11.1989
Reference2L
16100-59155 16100-59255 16100-59256 16100-59257**50 005 186**
NEW**HiLux 2.4 TD****108**08.1988→08.2001
Reference2L-T II, 2L-TE
16100-59155 16100-59255 16100-59256 16100-59257**50 005 186**
NEW**Ipsium 2.0i 16V****109**1995 → 2002
Reference3S-FE (94 kW)
16100-79075 16100-79185 16110-09010 16110-79025
16110-79026**50 005 187**
NEW06.2001→
Reference1AZ-FSE (114 kW)
16100-0H010 16100-28040**50 005 799****Ipsium 2.0 D-4D 16V****110**06.2001→
Reference1CD-FTV (81 kW)
16100-29135**50 005 198**
NEW**Ipsium 2.2 TD****111**1995 → 2001
Reference3C-TE
16100-69295 16100-69296 16100-69335 16100-69435**50 005 182**
NEW**Ipsium 2.4i 16V****112**06.2001→
Reference2AZ-FE (112 kW)
16100-0H010 16100-28040**50 005 799****T**



Isis 1.8i 16V										113
09.2004→	1ZZ-FE								50 005 183	
Reference	16100-09080	16100-29095	16100-29175	16100-29415					NEW	
Isis 2.0i 16V										114
10.2004→	1AZ-FSE (114 kW)								50 005 799	
Reference	16100-0H010	16100-28040								
Ist 1.4 D-4D										115
2002 → 2007	1ND-TV (53 kW)								50 005 188	
Reference	16100-29155	16100-29156	16100-29195						NEW	
Ist 1.5i 16V										116
2002 → 2007	1NZ-FE								50 005 188	
Reference	16100-29155	16100-29156	16100-29195						NEW	
Kluger 2.4i 24V										117
04.2001→2003	2AZ-FE (112 kW)								50 005 799	
Reference	16100-0H010	16100-28040								
Land Cruiser 2.4 D										118
11.1984→03.1990	2L								50 005 186	
Reference	16100-59155	16100-59255	16100-59256	16100-59257						NEW
Land Cruiser 2.4 TD										119
08.1988→	2L-T II, 2L-TE								50 005 186	
Reference	16100-59155	16100-59255	16100-59256	16100-59257						NEW
11.1984→03.1990	2L-T								50 005 192	
Reference	16100-59135 16100-59139	16100-59136	16100-59137	16100-59138						NEW

T



TOYOTA



Land Cruiser 2.8 D

120

05.1996→09.2002 3L
Reference 16100-59155 16100-59255 16100-59256 16100-59257

50 005 186
NEW

Land Cruiser 4.2 D

121

01.1990→08.1999 1HZ
Reference 16100-19235

50 005 193
NEW

Land Cruiser 4.2 TD

122

01.1990→01.1998 1HD-T
Reference 16100-19235

50 005 193
NEW

Land Cruiser 4,2 TD 24V

123

01.1998→
Reference 1HD-FTE 16100-19235

50 005 193
NEW

LiteAce 1.3

124

10.1979→08.1985 4K, 4K-C
Reference 16100-19015 16100-19016 16100-19017

50 005 196
NEW

LiteAce 1.8 D

125

10.1982→08.1988 1C
Reference 16100-69295 16100-69296 16100-69335 16100-69435

50 005 182
NEW

T

LiteAce 2.0 D

126

08.1988→01.1995 2C
Reference 16100-69295 16100-69296 16100-69335 16100-69435

50 005 182
NEW

Mark II 1.8i 16V

127

10.1992→1996 4S-FE
Reference 16100-79075 16100-79185 16110-09010 16110-79025
16110-79026

50 005 187
NEW

**Mark II 2.4 D****128**

1985 → 1994

2L

Reference

16100-59155

16100-59255

16100-59256

16100-59257

**50 005 186****NEW****Mark II 2.4 TD****129**

08.1988→

2L-T II, 2L-TE

Reference

16100-59155

16100-59255

16100-59256

16100-59257

**50 005 186****NEW**

1984 → 08.1988

2L-T

Reference

16100-59135

16100-59136

16100-59137

16100-59138

16100-59139

**50 005 192****NEW****Mark X 2.4i 16V****130**

09.2007→

2AZ-FSE

Reference

16100-0H010

16100-28040

**50 005 799****Matrix 1.8i 16V****131**

10.2002→

1ZZ-FE

Reference

16100-09080

16100-29095

16100-29175

16100-29415

**50 005 183****NEW**

10.2002→01.2008

2ZZ-GE (132 kW)

Reference

16100-29145

50 005 904**Matrix 2.4i 16V****132**

02.2008→

2AZ-FE (112 kW)

Reference

16100-0H010

16100-28040

**50 005 799****Model F 2.0 D****133**

05.1983→07.1988

2C

Reference

16100-69295

16100-69296

16100-69335

16100-69435

**50 005 182****NEW****T**

**TOYOTA****MR2 2.0i 16V****134**

12.1989→09.1999 3S-FE (89 kW), 3S-GE (115 kW)

Reference 16100-79075 16100-79185 16110-09010 16110-79025

**50 005 187**
NEW**MR2 2.2i 16V****135**

04.1989→09.1999 5S-FE (100 kW)

Reference 16100-79075 16100-79185 16110-09010 16110-79025

**50 005 187**
NEW**Nadia 2.0i 16V****136**

04.1998→08.2003 3S-FE (94 kW)

Reference 16100-79075 16100-79185 16110-09010 16110-79025

**50 005 187**
NEW**Noah 2.0i 16V****137**

2005 → 1AZ-FSE (114 kW)

Reference 16100-0H010 16100-28040

**50 005 799****Noah 2.4i 16V****138**

03.2001→ 2AZ-FE (112 kW)

Reference 16100-0H010 16100-28040

**50 005 799****Opa 1.8i 16V****139**

2000 → 12.2005 1ZZ-FE

Reference 16100-09080 16100-29095 16100-29175 16100-29415

50 005 183
NEW**Opa 2.0i 16V****140**

06.2002→12.2005 1AZ-FSE (114 kW)

Reference 16100-0H010 16100-28040









**50 005 799****Paseo 1.3i 16V****141**

01.1996→ 4E-FE (63 kW)

Reference 16110-19055 16110-19065 16110-19095 16110-19105

**50 005 194**
NEW**T**











Paseo 1.5i 16V										142
08.1995→07.1999	5E-FE (67 kW)									
Reference	16110-19055 16110-19106	16110-19065	16110-19095	16110-19105						50 005 194 NEW
Picnic 2.0i 16V										143
12.1996→12.2001	3S-FE (89 kW)									
Reference	16100-79075 16110-79026	16100-79185	16110-09010	16110-79025						50 005 187 NEW
Picnic 2.2 TD										144
08.1998→12.2001	3C-TE									
Reference	16100-69295	16100-69296	16100-69335	16100-69435						50 005 182 NEW
Platz 1.3i 16V										145
10.1999→	2NZ-FE									
Reference	16100-29155	16100-29156	16100-29195							50 005 188 NEW
Platz 1.5i 16V										146
2000 → 2005	1NZ-FE									
Reference	16100-29155	16100-29156	16100-29195							50 005 188 NEW
Porte 1.3i 16V										147
07.2004→	2NZ-FE									
Reference	16100-29155	16100-29156	16100-29195							50 005 188 NEW
Porte 1.5i 16V										148
07.2004→	1NZ-FE									
Reference	16100-29155	16100-29156	16100-29195							50 005 188 NEW
Prado 2.4 TD										149
04.1990→1993	2L-TE									
Reference	16100-59155	16100-59255	16100-59256	16100-59257						50 005 186 NEW

**TOYOTA**

11.1984→03.1990 Reference	2L-T 16100-59135 16100-59139	16100-59136	16100-59137	16100-59138			50 005 192 NEW
Prado 2.4 D							150
11.1984→03.1990 Reference	2L 16100-59155 16100-59139	16100-59255	16100-59256	16100-59257			50 005 186 NEW
Prado 2.8 D							151
04.1990→09.2002 Reference	3L 16100-59155 16100-59139	16100-59255	16100-59256	16100-59257			50 005 186 NEW
Premio 1.5i 16V							152
12.2001→ Reference	1NZ-FE 16100-29155 16100-29139	16100-29156	16100-29195				50 005 188 NEW
Premio 1.8i 16V							153
12.2001→ Reference	1ZZ-FE 16100-09080 16100-29139	16100-29095	16100-29175	16100-29415			50 005 183 NEW
Premio 2.0i 16V							154
12.2001→ Reference	1AZ-FSE (114 kW) 16100-0H010 16100-28040						50 005 799
Previa 2.0 D-4D 16V							155
02.2001→2005 Reference	1CD-FTV (81 kW) 16100-29135						50 005 198 NEW
Previa 2.4i 16V							156
02.2000→ Reference	2AZ-FE (112 kW) 16100-0H010 16100-28040						50 005 799

T









Prius 1.5i 16V					157
12.1997→12.2008 Reference	1NZ-FXE 16100-29155	16100-29156	16100-29195		50 005 188 NEW
Probox 1.3i 16V					158
08.2002→ Reference	2NZ-FE 16100-29155	16100-29156	16100-29195		50 005 188 NEW
Probox 1.5i 16V					159
08.2002→ Reference	1NZ-FE 16100-29155	16100-29156	16100-29195		50 005 188 NEW
Publica 1000					160
04.1969→08.1988 Reference	2K 16100-19015	16100-19016	16100-19017		50 005 196 NEW
Publica 1200					161
07.1977→08.1981 Reference	3K-H 16100-19015	16100-19016	16100-19017		50 005 196 NEW
Ractis 1.5i 16V					162
10.2005→ Reference	1NZ-FE 16100-29155	16100-29156	16100-29195		50 005 188 NEW
Raum 1.5i 16V					163
05.2003→ Reference	1NZ-FE 16100-29155	16100-29156	16100-29195		50 005 188 NEW
05.1997→04.2003 Reference	5E-FE (67 kW) 16110-19055 16110-19106	16110-19065	16110-19095 16110-19105		50 005 194 NEW



TOYOTA



RAV4 1.8i 16V							164
02.2001→02.2006	1ZZ-FE						50 005 183
Reference	16100-09080	16100-29095	16100-29175	16100-29415			NEW
RAV4 2.0i 16V							165
04.1994→08.2000	3S-FE (89 kW)						50 005 187
Reference	16100-79075 16110-79026	16100-79185	16110-09010	16110-79025			NEW
2001 → 2008	1AZ-FSE (114 kW), 2AZ-FE (112 kW)						50 005 799
Reference	16100-0H010	16100-28040					
RAV4 2.0 D-4D 16V							166
05.2001→02.2006	1CD-FTV (81 kW)						50 005 198
Reference	16100-29135						NEW
Scion xD 1.5i 16V							167
10.2008→	1NZ-FE						50 005 188
Reference	16100-29155	16100-29156	16100-29195				NEW
Sienta 1.5i 16V							168
09.2003→	1NZ-FE						50 005 188
Reference	16100-29155	16100-29156	16100-29195				NEW
Spacio 1.5i 16V							169
10.2001→	1NZ-FE						50 005 188
Reference	16100-29155	16100-29156	16100-29195				NEW
Spacio 1.6i 16V							170
01.1997→2000	4A-FE (84 kW)						50 005 184
Reference	16100-19295 16110-19146	16100-19296 16110-19205	16110-19135 16110-19255	16110-19145			NEW
Spacio 1.8i 16V							171
01.2001→	1ZZ-FE						50 005 183
Reference	16100-09080	16100-29095	16100-29175	16100-29415			NEW

T

**Sprinter 1.2****172**

04.1973→05.1978	3K-H							
Reference	16100-19015	16100-19016	16100-19017					50 005 196 <small>NEW</small>

Sprinter 1.3 12V**173**

05.1987→	2E, 2E-E							
Reference	16110-19055 16110-19106	16110-19065	16110-19095	16110-19105				50 005 194 <small>NEW</small>

Sprinter 1.3 16V**174**

12.1989→09.1995	4E-FE (65 kW)							
Reference	16110-19055 16110-19106	16110-19065	16110-19095	16110-19105				50 005 194 <small>NEW</small>

Sprinter 1.6i 16V**175**

04.1991→1998	4A-FE (84 kW)							
Reference	16100-19295 16110-19146	16100-19296 16110-19205	16110-19135 16110-19255	16110-19145				50 005 184 <small>NEW</small>

Sprinter 1.8i 16V**176**

1995 → 05.1991	7A-FE							
Reference	16110-19175	16110-19176	16110-19185					50 005 197 <small>NEW</small>

Sprinter 1.8 D**177**

05.1983→	1C-L							
Reference	16100-69295	16100-69296	16100-69335	16100-69435				50 005 182 <small>NEW</small>

Sprinter 2.0 D**178**

08.1989→	2C							
Reference	16100-69295	16100-69296	16100-69335	16100-69435				50 005 182 <small>NEW</small>

Starlet 1.0**179**

04.1969→02.1984	2K							
Reference	16100-19015	16100-19016	16100-19017					50 005 196 <small>NEW</small>

**TOYOTA****Starlet 1.0 12V****180**

10.1984→11.1989 1E-L
Reference 16100-19015 16100-19016 16100-19017



50 005 196
NEW

Starlet 1.2**181**

07.1978→08.1982 3K-H
Reference 16100-19015 16100-19016 16100-19017



50 005 196
NEW

Starlet 1.3**182**

08.1981→02.1984 4K, 4K-C
Reference 16100-19015 16100-19016 16100-19017



50 005 196
NEW

10.1984→11.1989 2E-L, 2E-LC
Reference 16110-19055 16110-19065 16110-19095 16110-19105
16110-19106



50 005 194
NEW

Starlet 1.3 12V**183**

12.1989→07.1999 2E, 2E-E
Reference 16110-19055 16110-19065 16110-19095 16110-19105
16110-19106



50 005 194
NEW

Starlet 1.3i 16V**184**

12.1989→03.1999 4E-FE (55 kW), 4E-FE (65 kW)
Reference 16110-19055 16110-19065 16110-19095 16110-19105
16110-19106



50 005 194
NEW

Starlet 1.5 12V**185**

08.1986→1994 3E
Reference 16110-19055 16110-19065 16110-19095 16110-19105
16110-19106



50 005 194
NEW

Succeed 1.5i 16V**186**

08.2002→ 1NZ-FE
Reference 16100-29155 16100-29156 16100-29195



50 005 188
NEW

T

**Tarago 2.4i 16V****187**

06.2006→ Reference	2AZ-FE (112 kW) 16100-0H010 16100-28040			50 005 799
-----------------------	---	---	--	------------

Tercel 1.5 12V**188**

08.1986→ Reference	3E 16110-19055 16110-19065 16110-19095 16110-19105 16110-19106			50 005 194 NEW
-----------------------	---	---	--	--------------------------

Tercel 1.5i 16V**189**

09.1994→07.1999 Reference	5E-FE (67 kW) 16110-19055 16110-19065 16110-19095 16110-19105 16110-19106			50 005 194 NEW
------------------------------	--	---	--	--------------------------

ToyoAce 2.4 D**190**

08.1983→07.1985 Reference	2L 16100-59155 16100-59255 16100-59256 16100-59257			50 005 186 NEW
------------------------------	--	---	--	--------------------------

Urban Cruiser 1.5i 16V**191**

04.2009→ Reference	1NZ-FE 16100-29155 16100-29156 16100-29195			50 005 188 NEW
-----------------------	---	---	--	--------------------------

Vanguard 2.4i 16V**192**

08.2007→ Reference	2AZ-FE (112 kW) 16100-0H010 16100-28040			50 005 799
-----------------------	---	---	--	------------







Vios 1.3i 16V**193**

2003 → 03.2007 Reference	2NZ-FE 16100-29155 16100-29156 16100-29195			50 005 188 NEW
-----------------------------	---	---	--	--------------------------

Vios 1.5i 16V**194**

2000 → Reference	1NZ-FE 16100-29155 16100-29156 16100-29195			50 005 188 NEW
---------------------	---	---	--	--------------------------



Vista 1.8i 16V					195
08.1998→07.2003	1ZZ-FE				
Reference	16100-09080	16100-29095	16100-29175	16100-29415	50 005 183 NEW
Vista 2.0i 16V					196
08.1986→1998	3S-FE (89 kW), 3S-GE (121 kW)				
Reference	16100-79075 16110-79026	16100-79185	16110-09010	16110-79025	 50 005 187 NEW
Vista 2.2 TD					197
07.1994→07.2003	3C-TE				
Reference	16100-69295	16100-69296	16100-69335	16100-69435	 50 005 182 NEW
Vitz 1.0i 16V					198
10.1998→2005	1SZ-FE				
Reference	16100-29115	16100-29116	16100-29117		 50 005 189 NEW
Vitz 1.3i 16V					199
11.1999→	2NZ-FE				
Reference	16100-29155	16100-29156	16100-29195		 50 005 188 NEW
Vitz 1.4 D-4D					200
1999 → 2005	1ND-TV (53 kW)				
Reference	16100-29155	16100-29156	16100-29195		 50 005 188 NEW
Vitz 1.5i 16V					201
1999 →	1NZ-FE				
Reference	16100-29155	16100-29156	16100-29195		 50 005 188 NEW
Voxy 2.0i 16V					202
2006 →	1AZ-FSE (114 kW)				
Reference	16100-0H010	16100-28040			 50 005 799

**Will 1.3i 16V****203**

01.2000→ Reference	2NZ-FE 16100-29155	16100-29156	16100-29195			50 005 188 NEW
-----------------------	-----------------------	-------------	-------------	---	--	--------------------------

Will 1.5i 16V**204**

2003 → Reference	1NZ-FE 16100-29155	16100-29156	16100-29195			50 005 188 NEW
---------------------	-----------------------	-------------	-------------	---	--	--------------------------

Windom 2.0i 16V**205**

09.1991→ Reference	3S-FE (94 kW) 16100-79075 16110-79026	16100-79185	16110-09010	16110-79025		50 005 187 NEW
-----------------------	---	-------------	-------------	-------------	---	--------------------------

Wish 1.8i 16V**206**

01.2003→ Reference	1ZZ-FE 16100-09080	16100-29095	16100-29175	16100-29415		50 005 183 NEW
-----------------------	-----------------------	-------------	-------------	-------------	--	--------------------------

Wish 2.0i 16V**207**

04.2003→ Reference	1AZ-FSE (114 kW) 16100-0H010	16100-28040				50 005 799
-----------------------	---------------------------------	-------------	--	--	---	-------------------

Yaris I 1.0i 16V**208**

01.1999→2005 Reference	1SZ-FE 16100-29115	16100-29116	16100-29117			50 005 189 NEW
---------------------------	-----------------------	-------------	-------------	---	--	--------------------------

Yaris I 1.3i 16V**209**





08.1999→ Reference	2NZ-FE 16100-29155	16100-29156	16100-29195			50 005 188 NEW
-----------------------	-----------------------	-------------	-------------	---	--	--------------------------

Yaris I 1.4 D-4D**210**

08.2001→09.2005 Reference	1ND-TV (53 kW) 16100-29155	16100-29156	16100-29195			50 005 188 NEW
------------------------------	-------------------------------	-------------	-------------	---	--	--------------------------

**TOYOTA****Yaris I 1.5i 16V****211**08.1999→
Reference1NZ-FE
16100-29155 16100-29156 16100-29195**50 005 188**
NEW**Yaris Verso 1.4 D-4D****212**08.2001→09.2005
Reference1ND-TV (53 kW)
16100-29155 16100-29156 16100-29195**50 005 188**
NEW**Yaris Verso 1.5i 16V****213**08.1999→09.2005
Reference1NZ-FE
16100-29155 16100-29156 16100-29195**50 005 188**
NEW**4-Runner 2.4 TD****214**01.1990→11.1995
Reference2L-TE
16100-59155 16100-59255 16100-59256 16100-59257**50 005 186**
NEW**4-Runner 2.8 D****215**1990 → 1995
Reference3L
16100-59155 16100-59255 16100-59256 16100-59257**50 005 186**
NEW**T**

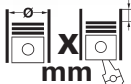

			Cyl	 mm	cm ³		Comp. Ratio ε	kW	PS	Pos
10 S	B		4	72 x 61	993	2	9,2:1	33-37	45-50	133
12 NC	B		4	79 x 61	1196	2	7,8:1	33	45	135
12 NV	B		4	77,8 x 62,9	1196	2	8/9,1:1	40	54	134
12 NZ	B		4	72 x 73,4	1195	2	9:1	33	45	91, 100
12 SC	B		4	79 x 61	1196	2	9:1	40	55	8, 49
12 ST	B		4	77,8 x 62,9	1196	2	9,2:1	37-43	50-58	134
13 N	B		4	75 x 73,4	1297	2	8,2:1	44	60	9, 72, 76, 90
13 NB	B		4	75 x 73,4	1297	2	8,2:1	44	60	9, 137
13 S	B		4	75 x 73,4	1297	2	9,2:1	50-55	68-75	4, 9, 50, 76, 90, 136
13 SB	B		4	75 x 73,4	1297	2	9,2:1	51	70	136
14 NV	B		4	77,6 x 73,4	1389	2	9,4:1	53-55	72-75	11, 20, 51, 83, 138
14 SE	B		4	77,6 x 73,4	1389	2	9,8:1	60	82	21
15 TD	D	(A)	4	76 x 82	1487	2	22,5:1	49-53	67-72	103
16 D	D	(AN)	4	80 x 79,5	1598	2	23:1	40	54	6, 14, 79
16 DA	D	(AN)	4	80 x 79,5	1598	2	23:1	40	54	14, 54, 79
16 LZ2	B		4	79 x 79,5	1598	2	9,6:1	55	75	23, 163
16 N	B		4	80 x 79,5	1598	2	8,2:1	50	68	73, 77
16 NZ2	B		4	80 x 79,5	1598	2	9,6:1	55	75	23
16 S	B		4	80 x 79,5	1598	2	9/9,5:1	55-60	75-82	5, 73, 77
16 SH	B		4	80 x 79,5	1598	2	9,2:1	66	90	5, 77
16 SV	B		4	79 x 81,5	1598	2	10:1	60	82	13, 53, 77
18 E	B		4	84,8 x 79,5	1796	2	9,5:1	85	115	7, 17, 81
18 NV	B		4	84,8 x 79,5	1796	2	9,2:1	60	82	63
18 S	B		4	84,8 x 79,5	1796	2	9,2:1	66	90	60, 121
18 SE	B		4	84,8 x 79,5	1796	2	10:1	82-85	112-116	17, 26, 55, 81
18 SEH	B		4	84,8 x 79,5	1796	2	10:1	85	116	64
18 SV	B		4	84,8 x 79,5	1796	2	10:1	66	90	63, 85
19 S	B		4	92 x 71,4	1897	2	8,8:1	65-77	88-105	74
20 E	B		4	95 x 69,8	1979	2	9,4:1	81	110	61
20 NE	B		4	86 x 86	1998	2	9,2:1	85	116	18, 82, 87
20 NEJ	B		4	86 x 86	1998	2	9,2:1	82	111	166
20 S	B		4	95 x 69,8	1979	2	9:1	74	101	75
20 SE	B		4	86 x 86	1998	2	10:1	85	116	65, 141
20 SEH	B		4	86 x 86	1998	2	10:1	95	129	18, 82, 87
20 SER	B		4	86 x 86	1998	2	10:1	91	124	18
20 XE	B		4	86 x 86	1998	4	10,5:1	110-115	150-156	56, 88
23 D	D	(AN)	4	92 x 85	2260	2	22:1	46-52	63-71	62
23 DTR	D	(LA)	4	92 x 85	2260	2	23:1	74	100	67
23 YD	D	(AN)	4	92 x 85	2260	2	22:1	54	73	66
23 YDT	D	(A)	4	92 x 85	2260	2	23:1	66	90	67
25 NE	B		6	87 x 69,8	2490	2	9,2:1	103	140	149
30 NE	B		6	95 x 69,8	2969	2	9,4:1	130-135	177-184	70, 151
C 12 NZ	B		4	72 x 73,4	1196	2	9,1:1	33	45	91, 100, 135
C 13 N	B		4	75 x 73,4	1297	2	9:1	44	60	10, 137
C 14 NZ	B		4	77,6 x 73,4	1389	2	9,4:1	40-44	54-60	12, 21, 52, 101, 139
C 14 SE	B		4	77,6 x 73,4	1389	2	9,8:1	60	82	21, 93, 101, 139
C 14 SEL	B		4	77,6 x 73,4	1389	4	9,8:1	60-66	82-90	102, 158
C 16 LZ	B		4	79 x 81,5	1598	2	9,2:1	55	75	15, 78
C 16 LZ2	B		4	79 x 81,5	1598	2	9,2:1	55	75	84
C 16 NZ	B		4	79 x 81,5	1598	2	9,2:1	55	75	15, 78, 140
C 16 NZ2	B		4	79 x 81,5	1598	2	9,2:1	55	75	84
C 16 SE	B		4	79 x 81,5	1598	2	10:1	74	100	23, 140
C 16 SEL	B		4	79 x 81,5	1598	4	9,8:1	74	100	32, 104, 159
C 16 XE	B		4	79 x 81,5	1598	4	10,5:1	80	109	104
C 18 NE	B		4	84,8 x 79,5	1796	2	8,9:1	74	101	17, 81
C 18 NT	B		4	84,8 x 79,5	1796	2	9,2:1	66	90	16
C 18 NZ	B		4	84,8 x 79,5	1796	2	9,2:1	66	90	17, 26, 86
C 18 SEL	B		4	84,8 x 79,5	1796	4	10,8:1	85	116	27
C 18 XE	B		4	81,6 x 86	1796	4	10,8:1	92	125	27
C 18 XEL	B		4	81,6 x 86	1796	4	10,8:1	85	116	27
C 20 NE	B		4	86 x 86	1998	2	9,2:1	85	116	18, 28, 57, 65, 82, 87, 116
C 20 SEL	B		4	86 x 86	1998	4	9,6:1	100	136	167
C 20 XE	B		4	86 x 86	1998	4	10,5:1	110	150	19, 29, 56, 58, 88
C 22 SEL	B		4	86 x 94,6	2198	4	10:1	106	144	170
C 24 NE	B		4	95 x 85	2410	2	9,2:1	92	125	68, 119
C 25 XE	B		6	81,6 x 79,6	2498	4	10,8:1	125	170	59, 89
C 26 NE	B		6	88,8 x 69,8	2594	4	9,2:1	110	150	69, 150
C 30 LE	B		6	95 x 69,8	2969	2	8,6:1	115	156	70, 148, 151
C 30 NE	B		6	95 x 69,8	2969	2	9,2:1	130	177	70, 148, 151



			Cyl		mm	cm ³	Comp. Ratio	ε	kW	PS	Pos
C 30 SE	B		6	95 x 69,8	2969	4	10:1	150	204	71, 152	
E 12 GV	B		4	79 x 61	1196	2	8:1	33	45	135	
E 16 NZ	B		4	79 x 81,5	1598	2	9,2:1	55-60	75-82	15, 78	
E 16 SE	B		4	79 x 81,5	1598	2	10:1	74	100	140	
E 18 NV	B		4	84,8 x 79,5	1796	2	9,2:1	62	84	16, 80	
E 18 NVR	B		4	84,8 x 79,5	1796	2	8,8:1	65	88	63, 85	
F4R 720	B		4	82,7 x 93	1998	4	9,8:1	88	120	178	
F9Q 760	D	(A)	4	80 x 93	1870	2	19:1	74	101	177	
F9Q 762	D	(A)	4	80 x 93	1870	2	19:1	60	82	177	
F9Q 770	D	(A)	4	80 x 93	1870	2	18,3:1	58	79	130	
F9Q 772	D	(A)	4	80 x 93	1870	2	18,3:1	60	82	130	
F9Q 774	D	(A)	4	80 x 93	1870	2	18,3:1	58-60	79-82	130	
G9T 722	D	(A)	4	87 x 92	2188	4	18:1	66	90	131	
G9U 630	D	(LA)	4	87 x 92	2464	4	18,1:1	107	145	179	
G9U 720	D	(LA)	4	89 x 99	2463	4	21,25:1	73-84	99-115	132	
G9U 730	D	(LA)	4	89 x 99	2463	4	18:1	99	135	179	
S 18 NV	B		4	84,8 x 79,5	1796	2	9,2:1	60-62	82-84	16, 63, 80	
X 12 SZ	B		4	72 x 73,4	1195	2	10:1	33	45	91, 100	
X 14 NZ	B		4	77,6 x 73,4	1389	2	9,6:1	44	60	21	
X 14 SZ	B		4	77,6 x 73,4	1389	2	9,6:1	44	60	101	
X 14 XE	B		4	77,6 x 73,4	1389	4	10,5:1	66	90	22, 30, 102, 158	
X 16 SZ	B		4	79 x 81,5	1598	2	10:1	52	71	23, 84	
X 16 SZR	B		4	79 x 81,5	1598	2	9,6:1	55	75	23, 31, 163	
X 16 XE	B		4	79 x 81,5	1598	4	10,5:1	78	106	104, 159	
X 16 XEL	B		4	79 x 81,5	1598	4	10,5:1	74	100	24, 32, 164, 182	
X 17 D	D	(AN)	4	79 x 86	1686	2	22:1	44	60	96, 105	
X 17 DTL	D	(LA)	4	82,5 x 79,5	1699	2	22:1	50	68	25, 34	
X 18 XE	B		4	81,6 x 86	1796	4	10,8:1	85	116	27, 165	
X 18 XE1	B		4	80,5 x 88,2	1796	4	10,5:1	85	116	36, 165, 184	
X 20 DTH	D	(LA)	4	84 x 90	1995	4	18,5:1	74	101	143, 169	
X 20 DTL	D	(A)	4	84 x 90	1995	4	18,5:1	60	82	39, 168, 186	
X 20 SE	B		4	86 x 86	1998	4	10:1	85	116	117, 142	
X 20 XER	B		4	86 x 86	1998	4	10,8:1	118	160	37, 185	
X 20 XEV	B		4	86 x 86	1998	4	10,8:1	100	136	29, 37, 58, 88, 142, 167, 185	
X 22 DTH	D	(LA)	4	84 x 98	2172	4	18,5:1	85-92	116-125	120, 157	
X 22 XE	B		4	86 x 94,6	2198	4	10,5:1	104	141	118, 156	
X 25 TD	D	(LA)	6	80 x 82,8	2498	2	22:1	96	131	147	
X 25 XE	B		6	81,6 x 79,6	2498	4	10,8:1	125	170	59, 146, 171	
Y 16 XE	B		4	79 x 81,5	1598	4	10,5:1	74	101	164	
Y 16 YNG	G		4	79 x 81,5	1598	4	12,5:1	71	97	111	
Y 17 DT	D	(LA)	4	79 x 86	1686	4	18,4:1	55	75	35, 98, 113, 126	
Y 17 DTL	D	(LA)	4	79 x 86	1686	4	18,4:1	48	65	97, 112, 128	
Y 20 DTH	D	(LA)	4	84 x 90	1995	4	18,5:1	74	100	40, 155, 169, 175, 187	
Y 22 DTH	D	(LA)	4	84 x 98	2172	4	18,5:1	85	116	120, 145	
Y 22 XE	B		4	86 x 94,6	2198	4	10,5:1	106	144	144	
Z 10 XEP	B		3	73,4 x 78,6	998	4	10,5:1	44	60	1, 106	
Z 12 XEP	B		4	73,4 x 72,6	1229	4	10,5:1	59	80	2, 42, 107	
Z 13 DT	D	(LA)	4	69,6 x 82	1248	4	18:1	51	69	3, 92, 108, 122, 160	
Z 14 XE	B		4	77,6 x 73,4	1389	4	10,5:1	66	90	30, 109	
Z 14 XEP	B		4	73,4 x 80,6	1364	4	10,5:1	66	90	43, 94, 109, 123, 161	
Z 16 SE	B		4	79 x 81,5	1598	2	9,6:1	62	84	31, 95, 110, 124	
Z 16 XE	B		4	79 x 81,5	1598	4	10,5:1	74	100	32, 125, 164, 172, 182	
Z 16 XEP	B		4	79 x 81,5	1598	4	10,5:1	76	104	32, 44, 125, 172, 189	
Z 16 YNG	G		4	79 x 81,5	1598	4	12,5:1	71	97	33, 111, 183	
Z 17 DTH	D	(LA)	4	79 x 86	1686	4	18,4:1	74	100	45, 99, 114, 127	
Z 18 XE	B		4	80,5 x 88,2	1796	4	10,5:1	90-92	122-125	36, 46, 115, 129, 153, 162, 165, 173, 184	
Z 18 XER	B		4	80,5 x 88,2	1796	4	10,5:1	103	140	46, 153, 173, 190	
Z 19 DTH	D	(LA)	4	82 x 90,4	1910	4	17,5:1	110	150	47, 154, 174, 191	
Z 19 DTJ	D	(LA)	4	82 x 90,4	1910	4	17,5:1	88	120	47	
Z 20 LEL	B	(LA)	4	86 x 86	1998	4	8,8:1	125	170	48, 192	
Z 20 LER	B	(LA)	4	86 x 86	1988	4	8,8:1	147	200	48, 192	
Z 20 LET	B	(LA)	4	86 x 86	1998	4	8,8:1	141	192	38, 180, 193	
Z 22 SE	B		4	86 x 94,6	2198	4	10:1	108	147	41, 170, 176, 181, 188	

V



Agila 1.0i 12V

1

09.2003→ Reference	Z 10 XEP 13 34 145 24469102			50 005 003 <small>NEW</small>
-----------------------	-------------------------------------	---	--	---

Agila 1.2i 16V

2

07.2004→ Reference	Z 12 XEP 13 34 145 24469102			50 005 003 <small>NEW</small>
-----------------------	-------------------------------------	---	--	---

Agila 1.3 CDTI 16V

3

09.2003→ Reference	Z 13 DT 63 34 001 93177340			50 005 760
-----------------------	------------------------------------	---	--	-------------------

Astra D 1.3

4

09.1979→08.1984 Reference	13 S 13 34 004 13 34 023 13 34 070 90076952 90183273 90349241			50 005 052
------------------------------	---	---	--	-------------------

Astra D 1.6

5

02.1982→08.1984 Reference	16 SH 13 34 008 90220568 90272361 14391115→			50 005 735
------------------------------	---	---	--	-------------------

08.1975→08.1981 Reference	16 S 13 34 032 13 34 035 28 98 355 Lager/bearing/coussinet/cojinete/подшипник: 30 mm			50 005 043
------------------------------	--	---	--	-------------------

08.1975→08.1981 Reference	16 S 6 46 027 6 46 027 6 46 030 6 46 030 90233175 90233175 90271451 90271451 90295214 90295214 16 S: →14387790 16 S: →14391115		50 005 823	
------------------------------	--	---	-------------------	--

02.1982→08.1984 Reference	16 SH 13 34 013 13 34 084 90106656 90273924 90284802 →14391114			50 005 049
------------------------------	--	---	--	-------------------

Astra D 1.6 D

6

03.1982→08.1984 Reference	16 D 13 34 014 90284913 90295078 14478631→			50 005 736
------------------------------	--	---	--	-------------------

V

**VAUXHALL**

03.1982→08.1984	16 D						
Reference	13 34 012 90285418 →14478630	13 34 015 90295077	13 34 099	90106450			50 005 055
Astra D 1.8i							7
05.1983→08.1984	18 E						
Reference	13 34 013 90284802	13 34 084	90106656	90273924			50 005 049
Astra E 1.2							8
09.1984→12.1988	12 SC						
Reference	13 34 027	13 34 071	90091035	90409912			50 005 051
Astra E 1.3							9
09.1984→08.1991	13 N, 13 NB, 13 S						
Reference	13 34 004 90183273	13 34 023 90349241	13 34 070	90076952			50 005 052
Astra E 1.3i							10
09.1985→08.1991	C 13 N						
Reference	13 34 004 90183273	13 34 023 90349241	13 34 070	90076952			50 005 052
Astra E 1.4							11
01.1990→08.1991	14 NV						
Reference	13 34 025 90325660 19307806→	13 34 065 90349239	13 34 098 9192793	90144227			50 005 059
01.1990→08.1991	14 NV						
Reference	6 46 029 90273981 14 NV : →02J22349 14 NV : →19307804	6 46 029 90273981	90231887	90231887		50 005 817	
01.1990→08.1991	14 NV						
Reference	13 34 011 90349240 →19307805	13 34 024	90234200	90325661			50 005 733
Astra E 1.4i							12
01.1990→08.1991	C 14 NZ						
Reference	6 46 029 90273981 C 14 NZ : →02J22349 C 14 NZ : →19311737	6 46 029 90273981	90231887	90231887		50 005 817	

V

**Astra E 1.6****13**

09.1984→12.1991

16 SV

Reference

6 46 029
90273981
→02J223496 46 029
90273981

90231887

90231887



50 005 817

**Astra E 1.6 D****14**

09.1984→12.1989

16 D, 16 DA

Reference

13 34 014
14478631→

90284913

90295078



50 005 736



09.1984→12.1989

16 D, 16 DA

Reference

13 34 012
90285418
→1447863013 34 015
90295077

13 34 099

90106450



50 005 055

**Astra E 1.6i****15**

09.1984→12.1991

C 16 LZ, C 16 NZ, E 16 NZ

Reference

6 46 029
90273981
→02J223496 46 029
90273981

90231887

90231887



50 005 817



09.1984→12.1991

C 16 LZ

Reference

13 34 011
90349240

13 34 024

90234200

90325661



50 005 733

Astra E 1.8**16**

09.1984→08.1991

C 18 NT, E 18 NV, S 18 NV

Reference

6 46 001
90442362
C 18 NT: 14254439→6 46 001
904423626 46 042
905415066 46 042
90541506

50 005 850



09.1984→08.1991

E 18 NV, S 18 NV

Reference

13 34 008

90220568

90272361



50 005 735

09.1984→08.1991

C 18 NT, E 18 NV, S 18 NV

Reference

6 46 027
90233175
90295214
C 18 NT: →142544386 46 027
90233175
902952146 46 030
902714516 46 030
90271451

50 005 823



09.1984→08.1991

C 18 NT

Reference

13 34 013
90284802

13 34 084

90106656

90273924



50 005 049

V

Astra E 1.8i**17**

10.1985→08.1991

C 18 NE, C 18 NZ

Reference

6 46 001
90442362
C 18 NZ: 14254439→6 46 001
904423626 46 042
905415066 46 042
90541506

50 005 850



**VAUXHALL**

09.1986→08.1991 Reference 	18 SE 13 34 008 14237770→	90220568	90272361			50 005 735
09.1984→08.1991 Reference 	18 E, 18 SE, C 18 NE, C 18 NZ 6 46 027 90233175 90295214 C 18 NE : 14056061→ 18 SE: 14056061→14270601 C 18 NE : 14237770→ 18 SE: 14237770→14270601 C 18 NZ: →14254438	6 46 027 90233175 90295214	6 46 030 90271451	6 46 030 90271451		50 005 823
09.1984→08.1991 Reference 	18 E, 18 SE, C 18 NE 13 34 013 90284802 18 SE: →14237769	13 34 084	90106656	90273924		50 005 049
Astra E 2.0i						18
09.1986→08.1991 Reference 	20 NE, 20 SEH, 20 SER, C 20 NE 6 46 001 90442362 20 NE, C 20 NE: 14608701→	6 46 001 90442362	6 46 042 90541506	6 46 042 90541506		50 005 850
09.1986→08.1991 Reference 	20 NE, 20 SEH, 20 SER, C 20 NE 6 46 027 90233175 90295214 →14608700	6 46 027 90233175 90295214	6 46 030 90271451	6 46 030 90271451		50 005 823
Astra E 2.0i 16V						19
05.1988→08.1991 Reference 	C 20 XE 13 34 041 90444311 14142840→	13 34 050	13 34 053	90443549		50 005 734
05.1988→08.1991 Reference 	C 20 XE 13 34 017 →14142839	13 34 038	90281612	90442207		50 005 737
Astra F 1.4						20
09.1991→09.1993 Reference 	14 NV 13 34 025 90325660 19307806→	13 34 065 90349239	13 34 098 9192793	90144227		50 005 059
09.1991→09.1993 Reference 	14 NV 6 46 009 6 46 132 90369451 90444316 14 NV : 02X38362→ 14 NV : 19994743→	6 46 009 6 46 132 90369451 90444316	6 46 041 6 46 133 90442241 90541505	6 46 041 6 46 133 90442241 90541505		50 005 818

V



09.1991→09.1993 Reference 	14 NV 13 34 011 90349240 →19307805	13 34 024	90234200	90325661			50 005 733
Astra F 1.4i							21
03.1992→02.1998 Reference	C 14 SE 13 34 025 90325660	13 34 065 90349239	13 34 098 9192793	90144227			50 005 059
09.1991→02.1998 Reference 	14 SE, C 14 NZ, C 14 SE, X 14 NZ 6 46 009 6 46 132 90369451 90444316 14 SE, C 14 NZ, C 14 SE, X 14 NZ: 02X38362→ 14 SE, C 14 NZ, C 14 SE, X 14 NZ: 19994743→	6 46 009 6 46 132 90369451 90444316	6 46 041 6 46 133 90442241 90541505	6 46 041 6 46 133 90442241 90541505		50 005 818	
Astra F 1.4i 16V							22
04.1996→02.1998 Reference	X 14 XE 13 34 046	13 34 066	90444079	9192797			50 005 738
04.1996→02.1998 Reference	X 14 XE 6 46 009 6 46 132 90369451 90444316	6 46 009 6 46 132 90369451 90444316	6 46 041 6 46 133 90442241 90541505	6 46 041 6 46 133 90442241 90541505		50 005 818	
Astra F 1.6i							23
09.1991→02.1998 Reference	16 LZ2, 16 NZ2 6 46 001 90442362	6 46 001 90442362	6 46 042 90541506	6 46 042 90541506		50 005 850	
03.1992→09.1998 Reference	C 16 SE, X 16 SZ, X 16 SZR 13 34 025 90325660	13 34 065 90349239	13 34 098 9192793	90144227			50 005 059
Astra F 1.6i 16V							24
09.1994→02.1998 Reference	X 16 XEL 13 34 046	13 34 066	90444079	9192797			50 005 738
09.1994→02.1998 Reference	X 16 XEL 6 46 009 6 46 132 90369451 90444316	6 46 009 6 46 132 90369451 90444316	6 46 041 6 46 133 90442241 90541505	6 46 041 6 46 133 90442241 90541505		50 005 818	
Astra F 1.7 TD							25
07.1995→02.1998 Reference	X 17 DTL 13 34 041 90444311	13 34 050	13 34 053	90443549			50 005 734

V

**Astra F 1.8i****26**

09.1991→02.1998	C 18 NZ						50 005 850	
Reference	6 46 001 90442362 14254439→	6 46 001 90442362	6 46 042 90541506	6 46 042 90541506				
09.1994→02.1998	18 SE						50 005 735	
Reference	13 34 008 14237770→	90220568	90272361					
09.1991→02.1998	C 18 NZ						50 005 823	
Reference	6 46 027 90233175 90295214 →14254438	6 46 027 90233175 90295214	6 46 030 90271451	6 46 030 90271451				
09.1994→02.1998	18 SE						50 005 049	
Reference	13 34 013 90284802 →14237769	13 34 084	90106656	90273924				

Astra F 1.8i 16V**27**

09.1994→02.1998	C 18 XE, C 18 XEL, X 18 XE						50 005 850	
Reference	6 46 001 90442362 C 18 XE, X 18 XE: →14261174	6 46 001 90442362	6 46 042 90541506	6 46 042 90541506				
09.1994→02.1998	C 18 SEL, C 18 XE, C 18 XEL, X 18 XE						50 005 851	
Reference	6 46 036 90511958 C 18 XEL: 14056061→ C 18 XE, X 18 XE: 14056061→14261174	6 46 036 90511958	6 46 046 90541510	6 46 046 90541510				
09.1994→02.1998	C 18 XE, C 18 XEL, X 18 XE						50 005 734	
Reference	13 34 041 90444311	13 34 050	13 34 053	90443549				

Astra F 2.0i**28**

09.1991→02.1998	C 20 NE						50 005 850	
Reference	6 46 001 90442362 14608701→	6 46 001 90442362	6 46 042 90541506	6 46 042 90541506				
09.1991→02.1998	C 20 NE						50 005 823	
Reference	6 46 027 90233175 90295214 →14608700	6 46 027 90233175 90295214	6 46 030 90271451	6 46 030 90271451				

Astra F 2.0i 16V**29**

01.1995→02.1998	X 20 XEV						50 005 850	
Reference	6 46 001 90442362 →14003331	6 46 001 90442362	6 46 042 90541506	6 46 042 90541506				

V



01.1995→02.1998 Reference	X 20 XEV 6 46 036 6 46 036 6 46 046 6 46 046 90511958 90511958 90541510 90541510 14003332→14315275					50 005 851
09.1991→02.1998 Reference	C 20 XE, X 20 XEV 13 34 041 13 34 050 13 34 053 90443549 90444311 C 20 XE: 14142840→					50 005 734
01.1995→02.1998 Reference	X 20 XEV 24406585 24406585 6 46 052 6 46 052 6 46 056 6 46 056 6 46 067 6 46 067 90542273 90542273 9118202 9118202 14315276→					50 005 848
09.1991→02.1998 Reference	C 20 XE 13 34 017 13 34 038 90281612 90442207 →14142839					50 005 737
Astra G 1.4i 16V						30
09.1997→09.2000 Reference	X 14 XE 13 34 046 13 34 066 90444079 9192797					50 005 738
09.1997→ Reference	X 14 XE, Z 14 XE 6 46 009 6 46 009 6 46 041 6 46 041 6 46 132 6 46 132 6 46 133 6 46 133 90369451 90369451 90442241 90442241 90444316 90444316 90541505 90541505					50 005 818
Astra G 1.6i						31
09.1997→08.2000 Reference	X 16 SZR 13 34 025 13 34 065 13 34 098 90144227 90325660 90349239 9192793					50 005 059
09.1997→ Reference	X 16 SZR, Z 16 SE 6 46 009 6 46 009 6 46 041 6 46 041 6 46 132 6 46 132 6 46 133 6 46 133 90369451 90369451 90442241 90442241 90444316 90444316 90541505 90541505					50 005 818
09.2000→ Reference	Z 16 SE 13 34 078 63 34 039 9199595 93182042					50 005 900
Astra G 1.6i 16V						32
09.1997→08.2000 Reference	X 16 XEL 13 34 046 13 34 066 90444079 9192797					50 005 738



09.2002→ Reference	Z 16 XEP 13 34 142	24405895				50 005 006 <small>NEW</small>
09.1997→ Reference	C 16 SEL, X 16 XEL, Z 16 XE, Z 16 XEP 6 46 009 6 46 009 6 46 041 6 46 041 6 46 132 6 46 132 6 46 133 6 46 133 90369451 90369451 90442241 90442241 90444316 90444316 90541505 90541505					50 005 818
09.1997→ Reference 	X 16 XEL, Z 16 XE 13 34 077 63 34 035 9199592 93182038 X 16 XEL: 02MV7225/20U75999→					50 005 793
Astra G 1.6i 16V (Gas)						33
09.2002→ Reference	Z 16 YNG 6 46 009 6 46 009 6 46 041 6 46 041 6 46 132 6 46 132 6 46 133 6 46 133 90369451 90369451 90442241 90442241 90444316 90444316 90541505 90541505					50 005 818
Astra G 1.7 TD						34
03.1998→08.2000 Reference	X 17 DTL 13 34 041 13 34 050 13 34 053 90443549 90444311					50 005 734
Astra G 1.7 DTI 16V						35
09.2000→ Reference	Y 17 DT 13 34 073 13 34 143 63 34 024 93182028 97251178 97287175					50 005 755
Astra G 1.8i 16V						36
09.1997→ Reference	X 18 XE1, Z 18 XE 13 34 135 90543935					50 005 747
Astra G 2.0i 16V						37
09.1997→ Reference	X 20 XEV 13 34 041 13 34 050 13 34 053 90443549 90444311					50 005 734
09.1997→ Reference	X 20 XER, X 20 XEV 24406585 24406585 6 46 052 6 46 052 6 46 056 6 46 056 6 46 067 6 46 067 90542273 90542273 9118202 9118202					50 005 848

V



Astra G 2.0i Turbo 16V

38

09.2000→
Reference

Z 20 LET
13 34 041
90444311

13 34 050

13 34 053

90443549

**50 005 734**

Astra G 2.0 DI 16V

39

03.1998→08.2000
Reference

X 20 DTL
13 34 117

90540478

**50 005 748**

Astra G 2.0 DTI 16V

40

08.2000→
Reference

Y 20 DTH
13 34 117

90540478

**50 005 748**

Astra G 2.2i 16V

41

09.2000→
Reference

Z 22 SE
13 34 067
93178602

13 34 083

63 34 002

91 94 747

**50 005 792**

Astra H 1.2i 16V

42

04.2005→
Reference

Z 12 XEP
13 34 145

24469102

**50 005 003**
NEW

Astra H 1.4i 16V

43

03.2004→
Reference

Z 14 XEP
13 34 145

24469102

**50 005 003**
NEW

Astra H 1.6i 16V

44

03.2004→
Reference

Z 16 XEP
13 34 142

24405895

**50 005 006**
NEW

Astra H 1.7 CDTI 16V

45

03.2004→
Reference

Z 17 DTH
13 34 073
97251178

13 34 143
97287175

63 34 024

93182028

**50 005 755****V**

**Astra H 1.8i 16V****46**

09.2005→ Reference	Z 18 XER 13 34 142	24405895			50 005 006 <small>NEW</small>
03.2004→ Reference	Z 18 XE 13 34 135	90543935			50 005 747

Astra H 1.9 CDTI 16V**47**

09.2004→ Reference	Z 19 DTH, Z 19 DTJ 13 34 147				50 005 056 <small>NEW</small>
-----------------------	---------------------------------	--	--	---	---

Astra H 2.0i Turbo 16V**48**

03.2004→ Reference	Z 20 LEL, Z 20 LER 13 34 139				50 005 074 <small>NEW</small>
-----------------------	---------------------------------	--	--	---	---



Belmont 1.2**49**

1982 → Reference	12 SC 13 34 027	13 34 071	90091035	90409912		50 005 051
---------------------	--------------------	-----------	----------	----------	---	-------------------

Belmont 1.3**50**

09.1985→09.1993 Reference	13 S 13 34 004 90183273	13 34 023 90349241	13 34 070	90076952		50 005 052
------------------------------	-------------------------------	-----------------------	-----------	----------	---	-------------------

Belmont 1.4**51**

1990 → 1991 Reference	14 NV 13 34 025 90325660 19307806→	13 34 065 90349239	13 34 098 9192793	90144227		50 005 059
1990 → 1991 Reference	14 NV 6 46 009 6 46 132 90369451 90444316	6 46 009 6 46 132 90369451 90444316	6 46 041 6 46 133 90442241 90541505	6 46 041 6 46 133 90442241 90541505		50 005 818
1990 → 1991 Reference	14 NV 13 34 011 90349240 →19307805	13 34 024	90234200	90325661		50 005 733

V

**Belmont 1.4i****52**

09.1990→12.1991

C 14 NZ

Reference

6 46 009	6 46 009	6 46 041	6 46 041
6 46 132	6 46 132	6 46 133	6 46 133
90369451	90369451	90442241	90442241
90444316	90444316	90541505	90541505



50 005 818

Belmont 1.6**53**

09.1985→09.1993

16 SV

Reference

6 46 009	6 46 009	6 46 041	6 46 041
6 46 132	6 46 132	6 46 133	6 46 133
90369451	90369451	90442241	90442241
90444316	90444316	90541505	90541505



50 005 818

Belmont 1.6 D**54**

09.1985→09.1993

16 DA

Reference

13 34 014	90284913	90295078	
-----------	----------	----------	--



14478631→



50 005 736

09.1985→09.1993

16 DA

Reference

13 34 012	13 34 015	13 34 099	90106450
90285418	90295077		



→14478630



50 005 055

Belmont 1.8i**55**

09.1985→03.1993

18 SE

Reference

13 34 008	90220568	90272361	
-----------	----------	----------	--



14237770→



50 005 735

09.1985→03.1993

18 SE

Reference

13 34 013	13 34 084	90106656	90273924
90284802			



→14237769



50 005 049

Belmont 2.0i 16V**56**

1988 →

20 XE, C 20 XE

Reference

13 34 041	13 34 050	13 34 053	90443549
90444311			

20 XE: 14142839→
C 20 XE: 14142840→

50 005 734

1988 →

20 XE, C 20 XE

Reference

13 34 017	13 34 038	90281612	90442207
-----------	-----------	----------	----------

20 XE: →14142838
C 20 XE: →14142839

50 005 737

Calibra 2.0i**57**

03.1990→03.1997

C 20 NE

Reference

6 46 001	6 46 001	6 46 042	6 46 042
90442362	90442362	90541506	90541506





50 005 850

V





03.1990→03.1997 Reference	C 20 NE 6 46 027 90233175 90295214 N1299999→N9299999	6 46 027 90233175 90295214	6 46 030 90271451	6 46 030 90271451		50 005 823	
Calibra 2.0i 16V 58							
09.1993→08.1996 Reference	X 20 XEV 6 46 001 90442362 →14003331	6 46 001 90442362	6 46 042 90541506	6 46 042 90541506		50 005 850	
09.1993→08.1996 Reference	X 20 XEV 6 46 036 90511958 14003332→14315275	6 46 036 90511958	6 46 046 90541510	6 46 046 90541510		50 005 851	
03.1990→03.1997 Reference	C 20 XE, X 20 XEV 13 34 041 90444311 C 20 XE: 14142840→	13 34 050	13 34 053	90443549		50 005 734	
09.1993→08.1996 Reference	X 20 XEV 24406585 6 46 056 90542273 14315276→	24406585 6 46 056 90542273	6 46 052 6 46 067 9118202	6 46 052 6 46 067 9118202		50 005 848	
03.1990→03.1997 Reference	C 20 XE 13 34 017 →14142839	13 34 038	90281612	90442207		50 005 737	
Calibra 2.5i 24V 59							
04.1993→03.1997 Reference	C 25 XE, X 25 XE 13 34 059	13 34 131	90444649	90543277		50 005 224	
Carlton II 1.8 60							
12.1982→08.1986 Reference	18 S 13 34 013 90284802	13 34 084	90106656	90273924		50 005 049	
Carlton II 2.0i 61							
10.1978→11.1986 Reference	20 E 13 34 032 Lager/bearing/coussinet/cojinetete/подшипник: 30 mm	13 34 035	28 98 355			50 005 043	
Carlton II 2.3 D 62							
05.1983→08.1986 Reference	23 D 13 34 045 90096415 →55082	13 34 074 90136382	13 34 087	34 69 874		50 005 053	

**Carlton III 1.8****63**

09.1986→10.1994	18 NV, 18 SV, E 18 NVR, S 18 NV						50 005 850	
Reference	6 46 001 90442362 14270601→	6 46 001 90442362	6 46 042 90541506	6 46 042 90541506				
09.1986→10.1994	18 NV, 18 SV, S 18 NV							50 005 735
Reference	13 34 008	90220568	90272361					
09.1986→10.1994	18 NV, 18 SV, E 18 NVR, S 18 NV						50 005 823	
Reference	6 46 027 90233175 90295214 →14270600	6 46 027 90233175 90295214	6 46 030 90271451	6 46 030 90271451				

Carlton III 1.8i**64**

09.1986→10.1994	18 SEH						50 005 850	
Reference	6 46 001 90442362 14270601→	6 46 001 90442362	6 46 042 90541506	6 46 042 90541506				
09.1986→10.1994	18 SEH							50 005 735
Reference	13 34 008	90220568	90272361					
09.1986→10.1994	18 SEH						50 005 823	
Reference	6 46 027 90233175 90295214 →14270600	6 46 027 90233175 90295214	6 46 030 90271451	6 46 030 90271451				

Carlton III 2.0i**65**

09.1986→10.1994	20 SE, C 20 NE						50 005 850	
Reference	6 46 001 90442362 14608701→	6 46 001 90442362	6 46 042 90541506	6 46 042 90541506				
09.1986→10.1994	20 SE							50 005 735
Reference	13 34 008 →14608700	90220568	90272361					
09.1986→10.1994	20 SE							50 005 732
Reference	13 34 054 14608701→	90444123						
09.1986→10.1994	20 SE						50 005 823	
Reference	6 46 027 90233175 90295214 →14608700	6 46 027 90233175 90295214	6 46 030 90271451	6 46 030 90271451				

V

**VAUXHALL****Carlton III 2.3 D****66**

09.1986→10.1994

23 YD

Reference

13 34 009

13 34 021

90271492

90348231



50 005 740

Carlton III 2.3 TD**67**

10.1986→10.1994

23 DTR , 23 YDT

Reference

13 34 009

13 34 021

90271492

90348231



50 005 740

Carlton III 2.4i**68**

09.1986→10.1994

C 24 NE

Reference

13 34 009

13 34 021

90271492

90348231



50 005 740

Carlton III 2.6i**69**

09.1990→10.1994

C 26 NE

Reference

13 34 009

13 34 021

90271492

90348231



50 005 740

Carlton III 3.0i**70**

09.1985→10.1994

30 NE, C 30 LE, C 30 NE

Reference

13 34 009

13 34 021

90271492

90348231



50 005 740

Carlton III 3.0i 24V**71**

01.1989→10.1994

C 30 SE

Reference

13 34 009

13 34 021

90271492

90348231



50 005 740

Cavalier I 1.3**72**

08.1977→08.1981

13 N

Reference

13 34 004
9018327313 34 023
90349241

13 34 070

90076952



50 005 052

V**Cavalier I 1.6****73**

08.1975→08.1991

16 N, 16 S

Reference

13 34 032

13 34 035

28 98 355



Lager/bearing/coussinet/cojinete/подшипник: 30 mm



50 005 043

Cavalier I 1.9**74**

10.1975→03.1978

19 S

Reference

13 34 032

13 34 035

28 98 355



Lager/bearing/coussinet/cojinete/подшипник: 30 mm



50 005 043

**Cavalier I 2.0****75**

03.1978→08.1981	20 S						
Reference	13 34 032	13 34 035	28 98 355				50 005 043
	Lager/bearing/coussinete/cojinete/подшипник: 30 mm						

Cavalier II 1.3**76**

09.1981→08.1988	13 N, 13 S						
Reference	13 34 004 90183273	13 34 023 90349241	13 34 070	90076952			50 005 052

Cavalier II 1.6**77**

09.1981→08.1988	16 SH						
Reference	13 34 008 14391115→	90220568	90272361				50 005 735
09.1981→08.1988	16 N, 16 S						
Reference	13 34 032	13 34 035	28 98 355				50 005 043
	Lager/bearing/coussinete/cojinete/подшипник: 30 mm						
09.1988→11.1995	16 SV						
Reference	6 46 029 90273981	6 46 029 90273981	90231887	90231887			50 005 817
	16 SV : →02J22349 16 SV : →19307806						
09.1988→11.1995	16 SV						
Reference	6 46 009 6 46 132 90369451 90444316 →02X38361	6 46 009 6 46 132 90369451 90444316	6 46 041 6 46 133 90442241 90541505	6 46 041 6 46 133 90442241 90541505			50 005 818
09.1981→08.1988	16 N, 16 S, 16 SH						
Reference	6 46 027 90233175 90295214 16 N: 14054371→ 16 SH: 14387790→ 16 SH: 14391115→	6 46 027 90233175 90295214	6 46 030 90271451	6 46 030 90271451			50 005 823
09.1981→08.1988	16 SH						
Reference	13 34 013 90284802 →14391114	13 34 084	90106656	90273924			50 005 049

Cavalier II 1.6i**78**

08.1986→08.1988	C 16 LZ, C 16 NZ, E 16 NZ						
Reference	6 46 029 90273981	6 46 029 90273981	90231887	90231887			50 005 817
09.1986→08.1988	C 16 NZ, E 16 NZ						
Reference	6 46 009 6 46 132 90369451 90444316 →02X38361	6 46 009 6 46 132 90369451 90444316	6 46 041 6 46 133 90442241 90541505	6 46 041 6 46 133 90442241 90541505			50 005 818

V



08.1986→08.1988 Reference	C 16 LZ 13 34 011 90349240	13 34 024	90234200	90325661			50 005 733
Cavalier II 1.6 D							79
03.1982→08.1988 Reference 	16 D, 16 DA 13 34 014 14478631→	90284913	90295078				50 005 736
03.1982→08.1988 Reference 	16 D, 16 DA 13 34 012 90285418 →14478630	13 34 015 90295077	13 34 099	90106450			50 005 055
Cavalier II 1.8							80
08.1986→08.1988 Reference	E 18 NV, S 18 NV 13 34 008	90220568	90272361				50 005 735
08.1986→08.1988 Reference	E 18 NV, S 18 NV 6 46 027 90233175 90295214	6 46 027 90233175 90295214	6 46 030 90271451	6 46 030 90271451		50 005 823	
Cavalier II 1.8i							81
09.1986→08.1988 Reference 	18 SE 13 34 008 14237770→	90220568	90272361				50 005 735
09.1981→12.1990 Reference 	18 E, 18 SE, C 18 NE 6 46 027 90233175 90295214 18 SE, C 18 NE : 14056061→ 18 SE, C 18 NE : 14237770→	6 46 027 90233175 90295214	6 46 030 90271451	6 46 030 90271451		50 005 823	
09.1981→12.1990 Reference 	18 E, 18 SE, C 18 NE 13 34 013 90284802 18 SE: →14237769	13 34 084	90106656	90273924			50 005 049
Cavalier II 2.0i							82
09.1986→08.1988 Reference 	20 NE, 20 SEH, C 20 NE 6 46 027 90233175 90295214 C 20 NE: →14608700	6 46 027 90233175 90295214	6 46 030 90271451	6 46 030 90271451		50 005 823	

**Cavalier III 1.4****83**

09.1988→11.1995	14 NV							
Reference	13 34 025 90325660 19307806→	13 34 065 90349239	13 34 098 9192793	90144227				50 005 059
09.1988→11.1995	14 NV							
Reference	6 46 029 90273981 14 NV : →02J22349 14 NV : →19307806	6 46 029 90273981	90231887	90231887				50 005 817
09.1988→11.1995	14 NV							
Reference	6 46 009 6 46 132 90369451 90444316 →02X38361	6 46 009 6 46 132 90369451 90444316	6 46 041 6 46 133 90442241 90541505	6 46 041 6 46 133 90442241 90541505				50 005 818
09.1988→11.1995	14 NV							
Reference	13 34 011 90349240 →19307805	13 34 024	90234200	90325661				50 005 733

Cavalier III 1.6i**84**

09.1988→11.1995	C 16 LZ2, C 16 NZ2							
Reference	6 46 001 90442362	6 46 001 90442362	6 46 042 90541506	6 46 042 90541506				50 005 850
09.1994→11.1995	X 16 SZ							
Reference	13 34 025 90325660	13 34 065 90349239	13 34 098 9192793	90144227				50 005 059
09.1994→11.1995	X 16 SZ							
Reference	6 46 029 90273981 X 16 SZ: →02J22349 X 16 SZ: →19307806	6 46 029 90273981	90231887	90231887				50 005 817
09.1994→11.1995	X 16 SZ							
Reference	6 46 009 6 46 132 90369451 90444316 →02X38361	6 46 009 6 46 132 90369451 90444316	6 46 041 6 46 133 90442241 90541505	6 46 041 6 46 133 90442241 90541505				50 005 818

Cavalier III 1.8**85**

09.1988→11.1995	18 SV, E 18 NVR							
Reference	6 46 001 90442362 18 SV: 14254439→ E 18 NVR: 14270601→	6 46 001 90442362	6 46 042 90541506	6 46 042 90541506				50 005 850
09.1988→08.1995	18 SV							
Reference	13 34 008	90220568	90272361					50 005 735



09.1988→11.1995 Reference	18 SV, E 18 NVR 6 46 027 90233175 90295214 18 SV: →14254438 E 18 NVR: →14270600	6 46 027 90233175 90295214	6 46 030 90271451	6 46 030 90271451		50 005 823
Cavalier III 1.8i						86
09.1988→11.1995 Reference	C 18 NZ 6 46 001 90442362 14270601→	6 46 001 90442362	6 46 042 90541506	6 46 042 90541506		50 005 850
09.1988→11.1995 Reference	C 18 NZ 6 46 027 90233175 90295214 →14270600	6 46 027 90233175 90295214	6 46 030 90271451	6 46 030 90271451		50 005 823
Cavalier III 2.0i						87
09.1988→11.1995 Reference	20 NE, 20 SEH, C 20 NE 6 46 001 90442362 14608701→	6 46 001 90442362	6 46 042 90541506	6 46 042 90541506		50 005 850
09.1988→11.1995 Reference	20 NE, 20 SEH, C 20 NE 6 46 027 90233175 90295214 →14608700	6 46 027 90233175 90295214	6 46 030 90271451	6 46 030 90271451		50 005 823
Cavalier III 2.0i 16V						88
09.1993→11.1995 Reference	X 20 XEV 6 46 001 90442362	6 46 001 90442362	6 46 042 90541506	6 46 042 90541506		50 005 850
09.1988→11.1995 Reference	20 XE, C 20 XE, X 20 XEV 13 34 041 90444311 20 XE: 14142839→ C 20 XE: 14142840→	13 34 050 90444311	13 34 053	90443549		50 005 734
09.1988→11.1995 Reference	20 XE, C 20 XE 13 34 017 20 XE: →14142838 C 20 XE: →14142839	13 34 038 90444311	90281612	90442207		50 005 737
Cavalier III 2.5i 24V						89
02.1993→11.1995 Reference	C 25 XE 13 34 059 13 34 131	13 34 131	90444649	90543277		50 005 224
Chevette 1.3						90
03.1975→12.1985 Reference	13 N, 13 S 13 34 004 90183273	13 34 023 90349241	13 34 070	90076952		50 005 052

**Combo 1.2i****91**

09.1994→10.2001	12 NZ, C 12 NZ, X 12 SZ			
Reference	13 34 025 90325660	13 34 065 90349239	13 34 098 9192793	90144227

**50 005 059****Combo 1.3 CDTI 16V****92**

09.2004→	Z 13 DT	
Reference	63 34 001	93177340

**50 005 760****Combo 1.4i****93**

09.1994→10.2001	C 14 SE			
Reference	13 34 025 90325660	13 34 065 90349239	13 34 098 9192793	90144227

**50 005 059****Combo 1.4i 16V****94**

09.2004→	Z 14 XEP	
Reference	13 34 145	24469102

**50 005 003**
NEW**Combo 1.6i****95**

10.2001→08.2004	Z 16 SE			
Reference	13 34 078	63 34 039	9199595	93182042

**50 005 900****Combo 1.7 D****96**

07.1994→10.2001	X 17 D			
Reference	13 34 031 13 34 105 97101320 →00877697	13 34 034 94341998 97110387	13 34 052 94386207	13 34 102 97101319

**50 005 741**

07.1994→10.2001	X 17 D		
Reference	13 34 069 00877698→	13 34 115	97114682

**50 005 746****Combo 1.7 DI 16V****97**

11.2001→08.2004	Y 17 DTL			
Reference	13 34 073 97251178	13 34 143 97287175	63 34 024	93182028

**50 005 755****V**



Combo 1.7 DTI 16V 98						
10.2001→08.2004	Y 17 DT					
Reference	13 34 073 97251178	13 34 143 97287175	63 34 024	93182028		50 005 755
Combo 1.7 CDTI 16V 99						
06.2004→	Z 17 DTH					
Reference	13 34 073 97251178	13 34 143 97287175	63 34 024	93182028		50 005 755
Corsa B 1.2i 100						
09.1994→08.2000	12 NZ, C 12 NZ, X 12 SZ					
Reference	13 34 025 90325660	13 34 065 90349239	13 34 098 9192793	90144227		50 005 059
09.1994→08.2000	12 NZ, C 12 NZ, X 12 SZ					
Reference	6 46 009 6 46 132 90369451 90444316	6 46 009 6 46 132 90369451 90444316	6 46 041 6 46 133 90442241 90541505	6 46 041 6 46 133 90442241 90541505		50 005 818
Corsa B 1.4i 101						
09.1994→08.2000	C 14 SE, X 14 SZ					
Reference	13 34 025 90325660	13 34 065 90349239	13 34 098 9192793	90144227		50 005 059
09.1994→08.2000	C 14 NZ, C 14 SE, X 14 SZ					
Reference	6 46 009 6 46 132 90369451 90444316	6 46 009 6 46 132 90369451 90444316	6 46 041 6 46 133 90442241 90541505	6 46 041 6 46 133 90442241 90541505		50 005 818
Corsa B 1.4i 16V 102						
09.1994→08.1999	X 14 XE					
Reference	13 34 046	13 34 066	90444079	9192797		50 005 738
09.1994→08.2000	C 14 SEL, X 14 XE					
Reference	6 46 009 6 46 132 90369451 90444316	6 46 009 6 46 132 90369451 90444316	6 46 041 6 46 133 90442241 90541505	6 46 041 6 46 133 90442241 90541505		50 005 818
Corsa B 1.5 TD 103						
09.1994→08.2000	15 TD					
Reference	13 34 121 →76351	13 34 756	97113499	97135548		50 005 749

**Corsa B 1.6i 16V****104**

09.1994→08.2000	C 16 XE, X 16 XE					50 005 738
Reference	13 34 046	13 34 066	90444079	9192797		
09.1994→08.2000	C 16 SEL, C 16 XE, X 16 XE					50 005 818
Reference	6 46 009	6 46 009	6 46 041	6 46 041		
	6 46 132	6 46 132	6 46 133	6 46 133		
	90369451	90369451	90442241	90442241		
	90444316	90444316	90541505	90541505		

Corsa B 1.7 D**105**

09.1994→08.2000	X 17 D					50 005 741
Reference	13 34 031	13 34 034	13 34 052	13 34 102		
	13 34 105	94341998	94386207	97101319		
	97101320	97110387				
	→00877697					
09.1994→08.2000	X 17 D					50 005 746
Reference	13 34 069	13 34 115	97114682			
	00877698→					

Corsa C 1.0i 12V**106**

09.2003→	Z 10 XEP					50 005 003 <small>NEW</small>
Reference	13 34 145	24469102				

Corsa C 1.2i 16V**107**

09.2004→	Z 12 XEP					50 005 003 <small>NEW</small>
Reference	13 34 145	24469102				

Corsa C 1.3 CDTI 16V**108**

09.2003→	Z 13 DT					50 005 760
Reference	63 34 001	93177340				

Corsa C 1.4i 16V**109**

09.2000→08.2003	Z 14 XE					50 005 818
Reference	6 46 009	6 46 009	6 46 041	6 46 041		
	6 46 132	6 46 132	6 46 133	6 46 133		
	90369451	90369451	90442241	90442241		
	90444316	90444316	90541505	90541505		
09.2003→	Z 14 XEP					50 005 003 <small>NEW</small>
Reference	13 34 145	24469102				

V



Corsa C 1.6i 110				
09.2001→08.2003	Z 16 SE			
Reference	6 46 009 6 46 132 90369451 90444316	6 46 009 6 46 132 90369451 90444316	6 46 041 6 46 133 90442241 90541505	6 46 041 6 46 133 90442241 90541505
				50 005 818
09.2001→08.2003	Z 16 SE			
Reference	13 34 078	63 34 039	9199595	93182042
				50 005 900
Corsa C 1.6i 16V (Gas) 111				
01.2002→	Y 16 YNG, Z 16 YNG			
Reference	6 46 009 6 46 132 90369451 90444316	6 46 009 6 46 132 90369451 90444316	6 46 041 6 46 133 90442241 90541505	6 46 041 6 46 133 90442241 90541505
				50 005 818
Corsa C 1.7 DI 16V 112				
09.2000→09.2003	Y 17 DTL			
Reference	13 34 073 97251178	13 34 143 97287175	63 34 024	93182028
				50 005 755
Corsa C 1.7 DTI 16V 113				
09.2000→08.2003	Y 17 DT			
Reference	13 34 073 97251178	13 34 143 97287175	63 34 024	93182028
				50 005 755
Corsa C 1.7 CDTI 16V 114				
09.2003→	Z 17 DTH			
Reference	13 34 073 97251178	13 34 143 97287175	63 34 024	93182028
				50 005 755
Corsa C 1.8i 16V 115				
09.2001→	Z 18 XE			
Reference	13 34 135	90543935		
				50 005 747
Frontera A 2.0i 116				
01.1992→08.1995	C 20 NE			
Reference	6 46 001 90442362 14608701→	6 46 001 90442362	6 46 042 90541506	6 46 042 90541506
				50 005 850
01.1992→08.1995	C 20 NE			
Reference	6 46 027 90233175 90295214 →14608700	6 46 027 90233175 90295214	6 46 030 90271451	6 46 030 90271451
				50 005 823

**Frontera A 2.0i 16V****117**

02.1995→08.1998

X 20 SE

Reference

13 34 054

90444123



50 005 732

Frontera A 2.2i 16V**118**

02.1995→08.1998

X 22 XE

Reference

6 46 001

6 46 001

6 46 042

6 46 042

90442362

90442362

90541506

90541506

→TV899999



50 005 850

02.1995→08.1998

X 22 XE

Reference

13 34 041

13 34 050

13 34 053

90443549

90444311



50 005 734

Frontera A 2.4i**119**

01.1992→08.1995

C 24 NE

Reference

13 34 009

13 34 021

90271492

90348231



50 005 740

Frontera B 2.2 DTI 16V**120**

09.1998→

X 22 DTH, Y 22 DTH

Reference

13 34 117

90540478



50 005 748

Manta 1.8**121**

09.1982→08.1988

18 S

Reference

13 34 013

13 34 084

90106656

90273924

90284802



50 005 049

Meriva 1.3 CDTI 16V**122**

07.2005→01.2006

Z 13 DT

Reference

63 34 001

93177340



50 005 760

Meriva 1.4i 16V**123**

09.2004→

Z 14 XEP

Reference

13 34 145

24469102



50 005 003

NEW

Meriva 1.6i**124**

03.2003→

Z 16 SE

Reference

6 46 009

6 46 009

6 46 041

6 46 041

6 46 132

6 46 132

6 46 133

6 46 133

90369451

90369451

90442241

90442241

90444316

90444316

90541505

90541505















50 005 818

**VAUXHALL**

03.2003→ Reference	Z 16 SE 13 34 078	63 34 039	9199595	93182042			50 005 900
Meriva 1.6i 16V							125
02.2006→ Reference	Z 16 XEP 13 34 142	24405895					50 005 006 <small>NEW</small>
03.2003→02.2006 Reference	Z 16 XE 6 46 009 6 46 132 90369451 90444316	6 46 009 6 46 132 90369451 90444316	6 46 041 6 46 133 90442241 90541505	6 46 041 6 46 133 90442241 90541505		50 005 818	
03.2003→02.2006 Reference	Z 16 XE 13 34 077	63 34 035	9199592	93182038			50 005 793
Meriva 1.7 DTI 16V							126
03.2003→ Reference	Y 17 DT 13 34 073 97251178	13 34 143 97287175	63 34 024	93182028			50 005 755
Meriva 1.7 CDTI 16V							127
03.2003→ Reference	Z 17 DTH 13 34 073 97251178	13 34 143 97287175	63 34 024	93182028			50 005 755
Meriva 1.7 DI 16V							128
2004 → Reference	Y 17 DTL 13 34 073 97251178	13 34 143 97287175	63 34 024	93182028			50 005 755
Meriva 1.8i 16V							129
03.2003→ Reference	Z 18 XE 13 34 135	90543935					50 005 747
Movano 1.9 DTI							130
01.1999→10.2001 Reference	F9Q 770 44 09 162						50 005 301



V





							
01.1999→ Reference	F9Q 770, F9Q 772, F9Q 774 44 08 028						50 005 756
Movano 2.2 DTI 16V							131
01.2001→ Reference	G9T 722 44 01 595 9109595	44 01 595 9109595	45 06 045 9201450	45 06 045 9201450			50 005 794
Movano 2.5 DTI 16V							132
10.2001→ Reference	G9U 720 44 01 595 9109595	44 01 595 9109595	45 06 045 9201450	45 06 045 9201450			50 005 794
Nova 1.0							133
05.1983→08.1994 Reference	10 S 13 34 027	13 34 071	90091035	90409912			50 005 051
Nova 1.2							134
09.1982→08.1994 Reference	12 NV, 12 ST 13 34 025 90325660	13 34 065 90349239	13 34 098 9192793	90144227			50 005 059
Nova 1.2i							135
09.1990→09.1994 Reference	C 12 NZ 13 34 025 90325660	13 34 065 90349239	13 34 098 9192793	90144227			50 005 059
05.1983→08.1994 Reference	12 NC, E 12 GV 13 34 027	13 34 071	90091035	90409912			50 005 051
Nova 1.3							136
05.1983→09.1994 Reference	13 S, 13 SB 13 34 004 90183273	13 34 023 90349241	13 34 070	90076952			50 005 052
Nova 1.3i							137
09.1985→08.1994 Reference	13 NB, C 13 N 13 34 004 90183273	13 34 023 90349241	13 34 070	90076952			50 005 052





**Nova 1.4****138**

01.1990→08.1994	14 NV						
Reference	13 34 025 90325660 19307806→	13 34 065 90349239	13 34 098 9192793	90144227			50 005 059
01.1990→08.1994	14 NV						
Reference	6 46 029 90273981 14 NV : →02J22349 14 NV : →19307805	6 46 029 90273981	90231887	90231887		50 005 817	
01.1990→08.1994	14 NV						
Reference	13 34 011 90349240 →19307805	13 34 024	90234200	90325661			50 005 733



Nova 1.4i**139**

09.1991→08.1994	C 14 SE						
Reference	13 34 025 90325660	13 34 065 90349239	13 34 098 9192793	90144227			50 005 059
01.1990→08.1994	C 14 NZ , C 14 SE						
Reference	6 46 029 90273981 C 14 NZ : →02J22349 C 14 NZ : →19311373	6 46 029 90273981	90231887	90231887		50 005 817	

Nova 1.6i**140**

05.1988→08.1994	C 16 SE, E 16 SE						
Reference	13 34 025 90325660 E 16 SE: 02j22350→	13 34 065 90349239	13 34 098 9192793	90144227			50 005 059
05.1988→08.1994	C 16 NZ, C 16 SE, E 16 SE						
Reference	6 46 029 90273981 C 16 NZ, E 16 SE: →02J22349	6 46 029 90273981	90231887	90231887		50 005 817	
05.1988→03.1993	E 16 SE						
Reference	13 34 011 90349240 →02J22349	13 34 024	90234200	90325661			50 005 733

Omega B 2.0i**141**

04.1994→12.2000	20 SE						
Reference	6 46 001 90442362	6 46 001 90442362	6 46 042 90541506	6 46 042 90541506		50 005 850	
04.1994→12.2000	20 SE						
Reference	13 34 008 →14608700	90220568	90272361				50 005 735

V



04.1994→12.2000 Reference 	20 SE 13 34 054 14608701→	90444123			50 005 732
Omega B 2.0i 16V					142
09.1993→12.2000 Reference 	X 20 SE, X 20 XEV 6 46 001 90442362	6 46 001 90442362	6 46 042 90541506	6 46 042 90541506	 50 005 850
09.1993→08.1999 Reference 	X 20 XEV 6 46 036 90511958 →31000031	6 46 036 90511958	6 46 046 90541510	6 46 046 90541510	 50 005 851
04.1994→12.2000 Reference	X 20 SE 13 34 054	90444123			50 005 732
09.1993→08.1999 Reference	X 20 XEV 13 34 041 90444311	13 34 050	13 34 053	90443549	 50 005 734
09.1993→08.1999 Reference 	X 20 XEV 24406585 6 46 056 90542273 X 20 XEV: 14384800→ X 20 XEV: 31027954→	24406585 6 46 056 90542273	6 46 052 6 46 067 9118202	6 46 052 6 46 067 9118202	 50 005 848
Omega B 2.0 DTI 16V					143
09.1997→08.2000 Reference	X 20 DTH 13 34 117	90540478			50 005 748
Omega B 2.2i 16V					144
09.1999→09.2003 Reference	Y 22 XE 13 34 139				50 005 074 <small>NEW</small>
Omega B 2.2 DTI 16V					145
06.2000→ Reference	Y 22 DTH 13 34 117	90540478			50 005 748

V

**VAUXHALL****Omega B 2.5i 24V****146**

04.1994→11.2000 X 25 XE
 Reference 13 34 059 13 34 131 90444649 90543277



50 005 224

Omega B 2.5 TD**147**

04.1994→ X 25 TD
 Reference 13 34 101 13 34 112 13 34 124 90512535
 90541671



50 005 516

Senator A 3.0**148**

09.1985→08.1987 C 30 LE, C 30 NE
 Reference 13 34 009 13 34 021 90271492 90348231



50 005 740

Senator B 2.5i**149**

09.1987→10.1990 25 NE
 Reference 13 34 009 13 34 021 90271492 90348231



50 005 740

Senator B 2.6i**150**

09.1990→08.1993 C 26 NE
 Reference 13 34 009 13 34 021 90271492 90348231



50 005 740

Senator B 3.0i**151**

09.1987→09.1993 30 NE, C 30 LE, C 30 NE
 Reference 13 34 009 13 34 021 90271492 90348231



50 005 740

Senator B 3.0i 24V**152**

09.1989→08.1993 C 30 SE
 Reference 13 34 009 13 34 021 90271492 90348231



50 005 740

Signum 1.8i 16V**153**

10.2003→ Z 18 XER
 Reference 13 34 142 24405895

50 005 006
NEW**V**



05.2003→ Reference	Z 18 XE 13 34 135	90543935				50 005 747
Signum 1.9 CDTI 16V						154
03.2004→ Reference	Z 19 DTH 13 34 147					50 005 056 <small>NEW</small>
Signum 2.0 DTI 16V						155
05.2003→ Reference	Y 20 DTH 13 34 117	90540478				50 005 748
Sintra 2.2i 16V						156
09.1996→09.1999 Reference	X 22 XE 13 34 041 90444311	13 34 050	13 34 053	90443549		50 005 734
Sintra 2.2 TDI 16V						157
09.1997→09.1999 Reference	X 22 DTH 13 34 117	90540478				50 005 748
Tigra 1.4i 16V						158
09.1994→08.1999 Reference	X 14 XE 13 34 046	13 34 066	90444079	9192797		50 005 738
09.1994→08.1999 Reference	C 14 SEL, X 14 XE 6 46 009 6 46 132 90369451 90444316	6 46 009 6 46 132 90369451 90444316	6 46 041 6 46 133 90442241 90541505	6 46 041 6 46 133 90442241 90541505		50 005 818
Tigra 1.6i 16V						159
09.1994→08.1999 Reference	X 16 XE 13 34 046	13 34 066	90444079	9192797		50 005 738
09.1994→08.1999 Reference	C 16 SEL, X 16 XE 6 46 009 6 46 132 90369451 90444316	6 46 009 6 46 132 90369451 90444316	6 46 041 6 46 133 90442241 90541505	6 46 041 6 46 133 90442241 90541505		50 005 818

V

**VAUXHALL****Tigra B 1.3 CDTI 16V****160**

12.2004→	Z 13 DT								50 005 760
Reference	63 34 001	93177340							



Tigra B 1.4i 16V**161**

09.2004→	Z 14 XEP								50 005 003 <small>NEW</small>
Reference	13 34 145	24469102							



Tigra B 1.8i 16V**162**

09.2004→	Z 18 XE								50 005 747
Reference	13 34 135	90543935							

Vectra B 1.6i**163**





09.1995→09.2002	16 LZ2								50 005 850
Reference	6 46 001 90442362	6 46 001 90442362	6 46 042 90541506	6 46 042 90541506					
09.1996→08.2000	X 16 SZR								50 005 059
Reference	13 34 025 90325660	13 34 065 90349239	13 34 098 9192793	90144227					
09.1996→08.2000	X 16 SZR								50 005 818
Reference	6 46 009 6 46 132 90369451 90444316	6 46 009 6 46 132 90369451 90444316	6 46 041 6 46 133 90442241 90541505	6 46 041 6 46 133 90442241 90541505					

Vectra B 1.6i 16V**164**



09.1995→08.2000	X 16 XEL								50 005 738
Reference	13 34 046	13 34 066	90444079	9192797					
09.1995→08.2001	X 16 XEL, Y 16 XE, Z 16 XE								50 005 818
Reference	6 46 009 6 46 132 90369451 90444316	6 46 009 6 46 132 90369451 90444316	6 46 041 6 46 133 90442241 90541505	6 46 041 6 46 133 90442241 90541505					
09.1995→08.2001	X 16 XEL, Z 16 XE								50 005 793
Reference	13 34 077 X 16 XEL: 02MZ5254/20U75999→	63 34 035	9199592	93182038					

V



**Vectra B 1.8i 16V****165**

09.1995→08.1999	X 18 XE						50 005 851	
Reference	6 46 036 90511958 →14261174	6 46 036 90511958	6 46 046 90541510	6 46 046 90541510				
09.1995→08.1999	X 18 XE						50 005 734	
Reference	13 34 041 90444311	13 34 050	13 34 053	90443549				
09.1998→08.2001	X 18 XE1, Z 18 XE						50 005 747	
Reference	13 34 135	90543935						
09.1995→08.1999	X 18 XE						50 005 848	
Reference	24406585 6 46 056 90542273 14372573→	24406585 6 46 056 90542273	6 46 052 6 46 067 9118202	6 46 052 6 46 067 9118202				

Vectra B 2.0i**166**

09.1995→08.2001	20 NEJ						50 005 851	
Reference	6 46 036 90511958	6 46 036 90511958	6 46 046 90541510	6 46 046 90541510				
09.1995→08.2001	20 NEJ						50 005 732	
Reference	13 34 054	90444123						

Vectra B 2.0i 16V**167**

10.1995→	C 20 SEL, X 20 XEV						50 005 851	
Reference	6 46 036 90511958 C 20 SEL: →25001463 X 20 XEV: →31000031	6 46 036 90511958	6 46 046 90541510	6 46 046 90541510				
10.1995→	X 20 XEV						50 005 734	
Reference	13 34 041 90444311	13 34 050	13 34 053	90443549				
10.1995→	C 20 SEL, X 20 XEV						50 005 848	
Reference	24406585 6 46 056 90542273 X 20 XEV: 14390219→ X 20 XEV: 31027954→	24406585 6 46 056 90542273	6 46 052 6 46 067 9118202	6 46 052 6 46 067 9118202				

Vectra B 2.0 DI 16V**168**

09.1996→08.2000	X 20 DTL						50 005 748	
Reference	13 34 117	90540478						

**VAUXHALL****Vectra B 2.0 DTi 16V****169**

09.1997→08.2001 X 20 DTH, Y 20 DTH
 Reference 13 34 117 90540478

**50 005 748****Vectra B 2.2i 16V****170**

09.2000→08.2001 Z 22 SE
 Reference 13 34 067 13 34 083 63 34 002 91 94 747
 93178602

**50 005 792**

10.1999→08.2001 C 22 SEL
 Reference 24406585 24406585 6 46 052 6 46 052
 6 46 056 6 46 056 6 46 067 6 46 067
 90542273 90542273 9118202 9118202

**50 005 848****Vectra B 2.5i 24V****171**

09.1995→08.2001 X 25 XE
 Reference 13 34 059 13 34 131 90444649 90543277

**50 005 224****Vectra C 1.6i 16V****172**

01.2006→ Z 16 XEP
 Reference 13 34 142 24405895

**50 005 006**
NEW

09.2001→ Z 16 XE
 Reference 6 46 009 6 46 009 6 46 041 6 46 041
 6 46 132 6 46 132 6 46 133 6 46 133
 90369451 90369451 90442241 90442241
 90444316 90444316 90541505 90541505

**50 005 818**

09.2001→ Z 16 XE
 Reference 13 34 077 63 34 035 9199592 93182038

**50 005 793****Vectra C 1.8i 16V****173**

03.2006→ Z 18 XER
 Reference 13 34 142 24405895

**50 005 006**
NEW

09.2001→ Z 18 XE
 Reference 13 34 135 90543935

**50 005 747****V**

**Vectra C 1.9 CDTI 16V****174**03.2004→
ReferenceZ 19 DTH
13 34 14750 005 056
NEW**Vectra C 2.0 DTI 16V****175**04.2002→
ReferenceY 20 DTH
13 34 117 90540478

50 005 748

Vectra C 2.2i 16V**176**09.2001→
ReferenceZ 22 SE
13 34 067 13 34 083 63 34 002 91 94 747
93178602

50 005 792

Vivaro 1.9 DTI**177**03.2001→
ReferenceF9Q 760, F9Q 762
44 08 028

50 005 756

Vivaro 2.0i 16V**178**03.2001→
ReferenceF4R 720
44 08 028

50 005 756

Vivaro 2.5 CDTI 16V**179**04.2004→
ReferenceG9U 630, G9U 730
44 01 595 44 01 595 45 06 045 45 06 045
9109595 9109595 9201450 9201450

50 005 794

VX 220 2.0i Turbo 16V**180**04.2003→
ReferenceZ 20 LET
13 34 041 13 34 050 13 34 053 90443549
90444311



50 005 734

VX 220 2.2i 16V**181**09.2000→
ReferenceZ 22 SE
13 34 067 13 34 083 63 34 002 91 94 747
93178602

50 005 792

V

**VAUXHALL****Zafira A 1.6i 16V****182**

09.1998→08.1999	X 16 XEL							
Reference	13 34 046	13 34 066	90444079	9192797				50 005 738
09.1998→07.2005	X 16 XEL, Z 16 XE							
Reference	6 46 009 6 46 132 90369451 90444316	6 46 009 6 46 132 90369451 90444316	6 46 041 6 46 133 90442241 90541505	6 46 041 6 46 133 90442241 90541505				50 005 818
09.1998→07.2005	X 16 XEL, Z 16 XE							
Reference	13 34 077	63 34 035	9199592	93182038				50 005 793
	X 16 XEL: 02MZ5254/20U75999→							



Zafira A 1.6i 16V (Gas)**183**

09.2001→	Z 16 YNG							
Reference	6 46 009 6 46 132 90369451 90444316	6 46 009 6 46 132 90369451 90444316	6 46 041 6 46 133 90442241 90541505	6 46 041 6 46 133 90442241 90541505				50 005 818

Zafira A 1.8i 16V**184**

03.1999→	X 18 XE1, Z 18 XE							
Reference	13 34 135	90543935						50 005 747

Zafira A 2.0i 16V**185**

02.1999→07.2005	X 20 XEV							
Reference	13 34 041 90444311	13 34 050	13 34 053	90443549				50 005 734
02.1999→07.2005	X 20 XER, X 20 XEV							
Reference	24406585 6 46 056 90542273	24406585 6 46 056 90542273	6 46 052 6 46 067 9118202	6 46 052 6 46 067 9118202				50 005 848

Zafira A 2.0 DI 16V**186**

03.1999→08.2000	X 20 DTL							
Reference	13 34 117	90540478						50 005 748

V**Zafira A 2.0 DTI 16V****187**

04.1999→07.2005	Y 20 DTH							
Reference	13 34 117	90540478						50 005 748



Zafira A 2.2i 16V

188

09.2000→ Reference	Z 22 SE 13 34 067 93178602	13 34 083	63 34 002	91 94 747			50 005 792
-----------------------	----------------------------------	-----------	-----------	-----------	---	--	------------

Zafira B 1.6i 16V

189

07.2005→ Reference	Z 16 XEP 13 34 142	24405895					50 005 006 <small>NEW</small>
-----------------------	-----------------------	----------	--	--	---	--	----------------------------------

07.2005→ Reference	Z 16 XEP 6 46 009 6 46 132 90369451 90444316	6 46 009 6 46 132 90369451 90444316	6 46 041 6 46 133 90442241 90541505	6 46 041 6 46 133 90442241 90541505		50 005 818	
-----------------------	--	--	--	--	---	------------	--

Zafira B 1.8i 16V

190

07.2005→ Reference	Z 18 XER 13 34 142	24405895					50 005 006 <small>NEW</small>
-----------------------	-----------------------	----------	--	--	--	--	----------------------------------

Zafira B 1.9 CDTI 16V

191

07.2005→ Reference	Z 19 DTH 13 34 147						50 005 056 <small>NEW</small>
-----------------------	-----------------------	--	--	--	---	--	----------------------------------

Zafira B 2.0i Turbo 16V

192

03.2005→ Reference	Z 20 LEL, Z 20 LER 13 34 139						50 005 074 <small>NEW</small>
-----------------------	---------------------------------	--	--	--	---	--	----------------------------------





Zafira B 2.0i Turbo 16V

193



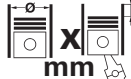

09.2001→ Reference	Z 20 LET 13 34 041 90444311	13 34 050	13 34 053	90443549			50 005 734
-----------------------	-----------------------------------	-----------	-----------	----------	---	--	------------

V







			Cyl	 mm	cm ³		Comp. Ratio ε	kW	PS	Pos
1C	D	(A)	4	76,5 x 86,4	1588	2	23:1	51	70	156
1F	B		4	81 x 77,4	1595	2	9:1	55	75	18, 19, 237, 285
1G	D	(A)	6	76,5 x 86,4	2383	2	23:1	68	92	47, 186, 190, 195, 199, 202, 207, 209
1H	B	(A)	4	81 x 86,4	1781	2	8:1	118	160	113
1P	B		4	81 x 86,4	1781	2	9:1	72	98	111, 173
1S	D	(AN)	6	76,5 x 86,4	2383	2	23,5:1	51	70	47, 184, 189, 191, 193, 198, 201, 206
1V	D	(A)	4	76,5 x 86,4	1588	2	23:1	44	60	81, 109, 170
1W	D	(AN)	4	75 x 79,1	1398	2	22,3:1	35	48	283
1X	D	(AN)	4	79,5 x 95,5	1896	2	22,5:1	44	60	32, 368
1Y	D	(AN)	4	79,5 x 95,5	1896	2	22,5:1	47	64	23, 86, 118, 230, 248, 290, 295, 331, 379, 386
1Z	D	(LA)	4	79,5 x 95,5	1896	2	19,5:1	66	90	24, 120, 250, 344, 388
2E	B		4	82,5 x 92,8	1984	2	10,5:1	85	115	51, 122, 251, 390
2G	B		4	75 x 72	1272	2	9:1	40	54	104, 160, 276
2H	B		4	81 x 86,4	1781	2	9:1	72	98	111
3F	B		4	75 x 72	1272	2	10:1	55-57	75-78	277
9A	B		4	82,5 x 92,8	1984	4	10,8:1	100	136	52, 114, 252
AAA	B		6	81 x 90,3	2792	2	10:1	120-128	163-174	53, 92, 125, 181, 262, 347, 392
AAB	D	(AN)	5	79,5 x 95,5	2370	2	23:1	57	78	36, 48, 67, 371
AAC	B		4	81 x 95,5	1998	2	8,5:1	62	84	35, 370
AAF	B		5	81 x 95,5	2461	2	8,5:1	81	110	37, 68, 372
AAK	B		4	75 x 59	1043	2	9,5:1	33	45	272
AAM	B		4	81 x 86,4	1781	2	9:1	55	75	83, 117, 173, 242, 385
AAU	B		4	75 x 59	1043	2	10:1	33	45	272
AAV	B		4	75 x 72	1272	2	9,2:1	40	54	276
AAZ	D	(A)	4	79,5 x 95,5	1896	2	22,5:1	55	75	87, 119, 175, 249, 387
ABD	B		4	75 x 78,7	1391	2	9,2:1	44	60	115, 383
ABF	B		4	82,5 x 92,8	1984	4	10,4:1	110	150	91, 123, 252
ABL	D	(A)	4	79,5 x 95,5	1896	2	22,5:1	50	68	33, 87, 369
ABN	B		4	81 x 77,4	1595	2	9:1	55	75	79, 107, 165, 237
ABS	B		4	81 x 86,4	1781	2	10:1	66	90	63, 117, 242, 385
ABU	B		4	76,5 x 86,9	1598	2	9,3:1	55	75	116, 384
ABV	B		6	82 x 90,3	2861	2	10:1	135-140	184-190	54, 126, 265
ACC	B		4	81 x 86,4	1781	2	10:1	66	90	83, 117, 173
ACK	B		6	82,5 x 86,4	2771	5	10,6:1	142	193	264
ACL	D	(LA)	6	76,5 x 86,4	2383	2	22:1	70	95	47, 186, 190, 195, 199, 202, 207, 209
ACM	B		4	75 x 59	1043	2	10:1	33	45	272
ACT	D	(AN)	6	76,5 x 86,4	2383	2	23:1	51	70	184, 189, 193, 198, 201, 206
ACU	B		5	81 x 95,5	2461	2	8,5:1	81	110	37, 68, 372
ACV	D	(LA)	5	81 x 95,5	2461	2	19,5:1	75	102	38, 373
ACX	B		4	82,5 x 92,8	1984	2	10,4:1	78	106	251
ADC	B		4	82,5 x 92,8	1984	2	10,4:1	85	115	122, 293, 297, 390
ADD	B		4	81 x 86,4	1781	2	10:1	66	90	22, 63, 117, 173, 288, 294, 385
ADP	B		4	81 x 77,4	1595	2	10,3:1	74	101	236
ADR	B		4	81 x 86,4	1781	5		92	125	244
ADX	B		4	76,5 x 70,5	1296	2	10:1	40	54	277
ADY	B		4	82,5 x 92,8	1984	2	10,4:1	85	115	51, 122, 251, 345, 390
ADZ	B		4	81 x 86,4	1781	2	9/10:1	66	90	63, 83, 117, 242, 385
AEA	B		4	76,5 x 86,9	1598	2	9,3:1	55	75	116, 285, 384
AEB	B	(A)	4	81 x 86,4	1781	5	9,5:1	110	150	245
AEE	B		4	76,5 x 86,9	1598	2	9,8:1	55	75	19, 79, 116, 285, 384
AEF	D	(AN)	4	79,5 x 95,5	1896	2	22,5:1	47	64	23, 290
AEG	B		4	82,5 x 92,8	1984	2	10,5:1	85	115	135, 178, 225
AEH	B		4	81 x 77,4	1595	2	10,3:1	74	101	2, 128, 285
AEK	B		4	81 x 77,4	1595	2	10,3:1	74	101	116, 237, 384
AEN	B		5	81 x 95,5	2461	2	10:1	81	110	372
AEP	B		4	82,5 x 92,8	1984	2	10,4:1	79	107	90, 122, 251, 390
AER	B		4	67,1 x 70,6	999	2	10,5:1	37	50	210, 270, 393
AES	B		6	81 x 90,3	2792	2	10:1	103	140	39, 69, 374
AET	B		5	81 x 95,5	2461	2	8,5:1	81	110	37, 372
AEU	B		5	81 x 95,5	2461	2	10:1	81	110	37, 372
AEV	B		4	75 x 59	1043	2	10:1	33	45	272
AEX	B		4	76,5 x 75,6	1390	2	10,2:1	40-44	55-60	14, 77, 115, 280, 383





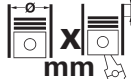

			Cyl	 mm	cm ³		Comp. Ratio ε	kW	PS	Pos
AEY	D	(AN)	4	79,5 x 95,5	1896	2	19,5:1	47	64	25, 89, 121, 291, 389
AFB	D	(A)	6	78,3 x 86,4	2496	4	19,5:1	110	150	260
AFH	B		4	76,5 x 75,6	1390	4	10,5:1	74	101	281
AFK	B		4	76,5 x 75,6	1390	4	10,5:1	74	101	213, 281
AFN	D	(LA)	4	79,5 x 95,5	1896	2	19,5:1	81	110	120, 250, 292, 344, 388
AFP	B		6	81 x 90,3	2792	4	10:1	130	177	138, 182
AFT	B		4	81 x 77,4	1595	2	10,5:1	74	101	79, 116, 237, 285, 384
AFY	B		4	81 x 86,4	1781	2		85	115	242
AGD	D	(AN)	4	79,5 x 95,5	1896	2	19,5:1	47	64	89, 291
AGE	B		6	82,5 x 86,4	2771	5	10,6:1	132	180	264
AGG	B		4	82,5 x 92,8	1984	2	10:1	85	115	90, 122, 251, 390
AGK	D	(LA)	4	93 x 103	2798	2	20:1	92	125	187, 196, 204
AGL	B		4	90,9 x 88,4	2295	2	8,8:1	105	143	183, 188, 192, 197, 200, 203, 205, 208
AGN	B		4	81 x 86,4	1781	5		92	125	5, 131
AGP	D	(AN)	4	79,5 x 95,5	1896	2	22,5:1	50	68	7, 133, 291
AGR	D	(LA)	4	79,5 x 95,5	1896	2	19,5:1	66	90	8, 88, 134, 292, 296
AGU	B	(LA)	4	81 x 86,4	1781	5	9,5:1	110	150	6, 132, 223
AGX	D	(AN)	5	81 x 95,5	2461	2	19,5:1	55	75	185, 194
AGZ	B		5	81 x 90,2	2324	4	10,1:1	110	150	11, 124, 259
AHA	B		6	82,5 x 86,4	2771	4	10,3:1	142	193	263
AHB	D	(AN)	4	79,5 x 86,4	1716	2	19,5:1	42	57	21
AHD	D	(LA)	5	81 x 95,5	2461	2	19,5:1	75	102	187, 196, 204
AHF	D	(LA)	4	79,5 x 95,5	1896	2	19,5:1	81	110	8, 134
AHG	D	(AN)	4	79,5 x 86,4	1716	2	19,5:1	42	57	287
AHH	D	(A)	4	79,5 x 95,5	1896	2	19,5:1	66	90	250
AHL	B		4	81 x 77,4	1595	2	10,3:1	74	101	236
AHP	B		4	81 x 77,4	1595	5		74	101	167
AHS	B		4	76,5 x 86,9	1598	2	9,8:1	55	75	285
AHT	B		4	67,1 x 70,6	999	2	10,7:1	37	50	210
AHU	D	(A)	4	79,5 x 95,5	1896	2	19,5:1	66	90	24, 120, 176, 250, 292, 344, 388
AHW	B		4	76,5 x 75,6	1390	4	10,5:1	55	75	1, 127, 213, 281
AHY	D	(LA)	5	81 x 95,5	2461	2	19,5:1	111	151	38, 373
AJA	D	(AN)	5	79,5 x 95,5	2370	2	23,5:1	55	75	36, 371
AJH	B	(LA)	4	81 x 86,4	1781	5	9,5:1	110	150	343
AJM	D	(A)	4	79,5 x 95,5	1896	2	19,5:1	85	115	8, 134, 250
AJT	D	(A)	5	81 x 95,5	2461	2	19,5:1	65	88	38, 373
AJV	B		4	76,5 x 86,9	1598	4	10,6:1	88	120	286
AKK	B		4	76,5 x 75,6	1390	2	10,4:1	44	60	280
AKL	B		4	81 x 77,4	1595	2	10,2:1	74	101	2, 116, 285
AKN	D	(A)	6	78,3 x 86,4	2496	4	19,5:1	110	150	260
AKP	B		4	76,5 x 75,6	1390	2	10,2:1	40	54	280
AKQ	B		4	76,5 x 75,6	1390	4	10,5:1	55	75	1, 127, 213
AKR	B		4	82,5 x 92,8	1984	2	10:1	85	115	90, 122, 390
AKS	B		4	81 x 77,4	1595	2	10,3:1	74	101	79, 116, 384
AKU	D	(AN)	4	79,5 x 86,4	1716	2	19,5:1	44	60	217, 287
AKV	B		4	76,5 x 75,6	1390	2	10,2:1	44	60	14, 280
AKW	D	(AN)	4	79,5 x 86,4	1716	2	19,5:1	42	57	287
ALD	B		4	67,1 x 70,6	999	2	10,7:1	37	50	210, 270
ALE	D	(LA)	4	79,5 x 95,5	1896	2	19,5:1	66	90	24, 88, 120, 292, 388
ALG	B		6	82,5 x 86,4	2771	5	10,6:1	142	193	264
ALH	D	(A)	4	79,5 x 95,5	1896	2	19,5:1	66	90	8, 24, 134, 176, 224, 292
ALL	B		4	67,1 x 70,6	999	2	10,7:1	37	50	210, 270
ALM	B			76,5 x 86,9	1598	2	9,8:1	55	75	285
ALT	B		4	82,5 x 92,8	1984	5	10,3:1	96	131	253
ALZ	B		4	81 x 77,4	1595	2	10,3:1	75	102	237
AMF	D	(LA)	3	79,5 x 95,5	1422	2	19,5:1	55	75	215, 284
AMX	B		6	82,5 x 86,4	2771	5	10,6:1	142	193	264
AMY	B		6	81 x 90,3	2792	2	10:1	128	174	347
ANA	B		4	81 x 77,4	1595	2	10,3:1	74	101	237
ANB	B	(A)	4	81 x 86,4	1781	5	9,5:1	110	150	245
ANJ	D	(A)	5	81 x 95,5	2461	2	19,5:1	80	109	187, 196
ANN	B		4	81 x 86,4	1781	2	9:1	55	75	117
ANP	B		4	81 x 86,4	1781	2	10:1	66	90	117
ANU	D	(LA)	4	79,5 x 95,5	1896	2	19,5:1	66	90	344
ANV	B		4	67,1 x 70,6	999	2	10,7:1	37	50	210
ANW	B		4	76,5 x 75,6	1390	2	10,4:1	44	60	280
ANX	B		4	76,5 x 75,6	1390	2	10,2:1	40	54	280



			Cyl	 mm	cm ³		Comp. Ratio ε	kW	PS	Pos
ANY	D	(LA)	3	76,5 x 86,4	1191	2	19,5:1	45	61	211
AP 112	B		4	82,5 x 92,8	1984	4	10:1	82	111	91, 232, 333
AP 504	B		4	81 x 77,4	1595	2				79, 228, 328
AP 505	B		4	81 x 77,4	1595	2		50	68	79, 228, 328
AP 521	B		4	81 x 77,4	1595	2				79, 228, 328
AP 522	B		4	81 x 86,4	1781	2				83, 229, 330
AP 528	B		4	82,5 x 92,8	1984	2	10:1	80	109	90, 231, 332
AP 529	B		4	82,5 x 92,8	1984	2	10:1	80	109	90, 231, 332
AP 540	B		4	81 x 77,4	1595	2				79, 228, 328
AP 541	B		4	81 x 77,4	1595	2		50	68	79, 228, 328
AP 542	B		4	81 x 77,4	1595	2				79, 228, 328
AP 543	B		4	81 x 86,4	1781	2				83, 229, 330
AP 546	B		4	82,5 x 92,8	1984	2	10:1	82	111	90, 231, 332
AP 547	B		4	82,5 x 92,8	1984	2	10:1	82	111	90, 231, 332
APA	D	(A)	5	81 x 95,5	2461	2	19,5:1	66	90	187, 196, 204
APE	B		4	76,5 x 75,6	1390	4	10,5:1	55	75	1, 127, 213, 281
APF	B		4	81 x 77,4	1595	2	10,3:1	74	101	2, 128, 285
APH	B	(A)	4	81 x 86,4	1781	5	9,5:1	110	150	223
APK	B		4	82,5 x 92,8	1984	2	10,5:1	85	115	9, 135, 178, 225
APL	B		5	81 x 95,5	2461	2	8,5:1	85	115	37, 372
APQ	B		4	76,5 x 75,6	1390	2	10,2:1	44	60	14, 115, 280, 383
APR	B		6	82,5 x 86,4	2771	5	10,6:1	142	193	264
APT	B		4	81 x 86,4	1781	5	10,3:1	92	125	244
APU	B	(A)	4	81 x 86,4	1781	5	9,5:1	110	150	245
AQA	B	(A)	4	81 x 86,4	1781	5	9,5:1	110	150	132
AQD	B		6	82,5 x 86,4	2771	5	10,6:1	142	193	264
AQM	D	(LA)	4	79,5 x 95,5	1896	2	19,5:1	50	68	7, 133, 177, 291
AQN	B		5	81 x 90,2	2324	5	10,8:1	125	170	12, 137, 226
AQP	B		6	81 x 90,3	2792	4	10,75:1	150	204	13, 138
AQQ	B		4	76,5 x 75,6	1390	4	10,5:1	74	101	213, 281
AQY	B		4	82,5 x 92,8	1984	2	10,3:1	85	115	9, 135, 225
ARC	B		4	76,5 x 86,9	1598	4	11,5:1	92	125	286
ARG	B		4	81 x 86,4	1781	5	10,3:1	92	125	244
ARL	D	(LA)	4	79,5 x 95,5	1896	2	19,5:1	110	150	8, 134
ARM	B		4	81 x 77,4	1595	2	10,3:1	74	101	237
ARR	B		4	76,5 x 75,6	1390	4	11,5:1	77	105	214
ARZ	B	(A)	4	81 x 86,4	1781	5	9,5:1	110	150	132
ASU	B		4	82,5 x 92,8	1984	2	10,5:1	88	120	251
ASV	D	(LA)	4	79,5 x 95,5	1896	2	19,5:1	81	110	8, 134, 292
ASX	D	(AN)	4	79,5 x 95,5	1896	2	22,5:1	47	64	291
ASY	D	(AN)	4	79,5 x 95,5	1896	2	19,5:1	47	64	72, 291, 300, 349, 350, 351
ASZ	D	(LA)	4	79,5 x 95,5	1896	2	19:1	96	130	8, 134, 292, 344
ATA	D	(LA)	4	93 x 103	2798	2	17,8:1	96	130	187, 196, 204
ATD	D	(LA)	4	79,5 x 95,5	1896	2	19:1	74	101	8, 134, 224, 292, 306
ATJ	D	(LA)	4	79,5 x 95,5	1896	2	18:1	85	115	250
ATL	D	(A)	3	79,5 x 95,5	1422	2	19,5:1	66	90	284
ATM	B		4	82,5 x 92,8	1984	2	10:1	85	115	345, 346
ATN	B		4	76,5 x 86,9	1598	4	11,5:1	77	105	3, 129
AUA	B		4	76,5 x 75,6	1390	4	10,5:1	55	75	15, 213, 281
AUB	B		4	76,5 x 75,6	1390	4	10,5:1	74	101	213, 281
AUC	B		4	67,1 x 70,6	999	2	10,7:1	37	50	210, 270
AUD	B		4	76,5 x 75,6	1390	2	10,4:1	44	60	14, 212, 280
AUE	B		6	81 x 90,3	2792	4	10,75:1	150	204	13, 138
AUF	D	(LA)	5	81 x 95,5	2461	2	19,5:1	75	102	38, 373
AUM	B	(LA)	4	81 x 86,4	1781	5	9,5:1	110	150	6, 132
AUQ	B	(LA)	4	81 x 86,4	1781	5	9,5:1	132	180	6, 85, 132
AUR	B		4	81 x 77,4	1595	2	10,3:1	74	101	285
AUS	B		4	76,5 x 86,9	1598	4	11,5:1	77	105	3, 129
AUY	D	(LA)	4	79,5 x 95,5	1896	2	18:1	85	115	8, 134, 344
AUZ	B		4	82,5 x 92,8	1984	2	10,5:1	88	120	251
AVA	B		4	82,5 x 92,8	1984	2	10,5:1	88	120	251
AVB	D	(A)	4	79,5 x 95,5	1896	2	19:1	74	101	250
AVC	B	(A)	4	81 x 86,4	1781	5	9,5:1	110	150	223
AVF	D	(LA)	4	79,5 x 95,5	1896	2	19:1	96	130	250
AVG	D	(LA)	4	79,5 x 95,5	1896	2	19,5:1	81	110	134, 250, 344
AVH	B		4	82,5 x 92,8	1984	2	10,4:1	85	115	225
AVQ	D	(LA)	4	79,5 x 95,5	1896	2	19:1	74	101	356







			Cyl	 mm	cm ³		Comp. Ratio ε	kW	PS	Pos
AVR	D	(LA)	5	81 x 95,5	2461	2	19,5:1	80	109	187, 196, 204
AVT	B		5	81 x 95,5	2461	2	8,5:1	85	115	37, 372
AVU	B		4	81 x 77,4	1595	2	10,3:1	75	102	2, 128
AVY	B		4	76,5 x 86,9	1598	4	11,5:1	92	125	216, 286
AWC	B	(LA)	4	81 x 86,4	1781	5	9,5:1	110	150	343
AWH	B		4	81 x 77,4	1595	2	10,3:1	74	101	222
AWM	B	(LA)	4	81 x 86,4	1781	5	9,3:1	125	170	245
AWP	B	(LA)	4	81 x 86,4	1781	5	9,5:1	132	179	223
AWT	B	(A)	4	81 x 86,4	1781	5	9,5:1	110	150	245
AWU	B	(A)	4	81 x 86,4	1781	5	9,5:1	110	150	223
AWV	B	(A)	4	81 x 86,4	1781	5	9,5:1	110	150	223
AWX	D	(A)	4	79,5 x 95,5	1896	2	19:1	96	130	250
AWY	B		3	76,5 x 86,9	1198	2	10,8:1	40	54	274
AXA	B		4	82,5 x 92,8	1984	2	10,3:1	85	115	35, 376
AXB	D	(LA)	4	79,5 x 95,5	1896	2	18,5:1	77	105	34, 375
AXC	D	(LA)	4	79,5 x 95,5	1896	2	19,5:1	63	85	34, 375
AXD	D	(LA)	5	81 x 95,5	2460	2	18:1	96	130	34, 377
AXE	D	(LA)	5	81 x 95,5	2460	2	18:1	128	174	38, 377
AXJ	B		6	84 x 95,9	3189	4	10,8:1	165	225	227
AXL	D	(LA)	5	81 x 95,5	2461	2	19,5:1	75	102	37, 373
AXP	B		4	76,5 x 75,6	1390	4	10,5:1	55	75	1, 127, 162
AXR	D	(LA)	4	79,5 x 95,5	1896	2	19:1	74	101	8, 134, 224, 292, 306
AXU	B		4	76,5 x 75,6	1390	4	12:1	63	85	282
AXW	B		4	82,5 x 92,8	1984	4	11,5:1	110	150	146, 357
AYC	D	(A)	5	81 x 95,5	2461	2	19,5:1	75	102	38, 373
AYD	B		4	81 x 77,4	1595	2	10,5:1	75	102	222
AYL	B		6	81 x 90,3	2792	4	10,5:1	150	204	348
AYQ	D	(AN)	4	79,5 x 95,5	1896	2	19,5:1	47	64	25
AYY	D	(A)	5	81 x 95,5	2461	2	19,5:1	65	88	38, 373
AYZ	D	(LA)	3	76,5 x 86,4	1191	2	19,5:1	45	61	211
AZD	B		4	76,5 x 86,9	1598	4	11,5:1	77	105	3, 129
AZG	B		4	82,5 x 92,8	1984	2	10,5:1	85	115	9, 135, 178, 225
AZH	B		4	82,5 x 92,8	1984	2	10,5:1	85	115	9, 135
AZJ	B		4	82,5 x 92,8	1984	2	10,4:1	85	116	9, 135, 225
AZM	B		4	82,5 x 92,8	1984	2	10,5:1	85	115	251
AZQ	B		3	76,5 x 86,9	1198	4	10,5:1	47	64	275
AZV	D	(LA)	4	81 x 95,5	1968	4	18:1	100	136	148, 155, 180, 359
AZX	B		5	81 x 90,2	2324	4	10,8:1	125	170	259
AZZ	B		6	84 x 95,9	3189	4	11,3:1	162	220	353
BAA	B		6	84 x 95,9	3189	4	11,3:1	162	220	353
BAC	D	(LA)	5	81 x 95,5	2461	2	18:1	128	174	352
BAD	B		4	76,5 x 86,9	1598	4	12:1	81	110	4, 130
BAG	B		4	76,5 x 86,9	1598	4	12:1	85	115	143, 355
BAU	D	(LA)	6	78,3 x 86,4	2496	4	18,5:1	132	179	261
BAY	D	(LA)	3	79,5 x 95,5	1422	2	19,5:1	55	75	284, 299
BBE	D	(A)	5	81 x 95,5	2461	2	19,5:1	61	83	187, 196, 204
BBF	D	(A)	5	81 x 95,5	2461	2	19,5:1	70	95	187, 196, 204
BBU	B	(LA)	4	81 x 86,4	1781	5	9,5:1	132	179	289
BBX	B		4	82,5 x 92,8	1984	2	10,5:1	85	116	293, 301
BBY	B		4	76,5 x 75,6	1390	4	10,5:1	55	75	213, 281, 298
BBZ	B		4	76,5 x 75,6	1390	4	10,5:1	74	101	281, 298, 302, 303
BCA	B		4	76,5 x 75,6	1390	4		55	75	1, 15, 127, 140, 151, 221
BCB	B		4	76,5 x 86,9	1598	4	11,5:1	77	105	3, 129
BDE	B		6	81 x 90,3	2792	4	10,75:1	150	204	13, 138
BDG	D	(LA)	6	78,3 x 86,4	2496	4	18,5:1	120	163	261
BDH	D	(LA)	6	78,3 x 86,4	2496	4	18,5:1	132	179	261
BDJ	D	(AN)	4	81 x 95,5	1968	2	19:1	51	70	26
BDK	D	(AN)	4	81 x 95,5	1968	2	19:1	55	75	147
BDL	B		6	84 x 95,9	3189	4	11,3:1	170	231	378
BEH	G		4	82,5 x 92,8	1984	2	10,4:1	85	116	136
BEJ	B		4	82,5 x 92,8	1984	2	10,3:1	85	115	225
BER	B		4	82,5 x 92,8	1984	2	10,3:1	85	116	225
BEV	B		4	82,5 x 92,8	1984	2	10,3:1	85	116	225
BEW	D	(LA)	4	79,5 x 95,5	1896	2	19:1	74	101	8, 224
BFH	B		6	84 x 95,9	3189	4	11,3:1	177	241	139
BFQ	B		4	81 x 77,4	1595	2	10,2:1	75	102	2, 128
BFS	B		4	81 x 77,4	1595	2	10,5:1	75	102	222
BGU	B		4	81 x 77,4	1595	2	10,5:1	75	102	18, 142, 354
BGW	D	(LA)	4	81 x 95,5	1968	2	18:1	100	136	255



			Cyl		mm	cm ³	Comp. Ratio	€	kW	PS	Pos
BHP	B		4	82,5 x 92,8	1984	2	10,3:1		85	115	225
BJB	D	(LA)	4	79,5 x 95,5	1896	2	19:1		77	105	24, 29, 219
BJK	D	(LA)	5	81 x 95,5	2459	2			80	109	55, 187, 196, 204
BJL	D	(LA)	5	81 x 95,5	2459	2			100	136	55, 187, 196, 204
BJM	D	(LA)	5	81 x 95,5	2459	2			120	163	55, 187, 196, 204
BJX	B	(LA)	4	81 x 86,4	1781	5	9,5:1		110	150	289
BKC	D	(LA)	4	79,5 x 95,5	1896	2	19:1		77	105	8, 145, 176, 250, 356, 388
BKD	D	(LA)	4	81 x 95,5	1968	4	18:1		103	140	10, 148, 155, 180, 359, 391
BKF	B	(LA)	4	81 x 86,4	1781	5	9,5:1		110	150	223
BKG	B		4	76,5 x 75,6	1390	4	12:1		66	90	141
BKJ	B		6	84 x 95,9	3189	4	11,3:1		162	220	353
BKK	B		6	84 x 95,9	3189	4	11,3:1		173	235	40, 378
BKP	D	(LA)	4	81 x 95,5	1968	4	18,5:1		103	140	256
BKY	B		4	76,5 x 75,6	1390	4	10,5:1		55	75	281, 298, 302
BLF	B		4	76,5 x 86,9	1598	4	12:1		85	115	64, 143, 168, 238, 355
BLK	D	(LA)	5	81 x 95,5	2460	2	18:1		120	163	352
BLN	B		4	76,5 x 75,6	1390	4	12:1		66	90	141
BLP	B		4	76,5 x 86,9	1598	4	12:1		85	116	143, 355
BLR	B		4	82,5 x 92,8	1984	4	11,5:1		110	150	146, 179, 254, 357
BLS	D	(LA)	4	79,5 x 95,5	1896	2	19:1		77	105	24, 29, 145, 153, 176, 219, 250, 356
BLT	D	(LA)	4	79,5 x 95,5	1896	2	19:1		96	130	292
BLX	B		4	82,5 x 92,8	1984	4	11,5:1		110	150	146, 254, 357
BLY	B		4	82,5 x 92,8	1984	4	11,5:1		110	150	146, 179, 254, 357
BMA	D	(LA)	4	81 x 95,5	1968	4	18,5:1		100	136	256
BML	B		6	84 x 95,9	3189	4	11,3:1		177	241	149
BMP	D	(LA)	4	81 x 95,5	1968	2	18,5:1		103	140	255
BMS	D	(LA)	3	79,5 x 95,5	1422	2	19,5:1		59	80	284
BMT	D	(LA)	4	79,5 x 95,5	1896	2	19:1		74	101	292, 306
BMV	B		6	84 x 95,9	3189	4	11,3:1		162	220	353
BMX	B		6	84 x 95,9	3189	4	11,3:1		162	220	353
BNM	D	(LA)	3	79,5 x 95,5	1422	2	19,5:1		51	68	71, 284, 304
BNU	B	(LA)	4	81 x 86,4	1781	5	9,5:1		132	179	223
BNV	D	(LA)	3	79,5 x 95,5	1422	2	19,5:1		58	80	284
BRJ	B		6	84 x 95,9	3189	4	10,8:1		162	220	353
BRM	D	(LA)	4	79,5 x 95,5	1896	2	19:1		74	101	8, 176
BRR	D	(LA)	4	79,5 x 95,5	1896	2	19,5:1		62	84	34, 375
BRS	D	(LA)	4	79,5 x 95,5	1896	2	19:1		75	102	34, 375
BRU	D	(LA)	4	79,5 x 95,5	1896	2	19:1		66	90	145, 356
BSE	B		4	81 x 77,4	1595	2	10,3:1		75	102	19, 28, 142, 152, 165, 218, 237, 354
BSF	B		4	81 x 77,4	1595	2	10,3:1		75	102	19, 28, 142, 152, 165, 218, 237, 354
BST	D	(AN)	4	81 x 95,5	1968	2	19:1		51	70	26
BSU	D	(LA)	4	79,5 x 95,5	1896	2	19,5:1		55	70	24
BSW	D	(LA)	4	79,5 x 95,5	1896	2	18,5:1		77	105	224
BSX	G		4	82,5 x 92,8	1984	4	10,3:1		80	109	27, 30, 220, 358
BTB	D	(LA)	4	79,5 x 95,5	1896	2	19:1		110	150	344
BTS	B		4	76,5 x 86,9	1598	4	11,5:1		77	105	286, 305
BUB	B		6	84 x 95,9	3189	4	11,3:1		184	250	66, 149
BUD	B		4	76,5 x 75,6	1390	4	10,5:1		59	80	16, 141, 150, 282, 303
BVE	D	(LA)	4	81 x 95,5	1968	4	18:1		90	122	256
BVK	D	(LA)	4	79,5 x 95,5	1896	2	18:1		85	115	344
BVY	B		4	82,5 x 92,8	1984	4	11,5:1		110	150	65, 146, 154, 179, 254, 357
BVZ	B		4	82,5 x 92,8	1984	4	11,5:1		110	150	65, 146, 154, 179, 254, 357
BWB	D	(LA)	3	79,5 x 95,5	1422	2	19,5:1		51	70	284, 304
BXE	D	(LA)	4	79,5 x 95,5	1896	2	19:1		77	105	8, 145, 153, 176, 250, 356, 388
BXF	D	(LA)	4	79,5 x 95,5	1896	2	19,5:1		66	90	145, 153, 356
BXJ	D	(LA)	4	79,5 x 95,5	1896	2	19,5:1		66	90	145, 153, 356
CBPA	B		4	82,5 x 92,8	1984	2			85	115	225
CK	D	(AN)	4	76,5 x 80	1471	2	23,5:1		37	50	56, 96, 235, 313
CP	D	(AN)	6	76,5 x 86,4	2383	2	23,5:1		55	75	184, 189, 191, 193, 198, 201, 206
CR	D	(AN)	4	76,5 x 86,4	1588	2	23,5:1		40	54	99, 169, 239, 315, 321
CS	D	(AN)	4	76,5 x 86,4	1588	2	23,5:1		37	50	42, 308, 315, 365, 380

V

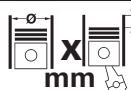





			Cyl	 X mm	cm ³		Comp. Ratio ε	kW	PS	Pos
CCSA	B		4	76,5 x 86,9	1598	2	10,5:1	75	102	144, 152, 166
CT	B		4	85,5 x 69	1584	2	7,5:1	37	50	41, 360
CY	D	(A)	4	76,5 x 86,4	1588	2	23:1	51	70	100, 170, 240, 316, 322
CZ	B		4	85,5 x 69	1584	2	7,5:1	35	47	360
DF	B		4	94 x 69	1915	2		44	60	44, 362
DG	B		4	94 x 69	1915	2		57	78	44, 362
DH	B		4	94 x 69	1915	2	8,6:1	60	82	44, 362, 381
DJ	B		4	94 x 76	2095	2	10,5:1	82	112	46, 364
DS	B		4	81 x 86,4	1781	2	9:1	66	90	241, 323
DT	B		4	81 x 77,4	1595	2	9:1	55	75	236, 320
DTA	B		4	81 x 77,4	1595	2	9:1	51	70	236
DV	D	(A)	6	76,5 x 86,4	2383	2	23:1	75	102	186, 190, 195, 199, 202, 207, 209
DW	D	(AN)	6	76,5 x 86,4	2383	2	23,5:1	55	75	47, 184, 189, 193, 198, 201, 206
DX	B		4	81 x 86,4	1781	2	10:1	82	112	102, 111, 173, 341
DZ	B		4	81 x 86,4	1781	2	10:1	82	112	242
EE	B		4	79,5 x 80	1588	2	8,2:1	60	82	314, 338
EF	B		4	79,5 x 80	1588	2		60	82	338
EG	B		4	79,5 x 80	1588	2	9,5:1	81	110	98, 165, 339
EH	B		4	79,5 x 73,4	1457	2	8,2:1	57	77	95, 312, 336
EJ	B		4	79,5 x 80	1588	2	8,2:1	61	83	97, 164, 266, 314, 338
EM	B		4	79,5 x 80	1588	2	8,2:1	55	75	18, 97, 164, 338
EN	B		4	79,5 x 86,4	1716	2	8,2:1	57-59	77-80	101, 171, 317, 340
EP	B		4	75 x 73,4	1297	2	9:1	44	60	233, 319
EU	B		4	75 x 72	1272	2	8,2:1	44	60	233
EV	B		4	81 x 86,4	1781	2	10:1	82	112	111, 173
EW	B		4	81 x 77,4	1595	2	9:1	55	75	19, 107, 339
EX	B		4	81 x 86,4	1781	2	9:1	66	90	111, 341
EZ	B		4	81 x 77,4	1595	2	9:1	55	75	79, 107, 165, 237
EZA	B		4	81 x 77,4	1595	2	9:1	51	70	107, 165
FA	B		4	69,5 x 72	1093	2	8:1	37	50	93, 334
FB	B		4	76,5 x 80	1471	2	9,7:1	55	75	337
FD	B		4	76,5 x 80	1471	2	9,7:1	63	85	336
FF	B		4	76,5 x 80	1471	2	7,5:1	48	65	234
FH	B		4	76,5 x 80	1471	2	8,2:1	51	70	95, 234, 312, 336
FJ	B		4	69,5 x 72	1093	2	9,7:1	38	52	93, 334
FK	B		4	76,5 x 80	1471	2	8,2:1	51	70	95, 336
FL	B		4	76,5 x 80	1471	2	7,5:1	48	65	234
FN	B		4	79,5 x 80	1588	2	8:1	55	75	98, 314, 338, 339
FP	B		4	79,5 x 80	1588	2	8:1	55	75	97, 98, 339
FR	B		4	79,5 x 80	1588	2	8,2:1	63	85	164, 338
FS	B		4	79,5 x 80	1588	2	8,2:1	53	72	237
FT	B		4	79,5 x 80	1588	2	8:1	51	70	98, 339
FV	B		4	79,5 x 80	1588	2	8:1	51	70	98, 339
FX	B		4	79,5 x 73,4	1457	2	8:1	46	62	312, 337
FY	B		4	75 x 72	1272	2	8,2:1	40	54	233, 319
FZ	B		4	75 x 72	1272	2	8,2:1	44	60	233, 319
GF	B		4	75 x 72	1272	2	8,2:1	44	60	94, 160, 307, 335
GG	B		4	69,5 x 72	1093	2	9,7:1	37	50	93, 159
GH	B		4	79,5 x 73,4	1457	2	8,2:1	48	65	95, 163, 336
GK	B		4	75 x 72	1272	2	11:1	55	75	62, 277
GL	B		4	75 x 59	1043	2	9,5:1	29	40	59, 270
GS	B		4	75 x 72	1272	2	8,2:1	43	58	94, 160
GT	B		4	75 x 72	1272	2	8,2:1	43	58	104, 160, 276
GU	B		4	81 x 86,4	1781	2	10:1	66	90	82, 110, 172
GW	B		4	94 x 69	1915	2	8,6:1	66	90	45, 363
GX	B		4	81 x 86,4	1781	2	10:1	66	90	110, 172
GZ	B		4	81 x 86,4	1781	2	10:1	82	112	111, 173
HA	B		4	69,5 x 59	895	2	8:1	29	40	58, 269
HB	B		4	69,5 x 72	1093	2	8,2:1	37	50	60, 273
HC	B		4	69,5 x 72	1093	2	9,5:1	44	60	60, 273
HE	B		4	64,5 x 59	771	2	8:1	25	34	268
HH	B		4	75 x 72	1272	2	8,2:1	44	60	61, 70, 276
HJ	B		4	75 x 72	1272	2	8,2:1	43	58	61, 276
HK	B		4	75 x 72	1272	2	9,5:1	40	54	61, 104, 160, 276, 335
HM	B		4	81 x 77,4	1595	2	9:1	60	82	107, 164
HN	B		4	81 x 77,4	1595	2	9:1	55	75	18, 107, 338
HP	B		5	81 x 77,4	1994	2	10:1	85	115	251, 326



			Cyl		mm	cm ³	Comp. Ratio	€	kW	PS	Pos
HT	B		4	81 x 86,4	1781	2	10:1	77	105		111
HV	B		4	81 x 86,4	1781	2	9:1	66	90		111, 173
HW	B		4	75 x 72	1272	2	9,5:1	37	50		61, 276
HY	B		5	81 x 86,4	2226	2	9,3:1	100	136		258
HZ	B		4	75 x 59	1043	2	9,5:1	37	50		75, 103, 158, 271
JB	B		4	79,5 x 73,4	1457	2	8,2:1	51	70		17, 95, 163, 336
JH	B		4	81 x 86,4	1781	2	10:1	70	95		22, 111, 173, 318, 341
JJ	B		4	81 x 86,4	1781	2	10:1	82	112		102, 173, 341
JK	D	(AN)	4	76,5 x 86,4	1588	2	23,5:1	40	54		20, 99, 169, 239, 267, 315, 321, 329, 380
JN	B		4	81 x 86,4	1781	2	10:1	66	90		74, 241, 309, 323
JP	D	(AN)	4	76,5 x 86,4	1588	2	23,5:1	40	54		80, 108, 169
JR	D	(A)	4	76,5 x 86,4	1588	2	23:1	51	70		81, 109, 170
JS	B		5	81 x 77,4	1994	2	10:1	85	115		251, 326
JT	B		5	81 x 86,4	2226	2	8,5:1	89	121		258, 311
JU	B		4	81 x 77,4	1595	2	9:1	55	75		236, 320
JV	B		4	81 x 86,4	1781	2	9:1	66	90		241, 323
JX	D	(A)	4	76,5 x 86,4	1588	2	23,5:1	51	70		43, 366
KR	B		4	81 x 86,4	1781	4	10:1	100	136		49, 84, 112, 174, 243, 342
KT	B		4	81 x 86,4	1781	2	10:1	82	112		111, 341
KV	B		5	81 x 86,4	2226	2	10:1	98	133		258
KX	B		5	81 x 86,4	2226	2	8,5:1	88	120		258, 311, 324
KY	D	(AN)	4	79,5 x 86,4	1716	2	23:1	42	57		361
ME	D	(AN)	4	76,5 x 86,4	1588	2	23,5:1	40	54		20, 80, 108, 169
MF	D	(A)	4	76,5 x 86,4	1588	2	23:1	51	70		81, 109, 170
MH	B		4	75 x 72	1272	2	9,2:1	40	55		104, 160, 276
MN	D	(AN)	4	75 x 72	1272	2	22:1	33	45		279
MV	B		4	94 x 76	2095	2	8,7:1	70	95		46, 364, 382
NU	B		4	75 x 72	1272	2	9,2:1	37	50		104, 160, 276
NZ	B		4	75 x 72	1272	2	9,2:1	40	55		76, 105, 161, 277
PB	B		4	81 x 86,4	1781	2	10:1	82	112		83, 111, 173, 242
PD	B		4	81 x 86,4	1781	2	9:1	49	67		31, 367
PF	B		4	81 x 86,4	1781	2	10:1	79	107		83, 111, 173, 242
PG	B	(A)	4	81 x 86,4	1781	2	8:1	110-118	150-160		50, 113, 246
PL	B		4	81 x 86,4	1781	4	10:1	95	129		84, 112, 174, 342
PN	B		4	81 x 77,4	1595	2	9:1	51	70		79, 107, 165
PP	B		4	81 x 77,4	1595	2	9:1	51	70		236
PY	B		4	75 x 72	1272	2	8:1	83	113		278
RA	D	(LA)	4	76,5 x 86,4	1588	2	23:1	59	80		81, 109, 170, 240
RD	B		4	81 x 86,4	1781	2	10:1	79	107		111, 173
RE	B		4	81 x 77,4	1595	2	9:1	53	72		338
RF	B		4	81 x 77,4	1595	2	9:1	53	72		78, 106, 164, 236
RG	B		4	81 x 86,4	1781	2	10:1	79	107		111, 173
RH	B		4	81 x 86,4	1781	2	10:1	62	84		82, 110, 172
RL	B		4	81 x 77,4	1595	2	9:1	53	72		237
RM	B		4	81 x 86,4	1781	2	10:1	64	87		241
RP	B		4	81 x 86,4	1781	2	10:1	66	90		83, 111, 173, 242
RV	B		4	81 x 86,4	1781	2	10:1	77	105		83, 111, 173
SB	D	(LA)	4	76,5 x 86,4	1588	2	23:1	59	80		81, 109, 170, 240
SP	B		4	94 x 69	1915	2	8,7:1	54	74		44, 362
SR	B		4	94 x 76	2095	2	8,7:1	64	87		46, 364
SS	B		4	94 x 76	2095	2	8,7:1	68	92		46, 364
UDH	B		4	81 x 86,4	1781	2					83
UNF	B		4	81 x 77,4	1595	2					79
UPD	B		4	81 x 77,4	1595	2					79
UQG	B		4	82,5 x 92,8	1984	2	10:1	82	111		90
WE	B		5	79,5 x 86,4	2144	2	8,2:1	79-85	107-115		257, 311, 327
WL	B		4	79,5 x 86,4	1716	2	8,2:1	55	75		157
WN	B		5	79,5 x 77,4	1921	2	10:1	85	115		247, 310, 325
WP	B		4	79,5 x 80	1588	2	8:1	51	70		236
WV	B		4	79,5 x 80	1588	2	8,2:1	55	75		236, 320
WVA	B		4	79,5 x 80	1588	2	8:1	51	70		236, 320
WY	B		4	79,5 x 80	1588	2	8,2:1	55	75		236, 320
WZ	B		4	79,5 x 80	1588	2	8,2:1	55	75		236
YG	B		4	79,5 x 80	1588	2	8,2:1	61	83		57, 73, 236
YH	B		4	79,5 x 80	1588	2	8,2:1	61	83		57, 73, 236
YJ	B		4	76,5 x 80	1471	2	9,7:1	55	75		234
YN	B		4	79,5 x 80	1588	2	8,2:1	55	75		236
YP	B		4	79,5 x 80	1588	2	8,2:1	63	85		236, 320



			Cyl	 mm	cm ³		Comp. Ratio ε	kW	PS	Pos
YS	B		4	79,5 x 80	1588	2	9,5:1	81	110	237
YV	B		4	79,5 x 80	1588	2	8,2:1	63	85	57, 314
YX	B		4	79,5 x 86,4	1716	2	8,2:1	55	75	157
YY	B		4	79,5 x 80	1588	2	8:1	51	70	236
ZA	B		4	75 x 73,4	1297	2	8,5:1	40	55	233
ZB	B		4	76,5 x 80	1471	2	9,7:1	55	75	234
ZC	B		4	76,5 x 80	1471	2	9,7:1	63	85	234
ZF	B		4	75 x 73,4	1297	2	8,5:1	44	60	233





Bora 1.4i 16V					1	
10.1998→05.2005	AHW, AKQ, APE, AXP, BCA					50 005 154
Reference	036 121 005 B 036 121 005 S	036 121 005 E 036 121 008K	036 121 005 Q 036 121 008L	036 121 005 QX 036 121 008LX		
10.1998→05.2005	AHW, AKQ, APE, AXP					50 005 844
Reference	036 115 105 B 036 115 105 D	036 115 105 B 036 115 105 D	036 115 105 B 036 115 105 D	036 115 105 B 036 115 105 D		
Bora 1.6i					2	
09.1998→05.2005	AEH, AKL, APF, AVU, BFQ					50 005 819
Reference	06A 115 105 06A 115 105 B 06A 115 105 C 06A 115 105 D	06A 115 105 06A 115 105 B 06A 115 105 C 06A 115 105 D	06A 115 105 06A 115 105 B 06A 115 105 C 06A 115 105 D	06A 115 105 06A 115 105 B 06A 115 105 C 06A 115 105 D		
09.1998→05.2005	AEH, AKL, APF, AVU					50 005 130
Reference						
Bora 1.6i 16V					3	
11.1999→05.2005	ATN, AUS, AZD, BCB					50 005 754
Reference	036 121 005 F	036 121 005 P	036 121 008 G	036 121 008 GX		
11.1999→05.2005	ATN, AUS, AZD, BCB					50 005 844
Reference	036 115 105 B 036 115 105 D	036 115 105 B 036 115 105 D	036 115 105 B 036 115 105 D	036 115 105 B 036 115 105 D		
Bora 1.6 FSI 16V					4	
08.2001→05.2005	BAD					50 005 754
Reference	036 121 005 F	036 121 005 P	036 121 008 G	036 121 008 GX		
Bora 1.8i 20V					5	
02.1999→10.2000	AGN					50 005 819
Reference	06A 115 105 06A 115 105 B 06A 115 105 C 06A 115 105 D	06A 115 105 06A 115 105 B 06A 115 105 C 06A 115 105 D	06A 115 105 06A 115 105 B 06A 115 105 C 06A 115 105 D	06A 115 105 06A 115 105 B 06A 115 105 C 06A 115 105 D		
02.1999→10.2000	AGN					50 005 131
Reference						





Bora 1.8i Turbo 20V

6

05.2000→05.2005	AGU, AUM, AUQ					50 005 819	
Reference	06A 115 105	06A 115 105	06A 115 105	06A 115 105			
	06A 115 105 B	06A 115 105 B	06A 115 105 B	06A 115 105 B			
	06A 115 105 C	06A 115 105 C	06A 115 105 C	06A 115 105 C			
	06A 115 105 D	06A 115 105 D	06A 115 105 D	06A 115 105 D			
05.2000→05.2005	AGU, AUM, AUQ						50 005 131





Bora 1.9 SDI

7

11.1998→05.2005	AGP, AQM						50 005 132
Reference	038 121 011	038 121 011 A	038 121 011 AV	038 121 011AX			
11.1998→05.2005	AQM					50 005 819	
Reference	06A 115 105	06A 115 105	06A 115 105	06A 115 105			
	06A 115 105 B	06A 115 105 B	06A 115 105 B	06A 115 105 B			
	06A 115 105 C	06A 115 105 C	06A 115 105 C	06A 115 105 C			
	06A 115 105 D	06A 115 105 D	06A 115 105 D	06A 115 105 D			

Bora 1.9 TDI

8

09.1998→05.2005	AGR, AHF, ALH, ASV						50 005 132
Reference	038 121 011	038 121 011 A	038 121 011 AV	038 121 011AX			
→	BKC, BRM, BXE						50 005 556
Reference	045 121 011B	045 121 011F	045 121 011H	045 121 011HX			
07.2003→	BEW						50 005 783
Reference	038 121 011 G						
09.1998→	AGR, AHF, AJM, ALH, ASV, ATD, AUY, AXR					50 005 819	
Reference	06A 115 105	06A 115 105	06A 115 105	06A 115 105			
	06A 115 105 B	06A 115 105 B	06A 115 105 B	06A 115 105 B			
	06A 115 105 C	06A 115 105 C	06A 115 105 C	06A 115 105 C			
	06A 115 105 D	06A 115 105 D	06A 115 105 D	06A 115 105 D			
11.1998→	AJM, ARL, ASZ, ATD, AUY, AXR						50 005 554
Reference	038 121 001 C	038 121 011 C	038 121 011 D	038 121 011G			
	038 121 011J	038 121 011K	038 121 011KX				

Bora 2.0i

9

→	APK, AQY, AZG, AZH					50 005 819	
Reference	06A 115 105	06A 115 105	06A 115 105	06A 115 105			
	06A 115 105 B	06A 115 105 B	06A 115 105 B	06A 115 105 B			
	06A 115 105 C	06A 115 105 C	06A 115 105 C	06A 115 105 C			
	06A 115 105 D	06A 115 105 D	06A 115 105 D	06A 115 105 D			





→	APK, AQY, AZG, AZH, AZJ			50 005 131
Bora 2.0 TDI 16V 10				
→	BKD			50 005 554
Reference	038 121 001 C 038 121 011 C 038 121 011 D 038 121 011G 038 121 011J 038 121 011K 038 121 011KX			
Bora 2.3i 20V 11				
09.1998→02.2001	AGZ			50 005 159
Reference	066 121 011 C 071 121 005			
Bora 2.3i 25V 12				
09.2000→05.2005	AQN			50 005 159
Reference	066 121 011 C 071 121 005			
Bora 2.8i VR6 24V 13				
05.1999→04.2001	AQP, AUE			50 005 165
Reference	021 121 004 021 121 004 A			
05.2001→05.2003	BDE			50 005 008 <small>NEW</small>
Reference	022 121 011			
Caddy 1.4i 14				
09.2000→06.2003	AUD			50 005 137
Reference	030 121 005 S 030 121 008 A 030 121 008 C 030 121 008 CX 037 121 008 C			
11.1995→06.2003	AEX, AKV, APQ			50 005 139
Reference	030 121 005 N 030 121 005 NV 030 121 005 NX 030 121 008 D 030 121 008 DX			
11.1995→06.2003	AEX, AKV, APQ		50 005 844	
Reference	036 115 105 B 036 115 105 B 036 115 105 B 036 115 105 B 036 115 105 D 036 115 105 D 036 115 105 D 036 115 105 D			





Caddy 1.4i 16V

15

09.2000→05.2006	AUA, BCA						
Reference	036 121 005 B 036 121 005 S	036 121 005 E 036 121 008K	036 121 005 Q 036 121 008L	036 121 005 QX 036 121 008LX			50 005 154
09.2000→05.2006	AUA, BCA						
Reference	036 115 105 B 036 115 105 D	036 115 105 B 036 115 105 D	036 115 105 B 036 115 105 D	036 115 105 B 036 115 105 D		50 005 844	





Caddy 1.4 FSI 16V

16

05.2006→	BUD						
Reference	036 121 005 B 036 121 005 S	036 121 005 E 036 121 008K	036 121 005 Q 036 121 008L	036 121 005 QX 036 121 008LX			50 005 154
05.2006→	BUD						
Reference	036 115 105 B 036 115 105 D	036 115 105 B 036 115 105 D	036 115 105 B 036 115 105 D	036 115 105 B 036 115 105 D		50 005 844	

Caddy 1.5

17

10.1982→10.1983	JB						
Reference	026 121 010 026 121 010 F 026 121 010 X 068 121 010 A	026 121 010 C 026 121 010 FV 037 121 010 068 121 010 AX	026 121 010 CV 026 121 010 FX 037 121 010 A	026 121 010 CX 026 121 010 V 037 121 010 AX			50 005 151
	mit Gegengehäuse/with backhousing/avec demi-corps/con remate/c задним корпусом ch ...C-630 001→						
10.1982→10.1983	JB						
Reference	056 121 005 068 121 005 C	056 121 005 A 068 121 005 X	068 121 005	068 121 005 B			50 005 140
	ohne Gegengehäuse/without backhousing/sans demi-corps/sin remate/без заднего корпуса →ch C-630 000						
10.1982→10.1983	JB						
Reference	027 115 105 049 115 105 A	027 115 105 049 115 105 A	027 115 105 E 055 115 105 D	027 115 105 E 055 115 105 D		50 005 808	
10.1982→10.1983	JB						
Reference	026 121 005 A 026 121 005 H	026 121 005 C 037 121 005 B	026 121 005 E 037 121 005 C	026 121 005 G 068 121 005 A			50 005 148
	ohne Gegengehäuse/without backhousing/sans demi-corps/sin remate/без заднего корпуса ch ...C-630 001→						
10.1982→10.1983	JB						
Reference	026 121 010 A 026 121 010 DX 056 121 013 A	026 121 010 AV 055 121 010 068 121 010	026 121 010 D 055 121 010 X	026 121 010 DV 056 121 011			50 005 150
	mit Gegengehäuse/with backhousing/avec demi-corps/con remate/c задним корпусом →ch. C-630 000						

V

**Caddy 1.6****18**

10.1982→05.1997	1F, EM, HN					
Reference	026 121 010 026 121 010 F 026 121 010 X 068 121 010 A	026 121 010 C 026 121 010 FV 037 121 010 068 121 010 AX	026 121 010 CV 026 121 010 FX 037 121 010 A	026 121 010 CX 026 121 010 V 037 121 010 AX		50 005 151
	mit Gegengehäuse/with backhousing/avec demi-corps/con remate/с задним корпусом					
04.2004→05.2005	BGU					50 005 775
Reference	06B 121 011 H	06B 121 011 L	06B 121 011 LX	06B 121 011 M		
08.1983→07.1989	HN					50 005 808
Reference	027 115 105 049 115 105 A	027 115 105 049 115 105 A	027 115 105 E 055 115 105 D	027 115 105 E 055 115 105 D		
10.1982→05.1997	1F, EM, HN					50 005 148
Reference	026 121 005 A 026 121 005 H	026 121 005 C 037 121 005 B	026 121 005 E 037 121 005 C	026 121 005 G 068 121 005 A		
	ohne Gegengehäuse/without backhousing/sans demi-corps/sin remate/без заднего корпуса					
04.2004→05.2005	BGU					50 005 819
Reference	06A 115 105 06A 115 105 B 06A 115 105 C 06A 115 105 D	06A 115 105 06A 115 105 B 06A 115 105 C 06A 115 105 D	06A 115 105 06A 115 105 B 06A 115 105 C 06A 115 105 D	06A 115 105 06A 115 105 B 06A 115 105 C 06A 115 105 D		

Caddy 1.6i**19**

08.1983→05.1997	1F, EW					
Reference	026 121 010 026 121 010 F 026 121 010 X 068 121 010 A	026 121 010 C 026 121 010 FV 037 121 010 068 121 010 AX	026 121 010 CV 026 121 010 FX 037 121 010 A	026 121 010 CX 026 121 010 V 037 121 010 AX		50 005 151
	mit Gegengehäuse/with backhousing/avec demi-corps/con remate/с задним корпусом					
06.2005→	BSE, BSF					50 005 775
Reference	06B 121 011 H	06B 121 011 L	06B 121 011 LX	06B 121 011 M		
08.1983→05.1997	1F, EW					50 005 808
Reference	027 115 105 049 115 105 A	027 115 105 049 115 105 A	027 115 105 E 055 115 105 D	027 115 105 E 055 115 105 D		
08.1983→05.1997	1F, EW					50 005 148
Reference	026 121 005 A 026 121 005 H	026 121 005 C 037 121 005 B	026 121 005 E 037 121 005 C	026 121 005 G 068 121 005 A		
	ohne Gegengehäuse/without backhousing/sans demi-corps/sin remate/без заднего корпуса					
06.2005→	BSE, BSF					50 005 819
Reference	06A 115 105 06A 115 105 B 06A 115 105 C 06A 115 105 D	06A 115 105 06A 115 105 B 06A 115 105 C 06A 115 105 D	06A 115 105 06A 115 105 B 06A 115 105 C 06A 115 105 D	06A 115 105 06A 115 105 B 06A 115 105 C 06A 115 105 D		

V



06.1996→12.2000 Reference	AEE 030 121 005 N 030 121 008 DX	030 121 005 NV	030 121 005 NX	030 121 008 D		50 005 139
06.1996→12.2000 Reference	AEE 036 115 105 B 036 115 105 D	036 115 105 B 036 115 105 D	036 115 105 B 036 115 105 D	036 115 105 B 036 115 105 D		50 005 844
Caddy 1.6 D						20
10.1982→07.1992 Reference	JK, ME 026 121 010 026 121 010 F 026 121 010 X 068 121 010 A mit Gegengehäuse/with backhousing/avec demi-corps/con remate/c задним корпусом	026 121 010 C 026 121 010 FV 037 121 010 068 121 010 AX	026 121 010 CV 026 121 010 FX 037 121 010 A	026 121 010 CX 026 121 010 V 037 121 010 AX		50 005 151
10.1982→07.1992 Reference	JK, ME 068 115 105 AE 068 115 105 P	068 115 105 AN 068 115 105 S	068 115 105 D	068 115 105 H		50 005 809
10.1982→07.1992 Reference	JK, ME 026 121 005 A 026 121 005 H ohne Gegengehäuse/without backhousing/sans demi-corps/sin remate/без заднего корпуса	026 121 005 C 037 121 005 B	026 121 005 E 037 121 005 C	026 121 005 G 068 121 005 A		50 005 148
Caddy 1.7 SDI						21
07.1996→09.2000 Reference	AHB 026 121 010 026 121 010 F 026 121 010 X 068 121 010 A mit Gegengehäuse/with backhousing/avec demi-corps/con remate/c задним корпусом	026 121 010 C 026 121 010 FV 037 121 010 068 121 010 AX	026 121 010 CV 026 121 010 FX 037 121 010 A	026 121 010 CX 026 121 010 V 037 121 010 AX		50 005 151
07.1996→09.2000 Reference	AHB 026 121 005 A 026 121 005 H ohne Gegengehäuse/without backhousing/sans demi-corps/sin remate/без заднего корпуса	026 121 005 C 037 121 005 B	026 121 005 E 037 121 005 C	026 121 005 G 068 121 005 A		50 005 148
07.1996→09.2000 Reference	AHB 028 115 105 G	028 115 105 G	068 115 105 BK	068 115 105 BK		50 005 806
Caddy 1.8i						22
08.1985→07.1992 Reference	JH 026 121 010 026 121 010 F 026 121 010 X 068 121 010 A mit Gegengehäuse/with backhousing/avec demi-corps/con remate/c задним корпусом	026 121 010 C 026 121 010 FV 037 121 010 068 121 010 AX	026 121 010 CV 026 121 010 FX 037 121 010 A	026 121 010 CX 026 121 010 V 037 121 010 AX		50 005 151

V



08.1985→07.1992	JH			
Reference	027 115 105 049 115 105 A	027 115 105 049 115 105 A	027 115 105 E 055 115 105 D	027 115 105 E 055 115 105 D
				50 005 808
→	ADD, JH			
Reference	026 121 005 A 026 121 005 H	026 121 005 C 037 121 005 B	026 121 005 E 037 121 005 C	026 121 005 G 068 121 005 A
	ohne Gegengehäuse/without backhousing/sans demi-corps/sin remate/без заднего корпуса			50 005 148
Caddy 1.9 D				23
11.1995→09.2005	1Y			
Reference	026 121 010 026 121 010 F 026 121 010 X 068 121 010 A	026 121 010 C 026 121 010 FV 037 121 010 068 121 010 AX	026 121 010 CV 026 121 010 FX 037 121 010 A	026 121 010 CX 026 121 010 V 037 121 010 AX
	mit Gegengehäuse/with backhousing/avec demi-corps/con remate/с задним корпусом			50 005 151
06.1996→12.2000	AEF			
Reference	028 121 004	028 121 004 V	028 121 004 X	
				50 005 158
11.1995→09.2005	1Y			
Reference	026 121 005 A 026 121 005 H	026 121 005 C 037 121 005 B	026 121 005 E 037 121 005 C	026 121 005 G 068 121 005 A
	ohne Gegengehäuse/without backhousing/sans demi-corps/sin remate/без заднего корпуса			50 005 148
11.1995→09.2005	1Y			
Reference	028 115 105 G	028 115 105 G	068 115 105 BK	068 115 105 BK
				50 005 806
06.1996→12.2000	AEF			
Reference	028 115 105 L			
				50 005 807
Caddy 1.9 TDI				24
10.1996→09.2000	1Z, AHU, ALE			
Reference	026 121 010 026 121 010 F 026 121 010 X 068 121 010 A	026 121 010 C 026 121 010 FV 037 121 010 068 121 010 AX	026 121 010 CV 026 121 010 FX 037 121 010 A	026 121 010 CX 026 121 010 V 037 121 010 AX
	mit Gegengehäuse/with backhousing/avec demi-corps/con remate/с задним корпусом			50 005 151
09.2000→06.2003	ALH			
Reference	038 121 011	038 121 011 A	038 121 011 AV	038 121 011 AX
				50 005 132
10.1996→09.2000	1Z, AHU, ALE			
Reference	026 121 005 A 026 121 005 H	026 121 005 C 037 121 005 B	026 121 005 E 037 121 005 C	026 121 005 G 068 121 005 A
	ohne Gegengehäuse/without backhousing/sans demi-corps/sin remate/без заднего корпуса			50 005 148





02.2004→ Reference	BJB, BLS, BSU 045 121 011B 045 121 011F 045 121 011H 045 121 011HX						50 005 556
10.1996→09.2000 Reference	1Z, AHU, ALE 028 115 105 G 028 115 105 G 068 115 105 BK 068 115 105 BK						50 005 806
09.2000→06.2003 Reference	ALH 06A 115 105 06A 115 105 06A 115 105 06A 115 105 06A 115 105 B 06A 115 105 B 06A 115 105 B 06A 115 105 B 06A 115 105 C 06A 115 105 C 06A 115 105 C 06A 115 105 C 06A 115 105 D 06A 115 105 D 06A 115 105 D 06A 115 105 D						50 005 819
Caddy 1.9 SDI							25
11.1995→09.2000 Reference	AEY 026 121 010 026 121 010 C 026 121 010 CV 026 121 010 CX 026 121 010 F 026 121 010 FV 026 121 010 FX 026 121 010 V 026 121 010 X 037 121 010 037 121 010 A 037 121 010 AX 068 121 010 A 068 121 010 AX mit Gegengehäuse/with backhousing/avec demi-corps/con remate/c задним корпусом 09.1996→						50 005 151
09.2000→06.2003 Reference	AYQ 038 121 011 038 121 011 A 038 121 011 AV 038 121 011AX						50 005 132
11.1995→09.2000 Reference	AEY 026 121 005 A 026 121 005 C 026 121 005 E 026 121 005 G 026 121 005 H 037 121 005 B 037 121 005 C 068 121 005 A ohne Gegengehäuse/without backhousing/sans demi-corps/sin remate/без заднего корпуса						50 005 148
11.1995→09.2000 Reference	AEY 028 115 105 G 028 115 105 G 068 115 105 BK 068 115 105 BK						50 005 806
09.2000→06.2003 Reference	AYQ 06A 115 105 06A 115 105 06A 115 105 06A 115 105 06A 115 105 B 06A 115 105 B 06A 115 105 B 06A 115 105 B 06A 115 105 C 06A 115 105 C 06A 115 105 C 06A 115 105 C 06A 115 105 D 06A 115 105 D 06A 115 105 D 06A 115 105 D						50 005 819
Caddy 2.0 SDI							26
02.2004→ Reference	BDJ, BST 045 121 011B 045 121 011F 045 121 011H 045 121 011HX						50 005 556
Caddy 2.0i EcoFuel							27
04.2006→ Reference	BSX 06A 115 105 06A 115 105 06A 115 105 06A 115 105 06A 115 105 B 06A 115 105 B 06A 115 105 B 06A 115 105 B 06A 115 105 C 06A 115 105 C 06A 115 105 C 06A 115 105 C 06A 115 105 D 06A 115 105 D 06A 115 105 D 06A 115 105 D						50 005 819







04.2006→	BSX			
				50 005 131
Caddy Maxi 1.6i				28
11.2007→	BSE, BSF			
Reference	06B 121 011 H	06B 121 011 L	06B 121 011 LX	06B 121 011 M
				50 005 775
Caddy Maxi 1.9 TDI				29
11.2007→	BJB, BLS			
Reference	045 121 011 B	045 121 011 F	045 121 011 H	045 121 011 HX
				50 005 556
Caddy Maxi 2.0 EcoFuel				30
04.2006→	BSX			
				50 005 131
California 1.8i				31
09.1990→07.1992	PD			
Reference	026 121 010	026 121 010 C	026 121 010 CV	026 121 010 CX
	026 121 010 F	026 121 010 FV	026 121 010 FX	026 121 010 V
	026 121 010 X	037 121 010	037 121 010 A	037 121 010 AX
	068 121 010 A	068 121 010 AX		
	mit Gegengehäuse/with backhousing/avec demi-corps/con remate/c задним корпусом			
				50 005 151
09.1990→07.1992	PD			
Reference	026 121 005 A	026 121 005 C	026 121 005 E	026 121 005 G
	026 121 005 H	037 121 005 B	037 121 005 C	068 121 005 A
	ohne Gegengehäuse/without backhousing/sans demi-corps/sin remate/без заднего корпуса			
				50 005 148
California 1.9 D				32
09.1990→07.1995	1X			
Reference	026 121 010	026 121 010 C	026 121 010 CV	026 121 010 CX
	026 121 010 F	026 121 010 FV	026 121 010 FX	026 121 010 V
	026 121 010 X	037 121 010	037 121 010 A	037 121 010 AX
	068 121 010 A	068 121 010 AX		
	mit Gegengehäuse/with backhousing/avec demi-corps/con remate/c задним корпусом			
				50 005 151
09.1990→07.1995	1X			
Reference	028 115 105 D			
				50 005 800
09.1990→07.1995	1X			
Reference	026 121 005 A	026 121 005 C	026 121 005 E	026 121 005 G
	026 121 005 H	037 121 005 B	037 121 005 C	068 121 005 A
	ohne Gegengehäuse/without backhousing/sans demi-corps/sin remate/без заднего корпуса			
				50 005 148



**California 1.9 TD****33**

08.1992→04.2002	ABL						
Reference	026 121 010 026 121 010 F 026 121 010 X 068 121 010 A	026 121 010 C 026 121 010 FV 037 121 010 068 121 010 AX	026 121 010 CV 026 121 010 FX 037 121 010 A	026 121 010 CX 026 121 010 V 037 121 010 AX			50 005 151
	mit Gegengehäuse/with backhousing/avec demi-corps/con remate/c задним корпусом						
08.1992→04.2002	ABL						
Reference	028 115 105 D					50 005 800	
08.1992→04.2002	ABL						
Reference	026 121 005 A 026 121 005 H	026 121 005 C 037 121 005 B	026 121 005 E 037 121 005 C	026 121 005 G 068 121 005 A			50 005 148
	ohne Gegengehäuse/without backhousing/sans demi-corps/sin remate/без заднего корпуса						

California 1.9 TDI**34**

05.2007→	AXB, AXC, BRR, BRS						
Reference	045 121 011B	045 121 011F	045 121 011H	045 121 011HX			50 005 556
05.2007→	AXD						
Reference	070 121 011 A	070 121 011 C	070 121 011 D				50 005 007 NEW

California 2.0i**35**

09.1990→04.2002	AAC						
Reference	026 121 010 026 121 010 F 026 121 010 X 068 121 010 A	026 121 010 C 026 121 010 FV 037 121 010 068 121 010 AX	026 121 010 CV 026 121 010 FX 037 121 010 A	026 121 010 CX 026 121 010 V 037 121 010 AX			50 005 151
	mit Gegengehäuse/with backhousing/avec demi-corps/con remate/c задним корпусом						
09.1990→04.2002	AAC						
Reference	026 121 005 A 026 121 005 H	026 121 005 C 037 121 005 B	026 121 005 E 037 121 005 C	026 121 005 G 068 121 005 A			50 005 148
	ohne Gegengehäuse/without backhousing/sans demi-corps/sin remate/без заднего корпуса						
05.2007→	AXA						
							50 005 131

California 2.4 D**36**

09.1990→09.1998	AAB						
Reference	023 121 004 →320.127	023 121 004 V	023 121 004 X				50 005 163



09.1990→04.2002 Reference	AAB, AJA 074 121 004 B 074 121 005 N 074 121 005 NX 074 121 005M 074 121 005MX 20 Zähne/teeth/dientes/dents/зубьев AAB: 320.128→ AJA: →ch. 70-Y-075 000			50 005 555
09.1990→04.2002 Reference	AAB, AJA 074 121 004 074 121 004 A 074 121 004 V 074 121 004 X 18 Zähne/teeth/dientes/dents/зубьев AAB: 320.128→ AJA: →ch. 70-Y-075 000			50 005 551
California 2.5i				37
09.1990→10.1996 Reference	AAF, ACU 023 121 004 023 121 004 V 023 121 004 X ch→ch. 70-N-014 000			50 005 163
09.1990→09.2003 Reference	AAF, ACU, AET, AEU, APL, AVT, AXL 074 121 004 B 074 121 005 N 074 121 005 NX 074 121 005M 074 121 005MX 20 Zähne/teeth/dientes/dents/зубьев AAF, ACU: ch 70-N-014 001→			50 005 555
09.1990→09.2003 Reference	AAF, ACU, AET, AEU 074 121 004 074 121 004 A 074 121 004 V 074 121 004 X 18 Zähne/teeth/dientes/dents/зубьев AAF, ACU: ch 70-N-014 001→			50 005 551
California 2.5 TDI				38
05.2007→ Reference	AXE 070 121 011 A 070 121 011 C 070 121 011 D			50 005 007 NEW
01.1996→09.2003 Reference	ACV, AHY, AJT, AUF, AYC, AYY 074 121 004 B 074 121 005 N 074 121 005 NX 074 121 005M 074 121 005MX 20 Zähne/teeth/dientes/dents/зубьев AHY, AJT: →ch. 70-Y-075 000			50 005 555
01.1996→09.2003 Reference	ACV, AHY, AJT 074 121 004 074 121 004 A 074 121 004 V 074 121 004 X 18 Zähne/teeth/dientes/dents/зубьев AHY, AJT: →ch. 70-Y-075 000			50 005 551
California 2.8i VR6				39
01.1996→05.2000 Reference	AES 021 121 004 021 121 004 A			50 005 165



01.1981→07.1987 Reference	CS 068 115 105 AQ 068 115 105 AR 068 115 105 BP 068 115 105 J					50 005 802
01.1981→07.1987 Reference	CS 026 121 010 A 026 121 010 AV 026 121 010 D 026 121 010 DV 026 121 010 DX 055 121 010 055 121 010 X 056 121 011 056 121 013 A 068 121 010 mit Gegengehäuse/with backhousing/avec demi-corps/con remate/с задним корпусом →215.895					50 005 150
Campmobil 1.6 TD						43
08.1984→07.1991 Reference	JX 026 121 010 026 121 010 C 026 121 010 CV 026 121 010 CX 026 121 010 F 026 121 010 FV 026 121 010 FX 026 121 010 V 026 121 010 X 037 121 010 037 121 010 A 037 121 010 AX 068 121 010 A 068 121 010 AX mit Gegengehäuse/with backhousing/avec demi-corps/con remate/с задним корпусом 012.053→					50 005 151
08.1984→07.1991 Reference	JX 056 121 005 056 121 005 A 068 121 005 068 121 005 B 068 121 005 C 068 121 005 X ohne Gegengehäuse/without backhousing/sans demi-corps/sin remate/без заднего корпуса →012.052					50 005 140
08.1984→07.1991 Reference	JX 026 121 005 A 026 121 005 C 026 121 005 E 026 121 005 G 026 121 005 H 037 121 005 B 037 121 005 C 068 121 005 A ohne Gegengehäuse/without backhousing/sans demi-corps/sin remate/без заднего корпуса 012.053→					50 005 148
08.1984→07.1991 Reference	JX 026 121 010 A 026 121 010 AV 026 121 010 D 026 121 010 DV 026 121 010 DX 055 121 010 055 121 010 X 056 121 011 056 121 013 A 068 121 010 mit Gegengehäuse/with backhousing/avec demi-corps/con remate/с задним корпусом →ch. 012.052					50 005 150
Campmobil 1.9						44
08.1982→07.1991 Reference	DF, DG, DH 025 121 010 A 025 121 010 AV 025 121 010 AX 025 121 010 D DF, DG: →07.1985					50 005 160
08.1982→07.1991 Reference	DF, DG, DH, SP 111 115 107 A 111 115 107 B 111 115 107 BK					50 005 812
Campmobil 1.9i						45
08.1983→07.1985 Reference	GW 025 121 010 A 025 121 010 AV 025 121 010 AX 025 121 010 D					50 005 160



08.1983→07.1985 Reference	GW 111 115 107 A 111 115 107 B 111 115 107 BK					50 005 812
Campmobil 2.1i						46
08.1985→07.1991 Reference	DJ, MV, SR, SS 025 121 010 B 025 121 010 BV 025 121 010 BX 025 121 010 C 025 121 010 CV 025 121 010 CX 025 121 010 E 025 121 010 F					50 005 162
08.1985→07.1991 Reference	DJ, SR, SS 111 115 107 A 111 115 107 B 111 115 107 BK					50 005 812
Campmobil 2.4						47
08.1983→12.1995 Reference	1G, 1S, DW 069 121 004 069 121 004 V 069 121 004 X 069 121 005 D					50 005 146
08.1992→12.1995 Reference	ACL 074 121 004 B 074 121 005 N 074 121 005 NX 074 121 005M 074 121 005MX 20 Zähne/teeth/dientes/dents/зубьев					50 005 555
Caravelle 2.4 D						48
02.1998→12.2000 Reference	AAB 023 121 004 023 121 004 V 023 121 004 X →320.127					50 005 163
02.1998→12.2000 Reference	AAB 074 121 004 B 074 121 005 N 074 121 005 NX 074 121 005M 074 121 005MX 20 Zähne/teeth/dientes/dents/зубьев 320.128→					50 005 555
02.1998→12.2000 Reference	AAB 074 121 004 074 121 004 A 074 121 004 V 074 121 004 X 18 Zähne/teeth/dientes/dents/зубьев 320.128→					50 005 551
Corrado 1.8i 16V						49
04.1989→07.1992 Reference	KR 026 121 010 026 121 010 C 026 121 010 CV 026 121 010 CX 026 121 010 F 026 121 010 FV 026 121 010 FX 026 121 010 V 026 121 010 X 037 121 010 037 121 010 A 037 121 010 AX 068 121 010 A 068 121 010 AX mit Gegengehäuse/with backhousing/avec demi-corps/con remate/c задним корпусом					50 005 151

V



04.1989→07.1992	KR			
Reference	026 121 005 A 026 121 005 C 026 121 005 E 026 121 005 G 026 121 005 H 037 121 005 B 037 121 005 C 068 121 005 A			50 005 148
	ohne Gegengehäuse/without backhousing/sans demi-corps/sin remate/без заднего корпуса			
04.1989→07.1992	KR			
Reference	027 115 105 A 027 115 105 A 027 115 105 C 027 115 105 C 068 115 105 AG 068 115 105 AG 068 115 105 Q 068 115 105 Q			50 005 803

Corrado 1.8i G60

50

09.1988→07.1993	PG			
Reference	026 121 010 026 121 010 C 026 121 010 CV 026 121 010 CX 026 121 010 F 026 121 010 FV 026 121 010 FX 026 121 010 V 026 121 010 X 037 121 010 037 121 010 A 037 121 010 AX 068 121 010 A 068 121 010 AX			50 005 151
	mit Gegengehäuse/with backhousing/avec demi-corps/con remate/с задним корпусом			
09.1988→07.1993	PG			
Reference	037 115 105			50 005 810
09.1988→07.1993	PG			
Reference	026 121 005 A 026 121 005 C 026 121 005 E 026 121 005 G 026 121 005 H 037 121 005 B 037 121 005 C 068 121 005 A			50 005 148
	ohne Gegengehäuse/without backhousing/sans demi-corps/sin remate/без заднего корпуса			

Corrado 2.0i

51

04.1993→07.1995	2E, ADY			
Reference	026 121 010 026 121 010 C 026 121 010 CV 026 121 010 CX 026 121 010 F 026 121 010 FV 026 121 010 FX 026 121 010 V 026 121 010 X 037 121 010 037 121 010 A 037 121 010 AX 068 121 010 A 068 121 010 AX			50 005 151
	mit Gegengehäuse/with backhousing/avec demi-corps/con remate/с задним корпусом			
04.1993→07.1995	2E, ADY			
Reference	026 121 005 A 026 121 005 C 026 121 005 E 026 121 005 G 026 121 005 H 037 121 005 B 037 121 005 C 068 121 005 A			50 005 148
	ohne Gegengehäuse/without backhousing/sans demi-corps/sin remate/без заднего корпуса			
04.1993→07.1995	2E, ADY			
Reference	027 115 105 B 027 115 105 B			50 005 805

Corrado 2.0i 16V

52

08.1991→07.1995	9A			
Reference	026 121 010 026 121 010 C 026 121 010 CV 026 121 010 CX 026 121 010 F 026 121 010 FV 026 121 010 FX 026 121 010 V 026 121 010 X 037 121 010 037 121 010 A 037 121 010 AX 068 121 010 A 068 121 010 AX			50 005 151
	mit Gegengehäuse/with backhousing/avec demi-corps/con remate/с задним корпусом			

V



08.1991→07.1995 Reference	9A 051 115 105 A 051 115 105 A			50 005 801
08.1991→07.1995 Reference 	9A 026 121 005 A 026 121 005 C 026 121 005 E 026 121 005 G 026 121 005 H 037 121 005 B 037 121 005 C 068 121 005 A ohne Gegengehäuse/without backhousing/sans demi-corps/sin remate/без заднего корпуса			50 005 148
Corrado 2.8i VR6 (USA)				53
08.1991→07.1995 Reference	AAA 021 121 004 021 121 004 A			50 005 165
Corrado 2.9i VR6				54
08.1991→07.1995 Reference	ABV 021 121 004 021 121 004 A			50 005 165
Crafter 2.5 TDI				55
04.2006→ Reference 	BJK, BJL, BJM 074 121 004 B 074 121 005 N 074 121 005 NX 074 121 005 M 074 121 005 MX 20 Zähne/teeth/dientes/dents/зубьев			50 005 555
Dasher 1.5 D (USA)				56
08.1976→07.1981 Reference 	CK 056 121 005 056 121 005 A 068 121 005 068 121 005 B 068 121 005 C 068 121 005 X ohne Gegengehäuse/without backhousing/sans demi-corps/sin remate/без заднего корпуса			50 005 140
08.1976→07.1981 Reference 	CK 026 121 010 A 026 121 010 AV 026 121 010 D 026 121 010 DV 026 121 010 DX 055 121 010 055 121 010 X 056 121 011 056 121 013 A 068 121 010 mit Gegengehäuse/with backhousing/avec demi-corps/con remate/c задним корпусом			50 005 150
Dasher 1.6 (USA)				57
09.1975→1983 Reference 	YV 026 121 010 026 121 010 C 026 121 010 CV 026 121 010 CX 026 121 010 F 026 121 010 FV 026 121 010 FX 026 121 010 V 026 121 010 X 037 121 010 037 121 010 A 037 121 010 AX 068 121 010 A 068 121 010 AX mit Gegengehäuse/with backhousing/avec demi-corps/con remate/c задним корпусом ch 43-B-070 001→			50 005 151
01.1975→1983 Reference 	YG, YH, YV 056 121 005 056 121 005 A 068 121 005 068 121 005 B 068 121 005 C 068 121 005 X ohne Gegengehäuse/without backhousing/sans demi-corps/sin remate/без заднего корпуса YV: →ch 43-B-070 000			50 005 140

V



09.1975→1983	YV			
Reference	026 121 005 A 026 121 005 C 026 121 005 E 026 121 005 G 026 121 005 H 037 121 005 B 037 121 005 C 068 121 005 A			50 005 148
	ohne Gegengehäuse/without backhousing/sans demi-corps/sin remate/без заднего корпуса ch 43-B-070 001→			
01.1975→1983	YG, YH, YV			
Reference	026 121 010 A 026 121 010 AV 026 121 010 D 026 121 010 DV 026 121 010 DX 055 121 010 055 121 010 X 056 121 011 056 121 013 A 068 121 010			50 005 150
	mit Gegengehäuse/with backhousing/avec demi-corps/con remate/с задним корпусом YV: →ch. 43-B-070 000			
Derby 0.9				58
04.1975→09.1981	HA			
Reference	052 121 004 052 121 004 V 052 121 004 X 052 121 005 052 121 005 A 052 121 005 AX 052 121 019			50 005 142
Derby 1.0i				59
10.1981→11.1984	GL			
Reference	052 121 004 052 121 004 V 052 121 004 X 052 121 005 052 121 005 A 052 121 005 AX 052 121 019			50 005 142
Derby 1.1				60
07.1976→07.1983	HB, HC			
Reference	052 121 004 052 121 004 V 052 121 004 X 052 121 005 052 121 005 A 052 121 005 AX 052 121 019			50 005 142
Derby 1.3				61
01.1977→11.1984	HH, HJ, HK, HW			
Reference	052 121 004 052 121 004 V 052 121 004 X 052 121 005 052 121 005 A 052 121 005 AX 052 121 019			50 005 142
Derby 1.3i				62
08.1983→07.1984	GK			
Reference	052 121 004 052 121 004 V 052 121 004 X 052 121 005 052 121 005 A 052 121 005 AX 052 121 019			50 005 142
Derby 1.8i				63
10.1994→12.1994	ABS, ADZ			
Reference	026 121 010 026 121 010 C 026 121 010 CV 026 121 010 CX 026 121 010 F 026 121 010 FV 026 121 010 FX 026 121 010 V 026 121 010 X 037 121 010 037 121 010 A 037 121 010 AX 068 121 010 A 068 121 010 AX			50 005 151
	mit Gegengehäuse/with backhousing/avec demi-corps/con remate/с задним корпусом			
10.1994→11.1996	ABS, ADD, ADZ			
Reference	026 121 005 A 026 121 005 C 026 121 005 E 026 121 005 G 026 121 005 H 037 121 005 B 037 121 005 C 068 121 005 A			50 005 148
	ohne Gegengehäuse/without backhousing/sans demi-corps/sin remate/без заднего корпуса			

**Eos 1.6 FSI 16V****64**

05.2006→05.2008

BLF

Reference

03C 121 005 D

03C 121 005 K

03C 121 005 L



50 005 001

NEW

Eos 2.0 FSI 16V**65**

05.2006→05.2008

BVY, BVZ

Reference

06B 121 011 H

06B 121 011 L

06B 121 011 LX

06B 121 011 M



50 005 775

Eos 3.2i 24V**66**

05.2006→

BUB

Reference

022 121 011

50 005 008

NEW

EuroVan 2.4 D**67**

07.1995→12.2000

AAB

Reference

023 121 004

023 121 004 V

023 121 004 X

→320.127



50 005 163

07.1995→12.2000

AAB

Reference

074 121 004 B

074 121 005 N

074 121 005 NX

074 121 005 M

074 121 005 MX

20 Zähne/teeth/dientes/dents/зубьев

320.128→



50 005 555

07.1995→12.2000

AAB

Reference

074 121 004

074 121 004 A

074 121 004 V

074 121 004 X

18 Zähne/teeth/dientes/dents/зубьев

320.128→



50 005 551

EuroVan 2.5i**68**

09.1991→12.1995

AAF, ACU

Reference

023 121 004

023 121 004 V

023 121 004 X

ch→ch. 70-N-014 000



50 005 163

09.1991→12.1995

AAF, ACU

Reference

074 121 004 B

074 121 005 N

074 121 005 NX

074 121 005 M

074 121 005 MX

20 Zähne/teeth/dientes/dents/зубьев

ch 70-N-014 001→



50 005 555

09.1991→12.1995

AAF, ACU

Reference

074 121 004

074 121 004 A

074 121 004 V

074 121 004 X

18 Zähne/teeth/dientes/dents/зубьев

ch 70-N-014 001→



50 005 551

V



EuroVan 2.8i						69
05.1996→05.2000 Reference	AES 021 121 004	021 121 004 A				50 005 165
Fox 1.3						70
09.1978→1981 Reference	HH 052 121 004 052 121 005 A	052 121 004 V 052 121 005 AX	052 121 004 X 052 121 019	052 121 005		50 005 142
Fox 1.4 TDI						71
04.2005→ Reference	BNM 045 121 011B	045 121 011F	045 121 011H	045 121 011HX		50 005 556
Fox 1.9 SDI						72
12.2007→ Reference	ASY 045 121 011 C	045 121 011 G				50 005 750
Fox 1.6 (USA)						73
01.1975→07.1980 Reference	YG, YH 056 121 005 068 121 005 C	056 121 005 A 068 121 005 X	068 121 005	068 121 005 B		50 005 140
	ohne Gegengehäuse/without backhousing/sans demi-corps/sin remate/без заднего корпуса					
01.1975→07.1980 Reference	YG, YH 026 121 010 A 026 121 010 DX 056 121 013 A	026 121 010 AV 055 121 010 068 121 010	026 121 010 D 055 121 010 X	026 121 010 DV 056 121 011		50 005 150
	mit Gegengehäuse/with backhousing/avec demi-corps/con remate/c задним корпусом					
Fox 1.8 (USA)						74
03.1987→06.1993 Reference	JN 026 121 010 026 121 010 F 026 121 010 X 068 121 010 A	026 121 010 C 026 121 010 FV 037 121 010 068 121 010 AX	026 121 010 CV 026 121 010 FX 037 121 010 A	026 121 010 CX 026 121 010 V 037 121 010 AX		50 005 151
	mit Gegengehäuse/with backhousing/avec demi-corps/con remate/c задним корпусом					
03.1987→06.1993 Reference	JN 026 121 005 A 026 121 005 H	026 121 005 C 037 121 005 B	026 121 005 E 037 121 005 C	026 121 005 G 068 121 005 A		50 005 148
	ohne Gegengehäuse/without backhousing/sans demi-corps/sin remate/без заднего корпуса					
Gol 1.05						75
→ Reference	HZ 030 121 004 A 030 121 005 LV 786.023→	030 121 004 B 030 121 005 LX	030 121 005 H	030 121 005 L		50 005 153



VOLKSWAGEN

→ Reference 	HZ 052 121 004 052 121 005 A →786.022	052 121 004 V 052 121 005 AX	052 121 004 X 052 121 019	052 121 005		50 005 142
Gol 1.3i						76
→ Reference 	NZ 030 121 004 A 030 121 005 LV 200.001→	030 121 004 B 030 121 005 LX	030 121 005 H	030 121 005 L		50 005 153
→ Reference 	NZ 052 121 004 052 121 005 A →200.000	052 121 004 V 052 121 005 AX	052 121 004 X 052 121 019	052 121 005		50 005 142
Gol 1.4i						77
→ Reference	AEX 030 121 005 N 030 121 008 DX	030 121 005 NV	030 121 005 NX	030 121 008 D		50 005 139
Gol 1.6						78
→ Reference 	RF 026 121 010 026 121 010 F 026 121 010 X 068 121 010 A mit Gegengehäuse/with backhousing/avec demi-corps/con remate/c задним корпусом	026 121 010 C 026 121 010 FV 037 121 010 068 121 010 AX	026 121 010 CV 026 121 010 FX 037 121 010 A	026 121 010 CX 026 121 010 V 037 121 010 AX		50 005 151
→ Reference 	RF 026 121 005 A 026 121 005 H ohne Gegengehäuse/without backhousing/sans demi-corps/sin remate/без заднего корпуса	026 121 005 C 037 121 005 B	026 121 005 E 037 121 005 C	026 121 005 G 068 121 005 A		50 005 148
Gol 1.6i						79
→ Reference 	ABN, AFT, AKS, EZ, PN 026 121 010 026 121 010 F 026 121 010 X 068 121 010 A mit Gegengehäuse/with backhousing/avec demi-corps/con remate/c задним корпусом	026 121 010 C 026 121 010 FV 037 121 010 068 121 010 AX	026 121 010 CV 026 121 010 FX 037 121 010 A	026 121 010 CX 026 121 010 V 037 121 010 AX		50 005 151
→ Reference 	ABN, AFT, AKS, EZ, PN 026 121 005 A 026 121 005 H ohne Gegengehäuse/without backhousing/sans demi-corps/sin remate/без заднего корпуса	026 121 005 C 037 121 005 B	026 121 005 E 037 121 005 C	026 121 005 G 068 121 005 A		50 005 148
05.1994→ Reference 	AP 504, AP 505, AP 521, AP 540, AP 541, AP 542, UNF, UPD 026 115 105 A UNF, UPD: 01.2004→ UNF: 01.2006→, 5W-6-000 001→5W-9P050 699 UNF: 01.2006→, 5W-6-000 001→5W-9T061 964 AP 541, AP 542: 07.1997→	026 115 105 A				50 005 822

V



07.1995→12.1997	AEE						
Reference	030 121 005 N 030 121 008 DX	030 121 005 NV	030 121 005 NX	030 121 008 D		50 005 139	
Gol 1.6 D						80	
→	JP, ME						
Reference	026 121 010 026 121 010 F 026 121 010 X 068 121 010 A	026 121 010 C 026 121 010 FV 037 121 010 068 121 010 AX	026 121 010 CV 026 121 010 FX 037 121 010 A	026 121 010 CX 026 121 010 V 037 121 010 AX		50 005 151	
	mit Gegengehäuse/with backhousing/avec demi-corps/con remate/c задним корпусом						
→	JP, ME						
Reference	026 121 005 A 026 121 005 H	026 121 005 C 037 121 005 B	026 121 005 E 037 121 005 C	026 121 005 G 068 121 005 A		50 005 148	
	ohne Gegengehäuse/without backhousing/sans demi-corps/sin remate/без заднего корпуса						
Gol 1.6 TD						81	
→	1V, JR, MF, RA, SB						
Reference	026 121 010 026 121 010 F 026 121 010 X 068 121 010 A	026 121 010 C 026 121 010 FV 037 121 010 068 121 010 AX	026 121 010 CV 026 121 010 FX 037 121 010 A	026 121 010 CX 026 121 010 V 037 121 010 AX		50 005 151	
	mit Gegengehäuse/with backhousing/avec demi-corps/con remate/c задним корпусом						
→	1V, JR, MF, RA, SB						
Reference	026 121 005 A 026 121 005 H	026 121 005 C 037 121 005 B	026 121 005 E 037 121 005 C	026 121 005 G 068 121 005 A		50 005 148	
	ohne Gegengehäuse/without backhousing/sans demi-corps/sin remate/без заднего корпуса						
→	MF						
Reference	028 115 105 G	028 115 105 G	068 115 105 BK	068 115 105 BK		50 005 806	
Gol 1.8						82	
→	GU, RH						
Reference	026 121 010 026 121 010 F 026 121 010 X 068 121 010 A	026 121 010 C 026 121 010 FV 037 121 010 068 121 010 AX	026 121 010 CV 026 121 010 FX 037 121 010 A	026 121 010 CX 026 121 010 V 037 121 010 AX		50 005 151	
	mit Gegengehäuse/with backhousing/avec demi-corps/con remate/c задним корпусом						
→	GU, RH						
Reference	026 121 005 A 026 121 005 H	026 121 005 C 037 121 005 B	026 121 005 E 037 121 005 C	026 121 005 G 068 121 005 A		50 005 148	
	ohne Gegengehäuse/without backhousing/sans demi-corps/sin remate/без заднего корпуса						
V	Gol 1.8i						83
→	AAM, ACC, ADZ, PB, PF, RP, RV						
Reference	026 121 010 026 121 010 F 026 121 010 X 068 121 010 A	026 121 010 C 026 121 010 FV 037 121 010 068 121 010 AX	026 121 010 CV 026 121 010 FX 037 121 010 A	026 121 010 CX 026 121 010 V 037 121 010 AX		50 005 151	
	mit Gegengehäuse/with backhousing/avec demi-corps/con remate/c задним корпусом						



VOLKSWAGEN

→ Reference	AAM, ACC, ADZ, PB, PF, RP, RV 026 121 005 A 026 121 005 C 026 121 005 E 026 121 005 G 026 121 005 H 037 121 005 B 037 121 005 C 068 121 005 A ohne Gegengehäuse/without backhousing/sans demi-corps/sin remate/без заднего корпуса				50 005 148
09.1994→ Reference	AP 522, AP 543, UDH 026 115 105 A 026 115 105 A UDH: 01.2004→ UDH: 01.2006→, 5W-6-000 001→5W-9P050 699 UDH: 01.2006→, 5W-6-000 001→5W-9T061 964 AP 543: 07.1997→				50 005 822
Gol 1.8i 16V					84
→ Reference	KR, PL 026 121 010 026 121 010 C 026 121 010 CV 026 121 010 CX 026 121 010 F 026 121 010 FV 026 121 010 FX 026 121 010 V 026 121 010 X 037 121 010 037 121 010 A 037 121 010 AX 068 121 010 A 068 121 010 AX mit Gegengehäuse/with backhousing/avec demi-corps/con remate/c задним корпусом				50 005 151
→ Reference	KR, PL 026 121 005 A 026 121 005 C 026 121 005 E 026 121 005 G 026 121 005 H 037 121 005 B 037 121 005 C 068 121 005 A ohne Gegengehäuse/without backhousing/sans demi-corps/sin remate/без заднего корпуса				50 005 148
→ Reference	KR, PL 027 115 105 A 027 115 105 A 027 115 105 C 027 115 105 C 068 115 105 AG 068 115 105 AG 068 115 105 Q 068 115 105 Q				50 005 803
Gol 1.8i Turbo 16V					85
06.2003→	AUQ				50 005 131
Gol 1.9 D					86
06.2002→07.2006 Reference	1Y 026 121 010 026 121 010 C 026 121 010 CV 026 121 010 CX 026 121 010 F 026 121 010 FV 026 121 010 FX 026 121 010 V 026 121 010 X 037 121 010 037 121 010 A 037 121 010 AX 068 121 010 A 068 121 010 AX mit Gegengehäuse/with backhousing/avec demi-corps/con remate/c задним корпусом				50 005 151
06.2002→07.2006 Reference	1Y 026 121 005 A 026 121 005 C 026 121 005 E 026 121 005 G 026 121 005 H 037 121 005 B 037 121 005 C 068 121 005 A ohne Gegengehäuse/without backhousing/sans demi-corps/sin remate/без заднего корпуса				50 005 148
Gol 1.9 TD					87
→ Reference	AAZ, ABL 026 121 010 026 121 010 C 026 121 010 CV 026 121 010 CX 026 121 010 F 026 121 010 FV 026 121 010 FX 026 121 010 V 026 121 010 X 037 121 010 037 121 010 A 037 121 010 AX 068 121 010 A 068 121 010 AX mit Gegengehäuse/with backhousing/avec demi-corps/con remate/c задним корпусом				50 005 151

V







→	AAZ, ABL			
Reference	026 121 005 A 026 121 005 C 026 121 005 E 026 121 005 G 026 121 005 H 037 121 005 B 037 121 005 C 068 121 005 A			50 005 148
	ohne Gegengehäuse/without backhousing/sans demi-corps/sin remate/без заднего корпуса			
GoI 1.9 TDI				88
→	ALE			
Reference	026 121 010 026 121 010 C 026 121 010 CV 026 121 010 CX 026 121 010 F 026 121 010 FV 026 121 010 FX 026 121 010 V 026 121 010 X 037 121 010 037 121 010 A 037 121 010 AX 068 121 010 A 068 121 010 AX			50 005 151
	mit Gegengehäuse/with backhousing/avec demi-corps/con remate/с задним корпусом			
→	AGR			
Reference	038 121 011 038 121 011 A 038 121 011 AV 038 121 011AX			50 005 132
→	ALE			
Reference	026 121 005 A 026 121 005 C 026 121 005 E 026 121 005 G 026 121 005 H 037 121 005 B 037 121 005 C 068 121 005 A			50 005 148
	ohne Gegengehäuse/without backhousing/sans demi-corps/sin remate/без заднего корпуса			
→	ALE			
Reference	028 115 105 G 028 115 105 G 068 115 105 BK 068 115 105 BK			50 005 806
GoI 1.9 SDI				89
→	AEY			
Reference	026 121 010 026 121 010 C 026 121 010 CV 026 121 010 CX 026 121 010 F 026 121 010 FV 026 121 010 FX 026 121 010 V 026 121 010 X 037 121 010 037 121 010 A 037 121 010 AX 068 121 010 A 068 121 010 AX			50 005 151
	mit Gegengehäuse/with backhousing/avec demi-corps/con remate/с задним корпусом 09.1996→			
→	AGD			
Reference	028 121 004 028 121 004 V 028 121 004 X			50 005 158
→	AEY			
Reference	026 121 005 A 026 121 005 C 026 121 005 E 026 121 005 G 026 121 005 H 037 121 005 B 037 121 005 C 068 121 005 A			50 005 148
	ohne Gegengehäuse/without backhousing/sans demi-corps/sin remate/без заднего корпуса			
→	AEY			
Reference	028 115 105 G 028 115 105 G 068 115 105 BK 068 115 105 BK			50 005 806





Gol 2.0i

90

→	AEP, AGG, AKR					
Reference	026 121 010	026 121 010 C	026 121 010 CV	026 121 010 CX		50 005 151
	026 121 010 F	026 121 010 FV	026 121 010 FX	026 121 010 V		
	026 121 010 X	037 121 010	037 121 010 A	037 121 010 AX		
	068 121 010 A	068 121 010 AX				
	mit Gegengehäuse/with backhousing/avec demi-corps/con remate/c задним корпусом					
→	AEP, AGG, AKR					
Reference	026 121 005 A	026 121 005 C	026 121 005 E	026 121 005 G		50 005 148
	026 121 005 H	037 121 005 B	037 121 005 C	068 121 005 A		
	ohne Gegengehäuse/without backhousing/sans demi-corps/sin remate/без заднего корпуса					
→	AEP, AGG, AKR					
Reference	027 115 105 B	027 115 105 B				50 005 805
09.1994→11.2005	AP 528, AP 529, AP 546, AP 547, UQG					
Reference	026 115 105 A	026 115 105 A				50 005 822
	UQG: 01.2004→					

Gol 2.0i 16V

91

→	ABF					
Reference	026 121 010	026 121 010 C	026 121 010 CV	026 121 010 CX		50 005 151
	026 121 010 F	026 121 010 FV	026 121 010 FX	026 121 010 V		
	026 121 010 X	037 121 010	037 121 010 A	037 121 010 AX		
	068 121 010 A	068 121 010 AX				
	mit Gegengehäuse/with backhousing/avec demi-corps/con remate/c задним корпусом					
→	ABF					
Reference	026 121 005 A	026 121 005 C	026 121 005 E	026 121 005 G		50 005 148
	026 121 005 H	037 121 005 B	037 121 005 C	068 121 005 A		
	ohne Gegengehäuse/without backhousing/sans demi-corps/sin remate/без заднего корпуса					
10.1995→07.2000	AP 112					
Reference	053 115 105 B	053 115 105 B	053 115 105 C	053 115 105 C		50 005 845

Gol 2.8i VR6

92

→	AAA					
Reference	021 121 004	021 121 004 A				50 005 165

Golf I 1.1

93

04.1974→12.1983	FA, FJ, GG					
Reference	052 121 004	052 121 004 V	052 121 004 X	052 121 005		50 005 142
	052 121 005 A	052 121 005 AX	052 121 019			

**Golf I 1.3****94**

08.1979→12.1983

GF, GS

Reference

052 121 004	052 121 004 V	052 121 004 X	052 121 005
052 121 005 A	052 121 005 AX	052 121 019	

**50 005 142****Golf I 1.5****95**

08.1977→12.1983

GH, JB

Reference

026 121 010	026 121 010 C	026 121 010 CV	026 121 010 CX
026 121 010 F	026 121 010 FV	026 121 010 FX	026 121 010 V
026 121 010 X	037 121 010	037 121 010 A	037 121 010 AX
068 121 010 A	068 121 010 AX		



mit Gegengehäuse/with backhousing/avec demi-corps/con remate/c задним корпусом
ch ...C-630 001→

**50 005 151**

02.1974→12.1983

EH, FH, FK, GH, JB

Reference

056 121 005	056 121 005 A	068 121 005	068 121 005 B
068 121 005 C	068 121 005 X		



ohne Gegengehäuse/without backhousing/sans demi-corps/sin remate/без заднего корпуса
JB: →ch C-630 000
GH: →ch. C-630 000

**50 005 140**

02.1974→12.1983

EH, FH, FK, GH, JB

Reference

027 115 105	027 115 105	027 115 105 E	027 115 105 E
049 115 105 A	049 115 105 A	055 115 105 D	055 115 105 D

**50 005 808**

08.1977→12.1983

GH, JB

Reference

026 121 005 A	026 121 005 C	026 121 005 E	026 121 005 G
026 121 005 H	037 121 005 B	037 121 005 C	068 121 005 A



ohne Gegengehäuse/without backhousing/sans demi-corps/sin remate/без заднего корпуса
ch ...C-630 001→

**50 005 148**

02.1974→12.1983

EH, FH, FK, GH, JB

Reference

026 121 010 A	026 121 010 AV	026 121 010 D	026 121 010 DV
026 121 010 DX	055 121 010	055 121 010 X	056 121 011
056 121 013 A	068 121 010		



mit Gegengehäuse/with backhousing/avec demi-corps/con remate/c задним корпусом
GH, JB: →ch. C-630 000

**50 005 150****Golf I 1.5 D****96**

08.1976→07.1980

CK

Reference

056 121 005	056 121 005 A	068 121 005	068 121 005 B
068 121 005 C	068 121 005 X		



ohne Gegengehäuse/without backhousing/sans demi-corps/sin remate/без заднего корпуса

**50 005 140**

08.1976→07.1980

CK

Reference

027 115 105 A	027 115 105 A	027 115 105 C	027 115 105 C
068 115 105 AG	068 115 105 AG	068 115 105 Q	068 115 105 Q

**50 005 803**

08.1976→07.1980

CK

Reference

026 121 010 A	026 121 010 AV	026 121 010 D	026 121 010 DV
026 121 010 DX	055 121 010	055 121 010 X	056 121 011
056 121 013 A	068 121 010		







mit Gegengehäuse/with backhousing/avec demi-corps/con remate/c задним корпусом

**50 005 150**











Golf I 1.6

97

→	EJ, FP					
Reference	056 121 005 068 121 005 C	056 121 005 A 068 121 005 X	068 121 005	068 121 005 B		50 005 140
	ohne Gegengehäuse/without backhousing/sans demi-corps/sin remate/без заднего корпуса					
08.1979→12.1983	EJ, EM					
Reference	027 115 105 049 115 105 A	027 115 105 049 115 105 A	027 115 105 E 055 115 105 D	027 115 105 E 055 115 105 D		50 005 808
→	EJ, FP					
Reference	026 121 010 A 026 121 010 DX 056 121 013 A	026 121 010 AV 055 121 010 068 121 010	026 121 010 D 055 121 010 X	026 121 010 DV 056 121 011		50 005 150
	mit Gegengehäuse/with backhousing/avec demi-corps/con remate/c задним корпусом					



Golf I 1.6i

98

06.1976→07.1982	EG					
Reference	026 121 010 026 121 010 F 026 121 010 X 068 121 010 A	026 121 010 C 026 121 010 FV 037 121 010 068 121 010 AX	026 121 010 CV 026 121 010 FX 037 121 010 A	026 121 010 CX 026 121 010 V 037 121 010 AX		50 005 151
	mit Gegengehäuse/with backhousing/avec demi-corps/con remate/c задним корпусом ch ...C-630 001→					
08.1975→07.1982	EG, FN, FP, FT, FV					
Reference	056 121 005 068 121 005 C	056 121 005 A 068 121 005 X	068 121 005	068 121 005 B		50 005 140
	ohne Gegengehäuse/without backhousing/sans demi-corps/sin remate/без заднего корпуса EG: →ch C-630 000					
08.1975→07.1982	EG, FN, FP, FT, FV					
Reference	027 115 105 049 115 105 A	027 115 105 049 115 105 A	027 115 105 E 055 115 105 D	027 115 105 E 055 115 105 D		50 005 808
06.1976→07.1982	EG					
Reference	026 121 005 A 026 121 005 H	026 121 005 C 037 121 005 B	026 121 005 E 037 121 005 C	026 121 005 G 068 121 005 A		50 005 148
	ohne Gegengehäuse/without backhousing/sans demi-corps/sin remate/без заднего корпуса ch ...C-630 001→					
08.1975→07.1982	EG, FN, FP, FT, FV					
Reference	026 121 010 A 026 121 010 DX 056 121 013 A	026 121 010 AV 055 121 010 068 121 010	026 121 010 D 055 121 010 X	026 121 010 DV 056 121 011		50 005 150
	mit Gegengehäuse/with backhousing/avec demi-corps/con remate/c задним корпусом EG: →ch. C-630 000					

Golf I 1.6 D

99

08.1982→12.1984	JK					
Reference	026 121 010 026 121 010 F 026 121 010 X 068 121 010 A	026 121 010 C 026 121 010 FV 037 121 010 068 121 010 AX	026 121 010 CV 026 121 010 FX 037 121 010 A	026 121 010 CX 026 121 010 V 037 121 010 AX		50 005 151
	mit Gegengehäuse/with backhousing/avec demi-corps/con remate/c задним корпусом					

V



08.1980→12.1984	CR, JK					
Reference	068 115 105 AE 068 115 105 P	068 115 105 AN 068 115 105 S	068 115 105 D	068 115 105 H		50 005 809
08.1982→12.1984	JK					
Reference	026 121 005 A 026 121 005 H	026 121 005 C 037 121 005 B	026 121 005 E 037 121 005 C	026 121 005 G 068 121 005 A		50 005 148
	ohne Gegengehäuse/without backhousing/sans demi-corps/sin remate/без заднего корпуса					
08.1980→07.1982	CR					
Reference	027 115 105 A 068 115 105 AG	027 115 105 A 068 115 105 AG	027 115 105 C 068 115 105 Q	027 115 105 C 068 115 105 Q		50 005 803
Golf I 1.6 TD						100
03.1982→12.1983	CY					
Reference	068 115 105 AE 068 115 105 P	068 115 105 AN 068 115 105 S	068 115 105 D	068 115 105 H		50 005 809
Golf I 1.7i						101
08.1980→12.1983	EN					
Reference	026 121 010 026 121 010 F 026 121 010 X 068 121 010 A	026 121 010 C 026 121 010 FV 037 121 010 068 121 010 AX	026 121 010 CV 026 121 010 FX 037 121 010 A	026 121 010 CX 026 121 010 V 037 121 010 AX		50 005 151
	mit Gegengehäuse/with backhousing/avec demi-corps/con remate/с задним корпусом					
08.1980→12.1983	EN					
Reference	027 115 105 049 115 105 A	027 115 105 049 115 105 A	027 115 105 E 055 115 105 D	027 115 105 E 055 115 105 D		50 005 808
08.1980→12.1983	EN					
Reference	026 121 005 A 026 121 005 H	026 121 005 C 037 121 005 B	026 121 005 E 037 121 005 C	026 121 005 G 068 121 005 A		50 005 148
	ohne Gegengehäuse/without backhousing/sans demi-corps/sin remate/без заднего корпуса					
Golf I 1.8i						102
08.1982→12.1983	DX, JJ					
Reference	026 121 010 026 121 010 F 026 121 010 X 068 121 010 A	026 121 010 C 026 121 010 FV 037 121 010 068 121 010 AX	026 121 010 CV 026 121 010 FX 037 121 010 A	026 121 010 CX 026 121 010 V 037 121 010 AX		50 005 151
	mit Gegengehäuse/with backhousing/avec demi-corps/con remate/с задним корпусом					
08.1982→12.1983	DX, JJ					
Reference	027 115 105 049 115 105 A	027 115 105 049 115 105 A	027 115 105 E 055 115 105 D	027 115 105 E 055 115 105 D		50 005 808



08.1982→12.1983 Reference	DX, JJ 026 121 005 A 026 121 005 H 026 121 005 C 037 121 005 B 026 121 005 E 037 121 005 C 026 121 005 G 068 121 005 A ohne Gegengehäuse/without backhousing/sans demi-corps/sin remate/без заднего корпуса					50 005 148
Golf II 1.05						103
05.1985→10.1991 Reference	HZ 030 115 105 C 030 115 105 E 030 115 105 C 030 115 105 E 030 115 105 D 030 115 105 D					50 005 868
05.1985→10.1991 Reference	HZ 030 121 004 A 030 121 005 LV 786.023→ 030 121 004 B 030 121 005 LX 030 121 005 H 030 121 005 L					50 005 153
05.1985→10.1991 Reference	HZ 052 121 004 052 121 005 A →786.022 052 121 004 V 052 121 005 AX 052 121 004 X 052 121 019 052 121 005					50 005 142
Golf II 1.3						104
08.1985→07.1992 Reference	2G, MH, NU 030 115 105 C 030 115 105 E 030 115 105 C 030 115 105 E 030 115 105 D 030 115 105 D					50 005 868
08.1983→12.1988 Reference	GT, HK, MH, NU 052 121 004 052 121 005 A 052 121 004 V 052 121 005 AX 052 121 004 X 052 121 019 052 121 005					50 005 142
Golf II 1.3i						105
08.1985→07.1992 Reference	NZ 030 115 105 C 030 115 105 E 030 115 105 C 030 115 105 E 030 115 105 D 030 115 105 D					50 005 868
08.1985→07.1992 Reference	NZ 030 121 004 A 030 121 005 LV 200.001→ 030 121 004 B 030 121 005 LX 030 121 005 H 030 121 005 L					50 005 153
08.1985→07.1992 Reference	NZ 052 121 004 052 121 005 A →200.000 052 121 004 V 052 121 005 AX 052 121 004 X 052 121 019 052 121 005					50 005 142

V

**Golf II 1.6****106**

08.1986→10.1991	RF					
Reference	026 121 010	026 121 010 C	026 121 010 CV	026 121 010 CX		50 005 151
	026 121 010 F	026 121 010 FV	026 121 010 FX	026 121 010 V		
	026 121 010 X	037 121 010	037 121 010 A	037 121 010 AX		
	068 121 010 A	068 121 010 AX				
	mit Gegengehäuse/with backhousing/avec demi-corps/con remate/c задним корпусом					
08.1986→10.1991	RF					
Reference	027 115 105	027 115 105	027 115 105 E	027 115 105 E		50 005 808
	049 115 105 A	049 115 105 A	055 115 105 D	055 115 105 D		
08.1986→10.1991	RF					
Reference	026 121 005 A	026 121 005 C	026 121 005 E	026 121 005 G		50 005 148
	026 121 005 H	037 121 005 B	037 121 005 C	068 121 005 A		
	ohne Gegengehäuse/without backhousing/sans demi-corps/sin remate/без заднего корпуса					

Golf II 1.6i**107**

08.1983→07.1992	ABN, EW, EZ, EZA, HM, HN, PN					
Reference	026 121 010	026 121 010 C	026 121 010 CV	026 121 010 CX		50 005 151
	026 121 010 F	026 121 010 FV	026 121 010 FX	026 121 010 V		
	026 121 010 X	037 121 010	037 121 010 A	037 121 010 AX		
	068 121 010 A	068 121 010 AX				
	mit Gegengehäuse/with backhousing/avec demi-corps/con remate/c задним корпусом					
08.1983→07.1992	ABN, EW, EZ, EZA, HM, HN, PN					
Reference	027 115 105	027 115 105	027 115 105 E	027 115 105 E		50 005 808
	049 115 105 A	049 115 105 A	055 115 105 D	055 115 105 D		
08.1983→07.1992	ABN, EW, EZ, EZA, HM, HN, PN					
Reference	026 121 005 A	026 121 005 C	026 121 005 E	026 121 005 G		50 005 148
	026 121 005 H	037 121 005 B	037 121 005 C	068 121 005 A		
	ohne Gegengehäuse/without backhousing/sans demi-corps/sin remate/без заднего корпуса					





Golf II 1.6 D**108**

08.1983→07.1992	JP, ME					
Reference	026 121 010	026 121 010 C	026 121 010 CV	026 121 010 CX		50 005 151
	026 121 010 F	026 121 010 FV	026 121 010 FX	026 121 010 V		
	026 121 010 X	037 121 010	037 121 010 A	037 121 010 AX		
	068 121 010 A	068 121 010 AX				
	mit Gegengehäuse/with backhousing/avec demi-corps/con remate/c задним корпусом					
08.1983→07.1992	JP, ME					
Reference	068 115 105 AE	068 115 105 AN	068 115 105 D	068 115 105 H		50 005 809
	068 115 105 P	068 115 105 S				
08.1983→07.1992	JP, ME					
Reference	026 121 005 A	026 121 005 C	026 121 005 E	026 121 005 G		50 005 148
	026 121 005 H	037 121 005 B	037 121 005 C	068 121 005 A		
	ohne Gegengehäuse/without backhousing/sans demi-corps/sin remate/без заднего корпуса					





Golf II 1.6 TD

109

08.1983→07.1992	1V, JR, MF, RA, SB					
Reference	026 121 010	026 121 010 C	026 121 010 CV	026 121 010 CX		50 005 151
	026 121 010 F	026 121 010 FV	026 121 010 FX	026 121 010 V		
	026 121 010 X	037 121 010	037 121 010 A	037 121 010 AX		
	068 121 010 A	068 121 010 AX				
	mit Gegengehäuse/with backhousing/avec demi-corps/con remate/c задним корпусом					
08.1983→10.1991	JR					
Reference	068 115 105 AE	068 115 105 AN	068 115 105 D	068 115 105 H		50 005 809
	068 115 105 P	068 115 105 S				
08.1983→07.1992	1V, JR, MF, RA, SB					
Reference	026 121 005 A	026 121 005 C	026 121 005 E	026 121 005 G		50 005 148
	026 121 005 H	037 121 005 B	037 121 005 C	068 121 005 A		
	ohne Gegengehäuse/without backhousing/sans demi-corps/sin remate/без заднего корпуса					
08.1983→10.1991	JR, MF, RA, SB					
Reference	028 115 105 G	028 115 105 G	068 115 105 BK	068 115 105 BK		50 005 806
	JR: 01.1988→					



Golf II 1.8

110

08.1983→10.1991	GU, GX, RH					
Reference	026 121 010	026 121 010 C	026 121 010 CV	026 121 010 CX		50 005 151
	026 121 010 F	026 121 010 FV	026 121 010 FX	026 121 010 V		
	026 121 010 X	037 121 010	037 121 010 A	037 121 010 AX		
	068 121 010 A	068 121 010 AX				
	mit Gegengehäuse/with backhousing/avec demi-corps/con remate/c задним корпусом					
08.1983→10.1991	GU, GX, RH					
Reference	027 115 105	027 115 105	027 115 105 E	027 115 105 E		50 005 808
	049 115 105 A	049 115 105 A	055 115 105 D	055 115 105 D		
08.1983→10.1991	GU, GX, RH					
Reference	026 121 005 A	026 121 005 C	026 121 005 E	026 121 005 G		50 005 148
	026 121 005 H	037 121 005 B	037 121 005 C	068 121 005 A		
	ohne Gegengehäuse/without backhousing/sans demi-corps/sin remate/без заднего корпуса					

Golf II 1.8i

111

08.1983→07.1993	1P, 2H, DX, EV, EX, GZ, HT, HV, JH, KT, PB, PF, RD, RG, RP, RV					
Reference	026 121 010	026 121 010 C	026 121 010 CV	026 121 010 CX		50 005 151
	026 121 010 F	026 121 010 FV	026 121 010 FX	026 121 010 V		
	026 121 010 X	037 121 010	037 121 010 A	037 121 010 AX		
	068 121 010 A	068 121 010 AX				
	mit Gegengehäuse/with backhousing/avec demi-corps/con remate/c задним корпусом					
08.1983→07.1993	1P, 2H, EV, EX, GZ, HT, HV, JH, KT, PB, PF, RD, RG, RP, RV					
Reference	027 115 105	027 115 105	027 115 105 E	027 115 105 E		50 005 808
	049 115 105 A	049 115 105 A	055 115 105 D	055 115 105 D		

V



08.1983→07.1993 Reference	1P, 2H, DX, EV, EX, GZ, HT, HV, JH, KT, PB, PF, RD, RG, RP, RV 026 121 005 A 026 121 005 C 026 121 005 E 026 121 005 G 026 121 005 H 037 121 005 B 037 121 005 C 068 121 005 A ohne Gegengehäuse/without backhousing/sans demi-corps/sin remate/без заднего корпуса			50 005 148
Golf II 1.8i 16V				112
02.1986→10.1991 Reference	KR, PL 026 121 010 026 121 010 C 026 121 010 CV 026 121 010 CX 026 121 010 F 026 121 010 FV 026 121 010 FX 026 121 010 V 026 121 010 X 037 121 010 037 121 010 A 037 121 010 AX 068 121 010 A 068 121 010 AX mit Gegengehäuse/with backhousing/avec demi-corps/con remate/с задним корпусом			50 005 151
02.1986→10.1991 Reference	KR, PL 026 121 005 A 026 121 005 C 026 121 005 E 026 121 005 G 026 121 005 H 037 121 005 B 037 121 005 C 068 121 005 A ohne Gegengehäuse/without backhousing/sans demi-corps/sin remate/без заднего корпуса			50 005 148
02.1986→10.1991 Reference	KR, PL 027 115 105 A 027 115 105 A 027 115 105 C 027 115 105 C 068 115 105 AG 068 115 105 AG 068 115 105 Q 068 115 105 Q			50 005 803
Golf II 1.8i G60				113
08.1988→07.1991 Reference	1H, PG 026 121 010 026 121 010 C 026 121 010 CV 026 121 010 CX 026 121 010 F 026 121 010 FV 026 121 010 FX 026 121 010 V 026 121 010 X 037 121 010 037 121 010 A 037 121 010 AX 068 121 010 A 068 121 010 AX mit Gegengehäuse/with backhousing/avec demi-corps/con remate/с задним корпусом			50 005 151
08.1988→07.1991 Reference	1H, PG 037 115 105			50 005 810
08.1988→07.1991 Reference	1H, PG 026 121 005 A 026 121 005 C 026 121 005 E 026 121 005 G 026 121 005 H 037 121 005 B 037 121 005 C 068 121 005 A ohne Gegengehäuse/without backhousing/sans demi-corps/sin remate/без заднего корпуса			50 005 148
Golf II 2.0i 16V				114
08.1989→07.1991 Reference	9A 026 121 010 026 121 010 C 026 121 010 CV 026 121 010 CX 026 121 010 F 026 121 010 FV 026 121 010 FX 026 121 010 V 026 121 010 X 037 121 010 037 121 010 A 037 121 010 AX 068 121 010 A 068 121 010 AX mit Gegengehäuse/with backhousing/avec demi-corps/con remate/с задним корпусом			50 005 151
08.1989→07.1991 Reference	9A 051 115 105 A 051 115 105 A			50 005 801
08.1989→07.1991 Reference	9A 026 121 005 A 026 121 005 C 026 121 005 E 026 121 005 G 026 121 005 H 037 121 005 B 037 121 005 C 068 121 005 A ohne Gegengehäuse/without backhousing/sans demi-corps/sin remate/без заднего корпуса			50 005 148



Golf III 1.4i

115

11.1991→07.1995	ABD						
Reference	030 115 105 C 030 115 105 E	030 115 105 C 030 115 105 E	030 115 105 D	030 115 105 D		50 005 868	
	1H-N-000 001→1H-S-078 143						
11.1991→07.1995	ABD						
Reference	030 121 004 A 030 121 005 LV	030 121 004 B 030 121 005 LX	030 121 005 H	030 121 005 L		50 005 153	
07.1995→05.1998	AEX, APQ						
Reference	030 121 005 N 030 121 008 DX	030 121 005 NV	030 121 005 NX	030 121 008 D		50 005 139	
07.1995→05.1998	AEX, APQ						
Reference	036 115 105 B 036 115 105 D	036 115 105 B 036 115 105 D	036 115 105 B 036 115 105 D	036 115 105 B 036 115 105 D		50 005 844	

Golf III 1.6i

116

10.1994→10.2000	AEK, AFT, AKS						
Reference	026 121 010 026 121 010 F 026 121 010 X 068 121 010 A	026 121 010 C 026 121 010 FV 037 121 010 068 121 010 AX	026 121 010 CV 026 121 010 FX 037 121 010 A	026 121 010 CX 026 121 010 V 037 121 010 AX		50 005 151	
	mit Gegengehäuse/with backhousing/avec demi-corps/con remate/c задним корпусом						
10.1994→10.2000	AEK, AFT, AKS						
Reference	027 115 105 049 115 105 A	027 115 105 049 115 105 A	027 115 105 E 055 115 105 D	027 115 105 E 055 115 105 D		50 005 808	
10.1994→10.2000	AEK, AFT, AKS						
Reference	026 121 005 A 026 121 005 H	026 121 005 C 037 121 005 B	026 121 005 E 037 121 005 C	026 121 005 G 068 121 005 A		50 005 148	
	ohne Gegengehäuse/without backhousing/sans demi-corps/sin remate/без заднего корпуса						
08.1992→09.1994	ABU						
Reference	030 121 004 A 030 121 005 LV	030 121 004 B 030 121 005 LX	030 121 005 H	030 121 005 L		50 005 153	
10.1997→05.2004	AKL						
Reference	06A 115 105 06A 115 105 B 06A 115 105 C 06A 115 105 D	06A 115 105 06A 115 105 B 06A 115 105 C 06A 115 105 D	06A 115 105 06A 115 105 B 06A 115 105 C 06A 115 105 D	06A 115 105 06A 115 105 B 06A 115 105 C 06A 115 105 D		50 005 819	
	1J-W-000 001→						
10.1994→12.1997	AEA, AEE						
Reference	030 121 005 N 030 121 008 DX	030 121 005 NV	030 121 005 NX	030 121 008 D		50 005 139	

V



07.1995→12.1997 Reference	AEE 036 115 105 B 036 115 105 D	036 115 105 B 036 115 105 D	036 115 105 B 036 115 105 D	036 115 105 B 036 115 105 D	 50 005 844	
10.1997→05.2004	AKL				 50 005 130	
Golf III 1.8i						117
08.1991→ Reference	AAM, ABS, ACC, ADZ, ANN, ANP 026 121 010 026 121 010 F 026 121 010 X 068 121 010 A	026 121 010 C 026 121 010 FV 037 121 010 068 121 010 AX	026 121 010 CV 026 121 010 FX 037 121 010 A	026 121 010 CX 026 121 010 V 037 121 010 AX	 50 005 151	
	mit Gegengehäuse/with backhousing/avec demi-corps/con remate/c задним корпусом					
08.1991→ Reference	AAM, ABS, ACC, ADZ, ANN, ANP 027 115 105 049 115 105 A	027 115 105 049 115 105 A	027 115 105 E 055 115 105 D	027 115 105 E 055 115 105 D	 50 005 808	
08.1991→ Reference	AAM, ABS, ACC, ADD, ADZ, ANN, ANP 026 121 005 A 026 121 005 H	026 121 005 C 037 121 005 B	026 121 005 E 037 121 005 C	026 121 005 G 068 121 005 A	 50 005 148	
	ohne Gegengehäuse/without backhousing/sans demi-corps/sin remate/без заднего корпуса					
Golf III 1.9 D						118
11.1991→02.1999 Reference	1Y 026 121 010 026 121 010 F 026 121 010 X 068 121 010 A	026 121 010 C 026 121 010 FV 037 121 010 068 121 010 AX	026 121 010 CV 026 121 010 FX 037 121 010 A	026 121 010 CX 026 121 010 V 037 121 010 AX	 50 005 151	
	mit Gegengehäuse/with backhousing/avec demi-corps/con remate/c задним корпусом					
11.1991→02.1999 Reference	1Y 026 121 005 A 026 121 005 H	026 121 005 C 037 121 005 B	026 121 005 E 037 121 005 C	026 121 005 G 068 121 005 A	 50 005 148	
	ohne Gegengehäuse/without backhousing/sans demi-corps/sin remate/без заднего корпуса					
11.1991→02.1999 Reference	1Y 028 115 105 G	028 115 105 G	068 115 105 BK	068 115 105 BK	 50 005 806	
Golf III 1.9 TD						119
11.1991→ Reference	AAZ 026 121 010 026 121 010 F 026 121 010 X 068 121 010 A	026 121 010 C 026 121 010 FV 037 121 010 068 121 010 AX	026 121 010 CV 026 121 010 FX 037 121 010 A	026 121 010 CX 026 121 010 V 037 121 010 AX	 50 005 151	
	mit Gegengehäuse/with backhousing/avec demi-corps/con remate/c задним корпусом					



VOLKSWAGEN

11.1991→ Reference	AAZ 026 121 005 A 026 121 005 C 026 121 005 E 026 121 005 G 026 121 005 H 037 121 005 B 037 121 005 C 068 121 005 A ohne Gegengehäuse/without backhousing/sans demi-corps/sin remate/без заднего корпуса			50 005 148
11.1991→ Reference	AAZ 028 115 105 G 028 115 105 G 068 115 105 BK 068 115 105 BK			50 005 806
Golf III 1.9 TDI				120
07.1993→12.2001 Reference	1Z, AHU, ALE 026 121 010 026 121 010 C 026 121 010 CV 026 121 010 CX 026 121 010 F 026 121 010 FV 026 121 010 FX 026 121 010 V 026 121 010 X 037 121 010 037 121 010 A 037 121 010 AX 068 121 010 A 068 121 010 AX mit Gegengehäuse/with backhousing/avec demi-corps/con remate/c задним корпусом			50 005 151
07.1993→12.2001 Reference	1Z, AHU, ALE 026 121 005 A 026 121 005 C 026 121 005 E 026 121 005 G 026 121 005 H 037 121 005 B 037 121 005 C 068 121 005 A ohne Gegengehäuse/without backhousing/sans demi-corps/sin remate/без заднего корпуса			50 005 148
07.1993→12.2001 Reference	1Z, AFN, AHU, ALE 028 115 105 G 028 115 105 G 068 115 105 BK 068 115 105 BK			50 005 806
Golf III 1.9 SDI				121
07.1995→02.1999 Reference	AEY 026 121 010 026 121 010 C 026 121 010 CV 026 121 010 CX 026 121 010 F 026 121 010 FV 026 121 010 FX 026 121 010 V 026 121 010 X 037 121 010 037 121 010 A 037 121 010 AX 068 121 010 A 068 121 010 AX mit Gegengehäuse/with backhousing/avec demi-corps/con remate/c задним корпусом 09.1996→			50 005 151
07.1995→02.1999 Reference	AEY 026 121 005 A 026 121 005 C 026 121 005 E 026 121 005 G 026 121 005 H 037 121 005 B 037 121 005 C 068 121 005 A ohne Gegengehäuse/without backhousing/sans demi-corps/sin remate/без заднего корпуса			50 005 148
07.1995→02.1999 Reference	AEY 028 115 105 G 028 115 105 G 068 115 105 BK 068 115 105 BK			50 005 806
Golf III 2.0i				122
11.1991→12.2001 Reference	2E, ADY, AEP, AGG, AKR 026 121 010 026 121 010 C 026 121 010 CV 026 121 010 CX 026 121 010 F 026 121 010 FV 026 121 010 FX 026 121 010 V 026 121 010 X 037 121 010 037 121 010 A 037 121 010 AX 068 121 010 A 068 121 010 AX mit Gegengehäuse/with backhousing/avec demi-corps/con remate/c задним корпусом			50 005 151

V



07.1995→12.2001 Reference	AGG 027 115 105 049 115 105 A	027 115 105 049 115 105 A	027 115 105 E 055 115 105 D	027 115 105 E 055 115 105 D	 50 005 808	
11.1991→12.2001 Reference	2E, ADY, AEP, AGG, AKR 026 121 005 A 026 121 005 H 	026 121 005 C 037 121 005 B	026 121 005 E 037 121 005 C	026 121 005 G 068 121 005 A ohne Gegengehäuse/without backhousing/sans demi-corps/sin remate/без заднего корпуса	 50 005 148	
11.1991→ Reference	2E, ADC, ADY, AEP, AGG, AKR 027 115 105 B	027 115 105 B			 50 005 805	
Golf III 2.0i 16V					123	
08.1992→12.1997 Reference	ABF 026 121 010 026 121 010 F 026 121 010 X 068 121 010 A 	026 121 010 C 026 121 010 FV 037 121 010 068 121 010 AX	026 121 010 CV 026 121 010 FX 037 121 010 A	026 121 010 CX 026 121 010 V 037 121 010 AX mit Gegengehäuse/with backhousing/avec demi-corps/con remate/с задним корпусом	 50 005 151	
08.1992→12.1997 Reference	ABF 051 115 105 A	051 115 105 A			 50 005 801	
08.1992→12.1997 Reference	ABF 026 121 005 A 026 121 005 H 	026 121 005 C 037 121 005 B	026 121 005 E 037 121 005 C	026 121 005 G 068 121 005 A ohne Gegengehäuse/without backhousing/sans demi-corps/sin remate/без заднего корпуса	 50 005 148	
Golf III 2.3i 20V					124	
10.1997→02.2001 Reference	AGZ 066 121 011 C	071 121 005			 50 005 159	
Golf III VR6 2.8i					125	
01.1992→ Reference	AAA 021 121 004	021 121 004 A			 50 005 165	
Golf III VR6 2.9i					126	
10.1984→12.1997 Reference	ABV 021 121 004	021 121 004 A			 50 005 165	



Golf IV 1.4i 16V

127

10.1997→06.2006	AHW, AKQ, APE, AXP, BCA						
Reference	036 121 005 B 036 121 005 S	036 121 005 E 036 121 008K	036 121 005 Q 036 121 008L	036 121 005 QX 036 121 008LX			50 005 154
10.1997→06.2006	AHW, AKQ, APE, AXP, BCA						
Reference	036 115 105 B 036 115 105 D	036 115 105 B 036 115 105 D	036 115 105 B 036 115 105 D	036 115 105 B 036 115 105 D		50 005 844	
	AXP: 01.2002→ AHW, AKQ, APE, AXP: 1J-W-000 001→						

Golf IV 1.6i

128

01.1998→06.2006	AEH, APF, AVU, BFQ						
Reference	06A 115 105 06A 115 105 B 06A 115 105 C 06A 115 105 D	06A 115 105 06A 115 105 B 06A 115 105 C 06A 115 105 D	06A 115 105 06A 115 105 B 06A 115 105 C 06A 115 105 D	06A 115 105 06A 115 105 B 06A 115 105 C 06A 115 105 D		50 005 819	
	AEH, APF, AVU: 1J-W-000 001→						
01.1998→05.2004	AEH, APF, AVU						50 005 130

Golf IV 1.6i 16V

129

11.1999→06.2006	ATN, AUS, AZD, BCB						
Reference	036 121 005 F	036 121 005 P	036 121 008 G	036 121 008 GX			50 005 754
11.1999→06.2006	ATN, AUS, AZD, BCB						
Reference	036 115 105 B 036 115 105 D	036 115 105 B 036 115 105 D	036 115 105 B 036 115 105 D	036 115 105 B 036 115 105 D		50 005 844	
	AZD: 01.2002→ ATN, AUS, AZD: 1J-W-000 001→						

Golf IV 1.6 FSI 16V

130

08.2001→06.2006	BAD						
Reference	036 121 005 F	036 121 005 P	036 121 008 G	036 121 008 GX			50 005 754

Golf IV 1.8i 20V

131



10.1997→10.2000	AGN						
Reference	06A 115 105 06A 115 105 B 06A 115 105 C 06A 115 105 D	06A 115 105 06A 115 105 B 06A 115 105 C 06A 115 105 D	06A 115 105 06A 115 105 B 06A 115 105 C 06A 115 105 D	06A 115 105 06A 115 105 B 06A 115 105 C 06A 115 105 D		50 005 819	
	1J-W-000 001→						
10.1997→10.2000	AGN						50 005 131

V





Golf IV 1.8i Turbo 20V

132

10.1997→05.2006	AGU, ARZ, AUM, AUQ						
Reference	06A 115 105	06A 115 105	06A 115 105	06A 115 105		50 005 819	
	06A 115 105 B	06A 115 105 B	06A 115 105 B	06A 115 105 B			
	06A 115 105 C	06A 115 105 C	06A 115 105 C	06A 115 105 C			
	06A 115 105 D	06A 115 105 D	06A 115 105 D	06A 115 105 D			
	1J-W-000 001→						
10.1997→05.2006	AGU, AQA, ARZ, AUM, AUQ						50 005 131





Golf IV 1.9 SDI

133

10.1997→06.2006	AGP, AQM						
Reference	038 121 011	038 121 011 A	038 121 011 AV	038 121 011AX			50 005 132
11.1998→06.2006	AQM						
Reference	06A 115 105	06A 115 105	06A 115 105	06A 115 105		50 005 819	
	06A 115 105 B	06A 115 105 B	06A 115 105 B	06A 115 105 B			
	06A 115 105 C	06A 115 105 C	06A 115 105 C	06A 115 105 C			
	06A 115 105 D	06A 115 105 D	06A 115 105 D	06A 115 105 D			
	1J-W-000 001→						

Golf IV 1.9 TDI

134

10.1997→	AGR, AHF, ALH, ASV						
Reference	038 121 011	038 121 011 A	038 121 011 AV	038 121 011AX			50 005 132
05.2001→06.2006	AXR						
Reference	038 121 011 G						50 005 783
08.1999→10.2000	AVG						
Reference	028 115 105 G	028 115 105 G	068 115 105 BK	068 115 105 BK		50 005 806	
	1E-X-000 001→1E-2-015 000						
10.1997→	AGR, AHF, AJM, ALH, ASV, ATD, AUY, AXR						
Reference	06A 115 105	06A 115 105	06A 115 105	06A 115 105		50 005 819	
	06A 115 105 B	06A 115 105 B	06A 115 105 B	06A 115 105 B			
	06A 115 105 C	06A 115 105 C	06A 115 105 C	06A 115 105 C			
	06A 115 105 D	06A 115 105 D	06A 115 105 D	06A 115 105 D			
	AGR, AHF, AJM, ALH, ASV, ATD, AUY: 1J-W-000 001→						
05.1999→06.2006	AJM, ARL, ASZ, ATD, AUY						
Reference	038 121 001 C	038 121 011 C	038 121 011 D	038 121 011G			50 005 554
	038 121 011J	038 121 011K	038 121 011KX				

V



Golf IV 2.0i

135

08.1998→06.2006

APK, AQY, AZG, AZH

Reference

06A 115 105	06A 115 105	06A 115 105	06A 115 105
06A 115 105 B	06A 115 105 B	06A 115 105 B	06A 115 105 B
06A 115 105 C	06A 115 105 C	06A 115 105 C	06A 115 105 C
06A 115 105 D	06A 115 105 D	06A 115 105 D	06A 115 105 D

APK, AQY, AZH: 1J-W-000 001→

**50 005 819**

→

AEG, APK, AQY, AZG, AZH, AZJ

**50 005 131**

Golf IV 2.0 (Bi-Fuel)

136

05.2002→06.2006

BEH

**50 005 131**

Golf IV 2.3i 25V

137

09.2000→05.2006

AQN

Reference

066 121 011 C 071 121 005

**50 005 159**

Golf IV 2.8i VR6 24V

138

05.1999→04.2001

AFP, AQP, AUE

Reference

021 121 004 021 121 004 A

**50 005 165**

05.2001→06.2005

BDE

Reference

022 121 011

**50 005 008****NEW**

Golf IV 3.2i 24V

139

06.2002→05.2004

BFH

Reference

022 121 011

**50 005 008****NEW**

Golf V 1.4i 16V

140

11.2005→06.2006

BCA

Reference

036 121 005 B	036 121 005 E	036 121 005 Q	036 121 005 QX
036 121 005 S	036 121 008K	036 121 008L	036 121 008LX

**50 005 154**

11.2005→06.2006

BCA

Reference

036 115 105 B	036 115 105 B	036 115 105 B	036 115 105 B
036 115 105 D	036 115 105 D	036 115 105 D	036 115 105 D



1K-4-000 001→

**50 005 844****V**





Golf V 1.4 FSI 16V

141

05.2006→	BUD						
Reference	036 121 005 B 036 121 005 S	036 121 005 E 036 121 008K	036 121 005 Q 036 121 008L	036 121 005 QX 036 121 008LX			50 005 154
10.2003→07.2006	BKG, BLN						
Reference	03C 121 005 B	03C 121 005 C					50 005 061 <small>NEW</small>
05.2006→	BUD						
Reference	036 115 105 B 036 115 105 D 1K-6-000 001→	036 115 105 B 036 115 105 D	036 115 105 B 036 115 105 D	036 115 105 B 036 115 105 D		50 005 844	

Golf V 1.6i

142

01.2004→	BGU, BSE, BSF						
Reference	06B 121 011 H	06B 121 011 L	06B 121 011 LX	06B 121 011 M			50 005 775
01.2004→	BGU, BSE, BSF						
Reference	06A 115 105 06A 115 105 B 06A 115 105 C 06A 115 105 D	06A 115 105 06A 115 105 B 06A 115 105 C 06A 115 105 D	06A 115 105 06A 115 105 B 06A 115 105 C 06A 115 105 D	06A 115 105 06A 115 105 B 06A 115 105 C 06A 115 105 D		50 005 819	
	BGU: 1K-4-000 001→ BSE, BSF: 1K-6-000 001→						

Golf V 1.6 FSI 16V

143

10.2003→01.2009	BAG, BLF, BLP						
Reference	03C 121 005 D	03C 121 005 K	03C 121 005 L				50 005 001 <small>NEW</small>

Golf V 1.6 SRE

144

11.2007→	CCSA						
Reference	06A 115 105 06A 115 105 B 06A 115 105 C 06A 115 105 D 1K-9-400 001→	06A 115 105 06A 115 105 B 06A 115 105 C 06A 115 105 D	06A 115 105 06A 115 105 B 06A 115 105 C 06A 115 105 D	06A 115 105 06A 115 105 B 06A 115 105 C 06A 115 105 D		50 005 819	

Golf V 1.9 TDI

145

10.2003→	BKC, BLS, BRU, BXE, BXF, BXJ						
Reference	045 121 011 B	045 121 011 F	045 121 011 H	045 121 011 HX			50 005 556

V



Golf V 2.0 FSI 16V

146

10.2003→11.2008 AXW, BLR, BLX, BLY, BVY, BVZ
 Reference 06B 121 011 H 06B 121 011 L 06B 121 011 LX 06B 121 011 M

**50 005 775**

Golf V 2.0 SDI

147

01.2004→11.2008 BDK
 Reference 045 121 011 B 045 121 011 F 045 121 011 H 045 121 011 HX

**50 005 556**

Golf V 2.0 TDI 16V

148

10.2003→ AZV, BKD
 Reference 038 121 001 C 038 121 011 C 038 121 011 D 038 121 011 G
 038 121 011 J 038 121 011 K 038 121 011 KX

**50 005 554**

Golf V 3.2i 24V

149

10.2003→ BML, BUB
 Reference 022 121 011

50 005 008
NEW

Golf Plus 1.4 FSI 16V

150

05.2007→ BUD
 Reference 036 121 005 B 036 121 005 E 036 121 005 Q 036 121 005 QX
 036 121 005 S 036 121 008 K 036 121 008 L 036 121 008 LX

**50 005 154**

05.2007→ BUD
 Reference 036 115 105 B 036 115 105 B 036 115 105 B 036 115 105 B
 036 115 105 D 036 115 105 D 036 115 105 D 036 115 105 D

**50 005 844**

Golf Plus 1.4i 16V

151

11.2005→06.2006 BCA
 Reference 036 121 005 B 036 121 005 E 036 121 005 Q 036 121 005 QX
 036 121 005 S 036 121 008 K 036 121 008 L 036 121 008 LX

**50 005 154**

11.2005→06.2006 BCA
 Reference 036 115 105 B 036 115 105 B 036 115 105 B 036 115 105 B
 036 115 105 D 036 115 105 D 036 115 105 D 036 115 105 D

**50 005 844**

Golf Plus 1.6 SRE

152

05.2007→ BSE, BSF
 Reference 06B 121 011 H 06B 121 011 L 06B 121 011 LX 06B 121 011 M

**50 005 775****V**



05.2007→ Reference	BSE, BSF, CCSA 06A 115 105 06A 115 105 B 06A 115 105 C 06A 115 105 D	06A 115 105 06A 115 105 B 06A 115 105 C 06A 115 105 D	06A 115 105 06A 115 105 B 06A 115 105 C 06A 115 105 D	06A 115 105 06A 115 105 B 06A 115 105 C 06A 115 105 D		50 005 819
Golf Plus 1.9 TDI						153
05.2007→ Reference	BLS, BXE, BXF, BXJ 045 121 011B	045 121 011F	045 121 011H	045 121 011HX		50 005 556
Golf Plus 2.0 FSI 16V						154
05.2007→06.2008 Reference	BVY, BVZ 06B 121 011 H	06B 121 011L	06B 121 011LX	06B 121 011M		50 005 775
Golf Plus 2.0 TDI 16V						155
05.2007→ Reference	AZV, BKD 038 121 001 C 038 121 011J	038 121 011 C 038 121 011K	038 121 011 D 038 121 011KX	038 121 011G		50 005 554
Ittis 1.6 TD						156
08.1987→12.1988 Reference	1C 026 121 010 026 121 010 F 026 121 010 X 068 121 010 A	026 121 010 C 026 121 010 FV 037 121 010 068 121 010 AX	026 121 010 CV 026 121 010 FX 037 121 010 A	026 121 010 CX 026 121 010 V 037 121 010 AX		50 005 151
	mit Gegengehäuse/with backhousing/avec demi-corps/con remate/c задним корпусом					
08.1987→12.1988 Reference	1C 026 121 005 A 026 121 005 H	026 121 005 C 037 121 005 B	026 121 005 E 037 121 005 C	026 121 005 G 068 121 005 A		50 005 148
	ohne Gegengehäuse/without backhousing/sans demi-corps/sin remate/без заднего корпуса					
Ittis 1.7						157
01.1979→12.1988 Reference	WL 026 121 010 026 121 010 F 026 121 010 X 068 121 010 A	026 121 010 C 026 121 010 FV 037 121 010 068 121 010 AX	026 121 010 CV 026 121 010 FX 037 121 010 A	026 121 010 CX 026 121 010 V 037 121 010 AX		50 005 151
	mit Gegengehäuse/with backhousing/avec demi-corps/con remate/c задним корпусом ch 18-G-000 001→					
01.1979→12.1988 Reference	WL, YX 056 121 005 068 121 005 C	056 121 005 A 068 121 005 X	068 121 005	068 121 005 B		50 005 140
	ohne Gegengehäuse/without backhousing/sans demi-corps/sin remate/без заднего корпуса WL: →ch. 18-C-000 887					
01.1979→12.1988 Reference	WL 026 121 005 A 026 121 005 H	026 121 005 C 037 121 005 B	026 121 005 E 037 121 005 C	026 121 005 G 068 121 005 A		50 005 148
	ohne Gegengehäuse/without backhousing/sans demi-corps/sin remate/без заднего корпуса ch 18-G-000 001→					



01.1979→12.1988	WL, YX					
Reference	026 121 010 A 026 121 010 DX 056 121 013 A	026 121 010 AV 055 121 010 068 121 010	026 121 010 D 055 121 010 X	026 121 010 DV 056 121 011		50 005 150
	mit Gegengehäuse/with backhousing/avec demi-corps/con remate/c задним корпусом WL: →ch. 18-C-000 887					
Jetta 1.05						158
08.1986→10.1991	HZ					
Reference	030 115 105 C 030 115 105 E	030 115 105 C 030 115 105 E	030 115 105 D	030 115 105 D		50 005 868
08.1986→10.1991	HZ					
Reference	030 121 004 A 030 121 005 LV 786.023→	030 121 004 B 030 121 005 LX	030 121 005 H	030 121 005 L		50 005 153
08.1986→10.1991	HZ					
Reference	052 121 004 052 121 005 A →786.022	052 121 004 V 052 121 005 AX	052 121 004 X 052 121 019	052 121 005		50 005 142
Jetta 1.1						159
08.1979→02.1984	GG					
Reference	052 121 004 052 121 005 A	052 121 004 V 052 121 005 AX	052 121 004 X 052 121 019	052 121 005		50 005 142
Jetta 1.3						160
08.1985→07.1992	2G, MH, NU					
Reference	030 115 105 C 030 115 105 E	030 115 105 C 030 115 105 E	030 115 105 D	030 115 105 D		50 005 868
01.1989→07.1992	2G					
Reference	030 121 004 A 030 121 005 LV 262.740→	030 121 004 B 030 121 005 LX	030 121 005 H	030 121 005 L		50 005 153
08.1979→07.1992	2G, GF, GS, GT, HK, MH, NU					
Reference	052 121 004 052 121 005 A 2G: →262.739	052 121 004 V 052 121 005 AX	052 121 004 X 052 121 019	052 121 005		50 005 142
Jetta 1.3i						161
08.1985→07.1992	NZ					
Reference	030 115 105 C 030 115 105 E	030 115 105 C 030 115 105 E	030 115 105 D	030 115 105 D		50 005 868

V



08.1985→07.1992	NZ							
Reference	030 121 004 A 030 121 005 LV 200.001→	030 121 004 B 030 121 005 LX	030 121 005 H	030 121 005 L			50 005 153	
08.1985→07.1992	NZ							
Reference	052 121 004 052 121 005 A →200.000	052 121 004 V 052 121 005 AX	052 121 004 X 052 121 019	052 121 005			50 005 142	
Jetta 1.4i 16V							162	
05.2000→04.2001	AXP							
Reference	036 121 005 B 036 121 005 S	036 121 005 E 036 121 008K	036 121 005 Q 036 121 008L	036 121 005 QX 036 121 008LX			50 005 154	
Jetta 1.5							163	
08.1979→02.1984	GH, JB							
Reference	026 121 010 026 121 010 F 026 121 010 X 068 121 010 A	026 121 010 C 026 121 010 FV 037 121 010 068 121 010 AX	026 121 010 CV 026 121 010 FX 037 121 010 A	026 121 010 CX 026 121 010 V 037 121 010 AX			50 005 151	
	mit Gegengehäuse/with backhousing/avec demi-corps/con remate/c задним корпусом ch ...C-630 001→							
08.1979→02.1984	GH, JB							
Reference	056 121 005 068 121 005 C	056 121 005 A 068 121 005 X	068 121 005	068 121 005 B			50 005 140	
	ohne Gegengehäuse/without backhousing/sans demi-corps/sin remate/без заднего корпуса JB: →ch C-630 000 GH: →ch. C-630 000							
08.1979→02.1984	GH, JB							
Reference	027 115 105 049 115 105 A	027 115 105 049 115 105 A	027 115 105 E 055 115 105 D	027 115 105 E 055 115 105 D		50 005 808		
08.1979→02.1984	GH, JB							
Reference	026 121 005 A 026 121 005 H	026 121 005 C 037 121 005 B	026 121 005 E 037 121 005 C	026 121 005 G 068 121 005 A			50 005 148	
	ohne Gegengehäuse/without backhousing/sans demi-corps/sin remate/без заднего корпуса ch ...C-630 001→							
08.1979→02.1984	GH, JB							
Reference	026 121 010 A 026 121 010 DX 056 121 013 A	026 121 010 AV 055 121 010 068 121 010	026 121 010 D 055 121 010 X	026 121 010 DV 056 121 011			50 005 150	
	mit Gegengehäuse/with backhousing/avec demi-corps/con remate/c задним корпусом →ch. C-630 000							
Jetta 1.6							164	
08.1980→10.1991	FR, HM, RF							
Reference	026 121 010 026 121 010 F 026 121 010 X 068 121 010 A	026 121 010 C 026 121 010 FV 037 121 010 068 121 010 AX	026 121 010 CV 026 121 010 FX 037 121 010 A	026 121 010 CX 026 121 010 V 037 121 010 AX			50 005 151	
	mit Gegengehäuse/with backhousing/avec demi-corps/con remate/c задним корпусом FR: ch ...C-630 001→							



08.1979→02.1984 Reference	EJ, FR 056 121 005 068 121 005 C 056 121 005 A 068 121 005 X 068 121 005 068 121 005 B ohne Gegengehäuse/without backhousing/sans demi-corps/sin remate/без заднего корпуса FR: →ch C-630 000			50 005 140
08.1979→10.1991 Reference	EJ, EM, FR, HM, RF 027 115 105 049 115 105 A 027 115 105 049 115 105 A 027 115 105 E 055 115 105 D 027 115 105 E 055 115 105 D		50 005 808	
08.1980→10.1991 Reference	FR, HM, RF 026 121 005 A 026 121 005 H 026 121 005 C 037 121 005 B 026 121 005 E 037 121 005 C 026 121 005 G 068 121 005 A ohne Gegengehäuse/without backhousing/sans demi-corps/sin remate/без заднего корпуса FR: ch ...C-630 001→			50 005 148
08.1979→02.1984 Reference	EJ, FR 026 121 010 A 026 121 010 DX 056 121 013 A 026 121 010 AV 055 121 010 068 121 010 026 121 010 D 055 121 010 X 026 121 010 DV 056 121 011 mit Gegengehäuse/with backhousing/avec demi-corps/con remate/c задним корпусом FR: →ch. C-630 000			50 005 150
Jetta 1.6i				165
08.1979→07.1992 Reference	ABN, EG, EZ, EZA, PN 026 121 010 026 121 010 F 026 121 010 X 068 121 010 A 026 121 010 C 026 121 010 FV 037 121 010 068 121 010 AX 026 121 010 CV 026 121 010 FX 037 121 010 A 026 121 010 CX 026 121 010 V 037 121 010 AX mit Gegengehäuse/with backhousing/avec demi-corps/con remate/c задним корпусом EG: ch ...C-630 001→			50 005 151
08.2005→ Reference	BSE, BSF 06B 121 011 H 06B 121 011 L 06B 121 011 LX 06B 121 011 M			50 005 775
08.1979→07.1982 Reference	EG 056 121 005 068 121 005 C 056 121 005 A 068 121 005 X 068 121 005 068 121 005 B ohne Gegengehäuse/without backhousing/sans demi-corps/sin remate/без заднего корпуса →ch C-630 000			50 005 140
08.1979→07.1992 Reference	ABN, EG, EZ, EZA, PN 027 115 105 049 115 105 A 027 115 105 049 115 105 A 027 115 105 E 055 115 105 D 027 115 105 E 055 115 105 D		50 005 808	
08.1979→07.1992 Reference	ABN, EG, EZ, EZA, PN 026 121 005 A 026 121 005 H 026 121 005 C 037 121 005 B 026 121 005 E 037 121 005 C 026 121 005 G 068 121 005 A ohne Gegengehäuse/without backhousing/sans demi-corps/sin remate/без заднего корпуса EG: ch ...C-630 001→			50 005 148



08.2005→ Reference	BSE, BSF 06A 115 105 06A 115 105 B 06A 115 105 C 06A 115 105 D	06A 115 105 06A 115 105 B 06A 115 105 C 06A 115 105 D	06A 115 105 06A 115 105 B 06A 115 105 C 06A 115 105 D	06A 115 105 06A 115 105 B 06A 115 105 C 06A 115 105 D	 50 005 819
08.1979→07.1982 Reference	EG 026 121 010 A 026 121 010 DX 056 121 013 A mit Gegengehäuse/with backhousing/avec demi-corps/con remate/с задним корпусом →ch. C-630 000	026 121 010 AV 055 121 010 068 121 010	026 121 010 D 055 121 010 X	026 121 010 DV 056 121 011	 50 005 150
Jetta 1.6 SRE				166	
01.2008→ Reference	CCSA 06A 115 105 06A 115 105 B 06A 115 105 C 06A 115 105 D	06A 115 105 06A 115 105 B 06A 115 105 C 06A 115 105 D	06A 115 105 06A 115 105 B 06A 115 105 C 06A 115 105 D	06A 115 105 06A 115 105 B 06A 115 105 C 06A 115 105 D	 50 005 819
Jetta 1.6i 20V				167	
→	AHP				 50 005 131
Jetta 1.6 FSI 16V				168	
09.2005→06.2008 Reference	BLF 03C 121 005 D	03C 121 005 K	03C 121 005 L		 50 005 001 NEW
Jetta 1.6 D				169	
08.1980→07.1992 Reference	CR, JK, JP, ME 026 121 010 026 121 010 F 026 121 010 X 068 121 010 A mit Gegengehäuse/with backhousing/avec demi-corps/con remate/с задним корпусом CR: ch 16-C-630 001→	026 121 010 C 026 121 010 FV 037 121 010 068 121 010 AX	026 121 010 CV 026 121 010 FX 037 121 010 A	026 121 010 CX 026 121 010 V 037 121 010 AX	 50 005 151
08.1980→02.1984 Reference	CR 056 121 005 068 121 005 C ohne Gegengehäuse/without backhousing/sans demi-corps/sin remate/без заднего корпуса →ch. 16-C-630 000	056 121 005 A 068 121 005 X	068 121 005	068 121 005 B	 50 005 140
08.1980→07.1992 Reference	CR, JK, JP, ME 068 115 105 AE 068 115 105 P	068 115 105 AN 068 115 105 S	068 115 105 D	068 115 105 H	 50 005 809
08.1980→07.1992 Reference	CR, JK, JP, ME 026 121 005 A 026 121 005 H ohne Gegengehäuse/without backhousing/sans demi-corps/sin remate/без заднего корпуса CR: ch 16-C-630 001→	026 121 005 C 037 121 005 B	026 121 005 E 037 121 005 C	026 121 005 G 068 121 005 A	 50 005 148



08.1980→02.1984 Reference	CR 027 115 105 A 068 115 105 AG	027 115 105 A 068 115 105 AG	027 115 105 C 068 115 105 Q	027 115 105 C 068 115 105 Q	 50 005 803	
08.1980→02.1984 Reference	CR 026 121 010 A 026 121 010 DX 056 121 013 A	026 121 010 AV 055 121 010 068 121 010	026 121 010 D 055 121 010 X	026 121 010 DV 056 121 011	 50 005 150	
Jetta 1.6 TD						170
08.1982→07.1992 Reference	1V, CY, JR, MF, RA, SB 026 121 010 026 121 010 F 026 121 010 X 068 121 010 A	026 121 010 C 026 121 010 FV 037 121 010 068 121 010 AX	026 121 010 CV 026 121 010 FX 037 121 010 A	026 121 010 CX 026 121 010 V 037 121 010 AX	 50 005 151	
08.1982→02.1984 Reference	CY 056 121 005 068 121 005 C	056 121 005 A 068 121 005 X	068 121 005	068 121 005 B	 50 005 140	
08.1982→10.1991 Reference	CY, JR 068 115 105 AE 068 115 105 P	068 115 105 AN 068 115 105 S	068 115 105 D	068 115 105 H	 50 005 809	
08.1982→07.1992 Reference	1V, CY, JR, MF, RA, SB 026 121 005 A 026 121 005 H	026 121 005 C 037 121 005 B	026 121 005 E 037 121 005 C	026 121 005 G 068 121 005 A	 50 005 148	
12.1983→10.1991 Reference	JR, MF, RA, SB 028 115 105 G JR: 01.1988→	028 115 105 G	068 115 105 BK	068 115 105 BK	 50 005 806	
08.1982→02.1984 Reference	CY 026 121 010 A 026 121 010 DX 056 121 013 A	026 121 010 AV 055 121 010 068 121 010	026 121 010 D 055 121 010 X	026 121 010 DV 056 121 011	 50 005 150	
Jetta 1.7						171
08.1980→02.1984 Reference	EN 026 121 010 026 121 010 F 026 121 010 X 068 121 010 A	026 121 010 C 026 121 010 FV 037 121 010 068 121 010 AX	026 121 010 CV 026 121 010 FX 037 121 010 A	026 121 010 CX 026 121 010 V 037 121 010 AX	 50 005 151	



08.1980→02.1984	EN					
Reference	027 115 105 049 115 105 A	027 115 105 049 115 105 A	027 115 105 E 055 115 105 D	027 115 105 E 055 115 105 D		50 005 808
08.1980→02.1984	EN					
Reference	026 121 005 A 026 121 005 H	026 121 005 C 037 121 005 B	026 121 005 E 037 121 005 C	026 121 005 G 068 121 005 A		50 005 148
	ohne Gegengehäuse/without backhousing/sans demi-corps/sin remate/без заднего корпуса					
Jetta 1.8						172
12.1983→10.1991	GU, GX, RH					
Reference	026 121 010 026 121 010 F 026 121 010 X 068 121 010 A	026 121 010 C 026 121 010 FV 037 121 010 068 121 010 AX	026 121 010 CV 026 121 010 FX 037 121 010 A	026 121 010 CX 026 121 010 V 037 121 010 AX		50 005 151
	mit Gegengehäuse/with backhousing/avec demi-corps/con remate/с задним корпусом					
12.1983→10.1991	GU, GX, RH					
Reference	027 115 105 049 115 105 A	027 115 105 049 115 105 A	027 115 105 E 055 115 105 D	027 115 105 E 055 115 105 D		50 005 808
12.1983→10.1991	GU, GX, RH					
Reference	026 121 005 A 026 121 005 H	026 121 005 C 037 121 005 B	026 121 005 E 037 121 005 C	026 121 005 G 068 121 005 A		50 005 148
	ohne Gegengehäuse/without backhousing/sans demi-corps/sin remate/без заднего корпуса					
Jetta 1.8i						173
08.1982→07.1995	1P, AAM, ACC, DX, EV, GZ, HV, JH, JJ, PB, PF, RD, RG, RP, RV					
Reference	026 121 010 026 121 010 F 026 121 010 X 068 121 010 A	026 121 010 C 026 121 010 FV 037 121 010 068 121 010 AX	026 121 010 CV 026 121 010 FX 037 121 010 A	026 121 010 CX 026 121 010 V 037 121 010 AX		50 005 151
	mit Gegengehäuse/with backhousing/avec demi-corps/con remate/с задним корпусом					
08.1982→10.1991	1P, DX, EV, GZ, HV, JJ, PB, PF, RD, RG, RP, RV					
Reference	027 115 105 049 115 105 A	027 115 105 049 115 105 A	027 115 105 E 055 115 105 D	027 115 105 E 055 115 105 D		50 005 808
08.1982→	1P, AAM, ACC, ADD, DX, EV, GZ, HV, JH, JJ, PB, PF, RD, RG, RP, RV					
Reference	026 121 005 A 026 121 005 H	026 121 005 C 037 121 005 B	026 121 005 E 037 121 005 C	026 121 005 G 068 121 005 A		50 005 148
	ohne Gegengehäuse/without backhousing/sans demi-corps/sin remate/без заднего корпуса					
Jetta 1.8i 16V						174
02.1986→10.1991	KR, PL					
Reference	026 121 010 026 121 010 F 026 121 010 X 068 121 010 A	026 121 010 C 026 121 010 FV 037 121 010 068 121 010 AX	026 121 010 CV 026 121 010 FX 037 121 010 A	026 121 010 CX 026 121 010 V 037 121 010 AX		50 005 151
	mit Gegengehäuse/with backhousing/avec demi-corps/con remate/с задним корпусом					











VOLKSWAGEN



















02.1986→10.1991 Reference	KR, PL 026 121 005 A 026 121 005 C 026 121 005 E 026 121 005 G 026 121 005 H 037 121 005 B 037 121 005 C 068 121 005 A ohne Gegengehäuse/without backhousing/sans demi-corps/sin remate/без заднего корпуса			50 005 148
02.1986→10.1991 Reference	KR, PL 027 115 105 A 027 115 105 A 027 115 105 C 027 115 105 C 068 115 105 AG 068 115 105 AG 068 115 105 Q 068 115 105 Q			50 005 803
Jetta 1.9 TD				175
08.1992→12.1998 Reference	AAZ 026 121 010 026 121 010 C 026 121 010 CV 026 121 010 CX 026 121 010 F 026 121 010 FV 026 121 010 FX 026 121 010 V 026 121 010 X 037 121 010 037 121 010 A 037 121 010 AX 068 121 010 A 068 121 010 AX mit Gegengehäuse/with backhousing/avec demi-corps/con remate/c задним корпусом			50 005 151
08.1992→12.1998 Reference	AAZ 026 121 005 A 026 121 005 C 026 121 005 E 026 121 005 G 026 121 005 H 037 121 005 B 037 121 005 C 068 121 005 A ohne Gegengehäuse/without backhousing/sans demi-corps/sin remate/без заднего корпуса			50 005 148
Jetta 1.9 TDI				176
08.1996→ Reference	AHU 026 121 010 026 121 010 C 026 121 010 CV 026 121 010 CX 026 121 010 F 026 121 010 FV 026 121 010 FX 026 121 010 V 026 121 010 X 037 121 010 037 121 010 A 037 121 010 AX 068 121 010 A 068 121 010 AX mit Gegengehäuse/with backhousing/avec demi-corps/con remate/c задним корпусом			50 005 151
11.1998→ Reference	ALH 038 121 011 038 121 011 A 038 121 011 AV 038 121 011AX			50 005 132
08.1996→ Reference	AHU 026 121 005 A 026 121 005 C 026 121 005 E 026 121 005 G 026 121 005 H 037 121 005 B 037 121 005 C 068 121 005 A ohne Gegengehäuse/without backhousing/sans demi-corps/sin remate/без заднего корпуса			50 005 148
01.2005→ Reference	BKC, BLS, BRM, BXE 045 121 011B 045 121 011F 045 121 011H 045 121 011HX			50 005 556
Jetta 1.9 SDI				177
→ Reference	AQM 038 121 011 038 121 011 A 038 121 011 AV 038 121 011AX			50 005 132

V





Jetta 2.0i							178
11.1998→	AEG, APK, AZG						50 005 131
Jetta 2.0 FSI 16V							179
08.2005→06.2008	BLR, BLY, BVY, BVZ						50 005 775
Reference	06B 121 011 H	06B 121 011 L	06B 121 011 LX	06B 121 011 M			
Jetta 2.0 TDI 16V							180
08.2005→06.2008	AZV, BKD						50 005 554
Reference	038 121 001 C 038 121 011 J	038 121 011 C 038 121 011 K	038 121 011 D 038 121 011 KX	038 121 011 G			
Jetta 2.8i VR6							181
07.1993→	AAA						50 005 165
Reference	021 121 004	021 121 004 A					
Jetta 2.8i VR6 24V							182
11.1998→	AFP						50 005 165
Reference	021 121 004	021 121 004 A					
LT 28							183
05.1996→11.2001	AGL						50 005 164
Reference	00A 121 010						
LT 28 D							184
08.1978→07.1992	1S, CP, DW						50 005 146
Reference	069 121 004	069 121 004 V	069 121 004 X	069 121 005 D			
08.1992→12.1995	ACT						50 005 555
Reference	074 121 004 B 074 121 005MX	074 121 005 N	074 121 005 NX	074 121 005 M			
		20 Zähne/teeth/dientes/dents/зубьев					





							
08.1992→12.1995	ACT						
Reference	074 121 004	074 121 004 A	074 121 004 V	074 121 004 X			50 005 551
	18 Zähne/teeth/dientes/dents/зубьев						
LT 28 SDI							185
05.1996→04.2001	AGX						
Reference	074 121 004 B	074 121 005 N	074 121 005 NX	074 121 005M			50 005 555
	20 Zähne/teeth/dientes/dents/зубьев						
05.1996→04.2001	AGX						
Reference	074 121 004	074 121 004 A	074 121 004 V	074 121 004 X			50 005 551
	18 Zähne/teeth/dientes/dents/зубьев						
LT 28 TD							186
12.1982→07.1992	1G, DV						
Reference	069 121 004	069 121 004 V	069 121 004 X	069 121 005 D			50 005 146
08.1991→12.1995	ACL						
Reference	074 121 004 B	074 121 005 N	074 121 005 NX	074 121 005M			50 005 555
	20 Zähne/teeth/dientes/dents/зубьев						
LT 28 TDI							187
05.1996→	AHD, ANJ, APA, AVR, BBE, BBF, BJK, B JL, BJM						
Reference	074 121 004 B	074 121 005 N	074 121 005 NX	074 121 005M			50 005 555
	20 Zähne/teeth/dientes/dents/зубьев						
05.1996→07.2006	AHD, ANJ, APA, AVR, BBE, BBF						
Reference	074 121 004	074 121 004 A	074 121 004 V	074 121 004 X			50 005 551
	18 Zähne/teeth/dientes/dents/зубьев						
07.1997→01.2002	AGK, ATA						
Reference	062 121 010						50 005 781
LT 31							188
05.1996→11.2001	AGL						
Reference	00A 121 010						50 005 164

V

**LT 31 D****189**

08.1978→07.1992	1S, CP, DW							
Reference	069 121 004	069 121 004 V	069 121 004 X	069 121 005 D				50 005 146
08.1992→12.1995	ACT							
Reference	074 121 004 B 074 121 005MX 20 Zähne/teeth/dientes/dents/зубьев	074 121 005 N	074 121 005 NX	074 121 005M				50 005 555
08.1992→12.1995	ACT							
Reference	074 121 004 18 Zähne/teeth/dientes/dents/зубьев	074 121 004 A	074 121 004 V	074 121 004 X				50 005 551

LT 31 TD**190**

12.1982→07.1992	1G, DV							
Reference	069 121 004	069 121 004 V	069 121 004 X	069 121 005 D				50 005 146
08.1991→12.1995	ACL							
Reference	074 121 004 B 074 121 005MX 20 Zähne/teeth/dientes/dents/зубьев	074 121 005 N	074 121 005 NX	074 121 005M				50 005 555



LT 33 D**191**

08.1978→07.1992	1S, CP							
Reference	069 121 004	069 121 004 V	069 121 004 X	069 121 005 D				50 005 146

LT 35**192**

05.1996→11.2001	AGL							
Reference	00A 121 010							50 005 164

LT 35 D**193**

08.1978→07.1992	1S, CP, DW							
Reference	069 121 004	069 121 004 V	069 121 004 X	069 121 005 D				50 005 146
08.1992→12.1995	ACT							
Reference	074 121 004 B 074 121 005MX 20 Zähne/teeth/dientes/dents/зубьев	074 121 005 N	074 121 005 NX	074 121 005M				50 005 555



V





08.1992→12.1995	ACT							
Reference	074 121 004	074 121 004 A	074 121 004 V	074 121 004 X			50 005 551	
	18 Zähne/teeth/dientes/dents/зубьев							
LT 35 SDI							194	
05.1996→04.2001	AGX							
Reference	074 121 004 B	074 121 005 N	074 121 005 NX	074 121 005M			50 005 555	
	20 Zähne/teeth/dientes/dents/зубьев							
05.1996→04.2001	AGX							
Reference	074 121 004	074 121 004 A	074 121 004 V	074 121 004 X			50 005 551	
	18 Zähne/teeth/dientes/dents/зубьев							
LT 35 TD							195	
12.1982→07.1992	1G, DV							
Reference	069 121 004	069 121 004 V	069 121 004 X	069 121 005 D			50 005 146	
08.1991→12.1995	ACL							
Reference	074 121 004 B	074 121 005 N	074 121 005 NX	074 121 005M			50 005 555	
	20 Zähne/teeth/dientes/dents/зубьев							
LT 35 TDI							196	
05.1996→	AHD, ANJ, APA, AVR, BBE, BBF, BJK, B JL, BJM							
Reference	074 121 004 B	074 121 005 N	074 121 005 NX	074 121 005M			50 005 555	
	20 Zähne/teeth/dientes/dents/зубьев							
05.1996→07.2006	AHD, ANJ, APA, AVR, BBE, BBF							
Reference	074 121 004	074 121 004 A	074 121 004 V	074 121 004 X			50 005 551	
	18 Zähne/teeth/dientes/dents/зубьев							
07.1997→01.2002	AGK, ATA							
Reference	062 121 010						50 005 781	
LT 40							197	
05.1996→11.2001	AGL							
Reference	00A 121 010						50 005 164	

V

**LT 40 D****198**

08.1978→07.1992	1S, CP, DW						
Reference	069 121 004	069 121 004 V	069 121 004 X	069 121 005 D			50 005 146
08.1992→12.1995	ACT						
Reference	074 121 004 B 074 121 005MX 20 Zähne/teeth/dientes/dents/зубьев	074 121 005 N	074 121 005 NX	074 121 005M			50 005 555
08.1992→12.1995	ACT						
Reference	074 121 004 18 Zähne/teeth/dientes/dents/зубьев	074 121 004 A	074 121 004 V	074 121 004 X			50 005 551



LT 40 TD**199**

12.1982→07.1992	1G, DV						
Reference	069 121 004	069 121 004 V	069 121 004 X	069 121 005 D			50 005 146
08.1991→12.1995	ACL						
Reference	074 121 004 B 074 121 005MX 20 Zähne/teeth/dientes/dents/зубьев	074 121 005 N	074 121 005 NX	074 121 005M			50 005 555

LT 45**200**

05.1996→11.2001	AGL						
Reference	00A 121 010						50 005 164

LT 45 D**201**

08.1978→07.1992	1S, CP, DW						
Reference	069 121 004	069 121 004 V	069 121 004 X	069 121 005 D			50 005 146
08.1992→12.1995	ACT						
Reference	074 121 004 B 074 121 005MX 20 Zähne/teeth/dientes/dents/зубьев	074 121 005 N	074 121 005 NX	074 121 005M			50 005 555
08.1992→12.1995	ACT						
Reference	074 121 004 18 Zähne/teeth/dientes/dents/зубьев	074 121 004 A	074 121 004 V	074 121 004 X			50 005 551

V

**LT 45 TD****202**

12.1982→07.1992 Reference	1G, DV 069 121 004 069 121 004 V 069 121 004 X 069 121 005 D			50 005 146
08.1991→12.1995 Reference	ACL 074 121 004 B 074 121 005 N 074 121 005 NX 074 121 005M 20 Zähne/teeth/dientes/dents/зубьев			50 005 555

LT 46**203**

05.1996→11.2001 Reference	AGL 00A 121 010			50 005 164
------------------------------	--------------------	--	--	------------

LT 46 TDI**204**

05.1996→ Reference	AHD, APA, AVR, BBE, BBF, BJK, B JL, BJM 074 121 004 B 074 121 005 N 074 121 005 NX 074 121 005M 20 Zähne/teeth/dientes/dents/зубьев			50 005 555
05.1996→07.2006 Reference	AHD, APA, AVR, BBE, BBF 074 121 004 074 121 004 A 074 121 004 V 074 121 004 X 18 Zähne/teeth/dientes/dents/зубьев			50 005 551
07.1997→01.2002 Reference	AGK, ATA 062 121 010			50 005 781

LT 50**205**













05.1996→11.2001 Reference	AGL 00A 121 010			50 005 164
------------------------------	--------------------	--	--	------------

LT 50 D**206**









08.1978→07.1992 Reference	1S, CP, DW 069 121 004 069 121 004 V 069 121 004 X 069 121 005 D			50 005 146
08.1992→12.1995 Reference	ACT 074 121 004 B 074 121 005 N 074 121 005 NX 074 121 005M 20 Zähne/teeth/dientes/dents/зубьев			50 005 555

V



				
08.1992→12.1995 Reference	ACT 074 121 004 074 121 004 A 074 121 004 V 074 121 004 X 18 Zähne/teeth/dientes/dents/зубьев			50 005 551
LT 50 TD 207				
12.1982→07.1992 Reference	1G, DV 069 121 004 069 121 004 V 069 121 004 X 069 121 005 D			50 005 146
08.1991→12.1995 Reference	ACL 074 121 004 B 074 121 005 N 074 121 005 NX 074 121 005M 074 121 005MX 20 Zähne/teeth/dientes/dents/зубьев			50 005 555
LT 55 208				
05.1996→11.2001 Reference	AGL 00A 121 010			50 005 164
LT 55 TD 209				
12.1982→07.1992 Reference	1G, DV 069 121 004 069 121 004 V 069 121 004 X 069 121 005 D			50 005 146
08.1991→12.1995 Reference	ACL 074 121 004 B 074 121 005 N 074 121 005 NX 074 121 005M 074 121 005MX 20 Zähne/teeth/dientes/dents/зубьев			50 005 555
Lupo 1.0i 210				
10.1998→05.2000 Reference	AHT 047 121 013 J			50 005 772
10.1998→07.2005 Reference	AER, ALD, ALL, ANV, AUC 030 121 005 S 030 121 008 A 030 121 008 C 030 121 008 CX 037 121 008 C			50 005 137
10.1998→05.2000 Reference	AER, ALL 036 115 105 B 036 115 105 B 036 115 105 B 036 115 105 B 036 115 105 D 036 115 105 D 036 115 105 D 036 115 105 D			50 005 844



Lupo 1.2 TDI							211
06.1999→07.2005	ANY, AYZ						
Reference	045 121 011B	045 121 011F	045 121 011H	045 121 011HX			50 005 556
Lupo 1.4i							212
09.2000→07.2005	AUD						
Reference	030 121 005 S 037 121 008 C	030 121 008 A	030 121 008 C	030 121 008 CX			50 005 137
Lupo 1.4i 16V							213
10.1998→07.2005	AFK, AHW, AKQ, APE, AQQ, AUA, AUB, BBY						
Reference	036 121 005 B 036 121 005 S	036 121 005 E 036 121 008K	036 121 005 Q 036 121 008L	036 121 005 QX 036 121 008LX			50 005 154
10.1998→07.2005	AFK, AHW, AKQ, APE, AQQ, AUA, AUB, BBY						
Reference	036 115 105 B 036 115 105 D	036 115 105 B 036 115 105 D	036 115 105 B 036 115 105 D	036 115 105 B 036 115 105 D		50 005 844	
Lupo 1.4 FSI 16V							214
09.2000→11.2003	ARR						
Reference	036 115 105 B 036 115 105 D	036 115 105 B 036 115 105 D	036 115 105 B 036 115 105 D	036 115 105 B 036 115 105 D		50 005 844	
Lupo 1.4 TDI							215
05.1999→07.2005	AMF						
Reference	045 121 011B →6X-2-100 000	045 121 011F	045 121 011H	045 121 011HX			50 005 556
Lupo 1.6i 16V							216
06.2000→07.2005	AVY						
Reference	036 121 005 F	036 121 005 P	036 121 008 G	036 121 008 GX			50 005 754
06.2000→07.2005	AVY						
Reference	036 115 105 B 036 115 105 D	036 115 105 B 036 115 105 D	036 115 105 B 036 115 105 D	036 115 105 B 036 115 105 D		50 005 844	
Lupo 1.7 SDI							217
10.1998→07.2005	AKU						
Reference	028 121 004	028 121 004 V	028 121 004 X				50 005 158

V



10.1998→07.2005 Reference	AKU 028 115 105 L			
			50 005 807	
Maxi 1.6i				218
11.2007→05.2008 Reference	BSE, BSF 06B 121 011 H 06B 121 011 L 06B 121 011 LX 06B 121 011 M			
			50 005 775	
Maxi 1.9 TDI				219
11.2007→05.2008 Reference	BJB, BLS 045 121 011 B 045 121 011 F 045 121 011 H 045 121 011 HX			
			50 005 556	
Maxi 2.0i EcoFuel				220
04.2006→05.2008	BSX			
			50 005 131	
New Beetle 1.4i 16V				221
08.2001→ Reference	BCA 036 121 005 B 036 121 005 E 036 121 005 Q 036 121 005 QX 036 121 005 S 036 121 008K 036 121 008L 036 121 008LX			
			50 005 154	
New Beetle 1.6i				222
11.1999→ Reference	AWH, AYD, BFS 06A 115 105 06A 115 105 06A 115 105 06A 115 105 06A 115 105 B 06A 115 105 B 06A 115 105 B 06A 115 105 B 06A 115 105 C 06A 115 105 C 06A 115 105 C 06A 115 105 C 06A 115 105 D 06A 115 105 D 06A 115 105 D 06A 115 105 D			50 005 819
11.1999→	AWH, AYD			50 005 130
New Beetle 1.8i T 20V				223
01.1998→ Reference	APH, AVC, AWP, AWU, AWW, BKF, BNU 06A 115 105 06A 115 105 06A 115 105 06A 115 105 06A 115 105 B 06A 115 105 B 06A 115 105 B 06A 115 105 B 06A 115 105 C 06A 115 105 C 06A 115 105 C 06A 115 105 C 06A 115 105 D 06A 115 105 D 06A 115 105 D 06A 115 105 D			50 005 819
01.1998→05.2001	AGU, APH			50 005 131



New Beetle 1.9 TDI				224		
01.1998→07.2005 Reference	ALH 038 121 011	038 121 011 A	038 121 011 AV	038 121 011AX		50 005 132
06.2003→ Reference 	AXR, BEW, BSW 038 121 011 G BSW: 1C-6-499 000→ BEW: →1C-6-499 000 / 9C-6-599 000					50 005 783
01.1998→ Reference	ALH, ATD, AXR, BEW, BSW 06A 115 105 06A 115 105 B 06A 115 105 C 06A 115 105 D	06A 115 105 06A 115 105 B 06A 115 105 C 06A 115 105 D	06A 115 105 06A 115 105 B 06A 115 105 C 06A 115 105 D	06A 115 105 06A 115 105 B 06A 115 105 C 06A 115 105 D		50 005 819
03.2000→ Reference	ATD 038 121 001 C 038 121 011J	038 121 011 C 038 121 011K	038 121 011 D 038 121 011KX	038 121 011G		50 005 554
New Beetle 2.0i				225		
01.1998→ Reference	AEG, APK, AQY, AVH, AZG, BEJ, BER, BEV, BHP, CBPA 06A 115 105 06A 115 105 B 06A 115 105 C 06A 115 105 D	06A 115 105 06A 115 105 B 06A 115 105 C 06A 115 105 D	06A 115 105 06A 115 105 B 06A 115 105 C 06A 115 105 D	06A 115 105 06A 115 105 B 06A 115 105 C 06A 115 105 D		50 005 819
01.1998→	AEG, APK, AQY, AZG, AZJ					50 005 131
New Beetle 2.3i 25V				226		
10.2000→ Reference	AQN 066 121 011 C	071 121 005				50 005 159
New Beetle 3.2i 24V				227		
10.2000→05.2001 Reference	AXJ 022 121 011					50 005 008 <small>NEW</small>
Parati 1.6i				228		
08.1995→05.2002 Reference 	AP 504, AP 505, AP 521, AP 540, AP 541, AP 542 026 115 105 A	026 115 105 A				50 005 822
Parati 1.8i				229		
08.1995→05.2002 Reference 	AP 522, AP 543 026 115 105 A	026 115 105 A				50 005 822

V



Parati 1.9 D						230	
08.1998→03.2006	1Y						
Reference	026 121 010	026 121 010 C	026 121 010 CV	026 121 010 CX		50 005 151	
	026 121 010 F	026 121 010 FV	026 121 010 FX	026 121 010 V			
	026 121 010 X	037 121 010	037 121 010 A	037 121 010 AX			
	068 121 010 A	068 121 010 AX					
	mit Gegengehäuse/with backhousing/avec demi-corps/con remate/c задним корпусом						
08.1998→03.2006	1Y						
Reference	026 121 005 A	026 121 005 C	026 121 005 E	026 121 005 G		50 005 148	
	026 121 005 H	037 121 005 B	037 121 005 C	068 121 005 A			
	ohne Gegengehäuse/without backhousing/sans demi-corps/sin remate/без заднего корпуса						
Parati 2.0i						231	
08.1995→05.2002	AP 528, AP 529, AP 546, AP 547						
Reference	026 115 105 A	026 115 105 A				50 005 822	
Parati 2.0i 16V						232	
02.1996→07.2000	AP 112						
Reference	053 115 105 B	053 115 105 B	053 115 105 C	053 115 105 C		50 005 845	
Passat 1.3						233	
08.1983→07.1987	EP						
Reference	026 121 010	026 121 010 C	026 121 010 CV	026 121 010 CX		50 005 151	
	026 121 010 F	026 121 010 FV	026 121 010 FX	026 121 010 V			
	026 121 010 X	037 121 010	037 121 010 A	037 121 010 AX			
	068 121 010 A	068 121 010 AX					
	mit Gegengehäuse/with backhousing/avec demi-corps/con remate/c задним корпусом						
05.1973→01.1978	ZA, ZF						
Reference	056 121 005	056 121 005 A	068 121 005	068 121 005 B		50 005 140	
	068 121 005 C	068 121 005 X					
	ohne Gegengehäuse/without backhousing/sans demi-corps/sin remate/без заднего корпуса						
08.1983→07.1987	EP, EU						
Reference	026 115 105	026 115 105	026 115 105 B	026 115 105 B		50 005 813	
	049 115 105 H	049 115 105 H	056 115 105 A	056 115 105 A			
08.1983→07.1987	EP						
Reference	026 121 005 A	026 121 005 C	026 121 005 E	026 121 005 G		50 005 148	
	026 121 005 H	037 121 005 B	037 121 005 C	068 121 005 A			
	ohne Gegengehäuse/without backhousing/sans demi-corps/sin remate/без заднего корпуса						
01.1978→07.1984	EU, FY, FZ						
Reference	052 121 004	052 121 004 V	052 121 004 X	052 121 005		50 005 142	
	052 121 005 A	052 121 005 AX	052 121 019				



05.1973→01.1978	ZA, ZF			
Reference	026 121 010 A 026 121 010 AV 026 121 010 D 026 121 010 DV 026 121 010 DX 055 121 010 055 121 010 X 056 121 011 056 121 013 A 068 121 010			50 005 150
	mit Gegengehäuse/with backhousing/avec demi-corps/con remate/c задним корпусом			
Passat 1.5				234
→	FF, FH, FL, YJ, ZB, ZC			
Reference	056 121 005 056 121 005 A 068 121 005 068 121 005 B 068 121 005 C 068 121 005 X			50 005 140
	ohne Gegengehäuse/without backhousing/sans demi-corps/sin remate/без заднего корпуса			
→	FF, FH, FL, YJ, ZB, ZC			
Reference	026 121 010 A 026 121 010 AV 026 121 010 D 026 121 010 DV 026 121 010 DX 055 121 010 055 121 010 X 056 121 011 056 121 013 A 068 121 010			50 005 150
	mit Gegengehäuse/with backhousing/avec demi-corps/con remate/c задним корпусом			
Passat 1.5 D				235
08.1977→07.1980	CK			
Reference	056 121 005 056 121 005 A 068 121 005 068 121 005 B 068 121 005 C 068 121 005 X			50 005 140
	ohne Gegengehäuse/without backhousing/sans demi-corps/sin remate/без заднего корпуса			
08.1977→07.1980	CK			
Reference	026 121 010 A 026 121 010 AV 026 121 010 D 026 121 010 DV 026 121 010 DX 055 121 010 055 121 010 X 056 121 011 056 121 013 A 068 121 010			50 005 150
	mit Gegengehäuse/with backhousing/avec demi-corps/con remate/c задним корпусом			
08.1977→07.1980	CK			
Reference	068 115 105 AC 068 115 105 AC 068 115 105 AD 068 115 105 AD 068 115 105 AP 068 115 105 AP 068 115 105 N 068 115 105 N 068 115 105 R 068 115 105 R 233 272→		50 005 804	
Passat 1.6				236
09.1975→07.1989	DT, DTA, JU, PP, RF, WP, WV, WVA, WY, YN, YP, YY			
Reference	026 121 010 026 121 010 C 026 121 010 CV 026 121 010 CX 026 121 010 F 026 121 010 FV 026 121 010 FX 026 121 010 V 026 121 010 X 037 121 010 037 121 010 A 037 121 010 AX 068 121 010 A 068 121 010 AX			50 005 151
	mit Gegengehäuse/with backhousing/avec demi-corps/con remate/c задним корпусом WP, WY, YN, YP, YY: ch 32-B-100 001→ WV, WVA: ch 32-E-100 001→			
09.1975→07.1983	WP, WV, WVA, WY, WZ, YG, YH, YN, YP, YY			
Reference	056 121 005 056 121 005 A 068 121 005 068 121 005 B 068 121 005 C 068 121 005 X			50 005 140
	ohne Gegengehäuse/without backhousing/sans demi-corps/sin remate/без заднего корпуса WP, WY, YN, YP, YY: →ch. 32-B-100 000 WV, WVA: →ch. 32-E-100 000			
04.1988→07.1989	RF			
Reference	027 115 105 027 115 105 027 115 105 E 027 115 105 E 049 115 105 A 049 115 105 A 055 115 105 D 055 115 105 D		50 005 808	

V



09.1975→03.1988 Reference	DT, DTA, JU, PP, WP, WV, WY, YP 026 115 105 026 115 105 026 115 105 B 026 115 105 B 049 115 105 H 049 115 105 H 056 115 105 A 056 115 105 A			50 005 813
09.1975→07.1989 Reference	DT, DTA, JU, PP, RF, WP, WV, WVA, WY, YN, YP, YY 026 121 005 A 026 121 005 C 026 121 005 E 026 121 005 G 026 121 005 H 037 121 005 B 037 121 005 C 068 121 005 A ohne Gegengehäuse/without backhousing/sans demi-corps/sin remate/без заднего корпуса WP, WY, YN, YP, YY: ch 32-B-100 001→ WV, WVA: ch 32-E-100 001→			50 005 148
01.1997→10.1997 Reference	ADP 050 121 010 050 121 010 A 050 121 010 C 050 121 010 CX mit Gegengehäuse/with backhousing/avec demi-corps/con remate/с задним корпусом			50 005 156
10.1996→08.2000 Reference	AHL 06A 115 105 06A 115 105 06A 115 105 06A 115 105 06A 115 105 B 06A 115 105 B 06A 115 105 B 06A 115 105 B 06A 115 105 C 06A 115 105 C 06A 115 105 C 06A 115 105 C 06A 115 105 D 06A 115 105 D 06A 115 105 D 06A 115 105 D 3B-V-000 001→			50 005 819
01.1997→10.1997 Reference	ADP 026 121 005 F 026 121 005 FV 026 121 005 FX 026 121 005 K 026 121 005 L ohne Gegengehäuse/without backhousing/sans demi-corps/sin remate/без заднего корпуса			50 005 155
10.1996→08.2000 Reference	AHL 06A 115 105 06A 115 105 06A 115 105 06A 115 105 06A 115 105 B 06A 115 105 B 06A 115 105 B 06A 115 105 B 06A 115 105 C 06A 115 105 C 06A 115 105 C 06A 115 105 C 06A 115 105 D 06A 115 105 D 06A 115 105 D 06A 115 105 D 3B-V-000 001→			50 005 130
09.1975→07.1983 Reference	WP, WV, WVA, WY, WZ, YG, YH, YN, YP, YY 026 121 010 A 026 121 010 AV 026 121 010 D 026 121 010 DV 026 121 010 DX 055 121 010 055 121 010 X 056 121 011 056 121 013 A 068 121 010 mit Gegengehäuse/with backhousing/avec demi-corps/con remate/с задним корпусом WP, WY, YN, YP, YY: →ch. 32-B-100 000 WV, WVA: →ch. 32-E-100 000			50 005 150
Passat 1.6i				237
08.1986→12.1996 Reference	1F, ABN, AEK, AFT, EZ, RL 026 121 010 026 121 010 C 026 121 010 CV 026 121 010 CX 026 121 010 F 026 121 010 FV 026 121 010 FX 026 121 010 V 026 121 010 X 037 121 010 037 121 010 A 037 121 010 AX 068 121 010 A 068 121 010 AX mit Gegengehäuse/with backhousing/avec demi-corps/con remate/с задним корпусом			50 005 151
05.2005→ Reference	BSE, BSF 06B 121 011 H 06B 121 011 L 06B 121 011 LX 06B 121 011 M			50 005 775



02.1976→07.1980 Reference	FS, YS 056 121 005 068 121 005 C 056 121 005 A 068 121 005 X ohne Gegengehäuse/without backhousing/sans demi-corps/sin remate/без заднего корпуса	068 121 005 068 121 005 B		50 005 140
04.1988→12.1996 Reference	1F, ABN, AEK, AFT, EZ 027 115 105 049 115 105 A 027 115 105 049 115 105 A 027 115 105 E 055 115 105 D 027 115 105 E 055 115 105 D			50 005 808
02.1979→03.1988 Reference	RL, YS 026 115 105 049 115 105 H 026 115 105 049 115 105 H 026 115 105 B 056 115 105 A 026 115 105 B 056 115 105 A			50 005 813
08.1986→12.1996 Reference	1F, ABN, AEK, AFT, EZ, RL 026 121 005 A 026 121 005 H 026 121 005 C 037 121 005 B 026 121 005 E 037 121 005 C 026 121 005 G 068 121 005 A ohne Gegengehäuse/without backhousing/sans demi-corps/sin remate/без заднего корпуса			50 005 148
01.1999→ Reference	ALZ, ANA, ARM, BSE, BSF 06A 115 105 06A 115 105 B 06A 115 105 C 06A 115 105 D 06A 115 105 06A 115 105 B 06A 115 105 C 06A 115 105 D ANA, ARM: 3B-V-000 001→	06A 115 105 06A 115 105 B 06A 115 105 C 06A 115 105 D		50 005 819
01.1999→05.2005	ALZ, ANA, ARM			50 005 130
02.1976→07.1980 Reference	FS, YS 026 121 010 A 026 121 010 DX 056 121 013 A 026 121 010 AV 055 121 010 068 121 010 026 121 010 D 055 121 010 X 026 121 010 DV 056 121 011 mit Gegengehäuse/with backhousing/avec demi-corps/con remate/c задним корпусом			50 005 150
Passat 1.6 FSI 16V				238
03.2005→ Reference	BLF 03C 121 005 D 03C 121 005 K 03C 121 005 L			50 005 001 NEW
Passat 1.6 D				239
08.1980→03.1988 Reference	CR, JK 026 121 010 026 121 010 F 026 121 010 X 068 121 010 A 026 121 010 C 026 121 010 FV 037 121 010 068 121 010 AX 026 121 010 CV 026 121 010 FX 037 121 010 A 026 121 010 CX 026 121 010 V 037 121 010 AX mit Gegengehäuse/with backhousing/avec demi-corps/con remate/c задним корпусом CR: ch 32-B-100 001→			50 005 151

V



08.1980→07.1982	CR			
Reference	056 121 005 068 121 005 C	056 121 005 A 068 121 005 X	068 121 005	068 121 005 B
	ohne Gegengehäuse/without backhousing/sans demi-corps/sin remate/без заднего корпуса →ch. 32-B-100 000			
				50 005 140
08.1980→03.1988	CR, JK			
Reference	026 121 005 A 026 121 005 H	026 121 005 C 037 121 005 B	026 121 005 E 037 121 005 C	026 121 005 G 068 121 005 A
	ohne Gegengehäuse/without backhousing/sans demi-corps/sin remate/без заднего корпуса CR: ch 32-B-100 001→			
				50 005 148
08.1980→07.1982	CR			
Reference	026 121 010 A 026 121 010 DX 056 121 013 A	026 121 010 AV 055 121 010	026 121 010 D 055 121 010 X	026 121 010 DV 056 121 011
	mit Gegengehäuse/with backhousing/avec demi-corps/con remate/с задним корпусом →ch. 32-B-100 000			
				50 005 150
08.1980→03.1988	CR, JK			
Reference	068 115 105 AC 068 115 105 AP 068 115 105 R	068 115 105 AC 068 115 105 AP 068 115 105 R	068 115 105 AD 068 115 105 N	068 115 105 AD 068 115 105 N
				50 005 804
Passat 1.6 TD				240
12.1981→10.1993	CY, RA, SB			
Reference	026 121 010 026 121 010 F 026 121 010 X 068 121 010 A	026 121 010 C 026 121 010 FV 037 121 010 068 121 010 AX	026 121 010 CV 026 121 010 FX 037 121 010 A	026 121 010 CX 026 121 010 V 037 121 010 AX
	mit Gegengehäuse/with backhousing/avec demi-corps/con remate/с задним корпусом CY: ch 32-E-100 001→			
				50 005 151
12.1981→03.1988	CY			
Reference	056 121 005 068 121 005 C	056 121 005 A 068 121 005 X	068 121 005	068 121 005 B
	ohne Gegengehäuse/without backhousing/sans demi-corps/sin remate/без заднего корпуса →ch. 32-E-100 000			
				50 005 140
12.1981→10.1993	CY, RA, SB			
Reference	026 121 005 A 026 121 005 H	026 121 005 C 037 121 005 B	026 121 005 E 037 121 005 C	026 121 005 G 068 121 005 A
	ohne Gegengehäuse/without backhousing/sans demi-corps/sin remate/без заднего корпуса CY: ch 32-E-100 001→			
				50 005 148
08.1988→10.1993	RA, SB			
Reference	028 115 105 G	028 115 105 G	068 115 105 BK	068 115 105 BK
	SB: 31-J-000 001→			
				50 005 806
12.1981→03.1988	CY			
Reference	026 121 010 A 026 121 010 DX 056 121 013 A	026 121 010 AV 055 121 010 068 121 010	026 121 010 D 055 121 010 X	026 121 010 DV 056 121 011
	mit Gegengehäuse/with backhousing/avec demi-corps/con remate/с задним корпусом →ch. 32-E-100 000			
				50 005 150



12.1981→03.1988	CY			
Reference	068 115 105 AC 068 115 105 AP 068 115 105 R	068 115 105 AC 068 115 105 AP 068 115 105 R	068 115 105 AD 068 115 105 N	068 115 105 AD 068 115 105 N
				50 005 804
Passat 1.8				241
01.1983→07.1988	DS, JN, JV, RM			
Reference	026 121 010 026 121 010 F 026 121 010 X 068 121 010 A	026 121 010 C 026 121 010 FV 037 121 010 068 121 010 AX	026 121 010 CV 026 121 010 FX 037 121 010 A	026 121 010 CX 026 121 010 V 037 121 010 AX
	mit Gegengehäuse/with backhousing/avec demi-corps/con remate/c задним корпусом			50 005 151
01.1983→07.1988	DS, JN, JV, RM			
Reference	026 115 105 049 115 105 H	026 115 105 049 115 105 H	026 115 105 B 056 115 105 A	026 115 105 B 056 115 105 A
				50 005 813
01.1983→07.1988	DS, JN, JV, RM			
Reference	026 121 005 A 026 121 005 H	026 121 005 C 037 121 005 B	026 121 005 E 037 121 005 C	026 121 005 G 068 121 005 A
	ohne Gegengehäuse/without backhousing/sans demi-corps/sin remate/без заднего корпуса			50 005 148
Passat 1.8i				242
12.1983→12.1996	AAM, ABS, ADZ, DZ, PB, PF, RP			
Reference	026 121 010 026 121 010 F 026 121 010 X 068 121 010 A	026 121 010 C 026 121 010 FV 037 121 010 068 121 010 AX	026 121 010 CV 026 121 010 FX 037 121 010 A	026 121 010 CX 026 121 010 V 037 121 010 AX
	mit Gegengehäuse/with backhousing/avec demi-corps/con remate/c задним корпусом			50 005 151
04.1988→12.1996	AAM, ABS, ADZ, PB, PF, RP			
Reference	027 115 105 049 115 105 A	027 115 105 049 115 105 A	027 115 105 E 055 115 105 D	027 115 105 E 055 115 105 D
				50 005 808
12.1983→07.1984	DZ			
Reference	026 115 105 049 115 105 H	026 115 105 049 115 105 H	026 115 105 B 056 115 105 A	026 115 105 B 056 115 105 A
				50 005 813
12.1983→12.1996	AAM, ABS, ADZ, DZ, PB, PF, RP			
Reference	026 121 005 A 026 121 005 H	026 121 005 C 037 121 005 B	026 121 005 E 037 121 005 C	026 121 005 G 068 121 005 A
	ohne Gegengehäuse/without backhousing/sans demi-corps/sin remate/без заднего корпуса			50 005 148
01.1997→04.2000	AFY			
Reference	050 121 010	050 121 010 A	050 121 010 C	050 121 010 CX
	mit Gegengehäuse/with backhousing/avec demi-corps/con remate/c задним корпусом			50 005 156
01.1997→04.2000	AFY			
Reference	026 121 005 F 026 121 005 L	026 121 005 FV	026 121 005 FX	026 121 005 K
	ohne Gegengehäuse/without backhousing/sans demi-corps/sin remate/без заднего корпуса			50 005 155

**Passat 1.8i 16V****243**

04.1988→07.1992	KR						
Reference	026 121 010 026 121 010 F 026 121 010 X 068 121 010 A	026 121 010 C 026 121 010 FV 037 121 010 068 121 010 AX	026 121 010 CV 026 121 010 FX 037 121 010 A	026 121 010 CX 026 121 010 V 037 121 010 AX			50 005 151
	mit Gegengehäuse/with backhousing/avec demi-corps/con remate/с задним корпусом						
04.1988→07.1992	KR						
Reference	026 121 005 A 026 121 005 H	026 121 005 C 037 121 005 B	026 121 005 E 037 121 005 C	026 121 005 G 068 121 005 A			50 005 148
	ohne Gegengehäuse/without backhousing/sans demi-corps/sin remate/без заднего корпуса						
04.1988→07.1992	KR						
Reference	027 115 105 A 068 115 105 AG	027 115 105 A 068 115 105 AG	027 115 105 C 068 115 105 Q	027 115 105 C 068 115 105 Q		50 005 803	

Passat 1.8i 20V**244**

12.1996→02.2001	ADR, APT, ARG						
Reference	058 115 105 A 058 115 105 C 3B-V-000 001→	058 115 105 A 058 115 105 C	058 115 105 B	058 115 105 B		50 005 811	
12.1996→02.2001	ADR						
Reference	050 121 010	050 121 010 A	050 121 010 C	050 121 010 CX			50 005 156
	mit Gegengehäuse/with backhousing/avec demi-corps/con remate/с задним корпусом						
12.1996→02.2001	ADR						
Reference	026 121 005 F 026 121 005 L	026 121 005 FV	026 121 005 FX	026 121 005 K			50 005 155
	ohne Gegengehäuse/without backhousing/sans demi-corps/sin remate/без заднего корпуса						

Passat 1.8i Turbo 20V**245**

10.1996→02.2001	AEB, ANB, APU						
Reference	058 115 105 A 058 115 105 C 3B-V-000 001→	058 115 105 A 058 115 105 C	058 115 105 B	058 115 105 B		50 005 811	
10.1996→02.2001	AEB						
Reference	050 121 010	050 121 010 A	050 121 010 C	050 121 010 CX			50 005 156
	mit Gegengehäuse/with backhousing/avec demi-corps/con remate/с задним корпусом						
10.2000→11.2005	AWM, AWT						
Reference	06A 115 105 06A 115 105 B 06A 115 105 C 06A 115 105 D	06A 115 105 06A 115 105 B 06A 115 105 C 06A 115 105 D	06A 115 105 06A 115 105 B 06A 115 105 C 06A 115 105 D	06A 115 105 06A 115 105 B 06A 115 105 C 06A 115 105 D		50 005 819	
10.2000→11.2005	AWM, AWT						
							50 005 131



10.1996→02.2001 Reference 	AEB 026 121 005 F 026 121 005 FV 026 121 005 FX 026 121 005 K 026 121 005 L ohne Gegengehäuse/without backhousing/sans demi-corps/sin remate/без заднего корпуса			50 005 155
04.1998→02.2001	APU			50 005 130
Passat 1.8i G60				246
08.1988→07.1993 Reference 	PG 026 121 010 026 121 010 C 026 121 010 CV 026 121 010 CX 026 121 010 F 026 121 010 FV 026 121 010 FX 026 121 010 V 026 121 010 X 037 121 010 037 121 010 A 037 121 010 AX 068 121 010 A 068 121 010 AX mit Gegengehäuse/with backhousing/avec demi-corps/con remate/c задним корпусом			50 005 151
08.1988→07.1993 Reference	PG 037 115 105		50 005 810	
08.1988→07.1993 Reference 	PG 026 121 005 A 026 121 005 C 026 121 005 E 026 121 005 G 026 121 005 H 037 121 005 B 037 121 005 C 068 121 005 A ohne Gegengehäuse/without backhousing/sans demi-corps/sin remate/без заднего корпуса			50 005 148
Passat 1.9i				247
01.1981→07.1983 Reference	WN 035 121 004 035 121 004 A 035 121 004 AV 035 121 004 AX 035 121 004 X 035 121 005 035 121 005 B 035 121 005 E			50 005 145
Passat 1.9 D				248
05.1989→10.1993 Reference 	1Y 026 121 010 026 121 010 C 026 121 010 CV 026 121 010 CX 026 121 010 F 026 121 010 FV 026 121 010 FX 026 121 010 V 026 121 010 X 037 121 010 037 121 010 A 037 121 010 AX 068 121 010 A 068 121 010 AX mit Gegengehäuse/with backhousing/avec demi-corps/con remate/c задним корпусом			50 005 151
05.1989→10.1993 Reference 	1Y 026 121 005 A 026 121 005 C 026 121 005 E 026 121 005 G 026 121 005 H 037 121 005 B 037 121 005 C 068 121 005 A ohne Gegengehäuse/without backhousing/sans demi-corps/sin remate/без заднего корпуса			50 005 148
05.1989→10.1993 Reference 	1Y 028 115 105 G 028 115 105 G 068 115 105 BK 068 115 105 BK 31-J-000 001→		50 005 806	

V



Passat 1.9 TD

249

03.1991→12.1996	AAZ						
Reference	026 121 010 026 121 010 F 026 121 010 X 068 121 010 A	026 121 010 C 026 121 010 FV 037 121 010 068 121 010 AX	026 121 010 CV 026 121 010 FX 037 121 010 A	026 121 010 CX 026 121 010 V 037 121 010 AX			50 005 151
	mit Gegengehäuse/with backhousing/avec demi-corps/con remate/c задним корпусом						
03.1991→12.1996	AAZ						
Reference	026 121 005 A 026 121 005 H	026 121 005 C 037 121 005 B	026 121 005 E 037 121 005 C	026 121 005 G 068 121 005 A			50 005 148
	ohne Gegengehäuse/without backhousing/sans demi-corps/sin remate/без заднего корпуса						
03.1991→12.1996	AAZ						
Reference	028 115 105 G 31-J-000 001→	028 115 105 G	068 115 105 BK	068 115 105 BK		50 005 806	

Passat 1.9 TDI

250

10.1993→08.2000	1Z, AFN, AHU						
Reference	026 121 010 026 121 010 F 026 121 010 X 068 121 010 A	026 121 010 C 026 121 010 FV 037 121 010 068 121 010 AX	026 121 010 CV 026 121 010 FX 037 121 010 A	026 121 010 CX 026 121 010 V 037 121 010 AX			50 005 151
	mit Gegengehäuse/with backhousing/avec demi-corps/con remate/c задним корпусом						
03.1996→08.2000	AFN, AHH, AHU						
Reference	028 121 004	028 121 004 V	028 121 004 X				50 005 158
10.1993→08.2000	1Z, AFN, AHU						
Reference	026 121 005 A 026 121 005 H	026 121 005 C 037 121 005 B	026 121 005 E 037 121 005 C	026 121 005 G 068 121 005 A			50 005 148
	ohne Gegengehäuse/without backhousing/sans demi-corps/sin remate/без заднего корпуса						
03.2005→11.2008	BKC, BLS, BXE						
Reference	045 121 011B	045 121 011F	045 121 011H	045 121 011HX			50 005 556
10.1993→08.1999	1Z, AFN						
Reference	028 115 105 G	028 115 105 G	068 115 105 BK	068 115 105 BK		50 005 806	
01.1999→05.2005	AJM, ATJ, AVB						
Reference	06A 115 105 06A 115 105 B 06A 115 105 C 06A 115 105 D	06A 115 105 06A 115 105 B 06A 115 105 C 06A 115 105 D	06A 115 105 06A 115 105 B 06A 115 105 C 06A 115 105 D	06A 115 105 06A 115 105 B 06A 115 105 C 06A 115 105 D		50 005 819	
	AJM, ATJ: 3B-V-000 001→						

V











03.1996→08.2000 Reference 	AFN, AHH, AHU, AVG 028 115 105 M 028 115 105 M 3B-V-000 001→		50 005 867	
01.1999→05.2005 Reference	AJM, ATJ, AVB, AVF, AWX 038 121 001 C 038 121 011 C 038 121 011 D 038 121 011 G 038 121 011J 038 121 011K 038 121 011KX			50 005 554
Passat 2.0i				251
01.1990→12.1996 Reference 	2E, ACX, ADY, AEP, AGG 026 121 010 026 121 010 C 026 121 010 CV 026 121 010 CX 026 121 010 F 026 121 010 FV 026 121 010 FX 026 121 010 V 026 121 010 X 037 121 010 037 121 010 A 037 121 010 AX 068 121 010 A 068 121 010 AX mit Gegengehäuse/with backhousing/avec demi-corps/con remate/c задним корпусом			50 005 151
08.1983→07.1988 Reference	HP, JS 035 121 004 035 121 004 A 035 121 004 AV 035 121 004 AX 035 121 004 X 035 121 005 035 121 005 B 035 121 005 E			50 005 145
01.1990→12.1996 Reference 	2E, ACX, ADY, AEP, AGG 026 121 005 A 026 121 005 C 026 121 005 E 026 121 005 G 026 121 005 H 037 121 005 B 037 121 005 C 068 121 005 A ohne Gegengehäuse/without backhousing/sans demi-corps/sin remate/без заднего корпуса			50 005 148
01.2000→05.2005 Reference 	ASU, AUZ, AVA, AZM 06A 115 105 06A 115 105 06A 115 105 06A 115 105 06A 115 105 B 06A 115 105 B 06A 115 105 B 06A 115 105 B 06A 115 105 C 06A 115 105 C 06A 115 105 C 06A 115 105 C 06A 115 105 D 06A 115 105 D 06A 115 105 D 06A 115 105 D ASU, AUZ, AVA: 3B-V-000 001→		50 005 819	
10.2000→05.2005	AZM			50 005 131
01.1990→12.1996 Reference	2E, ACX, ADY, AEP, AGG 027 115 105 B 027 115 105 B		50 005 805	
Passat 2.0i 16V				252
04.1988→12.1996 Reference 	9A, ABF 026 121 010 026 121 010 C 026 121 010 CV 026 121 010 CX 026 121 010 F 026 121 010 FV 026 121 010 FX 026 121 010 V 026 121 010 X 037 121 010 037 121 010 A 037 121 010 AX 068 121 010 A 068 121 010 AX mit Gegengehäuse/with backhousing/avec demi-corps/con remate/c задним корпусом			50 005 151

V



04.1988→12.1996 Reference	9A, ABF 051 115 105 A 051 115 105 A			50 005 801
04.1988→12.1996 Reference 	9A, ABF 026 121 005 A 026 121 005 C 026 121 005 E 026 121 005 G 026 121 005 H 037 121 005 B 037 121 005 C 068 121 005 A ohne Gegengehäuse/without backhousing/sans demi-corps/sin remate/без заднего корпуса			50 005 148
Passat 2.0i 20V				253
11.2001→05.2005	ALT			50 005 130
Passat 2.0 FSI 16V				254
03.2005→ Reference	BLR, BLX, BLY, BVY, BVZ 06B 121 011 H 06B 121 011 L 06B 121 011 LX 06B 121 011 M			50 005 775
Passat 2.0 TDI				255
11.2003→ Reference	BGW, BMP 038 121 011 G			50 005 783
Passat 2.0 TDI 16V				256
03.2005→05.2009 Reference	BKP, BMA, BVE 038 121 001 C 038 121 011 C 038 121 011 D 038 121 011 G 038 121 011 J 038 121 011 K 038 121 011 KX			50 005 554
Passat 2.1i				257
01.1981→07.1983 Reference	WE 035 121 004 035 121 004 A 035 121 004 AV 035 121 004 AX 035 121 004 X 035 121 005 035 121 005 B 035 121 005 E			50 005 145
Passat 2.2i				258
08.1984→07.1988 Reference 	HY, JT, KV, KX 035 121 004 035 121 004 A 035 121 004 AV 035 121 004 AX 035 121 004 X 035 121 005 035 121 005 B 035 121 005 E KV: →ch. 89-J-394 742			50 005 145
01.1985→03.1988 Reference 	KV 034 121 004 034 121 004 A 034 121 004 V 034 121 004 X 034 121 005 D ch 89-J-394 743→			50 005 149



Passat 2.3i 20V							259
01.2001→05.2005	AZX						
Reference	028 121 004	028 121 004 V	028 121 004 X				50 005 158
09.1997→08.2000	AGZ						
Reference	066 121 011 C	071 121 005					50 005 159
Passat 2.5 TDI							260
08.1998→05.2003	AFB, AKN						
Reference	059 121 004 B 059 121 004 EX	059 121 004 C	059 121 004 D	059 121 004 E			50 005 168
Passat 2.5 TDI 24V							261
01.2003→05.2005	BAU, BDG, BDH						
Reference	059 121 004 B 059 121 004 EX	059 121 004 C	059 121 004 D	059 121 004 E			50 005 168
Passat 2.8i VR6							262
06.1991→12.1996	AAA						
Reference	021 121 004	021 121 004 A					50 005 165
Passat 2.8i V6 24V							263
10.1994→12.1995	AHA						
Reference	078 121 004 H 078 121 004 JV 078 121 006	078 121 004 HV 078 121 004 JX	078 121 004 HX 078 121 004 Q	078 121 004 J 078 121 004 QX			50 005 167
Passat 2.8i VR6 30V							264
05.1997→05.2005	ACK, AGE, ALG, AMX, APR, AOD						
Reference	078 121 004 H 078 121 004 JV 078 121 006	078 121 004 HV 078 121 004 JX	078 121 004 HX 078 121 004 Q	078 121 004 J 078 121 004 QX			50 005 167
05.1997→12.1998	ACK						
Reference	078 121 004 B 078 121 004 CV	078 121 004 BV 078 121 004 CX	078 121 004 BX	078 121 004 C			50 005 166
Passat 2.9i VR6							265
10.1994→12.1996	ABV						
Reference	021 121 004	021 121 004 A					50 005 165

V

**Pickup 1.6 (USA)****266**

08.1979→07.1980	EJ						
Reference	056 121 005 068 121 005 C	056 121 005 A 068 121 005 X	068 121 005	068 121 005 B			50 005 140
	ohne Gegengehäuse/without backhousing/sans demi-corps/sin remate/без заднего корпуса						
08.1979→07.1980	EJ						
Reference	026 121 010 A 026 121 010 DX 056 121 013 A	026 121 010 AV 055 121 010 068 121 010	026 121 010 D 055 121 010 X	026 121 010 DV 056 121 011			50 005 150
	mit Gegengehäuse/with backhousing/avec demi-corps/con remate/с задним корпусом						

Pickup 1.6 D (USA)**267**

08.1982→07.1984	JK						
Reference	026 121 010 026 121 010 F 026 121 010 X 068 121 010 A	026 121 010 C 026 121 010 FV 037 121 010 068 121 010 AX	026 121 010 CV 026 121 010 FX 037 121 010 A	026 121 010 CX 026 121 010 V 037 121 010 AX			50 005 151
	mit Gegengehäuse/with backhousing/avec demi-corps/con remate/с задним корпусом						
08.1982→07.1984	JK						
Reference	026 121 005 A 026 121 005 H	026 121 005 C 037 121 005 B	026 121 005 E 037 121 005 C	026 121 005 G 068 121 005 A			50 005 148
	ohne Gegengehäuse/without backhousing/sans demi-corps/sin remate/без заднего корпуса						

Polo 0.8**268**

01.1976→07.1978	HE						
Reference	052 121 004 052 121 005 A	052 121 004 V 052 121 005 AX	052 121 004 X 052 121 019	052 121 005			50 005 142

Polo 0.9**269**

04.1975→09.1981	HA						
Reference	052 121 004 052 121 005 A	052 121 004 V 052 121 005 AX	052 121 004 X 052 121 019	052 121 005			50 005 142



Polo 1.0i**270**

08.1981→10.1986	GL						
Reference	052 121 004 052 121 005 A	052 121 004 V 052 121 005 AX	052 121 004 X 052 121 019	052 121 005			50 005 142
07.1996→09.2001	AER, ALD, ALL, AUC						
Reference	030 121 005 S 037 121 008 C	030 121 008 A	030 121 008 C	030 121 008 CX			50 005 137
07.1996→12.1999	AER, ALL						
Reference	036 115 105 B 036 115 105 D	036 115 105 B 036 115 105 D	036 115 105 B 036 115 105 D	036 115 105 B 036 115 105 D		50 005 844	







Polo 1.05

271

08.1985→01.1992	HZ						
Reference	030 115 105 C 030 115 105 E	030 115 105 C 030 115 105 E	030 115 105 D	030 115 105 D		50 005 868	
08.1985→01.1992	HZ						
Reference	030 121 004 A 030 121 005 LV 786.023→	030 121 004 B 030 121 005 LX	030 121 005 H	030 121 005 L			50 005 153
08.1985→01.1992	HZ						
Reference	052 121 004 052 121 005 A →786.022	052 121 004 V 052 121 005 AX	052 121 004 X 052 121 019	052 121 005			50 005 142

Polo 1.05i

272

01.1990→07.1994	AAK, AAU, ACM						
Reference	030 115 105 C 030 115 105 E	030 115 105 C 030 115 105 E	030 115 105 D	030 115 105 D		50 005 868	
02.1992→12.1992	ACM						
Reference	030 121 004 A 030 121 005 LV	030 121 004 B 030 121 005 LX	030 121 005 H	030 121 005 L			50 005 153
01.1990→07.1990	AAK						
Reference	052 121 004 052 121 005 A	052 121 004 V 052 121 005 AX	052 121 004 X 052 121 019	052 121 005			50 005 142
10.1994→06.1996	AEV						
Reference	030 121 005 N 030 121 008 DX	030 121 005 NV	030 121 005 NX	030 121 008 D			50 005 139

Polo 1.1

273

04.1975→07.1983	HB, HC						
Reference	052 121 004 052 121 005 A	052 121 004 V 052 121 005 AX	052 121 004 X 052 121 019	052 121 005			50 005 142

Polo 1.2i

274

01.2002→05.2004	AWY						
Reference	03D 121 005 9N-2-000 001→	03D 121 013 B					50 005 770

V



Polo 1.2i 12V

275

11.2001→05.2004

AZQ

Reference

03D 121 005 03D 121 013 B
9N-2-000 001→**50 005 770**

Polo 1.3

276

08.1985→07.1994

2G, AAV, MH, NU

Reference

030 115 105 C 030 115 105 C 030 115 105 D 030 115 105 D
030 115 105 E 030 115 105 E**50 005 868**

01.1989→07.1994

2G, AAV

Reference

030 121 004 A 030 121 004 B 030 121 005 H 030 121 005 L
030 121 005 LV 030 121 005 LX
2G: 262.740→**50 005 153**

01.1977→07.1994

2G, GT, HH, HJ, HK, HW, MH, NU

Reference

052 121 004 052 121 004 V 052 121 004 X 052 121 005
052 121 005 A 052 121 005 AX 052 121 019
2G: →262.739**50 005 142**

Polo 1.3i

277

05.1986→07.1994

3F, NZ

Reference

030 115 105 C 030 115 105 C 030 115 105 D 030 115 105 D
030 115 105 E 030 115 105 E**50 005 868**

05.1986→07.1994

3F, NZ

Reference

030 121 004 A 030 121 004 B 030 121 005 H 030 121 005 L
030 121 005 LV 030 121 005 LX
3F: 008.527→
NZ: 200.001→**50 005 153**

08.1982→07.1994

3F, GK, NZ

Reference

052 121 004 052 121 004 V 052 121 004 X 052 121 005
052 121 005 A 052 121 005 AX 052 121 019
3F: →008.526
NZ: →200.000**50 005 142**

09.1994→04.1997

ADX

Reference

030 121 005 N 030 121 005 NV 030 121 005 NX 030 121 008 D
030 121 008 DX**50 005 139**

Polo 1.3i G40

278

08.1986→07.1994

PY

Reference

030 115 105 C 030 115 105 C 030 115 105 D 030 115 105 D
030 115 105 E 030 115 105 E**50 005 868**



08.1986→07.1994 Reference 	PY 030 121 004 A 030 121 005 LV 002.177→	030 121 004 B 030 121 005 LX	030 121 005 H	030 121 005 L			50 005 153
08.1986→07.1994 Reference 	PY 052 121 004 052 121 005 A →002.177	052 121 004 V 052 121 005 AX	052 121 004 X 052 121 019	052 121 005			50 005 142
Polo 1.3 D							279
08.1985→07.1990 Reference	MN 030 115 105 C 030 115 105 E	030 115 105 C 030 115 105 E	030 115 105 D	030 115 105 D		50 005 868	
08.1985→07.1990 Reference	MN 031 121 004 031 121 004 X 031 121 005 CX	031 121 004 A 031 121 005 A	031 121 004 AV 031 121 005 C	031 121 004 AX 031 121 005 CV			50 005 138
Polo 1.4i							280
10.1999→09.2001 Reference	AKK, AKP, ANW, AUD 030 121 005 S 037 121 008 C	030 121 008 A	030 121 008 C	030 121 008 CX		50 005 137	
07.1995→12.1999 Reference	AEX, AKV, ANX, APQ 030 121 005 N 030 121 008 DX	030 121 005 NV	030 121 005 NX	030 121 008 D		50 005 139	
07.1995→12.1999 Reference	AEX, AKV, ANX, APQ 036 115 105 B 036 115 105 D	036 115 105 B 036 115 105 D	036 115 105 B 036 115 105 D	036 115 105 B 036 115 105 D		50 005 844	
Polo 1.4i 16V							281
07.1999→05.2008 Reference	AFK, AHW, APE, AQQ, AUA, AUB, BBY, BBZ, BKY 036 121 005 B 036 121 005 S	036 121 005 E 036 121 008K	036 121 005 Q 036 121 008L	036 121 005 QX 036 121 008LX		50 005 154	
04.1996→12.1999 Reference	AFH 036 121 005 D	036 121 005 J	036 121 005 M			50 005 769	

V



04.1996→05.2008 Reference	AFH, AFK, AHW, APE, AQQ, AUA, AUB, BBY, BBZ, BKY	036 115 105 B 036 115 105 D	036 115 105 B 036 115 105 D	036 115 105 B 036 115 105 D		50 005 844		
	AUA, AUB: 01.2002→, 9N-2-000 001→ BBZ, BKY: 01.2005→, 9N-5-500 001→ AFK, AHW, APE, AQQ, AUA, AUB: 6N-YD000 001→ BBY, BBZ, BKY: 9N-2-000 001→							
Polo 1.4 FSI 16V							282	
05.2006→ Reference	BUD	036 121 005 B 036 121 005 S	036 121 005 E 036 121 008K	036 121 005 Q 036 121 008L	036 121 005 QX 036 121 008LX		50 005 154	
02.2002→07.2006 Reference	AXU	03C 121 005 B	03C 121 005 C				50 005 061 NEW	
05.2006→ Reference	BUD	036 115 105 B 036 115 105 D	036 115 105 B 036 115 105 D	036 115 105 B 036 115 105 D	036 115 105 B 036 115 105 D		50 005 844	
	BUD: 01.2009→ BUD: 9N-5-500 001→							
Polo 1.4 D							283	
10.1990→07.1994 Reference	1W	030 115 105 C 030 115 105 E	030 115 105 C 030 115 105 E	030 115 105 D	030 115 105 D		50 005 868	
10.1990→07.1994 Reference	1W	031 121 004 031 121 004 X 031 121 005 CX	031 121 004 A 031 121 005 A	031 121 004 AV 031 121 005 C	031 121 004 AX 031 121 005 CV		50 005 138	
Polo 1.4 TDI							284	
10.1999→ Reference	AMF, ATL, BAY, BMS, BNM, BNV, BWB	045 121 011B	045 121 011F	045 121 011H	045 121 011HX		50 005 556	
	AMF: →9N-2-100 000							
Polo 1.6i							285	
10.1994→08.1999 Reference	1F, AFT	026 121 010 026 121 010 F 026 121 010 X 068 121 010 A	026 121 010 C 026 121 010 FV 037 121 010 068 121 010 AX	026 121 010 CV 026 121 010 FX 037 121 010 A	026 121 010 CX 026 121 010 V 037 121 010 AX		50 005 151	
	mit Gegengehäuse/with backhousing/avec demi-corps/con remate/c задним корпусом							
10.1994→08.1999 Reference	1F, AFT	027 115 105 049 115 105 A	027 115 105 049 115 105 A	027 115 105 E 055 115 105 D	027 115 105 E 055 115 105 D		50 005 808	



10.1994→08.1999 Reference	1F, AFT	026 121 005 A 026 121 005 H	026 121 005 C 037 121 005 B	026 121 005 E 037 121 005 C	026 121 005 G 068 121 005 A			50 005 148
		ohne Gegengehäuse/without backhousing/sans demi-corps/sin remate/без заднего корпуса						
10.1999→09.2001 Reference	AEH, AKL, APF, AUR	06A 115 105 06A 115 105 B 06A 115 105 C 06A 115 105 D	06A 115 105 06A 115 105 B 06A 115 105 C 06A 115 105 D	06A 115 105 06A 115 105 B 06A 115 105 C 06A 115 105 D	06A 115 105 06A 115 105 B 06A 115 105 C 06A 115 105 D		50 005 819	
		6K-Y-502 795→						
10.1994→12.1999 Reference	AEA, AEE, AHS	030 121 005 N 030 121 008 DX	030 121 005 NV	030 121 005 NX	030 121 008 D			50 005 139
07.1995→09.2001 Reference	AEE, AHS, ALM	036 115 105 B 036 115 105 D	036 115 105 B 036 115 105 D	036 115 105 B 036 115 105 D	036 115 105 B 036 115 105 D		50 005 844	
		ALM: 6K-Y-502 795→						
10.1999→09.2001	AEH, AKL, APF, AUR							50 005 130
Polo 1.6i 16V								286
08.1998→09.2001 Reference	AJV, ARC, AVY	036 121 005 F	036 121 005 P	036 121 008 G	036 121 008 GX			50 005 754
06.2006→ Reference	BTS	03C 121 005 B	03C 121 005 C					50 005 061 <small>NEW</small>
08.1998→09.2001 Reference	AJV, ARC, AVY	036 115 105 B 036 115 105 D	036 115 105 B 036 115 105 D	036 115 105 B 036 115 105 D	036 115 105 B 036 115 105 D		50 005 844	
		ARC, AVY: 6N-YD000 001→						
Polo 1.7 SDI								287
04.1997→04.2000 Reference	AHG, AKU	028 121 004	028 121 004 V	028 121 004 X				50 005 158
11.1997→08.1999 Reference	AKW	026 121 005 A 026 121 005 H	026 121 005 C 037 121 005 B	026 121 005 E 037 121 005 C	026 121 005 G 068 121 005 A			50 005 148
		ohne Gegengehäuse/without backhousing/sans demi-corps/sin remate/без заднего корпуса						

V



04.1997→04.2000 Reference	AHG, AKU 028 115 105 L			50 005 807
Polo 1.8i 288				
03.1998→09.2001 Reference	ADD 027 115 105 027 115 105 027 115 105 E 027 115 105 E 049 115 105 A 049 115 105 A 055 115 105 D 055 115 105 D			50 005 808
03.1998→09.2001 Reference	ADD 026 121 005 A 026 121 005 C 026 121 005 E 026 121 005 G 026 121 005 H 037 121 005 B 037 121 005 C 068 121 005 A ohne Gegengehäuse/without backhousing/sans demi-corps/sin remate/без заднего корпуса			50 005 148
Polo 1.8i Turbo 20V 289				
09.2005→ Reference	BBU, BJX 06A 115 105 06A 115 105 06A 115 105 06A 115 105 06A 115 105 B 06A 115 105 B 06A 115 105 B 06A 115 105 B 06A 115 105 C 06A 115 105 C 06A 115 105 C 06A 115 105 C 06A 115 105 D 06A 115 105 D 06A 115 105 D 06A 115 105 D 9N-5-500 001→			50 005 819
09.2005→	BBU, BJX			50 005 131
Polo 1.9 D 290				
01.1996→10.1996 Reference	1Y 026 121 010 026 121 010 C 026 121 010 CV 026 121 010 CX 026 121 010 F 026 121 010 FV 026 121 010 FX 026 121 010 V 026 121 010 X 037 121 010 037 121 010 A 037 121 010 AX 068 121 010 A 068 121 010 AX mit Gegengehäuse/with backhousing/avec demi-corps/con remate/с задним корпусом			50 005 151
10.1994→07.2001 Reference	AEF 028 121 004 028 121 004 V 028 121 004 X			50 005 158
01.1996→10.1996 Reference	1Y 026 121 005 A 026 121 005 C 026 121 005 E 026 121 005 G 026 121 005 H 037 121 005 B 037 121 005 C 068 121 005 A ohne Gegengehäuse/without backhousing/sans demi-corps/sin remate/без заднего корпуса			50 005 148
01.1996→10.1996 Reference	1Y 028 115 105 G 028 115 105 G 068 115 105 BK 068 115 105 BK			50 005 806



10.1994→07.2001 Reference	AEF 028 115 105 L			50 005 807
Polo 1.9 SDI				
12.1995→08.1999 Reference	AEY 026 121 010 026 121 010 C 026 121 010 CV 026 121 010 CX 026 121 010 F 026 121 010 FV 026 121 010 FX 026 121 010 V 026 121 010 X 037 121 010 037 121 010 A 037 121 010 AX 068 121 010 A 068 121 010 AX mit Gegengehäuse/with backhousing/avec demi-corps/con remate/c задним корпусом 09.1996→		50 005 151	
07.1996→09.2001 Reference	AGD 028 121 004 028 121 004 V 028 121 004 X			50 005 158
10.1999→09.2001 Reference	AGP, AQM 038 121 011 038 121 011 A 038 121 011 AV 038 121 011 AX			50 005 132
12.1995→08.1999 Reference	AEY 026 121 005 A 026 121 005 C 026 121 005 E 026 121 005 G 026 121 005 H 037 121 005 B 037 121 005 C 068 121 005 A ohne Gegengehäuse/without backhousing/sans demi-corps/sin remate/без заднего корпуса			50 005 148
12.1995→08.1999 Reference	AEY 028 115 105 G 028 115 105 G 068 115 105 BK 068 115 105 BK			50 005 806
10.1999→ Reference	AGP, AQM, ASY 06A 115 105 06A 115 105 06A 115 105 06A 115 105 06A 115 105 B 06A 115 105 B 06A 115 105 B 06A 115 105 B 06A 115 105 C 06A 115 105 C 06A 115 105 C 06A 115 105 C 06A 115 105 D 06A 115 105 D 06A 115 105 D 06A 115 105 D AGP, AQM: 6K-Y-502 795→ ASY: 9N-2-000 001→ ASY: 9N-5-500 001→			50 005 819
11.2001→ Reference	ASY 045 121 011 C 045 121 011 G			50 005 750
07.1996→09.2001 Reference	AGD, ASX 028 115 105 L			50 005 807

291**V**



Polo 1.9 TDI

292

01.1997→08.2000	AFN, AHU, ALE						
Reference	026 121 010	026 121 010 C	026 121 010 CV	026 121 010 CX			50 005 151
	026 121 010 F	026 121 010 FV	026 121 010 FX	026 121 010 V			
	026 121 010 X	037 121 010	037 121 010 A	037 121 010 AX			
	068 121 010 A	068 121 010 AX					
	mit Gegengehäuse/with backhousing/avec demi-corps/con remate/c задним корпусом						
01.1997→08.2000	AFN, AHU						50 005 158
Reference	028 121 004	028 121 004 V	028 121 004 X				
10.1999→09.2001	AGR, ALH, ASV						50 005 132
Reference	038 121 011	038 121 011 A	038 121 011 AV	038 121 011AX			
01.1997→08.2000	AFN, AHU, ALE						50 005 148
Reference	026 121 005 A	026 121 005 C	026 121 005 E	026 121 005 G			
	026 121 005 H	037 121 005 B	037 121 005 C	068 121 005 A			
	ohne Gegengehäuse/without backhousing/sans demi-corps/sin remate/без заднего корпуса						
11.2001→	ATD, AXR, BLT, BMT						50 005 556
Reference	045 121 011B	045 121 011F	045 121 011H	045 121 011HX			
	AXR: →9N-2-100 001						
01.1997→08.2000	AFN, AHU, ALE						50 005 806
Reference	028 115 105 G	028 115 105 G	068 115 105 BK	068 115 105 BK			
10.1999→	AGR, ALH, ASV, ATD, AXR						50 005 819
Reference	06A 115 105	06A 115 105	06A 115 105	06A 115 105			
	06A 115 105 B	06A 115 105 B	06A 115 105 B	06A 115 105 B			
	06A 115 105 C	06A 115 105 C	06A 115 105 C	06A 115 105 C			
	06A 115 105 D	06A 115 105 D	06A 115 105 D	06A 115 105 D			
	AGR, ALH, ASV: 6K-Y-502 795→ ATD, AXR: 9N-2-000 001→ ATD, AXR: 9N-5-500 001→						
11.2003→05.2008	ASZ						50 005 554
Reference	038 121 001 C	038 121 011 C	038 121 011 D	038 121 011G			
	038 121 011J	038 121 011K	038 121 011KX				

V

Polo 2.0i

293

10.2004→	BBX						50 005 819
Reference	06A 115 105	06A 115 105	06A 115 105	06A 115 105			
	06A 115 105 B	06A 115 105 B	06A 115 105 B	06A 115 105 B			
	06A 115 105 C	06A 115 105 C	06A 115 105 C	06A 115 105 C			
	06A 115 105 D	06A 115 105 D	06A 115 105 D	06A 115 105 D			
	9N-5-500 001→						



10.2004→	BBX						50 005 131
08.1999→09.2001	ADC						50 005 805
Reference	027 115 105 B	027 115 105 B					
Polo Classic 1.8i							294
→	ADD						
Reference	027 115 105 049 115 105 A	027 115 105 049 115 105 A	027 115 105 E 055 115 105 D	027 115 105 E 055 115 105 D		50 005 808	
→	ADD						
Reference	026 121 005 A 026 121 005 H	026 121 005 C 037 121 005 B	026 121 005 E 037 121 005 C	026 121 005 G 068 121 005 A		50 005 148	
	ohne Gegengehäuse/without backhousing/sans demi-corps/sin remate/без заднего корпуса						
Polo Classic 1.9 D							295
05.1996→09.2005	1Y						
Reference	026 121 010 026 121 010 F 026 121 010 X 068 121 010 A	026 121 010 C 026 121 010 FV 037 121 010 068 121 010 AX	026 121 010 CV 026 121 010 FX 037 121 010 A	026 121 010 CX 026 121 010 V 037 121 010 AX		50 005 151	
	mit Gegengehäuse/with backhousing/avec demi-corps/con remate/c задним корпусом						
05.1996→09.2005	1Y						
Reference	026 121 005 A 026 121 005 H	026 121 005 C 037 121 005 B	026 121 005 E 037 121 005 C	026 121 005 G 068 121 005 A		50 005 148	
	ohne Gegengehäuse/without backhousing/sans demi-corps/sin remate/без заднего корпуса						
Polo Classic 1.9 TDI							296
03.1999→09.2005	AGR						
Reference	038 121 011	038 121 011 A	038 121 011 AV	038 121 011 AX		50 005 132	
03.1999→09.2005	AGR						
Reference	06A 115 105 06A 115 105 B 06A 115 105 C 06A 115 105 D 6K-Y-502 795→	06A 115 105 06A 115 105 B 06A 115 105 C 06A 115 105 D	06A 115 105 06A 115 105 B 06A 115 105 C 06A 115 105 D	06A 115 105 06A 115 105 B 06A 115 105 C 06A 115 105 D		50 005 819	
Polo Classic 2.0i							297
08.1999→09.2001	ADC						
Reference	027 115 105 B	027 115 105 B				50 005 805	

**Polo Sedan 1.4 FSI 16V****298**

→

BBY, BBZ, BKY

Reference

036 121 005 B	036 121 005 E	036 121 005 Q	036 121 005 QX
036 121 005 S	036 121 008K	036 121 008L	036 121 008LX

**50 005 154****Polo Sedan 1.4 TDI****299**

06.2003→07.2006

BAY

Reference

045 121 011B	045 121 011F	045 121 011H	045 121 011HX
--------------	--------------	--------------	---------------

**50 005 556****Polo Sedan 1.9 SDI****300**

11.2002→

ASY

Reference

045 121 011 C	045 121 011 G
---------------	---------------

**50 005 750****Polo Sedan 2.0i****301**

→

BBX

**50 005 131****Polocross 1.4i 16V****302**

11.2005→

BBZ, BKY

Reference

036 121 005 B	036 121 005 E	036 121 005 Q	036 121 005 QX
036 121 005 S	036 121 008K	036 121 008L	036 121 008LX

**50 005 154****Polocross 1.4 FSI 16V****303**

11.2005→

BBZ, BUD

Reference

036 121 005 B	036 121 005 E	036 121 005 Q	036 121 005 QX
036 121 005 S	036 121 008K	036 121 008L	036 121 008LX

**50 005 154****Polocross 1.4 TDI****304**

11.2005→

BNM, BWB

Reference

045 121 011B	045 121 011F	045 121 011H	045 121 011HX
--------------	--------------	--------------	---------------

**50 005 556****Polocross 1.6i 16V****305**

06.2006→

BTS

Reference

03C 121 005 B	03C 121 005 C
---------------	---------------

**50 005 061**
NEW**V**

**Polocross 1.9 TDI****306**

11.2005→ Reference	ATD, AXR, BMT 045 121 011B 045 121 011F 045 121 011H 045 121 011HX			50 005 556
-----------------------	--	---	--	------------

Quantum 1.3**307**

02.1977→1985 Reference	GF 052 121 004 052 121 004 V 052 121 004 X 052 121 005 052 121 005 A 052 121 005 AX 052 121 019			50 005 142
---------------------------	--	---	--	------------

Quantum 1.6 D**308**

01.1981→07.1987 Reference	CS 026 121 010 026 121 010 C 026 121 010 CV 026 121 010 CX 026 121 010 F 026 121 010 FV 026 121 010 FX 026 121 010 V 026 121 010 X 037 121 010 037 121 010 A 037 121 010 AX 068 121 010 A 068 121 010 AX mit Gegengehäuse/with backhousing/avec demi-corps/con remate/c задним корпусом 215.896→			50 005 151
------------------------------	--	---	--	------------

01.1981→07.1987 Reference	CS 056 121 005 056 121 005 A 068 121 005 068 121 005 B 068 121 005 C 068 121 005 X ohne Gegengehäuse/without backhousing/sans demi-corps/sin remate/без заднего корпуса →215.895			50 005 140
------------------------------	--	---	--	------------

01.1981→07.1987 Reference	CS 026 121 005 A 026 121 005 C 026 121 005 E 026 121 005 G 026 121 005 H 037 121 005 B 037 121 005 C 068 121 005 A ohne Gegengehäuse/without backhousing/sans demi-corps/sin remate/без заднего корпуса 215.896→			50 005 148
------------------------------	--	---	--	------------

01.1981→07.1987 Reference	CS 026 121 010 A 026 121 010 AV 026 121 010 D 026 121 010 DV 026 121 010 DX 055 121 010 055 121 010 X 056 121 011 056 121 013 A 068 121 010 mit Gegengehäuse/with backhousing/avec demi-corps/con remate/c задним корпусом →215.895			50 005 150
------------------------------	---	---	--	------------

Quantum 1.8**309**

09.1983→07.1986 Reference	JN 026 121 010 026 121 010 C 026 121 010 CV 026 121 010 CX 026 121 010 F 026 121 010 FV 026 121 010 FX 026 121 010 V 026 121 010 X 037 121 010 037 121 010 A 037 121 010 AX 068 121 010 A 068 121 010 AX mit Gegengehäuse/with backhousing/avec demi-corps/con remate/c задним корпусом			50 005 151
------------------------------	--	---	--	------------

09.1983→07.1986 Reference	JN 026 121 005 A 026 121 005 C 026 121 005 E 026 121 005 G 026 121 005 H 037 121 005 B 037 121 005 C 068 121 005 A ohne Gegengehäuse/without backhousing/sans demi-corps/sin remate/без заднего корпуса			50 005 148
------------------------------	--	---	--	------------

Quantum 2.0i**310**

1981 → 1984 Reference	WN 035 121 004 035 121 004 A 035 121 004 AV 035 121 004 AX 035 121 004 X 035 121 005 035 121 005 B 035 121 005 E			50 005 145
--------------------------	--	---	--	------------



Quantum 2.2i							311		
06.1977→07.1988	JT, KX, WE								
Reference	035 121 004 035 121 004 X	035 121 004 A 035 121 005	035 121 004 AV 035 121 005 B	035 121 004 AX 035 121 005 E			50 005 145		
Rabbit 1.5							312		
→	EH, FH, FX								
Reference	056 121 005 068 121 005 C	056 121 005 A 068 121 005 X	068 121 005	068 121 005 B			50 005 140		
	ohne Gegengehäuse/without backhousing/sans demi-corps/sin remate/без заднего корпуса								
08.1977→07.1979	EH								
Reference	027 115 105 049 115 105 A	027 115 105 049 115 105 A	027 115 105 E 055 115 105 D	027 115 105 E 055 115 105 D		50 005 808			
→	EH, FH, FX								
Reference	026 121 010 A 026 121 010 DX 056 121 013 A	026 121 010 AV 055 121 010 068 121 010	026 121 010 D 055 121 010 X	026 121 010 DV 056 121 011			50 005 150		
	mit Gegengehäuse/with backhousing/avec demi-corps/con remate/с задним корпусом								
Rabbit 1.5 D							313		
09.1976→08.1980	CK								
Reference	056 121 005 068 121 005 C	056 121 005 A 068 121 005 X	068 121 005	068 121 005 B			50 005 140		
	ohne Gegengehäuse/without backhousing/sans demi-corps/sin remate/без заднего корпуса								
09.1976→08.1980	CK								
Reference	026 121 010 A 026 121 010 DX 056 121 013 A	026 121 010 AV 055 121 010 068 121 010	026 121 010 D 055 121 010 X	026 121 010 DV 056 121 011			50 005 150		
	mit Gegengehäuse/with backhousing/avec demi-corps/con remate/с задним корпусом								
Rabbit 1.6							314		
09.1975→1983	YV								
Reference	026 121 010 026 121 010 F 026 121 010 X 068 121 010 A	026 121 010 C 026 121 010 FV 037 121 010 068 121 010 AX	026 121 010 CV 026 121 010 FX 037 121 010 A	026 121 010 CX 026 121 010 V 037 121 010 AX			50 005 151		
	mit Gegengehäuse/with backhousing/avec demi-corps/con remate/с задним корпусом ch 43-B-070 001→								
08.1975→1983	EE, EJ, FN, YV								
Reference	056 121 005 068 121 005 C	056 121 005 A 068 121 005 X	068 121 005	068 121 005 B			50 005 140		
	ohne Gegengehäuse/without backhousing/sans demi-corps/sin remate/без заднего корпуса YV: →ch 43-B-070 000								
08.1975→07.1980	EJ, FN								
Reference	027 115 105 049 115 105 A	027 115 105 049 115 105 A	027 115 105 E 055 115 105 D	027 115 105 E 055 115 105 D		50 005 808			



09.1975→1983 Reference	YV 026 121 005 A 026 121 005 C 026 121 005 E 026 121 005 G 026 121 005 H 037 121 005 B 037 121 005 C 068 121 005 A ohne Gegengehäuse/without backhousing/sans demi-corps/sin remate/без заднего корпуса ch 43-B-070 001→			50 005 148
08.1975→1983 Reference	EE, EJ, FN, YV 026 121 010 A 026 121 010 AV 026 121 010 D 026 121 010 DV 026 121 010 DX 055 121 010 055 121 010 X 056 121 011 056 121 013 A 068 121 010 mit Gegengehäuse/with backhousing/avec demi-corps/con remate/c задним корпусом YV: →ch. 43-B-070 000			50 005 150
Rabbit 1.6 D				315
01.1981→07.1987 Reference	CS, JK 026 121 010 026 121 010 C 026 121 010 CV 026 121 010 CX 026 121 010 F 026 121 010 FV 026 121 010 FX 026 121 010 V 026 121 010 X 037 121 010 037 121 010 A 037 121 010 AX 068 121 010 A 068 121 010 AX mit Gegengehäuse/with backhousing/avec demi-corps/con remate/c задним корпусом CS: 215.896→			50 005 151
01.1981→07.1987 Reference	CS 056 121 005 056 121 005 A 068 121 005 068 121 005 B 068 121 005 C 068 121 005 X ohne Gegengehäuse/without backhousing/sans demi-corps/sin remate/без заднего корпуса →215.895			50 005 140
03.1981→07.1984 Reference	CR, JK 068 115 105 AE 068 115 105 AN 068 115 105 D 068 115 105 H 068 115 105 P 068 115 105 S		50 005 809	
01.1981→07.1987 Reference	CS, JK 026 121 005 A 026 121 005 C 026 121 005 E 026 121 005 G 026 121 005 H 037 121 005 B 037 121 005 C 068 121 005 A ohne Gegengehäuse/without backhousing/sans demi-corps/sin remate/без заднего корпуса CS: 215.896→			50 005 148
01.1981→07.1987 Reference	CS 026 121 010 A 026 121 010 AV 026 121 010 D 026 121 010 DV 026 121 010 DX 055 121 010 055 121 010 X 056 121 011 056 121 013 A 068 121 010 mit Gegengehäuse/with backhousing/avec demi-corps/con remate/c задним корпусом →215.895			50 005 150
Rabbit 1.6 TD				316
08.1981→07.1984 Reference	CY 068 115 105 AE 068 115 105 AN 068 115 105 D 068 115 105 H 068 115 105 P 068 115 105 S		50 005 809	
Rabbit 1.7				317
08.1981→07.1984 Reference	EN 027 115 105 027 115 105 027 115 105 E 027 115 105 E 049 115 105 A 049 115 105 A 055 115 105 D 055 115 105 D		50 005 808	

V

**Rabbit 1.8i****318**

05.1983→07.1984

JH

Reference

026 121 010	026 121 010 C	026 121 010 CV	026 121 010 CX
026 121 010 F	026 121 010 FV	026 121 010 FX	026 121 010 V
026 121 010 X	037 121 010	037 121 010 A	037 121 010 AX
068 121 010 A	068 121 010 AX		



mit Gegengehäuse/with backhousing/avec demi-corps/con remate/c задним корпусом



50 005 151

05.1983→07.1984

JH

Reference

026 121 005 A	026 121 005 C	026 121 005 E	026 121 005 G
026 121 005 H	037 121 005 B	037 121 005 C	068 121 005 A



ohne Gegengehäuse/without backhousing/sans demi-corps/sin remate/без заднего корпуса



50 005 148

Santana 1.3**319**

08.1983→12.1984

EP

Reference

026 121 010	026 121 010 C	026 121 010 CV	026 121 010 CX
026 121 010 F	026 121 010 FV	026 121 010 FX	026 121 010 V
026 121 010 X	037 121 010	037 121 010 A	037 121 010 AX
068 121 010 A	068 121 010 AX		



mit Gegengehäuse/with backhousing/avec demi-corps/con remate/c задним корпусом



50 005 151

08.1983→12.1984

EP

Reference

026 115 105	026 115 105	026 115 105 B	026 115 105 B
049 115 105 H	049 115 105 H	056 115 105 A	056 115 105 A



50 005 813

08.1983→12.1984

EP

Reference

026 121 005 A	026 121 005 C	026 121 005 E	026 121 005 G
026 121 005 H	037 121 005 B	037 121 005 C	068 121 005 A



ohne Gegengehäuse/without backhousing/sans demi-corps/sin remate/без заднего корпуса



50 005 148

01.1978→07.1983

FY, FZ

Reference

052 121 004	052 121 004 V	052 121 004 X	052 121 005
052 121 005 A	052 121 005 AX	052 121 019	



50 005 142

Santana 1.6**320**

08.1981→12.1984

DT, JU, WV, WVA, YP

Reference

026 121 010	026 121 010 C	026 121 010 CV	026 121 010 CX
026 121 010 F	026 121 010 FV	026 121 010 FX	026 121 010 V
026 121 010 X	037 121 010	037 121 010 A	037 121 010 AX
068 121 010 A	068 121 010 AX		

mit Gegengehäuse/with backhousing/avec demi-corps/con remate/c задним корпусом
WV, WVA, YP: ch 32-E-100 001→

50 005 151

08.1981→07.1983

WV, WVA, YP

Reference

056 121 005	056 121 005 A	068 121 005	068 121 005 B
068 121 005 C	068 121 005 X		

ohne Gegengehäuse/without backhousing/sans demi-corps/sin remate/без заднего корпуса
→ch. 32-E-100 000

50 005 140

08.1981→12.1984

DT, JU, WV, WY, YP

Reference

026 115 105	026 115 105	026 115 105 B	026 115 105 B
049 115 105 H	049 115 105 H	056 115 105 A	056 115 105 A



50 005 813



08.1981→12.1984 Reference	DT, JU, WV, VVA, YP 026 121 005 A 026 121 005 C 026 121 005 E 026 121 005 G 026 121 005 H 037 121 005 B 037 121 005 C 068 121 005 A ohne Gegengehäuse/without backhousing/sans demi-corps/sin remate/без заднего корпуса WV, VVA, YP: ch 32-E-100 001→			50 005 148
08.1981→07.1983 Reference	WV, VVA, YP 026 121 010 A 026 121 010 AV 026 121 010 D 026 121 010 DV 026 121 010 DX 055 121 010 055 121 010 X 056 121 011 056 121 013 A 068 121 010 mit Gegengehäuse/with backhousing/avec demi-corps/con remate/c задним корпусом →ch. 32-E-100 000			50 005 150
Santana 1.6 D				321
08.1981→12.1984 Reference	CR, JK 026 121 010 026 121 010 C 026 121 010 CV 026 121 010 CX 026 121 010 F 026 121 010 FV 026 121 010 FX 026 121 010 V 026 121 010 X 037 121 010 037 121 010 A 037 121 010 AX 068 121 010 A 068 121 010 AX mit Gegengehäuse/with backhousing/avec demi-corps/con remate/c задним корпусом CR: ch 32-B-100 001→			50 005 151
08.1981→07.1982 Reference	CR 056 121 005 056 121 005 A 068 121 005 068 121 005 B 068 121 005 C 068 121 005 X ohne Gegengehäuse/without backhousing/sans demi-corps/sin remate/без заднего корпуса →ch. 32-B-100 000			50 005 140
08.1981→12.1984 Reference	CR, JK 026 121 005 A 026 121 005 C 026 121 005 E 026 121 005 G 026 121 005 H 037 121 005 B 037 121 005 C 068 121 005 A ohne Gegengehäuse/without backhousing/sans demi-corps/sin remate/без заднего корпуса CR: ch 32-B-100 001→			50 005 148
08.1981→07.1982 Reference	CR 026 121 010 A 026 121 010 AV 026 121 010 D 026 121 010 DV 026 121 010 DX 055 121 010 055 121 010 X 056 121 011 056 121 013 A 068 121 010 mit Gegengehäuse/with backhousing/avec demi-corps/con remate/c задним корпусом →ch. 32-B-100 000			50 005 150
08.1981→12.1984 Reference	CR, JK 068 115 105 AC 068 115 105 AC 068 115 105 AD 068 115 105 AD 068 115 105 AP 068 115 105 AP 068 115 105 N 068 115 105 N 068 115 105 R 068 115 105 R		50 005 804	
Santana 1.6 TD				322
12.1981→12.1984 Reference	CY 026 121 010 026 121 010 C 026 121 010 CV 026 121 010 CX 026 121 010 F 026 121 010 FV 026 121 010 FX 026 121 010 V 026 121 010 X 037 121 010 037 121 010 A 037 121 010 AX 068 121 010 A 068 121 010 AX mit Gegengehäuse/with backhousing/avec demi-corps/con remate/c задним корпусом ch 32-E-100 001→			50 005 151
12.1981→12.1984 Reference	CY 056 121 005 056 121 005 A 068 121 005 068 121 005 B 068 121 005 C 068 121 005 X ohne Gegengehäuse/without backhousing/sans demi-corps/sin remate/без заднего корпуса →ch. 32-E-100 000			50 005 140

V



12.1981→12.1984	CY			
Reference	026 121 005 A 026 121 005 C 026 121 005 E 026 121 005 G 026 121 005 H 037 121 005 B 037 121 005 C 068 121 005 A			50 005 148
	ohne Gegengehäuse/without backhousing/sans demi-corps/sin remate/без заднего корпуса ch 32-E-100 001→			
12.1981→12.1984	CY			
Reference	026 121 010 A 026 121 010 AV 026 121 010 D 026 121 010 DV 026 121 010 DX 055 121 010 055 121 010 X 056 121 011 056 121 013 A 068 121 010			50 005 150
	mit Gegengehäuse/with backhousing/avec demi-corps/con remate/с задним корпусом →ch. 32-E-100 000			
12.1981→12.1984	CY			
Reference	068 115 105 AC 068 115 105 AC 068 115 105 AD 068 115 105 AD 068 115 105 AP 068 115 105 AP 068 115 105 N 068 115 105 N 068 115 105 R 068 115 105 R		50 005 804	
Santana 1.8				323
01.1983→12.1984	DS, JN, JV			
Reference	026 121 010 026 121 010 C 026 121 010 CV 026 121 010 CX 026 121 010 F 026 121 010 FV 026 121 010 FX 026 121 010 V 026 121 010 X 037 121 010 037 121 010 A 037 121 010 AX 068 121 010 A 068 121 010 AX			50 005 151
	mit Gegengehäuse/with backhousing/avec demi-corps/con remate/с задним корпусом			
01.1983→12.1984	DS, JN, JV			
Reference	026 115 105 026 115 105 026 115 105 B 026 115 105 B 049 115 105 H 049 115 105 H 056 115 105 A 056 115 105 A		50 005 813	
01.1983→12.1984	DS, JN, JV			
Reference	026 121 005 A 026 121 005 C 026 121 005 E 026 121 005 G 026 121 005 H 037 121 005 B 037 121 005 C 068 121 005 A			50 005 148
	ohne Gegengehäuse/without backhousing/sans demi-corps/sin remate/без заднего корпуса			
Santana 1.8i				324
01.1985→07.1986	KX			
Reference	035 121 004 035 121 004 A 035 121 004 AV 035 121 004 AX 035 121 004 X 035 121 005 035 121 005 B 035 121 005 E			50 005 145
Santana 1.9i				325
08.1981→07.1983	WN			
Reference	035 121 004 035 121 004 A 035 121 004 AV 035 121 004 AX 035 121 004 X 035 121 005 035 121 005 B 035 121 005 E			50 005 145
Santana 2.0i				326
08.1983→12.1984	HP, JS			
Reference	035 121 004 035 121 004 A 035 121 004 AV 035 121 004 AX 035 121 004 X 035 121 005 035 121 005 B 035 121 005 E			50 005 145



Santana 2.1i

327

08.1981→07.1983 WE

Reference

 035 121 004 035 121 004 A 035 121 004 AV 035 121 004 AX
 035 121 004 X 035 121 005 035 121 005 B 035 121 005 E

50 005 145

Saveiro 1.6i

328

05.1994→05.2002 AP 504, AP 505, AP 521, AP 540, AP 541, AP 542

Reference

 026 115 105 A 026 115 105 A
 AP 541, AP 542: 07.1997→

50 005 822

Saveiro 1.6 D

329

→

JK

Reference

 026 121 010 026 121 010 C 026 121 010 CV 026 121 010 CX
 026 121 010 F 026 121 010 FV 026 121 010 FX 026 121 010 V
 026 121 010 X 037 121 010 037 121 010 A 037 121 010 AX
 068 121 010 A 068 121 010 AX

mit Gegengehäuse/with backhousing/avec demi-corps/con remate/c задним корпусом

50 005 151

→

JK

Reference

 026 121 005 A 026 121 005 C 026 121 005 E 026 121 005 G
 026 121 005 H 037 121 005 B 037 121 005 C 068 121 005 A
 ohne Gegengehäuse/without backhousing/sans demi-corps/sin remate/без заднего корпуса

50 005 148

Saveiro 1.8i

330

05.1994→05.2002 AP 522, AP 543

Reference

 026 115 105 A 026 115 105 A
 AP 543: 07.1997→

50 005 822

Saveiro 1.9 D

331

06.2002→03.2006 1Y

Reference

 026 121 010 026 121 010 C 026 121 010 CV 026 121 010 CX
 026 121 010 F 026 121 010 FV 026 121 010 FX 026 121 010 V
 026 121 010 X 037 121 010 037 121 010 A 037 121 010 AX
 068 121 010 A 068 121 010 AX

mit Gegengehäuse/with backhousing/avec demi-corps/con remate/c задним корпусом

50 005 151

06.2002→03.2006 1Y

Reference

 026 121 005 A 026 121 005 C 026 121 005 E 026 121 005 G
 026 121 005 H 037 121 005 B 037 121 005 C 068 121 005 A
 ohne Gegengehäuse/without backhousing/sans demi-corps/sin remate/без заднего корпуса

50 005 148

Saveiro 2.0i

332

09.1994→05.2002 AP 528, AP 529, AP 546, AP 547

Reference

026 115 105 A 026 115 105 A

50 005 822

Saveiro 2.0i 16V

333

10.1995→07.2000 AP 112

Reference

053 115 105 B 053 115 105 B 053 115 105 C 053 115 105 C

50 005 845

**Scirocco 1.1****334**

02.1974→07.1979

FA, FJ

Reference

052 121 004	052 121 004 V	052 121 004 X	052 121 005
052 121 005 A	052 121 005 AX	052 121 019	



50 005 142

Scirocco 1.3**335**

08.1979→07.1984

GF, HK

Reference

052 121 004	052 121 004 V	052 121 004 X	052 121 005
052 121 005 A	052 121 005 AX	052 121 019	



50 005 142

Scirocco 1.5**336**

08.1977→12.1982

GH, JB

Reference

026 121 010	026 121 010 C	026 121 010 CV	026 121 010 CX
026 121 010 F	026 121 010 FV	026 121 010 FX	026 121 010 V
026 121 010 X	037 121 010	037 121 010 A	037 121 010 AX
068 121 010 A	068 121 010 AX		



mit Gegengehäuse/with backhousing/avec demi-corps/con remate/c задним корпусом
ch ...C-630 001→



50 005 151

02.1974→12.1982

EH, FD, FH, FK, GH, JB

Reference

056 121 005	056 121 005 A	068 121 005	068 121 005 B
068 121 005 C	068 121 005 X		



ohne Gegengehäuse/without backhousing/sans demi-corps/sin remate/без заднего корпуса
JB: →ch C-630 000
GH: →ch. C-630 000



50 005 140

02.1974→12.1982

EH, FD, FH, FK, GH, JB

Reference

027 115 105	027 115 105	027 115 105 E	027 115 105 E
049 115 105 A	049 115 105 A	055 115 105 D	055 115 105 D



50 005 808

08.1977→12.1982

GH, JB

Reference

026 121 005 A	026 121 005 C	026 121 005 E	026 121 005 G
026 121 005 H	037 121 005 B	037 121 005 C	068 121 005 A



ohne Gegengehäuse/without backhousing/sans demi-corps/sin remate/без заднего корпуса
ch ...C-630 001→



50 005 148

02.1974→12.1982

EH, FD, FH, FK, GH, JB

Reference

026 121 010 A	026 121 010 AV	026 121 010 D	026 121 010 DV
026 121 010 DX	055 121 010	055 121 010 X	056 121 011
056 121 013 A	068 121 010		



mit Gegengehäuse/with backhousing/avec demi-corps/con remate/c задним корпусом
GH, JB: →ch. C-630 000



50 005 150

Scirocco 1.5i**337**

02.1974→07.1980

FB, FX

Reference

056 121 005	056 121 005 A	068 121 005	068 121 005 B
068 121 005 C	068 121 005 X		



ohne Gegengehäuse/without backhousing/sans demi-corps/sin remate/без заднего корпуса



50 005 140

02.1974→04.1974

FB

Reference

027 115 105	027 115 105	027 115 105 E	027 115 105 E
049 115 105 A	049 115 105 A	055 115 105 D	055 115 105 D



50 005 808





02.1974→07.1980	FB, FX			
Reference	026 121 010 A 026 121 010 AV 026 121 010 D 026 121 010 DV 026 121 010 DX 055 121 010 055 121 010 X 056 121 011 056 121 013 A 068 121 010			50 005 150
	mit Gegengehäuse/with backhousing/avec demi-corps/con remate/c задним корпусом			
Scirocco 1.6				338
08.1975→07.1990	EM, FR, HN, RE			
Reference	026 121 010 026 121 010 C 026 121 010 CV 026 121 010 CX 026 121 010 F 026 121 010 FV 026 121 010 FX 026 121 010 V 026 121 010 X 037 121 010 037 121 010 A 037 121 010 AX 068 121 010 A 068 121 010 AX			50 005 151
	mit Gegengehäuse/with backhousing/avec demi-corps/con remate/c задним корпусом EM: 08.1980→ FR: ch ...C-630 001→			
→	EE, EF, EJ, EM, FN, FR			
Reference	056 121 005 056 121 005 A 068 121 005 068 121 005 B 068 121 005 C 068 121 005 X			50 005 140
	ohne Gegengehäuse/without backhousing/sans demi-corps/sin remate/без заднего корпуса EM: →07.1980 FR: →ch C-630 000			
→	EE, EF, EJ, EM, FN, FR, HN, RE			
Reference	027 115 105 027 115 105 027 115 105 E 027 115 105 E 049 115 105 A 049 115 105 A 055 115 105 D 055 115 105 D			50 005 808
08.1975→07.1990	EM, FR, HN, RE			
Reference	026 121 005 A 026 121 005 C 026 121 005 E 026 121 005 G 026 121 005 H 037 121 005 B 037 121 005 C 068 121 005 A			50 005 148
	ohne Gegengehäuse/without backhousing/sans demi-corps/sin remate/без заднего корпуса EM: 08.1980→ FR: ch ...C-630 001→			
→	EE, EF, EJ, EM, FN, FR			
Reference	026 121 010 A 026 121 010 AV 026 121 010 D 026 121 010 DV 026 121 010 DX 055 121 010 055 121 010 X 056 121 011 056 121 013 A 068 121 010			50 005 150
	mit Gegengehäuse/with backhousing/avec demi-corps/con remate/c задним корпусом EM: →07.1980 FR: →ch. C-630 000			
Scirocco 1.6i				339
08.1976→07.1991	EG, EW			
Reference	026 121 010 026 121 010 C 026 121 010 CV 026 121 010 CX 026 121 010 F 026 121 010 FV 026 121 010 FX 026 121 010 V 026 121 010 X 037 121 010 037 121 010 A 037 121 010 AX 068 121 010 A 068 121 010 AX			50 005 151
	mit Gegengehäuse/with backhousing/avec demi-corps/con remate/c задним корпусом EG: ch ...C-630 001→			
08.1975→07.1982	EG, FN, FP, FT, FV			
Reference	056 121 005 056 121 005 A 068 121 005 068 121 005 B 068 121 005 C 068 121 005 X			50 005 140
	ohne Gegengehäuse/without backhousing/sans demi-corps/sin remate/без заднего корпуса EG: →ch C-630 000			





08.1975→07.1991 Reference	EG, EW, FN, FP, FT, FV 027 115 105 027 115 105 027 115 105 E 027 115 105 E 049 115 105 A 049 115 105 A 055 115 105 D 055 115 105 D		50 005 808	
08.1976→07.1991 Reference 	EG, EW 026 121 005 A 026 121 005 C 026 121 005 E 026 121 005 G 026 121 005 H 037 121 005 B 037 121 005 C 068 121 005 A ohne Gegengehäuse/without backhousing/sans demi-corps/sin remate/без заднего корпуса EG: ch...-C-630 001→			50 005 148
08.1975→07.1982 Reference 	EG, FN, FP, FT, FV 026 121 010 A 026 121 010 AV 026 121 010 D 026 121 010 DV 026 121 010 DX 055 121 010 055 121 010 X 056 121 011 056 121 013 A 068 121 010 mit Gegengehäuse/with backhousing/avec demi-corps/con remate/с задним корпусом EG: →ch. C-630 000			50 005 150
Scirocco 1.7i				340
08.1980→07.1983 Reference 	EN 026 121 010 026 121 010 C 026 121 010 CV 026 121 010 CX 026 121 010 F 026 121 010 FV 026 121 010 FX 026 121 010 V 026 121 010 X 037 121 010 037 121 010 A 037 121 010 AX 068 121 010 A 068 121 010 AX mit Gegengehäuse/with backhousing/avec demi-corps/con remate/с задним корпусом			50 005 151
08.1980→07.1983 Reference	EN 027 115 105 027 115 105 027 115 105 E 027 115 105 E 049 115 105 A 049 115 105 A 055 115 105 D 055 115 105 D		50 005 808	
08.1980→07.1983 Reference 	EN 026 121 005 A 026 121 005 C 026 121 005 E 026 121 005 G 026 121 005 H 037 121 005 B 037 121 005 C 068 121 005 A ohne Gegengehäuse/without backhousing/sans demi-corps/sin remate/без заднего корпуса			50 005 148
Scirocco 1.8i				341
08.1982→07.1992 Reference 	DX, EX, JH, JJ, KT 026 121 010 026 121 010 C 026 121 010 CV 026 121 010 CX 026 121 010 F 026 121 010 FV 026 121 010 FX 026 121 010 V 026 121 010 X 037 121 010 037 121 010 A 037 121 010 AX 068 121 010 A 068 121 010 AX mit Gegengehäuse/with backhousing/avec demi-corps/con remate/с задним корпусом			50 005 151
08.1982→07.1992 Reference	DX, EX, JH, JJ, KT 027 115 105 027 115 105 027 115 105 E 027 115 105 E 049 115 105 A 049 115 105 A 055 115 105 D 055 115 105 D		50 005 808	
08.1982→07.1992 Reference 	DX, EX, JH, JJ, KT 026 121 005 A 026 121 005 C 026 121 005 E 026 121 005 G 026 121 005 H 037 121 005 B 037 121 005 C 068 121 005 A ohne Gegengehäuse/without backhousing/sans demi-corps/sin remate/без заднего корпуса			50 005 148





**Scirocco 1.8i 16V****342**

08.1984→07.1992	KR, PL						
Reference	026 121 010	026 121 010 C	026 121 010 CV	026 121 010 CX		50 005 151	
	026 121 010 F	026 121 010 FV	026 121 010 FX	026 121 010 V			
	026 121 010 X	037 121 010	037 121 010 A	037 121 010 AX			
	068 121 010 A	068 121 010 AX					
	mit Gegengehäuse/with backhousing/avec demi-corps/con remate/c задним корпусом						
08.1984→07.1992	KR, PL						
Reference	026 121 005 A	026 121 005 C	026 121 005 E	026 121 005 G		50 005 148	
	026 121 005 H	037 121 005 B	037 121 005 C	068 121 005 A			
	ohne Gegengehäuse/without backhousing/sans demi-corps/sin remate/без заднего корпуса						
08.1984→07.1992	KR, PL						
Reference	027 115 105 A	027 115 105 A	027 115 105 C	027 115 105 C		50 005 803	
	068 115 105 AG	068 115 105 AG	068 115 105 Q	068 115 105 Q			

Sharan 1.8i Turbo 20V**343**

04.2000→	AWC						
Reference	06A 115 105	06A 115 105	06A 115 105	06A 115 105		50 005 819	
	06A 115 105 B	06A 115 105 B	06A 115 105 B	06A 115 105 B			
	06A 115 105 C	06A 115 105 C	06A 115 105 C	06A 115 105 C			
	06A 115 105 D	06A 115 105 D	06A 115 105 D	06A 115 105 D			
11.1997→	AJH, AWC						
						50 005 131	

Sharan 1.9 TDI**344**

09.1995→02.2000	1Z, AFN, AHU						
Reference	026 121 010	026 121 010 C	026 121 010 CV	026 121 010 CX		50 005 151	
	026 121 010 F	026 121 010 FV	026 121 010 FX	026 121 010 V			
	026 121 010 X	037 121 010	037 121 010 A	037 121 010 AX			
	068 121 010 A	068 121 010 AX					
	mit Gegengehäuse/with backhousing/avec demi-corps/con remate/c задним корпусом						
09.1995→02.2000	1Z, AFN, AHU						
Reference	026 121 005 A	026 121 005 C	026 121 005 E	026 121 005 G		50 005 148	
	026 121 005 H	037 121 005 B	037 121 005 C	068 121 005 A			
	ohne Gegengehäuse/without backhousing/sans demi-corps/sin remate/без заднего корпуса						
01.2005→05.2007	BTB						
Reference	045 121 011B	045 121 011F	045 121 011H	045 121 011HX		50 005 556	
03.1999→	ANU						
Reference	038 121 011 G					50 005 783	

V



09.1995→02.2000 Reference	1Z, AFN, AHU, AVG	028 115 105 G	028 115 105 G	068 115 105 BK	068 115 105 BK	 50 005 806
03.1999→ Reference	ANU, AUY, BVK	06A 115 105 06A 115 105 B 06A 115 105 C 06A 115 105 D	06A 115 105 06A 115 105 B 06A 115 105 C 06A 115 105 D	06A 115 105 06A 115 105 B 06A 115 105 C 06A 115 105 D	06A 115 105 06A 115 105 B 06A 115 105 C 06A 115 105 D	 50 005 819
04.2000→ Reference	ASZ, AUY	038 121 001 C 038 121 011J	038 121 011 C 038 121 011K	038 121 011 D 038 121 011KX	038 121 011G	 50 005 554
Sharan 2.0i						345
09.1995→02.2000 Reference	ADY	026 121 010 026 121 010 F 026 121 010 X 068 121 010 A	026 121 010 C 026 121 010 FV 037 121 010 068 121 010 AX	026 121 010 CV 026 121 010 FX 037 121 010 A	026 121 010 CX 026 121 010 V 037 121 010 AX	 50 005 151
		mit Gegengehäuse/with backhousing/avec demi-corps/con remate/с задним корпусом				
09.1995→02.2000 Reference	ADY	026 121 005 A 026 121 005 H	026 121 005 C 037 121 005 B	026 121 005 E 037 121 005 C	026 121 005 G 068 121 005 A	 50 005 148
		ohne Gegengehäuse/without backhousing/sans demi-corps/sin remate/без заднего корпуса				
04.2000→ Reference	ATM	06A 115 105 06A 115 105 B 06A 115 105 C 06A 115 105 D	06A 115 105 06A 115 105 B 06A 115 105 C 06A 115 105 D	06A 115 105 06A 115 105 B 06A 115 105 C 06A 115 105 D	06A 115 105 06A 115 105 B 06A 115 105 C 06A 115 105 D	 50 005 819
04.2000→	ATM					 50 005 131
09.1995→02.2000 Reference	ADY	027 115 105 B	027 115 105 B			 50 005 805
Sharan 2.0 Gas						346
04.2006→	ATM					 50 005 131
Sharan 2.8i VR6						347
09.1995→02.2000 Reference	AAA, AMY	021 121 004	021 121 004 A			 50 005 165



Sharan 2.8i VR6 24V

348

04.2000→ Reference	AYL 021 121 004 021 121 004 A →ch. 7M-2-035 000			50 005 165
-----------------------	--	---	--	------------

04.2000→ Reference	AYL 022 121 011 ch. 7M-2-525 001→			50 005 008 NEW
-----------------------	---	--	--	--------------------------

Spacefox 1.9 SDI

349

09.2007→ Reference	ASY 045 121 011 C 045 121 011 G			50 005 750
-----------------------	---------------------------------------	---	--	------------

Sportvan 1.9 SDI

350

09.2007→ Reference	ASY 045 121 011 C 045 121 011 G			50 005 750
-----------------------	---------------------------------------	--	--	------------

Suran 1.9 SDI

351

09.2007→ Reference	ASY 045 121 011 C 045 121 011 G			50 005 750
-----------------------	---------------------------------------	---	--	------------

Touareg 2.5 TDI

352

01.2003→11.2006 Reference	BAC, BLK 070 121 011 A 070 121 011 C 070 121 011 D			50 005 007 NEW
------------------------------	---	---	--	--------------------------

Touareg 3.2i 24V

353

11.2002→11.2006 Reference	AZZ, BAA, BKJ, BMV, BMX, BRJ 022 121 011			50 005 008 NEW
------------------------------	---	--	--	--------------------------

Touran 1.6i

354

07.2003→ Reference	BGU, BSE, BSF 06B 121 011 H 06B 121 011 L 06B 121 011 LX 06B 121 011 M			50 005 775
-----------------------	--	---	--	------------

07.2003→ Reference	BGU, BSE, BSF 06A 115 105 06A 115 105 06A 115 105 06A 115 105 06A 115 105 B 06A 115 105 B 06A 115 105 B 06A 115 105 B 06A 115 105 C 06A 115 105 C 06A 115 105 C 06A 115 105 C 06A 115 105 D 06A 115 105 D 06A 115 105 D 06A 115 105 D		50 005 819	
-----------------------	---	---	------------	--

V

**Touran 1.6 FSI 16V****355**

02.2003→01.2007

BAG, BLF, BLP

Reference

03C 121 005 D

03C 121 005 K

03C 121 005 L

**50 005 001****NEW****Touran 1.9 TDI****356**

02.2003→

AVQ, BKC, BLS, BRU, BXE, BXF, BXJ

Reference

045 121 011B

045 121 011F

045 121 011H

045 121 011HX

**50 005 556****Touran 2.0 FSI 16V****357**

10.2003→01.2007

AXW, BLR, BLX, BLY, BVY, BVZ

Reference

06B 121 011 H

06B 121 011L

06B 121 011LX

06B 121 011M

**50 005 775****Touran 2.0i EcoFuel****358**

02.2006→

BSX

Reference

06A 115 105

06A 115 105

06A 115 105

06A 115 105

06A 115 105 B

06A 115 105 B

06A 115 105 B

06A 115 105 B

06A 115 105 C

06A 115 105 C

06A 115 105 C

06A 115 105 C

06A 115 105 D

06A 115 105 D

06A 115 105 D

06A 115 105 D

**50 005 819**

02.2006→

BSX

**50 005 131****Touran 2.0 TDI 16V****359**

02.2003→

AZV, BKD

Reference

038 121 001 C

038 121 011 C

038 121 011 D

038 121 011G

038 121 011J

038 121 011K

038 121 011KX

**50 005 554****Transporter T2 1.6****360**

05.1979→12.1982

CT, CZ

Reference

026 121 010

026 121 010 C

026 121 010 CV

026 121 010 CX

026 121 010 F

026 121 010 FV

026 121 010 FX

026 121 010 V

026 121 010 X

037 121 010

037 121 010 A

037 121 010 AX

068 121 010 A

068 121 010 AX



mit Gegengehäuse/with backhousing/avec demi-corps/con remate/с задним корпусом

CT: 05.1981→

CZ: 05.1981→12.1982

**50 005 151****V**

05.1979→12.1982

CT, CZ

Reference

056 121 005

056 121 005 A

068 121 005

068 121 005 B

068 121 005 C

068 121 005 X



ohne Gegengehäuse/without backhousing/sans demi-corps/sin remate/без заднего корпуса

→04.1981

**50 005 140**

05.1979→12.1982

CT, CZ

Reference

026 121 005 A

026 121 005 C

026 121 005 E

026 121 005 G

026 121 005 H

037 121 005 B

037 121 005 C

068 121 005 A



ohne Gegengehäuse/without backhousing/sans demi-corps/sin remate/без заднего корпуса

05.1981→

**50 005 148**



05.1979→12.1982 Reference	CT, CZ 111 115 107 A 111 115 107 B 111 115 107 BK					50 005 812
05.1979→12.1982 Reference	CT, CZ 026 121 010 A 026 121 010 AV 026 121 010 D 026 121 010 DV 026 121 010 DX 055 121 010 055 121 010 X 056 121 011 056 121 013 A 068 121 010 mit Gegengehäuse/with backhousing/avec demi-corps/con remate/c задним корпусом →04.1981					50 005 150
Transporter T2 1.7 D						361
08.1984→07.1992 Reference	KY 026 121 010 026 121 010 C 026 121 010 CV 026 121 010 CX 026 121 010 F 026 121 010 FV 026 121 010 FX 026 121 010 V 026 121 010 X 037 121 010 037 121 010 A 037 121 010 AX 068 121 010 A 068 121 010 AX mit Gegengehäuse/with backhousing/avec demi-corps/con remate/c задним корпусом					50 005 151
08.1984→07.1992 Reference	KY 026 121 005 A 026 121 005 C 026 121 005 E 026 121 005 G 026 121 005 H 037 121 005 B 037 121 005 C 068 121 005 A ohne Gegengehäuse/without backhousing/sans demi-corps/sin remate/без заднего корпуса					50 005 148
Transporter T2 1.9						362
08.1982→07.1992 Reference	DF, DG, DH 025 121 010 A 025 121 010 AV 025 121 010 AX 025 121 010 D DF, DG: →07.1985					50 005 160
08.1982→07.1992 Reference	DF, DG, DH, SP 111 115 107 A 111 115 107 B 111 115 107 BK					50 005 812
Transporter T2 1.9i						363
08.1983→07.1985 Reference	GW 025 121 010 A 025 121 010 AV 025 121 010 AX 025 121 010 D					50 005 160
08.1983→07.1985 Reference	GW 111 115 107 A 111 115 107 B 111 115 107 BK					50 005 812
Transporter T2 2.1i						364
08.1984→07.1992 Reference	DJ, MV, SR, SS 025 121 010 B 025 121 010 BV 025 121 010 BX 025 121 010 C 025 121 010 CV 025 121 010 CX 025 121 010 E 025 121 010 F					50 005 162
08.1984→07.1992 Reference	DJ, SR, SS 111 115 107 A 111 115 107 B 111 115 107 BK					50 005 812

V



Transporter T2 1.6 D

365

01.1981→07.1987	CS					
Reference	026 121 010 026 121 010 F 026 121 010 X 068 121 010 A	026 121 010 C 026 121 010 FV 037 121 010 068 121 010 AX	026 121 010 CV 026 121 010 FX 037 121 010 A	026 121 010 CX 026 121 010 V 037 121 010 AX		50 005 151
	mit Gegengehäuse/with backhousing/avec demi-corps/con remate/c задним корпусом 215.896→					
01.1981→07.1987	CS					
Reference	056 121 005 068 121 005 C	056 121 005 A 068 121 005 X	068 121 005	068 121 005 B		50 005 140
	ohne Gegengehäuse/without backhousing/sans demi-corps/sin remate/без заднего корпуса →215.895					
01.1981→07.1987	CS					
Reference	026 121 005 A 026 121 005 H	026 121 005 C 037 121 005 B	026 121 005 E 037 121 005 C	026 121 005 G 068 121 005 A		50 005 148
	ohne Gegengehäuse/without backhousing/sans demi-corps/sin remate/без заднего корпуса 215.896→					
01.1981→07.1987	CS					
Reference	068 115 105 AQ	068 115 105 AR	068 115 105 BP	068 115 105 J		50 005 802
01.1981→07.1987	CS					
Reference	026 121 010 A 026 121 010 DX 056 121 013 A	026 121 010 AV 055 121 010 068 121 010	026 121 010 D 055 121 010 X	026 121 010 DV 056 121 011		50 005 150
	mit Gegengehäuse/with backhousing/avec demi-corps/con remate/c задним корпусом →215.895					

Transporter T3 1.6 TD

366

08.1984→07.1992	JX					
Reference	026 121 010 026 121 010 F 026 121 010 X 068 121 010 A	026 121 010 C 026 121 010 FV 037 121 010 068 121 010 AX	026 121 010 CV 026 121 010 FX 037 121 010 A	026 121 010 CX 026 121 010 V 037 121 010 AX		50 005 151
	mit Gegengehäuse/with backhousing/avec demi-corps/con remate/c задним корпусом 012.053→					
08.1984→07.1992	JX					
Reference	056 121 005 068 121 005 C	056 121 005 A 068 121 005 X	068 121 005	068 121 005 B		50 005 140
	ohne Gegengehäuse/without backhousing/sans demi-corps/sin remate/без заднего корпуса →012.052					
08.1984→07.1992	JX					
Reference	026 121 005 A 026 121 005 H	026 121 005 C 037 121 005 B	026 121 005 E 037 121 005 C	026 121 005 G 068 121 005 A		50 005 148
	ohne Gegengehäuse/without backhousing/sans demi-corps/sin remate/без заднего корпуса 012.053→					
08.1984→07.1992	JX					
Reference	026 121 010 A 026 121 010 DX 056 121 013 A	026 121 010 AV 055 121 010 068 121 010	026 121 010 D 055 121 010 X	026 121 010 DV 056 121 011		50 005 150
	mit Gegengehäuse/with backhousing/avec demi-corps/con remate/c задним корпусом →ch. 012.052					

**Transporter T4 1.8i****367**

09.1990→07.1992	PD					
Reference	026 121 010 026 121 010 F 026 121 010 X 068 121 010 A	026 121 010 C 026 121 010 FV 037 121 010 068 121 010 AX	026 121 010 CV 026 121 010 FX 037 121 010 A	026 121 010 CX 026 121 010 V 037 121 010 AX		50 005 151
	mit Gegengehäuse/with backhousing/avec demi-corps/con remate/c задним корпусом					
09.1990→07.1992	PD					
Reference	026 121 005 A 026 121 005 H	026 121 005 C 037 121 005 B	026 121 005 E 037 121 005 C	026 121 005 G 068 121 005 A		50 005 148
	ohne Gegengehäuse/without backhousing/sans demi-corps/sin remate/без заднего корпуса					

Transporter T4 1.9 D**368**

09.1990→12.1995	1X					
Reference	026 121 010 026 121 010 F 026 121 010 X 068 121 010 A	026 121 010 C 026 121 010 FV 037 121 010 068 121 010 AX	026 121 010 CV 026 121 010 FX 037 121 010 A	026 121 010 CX 026 121 010 V 037 121 010 AX		50 005 151
	mit Gegengehäuse/with backhousing/avec demi-corps/con remate/c задним корпусом					
09.1990→12.1995	1X					
Reference	028 115 105 D					50 005 800
09.1990→12.1995	1X					
Reference	026 121 005 A 026 121 005 H	026 121 005 C 037 121 005 B	026 121 005 E 037 121 005 C	026 121 005 G 068 121 005 A		50 005 148
	ohne Gegengehäuse/without backhousing/sans demi-corps/sin remate/без заднего корпуса					

Transporter T4 1.9 TD**369**

10.1992→06.2003	ABL					
Reference	026 121 010 026 121 010 F 026 121 010 X 068 121 010 A	026 121 010 C 026 121 010 FV 037 121 010 068 121 010 AX	026 121 010 CV 026 121 010 FX 037 121 010 A	026 121 010 CX 026 121 010 V 037 121 010 AX		50 005 151
	mit Gegengehäuse/with backhousing/avec demi-corps/con remate/c задним корпусом					
10.1992→06.2003	ABL					
Reference	028 115 105 D					50 005 800
10.1992→06.2003	ABL					
Reference	026 121 005 A 026 121 005 H	026 121 005 C 037 121 005 B	026 121 005 E 037 121 005 C	026 121 005 G 068 121 005 A		50 005 148
	ohne Gegengehäuse/without backhousing/sans demi-corps/sin remate/без заднего корпуса					

Transporter T4 2.0i**370**

09.1990→06.2003	AAC					
Reference	026 121 010 026 121 010 F 026 121 010 X 068 121 010 A	026 121 010 C 026 121 010 FV 037 121 010 068 121 010 AX	026 121 010 CV 026 121 010 FX 037 121 010 A	026 121 010 CX 026 121 010 V 037 121 010 AX		50 005 151
	mit Gegengehäuse/with backhousing/avec demi-corps/con remate/c задним корпусом					



09.1990→06.2003 Reference 	AAC 026 121 005 A 026 121 005 C 026 121 005 E 026 121 005 G 026 121 005 H 037 121 005 B 037 121 005 C 068 121 005 A ohne Gegengehäuse/without backhousing/sans demi-corps/sin remate/без заднего корпуса			50 005 148
Transporter T4 2.4 D				371
09.1990→09.1998 Reference 	AAB 023 121 004 023 121 004 V 023 121 004 X →320.127			50 005 163
09.1990→06.2003 Reference 	AAB, AJA 074 121 004 B 074 121 005 N 074 121 005 NX 074 121 005M 074 121 005MX 20 Zähne/teeth/dientes/dents/зубьев AAB: 320.128→ AJA: →ch. 70-Y-075 000			50 005 555
09.1990→06.2003 Reference 	AAB, AJA 074 121 004 074 121 004 A 074 121 004 V 074 121 004 X 18 Zähne/teeth/dientes/dents/зубьев AAB: 320.128→ AJA: →ch. 70-Y-075 000			50 005 551
Transporter T4 2.5i				372
09.1990→10.1996 Reference 	AAF, ACU 023 121 004 023 121 004 V 023 121 004 X ch→ch. 70-N-014 000			50 005 163
09.1990→06.2003 Reference 	AAF, ACU, AEN, AET, AEU, APL, AVT 074 121 004 B 074 121 005 N 074 121 005 NX 074 121 005M 074 121 005MX 20 Zähne/teeth/dientes/dents/зубьев AAF, ACU: ch 70-N-014 001→			50 005 555
09.1990→06.2003 Reference 	AAF, ACU, AET, AEU 074 121 004 074 121 004 A 074 121 004 V 074 121 004 X 18 Zähne/teeth/dientes/dents/зубьев AAF, ACU: ch 70-N-014 001→			50 005 551
Transporter T4 2.5 TDI				373
09.1995→06.2003 Reference 	ACV, AHY, AJT, AUF, AXL, AYC, AYY 074 121 004 B 074 121 005 N 074 121 005 NX 074 121 005M 074 121 005MX 20 Zähne/teeth/dientes/dents/зубьев AHY, AJT: →ch. 70-Y-075 000			50 005 555
V 09.1995→06.2003 Reference 	ACV, AHY, AJT 074 121 004 074 121 004 A 074 121 004 V 074 121 004 X 18 Zähne/teeth/dientes/dents/зубьев AHY, AJT: →ch. 70-Y-075 000			50 005 551



Transporter T4 2.8i VR6

374

01.1996→05.2000

AES

Reference

021 121 004

021 121 004 A

50 005 165

Transporter T5 1.9 TDI

375

04.2003→

AXB, AXC, BRR, BRS

Reference

045 121 011B

045 121 011F

045 121 011H

045 121 011HX

50 005 556

Transporter T5 2.0i

376

11.2003→

AXA

Reference

06A 115 105

06A 115 105

06A 115 105

06A 115 105

06A 115 105 B

06A 115 105 B

06A 115 105 B

06A 115 105 B

06A 115 105 C

06A 115 105 C

06A 115 105 C

06A 115 105 C

06A 115 105 D

06A 115 105 D

06A 115 105 D

06A 115 105 D

AXA: 7H-3-000 001→7H-3-001 000

AXA: 7H-6-000 001→7H-6-200 000

AXA: 7H-7-000 001→7H-7-200 000

AXA: 7H-8-000 001→7H-8-200 000

AXA: 7H-9-000 001→

AXA: 7J-3-000 001→7J-3-001 000

AXA: 7J-7-000 001→7J-7-040 000

AXA: 7J-8-000 001→7J-8-030 000

AXA: 7J-9-000 001→

50 005 819

11.2003→

AXA

50 005 131

Transporter T5 2.5 TDI

377

04.2003→

AXD, AXE

Reference

070 121 011 A

070 121 011 C

070 121 011 D

50 005 007
NEW

Transporter T5 3.2i 24V

378

02.2004→

BDL, BKK

Reference

022 121 011

50 005 008
NEW

Van 1.9 D

379

10.2005→

1Y

Reference

026 121 010

026 121 010 C

026 121 010 CV

026 121 010 CX

026 121 010 F

026 121 010 FV

026 121 010 FX

026 121 010 V

026 121 010 X

037 121 010

037 121 010 A

037 121 010 AX

068 121 010 A

068 121 010 AX

mit Gegengehäuse/with backhousing/avec demi-corps/con remate/c задним корпусом

50 005 151

10.2005→

1Y

Reference

026 121 005 A

026 121 005 C

026 121 005 E

026 121 005 G

026 121 005 H

037 121 005 B

037 121 005 C

068 121 005 A

ohne Gegengehäuse/without backhousing/sans demi-corps/sin remate/без заднего корпуса

50 005 148
V

**Vanagon 1.6 D****380**

08.1981→07.1984	CS, JK						
Reference	026 121 010 026 121 010 F 026 121 010 X 068 121 010 A	026 121 010 C 026 121 010 FV 037 121 010 068 121 010 AX	026 121 010 CV 026 121 010 FX 037 121 010 A	026 121 010 CX 026 121 010 V 037 121 010 AX			50 005 151
	mit Gegengehäuse/with backhousing/avec demi-corps/con remate/с задним корпусом CS: 215.896→						
08.1981→07.1984	CS						
Reference	056 121 005 068 121 005 C	056 121 005 A 068 121 005 X	068 121 005	068 121 005 B			50 005 140
	ohne Gegengehäuse/without backhousing/sans demi-corps/sin remate/без заднего корпуса →215.895						
08.1981→07.1984	CS, JK						
Reference	026 121 005 A 026 121 005 H	026 121 005 C 037 121 005 B	026 121 005 E 037 121 005 C	026 121 005 G 068 121 005 A			50 005 148
	ohne Gegengehäuse/without backhousing/sans demi-corps/sin remate/без заднего корпуса CS: 215.896→						
08.1981→07.1984	CS						
Reference	026 121 010 A 026 121 010 DX 056 121 013 A	026 121 010 AV 055 121 010 068 121 010	026 121 010 D 055 121 010 X	026 121 010 DV 056 121 011			50 005 150
	mit Gegengehäuse/with backhousing/avec demi-corps/con remate/с задним корпусом →215.895						

Vanagon 1.9**381**

01.1983→07.1985	DH						
Reference	025 121 010 A	025 121 010 AV	025 121 010 AX	025 121 010 D			50 005 160

Vanagon 2.1i**382**

08.1985→07.1992	MV						
Reference	025 121 010 B 025 121 010 CV	025 121 010 BV 025 121 010 CX	025 121 010 BX 025 121 010 E	025 121 010 C 025 121 010 F			50 005 162

Vento 1.4i**383**

01.1992→07.1995	ABD						
Reference	030 115 105 C 030 115 105 E →1H-S-078 143	030 115 105 C 030 115 105 E	030 115 105 D	030 115 105 D		50 005 868	
01.1992→07.1995	ABD						
Reference	030 121 004 A 030 121 005 LV	030 121 004 B 030 121 005 LX	030 121 005 H	030 121 005 L			50 005 153
07.1995→10.1998	AEX, APQ						
Reference	030 121 005 N 030 121 008 DX	030 121 005 NV	030 121 005 NX	030 121 008 D			50 005 139



07.1995→12.1997	AEX					
Reference	036 115 105 B 036 115 105 D	036 115 105 B 036 115 105 D	036 115 105 B 036 115 105 D	036 115 105 B 036 115 105 D		50 005 844
Vento 1.6i						384
10.1994→12.1997	AEK, AFT, AKS					
Reference	026 121 010 026 121 010 F 026 121 010 X 068 121 010 A	026 121 010 C 026 121 010 FV 037 121 010 068 121 010 AX	026 121 010 CV 026 121 010 FX 037 121 010 A	026 121 010 CX 026 121 010 V 037 121 010 AX		50 005 151
	mit Gegengehäuse/with backhousing/avec demi-corps/con remate/c задним корпусом					
10.1994→12.1997	AEK, AFT, AKS					
Reference	027 115 105 049 115 105 A	027 115 105 049 115 105 A	027 115 105 E 055 115 105 D	027 115 105 E 055 115 105 D		50 005 808
10.1994→12.1997	AEK, AFT, AKS					
Reference	026 121 005 A 026 121 005 H	026 121 005 C 037 121 005 B	026 121 005 E 037 121 005 C	026 121 005 G 068 121 005 A		50 005 148
	ohne Gegengehäuse/without backhousing/sans demi-corps/sin remate/без заднего корпуса					
08.1992→09.1994	ABU					
Reference	030 121 004 A 030 121 005 LV	030 121 004 B 030 121 005 LX	030 121 005 H	030 121 005 L		50 005 153
10.1994→12.1997	AEA, AEE					
Reference	030 121 005 N 030 121 008 DX	030 121 005 NV	030 121 005 NX	030 121 008 D		50 005 139
07.1995→12.1997	AEE					
Reference	036 115 105 B 036 115 105 D	036 115 105 B 036 115 105 D	036 115 105 B 036 115 105 D	036 115 105 B 036 115 105 D		50 005 844
Vento 1.8i						385
01.1992→12.1997	AAM, ABS, ADZ					
Reference	026 121 010 026 121 010 F 026 121 010 X 068 121 010 A	026 121 010 C 026 121 010 FV 037 121 010 068 121 010 AX	026 121 010 CV 026 121 010 FX 037 121 010 A	026 121 010 CX 026 121 010 V 037 121 010 AX		50 005 151
	mit Gegengehäuse/with backhousing/avec demi-corps/con remate/c задним корпусом					
01.1992→12.1997	AAM, ABS, ADZ					
Reference	027 115 105 049 115 105 A	027 115 105 049 115 105 A	027 115 105 E 055 115 105 D	027 115 105 E 055 115 105 D		50 005 808
01.1992→	AAM, ABS, ADD, ADZ					
Reference	026 121 005 A 026 121 005 H	026 121 005 C 037 121 005 B	026 121 005 E 037 121 005 C	026 121 005 G 068 121 005 A		50 005 148
	ohne Gegengehäuse/without backhousing/sans demi-corps/sin remate/без заднего корпуса					

V

**Vento 1.9 D****386**

01.1992→12.1997	1Y					
Reference	026 121 010 026 121 010 F 026 121 010 X 068 121 010 A	026 121 010 C 026 121 010 FV 037 121 010 068 121 010 AX	026 121 010 CV 026 121 010 FX 037 121 010 A	026 121 010 CX 026 121 010 V 037 121 010 AX		50 005 151
	mit Gegengehäuse/with backhousing/avec demi-corps/con remate/c задним корпусом					
01.1992→12.1997	1Y					
Reference	026 121 005 A 026 121 005 H	026 121 005 C 037 121 005 B	026 121 005 E 037 121 005 C	026 121 005 G 068 121 005 A		50 005 148
	ohne Gegengehäuse/without backhousing/sans demi-corps/sin remate/без заднего корпуса					
01.1992→12.1997	1Y					
Reference	028 115 105 G	028 115 105 G	068 115 105 BK	068 115 105 BK		50 005 806

Vento 1.9 TD**387**

03.1991→12.1997	AAZ					
Reference	026 121 010 026 121 010 F 026 121 010 X 068 121 010 A	026 121 010 C 026 121 010 FV 037 121 010 068 121 010 AX	026 121 010 CV 026 121 010 FX 037 121 010 A	026 121 010 CX 026 121 010 V 037 121 010 AX		50 005 151
	mit Gegengehäuse/with backhousing/avec demi-corps/con remate/c задним корпусом					
03.1991→12.1997	AAZ					
Reference	026 121 005 A 026 121 005 H	026 121 005 C 037 121 005 B	026 121 005 E 037 121 005 C	026 121 005 G 068 121 005 A		50 005 148
	ohne Gegengehäuse/without backhousing/sans demi-corps/sin remate/без заднего корпуса					
03.1991→12.1997	AAZ					
Reference	028 115 105 G	028 115 105 G	068 115 105 BK	068 115 105 BK		50 005 806

Vento 1.9 TDI**388**

07.1993→12.1997	1Z, AFN, AHU, ALE					
Reference	026 121 010 026 121 010 F 026 121 010 X 068 121 010 A	026 121 010 C 026 121 010 FV 037 121 010 068 121 010 AX	026 121 010 CV 026 121 010 FX 037 121 010 A	026 121 010 CX 026 121 010 V 037 121 010 AX		50 005 151
	mit Gegengehäuse/with backhousing/avec demi-corps/con remate/c задним корпусом					
07.1993→12.1997	1Z, AFN, AHU					
Reference	028 121 004	028 121 004 V	028 121 004 X			50 005 158
07.1993→12.1997	1Z, AFN, AHU, ALE					
Reference	026 121 005 A 026 121 005 H	026 121 005 C 037 121 005 B	026 121 005 E 037 121 005 C	026 121 005 G 068 121 005 A		50 005 148
	ohne Gegengehäuse/without backhousing/sans demi-corps/sin remate/без заднего корпуса					

V



11.2005→ Reference	BKC, BXE 045 121 011B 045 121 011F 045 121 011H 045 121 011HX					50 005 556
07.1993→12.1997 Reference	1Z, AFN, AHU, ALE 028 115 105 G 028 115 105 G 068 115 105 BK 068 115 105 BK					50 005 806
Vento 1.9 SDI						389
07.1995→12.1997 Reference	AEY 026 121 010 026 121 010 C 026 121 010 CV 026 121 010 CX 026 121 010 F 026 121 010 FV 026 121 010 FX 026 121 010 V 026 121 010 X 037 121 010 037 121 010 A 037 121 010 AX 068 121 010 A 068 121 010 AX mit Gegengehäuse/with backhousing/avec demi-corps/con remate/c задним корпусом 09.1996→					50 005 151
07.1995→12.1997 Reference	AEY 028 121 004 028 121 004 V 028 121 004 X					50 005 158
07.1995→12.1997 Reference	AEY 026 121 005 A 026 121 005 C 026 121 005 E 026 121 005 G 026 121 005 H 037 121 005 B 037 121 005 C 068 121 005 A ohne Gegengehäuse/without backhousing/sans demi-corps/sin remate/без заднего корпуса					50 005 148
07.1995→12.1997 Reference	AEY 028 115 105 G 028 115 105 G 068 115 105 BK 068 115 105 BK					50 005 806
Vento 2.0i						390
01.1992→12.1997 Reference	2E, ADY, AEP, AGG, AKR 026 121 010 026 121 010 C 026 121 010 CV 026 121 010 CX 026 121 010 F 026 121 010 FV 026 121 010 FX 026 121 010 V 026 121 010 X 037 121 010 037 121 010 A 037 121 010 AX 068 121 010 A 068 121 010 AX mit Gegengehäuse/with backhousing/avec demi-corps/con remate/c задним корпусом					50 005 151
01.1992→12.1997 Reference	2E, ADY, AEP, AGG, AKR 026 121 005 A 026 121 005 C 026 121 005 E 026 121 005 G 026 121 005 H 037 121 005 B 037 121 005 C 068 121 005 A ohne Gegengehäuse/without backhousing/sans demi-corps/sin remate/без заднего корпуса					50 005 148
01.1992→07.1998 Reference	2E, ADC, ADY, AEP, AGG, AKR 027 115 105 B 027 115 105 B					50 005 805

V



Vento 2.0 TDI 16V

391

02.2006→

BKD

Reference

038 121 001 C
038 121 011J038 121 011 C
038 121 011K038 121 011 D
038 121 011KX

038 121 011G



50 005 554

Vento 2.8i VR6

392

01.1992→12.1997

AAA

Reference

021 121 004

021 121 004 A



50 005 165

Engine

393

02.1999→05.2000

AER

Reference

030 121 005 S
037 121 008 C

030 121 008 A





030 121 008 C

030 121 008 CX







50 005 137



			Cyl	 mm	cm ³		Comp. Ratio ε	kW	PS	Pos
4.236	D	(AN)	4	98,48 x 126,8	3864	2	16:1	48-60	59-80	128, 129, 130, 131
B 16 F	B		4	78 x 83,5	1596	2	10,1	61	83	15, 20
B 17 A	B		4	84,14 x 80	1780	2		66	90	1
B 18 E	B		4	81 x 83,5	1721	2	9,5:1	70-75	95-102	26
B 18 EP	B		4	81 x 83,5	1721	2	10:1	74-80	101-109	16, 21, 26
B 18 F	B		4	81 x 83,5	1721	2	10:1	70-75	95-102	16, 21, 26
B 18 FP	B		4	81 x 83,5	1721	2	10:1	75	102	16, 21, 26
B 18 FT	B	(A)	4	81 x 83,5	1721	2	8:1	88-90	120-122	18, 22, 27
B 18 K	B		4	81 x 83,5	1721	2	9,5:1	60	82	16, 21
B 18 KP	B		4	81 x 83,5	1721	2	9,5:1	55	90	16, 21
B 18 KPD	B		4	81 x 83,5	1721	2	9,5:1	64	87	16
B 18 U	B		4	82,7 x 83,5	1794	2	9,7:1	66	90	17, 23
B 19 A	B		4	88,9 x 80	1986	2	8,5:1	66-75	90-102	14, 29
B 19 ET	B	(A)	4	88,9 x 80	1986	2	9,3:1	110	150	3, 30
B 20 F 208	B		4	82,7 x 93	1998	2	9,5:1	80	109	19, 25, 28
B 21 A	B		4	92 x 79,4	2112	2	9,3:1	74	100	4
B 21 E	B		4	92 x 79,4	2112	2	9,3:1	90	122	4, 5
B 21 ET	B	(A)	4	92 x 79,4	2112	2	7,5:1	114	155	6
B 21 F	B		4	92 x 79,4	2112	2		71	97	4
B 23 A	B		4	96 x 80	2316	2	8,5/ 10,3:1	77-84	105-114	7, 37
B 23 E	B		4	96 x 80	2316	2	10,3:1	96	131	7, 8, 31, 33
B 23 ET	B	(A)	4	96 x 80	2316	2	9:1	125	170	38
B 200 F	B		4	88,9 x 80	1986	2	10:1	82	111	29, 48
B 200 K	B		4	88,9 x 80	1986	2	9,2:1	72-76	98-103	2, 14, 19
B 204 FT	B	(LA)	4	88,9 x 80	1986	4	8,2:1	140	190	49, 58
B 230 A	B		4	96 x 80	2316	2	10,3:1	78-82	106-111	7, 31
B 230 E	B		4	96 x 80	2316	2	10,3:1	96	131	7, 31, 37, 50, 59
B 230 ET	B	(LA)	4	96 x 80	2316	2	9:1	134	182	32, 38
B 230 F	B		4	96 x 80	2316	2	9,8:1	85	116	7, 51
B 230 FT	B	(A)	4	96 x 80	2316	2	8,7:1	121	165	32, 56, 61
B 230 K	B		4	96 x 80	2316	2	10,3:1	78-86	106-117	7, 31
B 234 F	B		4	96 x 80	2316	4	10:1	114	155	34, 52, 60
B 172 K	B		4	81 x 82,9	1709	2	10:1	59	80	11, 13
B 4164 S	B		4	81 x 77	1587	4	10,3:1	77	105	72
B 4164 S3	B		4	81 x 77	1587	4	11:1	74	100	65, 72, 98, 106
B 4184 S	B		4	83 x 80	1731	4	10,5:1	85	116	74, 99
B 4184 SM	B		4	81 x 89	1834	4	12,5:1	92	125	74, 99
B 4194 T	B	(A)	4	81 x 90	1855	4	8,5:1	147	200	75, 100
B 4204 S	B		4	83 x 90	1948	4	10,5:1	103	140	78, 103
B 4204 T	B	(LA)	4	83 x 90	1948	4	9:1	118	160	80, 105
B 5202 S	B		5	81 x 77	1984	2	10:1	93	126	42, 84, 109
B 5204 S	B		5	81 x 77	1984	4	10,3:1	105	143	41, 79, 85, 104, 110
B 5204 T	B	(LA)	5	81 x 77	1984	4	8,4:1	155	211	43, 86, 111
B 5234 T3	B	(LA)	5	81 x 90	2319	4	8,5:1	176-184	239-250	44, 70, 82, 87, 112, 118
B 5244 T	B	(LA)	5	83 x 90	2435	4	9:1	142	193	69, 88, 113
B 5252 S	B		5	83 x 90	2435	2	10:1	103-106	140-144	45, 89, 114
B 5254 S	B		5	83 x 90	2435	4	10,5:1	121-125	165-170	46, 71, 90, 115
B 6284 T	B	(LA)	6	81 x 90	2783	4	8,7:1	200	272	95
B 6294 S	B		6	83 x 90	2922	4	10,3:1	147	200	96
B 6294 T	B	(LA)	6	83 x 90	2922	4	8,5:1	200	272	97, 123
B 6304 F1	B		6	83 x 90	2922	4	10,7:1	150	204	36, 55, 64
B 6304 S3	B		6	83 x 90	2922	4	10,7:1	150	204	96
D 10 A 310	D	(LA)	6	120,65 x 140	9600	2	20:1	228	310	134
D 10 A 320	D	(LA)	6	120,65 x 140	9600	2	20:1	234	318	134, 139
D 10 A 350	D	(LA)	6	120,65 x 140	9600	2	20:1	258	351	134
D 10 A 360	D	(LA)	6	120,65 x 140	9600	2	20:1	265	360	134
D 16	D	(AN)	4	78 x 83,5	1596	2		40	54	10, 12
D 16 C 550	D	(LA)	6	144 x 165	16120	4	18:1	404	550	132
D 16 C 610	D	(LA)	6	144 x 165	16120	4	18:1	449	610	133
D 24	D	(AN)	6	76,5 x 86,4	2383	2	23:1	60	82	9, 35, 39, 53, 62
D 24 TIC	D	(LA)	6	76,5 x 86,4	2383	2	23:1	90	122	40, 54, 57, 63
D 4164 T	D	(LA)	4	75 x 88,3	1560	4	18,3:1	80	109	66, 73, 107
D 4192 T	D	(A)	4	80 x 93	1870	2	20,5:1	66	90	76, 101
D 4192 T3	D	(A)	4	80 x 93	1870	2	19:1	85	115	77, 102
D 4192 T4	D	(A)	4	80 x 93	1870	2	19:1	75	102	77, 102
D 4204 T	D	(LA)	4	85 x 88	1998	4	18,5:1	100	136	67, 68, 81, 92, 108, 117
D 4204 T2	D	(LA)	4	85 x 88	1998	4	18,5:1	98	133	81, 108



			Cyl	 mm	cm ³		Comp. Ratio ε	kW	PS	Pos
D 5244 T	D	(LA)	5	81 x 93,2	2401	4	18/ 18,5:1	120	163	83, 93, 120, 121, 122
D 5244 T2	D	(LA)	5	81 x 93,2	2401	4	18:1	96	130	83, 93, 120
D 5252 T	D	(LA)	5	81 x 95,5	2461	2	20,5:1	103	140	47, 91, 94, 116, 119
F3N 718	B		4	81 x 83,5	1721	2	9,5:1	53-55	73-75	13
F8Q 610	D	(A)	4	80 x 93	1870	2	20,5:1	66-68	90-92	24
F8Q 784	D	(A)	4	80 x 93	1870	2	20,5:1	66-70	90-95	24
TD 101 F	D	(LA)	6	120,65 x 140	9600	2	14,3:1	215-220	292-299	126, 134, 137
TD 102 F	D	(LA)	6	120,65 x 140	9600	2	15:1	230-234	312-318	126, 134, 137, 139
TD 120 A	D	(A)	6	130,175 x 150	12000	2	15:1	215-243	292-330	138
TD 120 C	D	(A)	6	130,175 x 150	12000	2	15:1	173-260	236-354	127
TD 120 D	D	(A)	6	130,175 x 150	12000	2	15:1	273	371	127, 138
TD 120 E	D	(A)	6	130,175 x 150	12000	2	13,3:1	240	326	127, 138
TD 120 F	D	(LA)	6	130,175 x 150	12000	2	14,2:1	265	360	124, 125, 127, 141
TD 120 FC	D	(LA)	6	130,175 x 150	12000	2	14,2:1	265	360	125, 127
TD 120 G	D	(A)	6	130,175 x 150	12000	2	13,3:1	225-256	306-348	124, 125, 127, 137, 138, 141
TD 120 GA	D	(A)	6	130,175 x 150	12000	2	14,2:1	227-241	308-328	124, 125, 127, 137, 138, 141
TD 121 F	D	(LA)	6	130,175 x 150	12000	2	14,2:1	272-283	370-385	127, 138
TD 121 FD	D	(LA)	6	130,175 x 150	12000	2	14,2:1	283	385	127, 138
TD 121 G	D	(A)	6	130,175 x 150	12000	2	14,2:1	215-256	292-348	127, 138, 140
TD 121 GD	D	(A)	6	130,175 x 150	12000	2	14,2:1	243	330	127, 138
TD 122 FK	D	(LA)	6	130,175 x 150	11977	2	15:1	284	386	127, 135, 136
TD 122 FS	D	(LA)	6	130,175 x 150	11977	2	15:1	291	395	127, 135, 136, 140

**240 1.8****1**

11.1978→07.1988	B 17 A							
Reference	270681 463425-9	275619	275619-5	463425				50 005 102

240 2.0**2**

08.1984→07.1989	B 200 K							
Reference	1326342 271275	1326342-1 2712750	270559 271830	270559-8 271975				50 005 106

240 2.0i Turbo**3**

08.1981→07.1984	B 19 ET							
Reference	270681 463425-9	275619	275619-5	463425				50 005 102

240 2.1**4**

08.1974→07.1986	B 21 A, B 21 E, B 21 F							
Reference	270681 463425-9	275619	275619-5	463425				50 005 102

240 2.1i**5**

08.1974→07.1986	B 21 E							
Reference	270681 463425-9	275619	275619-5	463425				50 005 102

240 2.1i Turbo**6**

08.1980→07.1986	B 21 ET							
Reference	270681 463425-9	275619	275619-5	463425				50 005 102

240 2.3**7**

08.1979→07.1986	B 23 A, B 23 E							
Reference	270681 463425-9	275619	275619-5	463425				50 005 102

04.1984→08.1993	B 230 A, B 230 E, B 230 F, B 230 K							
Reference	1326342 271275	1326342-1 2712750	270559 271830	270559-8 271975				50 005 106

240 2.3i**8**

08.1979→07.1986	B 23 E							
Reference	270681 463425-9	275619	275619-5	463425				50 005 102

240 2.4 D**9**

04.1979→08.1993	D 24							
Reference	1257185	271613						50 005 146



340 1.6 D						10
08.1984→07.1991	D 16					
Reference	20538845	20744939				50 005 634 NEW
08.1984→07.1991	D 16					
Reference	3085599 3287751-6 3344251-8	3085599-1 3343093 3344827	3242084 3343093-5 3344831	3287751 3344251 3345626		50 005 301
340 1.7						11
08.1985→07.1991	B 172 K					
Reference	3085599 3287751-6 3344251-8	3085599-1 3343093 3344827	3242084 3343093-5 3344831	3287751 3344251 3345626		50 005 301
360 1.6 D						12
08.1984→07.1991	D 16					
Reference	20538845	20744939				50 005 634 NEW
360 1.7						13
08.1985→	B 172 K, F3N 718					
Reference	3085599 3287751-6 3344251-8	3085599-1 3343093 3344827	3242084 3343093-5 3344831	3287751 3344251 3345626		50 005 301
360 2.0						14
08.1982→08.1983	B 19 A					
Reference	270681 463425-9 →ch 810.500	275619	275619-5	463425		50 005 102
08.1984→07.1990	B 200 K					
Reference	1326342 271275	1326342-1 2712750	270559 271830	270559-8 271975		50 005 106
440 1.6						15
09.1993→08.1997	B 16 F					
Reference	3085599 3287751-6 3344251-8	3085599-1 3343093 3344827	3242084 3343093-5 3344831	3287751 3344251 3345626		50 005 301
440 1.7						16
08.1988→08.1993	B 18 EP, B 18 F, B 18 FP, B 18 K, B 18 KP, B 18 KPD					
Reference	3085599 3287751-6 3344251-8	3085599-1 3343093 3344827	3242084 3343093-5 3344831	3287751 3344251 3345626		50 005 301
440 1.8i						17
09.1991→08.1997	B 18 U					
Reference	3085599 3287751-6 3344251-8	3085599-1 3343093 3344827	3242084 3343093-5 3344831	3287751 3344251 3345626		50 005 301

**440 1.7i Turbo****18**

09.1988→07.1996

B 18 FT

Reference

3085599
3287751-6
3344251-83085599-1
3343093
33448273242084
3343093-5
33448313287751
3344251
3345626

50 005 301

440 2.0**19**

08.1984→07.1990

B 200 K

Reference

1326342
2712751326342-1
2712750270559
271830270559-8
271975

50 005 106

09.1992→12.1996

B 20 F 208

Reference

3085599
3287751-6
3344251-83085599-1
3343093
33448273242084
3343093-5
33448313287751
3344251
3345626

50 005 301

460 1.6i**20**

09.1988→08.1997

B 16 F

Reference

3085599
3287751-6
3344251-83085599-1
3343093
33448273242084
3343093-5
33448313287751
3344251
3345626

50 005 301

460 1.7**21**

04.1986→08.1997

B 18 EP, B 18 F, B 18 FP, B 18 K, B 18 KP

Reference

3085599
3287751-6
3344251-83085599-1
3343093
33448273242084
3343093-5
33448313287751
3344251
3345626

50 005 301

460 1.7i Turbo**22**

03.1990→09.1996

B 18 FT

Reference

3085599
3287751-6
3344251-83085599-1
3343093
33448273242084
3343093-5
33448313287751
3344251
3345626

50 005 301

460 1.8i**23**

09.1991→08.1997

B 18 U

Reference

3085599
3287751-6
3344251-83085599-1
3343093
33448273242084
3343093-5
33448313287751
3344251
3345626

50 005 301

460 1.9 TD**24**

07.1994→

F8Q 610, F8Q 784

Reference

3085599
3287751-6
3344251-83085599-1
3343093
33448273242084
3343093-5
33448313287751
3344251
3345626

50 005 301

460 2.0**25**

09.1992→12.1996

B 20 F 208

Reference

3085599
3287751-6
3344251-83085599-1
3343093
33448273242084
3343093-5
33448313287751
3344251
3345626

50 005 301

480 1.7**26**

04.1986→12.1993

B 18 E, B 18 EP, B 18 F, B 18 FP

Reference

3085599
3287751-6
3344251-83085599-1
3343093
33448273242084
3343093-5
33448313287751
3344251
3345626

50 005 301

V

**480 1.7i Turbo****27**

08.1988→08.1995

B 18 FT

Reference

3085599
3287751-6
3344251-83085599-1
3343093
33448273242084
3343093-5
33448313287751
3344251
3345626

50 005 301

480 2.0**28**

09.1992→12.1996

B 20 F 208

Reference

3085599
3287751-6
3344251-83085599-1
3343093
33448273242084
3343093-5
33448313287751
3344251
3345626

50 005 301

740 2.0**29**

08.1984→1985

B 19 A

Reference

270681
463425-9

275619

275619-5

463425



50 005 102

08.1989→07.1993

B 200 F

Reference

1326342
2712751326342-1
2712750270559
271830270559-8
271975

50 005 106

740 2.0i Turbo**30**

08.1983→07.1984

B 19 ET

Reference

270681
463425-9

275619

275619-5

463425



50 005 102

740 2.3**31**

08.1983→07.1985

B 23 E

Reference

270681
463425-9

275619

275619-5

463425



50 005 102

08.1984→07.1991

B 230 A, B 230 E, B 230 K

Reference

1326342
2712751326342-1
2712750270559
271830270559-8
271975

50 005 106

740 2.3i Turbo**32**

08.1984→07.1991

B 230 ET, B 230 FT

Reference

1326342
2712751326342-1
2712750270559
271830270559-8
271975

50 005 106

740 2.3i**33**

08.1983→07.1985

B 23 E

Reference

270681
463425-9

275619

275619-5

463425



50 005 102

740 2.3i 16V**34**

04.1988→07.1990

B 234 F

Reference

2716470
2724762719854
272481

271986

272457



50 005 107

**740 2.4 D****35**

04.1984→07.1992	D 24							
Reference	1257185	271613						50 005 146

740 2.9i 24V**36**

→	B 6304 F1							
Reference	2716470 272476	2719854 272481	271986	272457				50 005 107

760 2.3**37**

10.1981→05.1984	B 23 A							
Reference	270681 463425-9	275619	275619-5	463425				50 005 102

05.1984→	B 230 E							
Reference	1326342 271275	1326342-1 2712750	270559 271830	270559-8 271975				50 005 106

760 2.3i Turbo**38**

04.1983→07.1984	B 23 ET							
Reference	270681 463425-9	275619	275619-5	463425				50 005 102

08.1984→07.1989	B 230 ET							
Reference	1326342 271275	1326342-1 2712750	270559 271830	270559-8 271975				50 005 106

760 2.4 D**39**

01.1982→07.1992	D 24							
Reference	1257185	271613						50 005 146

780 2.4 TDi**40**

08.1985→07.1991	D 24 TIC							
Reference	1257185 09.1986→08.1990	271613						50 005 146

850 2.0i 20V**41**

09.1991→12.1996	B 5204 S							
Reference	2716470 272476	2719854 272481	271986	272457				50 005 107

V

**850 2.0i****42**

08.1994→07.1999

B 5202 S

Reference

2716470
2724762719854
272481

271986

272457



50 005 107

850 2.0i Turbo 20V**43**

01.1995→08.1997

B 5204 T

Reference

2716470
2724762719854
272481

271986

272457



50 005 107

850 2.3i Turbo 20V**44**

09.1994→08.1995

B 5234 T3

Reference

2716470
2724762719854
272481

271986

272457



50 005 107

850 2.4i**45**

09.1992→08.1997

B 5252 S

Reference

2716470
2724762719854
272481

271986

272457



50 005 107

850 2.4i 20V**46**

09.1991→08.1997

B 5254 S

Reference

2716470
2724762719854
272481

271986

272457



50 005 107

850 2.5 TDI**47**

05.1996→08.1997

D 5252 T

Reference

271768

274155



20 Zähne/teeth/dientes/dents/зубьев



50 005 555

05.1996→08.1997

D 5252 T

Reference

271768

2717684



18 Zähne/teeth/dientes/dents/зубьев



50 005 551

940 2.0**48**

01.1992→08.1995

B 200 F

Reference

1326342
2712751326342-1
2712750270559
271830270559-8
271975

50 005 106

**940 2.0i Turbo 16V****49**

09.1991→08.1997	B 204 FT							
Reference	1326342 271275	1326342-1 2712750	270559 271830	270559-8 271975				50 005 106

940 2.3**50**

09.1990→04.1997	B 230 E							
Reference	1326342 271275	1326342-1 2712750	270559 271830	270559-8 271975				50 005 106

940 2.3i**51**

06.1991→08.1995	B 230 F							
Reference	1326342 271275	1326342-1 2712750	270559 271830	270559-8 271975				50 005 106

940 2.3i 16V**52**

09.1990→08.1992	B 234 F							
Reference	2716470 272476	2719854 272481	271986	272457				50 005 107

940 2.4 D**53**

09.1990→08.1993	D 24							
Reference	1257185	271613						50 005 146

940 2.4 TDi**54**

09.1990→08.1997	D 24 TIC							
Reference	271768	274155						50 005 555
	20 Zähne/teeth/dientes/dents/зубьев CH 30004→							

940 2.9i 24V**55**

09.1990→07.1998	B 6304 F1							
Reference	2716470 272476	2719854 272481	271986	272457				50 005 107

940 II 2.3i Turbo**56**

09.1990→08.1997	B 230 FT							
Reference	1326342 271275	1326342-1 2712750	270559 271830	270559-8 271975				50 005 106

940 II 2.4 TD**57**

08.1994→10.1998	D 24 TIC							
Reference	271768	274155						50 005 555
	20 Zähne/teeth/dientes/dents/зубьев CH 30004→							

V

**960 2.0i Turbo 16V****58**

09.1991→08.1994	B 204 FT				
Reference	1326342 271275	1326342-1 2712750	270559 271830	270559-8 271975	

**50 005 106****960 2.3****59**

→	B 230 E				
Reference	1326342 271275	1326342-1 2712750	270559 271830	270559-8 271975	

**50 005 106****960 2.3i 16V****60**

09.1990→07.1992	B 234 F				
Reference	2716470 272476	2719854 272481	271986	272457	

**50 005 107****960 2.3i Turbo****61**

03.1993→08.1996	B 230 FT				
Reference	1326342 271275	1326342-1 2712750	270559 271830	270559-8 271975	

**50 005 106****960 2.4 TD****62**

→	D 24				
Reference	1257185	271613			

**50 005 146****960 2.4 TDi****63**

08.1990→08.1997	D 24 TIC				
Reference	271768	274155			
	20 Zähne/teeth/dientes/dents/зубьев CH 30004→				

**50 005 555****960 2.9i 24V****64**

09.1990→08.1997	B 6304 F1				
Reference	2716470 272476	2719854 272481	271986	272457	

**50 005 107****C30 1.6i 16V****65**

09.2006→	B 4164 S3				
Reference	30735758				

50 005 119
NEW**C30 1.6 TDI 16V****66**

09.2006→	D 4164 T				
Reference	8653806				

**50 005 762****V**

**C30 2.0 TD 16V****67**

09.2006→

D 4204 T



50 005 779

C70 2.0 TD 16V**68**

09.2007→

D 4204 T



50 005 779

C70 2.4i Turbo 20V**69**

04.1999→07.2002

B 5244 T

Reference

2716470
2724762719854
272481

271986

272457



50 005 107

C70 2.3i Turbo 20V**70**

01.1997→07.2002

B 5234 T3

Reference

2716470
2724762719854
272481

271986

272457



50 005 107

C70 2.5i 20V**71**

03.1999→07.2000

B 5254 S

Reference

2716470
2724762719854
272481

271986

272457



50 005 107

S40 1.6i 16V**72**

01.1997→07.1999

B 4164 S

Reference

2716470
2724762719854
272481

271986

272457



50 005 107

11.2004→

B 4164 S3

Reference

30735758

50 005 119

NEW

S40 1.6 TDI 16V**73**

11.2004→

D 4164 T

Reference



8653806



50 005 762

V

**VOLVO****S40 1.8i 16V****74**

09.1997→07.2000 Reference	B 4184 SM 30874316						50 005 796
09.1995→07.1999 Reference	B 4184 S 2716470 272476	2719854 272481	271986	272457			50 005 107

S40 1.9i Turbo 16V**75**

05.1997→07.1999 Reference	B 4194 T 2716470 272476	2719854 272481	271986	272457			50 005 107
------------------------------	-------------------------------	-------------------	--------	--------	---	--	------------

S40 1.9 TD**76**

05.1996→07.1999 Reference	D 4192 T 3085599 3287751-6 3344251-8	3085599-1 3343093 3344827	3242084 3343093-5 3344831	3287751 3344251 3345626			50 005 301
------------------------------	---	---------------------------------	---------------------------------	-------------------------------	--	--	------------

S40 1.9 TDI**77**

04.2000→01.2004 Reference	D 4192 T3, D 4192 T4 30620725						50 005 756
------------------------------	----------------------------------	--	--	--	---	--	------------

S40 2.0i 16V**78**

09.1995→07.1999 Reference	B 4204 S 2716470 272476	2719854 272481	271986	272457			50 005 107
------------------------------	-------------------------------	-------------------	--------	--------	---	--	------------

S40 2.0i 20V**79**

01.1996→ Reference	B 5204 S 2716470 272476	2719854 272481	271986	272457			50 005 107
-----------------------	-------------------------------	-------------------	--------	--------	---	--	------------

S40 2.0i Turbo 16V**80**

04.1998→07.1999 Reference	B 4204 T 2716470 272476	2719854 272481	271986	272457			50 005 107
------------------------------	-------------------------------	-------------------	--------	--------	---	--	------------

V

**S40 2.0 TDI 16V****81**

10.2003→

D 4204 T, D 4204 T2



50 005 779

S60 2.3i Turbo 20V**82**

08.2000→04.2004 B 5234 T3

Reference

2716470
2724762719854
272481

271986

272457



50 005 107

S60 2.4 TDI 20V**83**

08.2001→07.2005 D 5244 T, D 5244 T2

Reference

274216

8694629

8694630



50 005 764

S70 2.0i**84**

01.1997→07.1999 B 5202 S

Reference

2716470
2724762719854
272481

271986

272457



50 005 107

S70 2.0i 20V**85**

01.1997→07.1998 B 5204 S

Reference

2716470
2724762719854
272481

271986

272457



50 005 107

S70 2.0i Turbo 20V**86**

01.1997→07.1998 B 5204 T

Reference

2716470
2724762719854
272481

271986

272457



50 005 107

S70 2.3i T5 Turbo 20V**87**

01.1997→07.2000 B 5234 T3

Reference

2716470
2724762719854
272481

271986

272457



50 005 107

S70 2.4i Turbo 20V**88**

01.1997→08.1999 B 5244 T

Reference

2716470
2724762719854
272481

271986

272457



50 005 107

V

**S70 2.5i****89**

01.1997→07.1999	B 5252 S						
Reference	2716470 272476	2719854 272481	271986	272457			50 005 107

S70 2.5i 20V**90**

01.1997→07.1999	B 5254 S						
Reference	2716470 272476	2719854 272481	271986	272457			50 005 107

S70 2.5 TDI**91**

01.1997→07.2000	D 5252 T						
Reference	271768	274155					50 005 555
	20 Zähne/teeth/dientes/dents/зубьев						
01.1997→07.2000	D 5252 T						
Reference	271768	2717684					50 005 551
	18 Zähne/teeth/dientes/dents/зубьев						

S80 2.0 TD 16V**92**

09.2007→	D 4204 T						
							50 005 779

S80 2.4 TDI 20V**93**

01.2001→12.2005	D 5244 T, D 5244 T2						
Reference	274216	8694629	8694630				50 005 764

S80 2.5 TDI**94**

08.1998→07.2001	D 5252 T						
Reference	8692839						50 005 798

V**S80 2.8i Turbo 24V****95**

06.1998→07.2001	B 6284 T						
Reference	272334	8694627	9142695				50 005 797

**S80 2.9i 24V****96**06.1998→07.2001
ReferenceB 6294 S, B 6304 S3
272334 8694627 9142695

50 005 797

S80 2.9i Turbo 24V**97**06.2001→07.2006
ReferenceB 6294 T
274216 8694629 8694630

50 005 764

V40 1.6i 16V**98**04.2004→
ReferenceB 4164 S3
3073575850 005 119
NEW**V40 1.8i 16V****99**08.1997→07.2000
ReferenceB 4184 SM
30874316

50 005 796

01.1995→07.1999
ReferenceB 4184 S
2716470 2719854 271986 272457
272476 272481

50 005 107

V40 1.9i Turbo 16V**100**05.1997→07.1999
ReferenceB 4194 T
2716470 2719854 271986 272457
272476 272481

50 005 107

V40 1.9 TD**101**01.1996→07.1999
ReferenceD 4192 T
3085599 3085599-1 3242084 3287751
3287751-6 3343093 3343093-5 3344251
3344251-8 3344827 3344831 3345626

50 005 301

V40 1.9 TDI**102**03.2000→04.2004
ReferenceD 4192 T3, D 4192 T4
30620725

50 005 756

V40 2.0i 16V**103**01.1996→07.1999
ReferenceB 4204 S
2716470 2719854 271986 272457
272476 272481

50 005 107

**VOLVO****V40 2.0i 20V****104**

01.1996→	B 5204 S							
Reference	2716470 272476	2719854 272481	271986	272457				50 005 107

V40 2.0i Turbo 16V**105**

04.1998→07.1999	B 4204 T							
Reference	2716470 272476	2719854 272481	271986	272457				50 005 107

V50 1.6i 16V**106**

11.2004→	B 4164 S3							50 005 119
Reference	30735758							NEW

V50 1.6 TDI 16V**107**

11.2004→	D 4164 T							
Reference	8653806							50 005 762

V50 2.0 TDI 16V**108**

02.2004→	D 4204 T, D 4204 T2							
								50 005 779

V70 2.0i**109**

01.1997→07.1999	B 5202 S							
Reference	2716470 272476	2719854 272481	271986	272457				50 005 107

V70 2.0i 20V**110**

01.1997→03.2000	B 5204 S							
Reference	2716470 272476	2719854 272481	271986	272457				50 005 107

V70 2.0i Turbo 20V**111**

01.1997→03.2000	B 5204 T							
Reference	2716470 272476	2719854 272481	271986	272457				50 005 107

V

**V70 2.3i Turbo 20V****112**

01.1997→03.2000 B 5234 T3

Reference 2716470 2719854 271986 272457
272476 272481

50 005 107

V70 2.4i Turbo 20V**113**

01.1997→08.1999 B 5244 T

Reference 2716470 2719854 271986 272457
272476 272481

50 005 107

V70 2.5i**114**

01.1997→03.2000 B 5252 S

Reference 2716470 2719854 271986 272457
272476 272481

50 005 107

V70 2.5i 20V**115**

01.1997→03.2000 B 5254 S

Reference 2716470 2719854 271986 272457
272476 272481

50 005 107

V70 2.5 TDI**116**

01.1997→03.2000 D 5252 T

Reference 271768 274155
20 Zähne/teeth/dientes/dents/зубьев

50 005 555

01.1997→03.2000 D 5252 T

Reference 271768 2717684
18 Zähne/teeth/dientes/dents/зубьев

50 005 551

V70 II 2.0 TD 16V**117**

09.2007→ D 4204 T



50 005 779

V70 II 2.3 Turbo 20V**118**

03.2000→ B 5234 T3

Reference 2716470 2719854 271986 272457
272476 272481

50 005 107

V

**VOLVO****V70 II 2.5 TDi****119**

03.2000→07.2001 D 5252 T
Reference 8692839



50 005 798

V70 II 2.4 TDi 20V**120**

01.2001→04.2007 D 5244 T, D 5244 T2
Reference 274216 8694629 8694630



50 005 764

XC70 2.4 TDI 20V**121**

07.2002→09.2005 D 5244 T
Reference 274216 8694629 8694630



50 005 764

XC90 2.4 TDI 20V**122**

01.2003→ D 5244 T
Reference 274216 8694629 8694630



50 005 764

XC90 2.9i Turbo 24V**123**

01.2003→07.2006 B 6294 T
Reference 274216 8694629 8694630



50 005 764

CH 200**124**

10.1979→1988 TD 120 F, TD 120 G, TD 120 GA
Reference 1545261 1675945 1698620 1699790
20431484 3184802 3184802-1 478845
479931 8149937 8149937-8
→34000



50 005 602

CH 230 T**125**

09.1979→10.1984 TD 120 F, TD 120 FC, TD 120 G, TD 120 GA
Reference 1545261 1675945 1698620 1699790
20431484 3184802 3184802-1 478845
479931 8149937 8149937-8
→34000



50 005 602

F 10**126**

09.1985→12.1994 TD 101 F, TD 102 F
Reference 1545261 1675945 1698620 1699790
20431484 3184802 3184802-1 478845
479931 8149937 8149937-8





50 005 602

V



F 12

127

08.1977→12.1994	TD 120 C, TD 120 D, TD 120 E, TD 120 F, TD 120 FC, TD 120 G, TD 120 GA, TD 121 F, TD 121 FD, TD 121 G, TD 121 GD, TD 122 FK, TD 122 FS				50 005 602
Reference	1545261 1675945 1698620 1699790 20431484 3184802 3184802-1 478845 479931 8149937 8149937-8				
	TD 121 F, TD 121 FD, TD 121 G, TD 121 GD: 34001→ TD 120 C, TD 120 D, TD 120 E, TD 120 F, TD 120 FC, TD 120 G, TD 120 GA: →34000				
10.1983→05.1988	TD 121 F, TD 121 G				50 005 841
Reference	478649				

F 82

128

09.1975→01.1986	4.236				50 005 246 <small>NEW</small>
09.1975→01.1986	4.236 mit Riemenscheibe with pulley avec poulie con polea с Ремснный шкив				50 005 245 <small>NEW</small>
09.1975→01.1986	4.236				50 005 252 <small>NEW</small>

F 83

129

09.1975→01.1986	4.236				50 005 246 <small>NEW</small>
09.1975→01.1986	4.236 mit Riemenscheibe with pulley avec poulie con polea с Ремснный шкив				50 005 245 <small>NEW</small>
09.1975→01.1986	4.236				50 005 252 <small>NEW</small>

V

**VOLVO****F 406****130**

09.1975→01.1986

4.236

**50 005 246****NEW**

09.1975→01.1986

4.236

mit Riemenscheibe
with pulley
avec poulie
con polea
с Ремснный шкив**50 005 245****NEW**

09.1975→01.1986

4.236

**50 005 252****NEW****F 407****131**

09.1975→01.1986

4.236

**50 005 246****NEW**

09.1975→01.1986

4.236

mit Riemenscheibe
with pulley
avec poulie
con polea
с Ремснный шкив**50 005 245****NEW**

09.1975→01.1986

4.236

**50 005 252****NEW****FH 16-550****132**

01.2003→

D 16 C 550

Reference

20538845

20744939

**50 005 634****NEW****FH 16-610****133**

01.2003→

D 16 C 610

Reference

20538845

20744939

**50 005 634****NEW****V**

**FL 10****134**

09.1985→12.1993

TD 101 F, TD 102 F

Reference

1545261	1675945	1698620	1699790
20431484	3184802	3184802-1	478845
479931	8149937	8149937-8	

**50 005 602**

02.1995→12.1998

D 10 A 310, D 10 A 320, D 10 A 350, D 10 A 360

Reference

478649

**50 005 841****FS 10****135**

1987 →

TD 122 FK, TD 122 FS

Reference

1545261	1675945	1698620	1699790
20431484	3184802	3184802-1	478845
479931	8149937	8149937-8	

**50 005 602****FS 12****136**

1987 →

TD 122 FK, TD 122 FS

Reference

1545261	1675945	1698620	1699790
20431484	3184802	3184802-1	478845
479931	8149937	8149937-8	

**50 005 602****N 10****137**

10.1980→

TD 101 F, TD 102 F, TD 120 G, TD 120 GA

Reference

1545261	1675945	1698620	1699790
20431484	3184802	3184802-1	478845
479931	8149937	8149937-8	



TD 120 G, TD 120 GA: →34000

**50 005 602****N 12****138**

09.1973→01.1996

TD 120 A, TD 120 D, TD 120 E, TD 120 G, TD 120 GA, TD 121 F, TD 121 FD, TD 121 G, TD 121 GD

Reference

1545261	1675945	1698620	1699790
20431484	3184802	3184802-1	478845
479931	8149937	8149937-8	



TD 121 F, TD 121 G: 12001→
 TD 120 A: →12000
 TD 120 D, TD 120 E, TD 120 G, TD 120 GA: →34000

**50 005 602**

06.1984→01.1996

TD 121 F, TD 121 G

Reference

478649

**50 005 841****NL 10****139**

05.1991→09.2001









TD 102 F

Reference





1545261	1675945	1698620	1699790
20431484	3184802	3184802-1	478845
479931	8149937	8149937-8	

**50 005 602**



				
01.1996→ Reference	D 10 A 320 478649			50 005 841
NL 12				140
05.1991→09.2001 Reference	TD 122 FS 1545261 20431484 479931	1675945 3184802 8149937	1698620 3184802-1 8149937-8	1699790 478845
				50 005 602
05.1991→09.2001 Reference	TD 121 G 478649			50 005 841
Engine				141
→ Reference	TD 120 F, TD 120 G, TD 120 GA 1545261 20431484 479931	1675945 3184802 8149937	1698620 3184802-1 8149937-8	1699790 478845
				50 005 602

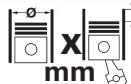

			Cyl	 mm	cm ³		Comp. Ratio ε	kW	PS	Pos
4.236	D	(AN)	4	98,48 x 126,8	3864	2	16:1	48-60	59-80	4
6B 5.9 C	D	(AN)	6	102 x 120	5880	2	17,5:1	86-132	115-177	1, 2, 3
TD 120 G	D	(A)	6	130,175 x 150	12000	2	13,3:1	225-256	306-348	5



EC 210

1

01.1996→

6B 5.9 C

**50 005 217**
NEW

EW 170

2

01.1996→

6B 5.9 C

**50 005 217**
NEW

EW 180

3

01.1996→

6B 5.9 C

**50 005 217**
NEW

L 30

4

01.1987→09.1995

4.236

**50 005 246**
NEW

01.1987→09.1995

4.236
mit Riemenscheibe
with pulley
avec poulie
con polea
с Ремснный шкив**50 005 245**
NEW

01.1987→09.1995

4.236

**50 005 252**
NEW

Engine

5

09.1983→

TD 120 G

Reference

1545261
20431484
4799311675945
3184802
81499371698620
3184802-1
8149937-81699790
478845**50 005 602**



DE Vergleichsliste

EN Cross reference

FR Liste de correspondances

ES Lista de referencias



RU Лист сравнения





CROSS REFERENCE



CROSS REFERENCE

Reference 		Reference 		Reference 	
AIRTEX		AIRTEX		AIRTEX	
1095-A	50 005 312	1348	50 005 151	1566	50 005 132
1101	50 005 033	1349	50 005 150	1568	50 005 434
1102	50 005 032	1359	50 005 319	1572	50 005 324
1102-30	50 005 932	1360	50 005 000	1577	50 005 040
1105-1	50 005 311	1361	50 005 313	1578	50 005 340
1111	50 005 064	1364	50 005 068	1579	50 005 333
1130-1	50 005 321	1365	50 005 725	1580	50 005 329
1133	50 005 326	1366	50 005 308	1581	50 005 154
1133-1	50 005 302	1368	50 005 084	1582	50 005 137
1134	50 005 325	1369	50 005 515	1583	50 005 769
1135	50 005 307	1370	50 005 514	1584	50 005 337
1138	50 005 142	1371	50 005 513	1585	50 005 335
1139	50 005 140	1372	50 005 512	1586	50 005 120
1140	50 005 148	1374	50 005 021	1587	50 005 330
1142	50 005 002	1386	50 005 428	1592	50 005 159
1143	50 005 019	1388	50 005 739	1595	50 005 332
1144	50 005 020	1390	50 005 447	1596	50 005 168
1151	50 005 065	1391	50 005 741	1597	50 005 164
1154	50 005 043	1393	50 005 427	1598	50 005 470
1155	50 005 053	1394	50 005 446	1599	50 005 155
1159	50 005 042	1396	50 005 552	1601	50 005 331
1161	50 005 045	1396	50 005 553	1607	50 005 181
1162	50 005 051	1397	50 005 153	1608	50 005 156
1163	50 005 052	1405	50 005 174	1609	50 005 148
1164	50 005 059	1406	50 005 425	1610	50 005 151
1164-C	50 005 733	1417	50 005 516	1614	50 005 029
1165	50 005 049	1419	50 005 339	1615	50 005 425
1165-D	50 005 055	1420	50 005 322	1619	50 005 216
1167	50 005 735	1438	50 005 621	1621	50 005 471
1168	50 005 740	1439	50 005 449	1624	50 005 086
1180	50 005 102	1442	50 005 436	1625	50 005 092
1190	50 005 146	1443	50 005 433	1631	50 005 072
1193	50 005 306	1444	50 005 036	1632	50 005 073
1194	50 005 145	1445	50 005 435	1633	50 005 076
1197	50 005 720	1446	50 005 738	1634	50 005 490
1204	50 005 620	1447	50 005 734	1635	50 005 474
1206	50 005 314	1448	50 005 732	1636	50 005 475
1207	50 005 304	1449	50 005 341	1640	50 005 336
1212	50 005 310	1450	50 005 759	1641	50 005 170
1218	50 005 018	1452	50 005 309	1642	50 005 747
1219	50 005 009	1455	50 005 317	1643	50 005 748
1228	50 005 063	1460	50 005 082	1645	50 005 786
1229	50 005 530	1465	50 005 107	1646	50 005 075
1230	50 005 067	1468	50 005 062	1647	50 005 767
1233	50 005 028	1475	50 005 318	1648	50 005 455
1235	50 005 031	1478	50 005 162	1650	50 005 785
1236	50 005 439	1510	50 005 163	1657	50 005 171
1237	50 005 038	1512	50 005 078	1659	50 005 751
1241	50 005 323	1513	50 005 077	1661	50 005 057
1243	50 005 316	1515	50 005 791	1667	50 005 755
1244	50 005 221	1516	50 005 135	1668	50 005 756
1247	50 005 106	1523	50 005 303	1670	50 005 556
1287	50 005 727	1530	50 005 139	1671	50 005 750
1294	50 005 736	1543	50 005 167	1672	50 005 753
1296	50 005 510	1544	50 005 780	1673	50 005 758
1303	50 005 149	1549	50 005 519	1674	50 005 760
1307	50 005 005	1550	50 005 746	1675	50 005 761
1308	50 005 511	1551	50 005 741	1676	50 005 793
1310	50 005 320	1552	50 005 749	1677	50 005 900
1314	50 005 324	1555	50 005 334	1678	50 005 762
1328	50 005 029	1559	50 005 223	1679	50 005 757
1330	50 005 737	1561	50 005 225	1681	50 005 141
1338	50 005 138	1562	50 005 725	1682	50 005 754



CROSS REFERENCE



CROSS REFERENCE

Reference 	Reference 	Reference 
AIRTEX	AIRTEX	AUTOPUMPS
1683 50 005 764	9349 50 005 788	AOP203 50 005 805
1684 50 005 189	9352 50 005 087	AOP204 50 005 802
1686 50 005 794	9378 50 005 132	AOP218 50 005 808
1687 50 005 784	9390 50 005 110	AOP228 50 005 804
1690 50 005 779	9471 50 005 008	AOP232 50 005 801
1691 50 005 765	9700 50 005 010	AOP233 50 005 810
1692 50 005 766		AOP237 50 005 836
1693 50 005 795	ALCO	AOP238 50 005 835
1695 50 005 901	MD9106 50 005 136	AOP247 50 005 814
1696 50 005 074		AOP248 50 005 820
1698 50 005 188	ALFA ROMEO	AOP256 50 005 829
1700 50 005 006	4714636 50 005 321	AOP257 50 005 837
1702 50 005 056	4754850 50 005 321	AOP272 50 005 803
1712 50 005 902	4764761 50 005 321	AOP279 50 005 817
1713 50 005 799	7303009 50 005 321	AOP280 50 005 823
1714 50 005 183		AOP282 50 005 818
1721 50 005 903	AUDI	AOP285 50 005 809
1723 50 005 792	026 115 105 50 005 813	
1731 50 005 904	026 115 105 A 50 005 822	BMW
1732 50 005 905	026 115 105 B 50 005 813	11 51 0 007 039 50 005 514
1734 50 005 778	028 115 105 J 50 005 866	11 51 0 007 042 50 005 517
1737 50 005 044	028 115 105 M 50 005 867	11 51 0 393 338 50 005 515
1739 50 005 175	036 115 105 B 50 005 844	11 51 0 393 340 50 005 519
1746 50 005 027	036 115 105 D 50 005 844	11 51 0 686 001 50 005 002
1792 50 005 193	045 121 011F 50 005 556	11 51 0 686 801 50 005 002
4049 50 005 111	045 121 011H 50 005 556	11 51 0 686 901 50 005 002
4053 50 005 116	045 121 011HX 50 005 556	11 51 0 786 821 50 005 019
4068 50 005 121	049 115 105 H 50 005 813	11 51 1 251 230 50 005 000
4078 50 005 117	053 115 105 B 50 005 845	11 51 1 253 143 50 005 000
4104 50 005 119	053 115 105 C 50 005 845	11 51 1 256 600 50 005 002
4115 50 005 215	056 115 105 A 50 005 813	11 51 1 258 701 50 005 019
5029 50 005 178	058 115 105 A 50 005 811	11 51 1 258 932 50 005 019
5048 50 005 179	058 115 105 B 50 005 811	11 51 1 258 933 50 005 019
5058 50 005 177	058 115 105 C 50 005 811	11 51 1 259 660 50 005 019
5079 50 005 224	068 115 105 AC 50 005 804	11 51 1 263 934 50 005 000
7115 50 005 095	068 115 105 AD 50 005 804	11 51 1 266 094 50 005 000
7121 50 005 128	068 115 105 AP 50 005 804	11 51 1 266 096 50 005 000
9015 50 005 196	068 115 105 BL 50 005 866	11 51 1 267 187 50 005 020
9061 50 005 160	068 115 105 N 50 005 804	11 51 1 267 583 50 005 020
9083 50 005 079	068 115 105 R 50 005 804	11 51 1 271 435 50 005 018
9098 50 005 194	06A 115 105 50 005 819	11 51 1 271 436 50 005 004
9099 50 005 187	06A 115 105 B 50 005 819	11 51 1 272 613 50 005 004
9150 50 005 162	06A 115 105 C 50 005 819	11 51 1 272 616 50 005 018
9209 50 005 080	06A 115 105 D 50 005 819	11 51 1 274 583 50 005 009
9213 50 005 136	→VOLKSWAGEN	11 51 1 274 584 50 005 009
9214 50 005 172		11 51 1 274 584 50 005 009
9222 50 005 452	AUTOPUMPS	11 51 1 274 584 50 005 009
9223 50 005 176	AOP101 50 005 821	11 51 1 274 584 50 005 009
9229 50 005 430	AOP1103 50 005 827	11 51 1 274 584 50 005 009
9230 50 005 030	AOP1104 50 005 828	11 51 1 274 584 50 005 009
9250 50 005 094	AOP1141 50 005 839	11 51 1 274 584 50 005 009
9251 50 005 090	AOP1147 50 005 815	11 51 1 274 584 50 005 009
9262 50 005 165	AOP1165 50 005 832	11 51 1 274 584 50 005 009
9263 50 005 166	AOP118 50 005 842	11 51 1 274 584 50 005 009
9272 50 005 197	AOP1182 50 005 812	11 51 1 274 584 50 005 009
9274 50 005 551	AOP1196 50 005 807	11 51 1 274 584 50 005 009
9276 50 005 517	AOP122 50 005 840	11 51 1 274 584 50 005 009
9279 50 005 550	AOP133 50 005 816	11 51 1 274 584 50 005 009
9312 50 005 437	AOP171 50 005 369	11 51 1 274 584 50 005 009
9314 50 005 491	AOP176 50 005 800	11 51 1 274 584 50 005 009
9318 50 005 118	AOP197 50 005 811	11 51 1 274 584 50 005 009
9335 50 005 158	AOP198 50 005 845	11 51 1 274 584 50 005 009
9346 50 005 454	AOP201 50 005 806	11 51 1 274 584 50 005 009
	AOP202 50 005 813	11 51 1 274 584 50 005 009



CROSS REFERENCE



CROSS REFERENCE

Reference 	Reference 	Reference 			
BMW	BMW	BUGATTI			
11 51 1 706 624	50 005 018	11 51 9 070 765	50 005 512	PA0247	50 005 725
11 51 1 707 190	50 005 004	11 51 9 071 560	50 005 020	PA0279	50 005 303
11 51 1 707 191	50 005 004	11 51 9 071 562	50 005 018	PA0285	50 005 106
11 51 1 707 192	50 005 004	11 51 9 071 564	50 005 511	PA0290	50 005 102
11 51 1 707 193	50 005 004	BUGATTI		PA0313	50 005 142
11 51 1 707 414	50 005 000	PA0021	50 005 321	PA0316	50 005 145
11 51 1 711 492	50 005 018	PA0026	50 005 306	PA0317	50 005 146
11 51 1 713 266	50 005 778	PA0071	50 005 307	PA0319	50 005 148
11 51 1 715 292	50 005 005	PA0075	50 005 314	PA0319C	50 005 151
11 51 1 719 836	50 005 510	PA0082	50 005 042	PA0320	50 005 140
11 51 1 720 609	50 005 510	PA0083	50 005 053	PA0320C	50 005 150
11 51 1 720 883	50 005 004	PA0085	50 005 045	PA0321	50 005 160
11 51 1 720 892	50 005 004	PA0091	50 005 052	PA0323	50 005 162
11 51 1 720 893	50 005 004	PA0092	50 005 051	PA0324	50 005 162
11 51 1 721 337	50 005 005	PA0092	50 005 051	PA0325	50 005 149
11 51 1 721 477	50 005 009	PA0093	50 005 043	PA0325	50 005 149
11 51 1 721 872	50 005 515	PA0093	50 005 043	PA0350	50 005 221
11 51 1 722 536	50 005 513	PA0095	50 005 049	PA0515	50 005 324
11 51 1 727 123	50 005 514	PA0098	50 005 055	PA0611	50 005 196
11 51 1 727 468	50 005 515	PA0099	50 005 059	PA10002	50 005 783
11 51 1 730 414	50 005 513	PA0132	50 005 033	PA10003	50 005 908
11 51 1 731 680	50 005 517	PA0135	50 005 032	PA10003	50 005 908
11 51 1 734 269	50 005 514	PA0135	50 005 035	PA10005	50 005 771
11 51 1 734 595	50 005 515	PA0135	50 005 932	PA10011	50 005 027
11 51 1 734 602	50 005 515	PA0136	50 005 034	PA10011	50 005 171
11 51 1 736 146	50 005 517	PA0136	50 005 034	PA10014	50 005 755
11 51 1 740 241	50 005 513	PA0138	50 005 038	PA10014	50 005 755
11 51 1 741 001	50 005 517	PA0138	50 005 038	PA10015	50 005 011
11 51 1 742 498	50 005 517	PA0139	50 005 021	PA10016	50 005 784
11 51 1 742 647	50 005 519	PA0140	50 005 029	PA10017	50 005 056
11 51 1 744 243	50 005 513	PA0141	50 005 028	PA10019	50 005 793
11 51 2 241 641	50 005 512	PA0142	50 005 031	PA10020	50 005 900
11 51 2 242 176	50 005 511	PA0144	50 005 440	PA10021	50 005 777
11 51 2 242 675	50 005 512	PA0145	50 005 442	PA10023	50 005 909
11 51 2 242 677	50 005 511	PA0145	50 005 446	PA10025	50 005 044
11 51 2 243 003	50 005 516	PA0146	50 005 439	PA10030	50 005 003
11 51 2 244 333	50 005 516	PA0147	50 005 441	PA10030	50 005 003
11 51 2 245 687	50 005 516	PA0147	50 005 447	PA10031	50 005 760
11 51 2 354 055	50 005 786	PA0148	50 005 447	PA10033	50 005 006
11 51 7 503 884	50 005 513	PA0148	50 005 030	PA10034	50 005 098
11 51 7 504 040	50 005 513	PA0180	50 005 311	PA10035	50 005 087
11 51 7 510 803	50 005 044	PA0188	50 005 325	PA10036	50 005 092
11 51 7 511 220	50 005 011	PA0189	50 005 302	PA10037	50 005 767
11 51 7 511 221	50 005 011	PA0189	50 005 326	PA1004	50 005 773
11 51 7 513 062	50 005 044	PA0190	50 005 323	PA10040	50 005 764
11 51 7 527 799	50 005 513	PA0193	50 005 318	PA10041	50 005 798
11 51 7 527 910	50 005 513	PA0195	50 005 316	PA10043	50 005 001
11 51 7 786 192	50 005 785	PA0200	50 005 002	PA10043	50 005 061
11 51 7 788 305	50 005 784	PA0201	50 005 000	PA10044	50 005 008
11 51 7 791 834	50 005 784	PA0203	50 005 019	PA10047	50 005 799
11 51 7 829 914	50 005 044	PA0205	50 005 020	PA10048	50 005 183
11 51 7 829 922	50 005 044	PA0207	50 005 004	PA10051	50 005 795
11 51 9 056 401	50 005 002	PA0209	50 005 009	PA10052	50 005 762
11 51 9 058 996	50 005 018	PA0210	50 005 512	PA10053	50 005 753
11 51 9 068 606	50 005 516	PA0211	50 005 018	PA10055	50 005 141
11 51 9 069 529	50 005 516	PA0212	50 005 510	PA10058	50 005 180
11 51 9 070 755	50 005 009	PA0213	50 005 511	PA10059	50 005 768
11 51 9 070 757	50 005 000	PA0214	50 005 005	PA1006	50 005 756
11 51 9 070 758	50 005 510	PA0230	50 005 062	PA10066	50 005 096
11 51 9 070 759	50 005 510	PA0231	50 005 064	PA10067	50 005 796
11 51 9 070 760	50 005 004	PA0234R	50 005 065	PA10071	50 005 182
11 51 9 070 761	50 005 004	PA0239	50 005 720	PA10072	50 005 086
11 51 9 070 763	50 005 005	PA0240	50 005 063	PA10076	50 005 198
		PA0240	50 005 721	PA10091	50 005 122
		PA0242	50 005 067	PA10092	50 005 206
		PA0243	50 005 530	PA10095	50 005 013
		PA0246	50 005 068	PA10102	50 005 097



CROSS REFERENCE



CROSS REFERENCE

Reference 	Reference 	Reference 
BUGATTI		
PA1051 50 005 304	PA6808 50 005 433	PA8713 50 005 551
PA1053 50 005 319	PA6810 50 005 430	PA8713 50 005 555
PA1080 50 005 735	PA6811 50 005 434	PA8801 50 005 107
PA1081 50 005 736	PA6811 50 005 436	PA8803 50 005 107
PA1082 50 005 733	PA6814 50 005 036	PA9002 50 005 100
PA1083 50 005 740	PA6815 50 005 454	PA9101 50 005 073
PA1084 50 005 739	PA6816 50 005 435	PA9102 50 005 072
PA1085 50 005 737	PA6816 50 005 437	PA9103 50 005 076
PA1172 50 005 308	PA6818 50 005 491	PA9104 50 005 075
PA5013 50 005 332	PA6819 50 005 490	PA9201 50 005 095
PA5101 50 005 553	PA6820 50 005 470	PA9202 50 005 903
PA5102 50 005 550	PA6821 50 005 474	PA9204 50 005 123
PA5103 50 005 166	PA6822 50 005 475	PA9301 50 005 178
PA5104 50 005 551	PA6823 50 005 457	PA9302 50 005 179
PA5104 50 005 552	PA6824 50 005 455	PA9303 50 005 177
PA5106 50 005 551	PA7102 50 005 172	
PA5107 50 005 156	PA7103 50 005 136	BUGIAD
PA5108 50 005 158	PA7109 50 005 791	BSP20297 50 005 819
PA5109 50 005 155	PA7112 50 005 169	BSP20298 50 005 844
PA5110 50 005 167	PA7201 50 005 741	BSP20300 50 005 811
PA5111 50 005 181	PA7202 50 005 734	
PA5114 50 005 132	PA7203 50 005 732	BURKERT
PA5115 50 005 168	PA7204 50 005 738	20 1402 28760 50 005 870
PA5117 50 005 905	PA7205 50 005 741	20 1405 41306 50 005 871
PA5118 50 005 554	PA7207 50 005 746	20 1405 41315 50 005 873
PA5201 50 005 084	PA7208 50 005 748	20 1405 41320 50 005 874
PA5204 50 005 082	PA7209 50 005 224	20 1405 51316 50 005 872
PA5205 50 005 080	PA7212 50 005 749	20 1602 25660 50 005 210
PA5206 50 005 090	PA7213 50 005 747	20 1602 25661 50 005 207
PA5401 50 005 513	PA7404 50 005 339	20 1603 35500 50 005 211
PA5402 50 005 514	PA7405 50 005 322	20 1603 36000 50 005 203
PA5403 50 005 515	PA7408 50 005 339	20 1603 36400 50 005 633
PA5404 50 005 516	PA7409 50 005 330	20 1603 40300 50 005 207
PA5405 50 005 517	PA7409 50 005 779	20 1603 40301 50 005 210
PA5408 50 005 519	PA7701 50 005 301	20 1603 42201 50 005 205
PA5415 50 005 778	PA7703 50 005 341	
PA5418 50 005 785	PA7704 50 005 317	CENTRO
PA5501 50 005 313	PA7712 50 005 309	0 986 002 333 50 005 043
PA5501 50 005 333	PA7713 50 005 337	0 986 002 335 50 005 321
PA5502 50 005 320	PA7714 50 005 340	0 986 002 382 50 005 739
PA5504 50 005 310	PA7715 50 005 040	0 986 002 383 50 005 741
PA5508 50 005 331	PA7716 50 005 336	0 986 002 413 50 005 433
PA5509 50 005 329	PA7717 50 005 335	0 986 002 414 50 005 434
PA5510 50 005 761	PA7718 50 005 170	0 986 002 414 50 005 436
PA5702 50 005 077	PA7718 50 005 170	0 986 002 415 50 005 435
PA5703 50 005 078	PA7724 50 005 794	0 986 002 416 50 005 036
PA5929 50 005 780	PA7801 50 005 225	0 986 002 421 50 005 317
PA5937 50 005 334	PA7802 50 005 223	0 986 002 429 50 005 551
PA5943 50 005 057	PA8101 50 005 176	0 986 002 441 50 005 437
PA6003 50 005 727	PA8505 50 005 187	0 986 002 442 50 005 309
PA6010 50 005 119	PA8507 50 005 189	0 986 002 450 50 005 000
PA6011 50 005 120	PA8508 50 005 188	0 986 002 451 50 005 002
PA6012 50 005 216	PA8701 50 005 163	0 986 002 453 50 005 062
PA6013 50 005 215	PA8702 50 005 153	0 986 002 454 50 005 042
PA6015 50 005 751	PA8703 50 005 138	0 986 002 465 50 005 021
PA6016 50 005 752	PA8704 50 005 139	0 986 002 474 50 005 053
PA6203 50 005 079	PA8705 50 005 165	0 986 002 504 50 005 307
PA6703 50 005 111	PA8706 50 005 164	0 986 002 505 50 005 314
PA6801 50 005 425	PA8707 50 005 137	0 986 002 506 50 005 310
PA6802 50 005 449	PA8708 50 005 159	0 986 002 509 50 005 146
PA6804 50 005 428	PA8710 50 005 154	0 986 002 511 50 005 149
PA6805 50 005 425	PA8711 50 005 772	0 986 002 513 50 005 019
PA6807 50 005 427	PA8712 50 005 556	0 986 002 515 50 005 020
	PA8712 50 005 750	



CROSS REFERENCE



CROSS REFERENCE

Reference 	Reference 	Reference 
CENTRO	CENTRO	COPARTS
0 986 002 516 50 005 018	0 986 002 782 50 005 427	01 33 3110 50 005 323
0 986 002 517 50 005 009	0 986 002 783 50 005 446	01 33 3330 50 005 317
0 986 002 519 50 005 512	0 986 002 938 50 005 516	01 33 3480 50 005 301
0 986 002 520 50 005 510	0 986 002 939 50 005 030	01 33 3900 50 005 309
0 986 002 521 50 005 004	0 986 002 945 50 005 732	01 33 4640 50 005 302
0 986 002 522 50 005 511	0 986 002 946 50 005 734	01 33 5040 50 005 316
0 986 002 524 50 005 005	0 986 002 947 50 005 738	01 33 5120 50 005 318
0 986 002 526 50 005 035	0 986 002 949 50 005 304	01 33 6500 50 005 308
0 986 002 530 50 005 038		01 47 2720 50 005 102
0 986 002 533 50 005 028	CHAMPION	01 47 4730 50 005 106
0 986 002 537 50 005 447	U578 50 005 136	01 48 4690 50 005 221
0 986 002 539 50 005 064		01 51 0050 50 005 005
0 986 002 540 50 005 530	CITROEN	01 51 0140 50 005 511
0 986 002 548 50 005 065	1001 30 50 005 863	01 51 0160 50 005 513
0 986 002 551 50 005 720	1001 40 50 005 863	01 51 0190 50 005 514
0 986 002 554 50 005 063	1001 50 50 005 820	01 51 0200 50 005 515
0 986 002 555 50 005 067	1001 56 50 005 815	01 51 1530 50 005 002
0 986 002 556 50 005 059	1001 68 50 005 825	01 51 2190 50 005 019
0 986 002 556 50 005 727	1001 69 50 005 853	01 51 2750 50 005 020
0 986 002 558 50 005 045	1001 77 50 005 854	01 51 2830 50 005 000
0 986 002 560 50 005 051	1001 91 50 005 826	01 51 2920 50 005 018
0 986 002 567 50 005 049	1001 92 50 005 824	01 51 3030 50 005 004
0 986 002 568 50 005 055	1201E8 50 005 779	01 51 3430 50 005 009
0 986 002 571 50 005 736	1201-G0 50 005 757	01 51 3520 50 005 512
0 986 002 572 50 005 735	75530147 50 005 306	01 51 6540 50 005 510
0 986 002 573 50 005 740	91511136 50 005 307	01 52 0720 50 005 449
0 986 002 576 50 005 737	9401201390 50 005 307	01 52 1780 50 005 033
0 986 002 577 50 005 142	9401201480 50 005 320	01 52 2450 50 005 034
0 986 002 578 50 005 140	9451001263 50 005 310	01 52 2620 50 005 035
0 986 002 580 50 005 148	95625017 50 005 319	01 52 2710 50 005 038
0 986 002 581 50 005 150	95641148 50 005 307	01 52 2940 50 005 021
0 986 002 581 50 005 151	95641149 50 005 320	01 52 3440 50 005 029
0 986 002 591 50 005 306	95643824 50 005 320	01 52 3450 50 005 028
0 986 002 594 50 005 313	95650955 50 005 313	01 52 4160 50 005 031
0 986 002 617 50 005 303	95655207 50 005 307	01 52 4240 50 005 030
0 986 002 640 50 005 324	95655208 50 005 319	01 52 4250 50 005 439
0 986 002 666 50 005 319	95655209 50 005 320	01 52 4930 50 005 440
0 986 002 669 50 005 311	95655210 50 005 320	01 52 4930 50 005 446
0 986 002 674 50 005 323	95656566 50 005 307	01 52 4930 50 005 446
0 986 002 675 50 005 302	95656567 50 005 319	01 52 5460 50 005 427
0 986 002 675 50 005 326	95656568 50 005 320	01 52 5470 50 005 447
0 986 002 677 50 005 325	95656569 50 005 320	01 52 6970 50 005 425
0 986 002 682 50 005 318	95666768 50 005 313	01 52 7900 50 005 428
0 986 002 684 50 005 316	96047088 50 005 322	01 53 0470 50 005 068
0 986 002 697 50 005 221	9608564280 50 005 339	01 53 2660 50 005 064
0 986 002 724 50 005 102	9617376980 50 005 310	01 53 3120 50 005 062
0 986 002 725 50 005 106		01 53 3560 50 005 720
0 986 002 740 50 005 029	CLEAN-FILTER	01 53 4190 50 005 065
0 986 002 744 50 005 320	MA662 50 005 136	01 53 4350 50 005 530
0 986 002 747 50 005 725		01 53 4370 50 005 727
0 986 002 749 50 005 068	COPARTS	01 53 5090 50 005 067
0 986 002 749 50 005 428	01 23 4670 50 005 303	01 53 5900 50 005 725
0 986 002 751 50 005 308	01 23 6815 50 005 324	01 54 1060 50 005 042
0 986 002 759 50 005 153	01 23 7420 50 005 321	01 54 1370 50 005 043
0 986 002 769 50 005 515	01 31 0210 50 005 320	01 54 1820 50 005 741
0 986 002 770 50 005 514	01 31 0350 50 005 319	01 54 2140 50 005 741
0 986 002 771 50 005 513	01 31 0370 50 005 313	01 54 2570 50 005 045
0 986 002 772 50 005 449	01 31 3500 50 005 307	01 54 2610 50 005 053
0 986 002 777 50 005 052	01 31 3970 50 005 306	01 54 2930 50 005 051
0 986 002 778 50 005 425	01 31 5920 50 005 310	01 54 3000 50 005 043
0 986 002 779 50 005 733	01 32 2990 50 005 063	01 54 3040 50 005 052
0 986 002 780 50 005 031	01 32 4180 50 005 314	01 54 3140 50 005 049
0 986 002 781 50 005 439	01 32 4830 50 005 304	01 54 3220 50 005 055
	01 33 2360 50 005 311	01 54 3240 50 005 059



CROSS REFERENCE



CROSS REFERENCE

Reference 	Reference 	Reference 
COPARTS	DEUTZ	DOLZ
01 54 3310 50 005 738	0223 7923 50 005 369	A-300 50 005 056
01 54 3840 50 005 746	0241 6767 50 005 368	B-144 50 005 621
01 54 4270 50 005 735	0241 6768 50 005 873	B-201 50 005 002
01 54 4280 50 005 740	0414 3184 50 005 872	B-202 50 005 019
01 54 6700 50 005 736	0414 3509 50 005 874	B-203 50 005 000
01 54 6710 50 005 739	0414 3644 50 005 368	B-204 50 005 004
01 54 6720 50 005 733	0414 3645 50 005 873	B-205 50 005 020
01 54 6980 50 005 737	0415 2881 50 005 369	B-206 50 005 018
01 56 1900 50 005 153	0415 4885 50 005 369	B-207 50 005 009
01 56 2800 50 005 142	0415 9966 50 005 369	B-210 50 005 512
01 56 2970 50 005 146	0423 0653 50 005 367	B-211 50 005 511
01 56 3530 50 005 158	0423 0787 50 005 369	B-212 50 005 510
01 56 3860 50 005 148	0423 1142 50 005 369	B-213 50 005 005
01 56 3865 50 005 151	0423 1306 50 005 369	B-214 50 005 513
01 56 4340 50 005 139	0423 1309 50 005 367	B-215 50 005 514
01 56 4680 50 005 140		B-216 50 005 515
01 56 4685 50 005 150	DOLZ	B-219 50 005 516
01 56 4870 50 005 145	A-150 50 005 140	B-221 50 005 784
01 56 4900 50 005 155	A-151 50 005 148	B-222 50 005 785
01 56 4905 50 005 156	A-152 50 005 145	B-223 50 005 786
01 56 5910 50 005 160	A-154 50 005 146	B-225 50 005 011
01 56 6690 50 005 162	A-158 50 005 149	B-317 50 005 517
01 56 6930 50 005 138	A-159 50 005 142	B-318 50 005 519
	A-160 50 005 150	B-318 50 005 778
CUMMINS	A-161 50 005 151	C-110 50 005 310
3802081 50 005 242	A-164 50 005 153	C-111 50 005 339
3802278 50 005 219	A-165 50 005 160	C-112 50 005 322
3930337 50 005 217	A-167 50 005 162	C-114 50 005 757
3960342 50 005 241	A-169 50 005 553	C-115 50 005 306
	A-170 50 005 138	C-117 50 005 313
DACIA	A-171 50 005 550	C-118 50 005 313
82 00 227 686 50 005 849	A-172 50 005 166	C-120 50 005 329
	A-174 50 005 167	C-122 50 005 758
DAEWOO	A-175 50 005 181	C-124 50 005 761
24409355 50 005 074	A-176 50 005 163	C-124 50 005 765
90444359 50 005 074	A-178 50 005 551	C-127 50 005 779
90 466 343 50 005 734	A-179 50 005 139	C-129 50 005 762
92 064 250 50 005 734	A-180 50 005 552	C-130 50 005 330
92065969 50 005 074	A-181 50 005 165	C-131 50 005 331
94013802 50 005 073	A-182 50 005 158	C-134 50 005 766
96182871 50 005 076	A-183 50 005 155	D-210 50 005 072
96350799 50 005 072	A-184 50 005 156	D-211 50 005 076
96351284 50 005 073	A-187 50 005 132	D-213 50 005 073
96 351 969 50 005 059	A-188 50 005 769	D-214 50 005 075
96351971 50 005 073	A-189 50 005 137	F-105 50 005 064
96352648 50 005 072	A-190 50 005 168	F-107 50 005 065
96352649 50 005 073	A-191 50 005 154	F-112 50 005 063
96352650 50 005 076	A-192 50 005 159	F-112 50 005 721
96518977 50 005 075	A-193 50 005 554	F-114 50 005 727
96563958 50 005 075	A-194 50 005 777	F-115 50 005 720
	A-195 50 005 905	F-120 50 005 067
DAIHATSU	A-196 50 005 556	F-121 50 005 062
16100-87108 50 005 077	A-197 50 005 750	F-127 50 005 530
16100-87109 50 005 078	A-198 50 005 775	F-132 50 005 118
16100-87182 50 005 077	A-199 50 005 781	F-133 50 005 119
16100-87183 50 005 078	A-200 50 005 754	F-135 50 005 725
16100-87184 50 005 077	A-201 50 005 771	F-137 50 005 068
16100-87185 50 005 078	A-202 50 005 008	F-138 50 005 117
	A-203 50 005 783	F-139 50 005 120
DEUTZ	A-207 50 005 770	F-140 50 005 901
0213 0385 50 005 367	A-210 50 005 007	F-141 50 005 215
0213 0440 50 005 366	A-218 50 005 001	F-148 50 005 013
0214 4036 50 005 871	A-280 50 005 555	F-149 50 005 752
0214 4037 50 005 871		





CROSS REFERENCE

CROSS REFERENCE

Reference 	Reference 	Reference 
FAI AUTOMOTIVE	FAI AUTOMOTIVE	FEBI
WP2194 50 005 055	WP6117 50 005 437	02086 50 005 555
WP2226 50 005 145	WP6121 50 005 322	02086 50 005 798
WP2304 50 005 065	WP6132 50 005 309	02134 50 005 868
WP2338 50 005 306	WP6145 50 005 433	02286 50 005 428
WP2350 50 005 028	WP6146 50 005 036	02292 50 005 440
WP2354 50 005 029	WP6147 50 005 435	02292 50 005 442
WP2358 50 005 009	WP6148 50 005 430	02292 50 005 446
WP2450 50 005 031	WP6151 50 005 434	02447 50 005 834
WP2456 50 005 314	WP6151 50 005 436	02484 50 005 803
WP2471 50 005 052	WP6158 50 005 030	02646 50 005 807
WP2474 50 005 325	WP6159 50 005 449	03054 50 005 146
WP2477 50 005 004	WP952 50 005 140	03221 50 005 366
WP2492 50 005 310	WP952BH 50 005 150	03521 50 005 142
WP2495 50 005 067	WP957 50 005 311	04615 50 005 817
WP2496 50 005 304	WP969 50 005 102	04728 50 005 738
WP2499 50 005 316	WP970 50 005 053	04729 50 005 734
WP2500 50 005 321	WP985 50 005 064	04731 50 005 732
WP2507 50 005 018	WP986 50 005 142	05298 50 005 843
WP2512 50 005 735	WP995 50 005 032	05357 50 005 447
WP2513 50 005 733	WP995 50 005 035	05376 50 005 030
WP2517 50 005 736		05377 50 005 433
WP2525 50 005 063	FEBI	05633 50 005 725
WP2527 50 005 530	01073 50 005 145	05634 50 005 065
WP2545 50 005 720	01092 50 005 550	05807 50 005 835
WP2563 50 005 446	01246 50 005 064	05808 50 005 829
WP2565 50 005 727	01255 50 005 051	06001 50 005 806
WP2567 50 005 160	01256 50 005 049	06022 50 005 822
WP2646 50 005 005	01257 50 005 052	07521 50 005 801
WP2652 50 005 068	01259 50 005 735	07527 50 005 845
WP2660 50 005 308	01260 50 005 733	07685 50 005 837
WP2661 50 005 301	01262 50 005 059	07923 50 005 166
WP2665 50 005 162	01262 50 005 072	07987 50 005 827
WP2667 50 005 447	01265 50 005 736	07988 50 005 828
WP2674 50 005 162	01266 50 005 055	08012 50 005 800
WP2689 50 005 740	01282 50 005 530	08013 50 005 867
WP2735 50 005 513	01283 50 005 720	08035 50 005 830
WP2800 50 005 737	01285 50 005 140	08312 50 005 165
WP2804 50 005 514	01286 50 005 148	08448 50 005 808
WP2884 50 005 320	01287 50 005 151	08450 50 005 809
WP2891 50 005 319	01288 50 005 009	08454 50 005 804
WP2911 50 005 425	01289 50 005 510	08455 50 005 813
WP2925 50 005 163	01290 50 005 018	08551 50 005 802
WP2941 50 005 307	01291 50 005 019	08657 50 005 021
WP2944 50 005 313	01292 50 005 512	08693 50 005 810
WP2962 50 005 225	01293 50 005 513	08699 50 005 866
WP2971 50 005 428	01294 50 005 004	08700 50 005 805
WP2997 50 005 302	01295 50 005 005	08756 50 005 427
WP3067 50 005 515	01296 50 005 515	09018 50 005 759
WP3084 50 005 738	01297 50 005 514	09021 50 005 317
WP3090 50 005 107	01349 50 005 150	09023 50 005 341
WP3096 50 005 516	01350 50 005 028	09024 50 005 302
WP3116 50 005 427	01353 50 005 029	09024 50 005 326
WP3124 50 005 317	01354 50 005 425	09025 50 005 325
WP3141 50 005 303	01356 50 005 032	09027 50 005 308
WP3193 50 005 148	01356 50 005 035	09107 50 005 434
WP3193BH 50 005 151	01558 50 005 038	09107 50 005 436
WP6057 50 005 322	01658 50 005 031	09108 50 005 449
WP6058 50 005 550	01663 50 005 439	09197 50 005 632
WP6059 50 005 166	01733 50 005 812	09255 50 005 339
WP6063 50 005 552	01853 50 005 153	09257 50 005 320
WP6065 50 005 551	01906 50 005 149	09258 50 005 319
WP6100 50 005 165	01962 50 005 836	09259 50 005 339
WP6102 50 005 167	02086 50 005 551	09260 50 005 310



CROSS REFERENCE



Reference 	Reference 	Reference 
FORD	FORD	FORD
1096556 50 005 013	5 010 878 50 005 721	A 840 X 8591 AA 50 005 727
1 100 635 50 005 554	5 011 013 50 005 720	A 840 X 8591 ATA 50 005 727
1100687 50 005 819	5 011 846 50 005 067	A 840 X 8591 BAA 50 005 063
1104115 50 005 216	5 011 863 50 005 721	A 840 X 8591 BCA 50 005 530
1109341 50 005 120	5 012 322 50 005 720	A 840 X 8591 JA 50 005 720
1114354 50 005 215	5 012 773 50 005 727	D5NN-6600-D 50 005 842
1116996 50 005 752	5 013 320 50 005 530	D 8 RZ 8501 A 50 005 064
1 119 276 50 005 751	5 018 437 50 005 065	E1NN-6600-DC 50 005 842
1124931 50 005 819	5 019 394 50 005 304	EINN6600CC 50 005 220
1130582 50 005 215	5 020 242 50 005 725	EINN6600DC 50 005 226
1131878 50 005 216	5 020 437 50 005 068	EPW 20 50 005 727
1132607 50 005 119	5 020 651 50 005 530	EPW 33 50 005 065
1136393 50 005 013	5 023 817 50 005 720	EPW 38 50 005 727
1 142 005 50 005 751	5 024 545 50 005 727	EPW 40 50 005 725
1 142 427 50 005 751	5 024 603 50 005 064	EPW 45 50 005 314
1143851 50 005 752	5 024 638 50 005 314	EPW 50 50 005 063
1146965 50 005 013	5025 077 50 005 136	EPW 51 50 005 721
1147585 50 005 758	5 025 908 50 005 068	EPW 56 50 005 062
1 213 357 50 005 165	5 026 076 50 005 067	EPW 58 50 005 062
1227902 50 005 215	5 026 783 50 005 068	EPW 61 50 005 720
1 229 571 50 005 787	6 039 328 50 005 064	EPW 64 50 005 067
1 232 499 50 005 779	6 043 065 50 005 062	EPW 65 50 005 720
1308452 50 005 013	6 049 790 50 005 062	EPW 68 50 005 063
1308453 50 005 013	6 050 034 50 005 064	EPW 69 50 005 063
1 313 842 50 005 762	6 050 907 50 005 064	EPW 70 50 005 530
1317038 50 005 215	6 065 711 50 005 063	EPW 71 50 005 068
1320876 50 005 215	6610572 50 005 839	EPW 82 50 005 725
1326374 50 005 119	71HM-6600-AA 50 005 821	EPW 981 50 005 062
1348621 50 005 758	7 269 023 50 005 774	EPW 985 50 005 064
1350461 50 005 119	81868537 50 005 227	X56 E 8501 AD 50 005 787
1 351 130 50 005 762	83 EF 8501 AA 50 005 314	XM21-6600-AA 50 005 819
1359942 50 005 758	88 BX 8591 AA 50 005 068	XM21-6600-BA 50 005 819
1 364 681 50 005 762	88 FX 8591 AA 50 005 725	XS4J8591AC 50 005 216
1376162 50 005 119	88 FX 8591 AB 50 005 725	XS4J8591DB 50 005 216
1385824 50 005 013	88 GX 8591 AA 50 005 304	XS7Q8K500AE 50 005 752
1385827 50 005 013	89 EX 8591 AA 50 005 314	
1438157 50 005 821	900X9601AKA 50 005 136	FRAM
1 527 289 50 005 062	914 FX 8591 AA 50 005 727	CA5164 50 005 136
1669841 50 005 806	924F-6600-AB 50 005 839	GERI
19BBX8591FA 50 005 215	92 BX 8591 BA 50 005 068	310.500 50 005 632
1S7 G8501 AK 50 005 751	92 TX 8591 DA 50 005 067	312.004 50 005 035
1S7 G8501 AL 50 005 751	95VW-6600-BA 50 005 806	312.012 50 005 021
1S7 G8501 AN 50 005 751	95 VW 8503 AA 50 005 148	312.014 50 005 028
256 G 8591 AA 50 005 787	96BX8591A2B 50 005 120	312.016 50 005 029
3 006 897 50 005 774	96BX8591AA 50 005 120	312.018 50 005 038
3 667 653 50 005 774	96 FX 8591 AA 50 005 725	312.020 50 005 425
3 715 703 50 005 774	96MX8591AA 50 005 119	312.024 50 005 433
3 800 766 50 005 774	978M8501NH 50 005 215	312.026 50 005 031
3 M5 Q 8591 BB 50 005 762	988M8501TJ 50 005 215	312.028 50 005 439
4 096 620 50 005 774	988X8591F1D 50 005 215	312.030 50 005 446
4 356 532 50 005 774	988X8591FC 50 005 215	312.034 50 005 434
4 448 290 50 005 774	A 790 X 8591 ALA 50 005 063	312.034 50 005 436
5 004 995 50 005 063	A 790 X 8591 ANA 50 005 063	312.036 50 005 449
5 005 194 50 005 062	A 790 X 8591 HCA 50 005 062	312.038 50 005 430
5 005 197 50 005 064	A 790 X 8591 HFA 50 005 064	312.040 50 005 738
5 006 043 50 005 063	A 790 X 8591 RLA 50 005 063	312.042 50 005 447
5 006 046 50 005 721	A 810 X 8591 FA 50 005 062	312.046 50 005 030
5 007 749 50 005 062	A 810 X 8591 HA 50 005 062	312.048 50 005 427
5 007 852 50 005 062	A 810 X 8591 SA 50 005 065	312.050 50 005 435
5 008 470 50 005 065	A 820 X 8591 BA 50 005 721	312.052 50 005 437
5 009 286 50 005 063	A 830 X 8591 CTA 50 005 067	312.054 50 005 428
5 009 287 50 005 721	A 830 X 8591 KA 50 005 721	312.058 50 005 036
5 009 823 50 005 314	A 830 X 8591 TA 50 005 720	

CROSS REFERENCE



CROSS REFERENCE



CROSS REFERENCE

Reference 	Reference 	Reference 
GKN	GMB	GRAF
0.060306	50 005 005	GWBE-01A 50 005 033
0.060315	50 005 733	GWBE-02A 50 005 032
0.060316	50 005 737	GWBE-02A 50 005 035
0.060319	50 005 313	GWBE-03A 50 005 021
0.060320	50 005 320	GWBM-01A 50 005 019
0.060324	50 005 739	GWBM-02A 50 005 009
0.060325	50 005 447	GWBM-03A 50 005 020
0.060326	50 005 427	GWBM-04A 50 005 018
0.060333	50 005 308	GWBM-05A 50 005 000
0.060340	50 005 068	GWBM-06A 50 005 004
0.060341	50 005 725	GWBM-07A 50 005 002
0.060344	50 005 428	GWBM-08A 50 005 510
0.060345	50 005 449	GWF-10A 50 005 064
0.060350	50 005 153	GWF-14A 50 005 062
0.060354	50 005 515	GWF-18A 50 005 063
0.060355	50 005 514	GWF-40A 50 005 065
0.060356	50 005 513	GWF-49A 50 005 067
0.060506	50 005 516	GWF-65A 50 005 530
0.060507	50 005 030	GWF-87A 50 005 727
0.060531	50 005 433	GWF-88A 50 005 068
0.060532	50 005 434	GWF-89A 50 005 725
0.060532	50 005 436	GWO-01A 50 005 043
0.060534	50 005 435	GWO-02 50 005 042
0.060535	50 005 036	GWO-03A 50 005 045
0.060539	50 005 732	GWO-05AP 50 005 052
0.060540	50 005 734	GWO-06A 50 005 051
0.060541	50 005 741	GWO-08AP 50 005 053
0.060542	50 005 738	GWO-09A 50 005 055
0.060547	50 005 317	GWO-10A 50 005 735
0.060548	50 005 309	GWO-11A 50 005 736
0.060565	50 005 551	GWO-12A 50 005 737
0.060593	50 005 452	GWO-13A 50 005 059
0.060598	50 005 224	GWO-15A 50 005 740
0.060603	50 005 132	GWR-06A 50 005 301
0.060605	50 005 746	GWR-11A 50 005 302
0.091001	50 005 142	GWR-12A 50 005 301
0.091003	50 005 019	GWSA-02A 50 005 221
0.091004	50 005 020	GWVW-05A 50 005 142
0.091005	50 005 000	GWVW-06A 50 005 146
0.091006	50 005 002	GWVW-07A 50 005 148
0.091010	50 005 062	GWVW-07AH 50 005 151
0.091012	50 005 064	GWVW-09A 50 005 140
0.091013	50 005 065	GWVW-09AH 50 005 150
0.091014	50 005 042	GWVW-10A 50 005 145
0.091016	50 005 045	
0.091018	50 005 049	
0.091019	50 005 051	
0.091021	50 005 055	
0.091032	50 005 148	
0.091035	50 005 146	
0.091041	50 005 004	
0.091042	50 005 009	
0.091043	50 005 018	
0.091062	50 005 021	
0.091066	50 005 028	
0.091069	50 005 031	
0.091106	50 005 053	
0.091129	50 005 311	
0.091163	50 005 102	
0.091176	50 005 439	
		GP
		PA1129 50 005 934
		GRAF
		PA031 50 005 620
		PA044 50 005 043
		PA046 50 005 042
		PA053 50 005 002
		PA1009 50 005 133
		PA1015 50 005 110
		PA102 50 005 146
		PA103 50 005 145
		PA105 50 005 035
		PA105 30MM 50 005 932
		PA106 50 005 021
		PA108 50 005 051
		PA114 50 005 102
		PA115 50 005 020
		PA117 50 005 063
		PA119 50 005 038
		PA121 50 005 053
		PA127 50 005 323
		PA133 50 005 033
		PA134 50 005 032
		PA135 50 005 034
		PA142 50 005 311
		PA146 50 005 140
		PA148 50 005 142
		PA149 50 005 019
		PA150 50 005 045
		PA153 50 005 064
		PA174 50 005 062
		PA178 50 005 321
		PA232 50 005 065
		PA235 50 005 049
		PA236 50 005 055
		PA240 50 005 306
		PA243 50 005 018
		PA247 50 005 325
		PA254 50 005 301
		PA256 50 005 307
		PA264 50 005 009
		PA270 50 005 512
		PA272 50 005 028
		PA278 50 005 720
		PA279 50 005 148
		PA284 50 005 221
		PA286 50 005 303
		PA286A 50 005 303
		PA297 50 005 314
		PA301 50 005 318
		PA303 50 005 304
		PA312 50 005 106
		PA319 50 005 160
		PA320 50 005 162
		PA321 50 005 530
		PA322 50 005 067
		PA323 50 005 727
		PA324 50 005 736
		PA325 50 005 735
		PA326 50 005 740
		PA328 50 005 310
		PA344 50 005 162
		PA348 50 005 319
		PA351 50 005 196
		PA363 50 005 324
		PA369 50 005 510
		PA370 50 005 511
		PA377 50 005 029
		PA379 50 005 000
		PA380 50 005 004
		PA383 50 005 149
		PA390 50 005 005
		PA391 50 005 313
		PA393 50 005 320
		PA401 50 005 068
		PA403 50 005 725
		PA406 50 005 428
		PA409 50 005 737
		PA410 50 005 739
		PA412 50 005 308





CROSS REFERENCE

CROSS REFERENCE

Reference 		Reference 		Reference 	
GRAF		GRAF		GRAF	
PA414A	50 005 447	PA582	50 005 433	PA703	50 005 169
PA414A+KIT	50 005 441	PA583	50 005 036	PA706	50 005 490
PA415	50 005 741	PA584	50 005 435	PA707	50 005 455
PA422	50 005 553	PA586	50 005 551	PA708	50 005 474
PA423	50 005 138	PA591	50 005 550	PA709	50 005 475
PA424	50 005 163	PA592	50 005 166	PA710	50 005 457
PA425	50 005 153	PA593	50 005 551	PA711	50 005 456
PA428	50 005 084	PA593A	50 005 551	PA712	50 005 184
PA430	50 005 515	PA595	50 005 326	PA714	50 005 182
PA431	50 005 514	PA603	50 005 139	PA715	50 005 187
PA432	50 005 513	PA606	50 005 107	PA723	50 005 336
PA432A	50 005 513	PA608	50 005 452	PA724A	50 005 170
PA437A	50 005 111	PA609	50 005 158	PA725	50 005 178
PA439	50 005 121	PA610	50 005 437	PA726	50 005 179
PA439A	50 005 172	PA612	50 005 119	PA727	50 005 747
PA441	50 005 052	PA613	50 005 454	PA730	50 005 748
PA442	50 005 059	PA615	50 005 332	PA731	50 005 132
PA443	50 005 733	PA617	50 005 165	PA732	50 005 796
PA446	50 005 031	PA618	50 005 167	PA736	50 005 471
PA447	50 005 427	PA618A	50 005 167	PA737	50 005 786
PA448	50 005 439	PA620	50 005 780	PA738	50 005 075
PA449	50 005 446	PA623	50 005 335	PA741	50 005 215
PA449+KIT	50 005 440	PA624	50 005 324	PA742	50 005 216
PA449T	50 005 442	PA625	50 005 519	PA746	50 005 767
PA450	50 005 449	PA626	50 005 334	PA747	50 005 329
PA459	50 005 079	PA627	50 005 337	PA749	50 005 107
PA491	50 005 339	PA628	50 005 310	PA752	50 005 455
PA495	50 005 425	PA633	50 005 040	PA757	50 005 181
PA500	50 005 621	PA634	50 005 340	PA758	50 005 555
PA502	50 005 516	PA635	50 005 174	PA760	50 005 785
PA502A	50 005 516	PA636	50 005 223	PA761	50 005 556
PA508	50 005 136	PA637	50 005 224	PA762	50 005 554
PA514	50 005 341	PA638	50 005 225	PA763	50 005 905
PA517	50 005 721	PA639	50 005 120	PA764	50 005 777
PA519A	50 005 176	PA640	50 005 725	PA765	50 005 754
PA527	50 005 323	PA643	50 005 330	PA766	50 005 194
PA529	50 005 759	PA650	50 005 901	PA767	50 005 186
PA531	50 005 301	PA654	50 005 769	PA773	50 005 177
PA532	50 005 309	PA656	50 005 132	PA775	50 005 192
PA536	50 005 317	PA658	50 005 159	PA779	50 005 156
PA537	50 005 791	PA661	50 005 434	PA783	50 005 116
PA539	50 005 135	PA662	50 005 552	PA795	50 005 128
PA541	50 005 738	PA664	50 005 746	PA796	50 005 126
PA541A	50 005 793	PA665	50 005 749	PA803	50 005 794
PA542	50 005 322	PA668	50 005 086	PA804	50 005 772
PA543	50 005 316	PA669	50 005 087	PA805	50 005 768
PA546	50 005 150	PA670	50 005 092	PA806	50 005 750
PA550	50 005 302	PA672	50 005 332	PA809	50 005 100
PA555	50 005 078	PA674	50 005 154	PA814	50 005 173
PA556	50 005 077	PA675	50 005 168	PA821	50 005 171
PA558	50 005 107	PA676	50 005 137	PA822	50 005 756
PA562	50 005 082	PA677	50 005 164	PA823	50 005 753
PA563	50 005 080	PA678	50 005 470	PA824	50 005 764
PA564	50 005 090	PA679	50 005 155	PA826	50 005 189
PA567	50 005 030	PA684	50 005 331	PA829	50 005 096
PA570	50 005 517	PA687	50 005 491	PA830	50 005 141
PA571	50 005 741	PA694	50 005 072	PA832	50 005 013
PA572	50 005 734	PA695	50 005 073	PA834	50 005 755
PA572A	50 005 074	PA696	50 005 076	PA835	50 005 784
PA577	50 005 732	PA697	50 005 095	PA838	50 005 746
PA578	50 005 430	PA698	50 005 903	PA839	50 005 752
PA579	50 005 151	PA700	50 005 123	PA840	50 005 624
PA580	50 005 436	PA701	50 005 124	PA-842	50 005 605



CROSS REFERENCE

Reference 	Reference 	Reference 			
GRAF	HEPU	HEPU			
PA-843	50 005 604	P040	50 005 090	P185	50 005 440
PA-847	50 005 607	P046	50 005 084	P186	50 005 440
PA-853	50 005 608	P049	50 005 082	P187	50 005 449
PA855	50 005 770	P051	50 005 102	P188	50 005 433
PA856	50 005 778	P053	50 005 106	P189	50 005 428
PA859	50 005 758	P054	50 005 301	P191	50 005 434
PA860	50 005 044	P056	50 005 107	P192	50 005 434
PA861	50 005 779	P061	50 005 797	P193	50 005 434
PA862	50 005 761	P094	50 005 303	P195	50 005 435
PA863	50 005 765	P1011	50 005 334	P196	50 005 437
PA864	50 005 188	P1032	50 005 901	P197	50 005 437
PA865	50 005 797	P1043	50 005 780	P201	50 005 530
PA866	50 005 057	P1055	50 005 332	P202	50 005 727
PA-870	50 005 618	P1058	50 005 057	P204	50 005 068
PA872	50 005 632	P1089	50 005 056	P205	50 005 725
PA876	50 005 789	P133	50 005 165	P207	50 005 065
PA877	50 005 098	P134	50 005 776	P208	50 005 063
PA878	50 005 783	P135	50 005 455	P215	50 005 064
PA881	50 005 771	P136	50 005 490	P221	50 005 067
PA887	50 005 760	P138	50 005 908	P227	50 005 725
PA888	50 005 782	P139	50 005 782	P232	50 005 120
PA893	50 005 011	P140	50 005 470	P234	50 005 165
PA896	50 005 091	P1403	50 005 632	P235	50 005 119
PA897	50 005 788	P141	50 005 471	P236	50 005 215
PA898	50 005 798	P142	50 005 491	P237	50 005 216
PA899	50 005 908	P143	50 005 164	P242	50 005 148
PA901	50 005 056	P144	50 005 474	P243	50 005 151
PA902	50 005 787	P145	50 005 475	P246	50 005 752
PA903	50 005 751	P1464	50 005 633	P248	50 005 013
PA904	50 005 775	P147	50 005 457	P251	50 005 751
PA907	50 005 795	P148	50 005 456	P252	50 005 774
PA909	50 005 909	P149	50 005 767	P254	50 005 787
PA911	50 005 333	P1531	50 005 909	P296	50 005 062
PA912	50 005 799	P1532	50 005 010	P297	50 005 720
PA917	50 005 118	P1536	50 005 773	P299	50 005 721
PA919	50 005 183	P154	50 005 034	P309	50 005 740
PA923	50 005 193	P155/30	50 005 932	P310	50 005 739
PA925	50 005 094	P155/38	50 005 032	P312	50 005 059
PA930	50 005 127	P155/40	50 005 035	P313	50 005 741
PA931	50 005 115	P158	50 005 038	P314	50 005 732
PA932	50 005 175	P159	50 005 033	P315	50 005 053
PA933	50 005 117	P160	50 005 031	P316	50 005 074
PA935	50 005 129	P161	50 005 036	P316	50 005 734
PA937	50 005 134	P162	50 005 436	P317	50 005 738
PA939	50 005 061	P163	50 005 436	P318	50 005 737
PA940	50 005 900	P164	50 005 436	P320	50 005 224
PA941	50 005 766	P165	50 005 425	P321	50 005 792
PA943	50 005 081	P166	50 005 452	P323	50 005 760
PA944	50 005 197	P168	50 005 430	P324	50 005 793
PA946	50 005 180	P169	50 005 454	P326	50 005 755
PA949	50 005 093	P170	50 005 028	P327	50 005 747
PA950	50 005 097	P1720	50 005 176	P329	50 005 746
PA954	50 005 001	P175	50 005 029	P333	50 005 741
PA958	50 005 003	P176	50 005 439	P334	50 005 003
PA959	50 005 006	P177	50 005 446	P335	50 005 043
PA962	50 005 206	P177T	50 005 442	P337	50 005 055
PA963	50 005 198	P178	50 005 021	P338	50 005 736
PA973	50 005 122	P179	50 005 030	P339	50 005 042
PA974	50 005 774	P180	50 005 440	P341	50 005 746
PA977	50 005 027	P181	50 005 427	P343	50 005 749
PA982	50 005 007	P182	50 005 447	P346	50 005 900
		P183	50 005 441	P347	50 005 748
		P184	50 005 441	P356	50 005 794

CROSS REFERENCE



CROSS REFERENCE



Reference	Reference	Reference
HK AUTOTEILE	HK AUTOTEILE	HONDA
W10013 50 005 145	W49010 50 005 000	19200-P7A-003 50 005 086
W10014 50 005 550	W49011 50 005 002	19200-PDA-E01 50 005 081
W10015 50 005 166	W49014 50 005 004	19200-PDF-E01 50 005 087
W10021 50 005 153	W49015 50 005 009	19200-PH1-000 50 005 079
W10023 50 005 551	W49016 50 005 018	19200-PH1-020 50 005 079
W10025 50 005 162	W49017 50 005 516	19200-PH1-305 50 005 079
W10026 50 005 162	W50028 50 005 322	19200-PH1-505 50 005 079
W10028 50 005 132	W60005 50 005 102	19200 PLM A01 50 005 789
W10030 50 005 165	W60009 50 005 106	19200-PM3-003 50 005 084
W10037 50 005 750	W65001 50 005 221	19200-PM3-004 50 005 084
W10045 50 005 754	W67001 50 005 035	19200-PM3-013 50 005 084
W13021 50 005 753	W67002 50 005 021	19200-PNA-003 50 005 902
W30010 50 005 323	W67003 50 005 038	19200-PNL-E01 50 005 902
W30014 50 005 311	W67008 50 005 028	19200-POA-003 50 005 080
W30018 50 005 325	W67009 50 005 029	19200-POA-032 50 005 080
W30019T 50 005 302	W67010 50 005 428	19200-POB-A01 50 005 080
W30019T 50 005 326	W67012 50 005 447	19200-PT0-003 50 005 080
W30020 50 005 301	W67013 50 005 031	19200-PT0-013 50 005 080
W30023 50 005 318	W67014 50 005 427	19200-PWA-003 50 005 093
W30024T 50 005 316	W67015 50 005 439	19200-RBB-003 50 005 902
W30030 50 005 308	W67016 50 005 446	19200-RBB-013 50 005 902
W30039 50 005 317	W67017 50 005 449	
W30040 50 005 309	W67025 50 005 452	HYUNDAI
W30043 50 005 759	W67025 50 005 454	25100-02500 50 005 098
W30046 50 005 107	W67026 50 005 437	25100-02501 50 005 098
W30047 50 005 337	W67035 50 005 767	25100-02502 50 005 098
W40005 50 005 307	W78001S 50 005 063	25100-02555 50 005 098
W40007 50 005 310	W78007 50 005 720	25100-22010 50 005 095
W40010 50 005 319	W78010 50 005 314	25100-22012 50 005 095
W40013 50 005 320	W78011 50 005 304	25100-22650 50 005 095
W40014 50 005 313	W78013 50 005 530	25100-23001 50 005 903
W40023 50 005 758	W78014 50 005 067	25100-23002 50 005 903
W44003 50 005 042	W78015 50 005 727	25100-23010 50 005 903
W44004 50 005 051	W78017 50 005 068	25100-23020 50 005 903
W44006 50 005 746	W78018 50 005 725	25100-24030 50 005 095
W44007 50 005 053	W78022 50 005 062	25100-24040 50 005 095
W44008 50 005 045	W78023 50 005 064	25100-24060 50 005 095
W44009 50 005 224	W78024 50 005 065	25100-24060 50 005 097
W44012 50 005 049	W78032 50 005 752	25100-26901 50 005 097
W44013 50 005 055	W78042 50 005 762	25100-26902 50 005 097
W44015 50 005 043	W90017 50 005 306	25100-27000 50 005 096
W44016 50 005 736	W90062 50 005 324	25100-35010 50 005 128
W44017 50 005 735		25100-35020 50 005 128
W44018 50 005 740	HONDA	25100-35030 50 005 128
W44019 50 005 737	19200-P01-003 50 005 084	25100-35050 50 005 128
W44020 50 005 739	19200-P01-004 50 005 084	25100-36010 50 005 128
W44022 50 005 052	19200-P08-003 50 005 094	25100-42000 50 005 123
W44023 50 005 059	19200-P08-004 50 005 094	25100-42540 50 005 124
W44024 50 005 733	19200-P08-A01 50 005 094	25100-42541 50 005 124
W44026 50 005 732	19200-P10-A02 50 005 094	2511129000 50 005 313
W44027 50 005 741	19200-P13-000 50 005 091	
W44028 50 005 738	19200-P13-003 50 005 091	ISUZU
W44033 50 005 734	19200-P13-013 50 005 091	89414-3412 50 005 100
W44035 50 005 756	19200-P14-A00 50 005 090	89431-02510 50 005 100
W49001 50 005 512	19200-P1G-E02 50 005 086	89437-68410 50 005 100
W49002 50 005 510	19200-P1J-E02 50 005 084	89437-68440 50 005 100
W49003 50 005 511	19200-P2A-004 50 005 087	89441-94612 50 005 100
W49004 50 005 005	19200-P2A-A01 50 005 087	89446-11730 50 005 100
W49005 50 005 515	19200-P2A-A02 50 005 087	89701-85601 50 005 100
W49006 50 005 514	19200-P2A-A03 50 005 087	
W49007 50 005 513	19200-P5T-G00 50 005 082	IVECO
W49008 50 005 019	19200-P72-A01 50 005 092	4813370 50 005 624
W49009 50 005 020	19200 P75 003 50 005 788	4838676 50 005 606

CROSS REFERENCE





CROSS REFERENCE

CROSS REFERENCE

Reference 	Reference 	Reference 
IVECO		
93191101	50 005 620	980 035
98403019	50 005 623	980 036
98415831	50 005 604	980 038
98447660	50 005 609	980 042
98447661	50 005 610	980 043
98497115	50 005 605	980 045
99438900	50 005 621	980 048
99458098	50 005 608	980 049
99458099	50 005 607	980 051
JOHN DEERE		
AR79463	50 005 230	980 052
RE35685	50 005 229	980 053
JP GROUP		
115046001	50 005 813	980 055
115046002	50 005 822	980 059
115047001	50 005 808	980 062
115047002	50 005 805	980 063
115047003	50 005 803	980 064
115048001	50 005 800	980 065
115048002	50 005 806	980 067
115048003	50 005 866	980 068
115048004	50 005 867	980 102
115048008	50 005 807	980 106
115060001	50 005 868	980 107
115066001	50 005 844	980 108
115081001	50 005 801	980 108
115083001	50 005 845	980 109
115088001	50 005 811	980 132
115098002	50 005 809	980 133
115098003	50 005 804	980 134
115098005	50 005 802	980 135
115100006	50 005 819	980 137
115200002	50 005 812	980 139
880646030	50 005 823	980 140
880646041	50 005 818	980 142
880646042	50 005 850	980 145
ES1559	50 005 839	980 146
ES1560	50 005 821	980 148
KIA		
251004A000	50 005 790	980 149
M251004A000	50 005 790	980 150
OFE3N-15-010E	50 005 110	980 151
OK937-15-010	50 005 121	980 153
KRULL		
980 000	50 005 000	980 154
980 002	50 005 002	980 155
980 004	50 005 004	980 156
980 005	50 005 005	980 158
980 009	50 005 009	980 159
980 018	50 005 018	980 160
980 019	50 005 019	980 161
980 020	50 005 020	980 162
980 021	50 005 021	980 162
980 028	50 005 028	980 163
980 029	50 005 029	980 165
980 030	50 005 030	980 166
980 031	50 005 031	980 167
980 032	50 005 032	980 168
980 033	50 005 033	980 181
980 034	50 005 034	980 189
		980 207
		980 210
		980 211
		980 221
		980 301
		980 302
		980 424
		980 425
		980 426
		980 427
		980 428
		980 430
		980 431
		980 432
		980 433
		980 434
		980 435
		980 436
		980 437
		980 438
		980 439
		980 440
		980 441
		980 442
		980 446
		980 447
		980 449
		980 450
		980 451
		980 452
		980 454
		980 460
		980 470
		980 471
		980 480
		980 490
		980 510
		980 511
		980 512
		980 513
		980 514
		980 515
		980 516
		980 517
		980 519
		980 530
		980 550
		980 551
		980 552
		980 553
		980 720
		980 721
		980 725
		980 727
		980 732
		980 733
		980 734
		980 735
		980 736
		980 737
		980 738
		980 739
		980 740
		980 741
		980 743
		980 744
		980 746
		980 747
		980 750
		980 751
		980 905





CROSS REFERENCE

Reference 	Reference 	Reference 
KRULL	KWP	KWP
980 932 50 005 932	10377 50 005 029	10628 50 005 310
983 623 50 005 339	10379 50 005 000	10640 50 005 725
986 071 50 005 341	10380 50 005 004	10656 50 005 132
986 849 50 005 340	10383 50 005 149	10658 50 005 159
KWP	10390 50 005 005	10661 50 005 434
10044 50 005 043	10391 50 005 313	10662 50 005 552
10046 50 005 042	10393 50 005 320	10664 50 005 746
10053 50 005 002	10401 50 005 068	10674 50 005 154
10102 50 005 146	10403 50 005 725	10675 50 005 168
10103 50 005 145	10406 50 005 428	10676 50 005 137
10105 50 005 035	10409 50 005 737	10677 50 005 164
10105 50 005 932	10410 50 005 739	10678 50 005 470
10106 50 005 021	10412 50 005 308	10679 50 005 155
10108 50 005 051	10414A 50 005 447	10706 50 005 490
10114 50 005 102	10415 50 005 741	10707 50 005 455
10115 50 005 020	10422 50 005 553	10708 50 005 474
10117 50 005 063	10424 50 005 163	10709 50 005 475
10119 50 005 038	10425 50 005 153	10710 50 005 457
10121 50 005 053	10430 50 005 515	10711 50 005 456
10133 50 005 033	10431 50 005 514	10735 50 005 440
10134 50 005 032	10432 50 005 513	10736 50 005 471
10135 50 005 034	10441 50 005 052	10757 50 005 181
10142 50 005 311	10442 50 005 059	10779 50 005 156
10146 50 005 140	10443 50 005 733	Krull
10148 50 005 142	10446 50 005 031	980250 50 005 008
10149 50 005 019	10447 50 005 427	980263 50 005 061
10150 50 005 045	10448 50 005 439	980270 50 005 001
10153 50 005 064	10449 50 005 446	980407 50 005 010
10174 50 005 062	10450 50 005 449	980709 50 005 216
10178 50 005 321	10495 50 005 425	980710 50 005 120
10232 50 005 065	10502 50 005 516	980719 50 005 119
10235 50 005 049	10527 50 005 323	980731 50 005 215
10236 50 005 055	10531 50 005 301	980764 50 005 074
10240 50 005 306	10532 50 005 309	980767 50 005 003
10243 50 005 018	10536 50 005 317	980768 50 005 006
10247 50 005 325	10541 50 005 738	980771 50 005 013
10254 50 005 301	10542 50 005 322	980811 50 005 044
10256 50 005 307	10543 50 005 316	980812 50 005 011
10264 50 005 009	10546 50 005 150	981020 50 005 176
10270 50 005 512	10550 50 005 302	981040 50 005 090
10272 50 005 028	10558 50 005 107	981049 50 005 082
10278 50 005 720	10567 50 005 030	981089 50 005 056
10279 50 005 148	10570 50 005 517	981705 50 005 192
10284 50 005 221	10571 50 005 741	981706 50 005 187
10286A 50 005 303	10572 50 005 734	981708 50 005 116
10297 50 005 314	10577 50 005 732	981715 50 005 111
10301 50 005 318	10578 50 005 430	981723 50 005 194
10303 50 005 304	10579 50 005 151	981726 50 005 182
10312 50 005 106	10580 50 005 436	981734 50 005 174
10319 50 005 160	10582 50 005 433	981735 50 005 169
10320 50 005 162	10583 50 005 036	981741 50 005 136
10321 50 005 530	10584 50 005 435	981743 50 005 172
10322 50 005 067	10591 50 005 550	981745 50 005 135
10323 50 005 727	10592 50 005 166	981754 50 005 173
10324 50 005 736	10593 50 005 551	981767 50 005 197
10325 50 005 735	10595 50 005 326	981772 50 005 196
10326 50 005 740	10603 50 005 139	981774 50 005 077
10344 50 005 162	10608 50 005 452	981776 50 005 078
10348 50 005 319	10609 50 005 158	981779 50 005 080
10363 50 005 324	10610 50 005 437	981780 50 005 079
10369 50 005 510	10613 50 005 454	981782 50 005 086
10370 50 005 511	10617 50 005 165	981783 50 005 087
	10618A 50 005 167	

CROSS REFERENCE



CROSS REFERENCE



Reference 	Reference 	Reference 
MAZDA	MERCEDES-BENZ	MERCEDES-BENZ
ZJ01-15-010A 50 005 206	111 200 21 01 50 005 474	353 200 56 01 50 005 618
ZJ01-15-010B 50 005 206	111 200 22 01 50 005 164	355 180 01 01 50 005 829
MERCEDES-BENZ	111 200 23 01 50 005 491	355 200 01 01 50 005 211
000 200 03 01 50 005 165	111 200 24 01 50 005 475	355 200 05 01 50 005 211
102 200 01 20 50 005 029	111 200 38 01 50 005 474	355 200 06 01 50 005 211
102 200 03 01 50 005 028	111 200 39 01 50 005 475	355 200 08 01 50 005 211
102 200 03 20 50 005 028	111 200 40 01 50 005 433	355 200 09 01 50 005 211
102 200 04 01 50 005 028	111 200 42 01 50 005 908	355 200 11 01 50 005 211
102 200 04 20 50 005 028	111 200 43 01 50 005 773	355 200 15 01 50 005 211
102 200 05 20 50 005 425	112 200 02 01 50 005 457	360 180 06 01 50 005 830
102 200 06 20 50 005 425	112 200 04 01 50 005 457	360 180 07 01 50 005 830
102 200 08 01 50 005 029	112 200 05 01 50 005 456	360 180 15 01 50 005 830
102 200 09 01 50 005 029	112 200 10 01 50 005 456	360 180 18 01 50 005 830
102 200 09 20 50 005 425	112 200 11 01 50 005 457	360 180 20 01 50 005 830
102 200 11 01 50 005 028	112 200 12 01 50 005 456	360 180 24 01 50 005 830
102 200 39 01 50 005 425	112 200 14 01 50 005 457	360 180 26 01 50 005 830
102 200 42 01 50 005 029	112 200 15 01 50 005 456	360 200 03 01 50 005 203
102 200 43 01 50 005 028	115 200 00 20 50 005 035	360 200 09 01 50 005 203
102 200 49 01 50 005 425	115 200 01 20 50 005 033	360 200 37 01 50 005 203
102 200 50 01 50 005 425	115 200 12 20 50 005 033	360 200 45 01 50 005 203
103 200 04 01 50 005 440	115 200 15 20 50 005 035	364 180 01 01 50 005 843
103 200 05 01 50 005 441	115 200 16 20 50 005 033	364 200 01 01 50 005 633
103 200 06 01 50 005 447	115 200 18 20 50 005 035	364 200 09 01 50 005 633
103 200 07 01 50 005 442	116 200 11 01 50 005 427	364 200 20 01 50 005 633
103 200 17 01 50 005 442	116 200 12 01 50 005 427	366 180 01 01 50 005 836
103 200 18 01 50 005 441	116 200 13 01 50 005 427	366 180 04 01 50 005 836
103 200 19 01 50 005 447	116 200 14 01 50 005 427	366 200 09 01 50 005 629
103 200 20 01 50 005 446	116 200 16 01 50 005 427	366 200 59 01 50 005 629
103 200 21 01 50 005 447	116 200 17 01 50 005 427	401 180 00 01 50 005 837
103 200 26 01 50 005 446	117 200 00 01 50 005 021	401 180 01 01 50 005 837
103 200 27 01 50 005 447	117 200 02 01 50 005 021	403 180 06 01 50 005 837
103 200 37 01 50 005 446	117 200 03 01 50 005 021	403 180 17 01 50 005 837
103 200 38 01 50 005 447	117 200 08 01 50 005 021	403 180 27 01 50 005 827
104 200 03 01 50 005 449	117 200 10 01 50 005 030	403 180 28 01 50 005 828
104 200 08 01 50 005 452	117 200 17 01 50 005 030	403 180 33 01 50 005 834
104 200 13 01 50 005 435	117 200 28 01 50 005 021	403 200 27 01 50 005 207
104 200 27 01 50 005 437	117 200 29 01 50 005 030	403 200 32 01 50 005 207
104 200 28 01 50 005 434	117 200 33 01 50 005 030	403 200 34 01 50 005 207
104 200 29 01 50 005 449	117 200 38 01 50 005 021	403 200 35 01 50 005 207
104 200 30 01 50 005 435	119 200 04 01 50 005 430	403 200 44 01 50 005 210
104 200 31 01 50 005 452	119 200 09 01 50 005 430	403 200 49 01 50 005 207
104 200 32 01 50 005 437	119 200 15 01 50 005 430	403 200 51 01 50 005 210
104 200 33 01 50 005 436	119 200 21 01 50 005 454	403 200 53 01 50 005 632
104 200 44 01 50 005 436	121 200 06 20 50 005 033	403 200 70 01 50 005 207
104 200 45 01 50 005 434	121 200 08 20 50 005 034	403 200 71 01 50 005 210
104 200 46 01 50 005 435	121 200 09 20 50 005 035	403 200 73 01 50 005 632
104 200 47 01 50 005 436	121 200 11 20 50 005 033	403 200 76 01 50 005 615
104 200 48 01 50 005 437	127 200 01 20 50 005 033	403 200 77 01 50 005 615
104 200 49 01 50 005 434	127 200 02 20 50 005 033	422 200 05 01 50 005 205
110 200 00 20 50 005 034	166 200 03 20 50 005 470	422 200 10 01 50 005 205
110 200 01 20 50 005 032	166 200 04 20 50 005 470	422 200 11 01 50 005 625
110 200 01 20 50 005 035	166 200 05 20 50 005 470	422 200 12 01 50 005 626
110 200 02 20 50 005 034	166 200 06 20 50 005 471	423 180 01 01 50 005 834
110 200 04 20 50 005 038	166 200 07 20 50 005 471	423 180 05 01 50 005 834
110 200 08 20 50 005 034	314 180 05 01 50 005 835	441 200 01 01 50 005 616
110 200 09 20 50 005 035	314 180 10 01 50 005 835	441 200 02 01 50 005 616
110 200 10 20 50 005 034	314 180 10 01 50 005 843	541 180 00 01 50 005 831
110 200 11 20 50 005 038	352 180 24 01 50 005 843	541 180 01 01 50 005 831
110 200 17 20 50 005 035	352 180 63 01 50 005 835	541 180 02 01 50 005 831
110 200 19 20 50 005 038	352 180 63 01 50 005 843	541 180 03 01 50 005 831
110 200 20 20 50 005 034	352 180 70 01 50 005 843	541 200 01 01 50 005 628
111 200 04 01 50 005 433	353 200 36 01 50 005 617	541 200 11 01 50 005 628
	353 200 37 01 50 005 617	541 200 12 01 50 005 628

CROSS REFERENCE



CROSS REFERENCE

CROSS REFERENCE

Reference 	Reference 	Reference 	
MERCEDES-BENZ			
542 180 00 01	50 005 838	MD997170	50 005 123
542 180 01 01	50 005 838	MD997244	50 005 128
542 180 02 01	50 005 838	MD997609	50 005 095
542 180 07 01	50 005 838	MD997618	50 005 123
542 200 05 01	50 005 619	MD997686	50 005 124
542 200 15 01	50 005 619	ME200411	50 005 127
542 200 19 01	50 005 619	ME993473	50 005 127
601 200 02 20	50 005 031	ME996789	50 005 127
601 200 07 20	50 005 031	MW30620725	50 005 756
601 200 09 20	50 005 031	MOTORCRAFT (FORD)	
601 200 11 20	50 005 036	EFA541	50 005 136
602 200 00 20	50 005 439	NISSAN	
602 200 01 20	50 005 439	21010-00QAC	50 005 756
602 200 02 20	50 005 439	21010-00QAS	50 005 171
605 200 01 20	50 005 490	21010-00QAT	50 005 171
605 200 03 20	50 005 490	21010-0F001	50 005 175
605 200 05 20	50 005 490	21010-0F002	50 005 175
605 200 08 20	50 005 490	21010-0F003	50 005 175
611 200 02 01	50 005 455	21010-0M300	50 005 172
611 200 04 01	50 005 776	21010-0M301	50 005 172
611 200 05 01	50 005 782	21010-22J00	50 005 135
611 200 10 01	50 005 776	21010-22J25	50 005 135
611 200 11 01	50 005 782	21010-22J26	50 005 135
611 200 12 01	50 005 455	21010-28J25	50 005 135
613 200 07 01	50 005 767	21010-28J26	50 005 135
616 200 04 20	50 005 428	21010-28J26	50 005 135
616 200 07 20	50 005 428	21010-35V26	50 005 173
646 200 03 01	50 005 909	21010-41B00	50 005 791
647 200 01 01	50 005 010	21010-41B03	50 005 791
904 200 04 01	50 005 627	21010-43G02	50 005 173
904 200 06 01	50 005 627	21010-43G25	50 005 173
904 200 08 01	50 005 627	21010-43G26	50 005 173
904 200 20 01	50 005 627	21010-43G27	50 005 173
904 200 22 01	50 005 627	21010-43G28	50 005 173
904 200 26 01	50 005 627	21010-43G29	50 005 173
904 200 49 01	50 005 627	21010-43G86	50 005 173
904 201 02 01	50 005 627	21010-4M525	50 005 141
904 201 07 01	50 005 627	21010-4M526	50 005 141
METELLI		21010-53J00	50 005 136
PA938	50 005 762	21010-53J01	50 005 136
MEYLE		21010-53J03	50 005 136
0130200001	50 005 776	21010-53J04	50 005 136
0130260015	50 005 773	21010-53Y00	50 005 172
0330200030	50 005 633	21010-53Y01	50 005 172
0340180022	50 005 831	21010-57J01	50 005 169
0340180023	50 005 838	21010-57J02	50 005 169
0340181003	50 005 835	21010-57J03	50 005 169
0340181004	50 005 829	21010-57J25	50 005 169
0340181006	50 005 843	21010-57J26	50 005 169
0340181007	50 005 836	21010-6F900	50 005 339
0340181008	50 005 837	21010-6F906	50 005 339
11130100156	50 005 815	21010-6F907	50 005 339
1130110001	50 005 806	21010-70J00	50 005 136
1130110002	50 005 804	21010-71J00	50 005 172
1130110003	50 005 802	21010-7F400	50 005 175
1130110004	50 005 809	21010-80G25	50 005 175
1130110005	50 005 866	21010-80G26	50 005 175
1130110006	50 005 822	21010-80G27	50 005 175
1130110008	50 005 813	21010-80G28	50 005 175
1130110009	50 005 805	21010-80G85	50 005 175
1130110013	50 005 868	21010-99B00	50 005 791
		21010-9F501	50 005 136
MEYLE			
1130110015	50 005 810		
1130110016	50 005 801		
1130110017	50 005 800		
1130110018	50 005 803		
1130110019	50 005 808		
1130110021	50 005 807		
1130110023	50 005 812		
1130110033	50 005 867		
1130110034	50 005 811		
1130110035	50 005 819		
1130110036	50 005 844		
1130120034	50 005 769		
1130120047	50 005 777		
1130120052	50 005 775		
1130120053	50 005 771		
1130120054	50 005 783		
113 012 0058	50 005 061		
1130380003	50 005 845		
1132200001	50 005 781		
16-13 027 0001	50 005 170		
16-13 086 4596	50 005 934		
3130114300	50 005 778		
5132000001	50 005 797		
5132200002	50 005 779		
613 220 0001	50 005 056		
613 220 0003	50 005 003		
6136000001	50 005 793		
6136000004	50 005 792		
6136000005	50 005 900		
6136006029	50 005 817		
6136006030	50 005 823		
6136006041	50 005 818		
6136006042	50 005 850		
MITSUBISHI			
M 345 611	50 005 301		
M 855 991	50 005 301		
MD030863	50 005 095		
MD168048	50 005 123		
MD168050	50 005 123		
MD301847	50 005 123		
MD302010	50 005 129		
MD309756	50 005 125		
MD313301	50 005 134		
MD323372	50 005 133		
MD346790	50 005 125		
MD365087	50 005 133		
MD664616	50 005 123		
MD971539	50 005 126		
MD972001	50 005 123		
MD972002	50 005 124		
MD972003	50 005 128		
MD972004	50 005 128		
MD972006	50 005 126		
MD972054	50 005 126		
MD974649	50 005 095		
MD974999	50 005 124		
MD980000	50 005 128		
MD997076	50 005 095		
MD997084	50 005 123		
MD997150	50 005 123		
MD997151	50 005 123		
MD997160	50 005 123		





CROSS REFERENCE

CROSS REFERENCE

Reference		Reference		Reference	
OPEL		PEUGEOT		POBJEDA	
90511958	50 005 851	1001 29	50 005 852	1 00 50 500 2	50 005 617
90512535	50 005 516	1001 30	50 005 863	1 00 53 000 1	50 005 627
90540478	50 005 748	1001 32	50 005 814	1 00 55 207 1	50 005 625
90541505	50 005 818	1001 37	50 005 814	1 00 55 208 1	50 005 626
90541506	50 005 850	1001 40	50 005 863	1 00 55 210 1	50 005 616
90541510	50 005 851	1001 50	50 005 820	1 00 55 221 1	50 005 615
90541671	50 005 516	1001 56	50 005 815	1 00 55 502 1	50 005 612
90542273	50 005 848	1001 68	50 005 825	1 00 55 503 1	50 005 614
90543277	50 005 224	1001 69	50 005 853	1 00 55 504 1	50 005 613
90543935	50 005 747	1001 77	50 005 854	1 00 56 000 1	50 005 628
9109595	50 005 794	1001 84	50 005 860	1 00 56 300 1	50 005 619
9118202	50 005 848	1001 91	50 005 826	1 00 68 000 1	50 005 624
9192793	50 005 059	1001 92	50 005 824	1 00 68 000 6	50 005 620
9192797	50 005 738	1201 35	50 005 314	1 00 68 100 1	50 005 623
91 94 747	50 005 792	1201 36	50 005 306	1 00 68 100 2	50 005 605
9199592	50 005 793	1201 39	50 005 307	1 00 68 200 0	50 005 604
9199595	50 005 900	1201 42	50 005 304	1 00 68 300 0	50 005 606
9201450	50 005 794	1201 48	50 005 320	1 00 68 400 1	50 005 621
92 92 375	50 005 045	1201 50	50 005 319	1 00 68 600 1	50 005 607
93177340	50 005 760	1201 51	50 005 320	1 00 68 600 5	50 005 610
93178602	50 005 792	1201 52	50 005 313	1 00 68 600 6	50 005 608
93182028	50 005 755	1201 54	50 005 322	1 02 68 603 2	50 005 609
93182038	50 005 793	1201 55	50 005 322	1 20 15 100 1	50 005 832
93182042	50 005 900	1201 58	50 005 339	1 20 18 000 0	50 005 841
94124093	50 005 739	1201 60	50 005 320	1 20 25 000 0	50 005 369
94341998	50 005 741	1201 61	50 005 319	1 20 33 700 0	50 005 840
94386207	50 005 741	1201 62	50 005 320	1 20 44 101 0	50 005 871
97101319	50 005 741	1201 63	50 005 307	1 20 46 000 0	50 005 872
97101320	50 005 741	1201 65	50 005 313	1 20 47 200 2	50 005 873
97110387	50 005 741	1201 67	50 005 313	1 20 47 300 2	50 005 874
97113499	50 005 749	1201 70	50 005 330	1 20 50 100 0	50 005 835
97114682	50 005 746	1201 74	50 005 314	1 20 50 201 2	50 005 843
97135548	50 005 749	1201 76	50 005 304	1 20 50 501 1	50 005 836
97251178	50 005 755	1201 91	50 005 313	1 20 52 000 0	50 005 829
97287175	50 005 755	1201 A3	50 005 330	1 20 55 100 1	50 005 870
OPTIMAL		1201 A4	50 005 313	1 20 55 200 0	50 005 837
OPU-002	50 005 802	1201 A5	50 005 331	1 20 55 200 1	50 005 833
PBR		1201 A7	50 005 322	1 20 55 300 0	50 005 827
AI5084	50 005 136	1201 A8	50 005 333	1 20 55 303 0	50 005 828
PERKINS		1201 C4	50 005 329	1 20 55 400 0	50 005 834
3641263M91	50 005 252	1201 C6	50 005 322	1 20 56 000 0	50 005 831
41312487	50 005 249	1201 E1	50 005 761	1 20 56 100 0	50 005 838
41312892	50 005 247	1201 E3	50 005 310	1 20 58 000 0	50 005 830
41313237	50 005 246	1201 E4	50 005 339	PUROLATOR	
41314054	50 005 840	1201 E6	50 005 339	A17956	50 005 136
41314067	50 005 232	1201 E7	50 005 765	AF4956	50 005 136
41314131	50 005 231	1201 F4	50 005 761	QUINTON HAZEL	
41314164	50 005 233	1201 F5	50 005 765	QCP1292	50 005 323
41314182	50 005 235	1201 F9	50 005 758	QCP1294	50 005 146
41314187	50 005 234	1201 G1	50 005 762	QCP1350	50 005 059
4131A013	50 005 245	1201 G2	50 005 766	QCP1350	50 005 072
4132F012	50 005 237	1201 G4	50 005 761	QCP1375	50 005 512
4132F015	50 005 240	1201 G5	50 005 765	QCP1435	50 005 439
4132F016	50 005 239	1201 G8	50 005 758	QCP1445	50 005 318
4132F021	50 005 236	1201 G9	50 005 762	QCP1531	50 005 173
U5MW0023	50 005 248	1207 18	50 005 310	QCP1535	50 005 174
U5MW0061	50 005 250	1207 23	50 005 310	QCP1550	50 005 038
U5MW0089	50 005 251	1207 25	50 005 339	QCP1559	50 005 020
		1336 L5	50 005 322	QCP2062	50 005 051
		POBJEDA		QCP2100	50 005 043
		1 00 18 000 0	50 005 602	QCP2101	50 005 062
		1 00 50 400 4	50 005 618		



CROSS REFERENCE



Reference 	Reference 	Reference 			
QUINTON HAZEL	QUINTON HAZEL	QUINTON HAZEL			
QCP2135	50 005 196	QCP2815	50 005 121	QCP3173	50 005 437
QCP2189	50 005 049	QCP2817	50 005 449	QCP3175	50 005 080
QCP2194	50 005 055	QCP2819	50 005 428	QCP3177	50 005 169
QCP2226	50 005 145	QCP2864	50 005 427	QCP3180	50 005 176
QCP2304	50 005 065	QCP2873	50 005 322	QCP3186	50 005 341
QCP2338	50 005 306	QCP2881	50 005 136	QCP3189	50 005 193
QCP2350	50 005 028	QCP2882	50 005 172	QCP3192	50 005 078
QCP2354	50 005 029	QCP2884	50 005 320	QCP3212	50 005 155
QCP2358	50 005 009	QCP2891	50 005 319	QCP3212BH	50 005 156
QCP2376	50 005 021	QCP2901	50 005 553	QCP3213	50 005 167
QCP2413	50 005 110	QCP2911	50 005 425	QCP3216	50 005 519
QCP2433	50 005 095	QCP2915	50 005 175	QCP3222	50 005 454
QCP2450	50 005 031	QCP2918	50 005 135	QCP3224	50 005 119
QCP2453	50 005 148	QCP2922	50 005 138	QCP3225	50 005 452
QCP2453BH	50 005 151	QCP2923	50 005 153	QCP3226	50 005 337
QCP2456	50 005 314	QCP2925	50 005 163	QCP3227	50 005 340
QCP2471	50 005 052	QCP2926	50 005 932	QCP3230	50 005 091
QCP2472	50 005 221	QCP2928	50 005 106	QCP3231	50 005 087
QCP2474	50 005 325	QCP2941	50 005 307	QCP3234	50 005 094
QCP2477	50 005 004	QCP2944	50 005 313	QCP3243	50 005 725
QCP2478	50 005 000	QCP2947	50 005 079	QCP3250	50 005 126
QCP2492	50 005 310	QCP2949	50 005 116	QCP3255	50 005 224
QCP2495	50 005 067	QCP2950	50 005 178	QCP3257	50 005 090
QCP2496	50 005 304	QCP2962	50 005 225	QCP3260	50 005 117
QCP2499	50 005 316	QCP2978	50 005 187	QCP3262	50 005 197
QCP2500	50 005 321	QCP2981	50 005 192	QCP3263	50 005 182
QCP2507	50 005 018	QCP2989	50 005 425	QCP3272	50 005 124
QCP2512	50 005 735	QCP2997	50 005 302	QCP3277	50 005 115
QCP2513	50 005 733	QCP2997BH	50 005 326	QCP3278	50 005 118
QCP2517	50 005 736	QCP3036	50 005 179	QCP3280	50 005 129
QCP2525	50 005 063	QCP3046	50 005 186	QCP3296	50 005 134
QCP2525	50 005 721	QCP3058	50 005 732	QCP3297	50 005 132
QCP2527	50 005 530	QCP3059	50 005 734	QCP3299	50 005 335
QCP2545	50 005 720	QCP3060	50 005 084	QCP3301	50 005 223
QCP2550	50 005 111	QCP3067	50 005 515	QCP3304	50 005 154
QCP2563	50 005 442	QCP3079	50 005 791	QCP3313	50 005 120
QCP2563	50 005 446	QCP3084	50 005 738	QCP3326	50 005 769
QCP2565	50 005 727	QCP3090	50 005 107	QCP3336	50 005 903
QCP2567	50 005 160	QCP3091	50 005 551	QCP3338	50 005 128
QCP2597	50 005 194	QCP3093	50 005 550	QCP3345	50 005 076
QCP2645	50 005 149	QCP3095	50 005 166	QCP3346	50 005 073
QCP2646	50 005 510	QCP3096	50 005 516	QCP3365	50 005 137
QCP2647	50 005 511	QCP3098	50 005 077	QCP3366	50 005 332
QCP2650	50 005 324	QCP3103	50 005 430	QCP3367	50 005 334
QCP2652	50 005 068	QCP3104	50 005 436	QCP3376	50 005 331
QCP2660	50 005 308	QCP3105	50 005 433	QCP3380	50 005 470
QCP2661	50 005 301	QCP3107	50 005 552	QCP3381	50 005 457
QCP2665	50 005 162	QCP3109	50 005 517	QCP3382	50 005 455
QCP2667	50 005 441	QCP3124	50 005 317	QCP3383	50 005 490
QCP2667	50 005 447	QCP3134	50 005 551	QCP3384	50 005 474
QCP2668	50 005 030	QCP3135	50 005 741	QCP3385	50 005 475
QCP2671	50 005 005	QCP3136	50 005 301	QCP3386	50 005 747
QCP2673	50 005 725	QCP3137	50 005 309	QCP3389	50 005 170
QCP2674	50 005 162	QCP3140	50 005 759	QCP3390	50 005 336
QCP2682BH	50 005 324	QCP3141	50 005 303	QCP3391	50 005 329
QCP2686	50 005 739	QCP3155	50 005 165	QCP3395	50 005 772
QCP2689	50 005 740	QCP3156	50 005 158	QCP3397	50 005 491
QCP2704	50 005 123	QCP3157	50 005 139	QCP3402	50 005 454
QCP2735	50 005 513	QCP3163	50 005 330	QCP3409	50 005 774
QCP2746	50 005 741	QCP3165	50 005 339	QCP3410	50 005 216
QCP2800	50 005 737	QCP3168	50 005 746	QCP3421	50 005 333
QCP2802	50 005 515	QCP3170	50 005 036	QCP3425	50 005 125
QCP2804	50 005 514	QCP3172	50 005 435	QCP3429BH	50 005 184

CROSS REFERENCE





CROSS REFERENCE

CROSS REFERENCE

Reference 	Reference 	Reference 	
QUINTON HAZEL			
QCP3431 50 005 188	QCP561 50 005 002	77 01 467 622 50 005 337	
QCP3435 50 005 057	QCP952 50 005 140	77 01 468 342 50 005 321	
QCP3437 50 005 189	QCP952BH 50 005 150	77 01 468 491 50 005 301	
QCP3452 50 005 183	QCP957 50 005 311	77 01 468 492 50 005 301	
QCP3458 50 005 554	QCP969 50 005 102	77 01 472 182 50 005 756	
QCP3458 50 005 783	QCP970 50 005 053	77 01 472 625 50 005 794	
QCP3459 50 005 339	QCP973 50 005 045	77 01 473 327 50 005 171	
QCP3461 50 005 788	QCP985 50 005 064	77 01 473 365 50 005 301	
QCP3472 50 005 133	QCP986 50 005 142	77 01 474 190 50 005 794	
QCP3477 50 005 777	QCP990 50 005 019	77 01 474 435 50 005 795	
QCP3478 50 005 754	QCP994 50 005 034	77 01 475 995 50 005 027	
QCP3479 50 005 905	QCP995 50 005 032	77 01 476 496 50 005 171	
QCP3480 50 005 797	QCP995 50 005 035	77 01 478 031 50 005 027	
QCP3482 50 005 750	RENAULT		
QCP3484 50 005 040	50 01 001 274 50 005 321	77 01 505 397 50 005 311	
QCP3488 50 005 097	74 38 610 006 50 005 107	77 01 508 491 50 005 864	
QCP3492 50 005 761	77 00 105 176 50 005 170	77 01 585 084 50 005 857	
QCP3494 50 005 779	77 00 105 378 50 005 170	77 01 588 187 50 005 856	
QCP3495 50 005 551	77 00 106 101 50 005 336	77 01 590 269 50 005 865	
QCP3495 50 005 555	77 00 107 845 50 005 336	77 01 611 364 50 005 865	
QCP3505 50 005 786	77 00 111 675 50 005 756	77 01 633 125 50 005 308	
QCP3507 50 005 756	77 00 111 841 50 005 336	77 01 643 206 50 005 253	
QCP3508 50 005 171	77 00 274 330 50 005 170	77 01 643 206 50 005 847	
QCP3510 50 005 755	77 00 736 091 50 005 308	77 01 669 290 50 005 858	
QCP3512 50 005 044	77 00 859 570 50 005 865	77 01 669 300 50 005 859	
QCP3515 50 005 778	77 00 859 931 50 005 337	77 01 669 305 50 005 253	
QCP3516 50 005 793	77 00 861 627 50 005 336	77 01 693 574 50 005 253	
QCP3517 50 005 900	77 00 861 686 50 005 340	77 01 693 575 50 005 859	
QCP3520 50 005 794	77 00 864 218 50 005 865	77 01 693 576 50 005 846	
QCP3521 50 005 758	77 00 864 220 50 005 865	77 01 693 577 50 005 858	
QCP3522 50 005 795	77 00 864 596 50 005 335	77 01 693 578 50 005 253	
QCP3525 50 005 908	77 00 866 518 50 005 040	77 01 693 588 50 005 861	
QCP3526 50 005 773	77 00 871 801 50 005 337	77 01 693 588 50 005 862	
QCP3527 50 005 799	77 01 457 671 50 005 311	77 02 118 708 50 005 312	
QCP3529 50 005 789	77 01 458 594 50 005 855	77 02 120 972 50 005 312	
QCP3531 50 005 902	77 01 461 336 50 005 323	79 46 004 571 50 005 857	
QCP3542 50 005 752	77 01 461 405 50 005 325	82 00 037 686 50 005 335	
QCP3544 50 005 757	77 01 462 145 50 005 302	82 00 042 514 50 005 336	
QCP3544 50 005 766	77 01 462 145 50 005 326	82 00 088 660 50 005 335	
QCP3547 50 005 771	77 01 462 491 50 005 302	82 00 088 663 50 005 335	
QCP3549 50 005 013	77 01 462 491 50 005 326	82 00 101 970 50 005 849	
QCP3550 50 005 760	77 01 462 808 50 005 321	82 00 129 206 50 005 794	
QCP3551 50 005 762	77 01 462 809 50 005 301	82 00 146 297 50 005 170	
QCP3555 50 005 753	77 01 463 111 50 005 301	82 00 146 301 50 005 040	
QCP3556 50 005 764	77 01 463 182 50 005 325	82 00 194 608 50 005 858	
QCP3557 50 005 096	77 01 463 377 50 005 302	82 00 194 613 50 005 861	
QCP3558 50 005 141	77 01 463 377 50 005 326	82 00 194 613 50 005 862	
QCP3563 50 005 909	77 01 463 397 50 005 301	82 00 199 281 50 005 254	
QCP3565 50 005 798	77 01 463 637 50 005 318	82 00 222 704 50 005 858	
QCP3566 50 005 056	77 01 464 030 50 005 316	82 00 227 686 50 005 849	
QCP3570 50 005 011	77 01 464 736 50 005 301	82 00 243 153 50 005 861	
QCP3571 50 005 767	77 01 465 119 50 005 857	82 00 243 154 50 005 254	
QCP3575 50 005 180	77 01 465 513 50 005 341	82 00 266 947 50 005 934	
QCP3576 50 005 008	77 01 465 761 50 005 857	82 00 279 948 50 005 858	
QCP3590 50 005 003	77 01 465 816 50 005 301	82 00 279 953 50 005 254	
QCP3595 50 005 093	77 01 466 419 50 005 302	82 00 279 956 50 005 861	
QCP3601 50 005 061	77 01 466 419 50 005 326	82 00 428 447 50 005 170	
QCP3605 50 005 006	77 01 466 571 50 005 317	82 00 582 675 50 005 170	
QCP3607 50 005 001	77 01 466 578 50 005 301	82 00 741 635 50 005 254	
QCP3617 50 005 782	77 01 466 788 50 005 309	89 82 775 051 50 005 302	
QCP4163 50 005 330	77 01 467 153 50 005 759	ROVER	
QCP541 50 005 042	77 01 467 223 50 005 316	ERR 3290 50 005 901	
QCP560 50 005 033		GWP193 50 005 082	





CROSS REFERENCE

Reference 	Reference 	Reference 
ROVER	RUVILLE	RUVILLE
GWP 195 50 005 310	65147 50 005 435	65402 50 005 160
GWP2157 50 005 084	65149 50 005 036	65404 50 005 162
GWP2161 50 005 084	65155 50 005 428	65405 50 005 138
GWP2163 50 005 084	65160 50 005 029	65406 50 005 162
GWP 337 50 005 320	65175 50 005 038	65407 50 005 163
GWP 338 50 005 320	65177 50 005 425	65409 50 005 554
GWP 341 50 005 310	65188 50 005 433	65410 50 005 140
GWP343 50 005 090	65191 50 005 446	65410G 50 005 150
GWP 346 50 005 339	65192 50 005 447	65413 50 005 132
GWP347 50 005 082	65201 50 005 063	65414 50 005 781
PEB102420 50 005 082	65206 50 005 062	65415 50 005 149
PEB 500090 50 005 901	65208 50 005 215	65416 50 005 775
SCT 1086 50 005 901	65209 50 005 216	65418 50 005 061
	65211 50 005 721	65419 50 005 008
	65212 50 005 118	65420 50 005 142
	65213 50 005 752	65421 50 005 770
RUVILLE	65215 50 005 013	65423 50 005 001
65001 50 005 019	65216 50 005 787	65430 50 005 148
65002 50 005 786	65240 50 005 530	65430G 50 005 151
65004 50 005 785	65242 50 005 068	65431 50 005 154
65005 50 005 020	65244 50 005 720	65432 50 005 783
65006 50 005 044	65250 50 005 064	65440 50 005 145
65008 50 005 018	65254 50 005 067	65441 50 005 769
65010 50 005 009	65255 50 005 065	65442 50 005 137
65011 50 005 510	65256 50 005 117	65443 50 005 132
65012 50 005 005	65260 50 005 725	65450 50 005 146
65015 50 005 000	65293 50 005 727	65452 50 005 550
65018 50 005 515	65298 50 005 119	65453 50 005 166
65020 50 005 512	65299 50 005 120	65455 50 005 153
65021 50 005 514	65301 50 005 053	65457 50 005 552
65022 50 005 784	65302 50 005 755	65458 50 005 553
65025 50 005 513	65303 50 005 045	65465 50 005 551
65030 50 005 004	65304 50 005 043	65467 50 005 551
65033 50 005 517	65306 50 005 739	65467 50 005 555
65035 50 005 511	65307 50 005 051	65468 50 005 139
65050 50 005 516	65308 50 005 741	65469 50 005 168
65055 50 005 519	65309 50 005 793	65470 50 005 158
65056 50 005 778	65310 50 005 049	65471 50 005 165
65100 50 005 032	65311 50 005 749	65472 50 005 167
65100 50 005 932	65313 50 005 747	65473 50 005 159
65103 50 005 470	65315 50 005 734	65474 50 005 155
65105 50 005 767	65316 50 005 074	65474G 50 005 156
65106 50 005 034	65317 50 005 792	65475 50 005 754
65108 50 005 033	65318 50 005 737	65500 50 005 335
65109 50 005 776	65319 50 005 900	65506 50 005 756
65110 50 005 021	65320 50 005 006	65508 50 005 794
65111 50 005 030	65322 50 005 741	65509 50 005 336
65112 50 005 427	65325 50 005 735	65510 50 005 170
65113 50 005 491	65327 50 005 736	65511 50 005 302
65114 50 005 490	65333 50 005 052	65511G 50 005 326
65118 50 005 457	65337 50 005 733	65512 50 005 795
65119 50 005 456	65343 50 005 738	65515 50 005 040
65120 50 005 909	65344 50 005 746	65516 50 005 340
65122 50 005 434	65345 50 005 748	65520 50 005 301
65122 50 005 436	65346 50 005 224	65522 50 005 308
65123 50 005 449	65347 50 005 043	65526 50 005 318
65124 50 005 430	65355 50 005 740	65527 50 005 323
65125 50 005 031	65361 50 005 059	65528 50 005 325
65126 50 005 908	65365 50 005 732	65530 50 005 107
65127 50 005 773	65377 50 005 733	65533 50 005 301
65137 50 005 452	65380 50 005 055	65534 50 005 309
65138 50 005 437	65400 50 005 556	65535 50 005 341
65139 50 005 454	65401 50 005 772	65541 50 005 316
65140 50 005 028		
65145 50 005 439		

CROSS REFERENCE



CROSS REFERENCE



Reference 	Reference 	Reference 			
SALERI	SALERI	SALERI			
PA238E	50 005 032	PA521	50 005 151	PA751	50 005 082
PA238S	50 005 035	PA522	50 005 140	PA752	50 005 309
PA239	50 005 034	PA524P	50 005 736	PA755P	50 005 551
PA248S	50 005 062	PA526	50 005 067	PA 760	50 005 551
PA249	50 005 019	PA527P	50 005 733	PA762	50 005 167
PA257	50 005 102	PA547	50 005 324	PA765	50 005 434
PA267	50 005 045	PA561	50 005 425	PA774	50 005 116
PA275	50 005 064	PA562	50 005 510	PA775	50 005 095
PA278P	50 005 142	PA571	50 005 512	PA776	50 005 123
PA280	50 005 311	PA573	50 005 162	PA786	50 005 176
PA320	50 005 196	PA575P	50 005 740	PA789	50 005 178
PA 322P	50 005 145	PA589P	50 005 138	PA790	50 005 194
PA347P	50 005 053	PA590P	50 005 725	PA792	50 005 182
PA355	50 005 051	PA595	50 005 428	PA800	50 005 192
PA356	50 005 321	PA599	50 005 068	PA801	50 005 177
PA358P	50 005 052	PA601	50 005 427	PA802	50 005 179
PA373	50 005 063	PA610	50 005 440	PA803	50 005 077
PA377P	50 005 145	PA610	50 005 442	PA806	50 005 100
PA380P	50 005 146	PA610	50 005 446	PA807	50 005 128
PA380P	50 005 553	PA611P	50 005 308	PA816	50 005 759
PA382	50 005 018	PA616	50 005 511	PA820	50 005 186
PA383	50 005 020	PA618	50 005 441	PA822	50 005 184
PA386	50 005 004	PA618	50 005 447	PA828	50 005 158
PA387	50 005 000	PA619P	50 005 149	PA829	50 005 156
PA397	50 005 323	PA624P	50 005 737	PA831	50 005 040
PA398P	50 005 065	PA637	50 005 324	PA835	50 005 437
PA409	50 005 021	PA646	50 005 005	PA837	50 005 437
PA412	50 005 038	PA647	50 005 430	PA839	50 005 434
PA413	50 005 325	PA648P	50 005 319	PA840	50 005 155
PA419	50 005 314	PA649P	50 005 313	PA846	50 005 139
PA426P	50 005 055	PA649P	50 005 333	PA847	50 005 165
PA427P	50 005 049	PA650	50 005 225	PA848	50 005 119
PA429P	50 005 307	PA655P	50 005 153	PA855	50 005 334
PA430	50 005 301	PA656	50 005 739	PA865	50 005 132
PA431	50 005 009	PA657	50 005 741	PA867	50 005 159
PA434	50 005 063	PA658	50 005 515	PA869	50 005 330
PA437P	50 005 059	PA659	50 005 513	PA871	50 005 073
PA445P	50 005 306	PA660	50 005 514	PA879	50 005 120
PA447	50 005 028	PA663P	50 005 163	PA880	50 005 337
PA458	50 005 029	PA664P	50 005 550	PA881	50 005 223
PA459	50 005 720	PA665P	50 005 166	PA883	50 005 168
PA460	50 005 148	PA670P	50 005 322	PA884	50 005 164
PA464P	50 005 302	PA671	50 005 449	PA887	50 005 224
PA465	50 005 031	PA674P	50 005 107	PA890	50 005 746
PA466P	50 005 030	PA675	50 005 741	PA895	50 005 172
PA467P	50 005 303	PA685	50 005 136	PA902	50 005 173
PA468	50 005 140	PA707P	50 005 738	PA908	50 005 080
PA469	50 005 221	PA708A	50 005 074	PA913	50 005 057
PA473	50 005 106	PA708P	50 005 734	PA918	50 005 452
PA483	50 005 304	PA709P	50 005 732	PA922	50 005 332
PA488	50 005 530	PA711P	50 005 326	PA924	50 005 181
PA488P	50 005 530	PA713	50 005 317	PA928	50 005 076
PA493	50 005 439	PA714	50 005 516	PA931	50 005 470
PA495	50 005 727	PA715	50 005 433	PA933	50 005 456
PA497	50 005 316	PA716	50 005 436	PA934	50 005 457
PA498	50 005 721	PA717	50 005 791	PA939	50 005 335
PA498E	50 005 721	PA718	50 005 435	PA941	50 005 137
PA503	50 005 318	PA729	50 005 517	PA944	50 005 132
PA510	50 005 160	PA738P	50 005 090	PA945	50 005 154
PA511P	50 005 310	PA746	50 005 111	PA946	50 005 769
PA512P	50 005 735	PA747	50 005 121	PA948	50 005 169
PA513P	50 005 320	PA748	50 005 036	PA949	50 005 216
PA519	50 005 150	PA750	50 005 135	PA951	50 005 490

CROSS REFERENCE





CROSS REFERENCE

CROSS REFERENCE

Reference 		Reference 		Reference 	
SALERI		SKF		SKF	
PA952	50 005 455	VKPC 81220	50 005 775	VKPC 84601	50 005 063
PA953	50 005 474	VKPC 81301	50 005 770	VKPC 84607	50 005 062
PA954	50 005 454	VKPC 81303	50 005 783	VKPC 84609	50 005 067
PA957	50 005 072	VKPC 81400	50 005 140	VKPC 84611	50 005 221
PA958	50 005 078	VKPC 81401	50 005 148	VKPC 84613	50 005 225
PA967	50 005 475	VKPC 81407	50 005 154	VKPC 84618	50 005 727
PA968	50 005 134	VKPC 81411	50 005 769	VKPC 84620	50 005 725
PA969	50 005 336	VKPC81416	50 005 750	VKPC 85200	50 005 042
PA970	50 005 170	VKPC81419	50 005 754	VKPC 85201	50 005 051
PA974	50 005 187	VKPC 81602	50 005 146	VKPC 85202	50 005 052
PA980	50 005 797	VKPC 81603	50 005 553	VKPC 85203	50 005 045
PA982	50 005 772	VKPC 81605	50 005 145	VKPC 85206	50 005 059
PA984	50 005 174	VKPC 81606	50 005 149	VKPC 85211	50 005 738
PA994	50 005 124	VKPC 81607	50 005 160	VKPC 85211	50 005 793
SCANIA		VKPC 81608	50 005 162	VKPC85300	50 005 755
0301473	50 005 832	VKPC 81609	50 005 162	VKPC85304	50 005 756
1318091	50 005 832	VKPC 81611	50 005 165	VKPC 85400	50 005 049
1353072	50 005 214	VKPC 81612	50 005 550	VKPC 85401	50 005 733
1365841	50 005 601	VKPC 81615	50 005 158	VKPC 85403	50 005 739
1508533	50 005 214	VKPC 81621	50 005 132	VKPC 85404	50 005 741
1508534	50 005 601	VKPC 81623	50 005 554	VKPC 85406	50 005 055
SEAT		VKPC 81624	50 005 164	VKPC 85407	50 005 735
027 115 105	50 005 808	VKPC 81625	50 005 168	VKPC 85408	50 005 736
027 115 105 A	50 005 803	VKPC 81626	50 005 554	VKPC 85409	50 005 732
027 115 105 B	50 005 805	VKPC 81800	50 005 166	VKPC 85460	50 005 900
027 115 105 C	50 005 803	VKPC 81802	50 005 167	VKPC 85600	50 005 043
027 115 105 E	50 005 808	VKPC 81803	50 005 163	VKPC 85603	50 005 740
028 115 105 G	50 005 806	VKPC 81805	50 005 552	VKPC 85610	50 005 737
030 115 105 C	50 005 868	VKPC 81811	50 005 905	VKPC 85611	50 005 734
030 115 105 D	50 005 868	VKPC 82214	50 005 303	VKPC 85613	50 005 224
030 115 105 E	50 005 868	VKPC 82246	50 005 334	VKPC 85620	50 005 746
036 115 105 B	50 005 844	VKPC 82251	50 005 057	VKPC 85624	50 005 747
036 115 105 D	50 005 844	VKPC 82429	50 005 324	VKPC 85700	50 005 760
049 115 105 A	50 005 808	VKPC 82630	50 005 321	VKPC 86201	50 005 311
051 115 105 A	50 005 801	VKPC 82665	50 005 332	VKPC 86206	50 005 326
055 115 105 D	50 005 808	VKPC 82667	50 005 056	VKPC86212	50 005 759
068 115 105 AG	50 005 803	VKPC 83205	50 005 310	VKPC 86215	50 005 335
068 115 105 BK	50 005 806	VKPC 83401	50 005 307	VKPC 86216	50 005 040
068 115 105 Q	50 005 803	VKPC 83420	50 005 313	VKPC 86305	50 005 794
06A 115 105	50 005 819	VKPC 83420	50 005 333	VKPC 86409	50 005 308
06A 115 105 B	50 005 819	VKPC 83423	50 005 314	VKPC 86413	50 005 301
06A 115 105 C	50 005 819	VKPC 83424	50 005 320	VKPC 86415	50 005 340
06A 115 105 D	50 005 819	VKPC 83425	50 005 322	VKPC 86416	50 005 170
4227634	50 005 816	VKPC 83428	50 005 339	VKPC 86417	50 005 171
4284907	50 005 816	VKPC 83604	50 005 304	VKPC 86500	50 005 796
46514517	50 005 816	VKPC 83615	50 005 319	VKPC 86520	50 005 797
→VOLKSWAGEN		VKPC 83617	50 005 306	VKPC 86602	50 005 325
SKF		VKPC 83640	50 005 761	VKPC 86603	50 005 316
VKPA 81400	50 005 150	VKPC 83643	50 005 779	VKPC 86603	50 005 341
VKPA 81401	50 005 151	VKPC83644	50 005 757	VKPC 86606	50 005 309
VKPA 84623	50 005 013	VKPC83645	50 005 758	VKPC 86609	50 005 106
VKPA 85605	50 005 053	VKPC 83810	50 005 330	VKPC 86610	50 005 102
VKPA 86206	50 005 302	VKPC 83811	50 005 331	VKPC 86618	50 005 107
VKPA 91602	50 005 187	VKPC 84205	50 005 064	VKPC 86619	50 005 551
VKPC 81200	50 005 142	VKPC 84207	50 005 065	VKPC 86619	50 005 555
VKPC 81203	50 005 138	VKPC 84208	50 005 530	VKPC 86620	50 005 798
VKPC 81204	50 005 153	VKPC 84209	50 005 068	VKPC 86621	50 005 317
VKPC 81206	50 005 138	VKPC 84215	50 005 119	VKPC 86622	50 005 318
VKPC 81210	50 005 139	VKPC 84216	50 005 120	VKPC 86623	50 005 323
VKPC 81215	50 005 137	VKPC 84403	50 005 720	VKPC 86630	50 005 223
		VKPC 84404	50 005 725	VKPC 86631	50 005 337
		VKPC 84415	50 005 215	VKPC 86633	50 005 336
		VKPC 84416	50 005 216	VKPC 87404	50 005 084



CROSS REFERENCE



Reference 	Reference 	Reference 
SKF	SKF	SUZUKI
VKPC 87813 50 005 082	VKPC 92412 50 005 136	17400-60A04 50 005 179
VKPC 87814 50 005 090	VKPC 92600 50 005 174	17400-60D01 50 005 075
VKPC 88430 50 005 785	VKPC 92645 50 005 127	17400-61810 50 005 075
VKPC 88600 50 005 002	VKPC 92651 50 005 173	17400-69G00 50 005 180
VKPC 88603 50 005 020	VKPC 92810 50 005 135	17400-69G01 50 005 180
VKPC 88604 50 005 029	VKPC 92928 50 005 169	17400-70B00 50 005 075
VKPC 88605 50 005 018	VKPC 93210 50 005 087	17400-82811 50 005 178
VKPC 88606 50 005 034	VKPC 93213 50 005 086	17400-82812 50 005 178
VKPC 88607 50 005 510	VKPC 93410 50 005 079	17400-82823 50 005 177
VKPC 88608 50 005 031	VKPC 93411 50 005 094	17400-82824 50 005 177
VKPC 88609 50 005 019	VKPC 93601 50 005 080	17400-82850 50 005 177
VKPC 88610 50 005 009	VKPC 93603 50 005 093	17400-82851 50 005 177
VKPC 88611 50 005 005	VKPC 94002 50 005 111	17400-83810 50 005 178
VKPC 88612 50 005 511	VKPC 94424 50 005 116	17400-83811 50 005 178
VKPC 88613 50 005 028	VKPC 94425 50 005 110	17400-83812 50 005 178
VKPC 88614 50 005 512	VKPC 94603 50 005 118	17400-83814 50 005 178
VKPC 88615 50 005 515	VKPC 95003 50 005 129	17410-85E00 50 005 760
VKPC 88616 50 005 514	VKPC 95005 50 005 125	
VKPC 88617 50 005 513	VKPC 95008 50 005 095	SWAG
VKPC 88619 50 005 425	VKPC 95405 50 005 123	30800012 50 005 804
VKPC 88620 50 005 439	VKPC 95610 50 005 128	30880001 50 005 822
VKPC 88622 50 005 433	VKPC 95614 50 005 126	30880002 50 005 813
VKPC 88625 50 005 036	VKPC 95800 50 005 124	30880003 50 005 805
VKPC 88645 50 005 784	VKPC 95853 50 005 096	30880004 50 005 803
VKPC 88800 50 005 000	VKPC 95854 50 005 790	30880005 50 005 808
VKPC 88802 50 005 004	VKPC 95857 50 005 097	30880006 50 005 800
VKPC 88803 50 005 033	VKPC 96210 50 005 177	30880007 50 005 806
VKPC 88804 50 005 447	VKPC 96212 50 005 178	30880008 50 005 866
VKPC 88807 50 005 035	VKPC 96402 50 005 179	30880009 50 005 807
VKPC 88809 50 005 428	VKPC 97200 50 005 077	30880010 50 005 867
VKPC 88810 50 005 446	VKPC 97201 50 005 078	30880011 50 005 809
VKPC 88812 50 005 021	VKPC 98863 50 005 133	30880013 50 005 802
VKPC 88813 50 005 038	VKPC 99407 50 005 176	30901733 50 005 812
VKPC 88816 50 005 449	VKPV 94434 50 005 121	30902134 50 005 868
VKPC 88818 50 005 030		30907527 50 005 845
VKPC 88820 50 005 430	SKODA	30919416 50 005 811
VKPC 88821 50 005 435	036 115 105 B 50 005 844	30922204 50 005 819
VKPC 88824 50 005 436	036 115 105 D 50 005 844	30990004 50 005 801
VKPC 88825 50 005 452	06A 115 105 50 005 819	40921782 50 005 818
VKPC 88826 50 005 516	06A 115 105 B 50 005 819	6092 1241 50 005 934
VKPC 88827 50 005 427	06A 115 105 C 50 005 819	62921079 50 005 815
VKPC 88828 50 005 437	06A 115 105 D 50 005 819	62921089 50 005 820
VKPC 88829 50 005 519		62923213 50 005 854
VKPC 88831 50 005 517	SUBARU	99908693 50 005 810
VKPC 88835 50 005 454	21111-AA000 50 005 176	
VKPC 88836 50 005 434	21111-AA001 50 005 176	TECNOCAR
VKPC 88854 50 005 908	21111-AA002 50 005 176	A424 50 005 136
VKPC 90200 50 005 073	21111-AA003 50 005 176	
VKPC 90202 50 005 072	21111-AA004 50 005 176	TEMOT
VKPC 90402 50 005 076	21111-AA005 50 005 176	85-0140 50 005 002
VKPC 90450 50 005 075	21111-AA006 50 005 176	85-0150 50 005 000
VKPC 91402 50 005 196	21111-AA007 50 005 176	85-0240 50 005 033
VKPC 91405 50 005 182	21111-AA011 50 005 176	85-0270 50 005 034
VKPC 91413 50 005 194		85-0280 50 005 032
VKPC 91416 50 005 184	SUZUKI	85-0290 50 005 035
VKPC 91606 50 005 192	17400-50812 50 005 075	85-0730 50 005 042
VKPC 91607 50 005 186	17400-60810 50 005 179	85-0760 50 005 043
VKPC 91805 50 005 189	17400-60811 50 005 179	85-1000 50 005 146
VKPC 91806 50 005 188	17400-60812 50 005 179	85-1015 50 005 106
VKPC 91808 50 005 183	17400-60813 50 005 179	85-1065 50 005 067
VKPC 91814 50 005 198	17400-60814 50 005 179	85-1075 50 005 530
VKPC 92208 50 005 791	17400-60815 50 005 179	85-1085 50 005 720
VKPC 92408 50 005 172	17400-60A02 50 005 179	85-1090 50 005 062

CROSS REFERENCE





CROSS REFERENCE

CROSS REFERENCE

Reference 	Reference 	Reference 			
VOLKSWAGEN		VOLKSWAGEN		VOLKSWAGEN	
00A 121 010	50 005 164	030 121 004 B	50 005 153	038 121 011 AV	50 005 132
021 121 004	50 005 165	030 121 005 H	50 005 153	038 121 011AX	50 005 132
021 121 004 A	50 005 165	030 121 005 L	50 005 153	038 121 011 C	50 005 554
022 121 011	50 005 008	030 121 005 LV	50 005 153	038 121 011 D	50 005 554
023 121 004	50 005 163	030 121 005 LX	50 005 153	038 121 011 G	50 005 783
023 121 004 V	50 005 163	030 121 005 N	50 005 139	038 121 011G	50 005 554
023 121 004 X	50 005 163	030 121 005 NV	50 005 139	038 121 011J	50 005 554
025 121 010 A	50 005 160	030 121 005 NX	50 005 139	038 121 011K	50 005 554
025 121 010 AV	50 005 160	030 121 005 S	50 005 137	038 121 011KX	50 005 554
025 121 010 AX	50 005 160	030 121 008 A	50 005 137	03C 121 005 B	50 005 061
025 121 010 B	50 005 162	030 121 008 C	50 005 137	03C 121 005 C	50 005 061
025 121 010 BV	50 005 162	030 121 008 CX	50 005 137	03C 121 005 D	50 005 001
025 121 010 BX	50 005 162	030 121 008 D	50 005 139	03C 121 005 K	50 005 001
025 121 010 C	50 005 162	030 121 008 DX	50 005 139	03C 121 005 L	50 005 001
025 121 010 CV	50 005 162	031 121 004	50 005 138	03D 121 005	50 005 770
025 121 010 CX	50 005 162	031 121 004 A	50 005 138	03D 121 013 B	50 005 770
025 121 010 D	50 005 160	031 121 004 AV	50 005 138	045 121 011B	50 005 556
025 121 010 E	50 005 162	031 121 004 AX	50 005 138	045 121 011 C	50 005 750
025 121 010 F	50 005 162	031 121 004 X	50 005 138	045 121 011 G	50 005 750
026 115 105	50 005 813	031 121 005 A	50 005 138	046 121 004	50 005 553
026 115 105 A	50 005 822	031 121 005 C	50 005 138	046 121 004 D	50 005 552
026 115 105 B	50 005 813	031 121 005 CV	50 005 138	046 121 004 DV	50 005 552
026 121 005 A	50 005 148	031 121 005 CX	50 005 138	046 121 004 DX	50 005 552
026 121 005 C	50 005 148	034 121 004	50 005 149	046 121 004 V	50 005 553
026 121 005 E	50 005 148	034 121 004 A	50 005 149	046 121 004 X	50 005 553
026 121 005 F	50 005 155	034 121 004 V	50 005 149	047 121 013 J	50 005 772
026 121 005 FV	50 005 155	034 121 004 X	50 005 149	047 121 013 L	50 005 768
026 121 005 FX	50 005 155	034 121 005 D	50 005 149	047 121 013 M	50 005 768
026 121 005 G	50 005 148	035 121 004	50 005 145	047 121 013 P	50 005 768
026 121 005 H	50 005 148	035 121 004 A	50 005 145	047 121 013 R	50 005 768
026 121 005 K	50 005 155	035 121 004 AV	50 005 145	049 115 105 A	50 005 808
026 121 005 L	50 005 155	035 121 004 AX	50 005 145	049 115 105 H	50 005 813
026 121 010	50 005 151	035 121 004 X	50 005 145	050 121 010	50 005 156
026 121 010 A	50 005 150	035 121 005	50 005 145	050 121 010 A	50 005 156
026 121 010 AV	50 005 150	035 121 005 B	50 005 145	050 121 010 C	50 005 156
026 121 010 C	50 005 151	035 121 005 E	50 005 145	050 121 010 CX	50 005 156
026 121 010 CV	50 005 151	036 115 105 B	50 005 844	051 115 105 A	50 005 801
026 121 010 CX	50 005 151	036 115 105 D	50 005 844	052 121 004	50 005 142
026 121 010 D	50 005 150	036 121 005 B	50 005 154	052 121 004 V	50 005 142
026 121 010 DV	50 005 150	036 121 005 D	50 005 769	052 121 004 X	50 005 142
026 121 010 DX	50 005 150	036 121 005 E	50 005 154	052 121 005	50 005 142
026 121 010 F	50 005 151	036 121 005 F	50 005 754	052 121 005 A	50 005 142
026 121 010 FV	50 005 151	036 121 005 J	50 005 769	052 121 005 AX	50 005 142
026 121 010 FX	50 005 151	036 121 005 M	50 005 769	052 121 019	50 005 142
026 121 010 V	50 005 151	036 121 005 P	50 005 754	053 115 105 B	50 005 845
026 121 010 X	50 005 151	036 121 005 Q	50 005 154	053 115 105 C	50 005 845
027 115 105	50 005 808	036 121 005 QX	50 005 154	054 121 004	50 005 550
027 115 105 A	50 005 803	036 121 005 S	50 005 154	054 121 004 A	50 005 550
027 115 105 B	50 005 805	036 121 008 G	50 005 754	054 121 004 AV	50 005 550
027 115 105 C	50 005 803	036 121 008 GX	50 005 754	054 121 004 AX	50 005 550
027 115 105 E	50 005 808	036 121 008K	50 005 154	055 115 105 D	50 005 808
028 115 105 D	50 005 800	036 121 008L	50 005 154	055 121 010	50 005 150
028 115 105 G	50 005 806	036 121 008LX	50 005 154	055 121 010 X	50 005 150
028 115 105 J	50 005 866	037 115 105	50 005 810	056 115 105 A	50 005 813
028 115 105 L	50 005 807	037 121 005 B	50 005 148	056 121 005	50 005 140
028 115 105 M	50 005 867	037 121 005 C	50 005 148	056 121 005 A	50 005 140
028 121 004	50 005 158	037 121 008 C	50 005 137	056 121 011	50 005 150
028 121 004 V	50 005 158	037 121 010	50 005 151	056 121 013 A	50 005 150
028 121 004 X	50 005 158	037 121 010 A	50 005 151	058 115 105 A	50 005 811
030 115 105 C	50 005 868	037 121 010 AX	50 005 151	058 115 105 B	50 005 811
030 115 105 D	50 005 868	038 121 001 C	50 005 554	058 115 105 C	50 005 811
030 115 105 E	50 005 868	038 121 011	50 005 132	059 121 004 B	50 005 168
030 121 004 A	50 005 153	038 121 011 A	50 005 132	059 121 004 C	50 005 168



CROSS REFERENCE

Reference 	Reference 	Reference 
VOLKSWAGEN	VOLKSWAGEN	VOLVO
059 121 004 D	50 005 168	077 121 004 FX 50 005 181
059 121 004 E	50 005 168	077 121 004 H 50 005 181
059 121 004 EX	50 005 168	077 121 004 M 50 005 777
062 121 010	50 005 781	077 121 004 N 50 005 777
066 121 011 C	50 005 159	078 121 004 B 50 005 166
068 115 105 AC	50 005 804	078 121 004 BV 50 005 166
068 115 105 AD	50 005 804	078 121 004 BX 50 005 166
068 115 105 AE	50 005 809	078 121 004 C 50 005 166
068 115 105 AG	50 005 803	078 121 004 CV 50 005 166
068 115 105 AN	50 005 809	078 121 004 CX 50 005 166
068 115 105 AP	50 005 804	078 121 004 H 50 005 167
068 115 105 AQ	50 005 802	078 121 004 HV 50 005 167
068 115 105 AR	50 005 802	078 121 004 HX 50 005 167
068 115 105 BK	50 005 806	078 121 004 J 50 005 167
068 115 105 BL	50 005 866	078 121 004 JV 50 005 167
068 115 105 BP	50 005 802	078 121 004 JX 50 005 167
068 115 105 D	50 005 809	078 121 004 L 50 005 905
068 115 105 H	50 005 809	078 121 004 Q 50 005 167
068 115 105 J	50 005 802	078 121 004 QX 50 005 167
068 115 105 N	50 005 804	078 121 004 R 50 005 905
068 115 105 P	50 005 809	078 121 006 50 005 167
068 115 105 Q	50 005 803	078 121 006 A 50 005 905
068 115 105 R	50 005 804	111 115 107 A 50 005 812
068 115 105 S	50 005 809	111 115 107 B 50 005 812
068 121 005	50 005 140	111 115 107 BK 50 005 812
068 121 005 A	50 005 148	
068 121 005 B	50 005 140	VOLVO
068 121 005 C	50 005 140	1257185 50 005 146
068 121 005 X	50 005 140	1326342 50 005 106
068 121 010	50 005 150	1326342-1 50 005 106
068 121 010 A	50 005 151	1545261 50 005 602
068 121 010 AX	50 005 151	1675945 50 005 602
069 121 004	50 005 146	1698620 50 005 602
069 121 004 V	50 005 146	1699790 50 005 602
069 121 004 X	50 005 146	20431484 50 005 602
069 121 005 D	50 005 146	20538845 50 005 634
06A 115 105	50 005 819	20744939 50 005 634
06A 115 105 B	50 005 819	270559 50 005 106
06A 115 105 C	50 005 819	270559-8 50 005 106
06A 115 105 D	50 005 819	270681 50 005 102
06B 121 011 H	50 005 775	271275 50 005 106
06B 121 011 L	50 005 775	2712750 50 005 106
06B 121 011 LX	50 005 775	271613 50 005 146
06B 121 011 M	50 005 775	2716470 50 005 107
06C 121 004 C	50 005 771	271768 50 005 551
06C 121 004 G	50 005 771	271768 50 005 555
06C 121 004 H	50 005 771	2717684 50 005 551
06C 121 004 HX	50 005 771	271830 50 005 106
070 121 011 A	50 005 007	271975 50 005 106
070 121 011 C	50 005 007	2719854 50 005 107
070 121 011 D	50 005 007	271986 50 005 107
071 121 005	50 005 159	272334 50 005 797
074 121 004	50 005 551	272457 50 005 107
074 121 004 A	50 005 551	272476 50 005 107
074 121 004 B	50 005 555	272481 50 005 107
074 121 004 V	50 005 551	274155 50 005 555
074 121 004 X	50 005 551	274216 50 005 764
074 121 005 M	50 005 555	275619 50 005 102
074 121 005 MX	50 005 555	275619-5 50 005 102
074 121 005 N	50 005 555	30620725 50 005 756
074 121 005 NX	50 005 555	30735758 50 005 119
077 121 004 F	50 005 181	3085599 50 005 301
077 121 004 FV	50 005 181	3085599-1 50 005 301
		30874316 50 005 796
		3184802 50 005 602
		3184802-1 50 005 602
		3242084 50 005 301
		3287751 50 005 301
		3287751-6 50 005 301
		3343093 50 005 301
		3343093-5 50 005 301
		3344251 50 005 301
		3344251-8 50 005 301
		3344827 50 005 301
		3344831 50 005 301
		3345626 50 005 301
		463425 50 005 102
		463425-9 50 005 102
		478649 50 005 841
		478845 50 005 602
		479931 50 005 602
		8149937 50 005 602
		8149937-8 50 005 602
		8653806 50 005 762
		8692839 50 005 798
		8694627 50 005 797
		8694629 50 005 764
		8694630 50 005 764
		9142695 50 005 797

CROSS REFERENCE



CROSS REFERENCE

CROSS REFERENCE

Reference



Reference



Reference



Quality Information Report

for KOLBENSCHMIDT Products

Customer ref. no: <input style="width: 200px;" type="text"/>		MSI ref. no: <input style="width: 200px;" type="text"/>	
Your address (MSI customer): <input style="width: 400px; height: 50px;" type="text"/>		Your customer's name (engine reconditioner, workshop): <input style="width: 400px; height: 50px;" type="text"/>	
claimed part:	<input type="checkbox"/> liner	<input type="checkbox"/> cylinder head	<input type="checkbox"/> water pump
<input type="checkbox"/> piston	<input type="checkbox"/> kit set	<input type="checkbox"/> valve	<input type="checkbox"/> filter
<input type="checkbox"/> rings	<input type="checkbox"/> bearing	<input type="checkbox"/> valve-guide / seat	<input type="checkbox"/> oilpump
		<input type="checkbox"/> other	<input type="checkbox"/> camshaft
Part no*:	<input style="width: 250px;" type="text"/>		
engine-manufacturer*:	<input style="width: 150px;" type="text"/>	engine type*:	<input style="width: 100px;" type="text"/>
<input type="checkbox"/> passenger vehicle	<input type="checkbox"/> bus	<input type="checkbox"/> stationary engine	<input type="checkbox"/> model year*:
<input type="checkbox"/> commercial vehicle	<input type="checkbox"/> agricultural vehicle	<input type="checkbox"/> compressor	<input style="width: 100px;" type="text"/>
<input type="checkbox"/> heavy duty	<input type="checkbox"/> fork lift	<input type="checkbox"/> marine-engine	
installation date / complete mileage or running time*:	<input style="width: 150px;" type="text"/>	removal date / complete mileage or running time*:	<input style="width: 150px;" type="text"/>
reason for repair / overhauling*:	<input style="width: 600px; height: 30px;" type="text"/>		
Have the below listed parts been overhauled (O), checked (C), replaced (R) or adjusted (A) during last overhaul?			
<input type="checkbox"/> timing belt	<input type="checkbox"/> cylinder head	<input type="checkbox"/> crankshaft	
<input type="checkbox"/> spark plug	<input type="checkbox"/> oil / air / fuel filter	<input type="checkbox"/> valve guide / seat	
<input type="checkbox"/> carburettor	<input type="checkbox"/> radiator	<input type="checkbox"/> turbo charger	
<input type="checkbox"/> injection pump	<input type="checkbox"/> oil- / water pump	<input type="checkbox"/> main and conrod bearing	
<input type="checkbox"/> injection nozzle	<input type="checkbox"/> oil-jet nozzle	<input type="checkbox"/> small end bushing	
reason for claim / representation of the damage*:	<input style="width: 600px; height: 60px;" type="text"/>		
Please note:			
<ul style="list-style-type: none"> • In order to find the fundamental cause of your damage, we need to be informed as comprehensively as possible. Please send us the entire unit i.e. piston and piston rings, piston and liner or the whole conrod or main bearing kit, including a completely filled in QIR (quality information report). (Address see below) • The fields marked with an * must be filled in. In order to be able to process your application faster, filling in of these fields is mandatory! • Processing will only be possible if you provide the receipt (if required with additional costs) together with this form. Receipts relating to additional costs received later cannot be taken into account offhand. • A completely filled in QIR (quality information report) must be provided for each component claimed about. 			
In case of rejection, shall the parts be send back to your address?		yes <input type="checkbox"/>	no <input type="checkbox"/>
Charges are on your account.*			
<input style="width: 400px;" type="text"/>	<input style="width: 100px;" type="text"/>	<input style="width: 200px;" type="text"/>	
city/country	date	signature	



Quality Information Report

for KOLBENSCHMIDT Products



Customer ref. no: MSI ref. no:

Your address (MSI customer): Your customer's name (engine reconditioner, workshop):

claimed part: liner cylinder head water pump oilpump
 piston kit set valve filter camshaft
 rings bearing valve-guide / seat other _____

Part no*:

engine-manufacturer*: engine type*: model year*:

passenger vehicle bus stationary engine
 commercial vehicle agricultural vehicle compressor
 heavy duty fork lift marine-engine

installation date / complete mileage or running time*: removal date / complete mileage or running time*:

reason for repair / overhauling*:

Have the below listed parts been overhauled (O), checked (C), replaced (R) or adjusted (A) during last overhaul?

timing belt cylinder head crankshaft
 spark plug oil / air / fuel filter valve guide / seat
 carburettor radiator turbo charger
 injection pump oil- / water pump main and conrod bearing
 injection nozzle oil-jet nozzle small end bushing

reason for claim / representation of the damage*:

Please note:

- In order to find the fundamental cause of your damage, we need to be informed as comprehensively as possible. Please send us the entire unit i.e. piston and piston rings, piston and liner or the whole conrod or main bearing kit, including a completely filled in QIR (quality information report). (Address see below)
- The fields marked with an * must be filled in. In order to be able to process your application faster, filling in of these fields is mandatory!
- Processing will only be possible if you provide the receipt (if required with additional costs) together with this form. Receipts relating to additional costs received later cannot be taken into account offhand.
- A completely filled in QIR (quality information report) must be provided for each component claimed about.

In case of rejection, shall the parts be send back to your address? yes no

Charges are on your account.*

city/country date signature



Verkaufs- und Lieferbedingungen

1. Auftragserteilung, abweichende Bedingungen

- 1.1 Lieferungen und Leistungen erbringen wir ausschließlich zu den nachfolgenden Bedingungen und etwigen, dem Besteller bekanntgegebenen Sonderbedingungen.
- 1.2 Allgemeine Geschäftsbedingungen des Bestellers gelten nur bei ausdrücklicher schriftlicher Bestätigung. Weder unterlassener Widerspruch noch Ausführung von Lieferung oder Leistung stellen eine Anerkennung fremder Geschäftsbedingungen dar.

2. Angebot, Angebotsunterlagen

- 2.1 Unser Angebot ist freibleibend, sofern sich aus der Auftragsbestätigung nichts anderes ergibt.
- 2.2 An Abbildungen, Zeichnungen und anderen Unterlagen, die dem Besteller überlassen werden, behalten wir uns Eigentums- und Urheberrechte vor; sie dürfen nicht für andere als die von uns angegebenen Zwecke verwendet oder Dritten zugänglich gemacht werden. Dies gilt insbesondere für schriftliche Unterlagen, die als "vertraulich" bezeichnet sind; vor ihrer Weitergabe an Dritte bedarf der Besteller unserer ausdrücklichen schriftlichen Zustimmung.
- 2.3 Alle Angaben in Katalogen, Abbildungen, Zeichnungen und sonstigen Unterlagen sind unverbindlich.
- 2.4 Für Inhalt und Umfang des Liefervertrages ist unsere schriftliche Auftragsbestätigung maßgebend. Die Übermittlung per Datenfernübertragung genügt der Schriftform.

3. Preise

- 3.1 Unsere Preise gelten ab Werk/Lager ausschließlich Verpackung und zuzüglich der zum Zeitpunkt der Rechnungsstellung jeweils gültigen gesetzlichen Mehrwertsteuer.
- 3.2 Wir behalten uns das Recht vor, unsere Preise entsprechend zu ändern, wenn nach Abschluß des Vertrages Kostensenkungen oder Kostenerhöhungen, insbesondere aufgrund von Tarifabschlüssen oder Materialpreisänderungen eintreten. Diese werden wir dem Besteller auf Verlangen nachweisen.

4. Lieferung

- 4.1 Die Einhaltung von vereinbarten Fristen für Lieferungen setzt den rechtzeitigen Eingang sämtlicher vom Besteller zu liefernden Unterlagen, erforderlichen Genehmigungen und Freigaben, insbesondere von Plänen, sowie die Einhaltung der vereinbarten Zahlungsbedingungen und sonstigen Verpflichtungen durch den Besteller voraus. Werden diese Voraussetzungen nicht rechtzeitig erfüllt, so verlängern sich die Fristen angemessen; dies gilt nicht, wenn wir die Verzögerung zu vertreten haben.
- 4.2 Höhere Gewalt, Arbeitskämpfe, Unruhen, behördliche Maßnahmen, Ausbleiben von Zulieferungen unserer Zulieferanten und sonstige unvorhersehbare, unabwendbare und schwerwiegende Ereignisse befreien die Vertragspartner für die Dauer der Störung und im Umfang ihrer Wirkung von den Leistungspflichten. Dies gilt auch, wenn diese Ereignisse zu einem Zeitpunkt eintreten, in dem sich der betroffene Vertragspartner in Verzug befindet. Die Vertragspartner sind verpflichtet, im Rahmen des Zumutbaren unverzüglich die erforderlichen Informationen zu geben und ihre Verpflichtungen den veränderten Verhältnissen nach Treu und Glauben anzupassen.
- 4.3 Schadensersatzansprüche des Bestellers gegen uns wegen Verzögerung der Leistung sind in allen Fällen verzögert, auch nach Ablauf einer uns etwa gesetzten Frist zur Lieferung, ausgeschlossen. Dies gilt nicht, soweit in Fällen des Vorsatzes oder der groben Fahrlässigkeit oder für die Verletzung von Leben, Körper und Gesundheit zwingend gehaftet wird; eine Änderung der Beweislast zum Nachteil des Bestellers ist hiermit nicht verbunden. Das gesetzliche Rücktrittsrecht des Bestellers bleibt unberührt. Vom Vertrag kann der Besteller im Rahmen der gesetzlichen Bestimmungen nur zurücktreten, soweit die Verzögerung der Lieferung durch uns zu vertreten ist.
- 4.4 Teillieferungen sind zulässig. Verzögert sich eine Teillieferung, so kann der Besteller hieraus keine Rechte wegen der übrigen Teilmenge geltend machen, es sei denn, die Teilerfüllung hat für ihn kein Interesse.
- 4.5 Unsere Lieferungen erfolgen ab Werk/Lager, sofern im Einzelfall nichts anderes vereinbart ist. Mit der Anzeige der Versandbereitschaft, spätestens, wenn die Ware das Werk/Lager verläßt, geht die Gefahr auf den Besteller über. Dies gilt auch, wenn wir den Transport durchführen. Eine Transportversicherung erfolgt nur nach besonderer Vereinbarung und auf Rechnung des Bestellers.
- 4.6 Einwegverpackungen werden nicht zurückgenommen. Der Besteller hat diese auf eigene Kosten zu entsorgen.

5. Selbstbelieferung

- Wir sind zur Aufschubung und/oder Aufhebung unserer hiervon betroffenen Lieferverpflichtung berechtigt, wenn richtige oder rechtzeitige Selbstbelieferung seitens unseres Vorlieferanten ohne unser Verschulden ausbleibt.

6. Sachmängelhaftung

- 6.1 Der Besteller hat nach der Lieferung die Ware unverzüglich zu untersuchen und etwaige Mängel unverzüglich schriftlich zu rügen. Verdeckte Mängel sind unverzüglich nach Entdeckung schriftlich zu rügen.
- 6.2 Bis zur Klärung der Reklamation darf beanstandete Ware nicht weiterverarbeitet werden. Uns ist Gelegenheit zu geben, gerügte Mängel an Ort und Stelle zu überprüfen. Im übrigen ist uns beanstandete Ware auf unseren Wunsch zu übersenden.
- 6.3 Dem Besteller überlassene Muster der Ware sind Orientierungs- oder Ausfallmuster. Ihre Überlassung berechtigt uns nach wie vor zur Lieferung nach handelsüblichen Toleranzen.
- 6.4 Bei Sachmängeln werden wir nach unserer Wahl den Mangel beseitigen oder eine mangelfreie Sache liefern, sofern der Sachmangel im Zeitpunkt des Gefahrübergangs vorlag. Schlägt die Nacherfüllung fehl, kann der Besteller – unbeschadet etwaiger Schadensersatzansprüche gemäß Ziffer 9 – die Vergütung mindern oder vom Vertrag zurücktreten. Ansprüche des Bestellers wegen der zum Zweck der Nacherfüllung erforderlichen Aufwendungen, insbesondere Transport-, Wege-, Arbeits- und Materialkosten, sind ausgeschlossen, soweit die Aufwendungen sich erhöhen, weil der Gegenstand der Lieferung nachträglich an einen anderen Ort als die Niederlassung des Bestellers verbracht worden ist, es sei denn, die Verbringung entspricht seinem bestimmungsgemäßen Gebrauch.
- 6.5 Gesetzliche Rückgriffsansprüche des Bestellers gemäß §§ 478, 479 BGB bestehen nur insoweit, als der Besteller mit seinem Abnehmer keine über die gesetzlichen Mängelansprüche hinausgehenden Vereinbarungen getroffen hat. Rückgriffsansprüche des Bestellers gegen uns bestehen darüber hinaus nur bis zur Höhe des Kaufpreises.
- 6.6 Mängelansprüche entstehen nicht, wenn der Fehler zurückzuführen ist auf Verletzung von Bedienungs-, Wartungs- und Einbauvorschriften, ungeeignete oder unsachgemäße Verwendung, fehlerhafte oder nachlässige Behandlung und natürlichen Verschleiß sowie vom Besteller oder von Dritten vorgenommene Eingriffe in den Liefergegenstand.
- 6.7 Die Verjährung für Mängelansprüche beträgt 24 Monate, gerechnet ab Gefahrübergang.
- 6.8 Auf Verlangen und auf unsere Kosten sind uns die fehlerhaften Teile unverzüglich zur Verfügung zu stellen.

7. Zahlungsbedingungen

- 7.1 Falls nicht anders vereinbart, sind unsere Rechnungen sofort nach Erhalt ohne Abzug zahlbar.
- 7.2 Kommt der Besteller in Zahlungsverzug, so sind wir berechtigt, Verzugszinsen in Höhe von 8% über dem Basiszinssatz zu berechnen.
- 7.3 Aufrechnungsrechte stehen dem Besteller nur zu, wenn seine Gegenansprüche rechtskräftig festgestellt oder von uns anerkannt sind. Außerdem ist er zur Ausübung eines Zurückbehaltungsrechts insoweit befugt, als sein Gegenanspruch auf dem gleichen Vertragsverhältnis beruht.
- 7.4 Sind mehrere Rechnungen oder Forderungen offen, so sind wir trotz einer etwaigen abweichenden Bestimmung des Bestellers berechtigt, die Reihenfolge der Tilgung zu bestimmen.
- 7.5 Werden uns nach Vertragsschluss Umstände bekannt, die bei Anlegung banküblicher Maßstäbe Zweifel an der Zahlungsfähigkeit begründen, oder ist der Besteller mit vereinbarten Zahlungszielen in Verzug, sind wir nach erfolglosem Ablauf einer angemessenen Nachfrist berechtigt, ausstehende Lieferungen nur gegen Vorkasse durchzuführen oder von der Stellung einer Sicherheit abhängig zu machen.

8. Eigentumsvorbehalt

- 8.1 Gelieferte Ware bleibt unser Eigentum bis zur Erfüllung aller gegenwärtigen Ansprüche aus Geschäftsverbindungen zwischen dem Besteller und uns (Vorbehaltsware). Für den Fall der Einleitung eines Insolvenzverfahrens über das Vermögen des Bestellers behalten wir uns den Rücktritt vor. Bei Pflichtverletzungen des Bestellers, insbesondere bei Zahlungsverzug, sind wir zum Rücktritt und zur Rücknahme berechtigt; der Besteller ist zur Herausgabe verpflichtet. Die Rücknahme bzw. Geltendmachung des Eigentumsvorbehalts erfordert keinen Rücktritt unsererseits; in diesen Handlungen oder einer Pfändung der Vorbehaltsware durch uns liegt kein Rücktritt vom Vertrag, es sei denn, wir hätten dies ausdrücklich erklärt.

- 8.2 Der Besteller ist zur getrennten Lagerung und Kennzeichnung der Vorbehaltsware verpflichtet. Der Besteller ist verpflichtet, die Vorbehaltsware pfleglich zu behandeln; insbesondere ist er verpflichtet, diese auf eigene Kosten gegen Feuer-, Wasser- und Diebstahlschäden zum Neuwert zu versichern. Sofern Wartungs- und Inspektionsarbeiten erforderlich sind, muß der Besteller diese auf eigene Kosten rechtzeitig durchführen.

- 8.3 Der Besteller darf die Vorbehaltsware weder verpfänden, noch zur Sicherung übereignen. Bei Pfändungen, Beschlagnahmungen oder sonstigen Verfügungen oder Eingriffen Dritter hat der Besteller uns unverzüglich zu benachrichtigen.

- 8.4 Der Besteller ist berechtigt, die Vorbehaltsware im ordentlichen Geschäftsgang weiter zu verkaufen; er tritt uns jedoch bereits jetzt alle Forderungen in Höhe des Rechnungsendbetrages unserer Forderung ab, die ihm aus der Weiterveräußerung gegen seine Abnehmer oder Dritte erwachsen, und zwar unabhängig davon, ob die Vorbehaltsware ohne oder nach Verarbeitung weiter verkauft worden ist. Zur Einziehung dieser Forderung bleibt der Besteller auch nach der Abtretung ermächtigt. Unsere Befugnis, die Forderung selbst einzuziehen, bleibt hiervon unberührt. Wir verpflichten uns, die Forderung nicht einzuziehen, solange der Besteller seinen Zahlungsverpflichtungen aus den vereinnahmten Erlösen nachkommt, nicht in Zahlungsverzug gerät, kein Antrag auf Eröffnung eines Insolvenzverfahrens gestellt ist oder keine Zahlungseinstellung vorliegt. In allen diesen Fällen können wir verlangen, daß der Besteller uns die abgetretenen Forderungen und deren Schuldner bekannt gibt, alle zum Einzug erforderlichen Angaben macht, die dazu gehörigen Unterlagen aushändigt und den Schuldnern (Dritten) die Abtretung mitteilt.

- 8.5 Eine Verarbeitung oder Umbildung der Vorbehaltsware nimmt der Besteller für uns vor, ohne daß uns daraus Verpflichtungen entstehen. Verbindet, vermischt, vermengt oder verarbeitet der Besteller unsere Vorbehaltsware, so erwerben wir das Miteigentum an der neuen Sache im Verhältnis des Wertes der Vorbehaltsware (Rechnungsendbetrag) zu den anderen verarbeiteten, vermengten, vermischten oder verbundenen Gegenständen zum Zeitpunkt der Verarbeitung, Vermengung, Vermischung oder Verbindung. Für die durch die Verarbeitung oder Verbindung entstehende Sache gilt im übrigen das gleiche wie für die unter Vorbehalt gelieferte Vorbehaltsware. Erfolgt die Vermischung oder Vermengung in der Weise, daß die Sache des Bestellers als Hauptsache anzusehen ist, so gilt als vereinbart, daß der Besteller uns anteilmäßig Miteigentum überträgt. Der Besteller verwahrt das so entstandene Alleineigentum oder Miteigentum für uns.

- 8.6 Übersteigt der Wert der uns gegebenen Sicherheiten unsere Forderungen insgesamt um mehr als 20%, so sind wir auf Verlangen des Bestellers verpflichtet, die überschüssenden Sicherheiten nach unserer Wahl freizugeben.

- 8.7 Sofern und soweit die Registrierung und/oder die Erfüllung anderer Erfordernisse Voraussetzung für die Wirksamkeit des Eigentumsvorbehalts ist, ist der Besteller verpflichtet, auf seine Kosten alle hierzu notwendigen Handlungen unverzüglich vorzunehmen und alle erforderlichen Mitteilungen zu machen. Falls und soweit die maßgebliche Rechtsordnung keine Vereinbarung eines Eigentumsvorbehalts zuläßt, wird der Besteller uns bei Inanspruchnahme von Warenkredit angemessene andere Sicherheiten stellen.

9. Sonstige Schadensersatzansprüche

- 9.1 Schadensersatzansprüche des Bestellers, gleich aus welchem Rechtsgrund, insbesondere wegen Verletzung von Pflichten aus dem Schuldverhältnis oder aus unerlaubter Handlung, sind ausgeschlossen.

- 9.2 Dies gilt nicht, soweit gesetzlich zwingend gehaftet wird, z. B. nach dem Produkthaftungsgesetz, in Fällen des Vorsatzes, der groben Fahrlässigkeit, wegen der Verletzung des Lebens, des Körpers oder der Gesundheit, wegen der Verletzung wesentlicher Vertragspflichten. Der Schadensersatzanspruch für die Verletzung wesentlicher Vertragspflichten ist jedoch auf den vertragstypischen, vorhersehbaren Schaden begrenzt, soweit nicht Vorsatz oder grobe Fahrlässigkeit vorliegt oder wegen der Verletzung des Lebens, des Körpers oder der Gesundheit gehaftet wird. Eine Änderung der Beweislast zum Nachteil des Bestellers ist mit den vorstehenden Regelungen nicht verbunden.

- 9.3 Soweit dem Besteller nach diesem Abschnitt 9 Schadensersatzansprüche zustehen, verjähren diese mit Ablauf der für Sachmängelansprüche geltenden Verjährungsfrist nach 6.7, soweit nicht zwingende gesetzliche Vorschriften entgegenstehen.

- 9.4 Soweit die Schadensersatzhaftung uns gegenüber ausgeschlossen oder eingeschränkt ist, gilt dies auch im Hinblick auf die persönliche Schadensersatzhaftung unserer Mitarbeiter, Vertreter und Erfüllungsgehilfen.

10. Rechte Dritter

- 10.1 Sofern ein Dritter wegen der Verletzung eines gewerblichen Schutzrechtes oder Urheberrechtes (Schutzrechte) durch von uns gelieferte, vertragsgemäß genutzte Produkte gegen den Besteller berechtigte Ansprüche erhebt, haften wir gegenüber dem Besteller wie folgt:

- 10.1.1 Wir werden nach unserer Wahl auf unsere Kosten entweder ein Nutzungsrecht für das Produkt erwirken, das Produkt so ändern, daß das Schutzrecht nicht verletzt wird, oder das Produkt austauschen. Ist uns dies nicht zu angemessenen Bedingungen möglich, haben wir das Produkt gegen Erstattung des Kaufpreises zurückzunehmen.

- 10.1.2 Unsere vorstehend genannten Verpflichtungen bestehen nur dann, wenn der Besteller uns über die vom Dritten geltend gemachten Ansprüche unverzüglich schriftlich verständigt, eine Verletzung nicht anerkennt und uns alle Abwehrmaßnahmen und Vergleichsverhandlungen vorbehalten bleiben. Stellt der Besteller die Nutzung des Produkts aus Schadensminderungs- oder sonstigen wichtigen Gründen ein, ist er verpflichtet, dem Dritten gegenüber darauf hinzuweisen, daß mit der Nutzungseinstellung kein Anerkenntnis einer Schutzrechtsverletzung verbunden ist.

- 10.2 Ansprüche des Bestellers sind ausgeschlossen, soweit er die Schutzrechtsverletzung zu vertreten hat oder soweit die Schutzrechtsverletzungen durch spezielle Vorgaben des Bestellers, durch eine von uns nicht voraussehbare Anwendung oder dadurch verursacht wird, daß das Produkt vom Besteller verändert oder zusammen mit nicht von uns gelieferten Produkten eingesetzt wird.

- 10.3 In den Fällen der Ziffer 10.2 stellt uns der Besteller von Ansprüchen Dritter frei.
- 10.4 Weitergehende Ansprüche gegen uns sind ausgeschlossen; Ziffer 9 (Sonstige Schadensersatzansprüche) bleibt jedoch ebenso unberührt wie das Recht des Bestellers zum Rücktritt vom Vertrag.

- 10.5 Bei Vorliegen sonstiger Rechtsmängel gelten die Bestimmungen nach Abschnitt 6 entsprechend.

11. Fertigungsmittel, Werkzeuge, Formeinrichtungen

- 11.1 Soweit der Besteller uns Fertigungsmittel (z.B. Werkzeuge, Kokillen, Formen oder Gesenke) zur Verfügung stellt, sind uns diese kostenfrei zuzusenden. Für deren Untergang, Verschlechterung oder unvollständige Rücklieferung und daraus resultierende Schäden übernehmen wir eine Haftung nur für grobe Fahrlässigkeit oder Vorsatz. Dies gilt nicht soweit gesetzlich zwingend gehaftet wird.

- 11.2 Wenn Fertigungsmittel von uns im Auftrag des Bestellers angefertigt oder beschafft werden, stellen wir hierfür anteilige Kosten gesondert in Rechnung; bei Gußteilen auch für Folgewerkzeuge. Bei Nichtausnutzung eines Werkzeuges übernimmt der Besteller die nicht gedeckten Kosten, auch der sonstigen typengebundenen Einrichtungen. Kosten für Modelle gehen stets in vollem Umfang zu Lasten des Bestellers. Die Fertigungsmittel bleiben unser Eigentum. Zur Herausgabe an den Besteller sind wir nicht verpflichtet. Dies gilt auch für Folgewerkzeuge.
- 11.3 Unsere dem Besteller ausgehändigten Zeichnungen und Unterlagen sowie unsere Vorschläge für die vorteilhafte Gestaltung und zur Herstellung der Teile dürfen an Dritte nicht weitergegeben und können von uns jederzeit zurückverlangt werden.

12. Erfüllungsort, Gerichtsstand, anwendbares Recht

- 12.1 Erfüllungsort der Zahlungsverpflichtung des Bestellers ist Neckarsulm, für unsere Verpflichtungen der Ort des Lieferwerkes/-lagers.

- 12.2 Gerichtsstand ist Heilbronn. Wir sind auch berechtigt, den Besteller an seinem allgemeinen Gerichtsstand zu verklagen.

- 12.3 Für alle Rechtsbeziehungen zwischen dem Besteller und uns gilt ausschließlich das materielle Recht der Bundesrepublik Deutschland unter Ausschluss des Kollisionsrechtes; das UN-Übereinkommen über Verträge über den Internationalen Warenkauf (CISG) findet keine Anwendung. Für die Auslegung von Lieferklauseln gelten die INCOTERMS in der jeweils gültigen Fassung.

13. Teilunwirksamkeit

- Die rechtliche Unwirksamkeit einzelner Bestimmungen dieser Bedingungen berührt die Wirksamkeit der übrigen Bestimmungen nicht.

14. Datenspeicherung

- Die für die Geschäftsabwicklung notwendigen Daten werden gespeichert und im Rahmen der Bestellabwicklung gegebenenfalls an Dritte weitergegeben. Alle personenbezogenen Daten werden selbstverständlich gemäß den Bestimmungen des Bundesdatenschutzgesetzes vertraulich behandelt.

General Conditions of Sale and Delivery

1. Order Placement, Diverging Conditions

- 1.1 We will provide goods and services exclusively on the basis of the terms and conditions set forth below as well as any special conditions notified to Buyer.
- 1.2 Buyer's standard terms and conditions shall only apply subject to express confirmation by us in writing. The omission to raise objections and/or the provision of goods or services on our part shall not be deemed to constitute our acceptance of other terms and conditions.

2. Offer, Offer Documents

- 2.1 Our offer is subject to alteration without notice, unless otherwise specified in the acceptance of order.
- 2.2 We reserve ownership and copyrights to any illustrations, diagrams, drawings and other documents submitted to Buyer; they may not be used for any purpose other than that specified by us nor may they be disclosed to third parties. This shall apply, in particular, to written documents marked "confidential"; Buyer must obtain our express prior written approval before forwarding such documents to third parties.
- 2.3 Any data and information contained in catalogues, illustrations, diagrams, drawings and other documents shall not be binding
- 2.4 Our written acceptance of order shall be mandatory for defining the contents and scope of the supply contract. Forwarding by remote data transmission shall comply with the requisite of transmission in written form.

3. Prices

- 3.1 Our prices relate to delivery ex works/warehouse exclusive of packing and are to be understood plus the respective statutory value added tax valid at the time of invoicing.
- 3.2 We reserve the right to revise our prices accordingly if after conclusion of the contract, any cost decreases or increases should occur, particularly as a result of collective wage agreements or changes in the cost of materials. We will furnish proof of any such changes towards Buyer, on request.

4. Delivery

- 4.1 Compliance with agreed delivery dates shall be dependent upon timely receipt of all documents, required approvals, releases and clearances to be provided by Buyer, particularly plans, and also compliance with the agreed terms of payment and other obligations to be met by Buyer. Should these prerequisites not be fulfilled on time, the delivery times will be extended analogously; this will not apply if we are responsible for the delay.
- 4.2 Force Majeure, industrial disputes, unrest, official action, failure to deliver on the part of our suppliers and other unforeseeable, unavoidable and serious events shall release the parties from their obligations to perform for the duration of the disturbances mentioned and to the extent of their impact. This shall also apply if such events occur at a time when the affected party is in delay. The parties shall be obliged to make best efforts in order to promptly provide the required information as can be reasonably expected and to adjust their obligations in good faith to the changed circumstances.
- 4.3 Any claims for damages lodged by Buyer against us on the grounds of delayed performance shall be excluded in all cases of delayed delivery, even after the expiration of a period set to us for delivery. This shall not apply insofar as mandatory liability applies to cases of damage caused intentionally or by gross negligence or to bodily injury; this shall not imply a reversal of the burden of proof to the detriment of Buyer. Buyer's statutory right to rescind the contract shall remain unaffected. Buyer may only withdraw from the contract within the scope of legal provisions inasmuch as a delay in delivery is attributable to us.
- 4.4 Part deliveries shall be allowable. Should a part consignment arrive late, Buyer may not derive any claims from this situation in respect of the full order, unless the part delivery is of no use to him.
- 4.5 Our deliveries are made ex works/warehouse, unless agreed otherwise in individual cases. Risk will pass over to Buyer on receipt of the advice of readiness for despatch or, at the latest, when the goods leave the works/warehouse. This shall also apply if the transport is carried out by us. Transport insurance shall be subject to special agreement and paid for by Buyer.
- 4.6 One-way packing will not be taken back. Buyer shall dispose of it at his own expense.

5. Sub-suppliers' Failure to Perform

We shall be entitled to postpone and/or cancel our respective supply obligations if for reasons not attributable to us we do not receive, correctly and on schedule, the necessary supplies from our sub-suppliers.

6. Liability for Defects

- 6.1 Buyer must examine the goods immediately on receipt and notify us without delay, in writing, of any defects. Hidden defects must be notified in writing immediately after being discovered.
- 6.2 In the case of complaints about defects, the goods which are the subject of such complaints must not be processed until the matter is clarified. We shall be given the opportunity to examine any notified defects on site. Moreover, the goods complained about shall be sent to us at our request.
- 6.3 Any samples delivered to Buyer are reference or out-turn samples. Delivery of such samples shall not affect our right to supply the goods in accordance with standard tolerances.
- 6.4 In the case of material defects we shall, at our discretion, either remedy the defect or provide goods that are free from defects provided that the material defect was existent at the time of the passage of risk. Should the rectification of defects fail, Buyer may reduce the amount to be paid or withdraw from the contract, irrespective of any claims for damages that may apply pursuant to Section 9. Any claims on the part of Buyer in respect of expenses incurred in connection with the rectification of defects, particularly cost of transport, mileage, labour and materials shall be excluded inasmuch as such expenses are increased due to the situation that the object of the supply was subsequently transferred to a place other than Buyer's establishment unless such a transfer is in conformance with the intended use.
- 6.5 Any claims under a statutory right of recourse pursuant to §§ 478, 479 German Civil Code (BGB) shall only apply inasmuch as Buyer did not conclude agreements with his customer exceeding the statutory warranty claims. Above and beyond this, Buyer's claims under a right of recourse shall not exceed the amount of the purchase price.
- 6.6 Warranty claims shall not arise if the defect complained about is attributable to non-compliance with operating, maintenance and/or installation instructions, unsuitable or improper use, faulty or negligent treatment, natural wear, and interference with the goods by Buyer or third parties.
- 6.7 The period of limitation for warranty claims shall be 24 months following the transfer of risk.
- 6.8 Upon our demand, the defective parts shall be immediately made available to us, at our expense.

7. Terms of Payment

- 7.1 Unless agreed otherwise, our invoices are due for payment immediately on receipt, without deduction.
- 7.2 If Buyer defaults, we shall be entitled to charge interest on arrears at the rate of 8% above the base interest rate.
- 7.3 Buyer shall only be entitled to set off if his counterclaims are res judicata or have been recognised by us. Furthermore, he shall be entitled to exercise a right of retention provided that his counterclaim is based on the same contractual relationship.
- 7.4 If several invoices or accounts receivable are outstanding, we shall be entitled to determine the sequence of discharge, irrespective of any existing provision to the contrary on the part of Buyer.
- 7.5 If after the conclusion of a contract, we become aware of circumstances that, in consideration of customary banking practice, call into question Buyer's ability to pay or if Buyer is in arrears in respect of the period allowed for payment and fails to pay on expiration of a reasonable extension of time, we shall be entitled to insist on cash in advance for deliveries still outstanding or to make such deliveries dependent on the provision of securities.

8. Retention of Title

- 8.1 Goods delivered shall remain our property until all pending claims derived from business relations between Buyer and us have been satisfied ("reserved goods"). For the event that insolvency proceedings are instituted against Buyer's assets, we reserve the right of rescission. In the event that the Buyer should not meet his obligations and, in particular, if he falls into arrears in payment, we shall be entitled to rescind and to take back the reserved goods; Buyer shall be obliged to surrender the reserved goods. The taking back of the reserved goods and reservation of title shall

not require a rescission on our part; such actions or the seizure of the reserved goods by us do not constitute a rescission of the contract, unless expressly declared by us.

- 8.2 Buyer shall be obliged to store and mark the reserved goods separately. Buyer shall be obliged to take good care of the reserved goods; in particular, he shall insure the reserved goods at his own cost against damage by fire, water and theft, at their replacement value. If the reserved goods require maintenance and inspection, Buyer must take care of this at his own cost and in due time.
- 8.3 Buyer may neither pledge the reserved goods nor transfer them by way of security. Buyer shall inform us without delay in the case of seizure, confiscation or other orders or interference by third parties.
- 8.4 Buyer shall be entitled to sell on the reserved goods in his ordinary course of business. However, he shall herewith assign to us all receivables up to the amount of our final invoice to which he becomes entitled as a result of reselling to his own customers or third parties, irrespective of whether the reserved goods are resold before or after processing. Buyer remains entitled to collect such receivables even after assigning them. Our entitlement to collect the receivables ourselves remains unaffected by this. We undertake not to collect the receivables provided that Buyer meets his payment obligations when due, from the proceeds, that no application is filed to initiate insolvency proceedings and that payments are not suspended. In all these cases, we may demand that Buyer informs us of the receivables assigned and the identity of the debtors, provides all the details required to enable the receivables to be collected, presents the relevant documents and notifies the debtors (third parties) of the assignment.
- 8.5 Buyer may process or convert the reserved goods on our behalf, without generating any commitments on our part. If Buyer combines, mixes, blends or processes our reserved goods, we shall acquire co-ownership to the new product in the proportion of the value of the reserved goods (final invoice amount) to the other processed, blended, mixed or combined items at the moment when the processing, blending, mixing or combining takes place. The product created as a result of processing or combining shall be subject to the same conditions as the reserved goods delivered under retention of title. If the mixing or blending takes place in such a manner that Buyer's product is considered to be the main item, it is agreed that Buyer shall transfer proportionate co-ownership to us. Buyer shall hold in custody, on our behalf, the object of sole ownership or co-ownership obtained in this way.
- 8.6 If the value of the security provided to us exceeds the value of our receivables by more than 20%, we shall be obliged, on Buyer's demand, to release the excess amounts at our discretion.
- 8.7 If and inasmuch as the registration and/or fulfillment of other requirements is a pre-condition for the effectiveness of our retention of title, Buyer shall have to take all necessary actions at his own cost and to provide all information required to this end. If and inasmuch as an agreement on the retention of title is not permitted under the relevant legal system, Buyer shall provide us with alternative appropriate security on taking advantage of credit on goods.

9. Miscellaneous Claims for Damages

- 9.1 Any claims for damages asserted by Buyer shall be excluded, regardless of their legal basis, particularly due to breach of duties deriving from contractual obligations or from illicit actions.
- 9.2 This shall not apply insofar as liability is mandatory, e.g. in accordance with the German Product Liability Act; in cases of intent; gross negligence; danger to life and limb and non-compliance with key contractual obligations. However, claims for damages regarding non-compliance with key contractual obligations shall be restricted to typical contractual damage that is foreseeable inasmuch as such damage is not caused intentionally or by gross negligence or liability applies to the danger to life and limb. The aforementioned provisions shall not entail a reversal of the burden of proof to the detriment of Buyer.
- 9.3 Insofar as Buyer is entitled to claims for damages in accordance with this Section 9, such claims shall fall under the statute of limitations upon the expiration of the period of limitations that applies to material defects in accordance with 6.7 unless this conflicts with statutory provisions.
- 9.4 Insofar as our liability for the payment of damages is excluded or restricted, this shall also apply to personal liability for compensation on the part of our employees, representatives and vicarious agents.

10. Third-party Rights

- 10.1 Should a third party, due to an intellectual property right or copyright (jointly referred to as "IP rights") having been infringed, bring a justified claim against Buyer in respect of the goods supplied by us having been used for their contractual purpose, we shall be liable to Buyer as follows:
 - 10.1.1 at our own cost, we shall at our discretion either acquire the right to use the product, modify the product so that IP rights are no longer infringed, or replace the product. If none of these measures is feasible at reasonable conditions, we shall take back the product in return for reimbursement of the purchase price;
 - 10.1.2 the obligations stated above will only materialise if Buyer immediately notifies us in writing of the claims brought by third parties, Buyer has not acknowledged an infringement and we are granted the right to all defensive measures and settlement negotiations. If Buyer stops using the product to limit damage or for any other reason, he must indicate to the third party that his ceasing to use the product does not constitute the recognition of an infringement of IP rights.
- 10.2 Any claims on the part of Buyer shall be excluded to the extent to which Buyer is responsible for infringing IP rights or if such an infringement is attributable to specific instructions imposed by Buyer, to a use not foreseeable by us or to the product having been changed by Buyer or used in combination with products not supplied by us.
- 10.3 In the cases stated in sub-clause 10.2, Buyer will exempt us from third party claims.
- 10.4 Any claims against us except those mentioned above shall be excluded; Clause 9 (Miscellaneous Claims for Damages) however, shall remain unaffected as does the right of Buyer to withdraw from the Contract.
- 10.5 In the event of other defects of title the provisions in accordance with Clause 6 shall apply analogously.

11. Production Equipment, Tools, Moulds

- 11.1 If Buyer provides us with production equipment (e.g. tools, moulds, cavities or dies), these shall be sent to us free of charge. We shall only be responsible for their loss, deterioration or incomplete return and any consequential damage, in the case of gross negligence or wilful default. This does not apply if the law stipulates liability.
- 11.2 If production equipment is manufactured or procured by us on behalf of Buyer, we shall charge for it separately at cost; for castings and mouldings and also for progressive dies. In the case of non-utilisation of a tool, Buyer shall pay the costs which have not been covered and also those relating to other type-specific equipment. The cost of prototypes shall always be paid in full by Buyer. The production equipment remains our property. We are not obliged to surrender this equipment to Buyer. This also applies to progressive dies.
- 11.3 Our drawings and documents and also our proposals for optimised design and manufacture of the components which are submitted to Buyer, may not be forwarded to third parties and we may ask for return of such documents at any time.

12. Place of Performance, Jurisdiction, Applicable Law

- 12.1 Neckarsulm is deemed the place of performance for Buyer's payment obligations. The supply plant/warehouse location is the place of performance for our obligations.
- 12.2 The place of jurisdiction is Heilbronn, Germany. We are also entitled to bring actions against Buyer at his place of jurisdiction as determined by the general law.
- 12.3 All legal relationships between us and Buyer shall be exclusively governed by German substantive law. The UN Convention on Contracts for the International Sale of Goods (CISG) shall not be applicable. The interpretation of delivery clauses shall be governed by the latest valid version of INCOTERMS.

13. Partial Ineffectiveness

The legal ineffectiveness of individual provisions contained in these General Conditions shall not affect the validity of the remaining provisions.

14. Data Storage

The data required to process business transactions will be stored and potentially forwarded to third parties in connection with the execution of orders. All personal data shall, of course, be treated confidentially in accordance with the provisions of the German Federal Data Protection Act.

Conditions Générales de Vente et de Livraison

1. Passation de commande, conditions dérogatoires

- 1.1 Nos livraisons et prestations de services sont régies exclusivement par les présentes Conditions et les Conditions Particulières qui ont été communiquées à l'acheteur.
- 1.2 Les Conditions Générales d'achat de l'acheteur ne peuvent s'appliquer sans accord préalable et écrit de notre part, l'absence d'opposition de notre part ou l'exécution de livraisons ou de prestations n'impliquant en aucun cas une acceptation desdites Conditions.

2. Offre, documentation de l'offre

- 2.1 Nos offres ne constituent aucun engagement de notre part, sauf dispositions particulières mentionnées dans la confirmation de commande.
- 2.2 Nous sommes titulaires des droits d'auteur et de propriété intellectuelle sur les illustrations, dessins ou tous autres documents qui seront remis à l'acheteur ; cette documentation ne pourra être utilisée qu'aux fins exclusives spécifiées par notre Société et ne pourra être communiquée à des tiers. La présente clause s'applique tout particulièrement aux documents écrits portant la mention « confidentiel » ; l'acheteur ne pourra les communiquer à des tiers qu'après autorisation écrite de notre part.
- 2.3 Les indications figurant dans les illustrations, les dessins, les catalogues et autres documents sont fournies à titre indicatif.
- 2.4 La teneur et l'étendue du contrat de livraison sont déterminées par notre confirmation écrite de la commande. La communication des données par transmission à distance suffit à satisfaire à l'obligation de la forme écrite.

3. Prix

- 3.1 Nos prix s'entendent sortie d'usine/d'entrepôt, emballage non compris. La taxe à la valeur ajoutée légalement en vigueur au moment de la facturation sera facturée en sus.
- 3.2 Nos prix sont valables sous réserve de modifications pouvant intervenir postérieurement à la conclusion du contrat ou à la passation de la commande et résultant d'augmentations ou de réductions des coûts, dues en particulier à la conclusion de conventions collectives, ou de variations dans les prix des matières. Sur demande de l'acheteur, un justificatif de ces modifications lui sera communiqué.

4. Livraison

- 4.1 Le respect des délais de livraison convenus est subordonné à la réception en temps opportun de tous les documents, autorisations et validations obligatoires qui doivent être fournis par l'acheteur, en particulier les plans. Le respect des délais de livraison est également soumis au respect des modalités de paiement convenues et à toutes les autres obligations à la charge de l'acheteur. En cas de non-respect de ces conditions préalables, les délais de livraison seront prorogés en conséquence. La présente clause ne s'appliquera pas si le retard occasionné est imputable à notre Société.
- 4.2 Les cas de force majeure, mouvements sociaux (grèves et autres), troubles sociaux, mesures administratives, défaut de livraison par nos sous-traitants, ainsi que tout autre événement grave, imprévisible et inéluctable, libéreront les parties au contrat de leurs obligations contractuelles pendant la période de leur durée et dans la mesure de leurs effets. La présente clause s'appliquera également si les événements mentionnés ci-dessus surviennent alors que la partie affectée est en retard dans l'exécution de ses obligations. Les parties au contrat s'engagent, dans la mesure du possible, à informer immédiatement l'autre partie de la survenance de telles circonstances et à adapter en toute bonne foi leurs obligations aux changements de situation en résultant.
- 4.3 Toute prétention de l'acheteur à des dommages et intérêts à notre encontre pour retard dans l'exécution de la prestation est exclue dans tous les cas de livraison retardée, même après expiration d'un éventuel délai qui nous aurait été fixé pour la livraison. Cette règle ne s'appliquera pas si la responsabilité est obligatoirement engagée pour cause d'intention délictueuse, de négligence grave ou d'atteinte à la vie, à l'intégrité du corps ou de la santé des personnes. La charge de la preuve n'en sera pas modifiée au détriment de l'acheteur. Le droit légal de désistement de l'acheteur n'en sera pas affecté. L'acheteur ne pourra se désister du contrat, dans le cadre des dispositions légales, que dans le cas où le retard de la livraison nous serait imputable.
- 4.4 Les livraisons partielles sont autorisées. En cas de retard dans une livraison partielle, l'acheteur ne pourra se prévaloir d'aucun droit portant sur le reste des quantités à livrer, sauf si la livraison partielle est pour lui dépourvue d'intérêt particulier.
- 4.5 Nos livraisons sont effectuées sortie d'usine/d'entrepôt, sauf accord particulier intervenant dans des cas spécifiques. Les risques sont transférés à l'acheteur dès l'avis indiquant que la marchandise est prête à l'expédition, au plus tard, lorsque la marchandise quitte l'usine/l'entrepôt. Les dispositions de la présente clause s'appliquent également si le transport est effectué par nos soins. Une assurance transport peut être souscrite uniquement après accord formel et à la charge de l'acheteur.
- 4.6 Les emballages perdus ne seront pas repris. L'acheteur est tenu d'assurer l'élimination de ces emballages à ses frais.

5. Réserve d'approvisionnement par nos fournisseurs

Nous sommes autorisés à différer et/ou à annuler notre obligation de livraison telle que mentionnée aux présentes lorsque nos propres fournisseurs ne nous livrent pas en temps voulu ou ne nous livrent pas correctement, sans que nous puissions en être tenus pour responsables.

6. Garantie des vices

- 6.1 L'acheteur s'oblige à vérifier immédiatement la marchandise après la livraison et à envoyer une réclamation écrite dans les plus brefs délais signalant les vices éventuellement constatés. Les vices cachés seront signalés par une lettre de réclamation immédiatement après leur découverte.
- 6.2 Aussi longtemps que le problème ne sera pas réglé, l'acheteur s'interdira de procéder à la transformation de la marchandise incriminée. Il devra nous donner la possibilité d'examiner la marchandise sur place. Par ailleurs, sur demande de notre part, l'acheteur devra nous renvoyer la marchandise objet de la réclamation.
- 6.3 Les échantillons de la marchandise remis à l'acheteur sont des échantillons fournis à titre d'information et de référence. Leur délivrance nous autorise toujours à livrer en tenant compte des tolérances admises habituellement dans le commerce.
- 6.4 En cas de défauts matériels détectés sur la marchandise, le choix nous reviendra de réparer ledit défaut ou de livrer une marchandise de remplacement en parfait état, si tant est que le défaut matériel ait été présent au moment du transfert des risques. Si la réparation échoue, l'acheteur pourra réduire le prix ou se désister du contrat, sans préjudice des droits éventuels aux dommages et intérêts cités au paragraphe 9. Nous prenons en charge les frais nécessaires à l'élimination du défaut, notamment les frais de transport, de déplacement, de main d'œuvre et de matériel, si tant est que lesdits frais ne soient pas augmentés par le fait que la marchandise a été transportée ultérieurement dans un autre endroit que le lieu d'établissement de l'acheteur, à l'exception des cas où ledit déplacement correspond à l'usage auquel la marchandise est destinée.
- 6.5 L'acheteur ne pourra se prévaloir de droits légaux au recours suivant les articles 478 et 479 du Code Civil allemand que s'il n'a pas conclu avec son client d'accords allant au-delà des droits légaux nés de la constatation de défauts matériels. D'autre part, les droits au recours de l'acheteur à notre encontre seront limités au montant du prix d'achat.
- 6.6 Les prétentions de l'acheteur pour cause de défauts matériels seront nulles et non avenues si le défaut résulte d'un manquement aux consignes de manœuvre, de maintenance et de montage, de l'usage inapproprié ou incorrect de la marchandise, d'un traitement impropre ou négligent et de l'usure naturelle, ou encore d'interventions opérées par l'acheteur ou par des tiers sur la marchandise livrée.
- 6.7 La prescription des revendications pour vices est de 24 mois, à dater du transfert des risques.
- 6.8 Les pièces défectueuses seront mises immédiatement à notre disposition sur notre demande et à nos frais.

7. Modalités de paiement

- 7.1 Sauf accord particulier, nos factures sont payables immédiatement à leur réception, sans déduction aucune.
- 7.2 En cas de retard de paiement de l'acheteur, nous nous réservons le droit d'exiger le paiement d'intérêts de retard d'un montant de 8 % supérieur au taux d'intérêt de base.
- 7.3 L'acheteur n'aura droit à la compensation que dans la mesure où ses contre-prétentions auront acquis force de choses jugées ou si nous les avons reconnues. D'autre part, il ne sera autorisé à l'exercice du droit de rétention que dans la mesure où sa contre-prétention repose sur la même relation contractuelle.
- 7.4 Dans l'hypothèse où plusieurs factures ou créances demeurent impayées, nous nous réservons le droit de définir la chronologie de l'apurement des dettes, sans tenir compte d'une éventuelle disposition différente du client.
- 7.5 Si, après la conclusion du contrat, des circonstances mettant en doute la solvabilité de l'acheteur (éta- bilité selon des critères bancaires habituels) étaient portées à notre connaissance ou si l'acheteur venait à prendre du retard dans les échéances convenues pour le paiement, nous serons en droit, après expiration sans résultat d'un délai supplémentaire raisonnable, d'exiger le paiement anticipé des livraisons en attente ou d'en subordonner l'exécution à la constitution d'une sûreté.

8. Réserve de propriété

- 8.1 La marchandise livrée demeure notre propriété jusqu'à satisfaction complète de tous les droits existants découlant des relations commerciales entre l'acheteur et notre Société (marchandise sous réserve de propriété). L'introduction d'une procédure de dépôt de bilan sur le patrimoine de l'acheteur nous autorise au désistement du contrat. En cas de violation des obligations contractuelles de l'acheteur, en particulier en cas de retard de paiement, nous serons autorisés au désistement du contrat et à la reprise de la marchandise sous réserve de propriété ; l'acheteur sera dans l'obligation de restituer la marchandise.

- Le fait que nous reprenions la marchandise ou le fait de faire valoir la réserve de propriété ne nécessite pas un désistement du contrat de notre part. Ces faits ou une saisie de la marchandise sous réserve par notre Société ne constituent pas un désistement du contrat, sauf si nous l'avons expressément signifié.
- 8.2 L'acheteur s'engage à stocker séparément et à identifier la marchandise sous réserve de propriété. Il s'oblige également à prendre soin de cette marchandise. En particulier, il est tenu d'assurer à ses frais la marchandise, pour sa valeur à l'état neuf, contre l'incendie, les dégâts des eaux et le vol. Dans la mesure où des travaux de maintenance et d'entretien seraient nécessaires, l'acheteur s'engage à les effectuer en temps voulu et à ses frais.
 - 8.3 L'acheteur n'est pas autorisé à nantir la marchandise sous réserve de propriété, ni à la transférer à titre de sûreté. L'acheteur devra nous informer immédiatement en cas de saisie, de confiscation ou de toute autre disposition ou intervention émanant de tiers.
 - 8.4 L'acheteur est autorisé à revendre la marchandise sous réserve de propriété dans le cadre d'opérations commerciales régulières, mais il nous cède d'ores et déjà toutes les créances résultant de la revente de la marchandise en question à ses clients ou à des tiers à hauteur du montant total de la somme due et ce, indépendamment du fait que la marchandise sous réserve de propriété ait été revendue sans ou après transformation. L'acheteur est autorisé à recouvrer cette créance même après la cession, notwithstanding notre pouvoir de recouvrer nous-mêmes ladite créance. Nous nous engageons à ne pas recouvrer la créance pour autant que l'acheteur respecte ses obligations de paiement sur les produits financiers réalisés, qu'il n'est pas en retard de paiement, qu'il n'existe pas de demande d'ouverture d'une procédure de dépôt de bilan ou qu'il n'est pas en état de cessation des paiements. Dans tous les cas cités ci-dessus, nous serons en droit d'exiger que l'acheteur nous fasse connaître les cessions de créances et leurs débiteurs, qu'il nous donne toutes les indications nécessaires à leur recouvrement, qu'il nous fournisse tous les documents correspondants et qu'il informe les débiteurs (tiers) de la cession des créances. L'acheteur procède pour notre compte à l'usinage ou à la transformation de la marchandise sous réserve de propriété sans qu'il en résulte pour nous une obligation quelconque. Si l'acheteur procède à des allages, des mélanges, des incorporations ou des transformations de notre marchandise sous réserve de propriété, nous acquérons de ce fait une copropriété sur la chose nouvelle en résultant, au prorata de la valeur initiale de cette marchandise (montant final de la facture) par rapport aux autres éléments transformés, incorporés, mélangés ou alliés au moment de la réalisation des opérations correspondantes. L'objet résultant de la transformation ou de l'alliage est soumis aux mêmes clauses que la marchandise livrée sous réserve de propriété. Si le mélange ou l'incorporation s'effectue dans une proportion telle que la chose de l'acheteur puisse être considérée comme la chose principale, il est réputé convenu par les présentes que l'acheteur nous en cède la copropriété au prorata. L'acheteur sera le dépositaire pour nous de la propriété exclusive ou de la copropriété ainsi engendrée.
 - 8.6 Si la valeur des sûretés qui nous ont été consenties excède nos créances de plus de vingt pour cent (20 %), nous nous engageons, sur demande de l'acheteur, à libérer les sûretés excédentaires selon notre choix.
 - 8.7 Dès lors et si tant est que l'enregistrement et/ou la satisfaction d'autres exigences constituent une condition préalable à la validité de la réserve de propriété, l'acheteur sera tenu de procéder immédiatement et à ses frais à tous les actes nécessaires et de faire les communiqués nécessaires. Dans l'hypothèse où le système juridique en vigueur n'autoriserait pas de clause contractuelle de réserve de propriété, l'acheteur faisant usage d'un crédit commercial s'engage à nous fournir d'autres garanties appropriées.

9. Autres droits aux dommages et intérêts

- 9.1 Tout droit à indemnisation de l'acheteur est exclu, quel qu'en soit le motif juridique, en particulier pour atteinte aux obligations inhérentes au rapport juridique entre le créancier et le débiteur ou pour acte illicite.
- 9.2 La présente clause ne s'applique pas dès lors que la responsabilité est obligatoire de par la loi, par exemple aux termes de la Loi relative à la garantie implicite du produit, en cas de faute intentionnelle, de négligence grave, d'atteinte à la vie, à l'intégrité du corps ou de la santé, et en cas de manquement à des obligations contractuelles majeures. Le droit aux dommages et intérêts en cas de manquement à des obligations contractuelles majeures sera toutefois limité au dommage prévisible, caractéristique du contrat, si tant est qu'il n'y ait pas eu intention délictueuse ou négligence grave, ou que la responsabilité soit obligatoirement engagée pour atteinte à la vie ou à l'intégrité du corps ou de la santé. Les dispositions susvisées n'emportent pas modification de la charge de la preuve au détriment du client.
- 9.3 Si l'acheteur peut prétendre aux dommages et intérêts aux termes du présent paragraphe 9, ces droits seront prescrits à l'expiration du délai de prescription cité au paragraphe 6.7, en vigueur pour les prétentions résultant du vice de la marchandise, si tant est que des dispositions impératives de la loi ne s'y opposent pas.
- 9.4 Toute exclusion ou limitation de notre responsabilité en matière d'indemnisation s'applique également à la responsabilité personnelle de nos employés, de nos représentants et de nos agents d'exécution.

10. Droits des tiers

- 10.1 Dès lors qu'un tiers fait valoir à l'encontre de l'acheteur des droits justifiés pour atteinte à ses droits de propriété industrielle ou droits d'auteur (droits de protection) par des produits que nous avons livrés et qui sont utilisés aux termes du contrat, nous sommes responsables vis-à-vis de l'acheteur dans les conditions suivantes :
 - 10.1.1 Le choix nous reviendra, soit d'acquiescer à nos frais un droit d'utilisation pour le produit, soit de modifier le produit de telle sorte qu'il ne porte pas atteinte audit droit de propriété, soit d'échanger le produit. Si ces opérations ne sont pas réalisables à des conditions raisonnables, nous nous engageons à reprendre le produit contre remboursement du prix d'achat.
 - 10.1.2 Nos obligations mentionnées ci-dessus ne seront valides que si l'acheteur nous informe immédiatement par écrit des prétentions alléguées par la tierce personne, s'il ne reconnaît pas d'atteinte auxdits droits et si nous toutes mesures de défense et de négociations de conciliation nous sont réservées. Si l'acheteur cesse d'utiliser le produit incriminé dans le but de réduire le préjudice ou pour toute autre raison, il sera tenu d'informer le tiers qu'il ne pourra y avoir reconnaissance d'atteinte au droit de propriété du fait de la cessation de l'utilisation.
- 10.2 Tout droit de l'acheteur sera exclu si la violation des droits de propriété lui est imputable ou si ladite violation est causée par des indications spéciales données par l'acheteur, par une utilisation non prévisible de notre part ou par le fait que l'acheteur utilise le produit après l'avoir modifié ou en association avec des produits qui ne font pas partie de nos livraisons.
- 10.3 Dans les cas cités à l'alinéa 10.2. ci-dessus, l'acheteur ne pourra faire valoir à notre encontre aucun droit de tiers.
- 10.4 Tout autre droit additionnel à faire valoir à notre encontre est exclu ; l'article 9 (Autres droits aux om- mages et intérêts) n'en sera toutefois pas affecté, de même que le droit de l'acheteur à se désister du contrat.
11. **Moyens de fabrication, outillage/outils, équipements de moulage**
 - 11.1 Dès lors que l'acheteur met à notre disposition des moyens de fabrication (ex. outils, moulages en coquille, moules ou matrices), ceux-ci nous seront envoyés gratuitement. Notre responsabilité en ce qui concerne leur disparition, leur dégradation ou leur réexpédition incomplète et les dommages en résultant ne pourra être engagée qu'en cas de négligence grave ou de faute intentionnelle. La présente clause ne s'appliquera pas si la responsabilité est obligatoire de par la loi.
 - 11.2 Lorsque l'acheteur nous chargera de fabriquer ou d'acheter des moyens (outils) de fabrication, une part des coûts en résultant lui seront facturés séparément. Il en ira de même pour les pièces coulées et pour les outillages complémentaires. Dans le cas où un outil ne serait pas utilisé, l'acheteur prendra à sa charge les coûts non couverts et les coûts des divers équipements spécifiques. Les coûts des modèles seront toujours intégralement à la charge de l'acheteur. Les moyens de fabrication resteront notre propriété. Nous ne serons pas tenus de les restituer à l'acheteur. Il en ira de même des outillages complémentaires.
 - 11.3 La transmission à des tiers des dessins (schémas) et des documents que nous remettons à l'acheteur, ainsi que de nos propositions visant à une meilleure conception et de celles concernant la fabrication des pièces n'est pas autorisée et nous serons en droit d'exiger leur restitution à tout moment.
12. **Lieu d'exécution, juridiction compétente, droit applicable**
 - 12.1 Le lieu d'exécution des obligations de paiement de l'acheteur est Neckarsulm. Le lieu d'exécution de nos propres obligations est le site de l'usine / de l'entrepôt de livraison.
 - 12.2 Tribunal compétent : Heilbronn. Nous sommes également autorisés à assigner l'acheteur devant les tribunaux auxquels il est rattaché en général.
 - 12.3 Toutes les relations de droit entre l'acheteur et notre Société sont soumises exclusivement au droit matériel de la République fédérale d'Allemagne, sans recours au droit relatif aux conflits de lois ; la Convention des Nations Unies en matière de contrats pour le commerce international des biens (CISG) n'est pas applicable. La version en vigueur des INCOTERMS sera utilisée pour l'interprétation des clauses relatives à la livraison.

13. Nullité partielle

La nullité juridique de certaines des clauses des présentes Conditions de Vente et de Livraison n'affectera pas les autres clauses qui demeureront pleinement valides et applicables.

14. Enregistrement des données

Les données nécessaires au suivi des affaires sont enregistrées et, dans le cadre du traitement des commandes, éventuellement transmises à des tiers. Toutes les données personnelles sont, bien entendu, traitées sous le sceau de la confidentialité, conformément aux dispositions de la Loi allemande Informatique et Libertés.

Condiciones de venta y entrega

1. **Adjudicación del pedido, condiciones especiales**
 - 1.1 Los suministros y la prestación de servicios se efectúan exclusivamente conforme a las condiciones relacionadas a continuación, y conforme a las condiciones especiales comunicadas al comprador.
 - 1.2 Las condiciones generales expresadas por el comprador serán válidas sólo en caso de confirmación expresa por escrito. Ni la omisión de oposición ni la ejecución del suministro o la prestación de servicios constituyen una aceptación de condiciones comerciales de terceros.
2. **Oferta y documentación referente a la oferta**
 - 2.1 En tanto no se exprese lo contrario en la confirmación de pedido, nuestra oferta es sin compromiso.
 - 2.2 Nos reservamos derechos de propiedad y de autor respecto a ilustraciones, dibujos y demás documentos entregados al comprador, que no deberán emplearse para fines diferentes de los indicados por el proveedor, ni podrán ser entregados ni hechos accesibles a terceros. Lo anterior vale sólo para toda documentación escrita, marcada como "confidencial". Antes de entregar dicha documentación a terceros, el comprador deberá obtener nuestra autorización expresa, por escrito.
 - 2.3 Los datos en ilustraciones, dibujos, catálogos y demás documentos son sin compromiso.
 - 2.4 Para el contenido y el alcance del contrato de suministro es determinante nuestra confirmación del pedido por escrito. Para la comunicación por teletransmisión de datos bastará la forma escrita.
3. **Precios**
 - 3.1 Nuestros precios se entienden franco fábrica/almacén, sin el embalaje, más el impuesto sobre el valor añadido (IVA) vigente en cada caso en el momento de la facturación.
 - 3.2 Nos reservamos el derecho de modificar los precios si, después de concluido el contrato, se producen disminuciones o incrementos de los costes, debidos especialmente a convenios colectivos o modificaciones en los precios de los materiales. Dichas modificaciones podrán ser acreditadas ante el comprador, si así lo solicita.
4. **Entrega**
 - 4.1 El cumplimiento de los plazos acordados para las entregas presupone el recibo a tiempo oportuno de toda la documentación a proporcionar por el comprador, los permisos y autorizaciones necesarios, sobre todo en lo que concierne a planos, así como la observancia por parte del comprador de las condiciones de pago acordadas y demás obligaciones que le correspondan. Si dichas condiciones no son cumplidas a su debido tiempo, se prolongarán de forma adecuada los plazos del proveedor; lo anterior no es aplicable si la demora es atribuible al proveedor.
 - 4.2 Casos de fuerza mayor, huelgas u otros conflictos laborales, disturbios, medidas tomadas por las autoridades, carencia de suministros a recibir de nuestros subproveedores y demás sucesos imprevisibles, inevitables y graves exoneran a las partes contratantes de sus obligaciones de entrega por el plazo y en la medida en que tales perturbaciones influyan en el proceso. Lo anterior vale también si dichos sucesos se producen en un momento en que la parte contratante afectada se encuentre en demora. Dentro del marco de lo exigible, las partes contratantes se comprometen a proporcionar sin demora las informaciones necesarias y a adaptar sus obligaciones, de buena fe, a las nuevas circunstancias.
 - 4.3 Quedan excluidos los derechos de indemnización por daños y perjuicios del comprador frente a nosotros por demora de la prestación en todos los casos de demora en la entrega, también después de la expiración de un plazo que nos haya sido impuesto eventualmente para la entrega. Esto no será válido en casos de responsabilidad forzosa por conducta dolosa o negligencia grave o en lo que concierne a daños personales que afecten a la integridad física y la salud; ello no supone una modificación del mérito probatorio en perjuicio del comprador. El derecho legal de rescisión del contrato por parte del comprador no se ve afectado. El comprador sólo podrá rescindir el contrato en el marco de las disposiciones legales en caso que la demora en la entrega nos sea imputable.
 - 4.4 Se permiten las entregas parciales. En caso de demora de una entrega parcial, el comprador no podrá hacer valer derechos respecto a la cantidad restante, a menos que el cumplimiento parcial carezca de interés para él.
 - 4.5 A menos que, en ciertos casos, se haya convenido otra cosa, los suministros se efectúan franco fábrica/almacén. En el momento en que se comunica al comprador que la mercancía está lista para el envío, o a más tardar cuando la mercancía salga de la fábrica/del almacén, el riesgo pasa al comprador. Lo anterior rige también cuando el proveedor se encarga de efectuar el transporte. Un seguro de transporte se suscribe sólo por convenio especial, y por cuenta del comprador.
 - 4.6 No se aceptará la devolución de embalajes de transporte y demás embalajes no retornables. El comprador está obligado a proveer la eliminación de los embalajes por cuenta propia.
5. **Abastecimiento propio**

En caso de falta de abastecimiento propio correcto o en tiempo oportuno por parte del presuministrador debido a causas que no sean imputables al proveedor, éste estará autorizado a aplazar y/o a anular la obligación de suministro correspondiente.
6. **Garantía / responsabilidad debida a defectos materiales**
 - 6.1 El comprador deberá examinar la mercancía inmediatamente al recibirla, reclamando sin dilación por escrito cualquier defecto detectado. Los defectos ocultos deberán ser comunicados sin dilación alguna tan pronto se descubran.
 - 6.2 La mercancía defectuosa no deberá ser utilizada en tanto no se aclare la reclamación. Deberá concederse al proveedor oportunidad para examinar sobre el terreno los defectos reclamados. Asimismo, si el proveedor así lo solicita, deberá devuelta la mercancía objeto del reclamo.
 - 6.3 Las muestras de la mercancía entregadas al comprador son muestras de orientación o muestras de prueba. En todo caso, con su entrega el proveedor quedará autorizado, ahora como antes, a efectuar el suministro conforme a las tolerancias usuales en el mercado.
 - 6.4 En caso de defectos materiales eliminaremos el defecto o suministraremos una mercancía libre de defectos, a nuestra elección, siempre y cuando el defecto material existiese en el momento de la transferencia de riesgos. Si el cumplimiento posterior fracasara, el comprador podrá – sin perjuicio de eventuales derechos de indemnización por daños y perjuicios según el numeral 9 – reducir el pago o rescindir el contrato. Están excluidos derechos de indemnización del comprador relacionados con gastos necesarios debido al cumplimiento posterior, en particular gastos de transporte, desplazamientos, mano de obra y material, en tanto los costes aumenten debido a que el objeto del suministro ha sido llevado posteriormente a un lugar distinto al de la sede del comprador, a no ser que el traslado responda a su uso previsto.
 - 6.5 Sólo existen derechos legales de regreso del comprador según la legislación alemana, art. 478 y 479 del código civil alemán, en tanto el comprador no haya establecido con su cliente ningún acuerdo que rebase los límites de los derechos de reclamación por defectos fijados por la ley. Además, el comprador sólo tiene derechos de regreso frente a nosotros hasta el importe correspondiente al precio de compra.
 - 6.6 No se generarán derechos del comprador por defectos materiales si el defecto se debe al incumplimiento de prescripciones para el manejo, mantenimiento y montaje, a utilización inadecuada o indebida, al uso erróneo o negligente y a desgaste natural, así como a manipulaciones realizadas por el comprador o por terceros en la mercancía.
 - 6.7 Los derechos de reclamación por defectos caducan a los 24 meses, a contar desde el momento del traspaso del riesgo.
 - 6.8 A petición nuestra y a nuestro cargo se pondrán a nuestra disposición sin dilación las piezas defectuosas.
7. **Condiciones de pago**
 - 7.1 A menos que se haya convenido otra cosa, nuestras facturas serán pagadas sin descuento a la recepción de las mismas.
 - 7.2 Si el comprador se retrasa en el pago, estaremos autorizados a facturar intereses de demora por valor del 8% sobre el tipo básico de interés.
 - 7.3 El comprador sólo podrá hacer valer derechos compensatorios cuando sus contrapretensiones hayan adquirido firmeza legal o hayan sido reconocidas por el proveedor. Podrá, además, ejercitar su derecho de retención en tanto su contrapretensión resulte de la misma relación contractual.
 - 7.4 Si hay varias facturas o créditos pendientes, el proveedor tendrá derecho a determinar el orden de la amortización, a pesar de una estipulación discrepante por parte del cliente.
 - 7.5 Si después de la conclusión del contrato llegan a nuestro conocimiento circunstancias que pongan en duda la solvencia del comprador sobre la base de criterios aplicados usualmente por el sector bancario, o si el comprador se demora en el pago conforme a los plazos convenidos, tras expirar una prórroga razonable podremos hacer depender la ejecución de suministros pendientes de un pago por adelantado o de la prestación de garantías.
8. **Reserva de dominio**
 - 8.1 La mercancía suministrada quedará propiedad del proveedor hasta que se hayan cumplido todas las pretensiones actuales resultantes de la relación comercial existente entre el comprador y nuestra empresa (mercancía bajo reserva de dominio). En caso de iniciación de un proceso de insolvencia relativo al patrimonio del comprador, nos reservamos el derecho de rescisión. En caso de incumplimiento del contrato por parte del comprador, y en especial en caso de retraso en el pago, el proveedor tendrá derecho a rescindir el contrato y a retirar la mercancía; el comprador está obligado a su entrega. La retirada de la mercancía o respectivamente la reivindicación de la reserva de dominio hecha por el proveedor no exige rescisión del contrato por nuestra parte. Estos actos o una pignoración por nuestra parte de la mercancía sujeta a reserva de dominio no significa rescisión del contrato por nuestra parte, a no ser que lo hayamos declarado así expresamente.
 - 8.2 El comprador está obligado a marcar y a almacenar por separado la mercancía bajo reserva. Se obliga, además, a tratar dicha mercancía con el debido cuidado. En especial, queda obligado a asegurarla a su cargo contra incendios, daños causados por el agua y contra robo por el valor de nuevo. En tanto sean

- 8.3 necesarios trabajos de mantenimiento e inspección, el comprador deberá efectuarlos oportunamente, por su propia cuenta y a su cargo.
- 8.4 El comprador no podrá pignorar ni transferir a título de garantía la mercancía bajo reserva de dominio. El comprador deberá comunicar al proveedor, sin dilación alguna, cualquier caso de embargo, prendaciones o demás actos de disposición o intervenciones de terceros.
- 8.5 El comprador podrá revender la mercancía bajo reserva de dominio dentro del marco de las prácticas comerciales reglamentarias. No obstante, desde este momento cederá a favor del proveedor todos los cobros pendientes por el valor del importe final de la factura equivalente a nuestro crédito, resultante de la enajenación frente a adquirentes o terceros, independientemente de si la mercancía bajo reserva de dominio sea vendida antes o después de haber sido transformada. El comprador quedará facultado para recaudar esta deuda incluso después de la cesión, sin perjuicio de nuestro derecho a cobrar nosotros mismos la deuda. Nos obligamos a no cobrar la deuda en tanto el comprador satisfaga sus obligaciones de pago resultantes de los ingresos, no se retrase en el pago, no se haya solicitado la apertura de un proceso de insolvencia o no haya sido declarada una suspensión de pagos. En todos estos casos podremos exigir que el comprador nos informe de las cesiones de créditos con indicación de los deudores, nos comunique todos los datos necesarios para el cobro, nos entregue todos los documentos relacionados con los mismos e informe a los deudores (terceros) de la cesión.
- 8.6 El comprador manipulará o transformará para nosotros la mercancía bajo reserva de dominio, sin que por ello emane ninguna obligación para nosotros. Si el comprador combina, mezcla, incorpora o transforma nuestras mercancías bajo reserva de dominio, adquiriremos la copropiedad del nuevo objeto, en relación al valor de la mercancía bajo reserva (importe final de la factura) respecto a los demás objetos combinados, mezclados, incorporados o transformados, en el momento en que se haya efectuado la transformación, la incorporación, la mezcla o la combinación. Sobre el objeto logrado mediante la transformación o incorporación rige, además, lo mismo que para la mercancía suministrada bajo reserva. En caso que la mezcla o incorporación sea efectuada de forma que el objeto del comprador se considere como objeto principal, se acuerda desde ahora que el comprador nos transferirá la copropiedad de forma proporcional. El comprador se encargará de custodiar para nosotros la propiedad exclusiva o la copropiedad.
- 8.7 En caso que el valor de las garantías entregadas exceda del valor de nuestros créditos en total en más de un 20%, a solicitud del comprador quedaremos obligados a liberar, a nuestra elección, el exceso de las garantías.
- 8.8 En la medida que el registro y/o el cumplimiento de otras exigencias sea requisito para la efectividad de la reserva de dominio, el comprador se obligará a emprender y a efectuar inmediatamente y por su propia cuenta todas las acciones y comunicaciones necesarias. En caso que la legislación vigente no permita el acuerdo de reserva de dominio, el comprador proporcionará al proveedor otras garantías adecuadas al utilizar créditos comerciales.
9. **Otros derechos de indemnización por daños y perjuicios**
 - 9.1 Quedan excluidas las pretensiones de indemnización por daños y perjuicios del comprador, sea cual fuere su causa justificativa, y en especial por infracción de obligaciones emanadas del derecho de crédito o de acción ilícita.
 - 9.2 Lo anterior no vale en caso de responsabilidad forzosa, por ejemplo en relación con la ley de responsabilidad debida a productos defectuosos, en casos de dolo o negligencia grave, de lesiones físicas y perjuicios para la salud o por incumplimiento de obligaciones importantes establecidas por el contrato. El derecho a indemnización por daños y perjuicios derivado de infracciones importantes del contrato se limita, sin embargo, a daños típicos del contrato y previsible, en tanto no se nos pueda atribuir ningún incumplimiento doloso o gravemente negligente del contrato o exista la responsabilidad por daños para la integridad física y la salud. Las anteriores reglamentaciones no suponen modificación del mérito probatorio en perjuicio del comprador.
 - 9.3 En tanto correspondan al comprador derechos de indemnización conforme al presente numeral 9, los mismos caducarán al expirar el plazo de validez para derechos de indemnización por defectos materiales estipulado en 6.7, siempre y cuando ello no se oponga a disposiciones legales de obligado cumplimiento. La exclusión o la limitación de la responsabilidad por daños y perjuicios respecto al proveedor vale también en lo relativo a responsabilidad personal por daños y perjuicios imputable a nuestros empleados, representantes y auxiliares ejecutivos.
10. **Derechos de terceros**
 - 10.1 En caso que una tercera persona formule contra el comprador reclamaciones justificadas debido a violación de un derecho de propiedad industrial o de un derecho intelectual (derechos protegidos) ocasionada por los productos que hemos suministrado y que hayan sido utilizados conforme a las estipulaciones del contrato, responderemos frente al comprador de la forma relacionada a continuación:
 - 10.1.1 Podremos elegir entre obtener, por nuestra cuenta, un derecho de uso para el producto, o bien modificarlo de forma que no ocasione violación del derecho protegido, o bien sustituir el producto. Si ello fuera imposible en condiciones razonables, readmitiremos el producto contra reembolso del precio de compra.
 - 10.1.2 Las obligaciones arriba mencionadas del proveedor sólo existen cuando el comprador nos haya notificado por escrito y sin dilación alguna las reclamaciones formuladas por un tercero, no haya admitido la violación y nos queden reservadas todas las medidas de defensa y los actos transaccionales. En caso que el comprador, por motivos referentes a disminuir daños, o por otros motivos importantes, renuncie a la utilización del producto, quedará obligado a indicar frente al tercero que la renuncia a la utilización no supone ningún reconocimiento de una violación de un derecho protegido.
 - 10.2 Quedan excluidas las pretensiones del comprador en tanto le sea imputable la violación del derecho protegido o en tanto las violaciones de dicho derecho hayan sido ocasionadas o por indicaciones específicas del comprador o por una aplicación no previsible por nosotros, o que hayan sido ocasionadas por el hecho de que el comprador haya modificado el producto o lo haya utilizado junto con otros productos diferentes de los que le hemos suministrado.
 - 10.3 En lo referente a los casos enunciados en el numeral 10.2, el comprador se obliga a eximirnos de las reclamaciones de terceros.
 - 10.4 Quedan excluidas todas las demás pretensiones contra nosotros; asimismo queda intacto el numeral 9 (Otros derechos de indemnización por daños y perjuicios), al igual que el derecho del comprador a rescisión del contrato.
 - 10.5 En caso de existir cualesquiera otros defectos de índole jurídica, rige lo dispuesto en el numeral 6.
11. **Elementos de producción, herramientas, moldes**
 - 11.1 En caso que el comprador nos suministre elementos de producción (tales como herramientas, coquillas, moldes o matrices), dichos elementos nos deberán ser enviados sin coste alguno para nosotros. No asumiremos ninguna responsabilidad por pérdida, desgaste, deterioro o devolución incompleta y los daños resultantes de la misma. Asumiremos responsabilidad sólo en caso de negligencia grave o dolo. Lo anterior no rige en caso de responsabilidad forzosa prescrita por la ley.
 - 11.2 En caso de fabricación o adquisición de elementos de producción por encargo del comprador, los costes se facturarán aparte y de forma proporcional; en caso de piezas de fundición, también para útiles sucesionales. Si uno de dichos útiles no fuera utilizado, el comprador asumirá los gastos no cubiertos, incluso de los demás dispositivos a ello vinculados. En todo caso, los costes de los modelos o prototipos correrán, en su totalidad, de cuenta del comprador. El proveedor conservará plena propiedad de los elementos de fabricación, sin que exista ninguna obligación de entregarlos al comprador. Lo anterior se aplica también a los útiles sucesionales.
 - 11.3 Queda prohibido entregar a terceros los dibujos y la documentación entregada al comprador, así como las propuestas hechas por el proveedor para el desarrollo adecuada y la fabricación de las piezas; el proveedor tendrá derecho a exigir la devolución de la documentación en todo momento.
12. **Lugar de cumplimiento, jurisdicción, derecho aplicable**
 - 12.1 El lugar de cumplimiento para la obligación de pago contraída por el comprador es Neckarsulm; para las obligaciones contraídas por nosotros, el lugar de cumplimiento es el lugar donde está ubicada nuestra fábrica/almacén de suministro.
 - 12.2 Lugar de jurisdicción es Heilbronn. Sin embargo, el proveedor podrá recurrir también a los Tribunales del domicilio social del comprador.
 - 12.3 Para todas las relaciones jurídicas entre el comprador y nosotros será de aplicación el derecho material de la República Federal de Alemania, con exclusión del derecho de colisión; no encuentra aplicación el acuerdo de las Naciones Unidas sobre Contratos referentes a la Compra Internacional de Mercancías (CISG). Para la interpretación de las cláusulas sobre entrega rigen los INCOTERMS vigentes en cada momento.
 - 12.4 Los términos y condiciones aquí descritos han sido preparados y proporcionados en lengua española solamente para la conveniencia de las partes. La versión en lengua alemana de estos es definitiva, en caso de existir alguna inconsistencia en los diferentes significados entre la versión en lengua española y la versión en lengua alemana, la versión en lengua alemana prevalecerá sobre la versión española excluyéndola.
13. **Nulidad parcial**

La nulidad legal de una o más disposiciones de estas condiciones no afecta la validez de las disposiciones restantes.
14. **Almacenamiento de datos**

Los datos necesarios para la realización de la operación serán almacenados y comunicados a terceros en el marco de la tramitación del pedido, en caso necesario. Todos los datos referidos a personas recibirán naturalmente un trato confidencial de conformidad con lo dictado por las leyes concernientes a la protección de datos personales.

Условия продажи и поставки

1. Предоставление заказа: особые условия

1.1 Мы осуществляем поставки и предоставляем свои услуги исключительно на нижеследующих условиях и возможных особых условиях, с которыми заказчик будет ознакомлен.

1.2 Общие условия заказчика действуют только в случае однозначного письменного подтверждения. Ни отсутствие возражения с нашей стороны, ни выполнение поставок или предоставление услуг не являются признанием сторонних условий заключения коммерческих сделок.

2. Предложение: тендерные документы

2.1 Наше предложение является свободным от обязательств, если противное не вытекает из подтверждения заказа.

2.2 Мы сохраняем за собой право собственности и авторские права на рисунки, чертежи и других документы, предоставляемые заказчику. Заказчик не имеет права использовать их в любых целях, кроме указанных нами, и предоставлять доступ к ним третьим лицам. Это особенно касается письменных документов с пометкой «секретно». Для передачи таких документов третьим лицам заказчику требуется наше однозначное письменное согласие.

2.3 Все данные, содержащиеся в каталогах, иллюстрациях, чертежах и прочих документах, являются свободными от обязательств.

2.4 В отношении содержания и объема договора поставки определяющим является наше письменное подтверждение заказа. При этом письменный договор действителен даже в том случае, если он был передан при помощи средств телекоммуникации.

3. Цены

3.1 Цена товара определяется стоимостью товара, установленной заводом или складом, стоимостью упаковки и действующим на момент выставления счета налогом на добавленную стоимость (НДС), установленным законом.

3.2 Мы сохраняем за собой право на изменение цен в связи со снижением или увеличением издержек после заключения договора, в частности, в связи с вступлением в силу тарифных соглашений или изменением цен на материалы. Соответствующие доказательства будут предоставлены по требованию заказчика.

4. Поставка

4.1 Соблюдение договорных сроков поставок предполагает своевременное поступление всех предоставляемых заказчиком документов, необходимых разрешений и подтверждений, в частности, подтверждений расчетов, а также соблюдение заказчиком договорных условий платежа и прочих обязательств. При невыполнении данных условий сроки поставки будут продлены соответствующим образом. Данное положение не действует в случаях, когда задержка происходит по нашей вине.

4.2 Форс-мажорные обстоятельства, забастовки, беспорядки, административные меры, отсутствие поставки товара субпоставщиками и прочие непредвиденные, неотвратимые и весомые обстоятельства освобождают стороны договора от выполнения своих обязательств на срок действия препятствующих обстоятельств события и в объеме их действия. Данное положение не действительно, если такие обстоятельства наступают в тот момент времени, когда сторона договора, пострадавшая от их действия, уже просрочила выполнение своих обязательств. Стороны договора обязаны по возможности незамедлительно предоставить необходимую информацию и согласовать свои обязательства с учетом изменившихся обстоятельств в соответствии с торговыми традициями.

4.3 Требования заказчика о возмещении ущерба в связи с задержкой выполнения поставки, в том числе по истечению назначенного нам срока поставки, не рассматриваются. Данное положение не действительно в случае умышленного нанесения вреда или преступной небрежности. За причинение ущерба жизни и здоровью и нанесение телесных повреждений предусматривается обязательная ответственность, не влекущая за собой изменение бремени доказывания не в пользу заказчика. Установленное законом право заказчика на отказ от договора сохраняется. В рамках существующего законодательства заказчик может отказаться от договора только в том случае, если задержка поставки произошла по нашей вине.

4.4 Допускается осуществление частичных поставок. При задержке частичной поставки заказчик не может предъявлять права в отношении остальной части поставки за исключением тех случаев, когда частичная поставка не представляет для него интереса.

4.5 Поставки осуществляются с завода или склада поставщика, если иное не было оговорено отдельно. Риск утраты или повреждения товара переходит на заказчика с момента уведомления о готовности к отгрузке и не позднее момента вывоза товара за пределы завода или склада. Данное положение действительно и в том случае, если транспортировку осуществляем мы. Транспортированное страхование осуществляется только на основании отдельного соглашения за счет заказчика.

4.6 Разовая тара назад не принимается. Заказчик обязан утилизировать ее за собственный счет.

5. Поставка товаров субпоставщиками

Мы имеем право на отсрочку и/или отмену выполнения обязательств по поставкам в случае несвоевременной или неправильной поставки товара субпоставщиками без нашей вины.

6. Ответственность за дефекты, обнаруженные в товаре

6.1 После получения товара заказчик обязан незамедлительно осмотреть товар на предмет наличия дефектов и заявить о них в письменном виде. Заказчик должен подать письменное заявление о скрытых дефектах непосредственно после их обнаружения.

6.2 До принятия решения относительно предъявленной рекламации рекламационный товар не разрешается подвергать дальнейшей обработке. Нам должна быть предоставлена возможность проверить рекламационный товар на месте. Тем не менее, заказчик обязан передать нам рекламационный товар по требованию.

6.3 Образцы товара предоставляются заказчику для его информирования и ознакомления с товаром. Их предоставление не отнимает у нас право на поставку в соответствии с принципами терпимости, принятыми в торговых отношениях.

6.4 В случае обнаружения дефектов товара мы, по своему усмотрению, либо устраним дефект, либо заменим его товаром, не имеющим дефектов, если повреждение товара произошло до момента перехода рисков. Если устранить дефекты или заменить товар не возможно, заказчик имеет право – несмотря на пункт 9, описывающий возможные претензии на возмещение ущерба – уменьшить оплату за товар или отказаться от договора. Требования на возмещение издержек, связанных с устранением дефекта или заменой товара, в частности, транспортные, дорожные расходы, стоимость рабочей силы и сырья и материалов, исключены, если повышение издержек связано с перевозкой товара в иное место, чем местонахождение заказчика, за исключением тех случаев, когда такая перевозка связана с применением товара по назначению.

6.5 Заказчик имеет законное право предъявить регрессный иск на основании статей 478 и 479 4 ГК только в том случае, если заказчик не заключил со своим покупателем соглашений, выходящих за рамки законных претензий по качеству. Размер регрессных требований заказчика к нам не может превышать покупной цены товара.

6.6 Претензии по качеству не могут предъявляться в том случае, если дефект вызван нарушением рекомендаций по эксплуатации, техническому обслуживанию и монтажу, неподходящим или некавалифицированным применением, неправильным или небрежным обращением и естественным износом, а также вмешательством заказчика или третьих лиц в предмет поставки.

6.7 Срок предъявления претензий по качеству составляет 24 месяца начиная с даты перехода рисков.

6.8 Дефектные детали должны быть возвращены нам по требованию. При этом заказчик не несет расходов.

7. Условия оплаты

7.1 При отсутствии особой договоренности наши счета подлежат полной оплате при получении товара.

7.2 При задержании оплаты заказчиком мы имеем право начислить пени за просрочку в размере 8 % сверх базовой процентной ставки.

7.3 Право на взаимный зачет встречных требований заказчик имеет только тогда, когда его встречные требования установлены в законном порядке или признаны нами. Кроме того, данное право действительно только в том случае, если встречное требование заказчика основывается том же договорном отношении.

7.4 При наличии нескольких непоплаченных счетов или долговых обязательств мы, несмотря на возможное отличие от нашего желания заказчика, имеем право определять последовательность оплаты.

7.5 Если после заключения договора нам станут известны обстоятельства, вызывающие (на основе общепринятых банковских критериев) сомнения в платежеспособности заказчика, или если заказчик не произведет платежей в течение договорных сроков, после безрезультатного истечения уместного дополнительного срока мы имеем право производить невыполненные поставки или выполнять гарантийные обязательства только после предварительной оплаты.

8. Оговорка о сохранении права собственности на товар до полной оплаты его стоимости

8.1 Поставленный товар остается нашей собственностью до выполнения всех действующих требований и деловых отношениях между заказчиком и нами (товар с оговоркой о сохранении права собственности на товар до полной оплаты его стоимости). В случае возбуждения дела о неплатежеспособности заказчика мы сохраняем за собой право на отказ от договора. В случае нарушений обязательств заказчика, в частности, при просрочке платежа, мы имеем право на отказ от договора и возврат товара; при этом заказчик обязан выдать товар. Возврат товара или сохранение права собственности на товар до полной оплаты его стоимости не требует с нашей стороны отказа от договора. Данные действия и наложение ареста на товар, в отношении которого применено положение о сохранении права собственности до полной оплаты, не означают отказа от договора, если противное не было однозначно объявлено нами.

8.2 Заказчик обязан отдельно хранить и обозначать товар, являющийся собственностью продавца до полной оплаты его стоимости. Заказчик обязан аккуратно обращаться с таким товаром; в частности, он обязан застраховать его за собственный счет от ущерба в результате пожара, наводнения и кражи на сумму восстановительной стоимости товара. Технический осмотр и обслуживание товара должно производиться своевременно за счет заказчика.

8.3 Заказчик не имеет права ни отдавать в залог, ни передавать другому лицу в качестве гарантии право собственности на товар, являющийся собственностью продавца до полной оплаты его стоимости. В случае ареста, конфискации или прочих распоряжений или вмешательства третьих лиц заказчик должен незамедлительно поставить нас в известность.

8.4 Заказчик имеет право продавать дальше в надлежащем порядке товар, являющийся собственностью продавца до полной оплаты его стоимости; однако при этом он уступает нас все требования (в размере конечной суммы нашего требования), которые возникают из перепродажи по отношению к его покупателям или третьим лицам, независимо от того, продан ли такой товар без переработки или после нее. После уступки заказчик сохраняет право на взыскание этого требования. Это не затрагивает наше право самим взыскивать это требование. Мы обязуемся не взыскивать это требование до тех пор, пока заказчик выполняет свои обязательства по платежам из полученных доходов, не просрочивает платежи, не подав заявление о неплатежеспособности или не наблюдается прекращение платежей. Во всех вышеперечисленных случаях мы имеем право требовать предоставления сведений обо всех требованиях и должниках, а также других сведений, необходимых для взыскания, а также передачи соответствующих документов и информирования должников (третьих лиц) об уступке права требования.

8.5 Заказчик осуществляет по нашему требованию переработку или обработку товара, являющегося нашей собственностью до полной оплаты стоимости, что не влечет за собой дополнительных обязательств с нашей стороны. При соединении, смешении, перемонировании или переработке товара, являющегося нашей собственностью до полной оплаты стоимости, мы приобретаем право долевой собственности на новое имущество в пропорции, равной отношению стоимости товара, являющегося нашей собственностью до полной оплаты стоимости (конечная сумма счета), к стоимости других переработанных, смешанных или соединенных товаров на момент переработки, смешивания или соединения. В отношении имущества, возникшего в результате переработки или соединения, в остальном действует то же положение, что и в отношении товара, поставленного с оговоркой о сохранении продавцом права собственности на товар до полной оплаты его стоимости. Если смешивание происходит таким образом, что имущество заказчика можно рассматривать как основное, то передача нам права долевой собственности считается согласованной. Заказчик хранит для нас возникшую таким образом единоличную или долевую собственность.

8.6 Если стоимость предоставленной нам гарантии превышает стоимость наших требований в общем на более чем 20 %, то мы можем по требованию заказчика уменьшить чрезмерную сумму гарантии. При этом право принятия такого решения остается за нами.

8.7 Если условием действительности оговорки о сохранении продавцом права собственности на товар до полной оплаты его стоимости является регистрация и/или выполнение иных требований, то заказчик обязан за свой счет незамедлительно предпринять все необходимые для этого действия и сделать все необходимые сообщения. Если совокупность важных правовых норм не допускает договоренности о сохранении за продавцом права собственности на товар до полной оплаты его стоимости, заказчик обязан предоставить нам другие уместные гарантии при получении товарного кредита.

9. Прочие требования о возмещении ущерба

9.1 Требования заказчика о возмещении ущерба, не зависимо от их правового основания, в частности, в связи с нарушением обязательств, вытекающих из правовых отношений между кредитором и должником или другим недозволенным действием, исключаются.

9.2 Данное положение не действительно, если за такие действия законом устанавливается обязательная ответственность, например, в соответствии с законом о качестве продукции, в случае умышленного нанесения вреда или преступной небрежности, за причинение ущерба жизни и здоровью, нанесение телесных повреждений, за нарушение важных договорных обязательств. Требование о возмещении ущерба за нарушение важных договорных обязательств ограничивается, однако, обычным для договоров предвидимым ущербом, кроме тех случаев, когда имеет место умышленное нанесение вреда или преступная небрежность, или установлена ответственность за причинение ущерба жизни и здоровью, а также нанесение телесных повреждений. Изменение бремени доказывания не в пользу заказчика с вышеперечисленными условиями не связано.

9.3 Заказчик теряет право на предъявление требований на основании настоящего раздела 9, по истечению действующего в отношении претензий по качеству срока давности, указанному в разделе 6.7, если это не противоречит положениям действующего законодательства.

9.4 Насколько наша ответственность по возмещению ущерба исключена или ограничена, настолько данное положение это относится и к личной ответственности наших сотрудников, представителей и доверенных лиц.

10. Права третьих лиц

10.1 Если третье лицо выставляет заказчику справедливую претензию в связи с нарушением его прав на промышленную собственность или авторских прав (права на защиту результатов умственного труда) поставленным нами и используемым в соответствии с договором товаром, то мы несем следующую ответственность перед заказчиком.

10.1.1 Мы по собственному выбору за свой счет либо приобретем право использования товара, либо изменим товар таким образом, что право на промышленную собственность не будет нарушено, либо заменим товар. Если это не будет возможно на разумных условиях, мы обязаны забрать продукт назад с возмещением продажной цены.

10.1.2 Вышеизложенные обязательства действительны только в том случае, если заказчик незамедлительно письменно уведомляет нас о предъявленных к нему третьим лицом требованиям, не признает нарушения и сохраняет за нами право на принятие всех мер по защите прав и проведение переговоров с целью достижения мирового соглашения. Если заказчик приостанавливает использование продукта с целью ограничения ущерба или по другим важным причинам, он обязан указать третьему лицу на то, что приостановка использования не связана с признанием нарушения его прав на промышленную собственность.

10.2 Требования заказчика исключены, если нарушение прав на промышленную собственность произошло по его вине или если эти нарушения вызваны выполнением заказчиком государственного задания, непредвиденным нами использованием товара, изменением товара заказчиком или использованием его совместно с товарами, которые не были предоставлены нами.

10.3 В случаях, указанных в пункте 10.2, заказчик освобождает нас от требований со стороны третьих лиц.

10.4 Более широкие требования к нам исключаются. Тем не менее, данное положение не влияет ни на пункт 9 («Прочие требования о возмещении ущерба»), ни на право заказчика на отказ от договора.

10.5 При наличии прочих правовых расхождений действуют положения, указанные в разделе 6.

11. Технологическая оснастка, инструменты, формовочный инструмент

11.1 Если заказчик предоставляет в наше распоряжение технологическую оснастку (например, инструменты, кокилы, формы или штампы), то они должны поставяться бесплатно. Мы не берем на себя ответственность за их поломку, ухудшение или неполный возврат и вытекающий из этого ущерб (за исключением случаев преступной небрежности или умышленного нанесения вреда). Данное положение не действует, если законом устанавливается обязательная ответственность.

11.2 Когда технологическая оснастка изготавливается или приобретается нами по поручению заказчика, то мы включаем в счет соответствующие издержки, в случае отливки – и на инструмент второго поколения. При неполном использовании инструмента заказчик берет на себя непокрытые издержки, в том числе и на прочие типизированные устройства. Издержки на модели всегда покрываются в полном объеме за счет заказчика. Технологическая оснастка остается нашей собственностью. Мы не обязаны выдавать ее заказчику. Это относится также к инструментам второго поколения.

11.3 Заказчик не имеет права передавать третьим лицам выданные чертежи и документы, а также сообщать о наших предложениях о выгодном конструировании и изготовлении деталей. Данные чертежи и документы могут быть затребованы нами назад в любое время.

12. Место исполнения, разрешения возникающих споров, применимое право

12.1 Местом исполнения платежного обязательства заказчика является Неккарзальм, для наших обязательств – местонахождение завода или склада поставщика.

12.2 Все возникающие по данному договору споры будут рассматриваться в г. Хайльбронн. Мы имеем также право предъявить иск к заказчику и по месту его подданности.

12.3 Все правоотношения между заказчиком и нами регулируются исключительно имущественным правом Федеративной Республики Германии за исключением коллизионного права; конвенция ООН о контрактах о международной торговле товарами (CISG) не действует. Для толкования условий поставки используются формы торговых условий INCOTERMS в действующей редакции.

12.4 Частичная недействительность отдельных положений договора не затрагивает действительность остальных положений.

14. Запись данных

Данные, необходимые для осуществления сделки, будут записываться и при необходимости передаваться третьим лицам в рамках выполнения заказа. В соответствии с положениями федерального закона о защите информации будет соблюдаться конфиденциальность личных данных.

Условия продажи и поставки фирмы «MS Motor Service International GmbH», состояние на 01/2003

¹ CISG = Convention on Contracts for the International Sale of Goods = Конвенция о контрактах о международной торговле товарами



MOTOR SERVICE

MS Motor Service International GmbH
Wilhelm-Maybach-Straße 14-18
74196 Neuenstadt, Germany
Phone +49 7139 9376-3333
Fax +49 7139 9376-2864
info@ms-motor-service.com

www.ms-motor-service.com



ALWAYS AT
YOUR SERVICE!



MOTORMAN



50 003 865 06/09



4 028977 007859

