

Product Catalogue

The Bus Catalogue 2008/2009

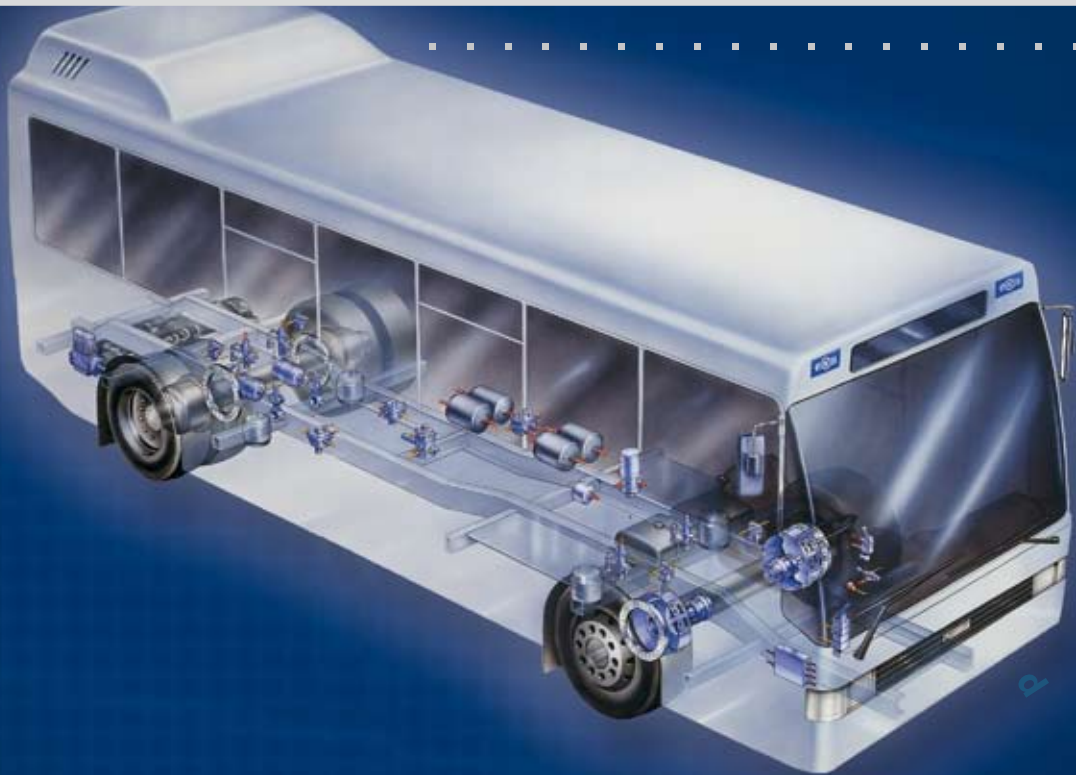

- Braking System Components
- Air Suspension System Components
- Air Operated Auxiliary Equipment
- New and Exchange Products

KNORR-BREMSE



GENUINE KNORR-BREMSE

PRODUCTS FOR BUSES

Index

	<u>Page No.</u>		<u>Page No.</u>
Introduction	i	Optare Metrorider Mk II	115
BMC Falcon 1100	1	Optare Sigma	see Dennis Lance
BMC 1100FE School Bus	3	Optare Solo	119
DAF DB250	5	Optare Spectra	see DAF DB250
DAF SB120	9	Optare Tempo	125
DAF SB220	15	Optare Versa	129
Dennis Dart	21	Plaxton Primo	133
Dennis Dart SLF/SPD	27	Scania 3 Series	137
Dennis Enviro 200/300	33	Scania 4 Series	147
Dennis Enviro 400	37	Volvo B6/B6LE	161
Dennis Javelin	41	Volvo B7L/B7LA	167
Dennis Lance	47	Volvo B7R/B7RLE	177
Dennis Trident II	53	Volvo B7TL	187
EBL Plasma	see Plaxton Primo	Volvo B9L/B9LA	195
Irisbus EuroRider	59	Volvo B9TL	201
Leyland Olympian	67	Volvo B10B/B10BLE	209
MAN 12.240/14.220	71	Volvo B10L/B10LA	221
MAN 18.220	77	Volvo B10M/B10MA	229
Mercedes-Benz Citaro	83	Volvo B12B	243
Mercedes-Benz 0.614D Vario	93	Volvo B12M/B12MA	253
Mercedes-Benz 0.814D Vario	95	Volvo City Bus (double deck)	see B10M
Neoplan Skyliner	99	Volvo Merit	see DAF SB120
Optare Alero	107	Volvo Olympian	267
Optare Delta	see DAF SB220	Volvo Super Olympian (B10TL)	271
Optare Excel	111	Knorr-Bremse Air Disc Brakes	277



KNORR-BREMSE

Knorr-Bremse Systems for Commercial Vehicles Ltd. · Century House · Folly Brook Road
Emerald Park · Emersons Green · Bristol · BS16 7FE · United Kingdom
Tel: 44 (0)117 9846 100 · Fax: 44(0)117 9846 101

New and Exchange Products for Buses

Product Information

This publication has been produced to help you select replacement air brake and suspension products for your buses. The layout for each model of bus follows the same format and runs from the Compressor, through the brake and suspension system components, to the Actuators, Slack Adjusters and Disc Brakes where fitted.

To help find the product quickly, "graphics" have been used to give a general representation of many of the products. These are for guidance only and should not be used to identify a specific product variant as many products, such as Multi-Circuit Protection Valves and Electronic Control Units, look similar but have very different operating characteristics. Wherever possible, a product should be identified from the part number label on the old unit removed from the vehicle. Vehicle manufacturers' part numbers and chassis numbers are included for reference only.

Whilst the greatest care has been taken in the preparation of the information in this publication, specification changes made by the vehicle manufacturers may not be covered in some cases. Furthermore, products offered as equivalent to the original equipment are based on the best information available at the time of printing and on the installation compatibility. If at any time a problem is found, we would be pleased to receive your comments on the Technical Help Line (0117 9846222) or by e-mail to technical@knorr-bremse.com.

The text, graphics and their arrangement are all subject to copyright and other intellectual property protection. Copying of this publication or parts of it must be authorised by Knorr-Bremse Systems for Commercial Vehicles.

Disclaimer

The information contained in this document is intended for the exclusive use of trained persons within the commercial vehicle industry, and must not be passed on to any third party. All recommendations regarding products and their servicing or usage are with reference to Knorr-Bremse products and should not be considered applicable to products from other manufacturers. This information does not purport to be all-inclusive and no responsibility is assumed as a result of its use. We cannot accept any liability nor offer any guarantee regarding data accuracy, completeness or timeliness. The information does not represent any guarantee or ensured characteristics of the Products or Systems described. No liability can be accepted based on the information, its use, recommendations or advice provided. In no event may we be held liable for any damage or loss except in the case of wilful intent or gross negligence on our part, or if any mandatory legal provisions apply. Any legal disputes arising from the use of this information shall be subject to German law.

Note: If service work is carried out on the vehicle, it is the responsibility of the workshop to ensure the vehicle is fully tested and in full functional order before the vehicle is returned into service. Knorr-Bremse accepts no liability for problems caused as a result of appropriate tests not being carried out.









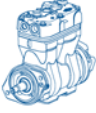

This disclaimer is an English translation of a German text, which should be referred to for all legal purposes.

General Information

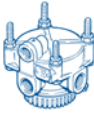

THIS PUBLICATION IS PRINTED ON PAPER OBTAINED FROM
SUSTAINABLE SOURCES. THE PRINTING INKS USED IN THE
PRODUCTION OF THE PUBLICATION LEAVE THE PAPER FULLY
RECYCLABLE



Description	BMC Part Number	OE Part Number	Replacement Knorr-Bremse Part No	Remarks <small>Note: Left and Right refer to the side of the vehicle when viewed from the driver's seat facing forward.</small>
Air Compressor (2W460R) 		LP4865 K006613	LP4865 K006613X50	On Cummins 6 cyl 220 ISBe engine. Cummins Part No. 3977147
Air Dryer 		LA8234 II30448	LA8234 II30448	8.1 bar cut-out Replacement cartridge is 272897SP
Air Line Filter 	5B84637	LA2103 I99660	LA2103 I99660	
Four Circuit Protection Valve 		AE4612 II38801F	AE4612 II38801F	With "Safety Feature"
Hand Control Valve 		HB1143 I82171	HB1143 I82171N00	
Dual Foot Valve 		MB4630 I74907	MB4630 I74907	
Double Check Valve 		295358	295358	M16 ports Bracket mounted
Relay Valve 		AC574AXY	AC574AXY	AC574AXY has integral silencer
Pressure Limiting Valve 		DB1116 I61707	DB1116 I61707	
ABS Modulator 		BR9131 0265351101000	BR9152 II16278	
ABS Wheel Speed Sensor 				
ABS Wheel Speed Sensor 				

NOTE: X00 and X50 suffixes refer to Exchange Products which may be Remanufactured.



Falcon 1100



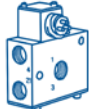
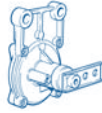

BMC

4 x 2









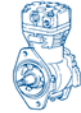
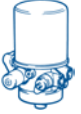

Air Suspension

	Description		BMC Part Number	OE Part Number	Replacement Knorr-Bremse Part No	Remarks Note: Left and Right refer to the side of the vehicle when viewed from the driver's seat facing forward.
	ABS Electronic Control Unit (CI-12) 			0486104033000	0486104033100	
	Air Suspension Control Module 			0501100038000	0501100038100	
	Air Suspension Level Sensor 			0500005002000	0500005002000	

Front Axle	Brake Chamber (Type 14) 			BS3263 II38455F	BS3251 II31782SP	With Disc Brakes Diaphragm C67204 ZF Part No. 0501 317 794
Rear Axle	Spring Brake (Type 30/30) 			Wabco 890 110 353 0 925 492 102 0	K2B0522X50	With Drum Brakes Spring Portion K2B0022X50 Diaphragm 234101K

Front Axle	Air Disc Brake 			SN7117 K011141	Caliper K003809	Left side, actuator mounting 0° ZF Part No. 0501 008 028
	Air Disc Brake 			SN7107 K011140	Caliper K003810	Right side, actuator mounting 0° ZF Part No. 0501 008 027
	Brake Pad Set 				K006060	
	Brake Disc 					
Rear Axle	Automatic Slack Adjuster 					

Mechanical Suspension

Description	BMC Part Number	OE Part Number	Replacement Knorr-Bremse Part No	Remarks Note: Left and Right refer to the side of the vehicle when viewed from the driver's seat facing forward.
Air Compressor (1W225R) 		LK3875 K008457	LK3875 K008457000	On Cummins 4 cyl ISBe 150 30 engine. Cummins Part No. 3971519
Air Dryer 		LA8245 II30810	LA8245 II30810 or LA8234 II30448	8.5 bar cut-out. If LA8234-II30448 is used reset unloader to 8.5 bar. Replacement cartridge is 272897SP
Air Line Filter 	5B84637	LA2103 I99660	LA2103 I99660	
Four Circuit Protection Valve 		AE4612 II38801F	AE4612 II38801F	With "Safety Feature"
Single Check Valve 	5K201097	AE5102 I60422	AE5102 I60422	M22(F) ports
Hand Control Valve 		HB1143 I82171	HB1143 I82171N00	
Dual Foot Valve 		MB4630 I74907	MB4630 I74907	
Double Check Valve 		295358	295358	M16 ports Bracket mounted
Relay Valve 		AC574AXY	AC574AXY	AC574AXY has integral silencer
Low Pressure Switch 		WE2135 I94846		5.0 bar, M12(F) thread Electrical connector - Kostal M24 x 1
Stop Lamp Switch 	3J13043	WE2131 I71206		M12(F) thread Electrical connection - Lucar
Drain Valve		466.1122.5		







NOTE: X00 and X50 suffixes refer to Exchange Products which may be Remanufactured.



1100FE School Bus

BMC

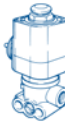
4 x 2

Mechanical Suspension







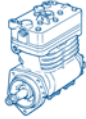
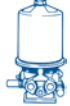

Description	BMC Part Number	OE Part Number	Replacement Knorr-Bremse Part No	Remarks <small>Note: Left and Right refer to the side of the vehicle when viewed from the driver's seat facing forward.</small>
Exhaust Silencer 		SIL68A	SIL68ASP	Snap-on Alternative Silencers: 0484210017000 or ZB3163-I92999
Exhaust Silencer 		SIL68B	SIL68B	M22 thread Alternative Silencers: 0484210001000 or ZB3150-I78074
ABS Modulator 		BR9131 0265351101000	BR9152 II16278	
ABS Wheel Speed Sensor 		0486001014000		Straight sensor, cable length 3.0 m
ABS Electronic Control Unit (Type CI-12) 		0486104033000	0486104033100	
ASR Solenoid Valve 		EA1152 II32611	EA1152 II32611	
Rotary Switch Valve 		EA1136 II30527	EA1136 II30527	

Front Axle	Brake Chamber (Type 24) 		BS2505 II39964F	BS2505 II39964F	Diaphragm B64322
Rear Axle	Spring Brake (Type 20/24) 		BS9439 II37270	BS9476 K004074	Voss ports Diaphragm C72336

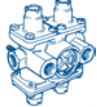
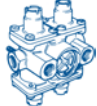







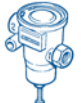

	Air Disc Brake 				
--	--	--	--	--	--

Bodied by Alexander (ALX400), East Lancs/Darwen (Lowlander), Northern Counties (Palatine 2), Optare (Spectra), Plaxton (President) and Wrightbus (Pulsar Gemini)

Air Suspension

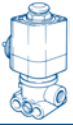

Description	DAF Part Number	OE Part Number	Replacement Knorr-Bremse Part No	Remarks <small>Note: Left and Right refer to the side of the vehicle when viewed from the driver's seat facing forward.</small>
Air Compressor (2W440R) 	1241874	LP4823 II15697	LP4823 SEB01782X00	5 bolt flange mounted
Air Dryer (AD6-S) 	0082829	1189089	LA8226 II30180-B	8.4 bar cut-out Replacement cartridge for 1189089 is SK2914/1 and for II30180-B is 272897SP
Air Line Filter 	0587805	Wabco 432 500 000 0	LA2013 I99660	
Four Circuit Protection Valve 	0271944	Wabco 934 702 381 0	AE4179 I80509	
Four Circuit Protection Valve 	0508473	Wabco 934 702 101 0	AE4428 II15588000	
Single Check Valve 	0288495	Wabco 434 014 000 0	1194016	M22 ports
Check Valve and Choke Unit 	0259592	Wabco 434 015 000 0		M22 ports
Hand Control Valve 	0371274	Wabco 961 723 001 0		
Dual Foot Valve 	1226132	Wabco 461 324 031 0		With pneumatic retarder control
Double Check Valve 	0635474	Wabco 434 202 100 0	AE4100 I14911	For retarder M22 ports, bracket mounted
Relay Valve 	0661694	Wabco 973 001 220 0	AE4179 I76202	

NOTE: X00 and X50 suffixes refer to Exchange Products which may be Remanufactured.

Description	DAF Part Number	OE Part Number	Replacement Knorr-Bremse Part No	Remarks <small>Note: Left and Right refer to the side of the vehicle when viewed from the driver's seat facing forward.</small>
Quick Release Valve 	0370888	1186892	1186892	
Limiting Quick Release Valve 	0720000	Wabco 975 001 000 0	DB2111 I50402	
Pressure Limiting Valve 	0223439	Wabco 475 010 313 0	0481009042000 see Remarks	3.3 bar, M22 ports. Set replacement valve to 3.3 bar
Stop Lamp Switch 	0578466	Wabco 441 014 003 0		
Tilt Drain Valve 			KW2350/2	M22 thread
Test Connector 			KW4282/2	M16 thread
Exhaust Silencer 	1207895	Wabco 432 407 010 0	SIL68B	For Quick Release Valve M22 thread Alternative Silencers: 0484210001000 or ZB3150-I78074
Exhaust Brake Valve 	0639394	Wabco 463 013 116 0	AE1201 I26755	
Solenoid Valve 	0091645	Wabco 472 132 158 0		
Air Suspension Levelling Valve 	0644520	0500005007000	0500005007000	Left side
Air Suspension Levelling Valve 	0644521	0500005006000	0500005006000	Right side

Bodied by Alexander (ALX400), East Lancs/Darwen (Lowlander), Northern Counties (Palatine 2), Optare (Spectra), Plaxton (President) and Wrightbus (Pulsar Gemini)

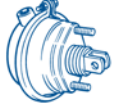
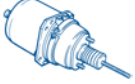
Air Suspension

	Description		DAF Part Number	OE Part Number	Replacement Knorr-Bremse Part No	Remarks Note: Left and Right refer to the side of the vehicle when viewed from the driver's seat facing forward.
Front Axle	Brake Chamber (Type 20 LS)		0751727	Wabco 423 105 080 0 (423 105 900 0)	<i>BX3419</i> II33782A + Yoke 295517	M16 port, M14 push rod Diaphragm 20LS
	Brake Chamber (Type 20 LS)		0751728	Wabco 423 105 081 0 (423 105 900 0)	<i>BX3419</i> II33782A + Yoke 295517	M16 port, M14 push rod Diaphragm 20LS
Rear Axle	Spring Brake (Type 27/30)		1192712 1245769	Wabco 925 329 021 0	<i>BZ9559</i> II37098 + Yoke 295517	M16 ports, M14 push rod Diaphragm 1190023
	Spring Brake (Type 27/30)		1192713 1245770	Wabco 925 329 031 0	<i>BZ9559</i> II37098 + Yoke 295517	M16 ports, M14 push rod Diaphragm 1190023







Front Axle	Automatic Slack Adjuster		0537538	Haldex 72534	KB2030	140 mm hole centre
Rear Axle	Automatic Slack Adjuster			Haldex 72816	KB3000	Left side 38 mm offset, 140 mm hole centre Dana Part No. R9641/F
	Automatic Slack Adjuster			Haldex 72815	KB3005	Right side 38 mm offset, 140 mm hole centre Dana Part No. R9640/F

NOTE: X00 and X50 suffixes refer to Exchange Products which may be Remanufactured.

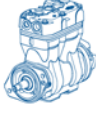
More than 1 billion people
put their trust in the
safety of Knorr-Bremse
products every day

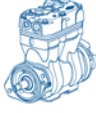
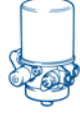

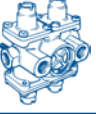
Bodied by Plaxton (Centro) and Wrightbus (Cadet), also sold as Volvo Merit

Air Suspension

Description	DAF Part Number	OE Part Number	Replacement Knorr-Bremse Part No	Remarks <small>Note: Left and Right refer to the side of the vehicle when viewed from the driver's seat facing forward.</small>
Air Compressor (2W460R) 		1194357	LP4863 K006611000	On Cummins B Series engine 2 bolt flange Cummins Part No. 3285924
Air Compressor (2W460R) 		1194454	LP4863 K006611000	On Cummins B Series engine 2 bolt flange, with revised cylinder head and gasket. Cummins Part No. 3286902
Air Compressor (2W460R) 		1194430	LP4865 K006613X50	On Cummins ISBe engine 2 bolt flange, crankshaft has right hand 5/8" UNF thread Cummins Part No. 4895964
Air Compressor (2W460R) 		LP4858 K001095	LP4865 K006613X50	On Cummins ISBe engine 2 bolt flange, crankshaft has left hand M18 thread Cummins Part No. 3957727
Air Compressor (2W460R) 		LP4865 K006613	LP4865 K006613X50	On Cummins ISBe engine 2 bolt flange, crankshaft has left hand M18 thread Cummins Part No. 3977147
Air Dryer 	1194407	0484460170000	0484460170000	9.8 bar cut-out with external purge control. Replacement Cartridge is 272897SP
Single Check Valve	1210080			2 inlet ports and 2 delivery ports
Four Circuit Protection Valve 	1238505	AE4437 II17189	AE4437 II17189	
Four Circuit Protection Valve 		Wabco 934 702 387 0	AE4437 II17189	
Four Circuit Protection Valve 	384037	0481062406000	AE4437 II17189	
Four Circuit Protection Valve 	1367504	AE4610 II37462	AE4610 II37462	With "Safety Feature"













NOTE: X00 and X50 suffixes refer to Exchange Products which may be Remanufactured.

Air Suspension

Description	DAF Part Number	OE Part Number	Replacement Knorr-Bremse Part No	Remarks <small>Note: Left and Right refer to the side of the vehicle when viewed from the driver's seat facing forward.</small>
Hand Control Valve 	1293853	Wabco 961 723 025 0		85° handle travel
Hand Control Valve 	1143275 1309815	Wabco 961 723 030 0		73° handle travel
Dual Foot Valve 	1136096 1141676 1141679	Wabco 461 318 601 0		With electrical retarder control
Dual Foot Valve 	1144648	Wabco 461 318 605 0		With electrical retarder control
Anti-compounding Relay Valve 	1259856	Wabco 973 011 200 0		Voss ports
Anti-compounding Relay Valve 	1302103	Wabco 973 011 205 0		Voss ports, with silencer
Relay Valve 	1143378 1238501	0481026022000	0481026022000	0.15 bar threshold
Relay Valve 	1305026	Wabco 973 011 004 0	0481026023000	0.2 bar threshold Voss ports
Quick Release Valve 	0533880 0711960	Wabco 973 500 000 0	KX2000/1	M22 ports
Pressure Limiting Valve 	1193483	Wabco 475 010 322 0		4.2 bar M22 Voss ports Door brake system
Low Pressure Switch 		Wabco 441 024 006 0		5.4 - 6.2 bar
Stop Lamp Switch 	1195063	Wabco 441 024 007 0		0.5 - 0.7 bar





Bodied by Plaxton (Centro) and Wrightbus (Cadet), also sold as Volvo Merit

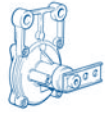

Air Suspension

Description	DAF Part Number	OE Part Number	Replacement Knorr-Bremse Part No	Remarks <small>Note: Left and Right refer to the side of the vehicle when viewed from the driver's seat facing forward.</small>
Pressure Relief (Safety) Valve 	1248291	Voss 0 268 874 200		16 bar
Tilt Drain Valve 		Voss 0 258 865 052	KW2350/2	
Test Connector 	0512733		ZB1218 SEB00253	M16(F) thread Alternative - use KW4282/2 with a M16 socket adapter
Test Connector 	1195131			
Test Connector 	1209294			
Exhaust Silencer 	1343945	Wabco 432 407 050 0		For Foot Valve 2 bolt flange mounted
Exhaust Silencer 	1193486 1311739	Wabco 432 407 060 0	SIL68B	M22 thread Alternative Silencers: 0484210001000 or ZB3150-178074
Exhaust Silencer 	1193201	Wabco 432 407 070 0	SIL68ASP	Snap-on Alternative Silencers: 0484210017000 or ZB3163-192999
ABS Modulator 	1304635	Wabco 472 195 016 0	BR9159 II40864FN00	M22 Voss ports DIN bayonet electrical connector
ABS Wheel Speed Sensor 				Front axle
ABS Wheel Speed Sensor 				Rear axle
ABS Electronic Control Unit 				

NOTE: X00 and X50 suffixes refer to Exchange Products which may be Remanufactured.

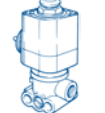
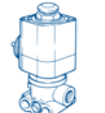







Air Suspension

Description	DAF Part Number	OE Part Number	Replacement Knorr-Bremse Part No	Remarks <small>Note: Left and Right refer to the side of the vehicle when viewed from the driver's seat facing forward.</small>
Air Suspension Level Sensor 	1138883	0504002113000	0504002113100	Both axles
Air Suspension Solenoid Block				
Air Suspension Pressure Switch 				6.0 bar
Air Suspension Pressure Sensor 	1296494	Wabco 441 040 006 0 441 040 007 0		
Air Suspension Electronic Control Unit 				
Check Valve and Choke Unit 	0259592	Wabco 434 015 000 0		M22 ports Door brake system
Solenoid Valve 	1197581			Door brake system
Solenoid Valve 	1197595			

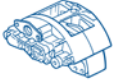
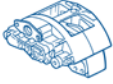
Front Axle	Brake Chamber (Type 14) 	1142081 1142080	BS3270 II39214F BS3271 II39215F	BS3251 II31782SP	Diaphragm C67204
Rear Axle	Spring Brake (Type16/16) 	1142164 1142163	BS9373 II39213F BS9374 II39212F	BS9397 II31227	Diaphragm C60491

Bodied by Plaxton (Centro) and Wrightbus (Cadet), also sold as Volvo Merit

Air Suspension







	Description	DAF Part Number	OE Part Number	Replacement Knorr-Bremse Part No	Remarks <small>Note: Left and Right refer to the side of the vehicle when viewed from the driver's seat facing forward.</small>
Front Axle	Air Disc Brake 	1154212 Dana SM486/27K	SB6556 II39252F	Caliper K003825	Left Side Actuator mounting 5° Pad Set II376580062 Pad Wear Indicator II39116F0061
	Air Disc Brake 	1154213 Dana SM486/28K	SB6546 II39251F	Caliper K003826	Right Side Actuator mounting 5° Pad Set II376580062 Pad Wear Indicator II39116F0061
Rear Axle	Air Disc Brake 	1142133 Dana 829691	SB6545 II39068F	Caliper K003826	Left Side Actuator mounting 5° Pad Set II376580062 Pad Wear Indicator II39116F0061
	Air Disc Brake 	1142131 Dana 829692	SB6555 II39069F	Caliper K003825	Right Side Actuator mounting 5° Pad Set II376580062 Pad Wear Indicator II39116F0061
Front and Rear Axles	Air Disc Brake 	Dana 829771	SN6575 K006843	Caliper K003780	Actuator mounting 5° Pad Set II376580062 Pad Wear Indicator K000683 2005 onwards
	Air Disc Brake 	Dana 829772	SN6585 K006844	Caliper K003779	Actuator mounting 5° Pad Set II376580062 Pad Wear Indicator K000683 2005 onwards
	Disc Brake Pad Set 	1142152	II376580062	II376580062	SB6 and SN6 Disc Brakes
Front Axle	Brake Disc 	1142086		II39280F	377 mm dia. 10 x 14.75 mm dia holes 2 x M14 x 1.5 holes
Rear Axle	Brake Disc 	1142132		II38628F	377 mm dia. 8 x M14 x 1.5 holes

NOTE: X00 and X50 suffixes refer to Exchange Products which may be Remanufactured.

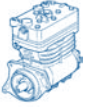
**Buying genuine
Knorr-Bremse product
ensures vehicle safety and
buys you peace of mind**

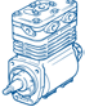
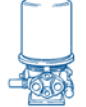
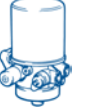
Bodied by Alexander (ALX300), East Lancs/Darwen (Myllennium), Ikarus (Citibus and Polaris), Northern Counties (Paladin), Optare (Delta) and Plaxton (Prestige)

Air Suspension

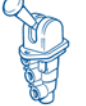
Description	DAF Part Number	OE Part Number	Replacement Knorr-Bremse Part No	Remarks <small>Note: Left and Right refer to the side of the vehicle when viewed from the driver's seat facing forward.</small>
Air Compressor (2W440R) 	1396291	LP4830 SEB01781	LP4830 SEB01781X00	4 bolt (not symmetrical) flange mounted
Air Compressor (2W440R) 	0280408	Wabco 911 503 051 0		4 bolt flange mounted
Air Compressor (2W440R) 	1287663	Wabco 911 506 052 0		4 bolt flange mounted
Air Dryer (AD6) 	0082829	1185774	LA8206 II19375-B	9.8 bar cut-out, Voss ports, bayonet heater connector, with external purge system Replacement cartridge is 272897SP
Air Dryer 	0080098 0220340	0484460107000	LA8206 II19375-B plus Heater I87122004	9.8 bar cut-out, Kostal heater connector (2 pin), Port 4 M12. Replacement cartridge is 272897SP
Air Dryer 	0387841 1238567	0484460153000	0484460153000 or LA8229 II30443N00 plus Heater I87122004	9.8 bar cut-out, Kostal heater connector (2 pin), No Port 4. Replacement cartridge is 272897SP
Air Dryer 	1187906 1239290	0484460135000	LA8206 II19375-B	9.8 bar cut-out, Voss ports, bayonet heater connector. Replacement cartridge is 272897SP
Air Line Filter 	0587805	Wabco 432 500 020 0	LA2103 I99660	
Four Circuit Protection Valve 	0271944	Wabco 934 702 381 0	AE4179 I80509	
Hand Control Valve 	0371274	Wabco 961 723 001 0		











NOTE: X00 and X50 suffixes refer to Exchange Products which may be Remanufactured.

Bodied by Alexander (ALX300), East Lancs/Darwen (Myllennium), Ikarus (Citibus and Polaris), Northern Counties (Paladin), Optare (Delta) and Plaxton (Prestige)

Description	DAF Part Number	OE Part Number	Replacement Knorr-Bremse Part No	Remarks <small>Note: Left and Right refer to the side of the vehicle when viewed from the driver's seat facing forward.</small>
Dual Foot Valve 	0375192	Wabco 461 317 037 0		3 hole mounting with no retarder control Up to 1990
Dual Foot Valve 	0091350	Wabco 461 317 039 0		4 hole mounting with no retarder control From 1990
Dual Foot Valve 	0528526	Wabco 461 318 007 0		3 hole mounting with switched retarder control Up to 1990
Dual Foot Valve 	0751751	Wabco 461 318 009 0		4 hole mounting with switched retarder control From 1990
Dual Foot Valve 	0375194	Wabco 461 324 011 0		3 hole mounting with pneumatic retarder control Up to 1990 with ZF gearbox
Dual Foot Valve 	0751752	Wabco 461 324 027 0		4 hole mounting with pneumatic retarder control From 1990 to 1991 with ZF gearbox
Dual Foot Valve 	1226132	Wabco 461 324 031 0		4 hole mounting with pneumatic retarder control From 1991 with ZF gearbox
Pneumatic Control Valve	0691640	Wabco 461 324 520 0		Attached to Foot Valve
Double Check Valve 	0635474	Wabco 434 202 100 0	AE4100 I14911	M22 ports, bracket mounted
Check Valve and Choke Unit 	0259592	Wabco 434 015 000 0		M22 ports
Relay Valve 	0661694	RE1121 I76202	RE1121 I76202	











Bodied by Alexander (ALX300), East Lancs/Darwen (Myllennium), Ikarus (Citibus and Polaris), Northern Counties (Paladin), Optare (Delta) and Plaxton (Prestige)

Air Suspension

Description	DAF Part Number	OE Part Number	Replacement Knorr-Bremse Part No	Remarks Note: Left and Right refer to the side of the vehicle when viewed from the driver's seat facing forward.
Quick Release Valve 	0370889	1186892	1186892	M22 inlet & exhaust, M16 delivery
Quick Release Valve 	0533880 0711960	Wabco 973 500 000 0	KX2000/1	M22 all ports
Pressure Limiting Valve 	0223439	Wabco (475 010 008 0) 475 010 313 0	DB1103 I61236 see Remarks	Set replacement valve to 3.3 bar
Pressure Limiting Valve 	0745062	Wabco 475 010 002 0	DB1103 I61236 see Remarks	Set replacement valve to 1.8 bar
Low Pressure Switch 	0578466 1332000	Wabco 441 014 003 0 441 014 015 0		5 bar, M12 thread
Low Pressure Switch 	0371993	Wabco 441 014 025 0	272295	6 bar, M12 thread For ECAS
Low Pressure Switch 	0299533 0649130			
Pressure Relief (Safety) Valve 	0555594 0759079	Wabco 434 602 011 0		12 bar, M22 thread
Tilt Drain Valve 	0505294	Wabco 934 300 003 0	KW2350/2	M22 thread
Test Connector 	0709671	Wabco 463 703 100 0	AC784D	M22(M) thread
Test Connector 	0117628 1260000		ZB1219 SEB00254	M22(F) thread Alternative - use AC784D with a M22 socket adapter
Test Connector 	0512733		ZB1218 SEB00253	M16(F) thread Alternative - use KW4282/2 with a M16 socket adapter

NOTE: X00 and X50 suffixes refer to Exchange Products which may be Remanufactured.

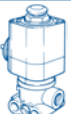
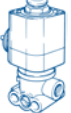
Bodied by Alexander (ALX300), East Lancs/Darwen (Myllennium), Ikarus (Citibus and Polaris), Northern Counties (Paladin), Optare (Delta) and Plaxton (Prestige)

Description	DAF Part Number	OE Part Number	Replacement Knorr-Bremse Part No	Remarks <small>Note: Left and Right refer to the side of the vehicle when viewed from the driver's seat facing forward.</small>
Exhaust Silencer 	0285476	Wabco 432 407 060 0	SIL68B	For Foot Valve and QRV M22 thread Alternative Silencers: 0484210001000 or ZB3150-178074
ABS Modulator 	0084275	Wabco 472 195 011 0		M22 Voss ports, 24v, 3 pin bayonet electrical connector
Air Suspension Levelling Valve 	0644520	0500005007000	0500005007000	Front axle
Air Suspension Levelling Valve 	0644521	0500005006000	0500005006000	Rear axle
Air Suspension Levelling Valve 	0638057	Wabco 464 002 330 0	SV1307 I87823	
ECAS Three Solenoid Control Valve 	0892110 1304587 1240836	Wabco 472 900 030 0 472 900 055 0 472 900 033 0		Front axle
ECAS Three Solenoid Control Valve 	0527488 1302682 1240847 1249402	Wabco 472 900 001 0 472 900 053 0 472 900 008 0		Rear axle
ECAS Pressure Sensor 	0387886 1249721 1253621	Wabco 441 040 000 0 441 040 004 0 441 040 005 0		M16 thread, Kostal electrical connector
ECAS Pressure Sensor 	0089131	Wabco 441 040 011 0		M22 thread, bayonet electrical connector
Solenoid Valve 	1285545	Wabco 472 172 604 0		
Solenoid Valve 	0629166 1327108	Wabco 472 103 108 0 472 123 108 0	EDP25AA/1	
Exhaust Brake Valve 		Wabco 463 013 015 0		

Bodied by Alexander (ALX300), East Lancs/Darwen (Myllennium), Ikarus (Citibus and Polaris), Northern Counties (Paladin), Optare (Delta) and Plaxton (Prestige)

Air Suspension

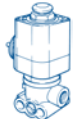
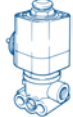
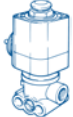
Description	DAF Part Number	OE Part Number	Replacement Knorr-Bremse Part No	Remarks <small>Note: Left and Right refer to the side of the vehicle when viewed from the driver's seat facing forward.</small>
Double Check Valve 	0635474	Wabco 434 202 100 0	<i>AE4100</i> I14911	For retarder control. M22 ports, bracket mounted
Solenoid Valve 	0091645	Wabco 472 132 158 0	0481511102100	For retarder control.
Solenoid Valve 	0091647	Wabco 472 128 758 0		For engine control.
Solenoid Valve 	1285547	Wabco 471 171 704 0		For traction control and engine brake control.





Genuine Knorr-Bremse parts last longer



NOTE: X00 and X50 suffixes refer to Exchange Products which may be Remanufactured.

4 x 2

Air Suspension

Bodied by Alexander (ALX300), East Lancs/Darwen (Myllennium), Ikarus (Citibus and Polaris), Northern Counties (Paladin), Optare (Delta) and Plaxton (Prestige)

	Description		DAF Part Number	OE Part Number	Replacement Knorr-Bremse Part No	Remarks <small>Note: Left and Right refer to the side of the vehicle when viewed from the driver's seat facing forward.</small>
Front Axle	Brake Chamber (Type 20)		0284503 0834482	Wabco 423 105 089 0	<i>BX3419</i> II33782A + Yoke 295517	M16 port, welded yoke II33782A has M16 push rod Diaphragm 20LS
	Brake Chamber (Type 24)		0754486 0754487 0834483	Wabco 423 106 086 0 423 106 087 0	<i>BX3538</i> II33783A + Yoke 295517	M16 port, M14 push rod II33783A has M16 push rod Diaphragm 24LS
Rear Axle	Spring Brake (Type 30/30)		1270262 1277863	Wabco 925 422 102 0 925 422 130 0	K2B0522X50 + Yoke 295517	M16 port, welded yoke K2B0522X50 has M16 push rod Diaphragm 234101K
	Spring Brake (Type 30/30)		0374781 0374782	Wabco 925 322 132 0 925 322 133 0	K2B0522X50 + Yoke 295517	M16 port, M14 push rod K2B0522X50 has M16 push rod Diaphragm 234101K

Front Axle	Automatic Slack Adjuster		0282609	Haldex 72534	KB2030	140mm hole centre
	Automatic Slack Adjuster		0740321	Haldex 72608	KB2400	Left side 13mm offset, 140mm hole centre
	Automatic Slack Adjuster		0740322	Haldex 72609	KB2425	Right side 13mm offset, 140mm hole centre
Rear Axle	Automatic Slack Adjuster		390065 0159577	Haldex 72170	KB2395	140mm hole centre
	Automatic Slack Adjuster			Haldex 72816	KB3000	Left side 38mm offset, 140mm hole centre. Dana Part No. R9641/F
	Automatic Slack Adjuster			Haldex 72815	KB3005	Right side 38mm offset, 140mm hole centre. Dana Part No. R9640/F

DENNIS (Alexander Dennis)

Dart 4 x 2

Bodied by Alexander (Dash), East Lancs/Darwen (EL2000 and Spryte),
Marshall/MCV (Capital), Reeve Burgess/Plaxton (Pointer) and Wrightbus (Handybus)

Mechanical & Air Suspension

Description	Dennis Part Number	OE Part Number	Replacement Knorr-Bremse Part No	Remarks <small>Note: Left and Right refer to the side of the vehicle when viewed from the driver's seat facing forward.</small>
Air Compressor (1W250D) 	652439	KZ1143/3	KZ1143/3X50	Mk I 2 Bolt flange mounted Disc Valve head Cummins Part No. 3279175
Air Compressor (1W250R) 	653613 657033	1186551 1194215	1194215X50	Mk I & Mk II 2 Bolt flange mounted Reed Valve head Cummins Part No. 3283968
Air Dryer (AD6) 	652885	KZ1310/2	LA8223 II30178-B	Mk I 8.4 bar cut-out, Imperial ports Replacement Cartridge is 272897SP
Air Dryer (AD6-S) 	653865	1188801	LA8223 II30178-B	Mk I 8.4 bar cut-out, Imperial ports Replacement Cartridge for 1188801 is SK2914/1
Air Dryer (AD6) 	656882	1194188	LA8226 II30180-B	Mk II 8.4 bar cut-out, Metric ports Replacement Cartridge is 272897SP
Air Dryer (AD6-S) 	654755	1189089	LA8226 II30180-B	Mk II 8.4 bar cut-out, Metric ports Replacement Cartridge for 1189089 is SK2914/1
Air Dryer (AD6-S) 	654729	1189163	LA8227 II30181-B	Mk II 10.0 bar cut-out, Metric ports Replacement Cartridge for 1189163 is SK2914/1
Four Circuit Protection Valve 	650209	KY1671/1	VPS48AI	Mk I up to Dec 1988 Imperial ports
Four Circuit Protection Valve 	611970	KY1671/14	VPS48HI	Mk I from Jan 1989 Imperial ports
Four Circuit Protection Valve 	654867	VPS45C	VPS45C	Mk II, some early buses fitted with this valve. Metric ports
Four Circuit Protection Valve 	614922	VPS48H	VPS48H	Mk II Metric ports
Four Circuit Protection Valve 	655610	AE4158 I70615	AE4158 I70615	Mk II, some later buses fitted with this valve. Metric ports

NOTE: X00 and X50 suffixes refer to Exchange Products which may be Remanufactured.

Description		Dennis Part Number	OE Part Number	Replacement Knorr-Bremse Part No	Remarks <small>Note: Left and Right refer to the side of the vehicle when viewed from the driver's seat facing forward.</small>
Charging Valve with Full Feedback		655711	Wabco 434 100 037 0	<i>DR4150</i> K000613 (see Remarks)	Set replacement valve to 1.6 bar
Single Check Valve		605293 612503	KW2966/1	KW2966/1	Mk I 1/2" NPTF ports
Single Check Valve		654733	KW4455/1	KW4455/1	Mk II M22 ports
Hand Control Valve (S4)		652405	KY2498/1	KY2498/1	Mk I
Hand Control Valve		654732	DPM94A	DPM94AAX	Mk II from 1994 to 1996
Hand Control Valve		656324	DPM92A	DPM92A	Mk II from 1996 to 1998
Hand Control Valve		657493	DPM92AB	DPM92AB	Mk II from 1998 With red handle knob
Dual Foot Valve (E6)		611529	KY1916/1	KY1916/1	Mk I 3/8" NPTF ports Replacement base valve is 295579XU
Dual Foot Valve (E6)		654756 657262	KY1916/3 KY1916/4	KY1916/3	Mk II M16 ports Replacement base valve is 1189389XU
Dual Foot Valve		660687	Wabco 461 318 609 0		3 bolt mounting with potentiometer for retarder control with Voith DV500
Double Check Valve		654734	295358	295358	M16 ports Bracket mounted
Double Check Valve		653877	Wabco 434 208 021 0	<i>AE4100</i> I14911	M22 ports Bracket mounted.

DENNIS (Alexander Dennis)





Dart 4 x 2

Bodied by Alexander (Dash), East Lancs/Darwen (EL2000 and Spryte),
Marshall/MCV (Capital), Reeve Burgess/Plaxton (Pointer) and Wrightbus (Handybus)

Mechanical & Air Suspension

Description	Dennis Part Number	OE Part Number	Replacement Knorr-Bremse Part No	Remarks Note: Left and Right refer to the side of the vehicle when viewed from the driver's seat facing forward.
Relay Valve (R15) 	653885	1186715	AC574AXY	AC574AXY has integral silencer
Quick Release Valve 	609011	274997	274997	Mk I
Quick Release Valve 	614927 654757	KX1294/1	KX1294/1	Mk II
Load Sensing Valve (Mech suspension) 	611740	KY890/1	KY890/1	Mk I & Mk II Front service brake
Load Sensing Valve (Air suspension) 	655611	BR5522 II36833	BR5522 II36836	Mk I & Mk II Front service brake
Load Sensing Valve (Air suspension) 		Haldex 602 005 001		Mk I & Mk II Front service brake
Pressure Proportioning Valve 	653826	DB2116 I86155	DB2116 I86155	Rear service brake
Low Pressure Switch 	610582-A	1185782	295476	5.4 bar, 1/4" NPTF thread
Stop Lamp Switch 	605208	274746	274746	1/4" NPTF thread
Pressure Relief (Safety) Valve 	613553	KX2073/7	KX2073/7	Mk I 11 bar, 1/4" NPTF thread Note: LA8... Air Dryers have an internal safety valve
Pressure Relief (Safety) Valve 	658257	KX1729/3	KX1729/3	Mk II 10.7 bar, M16 thread Note: LA8... Air Dryers have an internal safety valve
Pressure Relief (Safety) Valve 	654729	KX1729/4	KX1729/4	Mk II 13.5 bar, M16 thread Note: LA8... Air Dryers have an internal safety valve

NOTE: X00 and X50 suffixes refer to Exchange Products which may be Remanufactured.





Description		Dennis Part Number	OE Part Number	Replacement Knorr-Bremse Part No	Remarks <small>Note: Left and Right refer to the side of the vehicle when viewed from the driver's seat facing forward.</small>
Tilt Drain Valve		609956 653147	KW2350/5	KW2350/1	Mk I 1/2" NPTF thread
Tilt Drain Valve		654728	VA12A	KW2350/2	Mk II M22 thread
Drain Cock		607688	KW718/2	KW718/2	Mk I In Ping Tank 1/4" NPTF thread
Test Connector		650367	KW3405/1	KW3405/1	Mk I 1/4" NPTF thread
Test Connector		655026		KW4282/2	Mk II M16 thread
Exhaust Silencer		655137	1188975	1188975	For Foot Valve
Exhaust Silencer		655136	KW4069/3	0484210002000	Mk II For Quick Release Valve M16 thread
Air Suspension Levelling Valve		655687	Wabco 464 006 002 0	SV1395 II19425	
Levelling Valve Linkage		655691	Wabco 433 401 003 0	SEB00256	

DENNIS (Alexander Dennis)

Dart 4 x 2

Bodied by Alexander (Dash), East Lancs/Darwen (EL2000 and Spryte),
Marshall/MCV (Capital), Reeve Burgess/Plaxton (Pointer) and Wrightbus (Handybus)

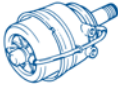
Mechanical & Air Suspension

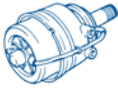
	Description	Dennis Part Number	OE Part Number	Replacement Knorr-Bremse Part No	Remarks <small>Note: Left and Right refer to the side of the vehicle when viewed from the driver's seat facing forward.</small>
Front Axle	Brake Chamber (Type 9) 	652881 652883 654280 654281	1186733-01	1186733-01	Mk I 3.8" NPTF ports, 1.75" UNF tube thread Diaphragm 272489
	Brake Chamber (Type 9) 	654758	1189072-01	1189072-01	Mk II M16 ports, M48 tube thread Diaphragm 272489
	Brake Chamber (Type 9) 	655834	EF90YE	EF90YE	Mk II M16 ports, M48 tube thread Diaphragm 234433K Tube lock nut is Dennis 428350
Rear Axle	Spring Brake (Type 9-47) 	652882	1186732-01	K2E4001X50	Mk I, 3.8" NPTF ports, 1.75" UNF tube thread Spring portion K2E0311X50 Diaphragm 272489
	Spring Brake (Type 9-47) 	654759 656295	K2E4002 K2E4020	K2E4002X50	Mk II, left side, M16 ports, M48 tube thread Spring portion K2E0301X50 Diaphragm 272489
	Spring Brake (Type 9-47) 	655142 656296	K2E4003 K2E4021	K2E4002X50	Mk II, right side, M16 ports, M48 tube thread Spring portion K2E0301XU Diaphragm 272489

Note: The Dart had many changes to its brake components at the end of March 1993. For simplification buses built up to that date are referred to as Mk I. Buses built after March 1993 are referred to as Mk II.

NOTE: X00 and X50 suffixes refer to Exchange Products which may be Remanufactured.











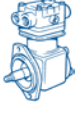

The only way to get
genuine Knorr-Bremse
quality is to buy genuine
Knorr-Bremse parts

DENNIS (Alexander Dennis)

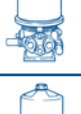
Dart SLF & SPD

4 x 2

Bodied by Alexander (ALX200), Caetano (Compass and Nimbus), East Lancs/Darwen (Esteem and Spryte), Marshall/MCV (Capital and Evolution), Plaxton (Pointer) and Wrightbus (Crusader and Handybus) **Air Suspension**

Description	Dennis Part Number	OE Part Number	Replacement Knorr-Bremse Part No	Remarks Note: Left and Right refer to the side of the vehicle when viewed from the driver's seat facing forward.
Air Compressor (1W250R) 	657033	1194215	1194215X50 (Upgrade kit to 2W460R Compressor available from Alexander Dennis)	2 bolt flange mounted, reed valve head Cummins Part No. 3283968
Air Compressor (2W460R) 	658414	1194357	LP4863 K006611000	On Cummins B Series engine 2 bolt flange mounted Cummins Part No. 3285924
Air Compressor (2W460R) 	658414	1194454	LP4863 K006611000	On Cummins B Series engine 2 bolt flange, with revised cylinder head and gasket. Cummins Part No. 3286902
Air Compressor (2W460R) 	659044	1194430	LP4865 K006613X50	On Cummins ISBe engine 2 bolt flange, crankshaft has right hand 5/8" UNF thread Cummins Part No. 4895964
Air Compressor (2W460R) 	658604	LP4858 K001095	LP4865 K006613X50	On Cummins ISBe engine 2 bolt flange, crankshaft has left hand M18 thread Cummins Part No. 3957727
Air Compressor (2W460R) 	658604-1	LP4865 K006613	LP4865 K006613X50	On Cummins ISBe engine 2 bolt flange, crankshaft has left hand M18 thread Cummins Part No. 3977147
Air Dryer (AD6) 	656881	1194211	LA8227 II30181-B	10.0 bar cut-out, Metric ports Replacement cartridge is 272897SP
Air Dryer (AD6-S) 	654729	1189163	LA8227 II30181-B	10.0 bar cut-out, Metric ports Replacement cartridge for 1189163 is SK2914/1 and for II30181 is 272897SP
Air Dryer 	658208	LA8227 II30181	LA8227 II30181	10.0 bar cut-out, Metric ports Replacement cartridge is 272897SP
Air Line Filter 	655710	Wabco 432 500 020 0	LA2103 I99660	For air suspension system
Four Circuit Protection Valve 	656249	Wabco 934 714 125 0	AE4612 II38801F	With "Safety Feature"
Charging Valve with Full Feedback 	655711	Wabco 434 100 037 0	DR4150 K000613 (see Remarks)	Set replacement valve to 1.6 bar

NOTE: X00 and X50 suffixes refer to Exchange Products which may be Remanufactured.







Dart SLF & SPD

4 x 2

DENNIS (Alexander Dennis)

Air Suspension







Bodied by Alexander (ALX200), Caetano (Compass and Nimbus), East Lancs/Darwen (Esteem and Spryte), Marshall/MCV (Capital and Evolution), Plaxton (Pointer) and Wrightbus (Crusader and Handybus)

Description		Dennis Part Number	OE Part Number	Replacement Knorr-Bremse Part No	Remarks Note: Left and Right refer to the side of the vehicle when viewed from the driver's seat facing forward.
Single Check Valve		654733	KW4455/1	KW4455/1	In auxiliary charge line M22 ports
Hand Control Valve		654732	DPM94A	DPM94AAX	
Hand Control Valve		656324	DPM92A	DPM92A	From Chassis 0714 Up to 1998
Hand Control Valve		657493	DPM92AB	DPM92AB	From 1998 With red handle knob
Dual Foot Valve		654756 657262	KY1916/3 KY1916/4	KY1916/3	Replacement base valve is 1189389XU
Dual Foot Valve		660687	Wabco 461 318 609 0		With potentiometer retarder control for Voith DV500
Double Check Valve		654734	295358	295358	
Quick Release Valve		654757	KX1294/5	KX1294/5	
Load Sensing Valve (Air Suspension)		655611	BR5530 II36818	BR5530 II36818	Vehicles without ABS
Pressure Limiting Valve		653540	KX542/7	SKX542/1	Set replacement valve to 5.5 bar
Low Pressure Switch		610668 610669			Dennis only
Stop Lamp Switch		659171	274746	274746	1/4" NPTF thread

DENNIS (Alexander Dennis)

Dart SLF & SPD 4 x 2

Bodied by Alexander (ALX200), Caetano (Compass and Nimbus), East Lancs/Darwen (Esteem and Spryte), Marshall/MCV (Capital and Evolution), Plaxton (Pointer) and Wrightbus (Crusader and Handybus) **Air Suspension**

Description	Dennis Part Number	OE Part Number	Replacement Knorr-Bremse Part No	Remarks Note: Left and Right refer to the side of the vehicle when viewed from the driver's seat facing forward.
Pressure Relief (Safety) Valve 	613553 654729	KX1729/4	KX1729/4	13.5 bar, M16 thread Note: LA8227 Air Dryer has an internal safety valve
Tilt Drain Valve 	654728	VA12A	KW2350/2	M22 thread
Test Connector 	655026		KW4282/2	M16 thread
Exhaust Silencer 	655137	1188975	1188975	For Foot Valve
Exhaust Silencer 	655136	KW4069/3	0484210002000	From Chassis 141 For Quick Release Valve M16 thread
Exhaust Silencer 	659280	0484210002000	0484210002000	Later vehicles For Quick Release Valve M16 thread
Exhaust Silencer 	656303	ZB3150 I78074	SIL68B	For Load Sensing Valve M22 thread Alternative Silencers: 0484210001000 or ZB3150-I78074
Exhaust Silencer 	658644	SIL68A	SIL68ASP	For Air Dryer Snap-on Alternative Silencers: 0484210017000 or ZB3163-I92999
ABS Modulator 	657942-2	Wabco 472 195 018 0	BR9156 II32612	
ABS Wheel Speed Sensor 	656007-53	Wabco	0486000128100	Sensor with Bush is 0486000136000
ABS Electronic Control Unit 	658004-1	Wabco 446 004 410 0		

NOTE: X00 and X50 suffixes refer to Exchange Products which may be Remanufactured.







Dart SLF & SPD

4 x 2

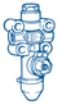
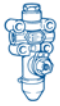
DENNIS (Alexander Dennis)

Air Suspension

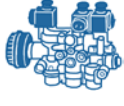
Bodied by Alexander (ALX200), Caetano (Compass and Nimbus), East Lancs/Darwen (Esteem and Spryte), Marshall/MCV (Capital and Evolution), Plaxton (Pointer) and Wrightbus (Crusader and Handybus)









Description		Dennis Part Number	OE Part Number	Replacement Knorr-Bremse Part No	Remarks <small>Note: Left and Right refer to the side of the vehicle when viewed from the driver's seat facing forward.</small>
Air Suspension Levelling Valve		655687	Wabco 464 006 002 0	SV1395 II19425 plus ZB3131 II19422	Up to Dec 2002 On suspension systems without ferry lift facility. Lever & Rubber Link II19422
Air Suspension Levelling Valve		652582	SV1294 180091 K002335	SV1294 K002335	From Jan 2003 On suspension systems without ferry lift facility
Air Suspension Levelling Valve		651509	SV1351 188579 K002334	SV1351 K002334	On suspension systems with ferry lift facility Valve has datum adjustment
Levelling Valve Linkage		655691	Wabco 433 401 003 0	SEB00256	
Air Operated Pilot Valve		654201	B4300		On ferry lift and full kneeling systems Dennis only
Air Operated Pilot Interlock Valve		658112			On ferry lift and full kneeling systems Dennis only
Solenoid Valve		655776	Wabco 472 173 700 0	EDP26AA/1	On ramp interlock Normally 'Open', M12 ports, Kostal electrical connector. EDP26AA/1 has female Port 1
ECAS Three Solenoid Control Valve		655713	Wabco 472 900 013 0		For air suspension and ferry lift systems
Air Suspension Single Solenoid Control Valve		609355	454ATF		Air suspension Dennis only
Air Suspension Level Sensor		654978-2	Wabco 441 050 006 0		
Two Way Valve		656537			For ferry lift and full kneeling systems Dennis only

DENNIS (Alexander Dennis)

Dart SLF & SPD

4 x 2

Bodied by Alexander (ALX200), Caetano (Compass and Nimbus), East Lancs/Darwen (Esteem and Spryte), Marshall/MCV (Capital and Evolution), Plaxton (Pointer) and Wrightbus (Crusader and Handybus) **Air Suspension**

	Description	Dennis Part Number	OE Part Number	Replacement Knorr-Bremse Part No	Remarks Note: Left and Right refer to the side of the vehicle when viewed from the driver's seat facing forward.
Front Axle	Brake Chamber (Type 9) 	655834	EF90YE	EF90YE	SLF - with breather elbow Diaphragm 234433K Tube lock nut is Dennis 428350
	Brake Chamber (Type 9) 	656759	EF90YES	EF90YES	SLF - with straight breather Diaphragm 234433K Tube lock nut is Dennis 428350
	Brake Chamber (Type 12) 	657346	EF120YES	EF120YES	SPD Diaphragm 234226K Tube lock nut is Dennis 428350
Rear Axle	Spring Brake (Type 9-47) 	656296	K2E4021	K2E4002X50	SLF up to Chassis 3938, left side Spring portion K2E0301X50 Diaphragm 272489
	Spring Brake (Type 9-47) 	656295	K2E4020	K2E4002X50	SLF up to Chassis 3938, right side Spring portion K2E0301X50 Diaphragm 272489
	Spring Brake (Type 9/16) 	657993	BY9113 II38097F	BY9113 II38097F	SLF from Chassis 3939 Spring portion II385130062 Diaphragm B74478 See Note
	Spring Brake (Type 12-65) 	657345	K2E4036	K2E4036X50	SPD, left side Spring Portion K2E0304X50 Diaphragm 234226K
	Spring Brake (Type 12-65) 	657344	K2E4035	K2E4035X50	SPD, right side Spring portion K2E0304X50 Diaphragm 234226K
	Spring Brake (Type 14/16) 	658499	BY9274 II39606F	BY9274 II39606F	SPD Spring portion II39608F0061 Diaphragm B79883

Note: The NG3 type Spring Brake BY9... and K2E type Spring Brakes must not be mixed on one axle. Replacement of K2E units by BY9... requires Elbow (Dennis 657240) and Adaptor (Dennis 654909-3). The Spring Portions are not interchangeable.

NOTE: X00 and X50 suffixes refer to Exchange Products which may be Remanufactured.

**Knorr-Bremse - 100 years
of innovation,
100% committed to
improving road safety**









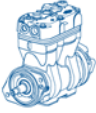
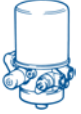

DENNIS (Alexander Dennis)

Enviro 200 & 300

4 x 2

Note: Alexander Dennis manufactures Enviro 200 and 300 chassis and fits Enviro 200 and 300 bodies onto them. However, they also fit the Enviro 200 and 300 bodies onto chassis from other manufacturers and other body builders fit bodies to the Enviro 200 and 300 chassis.

Air Suspension

Description	Dennis Part Number	OE Part Number	Replacement Knorr-Bremse Part No	Remarks Note: Left and Right refer to the side of the vehicle when viewed from the driver's seat facing forward.
Air Compressor (2W460R) 	658604-1	LP4865 K006613	LP4865 K006613X50	On Cummins ISBe engine 2 bolt flange, crankshaft has left hand M18 thread Cummins Part No. 3977147
Air Dryer 	658208	LA8227 II30181	LA8227 II30181	10.0 bar cut-out, Metric ports Replacement cartridge is 272897SP
Air Line Filter 	655710	Wabco 432 500 020 0	LA2103 I99660	For air suspension system
Four Circuit Protection Valve 	657367	Wabco 934 714 126 0	AE4615 II39140F	With "Safety Feature"
Charging Valve with Full Feedback 	655711	Wabco 434 100 037 0	DR4150 K000613 (see Remarks)	Set replacement valve to 1.6 bar
Single Check Valve 	654733	KW4455/1	KW4455/1	In auxiliary charge line M22 ports
Hand Control Valve 	657493	DPM92AB	DPM92AB	From 1998 With red handle knob
Dual Foot Valve 	660687	Wabco 461 318 609 0		Enviro 200 With Allison 2100 or Voith gearbox Replacement base valve is ADL 658719-1
Dual Foot Valve 	659319	Wabco 461 315 071 0		Enviro 300 With Allison T280R gearbox Replacement base valve is ADL 659319-1
Quick Release Valve 	661052	KX1294/4	KX1294/4	Enviro 300 M22 Supply port, M16 Delivery ports
Double Check Valve 	654734	295358	295358	
Relay Valve 	659372	AC574AXY	AC574AXY	

NOTE: X00 and X50 suffixes refer to Exchange Products which may be Remanufactured.









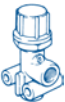
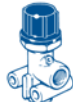

Enviro 200 & 300

4 x 2

Air Suspension

DENNIS (Alexander Dennis)

Note: Alexander Dennis manufactures Enviro 200 and 300 chassis and fits Enviro 200 and 300 bodies onto them. However, they also fit the Enviro 200 and 300 bodies onto chassis from other manufacturers and other body builders fit bodies to the Enviro 200 and 300 chassis.

Description	Dennis Part Number	OE Part Number	Replacement Knorr-Bremse Part No	Remarks Note: Left and Right refer to the side of the vehicle when viewed from the driver's seat facing forward.
Pressure Protection Valve (PR2) 	612049	277148	277148DK	5.9 bar, 1/4" NPTF ports
Pressure Reducing Valve (RV1) 	661077	KX2045/17000	KX2045/17000	With Voith gearbox 2.0 bar, M12 ports
Low Pressure Switch 	658977-B	295476	295476	5.4 bar, 1/4" NPTF thread Boot is 1190391
Stop Lamp Switch 	659171	274746	274746	1/4" NPTF thread
Tilt Drain Valve 	654728	VA12A	KW2350/2	M22 thread
Test Connector 	655026		KW4282/2	M16 thread
Exhaust Silencer 	658644	SIL68A	SIL68ASP	For Air Dryer Snap-on Alternative Silencers: 0484210017000 or ZB3163-192999
Exhaust Silencer 	656302	Wabco 432 407 012 0	SIL68ASP	For Foot Valve Snap-on Alternative Silencers: 0484210017000 or ZB3163-192999
Exhaust Silencer 	656589	0484210010000	0484210010000	8 mm hose fitting
Exhaust Silencer 	659280	0484210002000	0484210002000	M16 thread
ABS Modulator 	657942-2	Wabco 472 195 018 0	BR9156 II32612	
ABS Electronic Control Unit (ABS-E) 	660811	Wabco 446 004 607 0		











DENNIS (Alexander Dennis)

Enviro 200 & 300

4 x 2

Note: Alexander Dennis manufactures Enviro 200 and 300 chassis and fits Enviro 200 and 300 bodies onto them. However, they also fit the Enviro 200 and 300 bodies onto chassis from other manufacturers and other body builders fit bodies to the Enviro 200 and 300 chassis.

Air Suspension

Description	Dennis Part Number	OE Part Number	Replacement Knorr-Bremse Part No	Remarks <small>Note: Left and Right refer to the side of the vehicle when viewed from the driver's seat facing forward.</small>
ABS Wheel Speed Sensor 				Front axle
ABS Wheel Speed Sensor 	658685-30	Wabco 441 032 476 0		Rear axle Straight sensor, cable length 0.5 m
Air Suspension Levelling Valve 	655687	Wabco 464 006 002 0	SV1395 II19425 plus ZB3131 II19422	On suspension systems without ferry lift facility Lever & Rubber Link II19422
Air Suspension Levelling Valve 	651509	SV1351 I88579 K002334	SV1351 K002334	On suspension systems with ferry lift facility Valve has datum adjustment
Levelling Valve Linkage 	655691	Wabco 433 401 003 0	SEB00256	'In-line' bottom linkage
Solenoid Valve 	655776	Wabco 472 173 700 0	EDP26AA/1	On ramp interlock Normally 'Open', M12 ports, Kostal electrical connector. EDP26AA/1 has female Port 1
ECAS Three Solenoid Control Valve 	655713	Wabco 472 900 013 0		For air suspension and ferry lift systems
Air Suspension Single Solenoid Control Valve 	609355	454ATF		On suspension systems with ferry lift facility
Solenoid Valve 	658072	Wabco 472 172 600 0	EDP25AA/1	With Voith gearbox Normally 'Closed', M12 ports, Kostal electrical connector.
Pilot Valve (Foot Operated) 	657404	CP6A	CP6A	
External Charge Coupling 	658019			

NOTE: X00 and X50 suffixes refer to Exchange Products which may be Remanufactured.





Enviro 200 & 300





4 x 2

Air Suspension

DENNIS (Alexander Dennis)

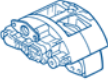
Note: Alexander Dennis manufactures Enviro 200 and 300 chassis and fits Enviro 200 and 300 bodies onto them. However, they also fit the Enviro 200 and 300 bodies onto chassis from other manufacturers and other body builders fit bodies to the Enviro 200 and 300 chassis.

	Description		Dennis Part Number	OE Part Number	Replacement Knorr-Bremse Part No	Remarks Note: Left and Right refer to the side of the vehicle when viewed from the driver's seat facing forward.
Front Axle	Brake Chamber (Type 16)		661269	Wabco 423 501 100 0	<i>BS3326</i> II38466F	Enviro 200 & 300, left side
	Brake Chamber (Type 16)		661270	Wabco 423 501 101 0	<i>BS3326</i> II38466F	Enviro 200 & 300, right side
Rear Axle	Spring Brake (Type 16/16)		661069	Wabco 925 464 452 0	<i>BS9397</i> II31227	Enviro 200, both sides
	Spring Brake (Type 16/16)		661135	Wabco 925 484 040 0	<i>BS9397</i> II31227	Enviro 300, left side
	Spring Brake (Type 16/16)		661136	Wabco 925 484 041 0	<i>BS9397</i> II31227	Enviro 300, right side













Front and Rear Axles	Air Disc Brake (PAN19-1 ^{plus})		659742	Wabco 40 195 019		Enviro 200 & 300, left side
	Air Disc Brake (PAN19-1 ^{plus})		659743	Wabco 40 195 020		Enviro 200 & 300, right side
	Disc Brake Pad Set		659742-1	Wabco 12 999 770		Enviro 200 & 300
Front Axle	Brake Disc		658621	Wabco 13 162 046		Enviro 200 & 300
Rear Axle	Brake Disc		658622	Wabco 13 162 047		Enviro 200 & 300

DENNIS (Alexander Dennis)

Enviro 400 4 x 2

Note: Alexander Dennis manufactures an Enviro 400 chassis and fits an Enviro 400 body onto it. However, they also fit the Enviro 400 body onto chassis from other manufacturers and other body builders fit bodies to the Enviro 400 chassis.

Air Suspension

Description	Dennis Part Number	OE Part Number	Replacement Knorr-Bremse Part No	Remarks Note: Left and Right refer to the side of the vehicle when viewed from the driver's seat facing forward.
Air Compressor (2W460R with Drive Gear) 		LP4862 K006610	LP4862 K006610X50	On Cummins ISC engine 2 bolt flange mounted Cummins Part No. 4929298
Air Dryer 	657516	LA8050 II37924	LA8050 II37924	10.0 bar cut-out, Metric ports Replacement cartridge is 272897SP
Air Line Filter 	655710	Wabco 432 500 020 0	LA2103 I99660	For air suspension system
Four Circuit Protection Valve 	656249	Wabco 934 714 125 0	AE4612 II38801F	With "Safety Feature"
Charging Valve with Full Feedback 	655711	Wabco 434 100 037 0	DR4150 K000613 (see Remarks)	For air suspension system. Set replacement valve to 1.6 bar
Single Check Valve 	654733	KW4455/1	KW4455/1	M22 ports
Hand Control Valve 	657493	DPM92AB	DPM92AB	With red handle knob
Dual Foot Valve 	660687	Wabco 461 318 609 0		With switched retarder control for Voith gearbox
Dual Foot Valve 	657186	Wabco 461 318 046 0		With pneumatic retarder control for ZF gearbox
Double Check Valve 	654734	295358	295358	M16 ports, bracket mounted
Relay Valve 	659372	AC574AXY	AC574AXY	
Stop Lamp Switch 	659171	274746	274746	1/4" NPTF thread (Boot is 1190391)

NOTE: X00 and X50 suffixes refer to Exchange Products which may be Remanufactured.













Enviro 400

4 x 2

Air Suspension

DENNIS (Alexander Dennis)

Note: Alexander Dennis manufactures an Enviro 400 chassis and fits an Enviro 400 body onto it. However, they also fit the Enviro 400 body onto chassis from other manufacturers and other body builders fit bodies to the Enviro 400 chassis.







Description		Dennis Part Number	OE Part Number	Replacement Knorr-Bremse Part No	Remarks Note: Left and Right refer to the side of the vehicle when viewed from the driver's seat facing forward.	
Low Pressure Switch		658977-A	295475	295475	6.0 bar, 1/4" NPTF thread	
		658977-B	295476	295476	5.4 bar, 1/4" NPTF thread (Boot is 1190391)	
Tilt Drain Valve		654728	VA12A	KW2350/2	M22 thread	
Test Connector		654499 655026		KW4282/2	M16 thread	
Test Connector		656246		AC784D	M22 thread	
Exhaust Silencer		656302	Wabco 432 407 012 0	SIL68ASP	For Foot Valve Snap-on Alternative Silencers: 0484210017000 or ZB3163-192999	
ABS Modulator		658879	0486201001000	BR9156 II32612		
Front Axle	ABS Wheel Speed Sensor		658470-52	0486000128100	0486000128100	Cable length 1.0 m Dana Part No. SM494/2K Sensor with Bush is 0486000136000
Rear Axle	ABS Wheel Speed Sensor		658517-26	0486000101000	0486000101000	Cable length 2.0 m ZF Part No. 0501 211 163
	ABS Electronic Control Unit (ABS 2X)		659974	0486104115000	0486104115100	J1939 CAN version
	Air Suspension Levelling Valve		660076	SV1494 K001885	SV1494 K002336	Front axle Horizontal mounting
	Air Suspension Levelling Valve		652582	SV1294 I80091	SV1294 I80091	Rear axle Vertical mounting
	Levelling Valve Linkage		660316	Wabco 428 901 921 2	ZB3117 SEB00256	Lower link



DENNIS (Alexander Dennis)

Enviro 400 4 x 2

Note: Alexander Dennis manufactures an Enviro 400 chassis and fits an Enviro 400 body onto it. However, they also fit the Enviro 400 body onto chassis from other manufacturers and other body builders fit bodies to the Enviro 400 chassis.

Air Suspension

Description	Dennis Part Number	OE Part Number	Replacement Knorr-Bremse Part No	Remarks Note: Left and Right refer to the side of the vehicle when viewed from the driver's seat facing forward.
ECAS Three Solenoid Control Valve 	656606	Wabco 472 900 014 0		Front kneel - one valve on front axle Full kneel - one valve on each axle
Air Suspension Single Solenoid Control Valve 	656607	Wabco 472 171 704 0		Front kneel - one valve on front axle Full kneel - one valve on each axle Normally 'Open', M12 ports, electrical connector DIN 72585 bayonet
Air Suspension Level Sensor 	654978-2	Wabco 441 050 006 0		
Pilot Valve (Foot Operated) 	657404	CP6A	CP6A	On steering column interlock
Solenoid Valve 	655776	Wabco 472 173 700 0	EDP26AA/1	On steering column interlock Normally 'Open', M12 ports, Kostal electrical connector. EDP26AA/1 has female Port 1
Pilot Valve (Air Operated)	660764			On steering column interlock
External Charge Coupling 	658019			

Front Axle	Brake Chamber (Type 22) 	659387-1	BS3471 K001214	BS3471 K001214 or BS3453 II31099	Left side Diaphragm C52066
	Brake Chamber (Type 22) 	659387-2	BS3472 K001215	BS3472 K001215 or BS3453 II31099	Right side Diaphragm C52066
Rear Axle	Spring Brake (Type 24/24) 	658517-38	BS9520 II34388	BS9520 II34388 or BS9500 K004050000	Spring Portion II175670061 Diaphragm B64322

NOTE: X00 and X50 suffixes refer to Exchange Products which may be Remanufactured.







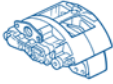

Enviro 400

4 x 2

Air Suspension

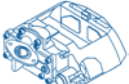
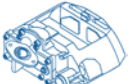
DENNIS (Alexander Dennis)

Note: Alexander Dennis manufactures an Enviro 400 chassis and fits an Enviro 400 body onto it. However, they also fit the Enviro 400 body onto chassis from other manufacturers and other body builders fit bodies to the Enviro 400 chassis.







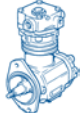
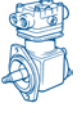

	Description	Dennis Part Number	OE Part Number	Replacement Knorr-Bremse Part No	Remarks Note: Left and Right refer to the side of the vehicle when viewed from the driver's seat facing forward.
Front Axle	Air Disc Brake (Axial) 	658470-42	SB7972 K002011	Caliper K005504	Left side up to mid 2007, actuator mounting 0° Isolated Tappet Kit K002424 Pad Set K006060 Pad Wear Indicator K000684
	Air Disc Brake (Axial) 	658470-43	SB7962 K002010	Caliper K005505	Right side up to mid 2007, actuator mounting 0° Isolated Tappet Kit K002424 Pad Set K006060 Pad Wear Indicator K000684
	Air Disc Brake (Axial) 		SN7350 K017478	Caliper K016515	Left side from mid 2007, actuator mounting 0° Isolated Tappet Kit K015542 Pad Set K020808 Pad Wear Indicator K000684
	Air Disc Brake (Axial) 		SN7340 K017477	Caliper K016516	Right side from mid 2007, actuator mounting 0° Isolated Tappet Kit K015542 Pad Set K020808 Pad Wear Indicator K000684
Rear Axle	Air Disc Brake (Radial) 	658517-36	SB7218 K010167	Caliper K005481	Left side, actuator mounting 93° Isolated Tappet Kit K002424 Pad Set K006060 Pad Wear Indicator K000684
	Air Disc Brake (Radial) 	658517-35	SB7208 K010166	Caliper K005482	Right side, actuator mounting 93° Isolated Tappet Kit K002424 Pad Set K006060 Pad Wear Indicator K000684
	Disc Brake Pad Set 	658470-41		K006060	SB7 Disc Brakes
	Disc Brake Pad Set 			K020808	SN7 Disc Brakes (front axle from mid 2007)
Front Axle	Brake Disc 	658470-39	Z000557	K013569	
Rear Axle	Brake Disc 	657303-126	II37191	II371910061	ZF axle ZF Part No. 0501 316 953

DENNIS (Alexander Dennis)

Bodied by Berghof (Excellence and Radial), Caetano (Algarve), Duple (300 and 320),
Plaxton (Paramount, Premiere and Profile) and Wadham Stringer/UVG (Vanguard)

Javelin 4 x 2

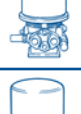
Air Suspension

Description	Dennis Part Number	OE Part Number	Replacement Knorr-Bremse Part No	Remarks Note: Left and Right refer to the side of the vehicle when viewed from the driver's seat facing forward.
Air Compressor (1W250D) 	652439	KZ1143/3	KZ1143/3X50	On Cummins B Series engine 2 bolt flange mounted, disc valve head Cummins Part No. 3279175
Air Compressor (1W250R) 	653613	1186551	1194215X50	On Cummins B Series engine 2 bolt flange mounted, reed valve head Cummins Part No. 3283968
Air Compressor (2W460R) 	659044	1194430	LP4865 K006613X50	On Cummins ISBe engine 2 bolt flange, crankshaft has right hand 5/8" UNF thread Cummins Part No. 4895964
Air Compressor (2W460R) 	658604	LP4858 K001095	LP4865 K006613X50	On Cummins ISBe engine 2 bolt flange, crankshaft has left hand M18 thread Cummins Part No. 3957727
Air Compressor (1W293R) 		Wabco 411 147 059 0		On Perkins engine
Governor Valve (D2) 	650057	277486	277486DK	9.0 bar cut-out, 1/8" NPTF ports
Air Dryer (AD2) 	652283	269827	269827X50	
Air Dryer (AD6-S) 	653865	1188801	LA8223 II30178-B	8.4 bar cut-out, Imperial ports Replacement cartridge for 1188801 is SK2914/1 and for II30178 is 272897SP
Air Dryer (AD6) 	656882	1194188	LA8226 II30180-B	8.4 bar cut-out, Metric ports Replacement cartridge is 272897SP
Air Dryer 	658209	LA8226 II30180	LA8226 II30180	8.4 bar cut-out, Metric ports Replacement cartridge is 272897SP
Condenser 	613553	KZ1291/2	KZ1291/1	

NOTE: X00 and X50 suffixes refer to Exchange Products which may be Remanufactured.



Javelin

4 x 2

Air Suspension

DENNIS (Alexander Dennis)

Bodied by Berghof (Excellence and Radial), Caetano (Algarve), Duple (300 and 320), Plaxton (Paramount, Premiere and Profile) and Wadham Stringer/UVG (Vanguard)

Description		Dennis Part Number	OE Part Number	Replacement Knorr-Bremse Part No	Remarks <small>Note: Left and Right refer to the side of the vehicle when viewed from the driver's seat facing forward.</small>
Four Circuit Protection Valve		650209	KY1671/1	VPS48AI	Imperial ports
Four Circuit Protection Valve		611970 655201	KY1671/14	VPS48HI	Imperial ports
Four Circuit Protection Valve		656249	Wabco 934 714 125 0	AE4612 II38801F	With "Safety Feature" Metric ports
Charging Valve with Full Feedback		655711	Wabco 434 100 037 0	DR4150 K000613 (see Remarks)	Set replacement valve to 1.6 bar
Single Check Valve		605293 612503	KW2966/1	KW2966/1	Early buses 1/2" NPTF ports
Single Check Valve		654733	KW4455/1	KW4455/1	Later buses M22 ports
Hand Control Valve (S4)		652405	KY2498/1	KY2498/1	Early buses
Hand Control Valve		657493	DPM92AB	DPM92AB	Later buses With red handle knob
Dual Foot Valve (E6)		611529	KY1916/1	KY1916/1	Replacement base valve is 295579
Dual Foot Valve		659764	Wabco 461 318 604 0		With potentiometer retarder control for ZF 5HP502C
Dual Foot Valve		651847	Wabco 461 324 008 0		With pneumatic retarder control
Pneumatic Control Valve		651487/1	Wabco 461 324 520 0		On Foot Valve

DENNIS (Alexander Dennis)

Bodied by Berghof (Excellence and Radial), Caetano (Algarve), Duple (300 and 320),
Plaxton (Paramount, Premiere and Profile) and Wadham Stringer/UVG (Vanguard)

Javelin 4 x 2

Air Suspension

Description	Dennis Part Number	OE Part Number	Replacement Knorr-Bremse Part No	Remarks Note: Left and Right refer to the side of the vehicle when viewed from the driver's seat facing forward.
Double Check Valve 	653877-6	Wabco 434 208 021 0	AE4100 I14911	M22 ports Bracket mounted.
Double Check Valve 	654734	295358	295358	M16 ports Bracket mounted
Relay Valve (R6) 	609010	280375	280375DK	Early buses
Relay Valve (R15) 	653885	1186715	AC574AXY	Later buses AC574AXY has built-in silencer
Relay Valve 	659372	AC574AXY	AC574AXY	
Quick Release Valve 	609011	274997	274997	Early buses Imperial ports
Quick Release Valve 	654757	KX1294/1	KX1294/1	Later buses Metric ports
Exhaust Silencer 	655136	KW4069/3	0484210002000	For Metric QRV M16 thread
Exhaust Silencer 	658644	SIL68A	SIL68ASP	For Air Dryer Snap-on Alternative Silencers: 0484210017000 or ZB3163-192999
Pressure Protection Valve (PR2) 	612049	277148	277148DK	5.9 bar, 1/4" NPTF ports
Differential Protection Valve 	650060	KX1058/1	KX1058/1	

NOTE: X00 and X50 suffixes refer to Exchange Products which may be Remanufactured.

Javelin





4 x 2

Air Suspension

DENNIS

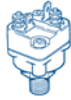
(Alexander Dennis)

Bodied by Berghof (Excellence and Radial), Caetano (Algarve), Duple (300 and 320), Plaxton (Paramount, Premiere and Profile) and Wadham Stringer/UVG (Vanguard)









Description		Dennis Part Number	OE Part Number	Replacement Knorr-Bremse Part No	Remarks <small>Note: Left and Right refer to the side of the vehicle when viewed from the driver's seat facing forward.</small>
Low Pressure Switch		610582/A	1185782	295476	5.4 bar, 1/4" NPTF thread
Stop Lamp Switch		605208	274746	274746	1/4" NPTF thread
Pressure Relief (Safety) Valve		613553-2	KX2073/7	KX2073/7	11 bar, 1/4" NPTF thread
Tilt Drain Valve		609956	KW2350/5	KW2350/1	1/2" NPTF thread
Tilt Drain Valve		654728	KW2350/2	KW2350/2	M22 thread
Test Connector		654499	KW4282/1	KW4282/2	M16 thread
ABS Modulator		653877-1	Wabco 472 195 004 0	BR9152 II16278	
ABS Wheel Speed Sensor		657082	Wabco 441 032 809 0	0486000136000	
ABS Electronic Control Unit		657082	Wabco (446 004 034 0) 446 004 064 0	0265150328000	
Air Suspension Levelling Valve		657160	SV1399 II30525	SV1399 II30525	Early buses
Air Suspension Levelling Valve		651509	SV1351 I88579	SV1351 K002334	Later buses
Air Suspension Level Sensor		654978-2	Wabco 441 050 006 0		

DENNIS (Alexander Dennis)

Bodied by Berghof (Excellence and Radial), Caetano (Algarve), Duple (300 and 320),
Plaxton (Paramount, Premiere and Profile) and Wadham Stringer/UVG (Vanguard)

Javelin 4 x 2

Air Suspension

	Description		Dennis Part Number	OE Part Number	Replacement Knorr-Bremse Part No	Remarks Note: Left and Right refer to the side of the vehicle when viewed from the driver's seat facing forward.
Front Axle - Drum Brakes	Brake Chamber (Type 24)		610579 610580	295332 295333	274423	1/4" NPTF ports, 5/8" UNF push rod, 57 mm stroke. Diaphragm 234100K
	Brake Chamber (Type 24)		653802	1188782-01	1188782-01	3/8" NPTF ports, 5/8" UNF push rod, 64 mm stroke. Diaphragm 234100K
Front Axle - Disc Brakes	Brake Chamber (Type 24)		415000 415001 415203	1189316 1189317 1194282	295555	On Meritor Disc Brake M16 ports, M16 push rod, 57 mm stroke. Diaphragm 234100K
Rear Axle - Drum Brakes	Spring Brake (Type 24-80)		652406	KZ1123/2	K2B0528X50	3/8" NPTF ports, 5/8" UNF push rod, 64 mm stroke. Diaphragm 234100K
	Spring Brake (Type 24-80)		654598	K2B1089	K2B0506X50	M16 ports, M16 push rod, 64 mm stroke. Diaphragm 234100K
Rear Axle - Disc Brakes	Spring Brake (Type 30-98)		654466	K2B1008	K2B0521X50	On Meritor Disc Brake M16 ports, M16 push rod, 64 mm stroke. Diaphragm 234101K
Front Axle	Automatic Slack Adjuster		651623	Haldex 72364	KB2375	127 mm hole centre Dana Part No. F4127/F
Rear Axle	Automatic Slack Adjuster		651626 652568	Haldex 72362	KB3095	127 mm hole centre
	Automatic Slack Adjuster		651777	Haldex 72367	KB2335	140 mm hole centre

NOTE: X00 and X50 suffixes refer to Exchange Products which may be Remanufactured.

Javelin









4 x 2

Air Suspension

DENNIS

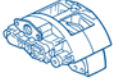
(Alexander Dennis)

Bodied by Berghof (Excellence and Radial), Caetano (Algarve), Duple (300 and 320), Plaxton (Paramount, Premiere and Profile) and Wadham Stringer/UVG (Vanguard)









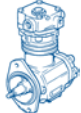
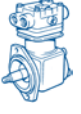

Description	Dennis Part Number	OE Part Number	Replacement Knorr-Bremse Part No	Remarks <small>Note: Left and Right refer to the side of the vehicle when viewed from the driver's seat facing forward.</small>
Air Disc Brake (D2) 		Meritor LRG530		Left side
Air Disc Brake (D2) 		Meritor LRG531		Right side
Disc Brake Pad Set (D2) 		Meritor MDP5027		
Brake Disc 		Meritor		
Air Disc Brake (D-Lisa) 	656564	Meritor LRG550		Left side
Air Disc Brake (D-Lisa) 	656565	Meritor LRG551		Right side
Disc Brake Pad Set (D-Lisa) 		Meritor MDP5019		
Brake Disc 	655750	Meritor		

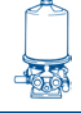
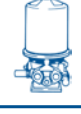
DENNIS (Alexander Dennis)

Lance + SLF 4 x 2

Bodied by Alexander (PS), Berkhof, East Lancs/Darwen (EL2000), Northern Counties (Paladin), Optare (Sigma), Plaxton (Verde) and Wrightbus (Pathfinder)

Air Suspension

Description	Dennis Part Number	OE Part Number	Replacement Knorr-Bremse Part No	Remarks Note: Left and Right refer to the side of the vehicle when viewed from the driver's seat facing forward.
Air Compressor (1W250D) 	652439	KZ1143/3	KZ1143/3X50	2 bolt flange mounted, disc valve head Cummins Part No. 3279175
Air Compressor (1W250R) 	653613	1186551	1194215X50	2 bolt flange mounted, reed valve head Cummins Part No. 3283968
Condenser 	654730	Haldex 92693		
Air Dryer (AD6-S) 	653865	1188801	LA8223 II30178-B	8.4 bar cut-out, Imperial ports Replacement cartridge for 1188801 is SK2914/1 and for II30178 is 272897SP
Air Dryer (AD6-S) 	654729	1194163	LA8227 II30181-B	SLF, 10 bar cut-out, Imperial ports, Replacement cartridge for 1188801 is SK2914/1 and for II30181 is 272897SP
Air Line Filter 	655710	Wabco 432 500 020 0	LA2103 I99660	SLF
Four Circuit Protection Valve 	655201	VPS48HI	VPS48HI	Imperial ports
Four Circuit Protection Valve 	654867	VPS45C	VPS45C	SLF Metric ports
Charging Valve with Full Feedback 	655711	Wabco 434 100 037 0	DR4150 K000613 (see Remarks)	SLF Set replacement valve to 1.6 bar
Single Check Valve 	605293	Wabco APSA/2099/2	KW2966/1	1/2" NPTF ports
Hand Control Valve (S4) 	652405	KY2498/1	KY2498/1	
Hand Control Valve 	654732	DPM94A	DPM94AAX	SLF

NOTE: X00 and X50 suffixes refer to Exchange Products which may be Remanufactured.

Lance + SLF

4 x 2

Air Suspension

DENNIS

(Alexander Dennis)

Bodied by Alexander (PS), Berkhof, East Lancs/Darwen (EL2000), Northern Counties (Paladin), Optare (Sigma), Plaxton (Verde) and Wrightbus (Pathfinder)









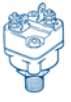

Description	Dennis Part Number	OE Part Number	Replacement Knorr-Bremse Part No	Remarks <small>Note: Left and Right refer to the side of the vehicle when viewed from the driver's seat facing forward.</small>
Dual Foot Valve (E6) 	611529	KY1916/1	KY1916/1	Replacement base valve is 295579
Dual Foot Valve 	651847	Wabco 461 315 495 0		With pneumatic retarder control
Dual Foot Valve 	651847	Wabco 461 324 008 0		SLF With pneumatic retarder control
Pneumatic Control Valve	651847-2	Wabco 461 324 520 0		On Foot Valve
Double Check Valve 	653877-6	Wabco 434 208 021 0	AE4100 I14911	M22 ports Bracket mounted.
Double Check Valve 	654734	295358	295358	M16 ports Bracket mounted
Relay Valve (R6) 	609010	280375	280375DK	Early buses
Relay Valve (R15) 	653885	1186715	AC574AXY	Later buses & SLF AC574AXY has built-in Silencer
Quick Release Valve 	609011	274997	274997	Early buses Imperial ports
Pressure Protection Valve (PR2) 	612049	277148	277148DK	5.9 bar, 1/4" NPTF ports
Differential Protection Valve 	650060	KX1058/1	KX1058/1	
Load Sensing Valve 	654731	Wabco 475 714 500 0		

DENNIS (Alexander Dennis)

Lance + SLF 4 x 2

Bodied by Alexander (PS), Berkhof, East Lancs/Darwen (EL2000), Northern Counties (Paladin), Optare (Sigma), Plaxton (Verde) and Wrightbus (Pathfinder)

Air Suspension

Description		Dennis Part Number	OE Part Number	Replacement Knorr-Bremse Part No	Remarks Note: Left and Right refer to the side of the vehicle when viewed from the driver's seat facing forward.
Low Pressure Switch		610582/A	1185782	295476	5.4 bar, 1/4" NPTF thread
Low Pressure Switch		654662	Wabco 441 014 025 0		SLF 6.0 bar, M12 thread
Stop Lamp Switch		605208	274746	274746	1/4" NPTF thread
Pressure Relief (Safety) Valve		613553-2	KX2073/7	KX2073/7	11 bar, 1/4" NPTF thread. Attached to AD6-S Air Dryer. Note: LA82.. Air Dryers have an integral Pressure Relief Valve
Pressure Relief (Safety) Valve		654729-1	KX1729/4	KX1729/4	SLF, 14 bar, M16 thread Attached to AD6-S Air Dryer Note: LA82.. Air Dryers have an integral Pressure Relief Valve
Drain Cock		607688	SF/1280	KW718/2	1/4" NPTF thread
Tilt Drain Valve		609956	Wabco 934 300 029 0	KW2350/1	1/2" NPTF thread
Test Connector		650367	KW3405/1	KW3405/1	1/4" NPTF thread
Test Connector		654499	KW4282/1	KW4282/2	M16 thread
Test Connector				AC784D	M22 thread

NOTE: X00 and X50 suffixes refer to Exchange Products which may be Remanufactured.

Lance + SLF











4 x 2

Air Suspension

DENNIS

(Alexander Dennis)

Bodied by Alexander (PS), Berkhof, East Lancs/Darwen (EL2000), Northern Counties (Paladin), Optare (Sigma), Plaxton (Verde) and Wrightbus (Pathfinder)





Description	Dennis Part Number	OE Part Number	Replacement Knorr-Bremse Part No	Remarks <small>Note: Left and Right refer to the side of the vehicle when viewed from the driver's seat facing forward.</small>
ABS Modulator 	653877-1	Wabco 472 195 004 0	<i>BR9152</i> II16278	
ABS Wheel Speed Sensor 		Wabco 441 032 578 0	0486000134000	Cable length 0.4 m
ABS Wheel Speed Sensor 		Wabco 441 032 579 0	0486000136000	Cable length 1.0 m
ABS Electronic Control Unit 	655640-1	Wabco 446 004 064 0	0265150328000	
Air Suspension Levelling Valve 	652582	<i>SV1294</i> 180091	<i>SV1294</i> K002335	With flat lever
Air Suspension Levelling Valve 	655687	Wabco 464 006 002 0	<i>SV1399</i> II30525 plus <i>ZB3131</i> II19422	SLF Wabco valve is supplied with round lever and rubber link
ECAS Six Solenoid Control Valve 	674978	Wabco 472 900 050 0		SLF
ECAS Solenoid Valve	654908	Wabco		SLF
ECAS Electronic Control Unit 	654978-1	Wabco 446 055 051 0		SLF
Air Suspension Level Sensor 	654978-2	Wabco 441 050 006 0		SLF
Solenoid Valve 	655776	Wabco 472 173 700 0	EDP26AA/1	SLF, for handbrake/kneeling interlock Normally 'Open', M12 ports, Kostal electrical connector. EDP26AA/1 has female Port 1
Pressure Reducing Valve (RV1) 	655021	KX2045/14	KX2045/14000	SLF 2.3 bar, M12 ports For brake interlock

DENNIS (Alexander Dennis)

Lance + SLF 4 x 2

Bodied by Alexander (PS), Berkhof, East Lancs/Darwen (EL2000), Northern Counties (Paladin), Optare (Sigma), Plaxton (Verde) and Wrightbus (Pathfinder)

Air Suspension

	Description		Dennis Part Number	OE Part Number	Replacement Knorr-Bremse Part No	Remarks Note: Left and Right refer to the side of the vehicle when viewed from the driver's seat facing forward.
Front Axle - Drum Brakes	Brake Chamber (Type 24) 		653802	1188782-01	1188782-01	3/8" NPTF ports, 5/8" UNF push rod, 64 mm stroke. Diaphragm 234100K
Front Axle - Disc Brakes	Brake Chamber (Type 16 LS) 		655081	Haldex 120916311	BZ3374 II33457A	SLF on Meritor Disc Brake M16 port, M16 push rod, 75 mm stroke Diaphragm 16LS
Rear Axle	Spring Brake (Type 30-80) 		652629	KZ1124/2	K2B0543X50	3/8" NPTF ports, 5/8" UNF push rod, 64 mm stroke. Spring portion K2B0043X50 Diaphragm 234101K
	Spring Brake (Type 30-98) 		654466	K2B1008	K2B0521X50	Later Lance & SLF M16 ports, M16 push rod, 64 mm stroke. Spring portion K2B0021X50 Diaphragm 234101K

Front Axle	Automatic Slack Adjuster 		651623	Haldex 72364	KB2375	127 mm hole centre
	Automatic Slack Adjuster 		611484	Haldex 70859	KB2325	140 mm hole centre
Rear Axle	Automatic Slack Adjuster 		652568	Haldex 72362	KB3095	127 mm hole centre
	Automatic Slack Adjuster 		651777	Haldex 72367	KB2335	140 mm hole centre

NOTE: X00 and X50 suffixes refer to Exchange Products which may be Remanufactured.

Lance + SLF





4 x 2

Air Suspension

DENNIS

(Alexander Dennis)

Bodied by Alexander (PS), Berkhof, East Lancs/Darwen (EL2000), Northern Counties (Paladin), Optare (Sigma), Plaxton (Verde) and Wrightbus (Pathfinder)

	Description	Dennis Part Number	OE Part Number	Replacement Knorr-Bremse Part No	Remarks <small>Note: Left and Right refer to the side of the vehicle when viewed from the driver's seat facing forward.</small>
Front Axle	Air Disc Brake (D2) 		Meritor LRG528		SLF Left side
	Air Disc Brake (D2) 		Meritor LRG529		SLF Right side
	Disc Brake Pad Set (D2) 		Meritor MDP5000		
	Brake Disc 				









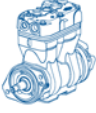

Knorr Bremse genuine parts - simply the best!

DENNIS (Alexander Dennis)

Bodied by Alexander (ALX400), East Lancs/Darwen (Lolyne) and Plaxton (President)

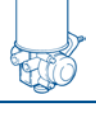
Trident II 4 x 2

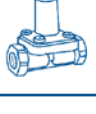
Air Suspension

Description	Dennis Part Number	OE Part Number	Replacement Knorr-Bremse Part No	Remarks Note: Left and Right refer to the side of the vehicle when viewed from the driver's seat facing forward.
Air Compressor (2W460R) 	657463	1194275	LP4864 K006612X50	2 bolt flange mounted Cummins Part Nos. 3284281 & 3286903
Air Compressor (2W460R) 	658878-1	1194425	LP4861 K006608X50	On Cummins ISC engine 2 bolt flange mounted Cummins Part No. 3286449
Air Compressor (2W460R) 		LP4861 K006608	LP4861 K006608X50	On Cummins ISC engine 2 bolt flange mounted Cummins Part No. 4929297
Air Compressor (2W460R with Drive Gear) 		1194458	LP4862 K006610X50	On Cummins ISC engine 2 bolt flange mounted Cummins Part No. 3286978
Air Compressor (2W460R with Drive Gear) 		LP4862 K006610	LP4862 K006610X50	On Cummins ISC engine 2 bolt flange mounted Cummins Part No. 4929298
Air Dryer 	658011	Haldex 87189	LA8050 II37924-B	Up to Chassis No. 1298 10.0 bar cut-out LA8050-II37924 may need to be raised 50mm to provide ground clearance.
Air Dryer 	657516	LA8050 II37924	LA8050 II37924	10.0 bar cut-out, Metric ports Replacement cartridge is 272897SP
Air Line Filter 	655710	Wabco 432 500 020 0	LA2103 I99660	For air suspension system
Four Circuit Protection Valve 	656249	Wabco 934 714 125 0	AE4612 II38801F	With "Safety Feature"
Charging Valve with Full Feedback 	655711	Wabco 434 100 037 0	DR4150 K000613 (see Remarks)	For air suspension system. Set replacement valve to 1.6 bar
Single Check Valve 	654733	KW4455/1	KW4455/1	M22 ports
Hand Control Valve 	657493	DPM92AB	DPM92AB	With red handle knob

NOTE: X00 and X50 suffixes refer to Exchange Products which may be Remanufactured.

Trident II

4 x 2

Air Suspension

DENNIS

(Alexander Dennis)

Bodied by Alexander (ALX400), East Lancs/Darwen (Lolyne) and Plaxton (President)











	Description	Dennis Part Number	OE Part Number	Replacement Knorr-Bremse Part No	Remarks Note: Left and Right refer to the side of the vehicle when viewed from the driver's seat facing forward.
	Dual Foot Valve 	657185	Wabco 461 318 025 0 461 318 655 0		With switched retarder control for Voith gearbox
	Dual Foot Valve 	657186	Wabco 461 318 046 0		With pneumatic retarder control for ZF gearbox
	Double Check Valve 	654734	295358	295358	M16 ports, bracket mounted
	Relay Valve (R15) 	653885	1186715	AC574AXY	AC574AXY has integral silencer
	Relay Valve 	659372 653885	AC574AXY	AC574AXY	
	Stop Lamp Switch 	605208 659171	274746	274746	1/4" NPTF thread
	Tilt Drain Valve 	654728	VA12A	KW2350/2	M22 thread
	Test Connector 	654499 655026		KW4282/2	M16 thread
	Exhaust Silencer 	656302	Wabco 432 407 012 0	SIL68ASP	For Foot Valve Snap-on Alternative Silencers: 0484210017000 or ZB3163-192999
	ABS Modulator 	658879	0486201001000	BR9156 II32612	From Chassis No. 1299
Front Axle	ABS Wheel Speed Sensor 		ES5021 II16764	0486000128100	Cable length 1.0 m From Chassis No. 1299, Dana Part No. SM494/2K, Sensor with Bush is 0486000136000
Rear Axle	ABS Wheel Speed Sensor 		0486000101000	0486000101000	Cable length 2.0 m From Chassis No. 1299, ZF Part No. 0501 211 163

DENNIS (Alexander Dennis)

Bodied by Alexander (ALX400), East Lancs/Darwen (Lolyne) and Plaxton (President)

Trident II 4 x 2

Air Suspension

Description	Dennis Part Number	OE Part Number	Replacement Knorr-Bremse Part No	Remarks <small>Note: Left and Right refer to the side of the vehicle when viewed from the driver's seat facing forward.</small>
ABS Electronic Control Unit (ABS 2X) 	658880	0486104104000	0486104104100	Up to Jan 2003 Non-CAN version
ABS Electronic Control Unit (ABS 2X) 	659974	0486104115000	0486104115100	From Jan 2003 J1939 CAN version
Air Suspension Levelling Valve 	655687	Wabco 464 006 002 0	SV1395 II19425 plus ZB3131 II19422	Up to Dec 2002 On suspension systems without ferry lift facility. Lever & Rubber Link II19422
Air Suspension Levelling Valve 	660076	SV1494 K001885	SV1494 K002336	From Jan 2003 Front axle Horizontal mounting
Air Suspension Levelling Valve 	652582	SV1294 I80091	SV1294 K002335	From Jan 2003 Rear axle Vertical mounting
Levelling Valve Linkage 	655691	Wabco 433 401 003 0	ZB3117 SEB00256	
ECAS Three Solenoid Control Valve 	654662 656606	Wabco 472 900 008 0		Front kneel - one valve on front axle Full kneel - one valve on each axle
Air Suspension Single Solenoid Control Valve 	656607	Wabco 472 171 726 0		Front kneel - one valve on front axle Full kneel - one valve on each axle Normally 'Open', M12 ports, electrical connector DIN 72585 bayonet
Air Suspension Level Sensor 	654978-2	Wabco 441 050 006 0		
Pilot Valve (Foot Operated) 	657404	CP6A	CP6A	

NOTE: X00 and X50 suffixes refer to Exchange Products which may be Remanufactured.

Trident II



4 x 2





Air Suspension

DENNIS

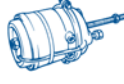
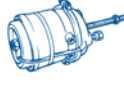
(Alexander Dennis)

Bodied by Alexander (ALX400), East Lancs/Darwen (Lolyne) and Plaxton (President)

	Description		Dennis Part Number	OE Part Number	Replacement Knorr-Bremse Part No	Remarks Note: Left and Right refer to the side of the vehicle when viewed from the driver's seat facing forward.
Front Axle with Drum Brakes	Brake Chamber (Type 24)		423749	1194259	295555	Left side Up to Chassis No. 1298 Diaphragm 234100K
	Brake Chamber (Type 24)		423750	1194258	295555	Right side Up to Chassis No. 1298 Diaphragm 234100K
Rear Axle with Drum Brakes	Spring Brake (Type 27-98)		656471	K2B1171	K2B0517X50	Up to Chassis No. 0131 Diaphragm 1190023
	Spring Brake (Type 24-98)		657687	K2B0513	K2B0513X50	From Chassis No. 0132 to 1298 Diaphragm 234100K











Front Axle with Drum Brakes	Automatic Slack Adjuster		656007-30	Haldex 79157	KB3330	Left side 38 mm offset, 165 mm hole centre
	Automatic Slack Adjuster		656007-29	Haldex 79156	KB3325	Right side 38 mm offset, 165 mm hole centre
Rear Axle with Drum Brakes	Automatic Slack Adjuster		656995-104	Haldex 79429	KB3180	Left side 25 mm offset, 145 mm hole centre
	Automatic Slack Adjuster		656995-105	Haldex 79430	KB3175	Right side 25 mm offset, 145 mm hole centre

DENNIS (Alexander Dennis)

Bodied by Alexander (ALX400), East Lancs/Darwen (Lolyne) and Plaxton (President)

Trident II 4 x 2

Air Suspension

	Description	Dennis Part Number	OE Part Number	Replacement Knorr-Bremse Part No	Remarks Note: Left and Right refer to the side of the vehicle when viewed from the driver's seat facing forward.
Front Axle with Disc Brakes	Brake Chamber (Type 24) 	658470-47	BS2505 II39964F	BS2505 II39964F or BS3509 II30618	Left side From Chassis No. 1299 up to Jan 2003 Diaphragm B64322
	Brake Chamber (Type 22) 	659387-1	BS3471 K001214	BS3471 K001214 or BS3453 II31099	Left side From Jan 2003 Diaphragm C52066
	Brake Chamber (Type 24) 	658470-48	BS2506 II39965F	BS2506 II39965F or BS3509 II30618	Right side From Chassis No. 1299 up to Jan 2003 Diaphragm B64322
	Brake Chamber (Type 22) 	659387-2	BS3472 K001215	BS3472 K001215 or BS3453 II31099	Right side From Jan 2003 Diaphragm C52066
Rear Axle Disc Brakes	Spring Brake (Type 24/24) 	658517-38	BS9520 II34388	BS9520 II34388 or BS9500 K004050000	From Chassis No. 1299 Spring Portion II175670061 Diaphragm B64322
Front Axle	Air Disc Brake (Axial) 	658470-42	SB7873 - Z0017952 SB7919 - K000553 SB7972 - K002011	Caliper K005504	Left side, actuator mounting 0° Isolated Tappet Kit K002424 Pad Set K006060 Pad Wear Indicator K000684
	Air Disc Brake (Axial) 	658470-43	SB7863 - Z0017951 SB7909 - K000552 SB7962 - K002010	Caliper K005505	Right side, actuator mounting 0° Isolated Tappet Kit K002424 Pad Set K006060 Pad Wear Indicator K000684
Rear Axle	Air Disc Brake (Radial) 	658517-36	SB7133 - II37813 SB7211 - K000486 SB7973 - K002013 SB7218 - K010167	Caliper K005481	Left side, actuator mounting 93° Isolated Tappet Kit K002424 Pad Set K006060 Pad Wear Indicator K000684
	Air Disc Brake (Radial) 	658517-35	SB7123 - II37812 SB7201 - K000485 SB7963 - K002012 SB7208 - K010166	Caliper K005482	Right side, actuator mounting 93° Isolated Tappet Kit K002424 Pad Set K006060 Pad Wear Indicator K000684
	Disc Brake Pad Set 	658470-41		K006060	

NOTE: X00 and X50 suffixes refer to Exchange Products which may be Remanufactured.



Trident II

4 x 2







Air Suspension

DENNIS (Alexander Dennis)

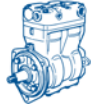

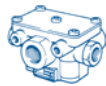
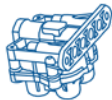

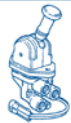
Bodied by Alexander (ALX400), East Lancs/Darwen (Lolyne) and Plaxton (President)





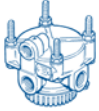

	Description	Dennis Part Number	OE Part Number	Replacement Knorr-Bremse Part No	Remarks Note: Left and Right refer to the side of the vehicle when viewed from the driver's seat facing forward.
Front Axle	Brake Disc 	658470-39	Z000557	K013569	
Rear Axle	Brake Disc 	657303-126	II37191	II371910061	ZF axle ZF Part No. 0501 316 953

Genuine Knorr-Bremse
product costs less on a
pence per mile basis



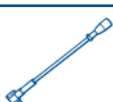



Description		Irisbus Part Number	OE Part Number	Replacement Knorr-Bremse Part No	Remarks Note: Left and Right refer to the side of the vehicle when viewed from the driver's seat facing forward.
Air Compressor (2W600R)		5003 29613	ACX83DX K007304	ACX83DX K007304	4 bolt flange mounted. Compressor with through drive (do not confuse with ACX83D non-through drive compressor)
Air Compressor (2W630R)		4121 1340	LK4936 K001126	LK4936 K001126X00	3 bolt flange mounted, with through drive
Air Dryer		4205 8277	LA6215 I89326	LA8242 II30650N00	11 bar cut-out. Replacement cartridge is 272897SP
Air Dryer		5006 144044	LA8069 K004692	LA8069 K004692	12.2 bar cut-out, with timed purge. Replacement cartridge is 272897SP
Four Circuit Protection Valve		9840 0429	VPS45A	VPS45A	
Four Circuit Protection Valve		5006-143813	AE4605 II36650	AE4605 II36650	Flange mounted
Single Check Valve		0470 0995	AE5102 I60422	AE5102 I60422	M22(F) ports
Hand Control Valve		4100 2768	DPM94AAX	DPM94AAX	
Hand Control Valve		5010 485059	DPM63AX	DPM63AX	
Dual Foot Valve		5003 17963	DX75BA	DX75BAY	DX75BAY has integral silencer





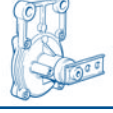

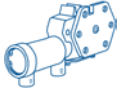
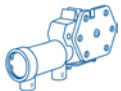
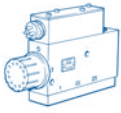
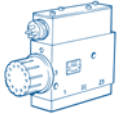
NOTE: X00 and X50 suffixes refer to Exchange Products which may be Remanufactured.



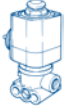





Description		Irisbus Part Number	OE Part Number	Replacement Knorr-Bremse Part No	Remarks Note: Left and Right refer to the side of the vehicle when viewed from the driver's seat facing forward.
Anti-compounding Relay Valve		5006 303955	AC586AAX	AC586AAX	
Relay Valve		5010 260468	0481026026000	0481026026000	
Relay Valve		4103 1426	AC574AXY	AC574AXY	AC574AXY has integral silencer
Pressure Proportioning Valve		0473 8490	DB2121 I86157	DB2121 I86157	
Pressure Limiting Valve		0816 9586	AC156B	AC156B	8.5 bar, M16 ports
Low Pressure Switch		8025 002350	INT46E	INT46E	5.8 bar, M20 thread, M28x1.5 electrical connector (Lucar terminals)
Low Pressure Switch		5040 31141	INT46G		4.5 bar, M20 thread, M28x1.5 electrical connector (Lucar terminals)
Low Pressure Switch		0474 5805	IB20BA	IB20BA	5.5 bar, M20 thread, M28x1.5 electrical connector (Lucar terminals)
Low Pressure Switch		0474 5806	IB20EA	IB20EA	5.8 bar, M20 thread, M28x1.5 electrical connector (Lucar terminals)
Exhaust Silencer		4253 1613 5006 304173	0484210001000 SIL68B	SIL68B	M22 thread Alternative Silencers: 0484210001000 or ZB3150-178074
Exhaust Silencer		5040 67101	0484210017000	SIL68ASP	For use on Air Dryers Snap-on Alternative Silencers: 0484210017000 or ZB3163-192999
Exhaust Silencer		4212 2650	ZB3163 192999	SIL68ASP	Snap-on Alternative Silencers: 0484210017000 or ZB3163-192999







Description	Irisbus Part Number	OE Part Number	Replacement Knorr-Bremse Part No	Remarks <small>Note: Left and Right refer to the side of the vehicle when viewed from the driver's seat facing forward.</small>
ABS Modulator 	5006 143819	BR9154 II17776	BR9154 II17776N00	M22 Voss ports
ABS Wheel Speed Sensor 	5041 49846	0486001066000	0486001066100	Straight sensor, cable length 1.7 m, round socket
ABS Wheel Speed Sensor 	5041 49847	0486001077000	0486001077100	Straight sensor, cable length 2.05 m, round plug
ABS Wheel Speed Sensor 	5006 143953 5010 344190	0486000041000	0486000041000	Left side 90° sensor, cable length 2.0 m, round socket
ABS Wheel Speed Sensor 	5040 06366 5010 344189	0486000042000	0486000183100	Right side 90° sensor, cable length 1.99 m, round plug
ABS Wheel Speed Sensor 	5041 33882	0486000182000	0486000182100	Left side 90° sensor, cable length 2.0 m, round socket
ABS Wheel Speed Sensor 	5041 33883	0486000183000	0486000183100	Right side 90° sensor, cable length 1.99 m, round plug
ABS Electronic Control Unit (EU12) 	5006 142737	0486104050000	0486104050100	
ABS Electronic Control Unit (ABS6) 	5040 89276	0486107103000	0486107103100	
ABS Electronic Control Unit (ABS6) 	5041 00391	0486107108000	0486107108100	





NOTE: X00 and X50 suffixes refer to Exchange Products which may be Remanufactured.

Description		Irisbus Part Number	OE Part Number	Replacement Knorr-Bremse Part No	Remarks <small>Note: Left and Right refer to the side of the vehicle when viewed from the driver's seat facing forward.</small>
Air Suspension Levelling Valve		9944 4042	0500005101000	0500005101000	
Air Suspension Levelling Valve		9944 4043	0500005102000	0500005102000	
Air Suspension Level Sensor		5010 207803	0504002110000	0504002110000	
Air Suspension Height Control Element		9944 4041	0504003001000	0504003001000	Both sides
Air Suspension Height Control Element		5040 45232	0504003003000	0504003003100	Left side
Air Suspension Height Control Element		5040 45231	0504003004000	0504003004100	Right side
Air Suspension Control Module		5010 207861	0501100016000	0501100041100	With kneeling function
Air Suspension Control Module		5010 347767	0501100025000	0501100025000	Without kneeling function
Air Suspension Electronic Control Unit		5010 393211	0504004112000		No longer available
Air Suspension Electronic Control Unit		5041 00354	0504004114000	0504004114000	

Description	Irisbus Part Number	OE Part Number	Replacement Knorr-Bremse Part No	Remarks Note: Left and Right refer to the side of the vehicle when viewed from the driver's seat facing forward.
Solenoid Valve 	5040 06338	0481511105000	0481511105000	DIN 72585 bayonet electrical connector
Solenoid Valve	0475 0603	CPE2H	CPE2H	Push-in electrical connectors
Rotary Switch Valve 	9944 4040	0481007039000	0481007039000	
Electronic Throttle Control 	4121 5902 4121 7741	Wabco 965 100 001 0		Throttle pedal box
Horn Distributor Valve	0475 0599	DPE1GB	DPE1GB	
Horn 	8025 000987	TP6A		No longer available
Horn 	8025 000986	TP5A		No longer available
Clutch Servo 	9843 8178	VG3264 II35696	VG3288 K004296	
Clutch Servo 	4103 5646	VG3288 K004296	VG3288 K004296	

	Description		Irisbus Part Number	OE Part Number	Replacement Knorr-Bremse Part No	Remarks Note: Left and Right refer to the side of the vehicle when viewed from the driver's seat facing forward.
Front Axle with Drum Brakes	Brake Chamber (Type 12)		0483 5038	EF120FY	EF120FY	Diaphragm 234226K
	Brake Chamber (Type 18)		9945 9885	EF180FY	EF180FY	Diaphragm 234189K
Rear Axle with Drum Brakes	Spring Brake (Type 12/20HF)		5040 07758	BY9230 II39595F	BY9230 II39595F	Diaphragm B74479
	Spring Brake (Type 14/20)		9944 6701	BY9251 II17472	BY9251 II17472	Diaphragm 234189K
	Spring Brake (Type 18/24HF)		0818 9492	BY9350 I98822	BY9350 I98822	Diaphragm 234189K
	Spring Brake (Type 18/24HF)		0816 9240	BY9351 II16159	BY9351 II16159	Diaphragm 234189K
	Spring Brake (Type 20/24HF)		0816 9241	BY9401 II16160	BY9401 II16160	Diaphragm B61184
	Spring Brake (Type 22/24HF)		4100 6333	BY9451 II17755	BY9451 II17755	Diaphragm C52066

	Description		Irisbus Part Number	OE Part Number	Replacement Knorr-Bremse Part No	Remarks Note: Left and Right refer to the side of the vehicle when viewed from the driver's seat facing forward.
Front Axle with Disc Brakes	Brake Chamber (Type 12)		4103 1955 4121 1446	BS3201 II36967 K008766	BS3201 K008766	Diaphragm C34578F
	Brake Chamber (Type 16))		4103 1957 4121 1452	BS3313 II36969 K003840	BS3313 K003840	Diaphragm C72596
	Brake Chamber (Type 18)		4103 1958 4121 1454	BS3354 II36778 K003030	BS3354 K003030	Diaphragm C72231
	Brake Chamber (Type 22)		4103 1960 4121 1458	BS3458 II36780 K003012	BS3458 K003012	Diaphragm C72337
Rear Axle with Disc Brakes	Spring Brake (Type 20/24)		5040 45655	BS8452 K000699	BS8452 K000699	Diaphragm C72336
	Spring Brake (Type 20/24)		5040 43975	BS8453 K000700	BS8453 K000700	Diaphragm C72336







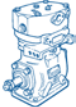
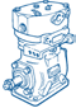

Air Disc Brake		9945 8477	SB7906 K000412	Caliper K004579	Actuator mounting -12° Pad Set K001104 Pad Wear Indicator K000684 Guide Pins & Bushes K000375 Tappet & Boot Kit K010604
Air Disc Brake		9945 8478	SB7916 K000413	Caliper K004578	Actuator mounting -12° Pad Set K001104 Pad Wear Indicator K000684 Guide Pins & Bushes K000375 Tappet & Boot Kit K010604
Air Disc Brake		4121 1286 4128 5001	SN7066 K000474 K004625 K007765	Caliper K004579	Actuator mounting -12° Pad Set K001104 Pad Wear Indicator K000684 Guide Pins & Bushes K000472 Tappet & Boot Kit K010603
Air Disc Brake		4121 1287 4128 5002	SN7076 K000475 K004626 K007766	Caliper K004578	Actuator mounting -12° Pad Set K001104 Pad Wear Indicator K000684 Guide Pins & Bushes K000472 Tappet & Boot Kit K010603
Disc Brake Pad Set				K001104	

NOTE: X00 and X50 suffixes refer to Exchange Products which may be Remanufactured.

**Knorr-Bremse Product
Quality = Passenger Safety
+ Best Value for you**

Bodied by Alexander, C.H. Roe, Eastern Coach Works,
Northern Counties and Optare

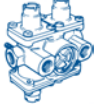
Mechanical & Air Suspension

Description	Leyland Part Number	OE Part Number	Replacement Knorr-Bremse Part No	Remarks <small>Note: Left and Right refer to the side of the vehicle when viewed from the driver's seat facing forward.</small>
Air Compressor (Tu-Flo 500) 	ACU 5896	274838	274838X50	On Gardner engine
Air Compressor (Tu-Flo 700) 	LB 10609	101255	101255RM	On Gardner engine
Air Compressor (TC15) 	AAU 3958	Wabco PCGA 769/AX		On Gardner engine
Air Compressor (Twin Cylinder) 	HAI 1759 HAI 9676	Wabco PCGA 995		On Leyland TL11 engine
Air Compressor (Single Cylinder)		Cummins 3251987		On Cummins engine
Air Compressor (Twin Cylinder)		Cummins 3067469		On Cummins engine
Governor Valve (D2) 	AAU 3506	277812	275491DK	8.3 bar Cut-out
Unloader Valve 	CAL 0778	Wabco APSA 2878/S1 975 390 043 0		
Air Dryer (AD2) 	ACU 2307	267000	269827X50	
Alcohol Evaporator 	10903646	282486	228663DK	Vehicles without Air Dryer
Three Circuit Protection Valve 	ACU 3864	KY1671/12	VPS38AIY	
Three Circuit Protection Valve 	BCU 6443	Wabco 934 711 001 0		

NOTE: X00 and X50 suffixes refer to Exchange Products which may be Remanufactured.

Bodied by Alexander, C.H. Roe, Eastern Coach Works,
Northern Counties and Optare

Description	Leyland Part Number	OE Part Number	Replacement Knorr-Bremse Part No	Remarks <small>Note: Left and Right refer to the side of the vehicle when viewed from the driver's seat facing forward.</small>
Single Circuit Protection Valve 	AAU 5633	KW4081/1	KW4081/1	
Single Circuit Protection Valve 	CAL 3109	Wabco APSA 7335/X	KW4081/1	
Hand Control Valve (S2) 	CAL 3605	KY932/7	KY932/7	
Hand Control Valve 	ABU 7384	Wabco APGA 6377/F	KY932/7	
Hand Control Valve 	BCU5532 ACU 9400	Wabco APGA 6710/B 961 710 001 0		
Dual Foot Valve (Delta) 	10885467	KY930/5	Obsolete	Service Kit SK2652/1
Dual Foot Valve (DB3) 	AAU 2959	Wabco APGA 6656		
Dual Foot Valve 	ACU 5113	Wabco APGA 6653		
Double Check Valve 	585179 528984	295036	295036	
Relay Valve (R6) 	CAL 0992 1089854 1692Z165	280375	280375DK	
Relay Valve 	3173150 3173824	0481026032000	AC574AXY	AC574AXY has integral silencer
Mini Relay Valve 	BCU 2601	Wabco APSA 10473/1	267114 See Remarks	Use of 267114 requires 1/2" NPTF to 3/8" NPTF Adapter. Also bracket position & hole spacing are different

Bodied by Alexander, C.H. Roe, Eastern Coach Works,
Northern Counties and Optare



Mechanical & Air Suspension

Description	Leyland Part Number	OE Part Number	Replacement Knorr-Bremse Part No	Remarks <small>Note: Left and Right refer to the side of the vehicle when viewed from the driver's seat facing forward.</small>
Quick Release Valve 	10898550 10898797	274999	274999	
Exhaust Check Valve 	ACU 2709	KX2016/1	KX2016/1	For Quick Release Valve
Pressure Protection Valve 	1089098	KX1248/2	SKX1248/1 See Remarks	Set replacement valve to 4.1 bar. 1/2" NPTF ports
Pressure Protection Valve (PR1) 	823523 ACU 4952	274785	274785	4.8 bar, 1/4" NPTF ports
Low Pressure Switch 	CAL 0129 AAU 2497	295482	295476	5.4 bar, 1/4" NPTF thread
Stop Lamp Switch 	CAL 0984	Wabco APSA 4872	274746	1/4" NPTF thread
Pressure Relief (Safety) Valve 	13H7035	KX175/1	KX175/1	11 bar, 1/4" NPTF thread
Automatic Drain Valve 	ABU 9983	Wabco APSA 7440/1	KX2068/1	1/2" NPTF thread
Drain Cock 	528174	KW718/1	KW718/2	1/4" NPTF thread
Tilt Drain Valve 	AJU 1653	KW2350/5	KW2350/1	1/2" NPTF thread
Test Connector 	ACU 3400	KW3405/1	KW3405/1	1/4" NPTF thread
Air Suspension Levelling Valve 		Dunlop PNP 311 600 201	SV1294 K002335	

NOTE: X00 and X50 suffixes refer to Exchange Products which may be Remanufactured.

Mechanical & Air Suspension







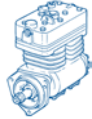

Bodied by Alexander, C.H. Roe, Eastern Coach Works,
Northern Counties and Optare

	Description		Leyland Part Number	OE Part Number	Replacement Knorr-Bremse Part No	Remarks Note: Left and Right refer to the side of the vehicle when viewed from the driver's seat facing forward.
Front Axle	Brake Chamber (Type 30) 		ACU 3577	267094	1189182 or 274424	Diaphragm 234101K
Rear Axle	Spring Brake (Type 30-STD LS) 		ACU 4022	KZ488/5	K2C2004X50	Diaphragm 234101K

Front Axle	Automatic Slack Adjuster 		ACU 3627	Haldex 70943	KB2475	Left side 16 mm offset, 155 mm hole centre
	Automatic Slack Adjuster 		ACU 3628	Haldex 70944	KB2480	Right side 16 mm offset, 155 mm hole centre
	Automatic Slack Adjuster 		BCU 5767	Haldex 72439	KB2345	Left side 16 mm offset, 155 mm hole centre
	Automatic Slack Adjuster 		BCU 5768	Haldex 72440	KB2350	Right side 16 mm offset, 155 mm hole centre
Rear Axle	Automatic Slack Adjuster 		BCU2077 NRK3115	Haldex 72168 72559		Left side 47.6 mm offset, 152 mm hole centre
	Automatic Slack Adjuster 		NRK3116	Haldex 72169 72560		Right side 47.6 mm offset, 152 mm hole centre
	Automatic Slack Adjuster 		ACU 3629	Haldex 70945	KB2315	Left & right side 180 mm hole centre
	Automatic Slack Adjuster 		BCU 5769	Haldex 72441	KB2340	Left & right side 165 mm hole centre

Bodied by East Lancs/Darwen (Esteem and Myllemium),
Marshall/MCV (Evolution and Stirling) and Plaxton (Centro)

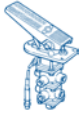
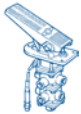
Air Suspension

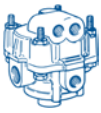
Description	MAN Part Number	OE Part Number	Replacement Knorr-Bremse Part No	Remarks <small>Note: Left and Right refer to the side of the vehicle when viewed from the driver's seat facing forward.</small>
Air Compressor (2W600R) 	51.54100-7069	LK4939 K001998		12.240 vehicle MAN only
Air Compressor				14.220 vehicle
Air Dryer 	81.52102-6103	LA8210 II19207	LA8210 II19207	10 bar cut-out Replacement cartridge is 272897SP
Air Dryer 	81.52102-6104	Wabco 432 410 116 0	LA8210 II19207	10 bar cut-out Replacement cartridge is 272897SP
Four Circuit Protection Valve 	81.52151-6073	AE4422 II18172	AE4422 II18172	
Single Check Valve 	81.52120-6025	AE5102 I60422	AE5102 I60422	On outlet from Air Dryer
Hand Control Valve 	81.52315-6086	HB1189 I92190	HB1189 I92190	
Hand Control Valve 	81.52315-6090	Wabco 961 722 262 0	HB1189 I92190	
Dual Foot Valve 	81.52310-6098	MB4745 I89741	MB4745 I89741	
Dual Foot Valve 	81.52310-6095	Wabco 461 318 003 0	MB4745 I89741	
EBS Dual Foot Valve 	81.52130-6268	0486200007000	0486200007000	Voss 232 NG8 ports
Anti-compounding Relay Valve 	81.52116-6071	Wabco 973 011 200 0		Voss ports

NOTE: X00 and X50 suffixes refer to Exchange Products which may be Remanufactured.







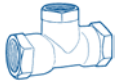
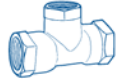
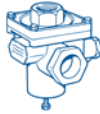

12.240 & 14.220

MAN

4 x 2









Air Suspension

Bodied by East Lancs/Darwen (Esteem and Mylennium),
Marshall/MCV (Evolution and Stirling) and Plaxton (Centro)

	Description	MAN Part Number	OE Part Number	Replacement Knorr-Bremse Part No	Remarks <small>Note: Left and Right refer to the side of the vehicle when viewed from the driver's seat facing forward.</small>
	Double Check Valve 	81.52310-6090	Wabco 434 208 050 0	<i>AE4252</i> I90168	M22 ports Biased valve
	Double Check Valve 	81.52310-6111	<i>AE4252</i> I90168	<i>AE4252</i> I90168	M22 ports Biased valve
	Limiting Quick Release Valve 	81.52120-6041	<i>DB2113</i> I53929	<i>DB2113</i> I53929	
	Limiting Quick Release Valve 	81.52180-6211	Wabco 975 001 002 0	<i>DB2113</i> I53929	
	Quick Release Valve 	81.52115-6034	Wabco 973 500 034 0		M22 Voss ports. 3 Delivery Ports - only 2 used
	Pressure Limiting Valve 	81.52101-6269	Wabco 475 010 300 0		8.5 bar Port 1 M22 Voss thread. On outlet from 4CPV
	Pressure Reducing Valve 	81.52101-6221	Wabco 475 009 021 0		1.2 bar, M12 ports. Situated between front wheels
	ABS modulator 	81.52452-6016	<i>BR7012</i> 0265351118000	<i>BR9154</i> II17776N00	ECU to Modulator cables are MAN supply only
	ABS modulator 	81.52452-6017	<i>BR9154</i> II17776	<i>BR9154</i> II17776N00	ECU to Modulator cables are MAN supply only
Front Axle	Wheel Speed Sensor 	81.27120-6077	0486000049000	0486000238000	Left side Cable length 2.0 m
	Wheel Speed Sensor 	81.27120-6078	0486000051000	0486000240000	Right side Cable length 2.0 m

Bodied by East Lancs/Darwen (Esteem and Myllennium),
Marshall/MCV (Evolution and Stirling) and Plaxton (Centro)

Air Suspension

	Description	MAN Part Number	OE Part Number	Replacement Knorr-Bremse Part No	Remarks <small>Note: Left and Right refer to the side of the vehicle when viewed from the driver's seat facing forward.</small>
Rear Axle	Wheel Speed Sensor 	81.27120-6067	0486000052000	0486000241000	Left side Cable length 2.0 m
	Wheel Speed Sensor 	81.27120-6068	0486000053000	0486000242000	Right side Cable length 2.0 m
	ABS Electronic Control Unit (Gamma 2E) 	81.25935-6639	0265150315000	0265150315000	
	EBS Axle Control Module (1 Channel) 	81.52106-6013	0486203023000	0486203023000	
	EBS Axle Control Module (2 Channel) 	81.52106-6014	0486204017000	0486204017000	
	EBS Electronic Control Unit (EBS 2.3) 	81.25808-7016	0486106041000		Replacement ECU must be programmed before use MAN only
	Air Suspension Levelling Valve 	81.43610-6121	SV1411 I98290	SV1411 I98290	
	Air Suspension Levelling Valve 	81.43610-6125	Wabco 464 002 530 0	SV1411 I98290	

NOTE: X00 and X50 suffixes refer to Exchange Products which may be Remanufactured.







12.240 & 14.220

MAN

4 x 2



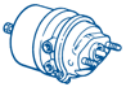
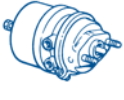





Air Suspension

Bodied by East Lancs/Darwen (Esteem and Mylennium),
Marshall/MCV (Evolution and Stirling) and Plaxton (Centro)

	Description	MAN Part Number	OE Part Number	Replacement Knorr-Bremse Part No	Remarks <small>Note: Left and Right refer to the side of the vehicle when viewed from the driver's seat facing forward.</small>
Front Axle with Disc Brakes	Brake Chamber (Type 16) 	81.51101-6419 81.51101-6501	<i>BS3317</i> II37316 K015580	<i>BS3317</i> K015580	12.240, left side, M16 port, 15 mm push rod protrusion. Diaphragm C72596
	Brake Chamber (Type 16) 	81.51101-6420 81.51101-6500	<i>BS3316</i> II37317 K015579	<i>BS3316</i> K015579	12.240, right side, M16 port, 15 mm push rod protrusion. Diaphragm C72596
	Brake Chamber 				14.220, left side,
	Brake Chamber 				14.220, right side
Rear Axle with Disc Brakes	Spring Brake 				12.240, left side, with Knorr-Bremse Disc Brake
	Spring Brake 				12.240, right side, with Knorr-Bremse Disc Brake
	Spring Brake 				14.220, right side, with Knorr-Bremse Disc Brake
	Spring Brake 				14.220, right side, with Knorr-Bremse Disc Brake

Bodied by East Lancs/Darwen (Esteem and Myllennium),
Marshall/MCV (Evolution and Stirling) and Plaxton (Centro)

Air Suspension

	Description	MAN Part Number	OE Part Number	Replacement Knorr-Bremse Part No	Remarks <small>Note: Left and Right refer to the side of the vehicle when viewed from the driver's seat facing forward.</small>
Front Axle	Air Disc Brake 	81.50804-6447	SB6586 K004483	Caliper K003826	Left side, actuator mounting 5° Tappet & Boot Kit K010604 Guide Pins & Bushes II39769F0062 Pad Set K006970
	Air Disc Brake 	81.50804-6448	SB6596 K004484	Caliper K003825	Right side, actuator mounting 5° Tappet & Boot Kit K010604 Guide Pins & Bushes II39769F0062 Pad Set K006970
	Air Disc Brake 				Left side
	Air Disc Brake 				Right side
Rear Axle	Air Disc Brake 				Left side
	Air Disc Brake 				Right side
	Air Disc Brake 				Left side
	Air Disc Brake 				Right side
	Disc Brake Pad Set 		K002733	K002733	For Knorr-Bremse SN6 Air Disc Brakes







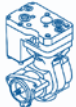
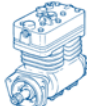

Front Axle	Brake Disc 	81.50803-0044			With 19.5" wheels
Rear Axle	Brake Disc 	81.50803-0057			With 19.5" wheels

NOTE: X00 and X50 suffixes refer to Exchange Products which may be Remanufactured.

**Knorr-Bremse
the world leader in
original equipment**

Bodied by Alexander (ALX300), East Lancs/Darwen (Kinetic) and Ikarus







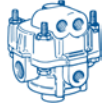
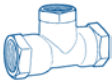
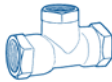

Air Suspension

Description	MAN Part Number	OE Part Number	Replacement Knorr-Bremse Part No	Remarks Note: Left and Right refer to the side of the vehicle when viewed from the driver's seat facing forward.
Air Compressor				Integral with MAN engine MAN parts only
Air Compressor (1W352R) 	51.54100-7005	Wabco 412 352 003 0		Mk 2 vehicles With energy saving system
Air Compressor (2W600R) 	51.54100-7069	LK4939 K001998		Mk 3 vehicles MAN only
Air Dryer 	81.52102-6103	LA8210 II19207	LA8210 II19207	10 bar cut-out Replacement cartridge is 272897SP
Air Dryer 	81.52102-6104	Wabco 432 410 116 0	LA8210 II19207	10 bar cut-out Replacement cartridge is 272897SP
Four Circuit Protection Valve 	81.52151-6073	AE4422 II18172	AE4422 II18172	
Single Check Valve 	81.52120-6025	AE5102 I60422	AE5102 I60422	On outlet from Air Dryer
Hand Control Valve 	81.52315-6086	HB1189 I92190	HB1189 I92190	
Hand Control Valve 	81.52315-6090	Wabco 961 722 262 0	HB1189 I92190	
Dual Foot Valve 	81.52310-6098	MB4745 I89741	MB4745 I89741	
Dual Foot Valve 	81.52310-6095	Wabco 461 318 003 0	MB4745 I89741	
EBS Dual Foot Valve 	81.52130-6268	0486200007000	0486200007000	Voss 232 NG8 ports

NOTE: X00 and X50 suffixes refer to Exchange Products which may be Remanufactured.

Air Suspension

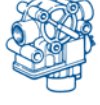







Bodied by Alexander (ALX300), East Lancs/Darwen (Kinetic) and Ikarus

	Description	MAN Part Number	OE Part Number	Replacement Knorr-Bremse Part No	Remarks Note: Left and Right refer to the side of the vehicle when viewed from the driver's seat facing forward.
	Anti-compounding Relay Valve 	81.52116-6071	Wabco 973 011 200 0		Voss ports
	Double Check Valve 	81.52310-6090	Wabco 434 208 050 0	AE4252 I90168	M22 ports Biased valve
	Double Check Valve 	81.52310-6111	AE4252 I90168	AE4252 I90168	M22 ports Biased valve
	Limiting Quick Release Valve 	81.52120-6041	DB2113 I53929	DB2113 I53929	
	Limiting Quick Release Valve 	81.52180-6211	Wabco 975 001 002 0	DB2113 I53929	
	Quick Release Valve 	81.52115-6034	Wabco 973 500 034 0		M22 Voss ports. 3 Delivery Ports - only 2 used
	Pressure Limiting Valve 	81.52101-6269	Wabco 475 010 300 0		8.5 bar Port 1 M22 Voss thread. On outlet from 4CPV
	Pressure Reducing Valve 	81.52101-6221	Wabco 475 009 021 0		1.2 bar, M12 ports. Situated between front wheels
	ABS modulator 	81.52452-6016	BR7012 0265351118000	BR9154 II17776N00	ECU to Modulator cables are MAN supply only
	ABS modulator 	81.52452-6017	BR9154 II17776	BR9154 II17776N00	ECU to Modulator cables are MAN supply only
Front Axle	Wheel Speed Sensor 	81.27120-6077	0486000049000	0486000238000	Left side Cable length 2.0 m
	Wheel Speed Sensor 	81.27120-6078	0486000051000	0486000240000	Right side Cable length 2.0 m

See Notes on different Marks at the end of this section

Bodied by Alexander (ALX300), East Lancs/Darwen (Kinetic) and Ikarus













Air Suspension

	Description	MAN Part Number	OE Part Number	Replacement Knorr-Bremse Part No	Remarks Note: Left and Right refer to the side of the vehicle when viewed from the driver's seat facing forward.
Rear Axle	Wheel Speed Sensor 	81.27120-6067	0486000052000	0486000241000	Left side Cable length 2.0 m
	Wheel Speed Sensor 	81.27120-6068	0486000053000	0486000242000	Right side Cable length 2.0 m
	ABS Electronic Control Unit (Gamma 2E) 	81.25935-6639	0265150315000	0265150315000	
	EBS Axle Control Module (1 Channel) 	81.52106-6013	0486203023000	0486203023000	
	EBS Axle Control Module (2 Channel) 	81.52106-6014	0486204017000	0486204017000	
	EBS Electronic Control Unit (EBS 2.3) 	81.25808-7016	0486106041000		Replacement ECU must be programmed before use MAN only
	Air Suspension Levelling Valve 	81.43610-6121	SV1411 I98290	SV1411 I98290	
	Air Suspension Levelling Valve 	81.43610-6125	Wabco 464 002 530 0	SV1411 I98290	

NOTE: X00 and X50 suffixes refer to Exchange Products which may be Remanufactured.

Air Suspension



Bodied by Alexander (ALX300), East Lancs/Darwen (Kinetic) and Ikarus







	Description	MAN Part Number	OE Part Number	Replacement Knorr-Bremse Part No	Remarks <small>Note: Left and Right refer to the side of the vehicle when viewed from the driver's seat facing forward.</small>
Front Axle Mk 1 Drum Brakes	Brake Chamber (Type 24) 	81.51101-6449	Wabco 423 106 430 0	<i>BZ3590</i> I98819	Left side Diaphragm 234100K
	Brake Chamber (Type 24) 	81.51101-6448	Wabco 423 106 428 0	<i>BZ3590</i> I98819	Right side Diaphragm 234100K
Front Axle Mk 2 Disc Brakes	Brake Chamber (Type 16) 	81.51101-6422	Wabco 423 104 712 0		Left side, with Meritor Disc Brake M22 ports, 73 mm stroke 20 mm push rod protrusion Diaphragm 16LS
	Brake Chamber (Type 16) 	81.51101-6423	Wabco 423 104 711 0		Right side, with Meritor Disc Brake M22 ports, 73 mm stroke 20 mm push rod protrusion Diaphragm 16LS
Front Axle Mk 3 Disc Brakes	Brake Chamber (Type 20) 	81.51101-6479	<i>BS2407</i> K002942 K015584	<i>BS2407</i> K015584	Left side, with Knorr-Bremse Disc Brake M22 ports, 64 mm stroke 15 mm push rod protrusion Diaphragm C72336
	Brake Chamber (Type 20) 	81.51101-6478	<i>BS2406</i> K002941 K015583	<i>BS2406</i> K015583	Right side, with Knorr-Bremse Disc Brake M22 ports, 64 mm stroke 15 mm push rod protrusion Diaphragm C72336
Rear Axle Mk 1 Drum Brakes	Spring Brake (Type 30/30) 	81.50410-6537	<i>BZ9631</i> II19749	<i>BZ9631</i> II19749	Left side M16 ports, 64 mm stroke Diaphragm B75383 <small>Note: push rod is 300 mm long - fully threaded rods are not strong enough and rationalised units should not be used</small>
	Spring Brake (Type 30/30) 	81.50410-6536	<i>BZ9630</i> II19748	<i>BZ9630</i> II19748	Right side M16 ports, 64 mm stroke Diaphragm B75383 <small>Note: push rod is 300 mm long - fully threaded rods are not strong enough and rationalised units should not be used</small>
Rear Axle Mk 2 Drum Brakes	Spring Brake (Type 24/30) 	81.50410-6789	Wabco 925 421 454 0		Left side M22 ports, 57 mm stroke Diaphragm 234100K <small>Note: push rod is 300 mm long - fully threaded rods are not strong enough and rationalised units should not be used</small>
	Spring Brake (Type 24/30) 	81.50410-6788	Wabco 925 421 455 0		Right side M22 ports, 57 mm stroke Diaphragm 234100K <small>Note: push rod is 300 mm long - fully threaded rods are not strong enough and rationalised units should not be used</small>
Rear Axle Mk 3 Disc Brakes	Spring Brake (Type 20/24HFL1) 	81.50410-6843	<i>BS8435</i> K002956 K007676	<i>BS8435</i> K007676	Left side, with Knorr-Bremse Disc Brake M22 ports, 64 mm stroke
	Spring Brake (Type 20/24HFL1) 	81.50410-6842	<i>BS8434</i> K002955 K007675	<i>BS8434</i> K007675	Right side, with Knorr-Bremse Disc Brake M22 ports, 64 mm stroke

See Notes on different Marks at the end of this section

Bodied by Alexander (ALX300), East Lancs/Darwen (Kinetic) and Ikarus

Air Suspension

	Description	MAN Part Number	OE Part Number	Replacement Knorr-Bremse Part No	Remarks Note: Left and Right refer to the side of the vehicle when viewed from the driver's seat facing forward.
Front Axle Mk 1	Automatic Slack Adjuster 				
Rear Axle Mk 1	Automatic Slack Adjuster 				
Rear Axle Mk 2	Automatic Slack Adjuster 				

Front Axle Mk 2	Air Disc Brake 		Meritor LRG574 LRG590		Left side
	Air Disc Brake 		Meritor LRG575 LRG591		Right side
	Air Disc Brake 		Meritor LRG704		Left side, with EBS
	Air Disc Brake 		Meritor LRG705		Right side, with EBS
	Disc Brake Pad Set 		Meritor MDP5038		For Meritor Air Disc Brakes
	Brake Disc 	81.50803-0040			

NOTE: X00 and X50 suffixes refer to Exchange Products which may be Remanufactured.





18.220

4 x 2

Air Suspension

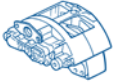
MAN

Bodied by Alexander (ALX300), East Lancs/Darwen (Kinetic) and Ikarus







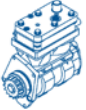
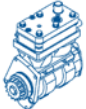

	Description	MAN Part Number	OE Part Number	Replacement Knorr-Bremse Part No	Remarks Note: Left and Right refer to the side of the vehicle when viewed from the driver's seat facing forward.
Front and Rear Axles Mk 3	Air Disc Brake 	81.50804-6473 81.50804-6507	SN7086 K010153 K014997	Caliper K003812	Left side, actuator mounting 0° Tappet & Boot Kit K010603 Guide Pins & Bushes K000472 Pad Set K017002
	Air Disc Brake 	81.50804-6474 81.50804-6508	SN7096 K010154 K014998	Caliper K003811	Right side, actuator mounting 0° Tappet & Boot Kit K010603 Guide Pins & Bushes K000472 Pad Set K017002
	Disc Brake Pad Set 		K002231	K017002	For Knorr-Bremse Air Disc Brakes
Front Axle Mk 3	Brake Disc 				
Rear Axle Mk 3	Brake Disc 				

NOTES













Various changes have been made to the brake components of the 18-220 vehicle and these are described for convenience as Mk1, Mk 2 and Mk 3:











Vehicle Mark

- | | |
|------|--|
| Mk 1 | Drum Brakes on both front and rear axles. |
| Mk 2 | Meritor Disc Brakes on front axle, Drum Brakes on rear axle. |
| Mk 3 | Knorr-Bremse Disc Brakes on both front and rear axles. |

Description	M-Benz Part Number	OE Part Number	Replacement Knorr-Bremse Part No	Remarks <small>Note: Left and Right refer to the side of the vehicle when viewed from the driver's seat facing forward.</small>
Air Compressor (1W352R) 	A906 130 14 15	Wabco 412 352 002 0		4 x 2
Air Compressor (2W636R) 	A457 130 04 15	Wabco 911 553 000 0		4 x 2
Air Compressor (2W636R) 	A906 130 32 15	Wabco 412 636 000 0		6 x 2 and Artic
Condenser 		Haldex 78200		
Air Processing Unit (Air Dryer and Four Circuit Protection Valve) 	A002 431 03 15	Wabco 932 500 015 0		12.3 bar cut-out The Air Dryer can be replaced with LA9010 - II38308FN00. Replacement cartridge is 272897SP
Charging Valve with Limited Feedback 	A005 429 18 44	Wabco 434 100 249 0	DR4250 K000624 See Remarks	Air Suspension circuit Set replacement valve to 10.0 bar
Charging Valve with Limited Feedback 	A005 429 14 44	Wabco 434 100 232 0	DR4250 K000624 See Remarks	6 x 2 and Artic, 3rd axle brake circuit Set replacement valve to 8.5 bar
Single Check Valve 	A003 429 07 44	Wabco 434 014 100 0	AE5115 I75598	Emergency charge circuit M22(F) ports
Hand Control Valve 	A003 430 75 81	DPM24A	DPM24A	
EBS Dual Foot Valve 	A004 431 36 05	Wabco 480 002 000 0		Up to 2003
EBS Dual Foot Valve 	A004 431 64 05	Wabco 480 002 004 0		From 2004
Base Foot Valve	A004 431 50 05	Wabco 480 001 004 0		For EBS Foot Valve

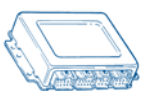
NOTE: X00 and X50 suffixes refer to Exchange Products which may be Remanufactured.

Description	M-Benz Part Number	OE Part Number	Replacement Knorr-Bremse Part No	Remarks Note: Left and Right refer to the side of the vehicle when viewed from the driver's seat facing forward.
Double Check Valve 	A003 429 70 44	Wabco 434 208 027 0		M22 Voss ports, Bracket Mounted
Anti-compounding Valve 	A004 429 76 44	Wabco 973 011 200 0		Voss ports
Relay Valve 	A004 429 38 44	Wabco 973 011 001 0	AC574AXY	Voss ports Note: AC574AXY has standard Metric ports
Pressure Limiting Valve 	A003 431 56 06	Wabco 475 010 201 0		6 x 2 and Artic, 3rd axle brake circuit M22 ports, 11.0 bar
Quick Release Valve 	A004 429 23 44	Wabco 973 500 028 0		Voss ports
Exhaust Silencer 	A000 430 29 70	Wabco 432 407 060 0	SIL68B	On Condensate Reservoir M22 thread Alternative Silencers: 0484210001000 or ZB3150-178074
Exhaust Silencer 	A000 430 24 70	Wabco 432 407 070 0	SIL68ASP	On QRV, Anti-compounding Relay Valve and Relay Valve. Snap-on Alternative Silencers: 0484210017000 or ZB3163-192999
Test Connector 	A000 420 60 71	Wabco 463 703 116 0		M12(F) thread
ABS Modulator 	A004 429 65 44	Wabco 472 195 016 0	BR9159 II40864FN00	Front axle. Voss Supply port 1 Electrical Connector DIN 72585 Bayonet
ABS Wheel Speed Sensor 	A001 542 31 18	Wabco 441 032 488 0		Front axle, left side 90° Sensor, cable length 2.0 m
ABS Wheel Speed Sensor 	A001 542 96 18	Wabco 441 032 728 0		Front axle, right side 90° Sensor, cable length 2.0 m
ABS Wheel Speed Sensor 				Drive axle

Description	M-Benz Part Number	OE Part Number	Replacement Knorr-Bremse Part No	Remarks <small>Note: Left and Right refer to the side of the vehicle when viewed from the driver's seat facing forward.</small>
ABS Wheel Speed Sensor 				6 x 2 trailing axle
ABS Wheel Speed Sensor 	A001 542 33 18	Wabco 441 032 487 0		Artic trailing axle, left side 90° Sensor, cable length 3.0 m
ABS Wheel Speed Sensor 	A001 542 97 18	Wabco 441 032 727 0		Artic trailing axle, right side 90° Sensor, cable length 3.0 m
EBS Electronic Control Unit 	A000 446 20 36	Wabco 446 130 020 0		4 x 2, up to 2000 4S/4M
EBS Electronic Control Unit 	A000 446 22 36	Wabco 446 130 024 0		4 x 2, 2000 up to 2002 4S/4M
EBS Electronic Control Unit 	A000 446 35 36	Wabco 446 130 028 0		4 x 2, from 2002 4S/4M
EBS Electronic Control Unit 	A000 446 21 36	Wabco 446 130 021 0		6 x 2 and Artic, up to 2000 6S/6M
EBS Electronic Control Unit 	A000 446 23 36	Wabco 446 130 025 0		6 x 2 and Artic, 2000 up to 2002 6S/6M
EBS Electronic Control Unit 	A000 446 36 36	Wabco 446 130 029 0		6 x 2 and Artic, from 2002 6S/6M
EBS Axle Modulator 	A000 429 08 24	Wabco 480 103 006 0		Drive axle up to Sept 1999
EBS Axle Modulator 	A000 429 15 24	Wabco 480 103 011 0		Drive axle from Sept 1999 Voss ports
EBS Axle Modulator 	A000 429 14 24	Wabco 480 103 066 0		Drive axle From Mar 1999 to 2002 Voss ports









NOTE: X00 and X50 suffixes refer to Exchange Products which may be Remanufactured.

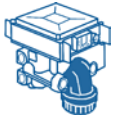
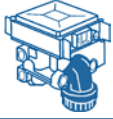





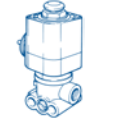





Citaro

4 x 2, 6 x 2 & Artic

Air Suspension

MERCEDES-BENZ

Description	M-Benz Part Number	OE Part Number	Replacement Knorr-Bremse Part No	Remarks
EBS Axle Modulator 	A000 429 23 24	Wabco 480 103 063 0		Drive axle With Redundancy Valve From Sept 2000
EBS Axle Modulator 	A000 429 10 24	Wabco 480 103 008 0		6 x 2 and Artic, trailing axle With Redundancy Valve Up to Sept 2000
EBS Axle Modulator 	A000 429 24 24	Wabco 480 103 061 0		6 x 2 and Artic, trailing axle With Redundancy Valve From Sept 2000
EBS Axle Modulator 	A000 429 13 24	Wabco 480 103 009 0		6 x 2 and Artic, trailing axle Without Redundancy Valve Up to Sept 2000
EBS Proportioning Relay Valve 	A005 429 12 44	Wabco 480 202 004 0		Front axle
EBS Redundancy Valve 	A005 429 23 44	Wabco 480 205 010 0		
Pressure Sensor Module 	A628 420 00 61	Wabco 893 350 010 0		
Solenoid Control Valve 	A004 997 93 36	Wabco 472 170 636 0		Voss ports Electrical Connector DIN 72585 Bayonet. Normally closed
ECAS Solenoid Valve 	A000 327 74 25	Wabco 472 900 056 0		With kneeling function
ECAS Pressure Sensor 		Wabco 441 032 007 0		
Emergency Charge Coupling				

	Description	M-Benz Part Number	OE Part Number	Replacement Knorr-Bremse Part No	Remarks Note: Left and Right refer to the side of the vehicle when viewed from the driver's seat facing forward.
Front Axle	Brake Chamber (Type 24) 	A005 420 86 24	BS3522 II32172	BS3435 K002722N00	4 x 2 & 6 x 2, left side Up to Feb 2000 Voss 232 side port Diaphragm C72337
	Brake Chamber (Type 20) 	A006 420 94 24	BS3435 II38414F	BS3435 K004486N00	4 x 2 & 6 x 2, left side From Mar 2000 Voss 230 side port Diaphragm C72336
	Brake Chamber (Type 24) 	A005 420 85 24	BS3516 II32599	BS3516 K002721N00	4 x 2 & 6 x 2, right side Up to Feb 2000 Voss 232 side port Diaphragm C72337
	Brake Chamber (Type 20) 	A006 420 93 24	BS3434 II38413F	BS3434 K0044485N00	4 x 2 & 6 x 2, right side From Mar 2000 Voss 230 side port Diaphragm C72336
	Brake Chamber (Type 20) 		BS2410 K004764	ZF only	Artic ZF Part No. 0501 321 400 Diaphragm C60489
	Brake Chamber (Type 20) 		BS2409 K004763	ZF only	Artic ZF Part No. 0501 321 399 Diaphragm C60489
Drive Axle	Spring Brake (Type 24/24) 		BS9520 II34388	BS9520 II34388	4 x 2, both sides Up to Feb 2000 Voss 230 ports ZF Part No. 0501 316 050 Diaphragm C64322
	Spring Brake (Type 20/24) 		BS9476 II38408F	BS9476 II38408F	4 x 2 & Artic, both sides From Mar 2000 to Feb 2004 Voss 230 ports ZF Part No. 0501 317 952 Diaphragm C72336
	Spring Brake (Type 20/24) 		BS9476 K004074	BS9476 K004074	4 x 2 & Artic, both sides From Mar 2004 M22 Voss ports ZF Part No. 0501 321 353 Diaphragm C72336
	Spring Brake (Type 24/27) 		BS9546 II38410F	BS9546 II38410F	6 x 2, both sides Up to Feb 2000 Voss 230 ports ZF Part No. 0501 317 950 Diaphragm C72337
	Spring Brake (Type 20/27) 		BS9478 II38522F	BS9478 II38522F	6 x 2, both sides From Mar 2000 to Mar 2004 Voss 230 ports ZF Part No. 0501 317 951 Diaphragm C72336
	Spring Brake (Type 20/27) 		BS9478 K004075	BS9478 K004075	6 x 2, both sides From Apr 2004 M22 Voss ports ZF Part No. 0501 317 951 Diaphragm C72336





NOTE: X00 and X50 suffixes refer to Exchange Products which may be Remanufactured.

Citaro













4 x 2, 6 x 2 & Artic

Air Suspension

MERCEDES-BENZ

	Description	M-Benz Part Number	OE Part Number	Replacement Knorr-Bremse Part No	Remarks Note: Left and Right refer to the side of the vehicle when viewed from the driver's seat facing forward.
Trailing Axle 6 x 2	Brake Chamber (Type 16) 	A050 131 67 75	BS3314 II37110	BS3314 K002978	6 x 2, both sides Up to May 2005 M16 centre port ZF Part No. 0501 316 775 Diaphragm C72596
	Brake Chamber (Type 16 OBC) 	A021 420 71 18	BS3314 K002978	BS3314 K002978	6 x 2, both sides From May 2005 M16 centre port ZF Part No. 0501 322 277
Mid Axle Artic	Spring Brake (Type 20/24) 		BS9476 II38408F	BS9476 II38408F	Artic, both sides Up to Feb 2004 Voss 230 ports ZF Part No. 0501 317 952 Diaphragm C72336
	Spring Brake (Type 20/24) 		BS9476 K004074	BS9476 K004074	Artic, both sides From Mar 2004 M22 Voss ports ZF Part No. 0501 321 353 Diaphragm C72336

Genuine Knorr-Bremse parts -
engineered for long life value

	Description	M-Benz Part Number	OE Part Number	Replacement Knorr-Bremse Part No	Remarks Note: Left and Right refer to the side of the vehicle when viewed from the driver's seat facing forward.
Front Axle	Air Disc Brake (Axial) 	A942 420 21 01	SB7648 II32798	Caliper K003800	4 x 2 & 6 x 2, left side Up to Dec 1998 Actuator mounting -12°
	Air Disc Brake (Axial) 	A942 420 33 01	SB7648 II36689	Caliper K003800	4 x 2 & 6 x 2, left side From Jan 1999 Actuator mounting -12°
	Air Disc Brake (Axial) 	A628 420 07 01	SN7081 K003350	Caliper K003800	4 x 2 & 6 x 2, left side Up to Nov 2005 Actuator mounting -12°
	Air Disc Brake (Axial) 	A628 420 07 01 A628 420 09 01 A628 420 11 01	SN7081 K008172 K008170 K008168	Caliper K003800	4 x 2 & 6 x 2, left side From Nov 2005 Actuator mounting -12°
	Air Disc Brake (Axial) 	A942 420 22 01	SB7658 II32799	Caliper K003799	4 x 2 & 6 x 2, right side Up to Dec 1998 Actuator mounting -12°
	Air Disc Brake (Axial) 	A942 420 34 01	SB7658 II36690	Caliper K003799	4 x 2 & 6 x 2, right side From Jan 1999 Actuator mounting -12°
	Air Disc Brake (Axial) 	A628 420 08 01	SN7091 K003351	Caliper K003799	4 x 2 & 6 x 2, right side Up to Nov 2005 Actuator mounting -12°
	Air Disc Brake (Axial) 	A628 420 08 01 A628 420 10 01 A628 420 12 01	SN7091 K008173 K008171 K008169	Caliper K003799	4 x 2 & 6 x 2, right side From Nov 2005 Actuator mounting -12°
	Air Disc Brake (Axial) 		SN7047 K000771	Caliper K003800	Artic, left side Up to May 2005 Actuator mounting -12° ZF Part No. 0501 007 475
	Air Disc Brake (Axial) 		SN7047 K011134	Caliper K003800	Artic, left side From May 2005 Actuator mounting -12° ZF Part No. 0501 008 020
	Air Disc Brake (Axial) 		SN7057 K000772	Caliper K003799	Artic, right side Up to May 2005 Actuator mounting -12° ZF Part No. 0501 007 476
	Air Disc Brake (Axial) 		SN7057 K011135	Caliper K003799	Artic, right side From May 2005 Actuator mounting -12° ZF Part No. 0501 008 021







NOTE: X00 and X50 suffixes refer to Exchange Products which may be Remanufactured.



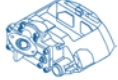

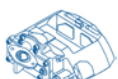

Citaro

4 x 2, 6 x 2 & Artic

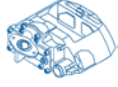
Air Suspension

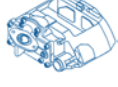
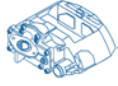
MERCEDES-BENZ

	Description	M-Benz Part Number	OE Part Number	Replacement Knorr-Bremse Part No	Remarks Note: Left and Right refer to the side of the vehicle when viewed from the driver's seat facing forward.
Drive Axle 4 x 2	Air Disc Brake (Radial) 		SB7118 II35397	Caliper K002964	4 x 2, left side Up to Dec 1998 Actuator mounting +93° ZF Part No. 0501 006 008
	Air Disc Brake (Radial) 		SB7134 II37815	Caliper K002964	4 x 2, left side From Dec 1998 to June 2001 Actuator mounting +93° ZF Part No. 0501 006 600
	Air Disc Brake (Radial) 		SB7190 Z0021122	Caliper K002964	4 x 2, left side From July 2001 to mid 2003 Actuator mounting +93° ZF Part No. 0501 007 173
	Air Disc Brake (Radial) 		SB7197 K010173	Caliper K002964	4 x 2, left side From mid 2003 Actuator mounting +93° ZF Part No. 0501 007 976
	Air Disc Brake (Radial) 		SB7108 II35396	Caliper K002965	4 x 2, right side Up to Dec 1998 Actuator mounting +93° ZF Part No. 0501 006 007
	Air Disc Brake (Radial) 		SB7124 II37814	Caliper K002965	4 x 2, right side From Dec 1998 to June 2001 Actuator mounting +93° ZF Part No. 0501 006 599
	Air Disc Brake (Radial) 		SB7180 Z0021121	Caliper K002965	4 x 2, right side From July 2001 to mid 2003 Actuator mounting +93° ZF Part No. 0501 007 172
	Air Disc Brake (Radial) 		SB7187 K010172	Caliper K002965	4 x 2, right side From mid 2003 Actuator mounting +93° ZF Part No. 0501 007 975

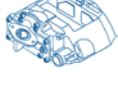
	Description	M-Benz Part Number	OE Part Number	Replacement Knorr-Bremse Part No	Remarks <small>Note: Left and Right refer to the side of the vehicle when viewed from the driver's seat facing forward.</small>
Drive Axle 6 x 2	Air Disc Brake (Radial) 		SB7118 II35397	Caliper K002964	6 x 2, left side Up to Dec 1998 Actuator mounting +93° ZF Part No. 0501 006 008
	Air Disc Brake (Radial) 		SB7134 II37815	Caliper K002964	6 x 2, left side From Dec 1998 to Feb 2000 Actuator mounting +93° ZF Part No. 0501 006 600
	Air Disc Brake (Radial) 		SB7156 II39007F	Caliper K002964	6 x 2, left side From Mar 2000 Actuator mounting +93° ZF Part No. 0501 006 851
	Air Disc Brake (Radial) 		SB7108 II35396	Caliper K002965	6 x 2, right side Up to Dec 1998 Actuator mounting +93° ZF Part No. 0501 006 007
	Air Disc Brake (Radial) 		SB7124 II37814	Caliper K002965	6 x 2, right side From Dec 1998 to Feb 2000 Actuator mounting +93° ZF Part No. 0501 006 599
	Air Disc Brake (Radial) 		SB7146 II39006F	Caliper K002965	6 x 2, right side From Mar 2000 Actuator mounting +93° ZF Part No. 0501 006 850
Trailing Axle 6 x 2	Air Disc Brake (Radial) 		SB7118 II35397	Caliper K002964	left side Up to Dec 1998 Actuator mounting +93° ZF Part No. 0501 006 008
	Air Disc Brake (Radial) 		SB7134 II37815	Caliper K002964	left side From Dec 1998 to Feb 2000 Actuator mounting +93° ZF Part No. 0501 006 600
	Air Disc Brake (Radial) 		SB7156 II39007F	Caliper K002964	left side From Mar 2000 Actuator mounting +93° ZF Part No. 0501 006 851
	Air Disc Brake (Radial) 		SB7108 II35396	Caliper K002965	right side Up to Dec 1998 Actuator mounting +93° ZF Part No. 0501 006 007
	Air Disc Brake (Radial) 		SB7124 II37814	Caliper K002965	right side From Dec 1998 to Feb 2000 Actuator mounting +93° ZF Part No. 0501 006 599
	Air Disc Brake (Radial) 		SB7146 II39006F	Caliper K002965	right side From Mar 2000 Actuator mounting +93° ZF Part No. 0501 006 850



NOTE: X00 and X50 suffixes refer to Exchange Products which may be Remanufactured.

Citaro

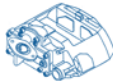

4 x 2, 6 x 2 & Artic

Air Suspension





MERCEDES-BENZ

	Description	M-Benz Part Number	OE Part Number	Replacement Knorr-Bremse Part No	Remarks Note: Left and Right refer to the side of the vehicle when viewed from the driver's seat facing forward.
Mid & Drive Axles Artic	Air Disc Brake (Radial) 		SB7190 Z0021122	Caliper K002964	Artic mid & drive axles, left side Up to mid 2003 Actuator mounting +93° ZF Part No. 0501 007 173
	Air Disc Brake (Radial) 		SB7197 K010173	Caliper K002964	Artic mid & drive axles, left side From mid 2003 Actuator mounting +93° ZF Part No. 0501 007 976
	Air Disc Brake (Radial) 		SB7180 Z0021121	Caliper K002965	Artic mid & drive axles, right side Up to mid 2003 Actuator mounting +93° ZF Part No. 0501 007 172
	Air Disc Brake (Radial) 		SB7187 K010172	Caliper K002965	Artic mid & drive axles, right side From mid 2003 Actuator mounting +93° ZF Part No. 0501 007 975

	Brake Pad Set 	A003 420 35 20		K006060	All axles
--	---	----------------	--	---------	-----------

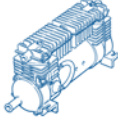
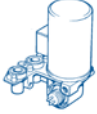
	Brake Disc 	A942 421 21 12		II376380061	4 x 2 front axle. 4 x 2 rear axle up to June 2001
	Brake Disc 	A000 420 02 72		II371910061	4 x 2 rear axle from July 2001
	Brake Disc 	A942 421 21 12		II376380061	6 x 2 all axles

Mechanical Suspension





Description	M-Benz Part Number	OE Part Number	Replacement Knorr-Bremse Part No	Remarks <small>Note: Left and Right refer to the side of the vehicle when viewed from the driver's seat facing forward.</small>
Air Compressor (Electrically Driven) 	A000 553 01 16 A000 553 04 16	0504050003000 0504050005000	0504050008000	24 volt motor
Air Dryer 	A000 553 01 16	0501100024000	0501100408000 see Remarks	0501100408000 can be used with pipework modification. Replacement cartridge is 1507434000000
Air Distribution Valve		Voss 0833124000		
Charging Valve with Full Feedback 	A005 429 16 44	Wabco 434 100 049 0	DR4125 K000613 see Remarks	Set replacement valve to 10.3 bar
Hand Control Valve 	A003 430 72 81 A003 430 79 81	Wabco 961 723 028 0	DPM23A	
Pressure Limiting Valve 	A005 429 04 44	Wabco 475 010 314 0		7.0 bar, Voss ports
Relay Valve 	A004 429 06 44 A004 429 11 44	Wabco 973 006 001 0	0481026306000	

O.614D Vario

MERCEDES-BENZ

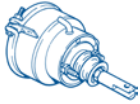
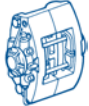
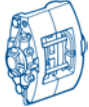
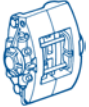
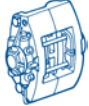
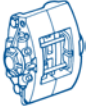
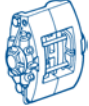
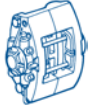







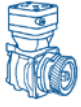
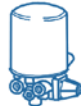

4 x 2

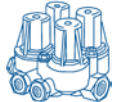
Mechanical Suspension

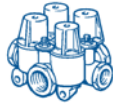
	Description	M-Benz Part Number	OE Part Number	Replacement Knorr-Bremse Part No	Remarks Note: Left and Right refer to the side of the vehicle when viewed from the driver's seat facing forward.
	Disc Brake Parking Actuator (Type 61) 	A002 431 04 14	1189458	1189458	Diaphragm 1189902
Front Axle	Hydraulic Disc Brake 		Meritor LRG510		Left side, 16" wheels
	Hydraulic Disc Brake 		Meritor LRG511		Right side, 16" wheels
	Hydraulic Disc Brake 		Meritor LRG520		Left side, 17.5" wheels
	Hydraulic Disc Brake 		Meritor LRG521		Right side, 17.5" wheels
Rear Axle	Hydraulic Disc Brake 		Meritor LRG624		Left side, 16" wheels
	Hydraulic Disc Brake 		Meritor LRG625		Right side, 16" wheels
	Hydraulic Disc Brake 		Meritor LRG626		Left side, 17.5" wheels
	Hydraulic Disc Brake 		Meritor LRG627		Right side, 17.5" wheels
	Disc Brake Pad Set 		Meritor MDP5040		
	Brake Disc 				

Bodied by Alexander (ALX100), Marshall/MCV (Master), Optare (StarRider), Plaxton (Beaver and Cheetah), and UVG (CitiStar)

Mechanical & Air Suspension

Description	M-Benz Part Number	OE Part Number	Replacement Knorr-Bremse Part No	Remarks Note: Left and Right refer to the side of the vehicle when viewed from the driver's seat facing forward.
Air Compressor (1W238R) 	A906 130 06 15	Wabco 411 151 000 0		4 bolt flange mounted, complete with drive gear. Through drive facility
Air Dryer 	A001 431 62 15	Wabco 432 410 069 0	LA8209 II19206	10.0 bar cut-out Add Heater I87122004 to II19206 Replacement cartridge is 272897SP
Air Line Filter 	A000 429 29 95	LA2100 I13886	LA2103 I99660	
Four Circuit Protection Valve 	A002 431 93 06	Wabco 934 702 221 0	0481062104000	7 port valve Alternative valve is AE4162-I73329
Four Circuit Protection Valve 	A003 431 41 06	0481062413000	0481062413000	5 port valve
Four Circuit Protection Valve 	A003 431 47 06	Wabco 934 702 261 0	0481062413000	5 port valve
Charging Valve with Full Feedback 	A002 429 65 44	DR4130 I75351	DR4125 K000613 See Remarks	Set replacement valve to 7.3 bar
Charging Valve with Limited Feedback 	A004 429 31 44	Wabco 434 100 246 0	DR4250 K000624 See Remarks	Set replacement valve to 7.3 bar
Hand Control Valve 	A002 430 26 81	Wabco 961 722 174 0	0481016114000	A002 430 26 81 and A002 430 37 81 have opposite hand mounting
Hand Control Valve 	A002 430 37 81	Wabco 961 722 164 0	0481016113000	A002 430 26 81 and A002 430 37 81 have opposite hand mounting
Hand Control Valve 	A002 430 41 81	0481016207000	0481016207000	

NOTE: X00 and X50 suffixes refer to Exchange Products which may be Remanufactured.













O.814D Vario

MERCEDES-BENZ

4 x 2









Bodied by Alexander (ALX100), Marshall/MCV (Master), Optare (StarRider),
Plaxton (Beaver and Cheetah), and UVG (CitiStar)

Mechanical & Air Suspension

Description	M-Benz Part Number	OE Part Number	Replacement Knorr-Bremse Part No	Remarks
Dual Foot Valve 	A003 431 15 05	Wabco 461 315 258 0		
Dual Foot Valve 	A002 431 87 05	Wabco 461 315 250 0	0481064103000	
Dual Foot Valve 	A002 431 88 05	Wabco 461 319 260 0	0481064205000	With front axle modulation
Double Check Valve 	A003 429 70 44	Wabco 434 208 027 0		M22 Voss ports Bracket mounted
Relay Valve 	A002 429 84 44	Wabco 973 001 021 0	0481026005000	
Relay Valve 	A003 429 59 44	Wabco 973 001 020 0	0481026005000	Alternative valves are: 0481026013000 or AC574AXY
Relay Valve 	A004 429 06 44 A004 429 11 44	Wabco 973 006 001 0	0481026306000	
Load Sensing Valve (Mech Suspension) 	A001 431 58 12	Wabco 475 710 026 0		
Load Sensing Valve (Mech Suspension) 	A002 431 05 12	Wabco 475 710 020 0		
Load Sensing Valve (Air Suspension) 	A003 431 22 12	Wabco 475 711 024 0 475 711 118 0		For Laden Air Suspension pressure of 3.0 bar
Load Sensing Valve (Air Suspension) 	A003 431 23 12	Wabco 475 711 017 0 475 711 119 0		For Laden Air Suspension pressure of 4.5 bar
Pressure Limiting Valve 	A004 429 96 44	Wabco 475 010 318 0		8 bar, M22 Voss ports

Bodied by Alexander (ALX100), Marshall/MCV (Master), Optare (StarRider), Plaxton (Beaver and Cheetah), and UVG (CitiStar)

Mechanical & Air Suspension

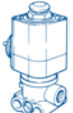
Description	M-Benz Part Number	OE Part Number	Replacement Knorr-Bremse Part No	Remarks Note: Left and Right refer to the side of the vehicle when viewed from the driver's seat facing forward.
Tilt Drain Valve 	A000 432 11 07	Wabco 934 300 001 0	KW2350/2	M22 thread
Test Connector 			KW4282/2	M16 thread
Exhaust Silencer 	A000 430 24 70	Wabco 432 407 070 0	SIL68ASP	For Hand Valve and Load Sensing Valve. Snap-on Alternative Silencers: 0484210017000 or ZB3163-I92999
Exhaust Silencer 	A000 430 23 70	Wabco 432 407 060 0	SIL68B	For ECAS suspension valves. M22 thread Alternative Silencers: 0484210001000 or ZB3150-I78074
Air Suspension Levelling Valve 	A000 328 28 30	SV1269 I80086	SV1269 I80086	Without ECAS system
Air Suspension Level Sensor 	A010 542 78 17	Wabco 441 050 008 0		
ECAS Single Solenoid Control Valve 	A000 327 66 25	Wabco 472 900 058 0		Front axle
ECAS Multiple Solenoid Control Valve 	A000 327 67 25	Wabco 472 900 053 0 472 900 060 0		Rear axle
Solenoid Control Valve 	A003 997 53 36	Wabco 472 124 108 0	EDP25AA/1	

NOTE: X00 and X50 suffixes refer to Exchange Products which may be Remanufactured.







O.814D Vario



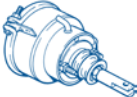

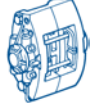
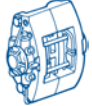



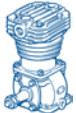

MERCEDES-BENZ

4 x 2

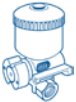
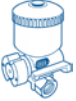







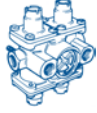

Bodied by Alexander (ALX100), Marshall/MCV (Master), Optare (StarRider), Plaxton (Beaver and Cheetah), and UVG (CitiStar)













Mechanical & Air Suspension

	Description	M-Benz Part Number	OE Part Number	Replacement Knorr-Bremse Part No	Remarks Note: Left and Right refer to the side of the vehicle when viewed from the driver's seat facing forward.
	Brake Chamber for Air/Hydraulic Actuator (Type 14) 	A001 431 97 14	Wabco 423 060 004 0		Diaphragm 16LS
Rear Axle	Disc Brake Parking Actuator (Type 61) 	A002 431 04 14	1189458	1189458	Diaphragm 1189902
Front Axle	Hydraulic Disc Brake 		Meritor LRG520		Left side
	Hydraulic Disc Brake 		Meritor LRG521		Right side
Rear Axle	Hydraulic Disc Brake 		Meritor LRG626		Left side
	Hydraulic Disc Brake 		Meritor LRG627		Right side
	Disc Brake Pad Set 		Meritor MDP5040		
	Brake Disc 				













Description	Neoplan Part Number	OE Part Number	Replacement Knorr-Bremse Part No	Remarks Note: Left and Right refer to the side of the vehicle when viewed from the driver's seat facing forward.
Air Compressor (1A300R) 		LP1999 I80165	Obsolete	Base mounted with through drive. Service Kits available
Air Compressor Cylinder Head 		ZB4257 I79016	ZB4275 I88057	Cylinder Head only on MAN D2866-LOH29 Euro 3 engine
Unloader Valve 	11021610	DR3238 I78861	0481039221000	8.1 bar cut-out
Unloader Valve 	11027335	Wabco 975 303 473 0	0481039221000	8.1 bar cut-out
Alcohol Injector 	11022810	LA4130 I86679	LA4130 I86679	
Alcohol Injector 	11026851	Wabco 932 002 101 0	LA4130 I86679	
Air Dryer 	11027363	LA6210 I87501	LA8234 II30448-B	8.1 bar cut-out Replacement cartridge is 272897SP
Air Dryer 	11017447	Wabco 432 410 102 0	LA8234 II30448-B	8.1 bar cut-out Replacement cartridge is 272897SP
Air Dryer 	11017491	LA8270 II35523	LA8209 II19206	10.0 bar cut-out Replacement cartridge is 272897SP Add Heater I87122004 to LA8209-II19206
Single Check Valve 	12006518	AE5101 I25351	AE5115 I75598 or 1194016	M22(F) ports
Single Check Valve 	11017366	Wabco 434 014 000 0	AE5115 I75598 or 1194016	M22(F) ports
Single Check Valve 	11017249	AE5115 I75598	AE5115 I75598 or 1194016	M22(F) ports







NOTE: X00 and X50 suffixes refer to Exchange Products which may be Remanufactured.





Description	Neoplan Part Number	OE Part Number	Replacement Knorr-Bremse Part No	Remarks
Four Circuit Protection Valve 	11025130	AE4158 I70615	AE4158 I70615	
Four Circuit Protection Valve 	11017368	Wabco 934 702 320 0	AE4158 I70615	
Four Circuit Protection Valve 	11067164	AE4620 II40246F	AE4620 II40246F	With "Safety Feature"
Charging Valve with Limited Feedback 	11024860	DR4236 I69854	DR4250 K000624	Set replacement valve to required pressure
Hand Control Valve 	11017300	HB1189 I92190	HB1189 I92190	
Hand Control Valve 	11017394	Wabco 961 722 262 0	HB1189 I92190	
Dual Foot Valve 	11024035	Wabco 461 307 200 0		
Dual Foot Valve 	11017327	Wabco 461 324 008 0		With pneumatic control valve for retarder control
Dual Foot Valve 	11017323	Wabco 461 318 003 0	MB4745 I89741	
Double Check Valve 	11029670	AE4100 I14911	AE4100 I14911	M22 ports Bracket mounted
Double Check Valve 	11017272	AE4146 I85731	AE4146 I85731	M16 ports 0.4 bar bias against Port 12

Description	Neoplan Part Number	OE Part Number	Replacement Knorr-Bremse Part No	Remarks Note: Left and Right refer to the side of the vehicle when viewed from the driver's seat facing forward.
Relay Valve 	11021440	0486026006000	RE1121 I76202	
Relay Valve 	11223150	Wabco 973 011 000 0	RE1121 I76202	
Relay Valve 	11017202	AC574AY	AC574AXY	AC574AXY has integral silencer
Quick Release Valve 	11021450	RE2108 I70676	RE2108 I70676	Biased valve
Quick Release Valve 	11026760	Wabco 973 500 000 0	RE2108 I70676	Biased valve
Pressure Proportioning Valve 	11021900	DB2116 I86155	DB2116 I86155	Reduction ratio 1.15:1 Mercedes-Benz axle
Pressure Proportioning Valve 	11024735	Wabco 473 301 003 0	DB2116 I86155	Reduction ratio 1.15:1 Mercedes-Benz axle
Pressure Proportioning Valve 	11021910	DB2115 I86154	DB2115 I86154	Reduction ratio 1.5:1 ZF axle
Pressure Proportioning Valve 	11017237	DB2142 II36021	DB2142 II36021	Reduction ratio 1.35:1 Complete with snap-on silencer
Pressure Reducing Valve 	11017222	DB1114 I61241	DB1103 I61236	Reset replacement valve to 1.0 bar
Tilt Drain Valve 	11017276	EE1100 I94095	KW2350/2	M22 thread
Tilt Drain Valve 	11017398	Wabco 934 300 003 0	KW2350/2	M22 thread



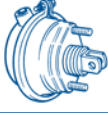

NOTE: X00 and X50 suffixes refer to Exchange Products which may be Remanufactured.







Description	Neoplan Part Number	OE Part Number	Replacement Knorr-Bremse Part No	Remarks Note: Left and Right refer to the side of the vehicle when viewed from the driver's seat facing forward.
Test Connector 	11018286			M12 thread
Test Connector 	11018342			M14(F) thread
Test Connector 	11019034		KW4282/2	M16 thread Fitted near Double Check Valve, Pressure Proportioning Valve and ABS Modulator
Test Connector 	11019035		AC784D	M22 thread
Test Connector 	11019080			M18 thread
Test Connector 	11071610			Fitted to Air Dryer
Exhaust Silencer 	11017349	ZB3163 I92999	SIL68ASP	Snap-on Alternative Silencers: 0484210017000 or ZB3163-I92999
Exhaust Silencer 	11017348	ZB3150 I78074	SIL68B	M22 thread Alternative Silencers: 0484210001000 or ZB3150-I78074
Exhaust Silencer 	11018653	Wabco 432 407 060 0	SIL68B	M22 thread Alternative Silencers: 0484210001000 or ZB3150-I78074
ABS Modulator 	11018716	0486201001000	BR9156 II32612	Electrical connector DIN 72585 bayonet
ABS Wheel Speed Sensor 				
ABS Electronic Control Unit 	11018714	0486104039000	0486104039100	

Description	Neoplan Part Number	OE Part Number	Replacement Knorr-Bremse Part No	Remarks Note: Left and Right refer to the side of the vehicle when viewed from the driver's seat facing forward.
Air Suspension Levelling Valve 	11018608	SV1318 I85883	SV1318 I85883	
Air Suspension Single Check Valve 	11017249	AE5115 I75598	AE5115 I75598	M22(F) ports
Solenoid Valve 	11029660	0481511001000	0481511001000	
Exhaust Brake Valve 	11028250	AE1208 I79713	AE1208 I79713	
Exhaust Brake Valve 	11017347	Wabco 463 013 116 0	AE1208 I79713	
Push Button Valve 		0481007004000	Obsolete	
Electronic Throttle Control 		Williams WM526		

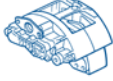
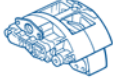
	Description		Neoplan Part Number	OE Part Number	Replacement Knorr-Bremse Part No	Remarks Note: Left and Right refer to the side of the vehicle when viewed from the driver's seat facing forward.
Front Axle with Drum Brakes	Brake Chamber (Type 24)		080240000	Wabco 423 106 106 0	<i>BZ3555</i> I77744	ZF axle Diaphragm 234100K
	Brake Chamber (Type 20)		07010020	Wabco 423 105 900 0	<i>BX3419</i> II33782A	Mercedes-Benz axle Diaphragm 20LS
Trailing Axle - Drum Brakes	Spring Brake (Type 20/20)			Wabco 890 110 328 0	K2B0525X50	Diaphragm 234099K
Drive Axle with Drum Brakes	Spring Brake (Type 30/30)		070218100	<i>BZ7637</i> 185943	K2B0522X50	Diaphragm 234101K
	Spring Brake (Type 30/30)		070240000	Wabco 925 322 433 0	K2B0522X50	Diaphragm 234101K













Front Axle	Automatic Slack Adjuster		080110802	Haldex 70775	KB2100	Left and right side. 130 mm hole centre, 26 tooth spline
Trailing Axle	Automatic Slack Adjuster		070112507	Haldex 70706	KB2440	Left and right side. 115 mm hole centre, 26 tooth spline
	Automatic Slack Adjuster		070114304	Haldex 70772	KB3125	Left side. 15 mm offset, 115 mm hole centre, 26 tooth spline
	Automatic Slack Adjuster		070114305	Haldex 70771	KB3130	Right side. 15 mm offset, 115 mm hole centre, 26 tooth spline
Drive Axle	Automatic Slack Adjuster		080110802	Haldex 70775	KB2100	Left and right side. 130 mm hole centre, 26 tooth spline

	Description		Neoplan Part Number	OE Part Number	Replacement Knorr-Bremse Part No	Remarks Note: Left and Right refer to the side of the vehicle when viewed from the driver's seat facing forward.
Front Axle with Disc Brakes	Brake Chamber (Type 20)		11015698	BS3402 II30616	BS3402 II30616	Left side. Diaphragm C60489
	Brake Chamber (Type 20)		11015699	BS3403 II30617	BS3403 II30617	Right side. Diaphragm C60489
Trailing Axle - Disc Brakes	Spring Brake (Type 16/16)		11014289	BS9398 II18224	BS9397 II31227	Diaphragm C72596
Drive Axle - Disc Brakes	Spring Brake (Type 24/24HFL1)		11018612	BS9535 II37468	BS9535 II37468	Diaphragm C72337









Front & Trailing Axle	Air Disc Brake		11014054	SB7716 II34459	Caliper K003803	Left side. Actuator mounting 0° ZF Part No. 0501 005 860
	Air Disc Brake		11014053	SB7706 II34458	Caliper K003804	Right side. Actuator mounting 0° ZF Part No. 0501 005 859
Drive Axle	Air Disc Brake			SB7894 K000046	Caliper K003809	Left side. Actuator mounting 0° ZF Part No. 0501 007 244
	Air Disc Brake			SB7884 K000045	Caliper K003810	Right side. Actuator mounting 0° ZF Part No. 0501 007 243
	Disc Brake Pad Set		11015470		II180220062	
	Brake Disc		11015508	II37191	II371910061	ZF axle
	Brake Disc		11015449	II37653	II376530061	Mercedes-Benz axle

NOTE: X00 and X50 suffixes refer to Exchange Products which may be Remanufactured.



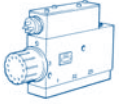

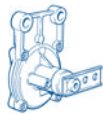

**Can you fit and forget if
you don't use genuine
Knorr-Bremse parts?**

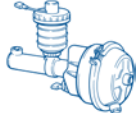
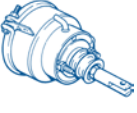
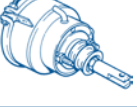
Description	Optare Part Number	OE Part Number	Replacement Knorr-Bremse Part No	Remarks Note: Left and Right refer to the side of the vehicle when viewed from the driver's seat facing forward.
Air Compressor (1A213R) 	21070026	LP1806 I75566	LP1806 I75566	Base mounted
Air Dryer 	21070142	LA8267 II33424	LA8267 II33424	Voss ports, 8.5 bar cut-out Replacement cartridge is 272897SP
Single Check Valve 	R2200224	AE5102 I60422	AE5102 I60422	M22(F) ports
Four Circuit Protection Valve 	20170027	VPS45HY	VPS45HY	With "Safety Feature"
Hand Control Valve 	X2216641	DPM94AAX	DPM94AAX	
Dual Foot Valve 	21070028	DX70C	DX70C	
Low Pressure Switch 	21070180	295474	295474	5.2 bar, 1/4" NPTF thread
Pressure Relief (Safety) Valve 	21070340	KX175/1	KX175/1	11 bar, 1/4" NPTF thread
Tilt Drain Valve 		Voss	KW2350/2	M22 thread
Test Connector 	X22312172	AC784B	KW4282/2	M16 thread
Exhaust Silencer 	L2230331	SIL68A	SIL68ASP	Snap-on Alternative Silencers: 0484210017000 or ZB3163-192999
Exhaust Silencer 	21070032	0481210001000	SIL68B	M22 thread Alternative Silencers: 0484210001000 or ZB3150-178074

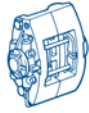
NOTE: X00 and X50 suffixes refer to Exchange Products which may be Remanufactured.

Description	Optare Part Number	OE Part Number	Replacement Knorr-Bremse Part No	Remarks <small>Note: Left and Right refer to the side of the vehicle when viewed from the driver's seat facing forward.</small>
Exhaust Silencer 	21070172	0484210004000	0484210004000	14 mm hose fitting
ABS Modulator 	21070030	BR9152 II16278	BR9152 II16278	
ABS Wheel Speed Sensor 	21070190	ES5021 II16764	0486000136000	90° sensor, cable length 1.0 m. Replacement is a sensor with bush
ABS Electronic Control Unit (ABS 2X) 	21070029	0486104119000	0486104119100	
ABS Electronic Control Unit (ABS6) 	21070343	0486107308000	0486107308000	From Jan 2008
Air Suspension Control Module 	21070011	0501100041000	0501100041100	Front axle With kneeling function
Air Suspension Control Module 	21070122	0501100040000	0501100040100	Rear axle Without kneeling function
Air Suspension Level Sensor 	21070012	0504002112000	0504002112100	
Level Sensor Linkage 	21070075	SEB00256	SEB00256	
Air Suspension Electronic Control Unit 	20170013	0504004106000	0504004106100	Replacement ECU needs to be programmed before use







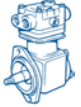
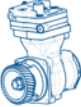
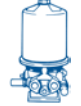
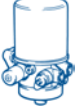

	Description	Optare Part Number	OE Part Number	Replacement Knorr-Bremse Part No	Remarks <small>Note: Left and Right refer to the side of the vehicle when viewed from the driver's seat facing forward.</small>
	Air/Hydraulic Actuator (Type 24 with MC19 Master Cylinder) 	R2200054	EF624CY	EF624CY	Diaphragm 24LS Master Cylinder 758188.01SP
Rear Axle	Disc Parking Actuator (Type 61) 	21070184	1186754	1186754	Up to May 2003 Diaphragm 1188902
	Disc Parking Actuator (Type 50) 	X2216643	1186753	1186753	From May 2003 Diaphragm 1188902

Front Axle	Hydraulic Disc Brake 				Left side
	Hydraulic Disc Brake 				Right side
	Brake Disc 				
Rear Axle	Hydraulic Disc Brake 				Left side
	Hydraulic Disc Brake 				Right side
	Brake Disc 				
	Disc Brake Pad Set 				









NOTE: X00 and X50 suffixes refer to Exchange Products which may be Remanufactured.

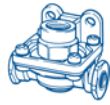







**Only the best can stand
the test!**

**Only fit genuine
Knorr-Bremse parts**

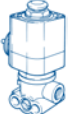

Description	Optare Part Number	OE Part Number	Replacement Knorr-Bremse Part No	Remarks Note: Left and Right refer to the side of the vehicle when viewed from the driver's seat facing forward.
Air Compressor (1W250R) 		1186551	1194215X50	Cummins Part No. 3279412
Air Compressor (1W318R) 		Wabco 411 153 500 0		With energy saving system. Mercedes-Benz Part No. A906 130 34 15
Air Dryer (AD6-S) 	L2210058	1189163	LA8227 II30181-B	Up to Sept 1999. 10.0 bar cut-out Replacement cartridge for 1189163 is SK2914/1 and for LA8227-II30181 is 272897SP
Air Dryer 	L2250290	LA8234 II30448	LA8234 II30448	From Sept 1999. 8.1 bar cut-out Replacement cartridge is 272897SP
Four Circuit Protection Valve 	L2210077	VPS48H	VPS48H	Up to March 2002. Buses without ABS
Four Circuit Protection Valve 	20170027	VPS45HY	VPS45HY	From March 2002. Buses with ABS With "Safety Feature"
Single Check Valve 	L2230013	KW4455/1	KW4455/1	M22 ports
Hand Control Valve 	X2216641	DPM94AAX	DPM94AAX	
Dual Foot Valve (E6) 	X2216640	KY1916/3	KY1916/3	Replacement base valve is 1189389
Double Check Valve 	L2230010	295358	295358	M16 ports Bracket mounted
Relay Valve (R15) 	L2220011	1186715	AC574AXY	Up to March 2002. Buses without ABS AC574AXY has integral silencer
Relay Valve 	R2200219	AC574AXY	AC574AXY	From March 2002. Buses with ABS AC574AXY has integral silencer

NOTE: X00 and X50 suffixes refer to Exchange Products which may be Remanufactured.

Description	Optare Part Number	OE Part Number	Replacement Knorr-Bremse Part No	Remarks Note: Left and Right refer to the side of the vehicle when viewed from the driver's seat facing forward.
Quick Release Valve 	L2230014	KX1294/1	KX1294/1	Up to Sept 1999. M16 exhaust port
Quick Release Valve 	L2200286	1186892	1186892	From Sept 1999. M22 exhaust port
Low Pressure Switch 	L2230006	272295	272295	5.2 bar, M12 thread
Stop Lamp Switch 	X2222947	274746	274746	1/4" NPTF thread
Pressure Relief (Safety) Valve 	L2250227	KX1729/4	KX1729/4	14 bar, M16 thread Fitted in AD6-S Air Dryer Note: LA8... Air Dryers have an internal safety valve
Tilt Drain Valve 	X22312247	KW2350/1	KW2350/1	Up to June 2001 1/2" NPTF thread
Tilt Drain Valve 	L2230005	KW2350/2	KW2350/2	From June 2001 M22 thread
Test Connector 	X22312172	AC784B	AC784B	M16 thread Alternative is KW4282/2
Exhaust Silencer 	X22312474	SIL68A	SIL68ASP	Snap-on Alternative Silencers: 0484210017000 or ZB3163-192999
Exhaust Silencer 	L2200287	SIL68B	SIL68B	M22 thread Alternative Silencers: 0484210001000 or ZB3150-178074
Exhaust Silencer 	L2230150	1188975	1188975	For Foot Valve
Exhaust Silencer 	L2230153	1188233	0484210002000	M16 thread



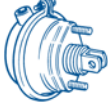



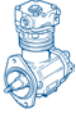
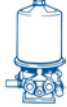
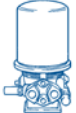

Description	Optare Part Number	OE Part Number	Replacement Knorr-Bremse Part No	Remarks Note: Left and Right refer to the side of the vehicle when viewed from the driver's seat facing forward.
ABS Modulator 	L2230009	BR9152 II16278	BR9152 II16278	
ABS Wheel Speed Sensor 	L2230048	ES5021 II16764	0486000136000	90° sensor, cable length 1.0 m. Replacement is a sensor with bush
ABS Wheel Speed Sensor 	L2230348	0265050149000	0486000129100	90° sensor, cable length 2.0 m
ABS Wheel Speed Sensor Bush 	L2230049	I97002	II16774	
ABS Electronic Control Unit (CI-12) 	24070023	0486104028000	0486104028100	
Air Suspension Levelling Valve 	L2230015	SV1294 I80091	SV1294 K002335	
Air Suspension Solenoid Valve 	L2230025	EDP25AA/1	EDP25AA/1	Normally closed
Pressure Retention Valve 	L2230026	SEB01237	SEB01237	
Solenoid Valve 	L2230017	EDP26AA/1	EDP26AA/1	Normally open

NOTE: X00 and X50 suffixes refer to Exchange Products which may be Remanufactured.

	Description		Optare Part Number	OE Part Number	Replacement Knorr-Bremse Part No	Remarks Note: Left and Right refer to the side of the vehicle when viewed from the driver's seat facing forward.
Front Axle	Brake Chamber (Type 20)		L2210060	BZ3491 I98817	BZ3491 I98817 or BZ3443 I75269	Diaphragm 234099K
	Brake Chamber (Type 20)		L2210012	BZ3490 I98818	BZ3490 I98818 or BZ3443 I75269	Diaphragm 234099K
Rear Axle	Spring Brake (Type 20-80)		L2210059	K2B1162	K2B0504X50	Spring Portion K2B0004X50 Diaphragm 234099K

Front Axle	Automatic Slack Adjuster		L1850096	Haldex 79226	KB3120	MAN axle, left side 15 mm offset, 130 mm hole centre MAN Part No. 81.50610-6169
	Automatic Slack Adjuster		L1850087	Haldex 79225	KB3115	MAN axle, right side 15 mm offset, 130 mm hole centre MAN Part No. 81.50610-6170
Rear Axle	Automatic Slack Adjuster		L2220055	Haldex 79177	KB2955	Rockwell axle, left and right side 140 mm hole centre

Mechanical Suspension

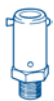
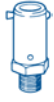
Description	Optare Part Number	OE Part Number	Replacement Knorr-Bremse Part No	Remarks Note: Left and Right refer to the side of the vehicle when viewed from the driver's seat facing forward.
Air Compressor (1W250D) 		KZ1143/2	KZ1143/2X50	2 bolt flange mounted Cummins Part No. 3279087
Air Dryer (AD6-S) 	X2216638	1189089	LA8226 II30180-B	Metric ports, 8.4 bar cut-out Replacement cartridge for 1189089 is SK2914/1 and for LA8226-II30180 is 272897SP
Air Dryer (AD6) 	X2225939	1194128	LA8234 II30448-B	Metric ports, 8.1 bar cut-out Replacement cartridge is 272897SP
Four Circuit Protection Valve 	X2216639	VPS48A	VPS48A	Up to 1997
Four Circuit Protection Valve 	X2210077	VPS48H	VPS48H	From 1997
Hand Control Valve 	X2216641	DPM94AAX	DPM94AAX	
Dual Foot Valve (E6) 	X2216640	KY1916/3	KY1916/3	Replacement base valve is 1189389
Quick Release Valve with Exhaust Check Valve 	X2216642	KY2590/4	KY2590/4	Up to Sept 1999
Low Pressure Switch 	X2216644	295481	295473	4.1 bar, 1/4" NPTF thread
Stop Lamp Switch 	X2216645 X2222947	274746	274746	1/4" NPTF thread
Pressure Relief (Safety) Valve 	UN21000502	KX1729/3	KX1729/3	11 bar, M16 thread Fitted in AD6-S Air Dryer Note: LA8... Air Dryers have an internal safety valve
Pressure Relief (Safety) Valve 	L2250227	KX1729/4	KX1729/4	14 bar, M16 thread Fitted in AD6 Air Dryer Note: LA8... Air Dryers have an internal safety valve





NOTE: X00 and X50 suffixes refer to Exchange Products which may be Remanufactured.

Metrorider Mk II

4 x 2



Mechanical Suspension



OPTARE

Description	Optare Part Number	OE Part Number	Replacement Knorr-Bremse Part No	Remarks
Tilt Drain Valve 	X22312247	KW2350/1	KW2350/1	1/2" NPTF thread
Tilt Drain Valve 	X22312173	VA12A	KW2350/2	M22 thread
Test Connector 	X22312172	AC784B	AC784B	M16 thread Alternative is KW4282/2
Exhaust Silencer 	X22312474	SIL68A	SIL68ASP	Snap-on Alternative Silencers: 0484210017000 or ZB3163-192999

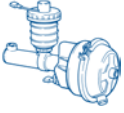
Remember!
Fit Genuine Knorr-Bremse
replacement parts

Mechanical Suspension

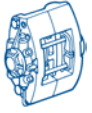
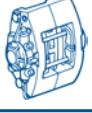

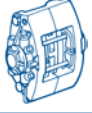
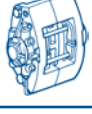



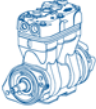
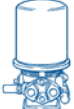

	Description	Optare Part Number	OE Part Number	Replacement Knorr-Bremse Part No	Remarks <small>Note: Left and Right refer to the side of the vehicle when viewed from the driver's seat facing forward.</small>
	Air/Hydraulic Actuator (Type 24 with MC19 Master Cylinder) 	X2205454	EF624AX	EF624AX	Diaphragm 24LS Master Cylinder 758188.01SP
Rear Axle	Disc Parking Actuator (Type 50) 	X2216643	1186753	1186753	Diaphragm 1188902

Front Axle	Hydraulic Disc Brake 		Meritor LRG514		Left side
	Hydraulic Disc Brake 		Meritor LRG515		Right side
	Disc Brake Pad Set 		Meritor MDP5429		
	Brake Disc 	X1857658 X2057948 R2000005			
Rear Axle	Hydraulic Disc Brake 		Meritor LRG620		Left side
	Hydraulic Disc Brake 		Meritor LRG621		Right side
	Disc Brake Pad Set 		Meritor MDP5429		
	Disc Brake Pad Set 		Meritor MBR1831		From Jan 1989
	Brake Disc 	X1857658 X2057948 R2000005			











NOTE: X00 and X50 suffixes refer to Exchange Products which may be Remanufactured.









Buying genuine
Knorr-Bremse product
ensures vehicle safety
and buys you
peace of mind



Air Suspension





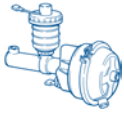

Description	Optare Part Number	OE Part Number	Replacement Knorr-Bremse Part No	Remarks <small>Note: Left and Right refer to the side of the vehicle when viewed from the driver's seat facing forward.</small>
Air Compressor				Integral on Mercedes-Benz 4 cylinder OM904LA SCR engine
Air Compressor (2W460R) 		LP4865 K006613	LP4865 K006613X50	On Cummins 6 cylinder ISBe SCR engine Cummins Part No. 3977147
Air Compressor				On MAN 4 cylinder D0834 engine with EGR
Air Dryer (AD6) 	R2200037	1194211	LA8227 II30181-B	Up to Dec. 1999 10.0 bar cut-out Replacement cartridge is 272897SP
Air Dryer 	L2210058	LA8227 II30181	LA8227 II30181	From Dec. 1999 10.0 bar cut-out Replacement cartridge is 272897SP
Four Circuit Protection Valve 	L2210077	VPS48H	VPS48H	With air/hydraulic brakes
Four Circuit Protection Valve 	20170027	VPS45HY	VPS45HY	With full air brakes With "Safety Feature"
Single Check Valve 	R2200224	AE5102 I60422	AE5102 I60422	M22(F) ports
Hand Control Valve 	X2216641	DPM94AAX	DPM94AAX	
Dual Foot Valve (E6) 	X2216640	KY1916/3	KY1916/3	With air/hydraulic brakes Replacement Base Valve is 1189389
Dual Foot Valve (E6) 	R2200242	1189389	1189389	With full air brakes
Foot Valve Treadle Assembly 	24070017	275732	275732N	With full air brakes



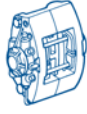
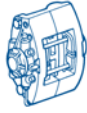

NOTE: X00 and X50 suffixes refer to Exchange Products which may be Remanufactured.







Description		Optare Part Number	OE Part Number	Replacement Knorr-Bremse Part No	Remarks Note: Left and Right refer to the side of the vehicle when viewed from the driver's seat facing forward.
Anti-compounding Relay Valve		R2200220	RE2221 I63354	RE2221 I63354 or AC586AY	With full air brakes
Relay Valve		R2200219	AC574AXY	AC574AXY	With full air brakes With integral silencer
Quick Release Valve with Exhaust Check Valve		X2216642	KY2590/4	KY2590/4	With air/hydraulic brakes
Pressure Limiting Valve		R2200038 24070011	DB1145 I86170	DB1145 I86170	With air/hydraulic brakes 7.8 bar
Low Pressure Switch		274780 X2222730	295473	295473	With air/hydraulic brakes 4.1 bar, 1/4" NPTF thread
Low Pressure Switch		L2230006	272295	272295	With full air brakes 5.5 bar, M12 thread
Stop Lamp Switch		X2216645 X2222947	274746	274746	1/4" NPTF thread
Pressure Relief (Safety) Valve		R2200246	KX2073/13	KX2073/13	14 bar, 1/4" NPTF thread
Tilt Drain Valve		24070012 L2230005	EE1100 I94095	KW2350/2	M22 thread
Signalled Automatic Drain Valve		R2200210	EE4103 I74772	EE4103 I74772	Up to March 2003 Signalled from Air Dryer Unloader M22 thread, M12 Control port
Signalled Automatic Drain Valve			Haldex 71325		From March 2003 Signalled from Stop Lamp Switch. M22 thread, Electrical connection M24 x 1

Description	Optare Part Number	OE Part Number	Replacement Knorr-Bremse Part No	Remarks <small>Note: Left and Right refer to the side of the vehicle when viewed from the driver's seat facing forward.</small>
Exhaust Silencer 	L2230006 L2230331	SIL68A or ZB3163 I92999	SIL68ASP	Snap-on Alternative Silencers: 0484210017000 or ZB3163-I92999
Exhaust Silencer 		SIL68B	SIL68B	Full air brakes with ABS M22 thread Alternative Silencers: 0484210001000 or ZB3150-I78074
Exhaust Silencer 	L2230150	1188975	1188975	For E6 Foot Valve Silencer element is 1188231
ABS Modulator 	21070030 L2220009	BR9152 II16278	BR9152 II16278	With full air brakes
ABS Wheel Speed Sensor 				With full air brakes
ABS Electronic Control Unit (CI-12) 	24070023	0486104028000	0486104028100	With full air brakes
Air Suspension Levelling Valve 	L2200015	SV1294 I80091	SV1294 K002335	
Pressure Retention Valve 	L2230026	SEB01237	SEB01237	
Solenoid Valve 	L2230017	EDP26AA/1	EDP26AA/1	Normally open

	Description	Optare Part Number	OE Part Number	Replacement Knorr-Bremse Part No	Remarks Note: Left and Right refer to the side of the vehicle when viewed from the driver's seat facing forward.
	Air/Hydraulic Actuator (Type 24 with MC19 Master Cylinder) 	R2200054	EF624AY EF624CY	EF624CY	With air/hydraulic brakes Diaphragm 24LS Master Cylinder 758188.01SP
Rear Axle	Disc Parking Actuator (Type 50) 	X2216643	1186753	1186753	With air/hydraulic brakes Diaphragm 1188902









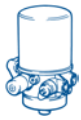

Front Axle	Hydraulic Disc Brake 		Meritor LRG568		Left side with air/hydraulic brakes
	Hydraulic Disc Brake 		Meritor LRG569		Right side with air/hydraulic brakes
	Brake Disc 	X1857658 X2057948 R2000005			With air/hydraulic brakes
Rear Axle	Hydraulic Disc Brake 		Meritor LRG634		Left side with air/hydraulic brakes
	Hydraulic Disc Brake 		Meritor LRG635		Right side with air/hydraulic brakes
	Brake Disc 	X1857658 X2057948 R2000005			With air/hydraulic brakes
	Disc Brake Pad Set 		Meritor MDP5049		With air/hydraulic brakes

	Description		Optare Part Number	OE Part Number	Replacement Knorr-Bremse Part No	Remarks Note: Left and Right refer to the side of the vehicle when viewed from the driver's seat facing forward.
Front Axle	Brake Chamber (Type 12)			Wabco		With full air brakes
	Brake Chamber (Type 16)			Wabco		With full air brakes
Rear Axle	Spring Brake (Type 14/16)			Wabco 925 488 060 0		Left side with full air brakes Mercedes-Benz Part No. A020 420 67 18
	Spring Brake (Type 14/16)			Wabco 925 488 061 0		Right side with full air brakes Mercedes-Benz Part No. A020 420 68 18











Front Axle	Air Disc Brake (PAN 17)			Wabco		Left side with full air brakes
	Air Disc Brake (PAN 17)			Wabco		Right side with full air brakes
	Brake Disc		24240014			With full air brakes
Rear Axle	Air Disc Brake (PAN 17)			Wabco		Left side with full air brakes
	Air Disc Brake (PAN 17)			Wabco		Right side with full air brakes
	Brake Disc		24070024			With full air brakes
	Disc Brake Pad Set			Wabco		With full air brakes

NOTE: X00 and X50 suffixes refer to Exchange Products which may be Remanufactured.

**Genuine Knorr-Bremse
product with OE quality
reduces maintenance
costs**



Description	Optare Part Number	OE Part Number	Replacement Knorr-Bremse Part No	Remarks <small>Note: Left and Right refer to the side of the vehicle when viewed from the driver's seat facing forward.</small>
Air Compressor				On Mercedes-Benz 6 cylinder OM906LA engine
Air Compressor				On MAN 6 cylinder D0836LOH51 engine
Air Dryer 	L2250290	LA8234 II30448	LA8234 II30448	8.1 bar cut-out Replacement cartridge is 272897SP
Single Check Valve 	L2230013	KW4455/1	KW4455/1	M22 ports
Four Circuit Protection Valve 	20170027	VPS45HY	VPS45HY	With "Safety Feature"
Hand Control Valve 	X2216641	DPM94AAX	DPM94AAX	
Dual Foot Valve 	23090003	DX80E	DX80E	
Double Check Valve 	L2220010 L2230010	295358	295358	M16 ports Bracket mounted
Relay Valve 	R2200219	AC574AXY	AC574AXY	With integral silencer
Quick Release Valve 	L2200286	1186892	1186892	
Low Pressure Switch 	L2230006	272295	272295	5.2 bar, M12 thread
Tilt Drain Valve 	L2230005	EE1100 I94095	KW2350/2	M22 thread



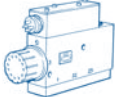
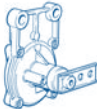

NOTE: X00 and X50 suffixes refer to Exchange Products which may be Remanufactured.

Description		Optare Part Number	OE Part Number	Replacement Knorr-Bremse Part No	Remarks Note: Left and Right refer to the side of the vehicle when viewed from the driver's seat facing forward.
Exhaust Silencer		L2230331	SIL68A	SIL68ASP	Snap-on Alternative Silencers: 0484210017000 or ZB3163-192999
Exhaust Silencer		L2200287	SIL68B	SIL68B	M22 thread Alternative Silencers: 0484210001000 or ZB3150-178074
Exhaust Silencer		21070172	0484210004000	0484210004000	14 mm hose fitting
ABS Modulator		L2220009 L2230009	BR9152 II16278	BR9152 II16278	
ABS Wheel Speed Sensor		L2230348	0265050149000	0486000135000	90° Sensor, cable length 2.0 m Complete with Bush
ABS Wheel Speed Sensor			0486000129000	0486000129100	90° Sensor, cable length 2.0 m Similar Sensor with Bush is 0486000135000
ABS Wheel Speed Sensor		28070059	0486000126100	0486000126100	90° Sensor, cable length 0.4 m Similar Sensor with Bush is 0486000134000
ABS Electronic Control Unit (EU12)		25100013	0486104045000	0486104045100	With drum brakes
ABS Electronic Control Unit (ABS6)		32070014	0486107007100	0486107007100	With disc brakes
Air Suspension Levelling Valve		L2200015 L2230015	SV1294 K002335	SV1294 K002335	Rear axle

Air Suspension

Description	Optare Part Number	OE Part Number	Replacement Knorr-Bremse Part No	Remarks
Air Suspension Electronic Control Unit 	20170013	0504004106000	0504004106100	Replacement ECU needs to be programmed before use
Air Suspension Control Module 	21070122	0501100040000	0501100040100	Front axle With kneeling function
Air Suspension Level Sensor 	21070012	0504002112000	0504002112100	

Front Axle - Drum Brakes	Brake Chamber (Type 20) 	L2210060	BZ3491 I98817	BZ3491 I98817 or BZ3443 I75269	Diaphragm 234099K
	Brake Chamber (Type 20) 	L2210012	BZ3490 I98818	BZ3490 I98818 or BZ3443 I75269	Diaphragm 234099K
Rear Axle - Drum Brakes	Spring Brake (Type 20-80) 	L2210059	K2B1162	K2B0504X50	Spring Portion K2B0004X50 Diaphragm 234099K

Front Axle	Automatic Slack Adjuster 		Haldex		MAN axle, left side
	Automatic Slack Adjuster 		Haldex		MAN axle, right side
Rear Axle	Automatic Slack Adjuster 		Haldex		RABA axle, left side
	Automatic Slack Adjuster 		Haldex		RABA axle, right side



NOTE: X00 and X50 suffixes refer to Exchange Products which may be Remanufactured.



Tempo







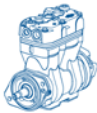
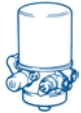

4 x 2

Air Suspension







OPTARE







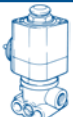

	Description		Optare Part Number	OE Part Number	Replacement Knorr-Bremse Part No	Remarks Note: Left and Right refer to the side of the vehicle when viewed from the driver's seat facing forward.
Front Axle - Disc Brakes	Brake Chamber 					
	Brake Chamber 					
Rear Axle - Disc Brakes	Spring Brake 					

Front Axle	Air Disc Brake 			Meritor		MAN axle, left side
	Air Disc Brake 			Meritor		MAN axle, right side
	Disc Brake Pad Set 			Meritor		
	Brake Disc 					
Rear Axle	Air Disc Brake 			Meritor		Meritor axle, left side
	Air Disc Brake 			Meritor		Meritor axle, right side
	Disc Brake Pad Set 			Meritor		
	Brake Disc 					

Description	Optare Part Number	OE Part Number	Replacement Knorr-Bremse Part No	Remarks Note: Left and Right refer to the side of the vehicle when viewed from the driver's seat facing forward.
Air Compressor				Integral on Mercedes-Benz 4 cylinder OM904LA engine
Air Compressor				Integral on MAN 4 cylinder D0834 engine
Air Compressor (2W460R)		LP4865 K006613	LP4865 K006613X50	On Cummins 6 cylinder ISBe SCR engine Cummins Part No. 3977147
Air Dryer		L2210058	LA8227 II30181	10.0 bar cut-out Replacement cartridge is 272897SP
Four Circuit Protection Valve		20170027	VPS45HY	VPS45HY With "Safety Feature"
Hand Control Valve		X2216641	DPM94AAX	DPM94AAX
Dual Foot Valve		23090003	DX80E	DX80E
Anti-compounding Relay Valve			AC586AY	AC586AY
Relay Valve		R2200219	AC574AXY	AC574AXY With integral silencer
Charging Valve		R2200253	DR4370 K000636	DR4370 K000636 Set valve to required pressure
Low Pressure Switch		L2230006	272295	272295 5.5 bar, M12 thread
Pressure Relief (Safety) Valve		R2200246	KX2073/13	KX2073/13 14 bar, 1/4" NPTF thread



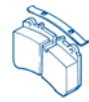





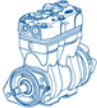
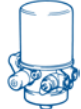

NOTE: X00 and X50 suffixes refer to Exchange Products which may be Remanufactured.

Description		Optare Part Number	OE Part Number	Replacement Knorr-Bremse Part No	Remarks Note: Left and Right refer to the side of the vehicle when viewed from the driver's seat facing forward.
Exhaust Silencer		L2230006 L2230331	SIL68A or ZB3163 192999	SIL68ASP	Snap-on Alternative Silencers: 0484210017000 or ZB3163-1929997
Exhaust Silencer		21070172	0484210004000	0484210004000	14 mm hose fit
ABS Modulator		21070030 L2220009	BR9152 II16278	BR9152 II16278	
ABS Wheel Speed Sensor					Front axle
ABS Wheel Speed Sensor					Rear axle
ABS Electronic Control Unit (ABS6)			0486107007100	0486107007100	
Air Suspension Levelling Valve		L2230015	SV1294 K002335	SV1294 K002335	
Solenoid Valve		L2230017	EDP26AA/1	EDP26AA/1	Normally open





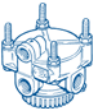





	Description		Optare Part Number	OE Part Number	Replacement Knorr-Bremse Part No	Remarks Note: Left and Right refer to the side of the vehicle when viewed from the driver's seat facing forward.
Front Axle	Brake Chamber 			Wabco		
	Brake Chamber 			Wabco		
Rear Axle	Spring Brake 			Wabco		
Front Axle	Air Disc Brake (PAN 17) 			Wabco		Left side
	Air Disc Brake (PAN 17) 			Wabco		Right side
Rear Axle	Air Disc Brake (PAN 17) 			Wabco		Left side
	Air Disc Brake (PAN 17) 			Wabco		Right side
	Disc Brake Pad Set 					
Front Axle	Brake Disc 					
Rear Axle	Brake Disc 					





NOTE: X00 and X50 suffixes refer to Exchange Products which may be Remanufactured.





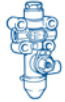
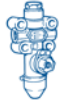

**Product liability? It's part
of the deal when you buy
genuine Knorr-Bremse
parts**

Description	EBL/Plaxton Part Number	OE Part Number	Replacement Knorr-Bremse Part No	Remarks <small>Note: Left and Right refer to the side of the vehicle when viewed from the driver's seat facing forward.</small>
Air Compressor (2W460R) 		LP4865 K006613	LP4865 K006613X50	On Cummins ISBe engine 2 bolt flange, crankshaft has left hand M18 thread Cummins Part No. 3977147
Air Dryer 		LA6210 I87501	LA8234 II30448-B	8.1 bar cut-out. Replacement Cartridge is 272897SP
Air Dryer 		LA8227 II30181	LA8227 II30181	10.0 bar cut-out. Replacement Cartridge is 272897SP
Air Line Filter 		LA2103 I99660	LA2103 I99660	
Four Circuit Protection Valve 		AE4612 II38801F	AE4612 II38801F	With "Safety Feature"
Single Check Valve 		AE5101 I25351	1194016	M22(F) ports
Hand Control Valve 		HB1143 I82171	HB1143 I82171N00	
Hand Control Valve 		HB1147 I82174	HB1147 I82174	
Dual Foot Valve 		MB4764 II36091	MB4764 II36091	With microswitch retarder control
Double Check Valve 		AE4105 I40405	AE4105 I40405	M22 ports
Relay Valve 		AC574AXY	AC574AXY	
Quick Release Valve 		KX1294/1	KX1294/1	M22 ports

NOTE: X00 and X50 suffixes refer to Exchange Products which may be Remanufactured.







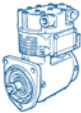
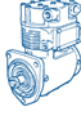
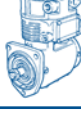

Description	EBL/Plaxton Part Number	OE Part Number	Replacement Knorr-Bremse Part No	Remarks Note: Left and Right refer to the side of the vehicle when viewed from the driver's seat facing forward.
Pressure Limiting Valve 		DB1116 I61707	DB1116 I61707	M22 ports, 3.5 bar
Pressure Limiting Valve 		AC157C	AC157C	M22 ports, 8.0 bar
Pressure Proportioning Valve 		DB2116 K001043	DB1103 I86155	Ratio 1.15:1
Exhaust Silencer 		SIL68B	SIL68B	M22 thread, for Alternative Silencers: 0484210001000 or ZB3150-I78074
Exhaust Silencer 		SIL68A	SIL68ASP	Snap-on Alternative Silencers: 0484210017000 or ZB3163-I92999
Exhaust Silencer 		0484210002000	0484210002000	M16 thread
ABS Electronic Control Unit (EU12) 		0486104039000	0486104039100	
ABS Wheel Speed Sensor 		0486000128000	0486000128100	90° sensor, cable length 1.0 m Alternative is 0486000136000 which includes Sensor Bush
ABS Wheel Speed Sensor 		0486000129000	0486000129100	90° sensor, cable length 2.0 m Alternative is 0486000135000 which includes Sensor Bush
ABS Modulator 		BR9152 II16278	BR9152 II16278	M22 ports Kostal electrical connector

Description	EBL/Plaxton Part Number	OE Part Number	Replacement Knorr-Bremse Part No	Remarks <small>Note: Left and Right refer to the side of the vehicle when viewed from the driver's seat facing forward.</small>
Air Suspension Levelling Valve 		SV1295 I85698	SV1295 I85698	Front axle
Air Suspension Levelling Valve 		SV1294 I80091	SV1294 K002335	Rear axle
Levelling Valve Linkage 		SEB00256	SEB00256	In-line link
Levelling Valve Linkage 		K001406	K001406	Offset link
Air Suspension Solenoid Valve 		EDP26AAX	EDP26AAX	
Solenoid Valve 		0486206103000	0486206103100	

	Description	EBL/Plaxton Part Number	OE Part Number	Replacement Knorr-Bremse Part No	Remarks <small>Note: Left and Right refer to the side of the vehicle when viewed from the driver's seat facing forward.</small>
Front Axle	Brake Chamber (Type 14) 		Wabco 423 114 710 0	<i>BS3251</i> II31782SP	Diaphragm C67204
Rear Axle	Spring Brake (Type14/16) 		Wabco 925 468 250 0	<i>BS9295</i> K007643	
	Spring Brake (Type14/16) 		Wabco 925 468 251 0	<i>BS9296</i> K007642	
Front & Rear Axles	Air Disc Brake (PAN 17) 		Wabco 40 175 079		
	Disc Brake Pad Set 		Wabco		
Front Axle	Brake Disc 				
Rear Axle	Brake Disc 				

Bodied by Alexander (PS and Strider), East Lancs/Darwen (Cityzen, EL2000, European and Flyte), Northern Counties (Paladin), Plaxton (Derwent and Paramount), Van Hool (Alizee) and Wrightbus (Axxess, Endurance and Pathfinder)

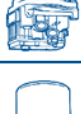
Mechanical & Air Suspension

Description	Scania Part Number	OE Part Number	Replacement Knorr-Bremse Part No	Remarks Note: Left and Right refer to the side of the vehicle when viewed from the driver's seat facing forward.
Air Compressor (2W440D) 	300162 1348919	KZ632/1 1189106	KZ642/2X50	3 bolt flange mounted
Air Compressor (2W440D) 	301525	KZ996/1	KZ996/2X50	3 bolt flange mounted
Air Compressor (2W440D) 	394441	KZ1228/1	KZ1228/1X50	3 bolt flange mounted
Air Compressor (2W440R) 	1303227	LP4815 I97493	LP4815 I97493X50	3 bolt flange mounted
Governor Valve (D2) 	257772	274829	274829	8.0 bar cut-out 1/8" NPTF ports
Governor Valve (D2) 	333851	267098	267098	8.6 bar cut-out M10 ports
Unloader Valve 	457735	Wabco 975 303 072 0	0481039213000	8.5 bar cut-out Adjust replacement valve to 8.5 bar
Unloader Valve 	469239	Wabco 975 303 089 0	0481039213000	Up to Chassis 1823419 9.5 bar cut-out Adjust replacement valve to 9.5 bar
Unloader Valve 	492272	Wabco 975 303 091 0	0481039213000	From Chassis 1823420 10 bar cut-out, with Silencer
Air Dryer (Single Cartridge) 	489832	Haldex (86403) 89464	LA6711 II36936000	Deutsch heater connector. When using LA6711-II36936000, change heater connector on wiring with 1185832
Air Dryer (Single Cartridge) 	470200	Haldex 78986	LA8227 II30181-B	Later vehicles, 10.3 bar cut-out. When using LA8227-II30181, reset unloader to 10.3 bar and change heater connector on wiring with 1185832
Air Dryer (Twin Cartridge) 	448480	Haldex 71206		Kostal heater connector

NOTE: X00 and X50 suffixes refer to Exchange Products which may be Remanufactured.









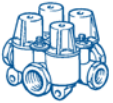
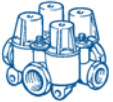

3 Series Bus

4 x 2 & 6 x 2

Mechanical & Air Suspension

SCANIA

Bodied by Alexander (PS and Strider), East Lancs/Darwen (Cityzen, EL2000, European and Flyte), Northern Counties (Paladin), Plaxton (Derwent and Paramount), Van Hool (Alizee) and Wrightbus (Acess, Endurance and Pathfinder)

Description	Scania Part Number	OE Part Number	Replacement Knorr-Bremse Part No	Remarks Note: Left and Right refer to the side of the vehicle when viewed from the driver's seat facing forward.
Alcohol Injector 	295469	0484451005000	0484451005000	
Four Circuit Protection Valve 	307605	Wabco 934 702 381 0	AE4179 I80509 or VPS41BY	Up to Chassis 1183837 and 4315952
Four Circuit Protection Valve 	1337904	Wabco 934 714 028 0		From Chassis 1183838 and 4315953
Single Check Valve 	303497	KW4648/1	KW4648/1	M22 ports
Single Check Valve 	448450	1186831	KW4648/1	M22 ports
Hand Control Valve 	469271	Wabco 961 723 021 0		
Hand Control Valve 	436190	DPM84AX	DPM84AX	
Interlock Valve 	303883	Wabco 434 205 028 0		"Broms" brake
Dual Foot Valve 	1314047	DX70C	DX70C	No treadle, no microswitches
Dual Foot Valve 	469052	(DX80C) DX80D	DX80D	Complete with mounting plate, treadle, retarder control and microswitches. Base Valve - DX81D
Dual Foot Valve 	461159	DX81D	DX81D	Complete with retarder control and microswitches. Base Valve is DX71BY Note: DX71BY requires a 7/16" dia ball bearing fitted in the upper piston
Double Check Valve 	215720	295036	295036	3/8" NPTF ports, bracket mounted

Bodied by Alexander (PS and Strider), East Lancs/Darwen (Cityzen, EL2000, European and Flyte), Northern Counties (Paladin), Plaxton (Derwent and Paramount), Van Hool (Alizee) and Wrightbus (Axxess, Endurance and Pathfinder)

Mechanical & Air Suspension

Description	Scania Part Number	OE Part Number	Replacement Knorr-Bremse Part No	Remarks Note: Left and Right refer to the side of the vehicle when viewed from the driver's seat facing forward.
Double Check Valve 	290017	295358	295358	M16 ports, bracket mounted
Relay Valve (R6) 	217385	295198	295198	
Relay Valve 	350000	AC571AX	AC574AXY	AC574AXY has integral silencer
Relay Valve (R15) 	350001	KY2308/1	AC574AXY	AC574AXY has integral silencer
Relay Valve 	1313871	Wabco 973 011 002 0	AC574AXY	For parking and air suspension kneeling systems. AC574AXY has integral silencer
Quick Release Valve 	371574	KX2552/2	KX2552/3	With internal by-pass
Pressure Limiting Valve 	436775	0481009034000	0481009014000	For door system. Reset replacement valve to 2.4 bar
Low Pressure Switch 	303499	267013	267037	5.0 bar, M12 thread
Low Pressure Switch 	303500	267024	272295	Up to Chassis 1822998 5.5 bar, M12 thread
Low Pressure Switch 	1353406	1189211	272295	From Chassis 1822999 6.0 bar, M12 thread
Tilt Drain Valve 	303501	0481019005000	KW2350/2	M22 thread
Automatic Drain Valve 	639326	Haldex 71311		M22 thread, with heater

NOTE: X00 and X50 suffixes refer to Exchange Products which may be Remanufactured.













3 Series Bus

4 x 2 & 6 x 2

Mechanical & Air Suspension

SCANIA

Bodied by Alexander (PS and Strider), East Lancs/Darwen (Cityzen, EL2000, European and Flyte), Northern Counties (Paladin), Plaxton (Derwent and Paramount), Van Hool (Alizee) and Wrightbus (Access, Endurance and Pathfinder)

Description	Scania Part Number	OE Part Number	Replacement Knorr-Bremse Part No	Remarks Note: Left and Right refer to the side of the vehicle when viewed from the driver's seat facing forward.
Test Connector 	303498	KW3731/1	AC784D	M22 thread
Exhaust Silencer 	339877	0484210001000	SIL68B	For Wabco Relay Valve M22 thread Alternative Silencers: 0484210001000 or ZB3150-178074
Exhaust Silencer 	339878	0484210002000	0484210002000	For Foot Valve M16 thread
Exhaust Silencer 	457736	Wabco 975 303 531 2	0484210009000	For Unloader Valve 32.5 mm Snap-on
ABS Modulator 	1307040	Wabco 475 195 004 0	BR9152 II16278	Front axle
ABS Modulator 	369543	0265351101000	BR9152 II16278	Front & rear axle
Wheel Speed Sensor 	332533 1400674	0265050035000	0486000023000	Front axle 90° sensor, cable length 1.85 m
Wheel Speed Sensor 	1107495 1342971	Wabco 441 032 771 0 441 032 577 0		Front and ASA60 tag axles 90° sensor, cable length 1.55 m
Wheel Speed Sensor 	1355747	Wabco 441 032 555 0		Later front axle 90° sensor, cable length 2.24 m
Wheel Speed Sensor 	1326136 1356604	0265050025000	0265050112000	Rear and ATA90 tag axles 90° sensor, cable length 1.87 m
Wheel Speed Sensor 	1365529	0265050145000		Later rear axle 90° sensor, cable length 1.75 m
Wheel Speed Sensor 	1428443	Wabco 441 032 865 0		Later rear axle 90° sensor, cable length 2.7 m

Bodied by Alexander (PS and Strider), East Lancs/Darwen (Cityzen, EL2000, European and Flyte), Northern Counties (Paladin), Plaxton (Derwent and Paramount), Van Hool (Alizee) and Wrightbus (Axxess, Endurance and Pathfinder)

Mechanical & Air Suspension

Description	Scania Part Number	OE Part Number	Replacement Knorr-Bremse Part No	Remarks <small>Note: Left and Right refer to the side of the vehicle when viewed from the driver's seat facing forward.</small>
ABS Electronic Control Unit (Gamma 2M)	374008 1326135	0265150201000 0265150315000	0265150315000	4 x 2 up to Chassis 1822877
ABS Electronic Control Unit (Gamma 2E)	469479	0265150325000		4 x 2 from Chassis 1822878 Scania only
ABS Electronic Control Unit (Gamma 2E)	460757	0265150301000		6 x 2 up to Chassis 1821460
ABS Electronic Control Unit (Gamma 2M)	463361	0265150302000	0486104023000	6 x 2 from Chassis 1821461
ABS Electronic Control Unit	460756			N113ALB up to Chassis 1827830
ABS Electronic Control Unit (Type C3)	470160 483747	Wabco 446 003 079 0		N113ALB from Chassis 1827831
ABS Electronic Control Unit (Type C2)	1326134	Wabco 446 004 054 0		Replaced by 1334350
ABS Electronic Control Unit (Type C3)	1334350	Wabco 446 004 064 0		
ASR Solenoid Valve	1120891	0481511002000	0481511002000	
Air Suspension Levelling Valve	468568 475110	SV1323 I84808	SV1323 II32764	From Chassis 1823420 Front & rear axles With datum adjustment
Air Suspension Levelling Valve	455904 475111	SV1328 I86030	SV1328 II32765	From Chassis 1823420 Front & rear axles
ECAS Three Solenoid Control Valve	1309501	Wabco 472 900 007 0		For kneeling system

NOTE: X00 and X50 suffixes refer to Exchange Products which may be Remanufactured.







3 Series Bus

4 x 2 & 6 x 2

Mechanical & Air Suspension





SCANIA

Bodied by Alexander (PS and Strider), East Lancs/Darwen (Cityzen, EL2000, European and Flyte), Northern Counties (Paladin), Plaxton (Derwent and Paramount), Van Hool (Alizee) and Wrightbus (Axxess, Endurance and Pathfinder)

Description	Scania Part Number	OE Part Number	Replacement Knorr-Bremse Part No	Remarks Note: Left and Right refer to the side of the vehicle when viewed from the driver's seat facing forward.
Air Suspension Chassis Lowering Valve 	423964	0481007022000	0481007022000	
Clutch Servo 	374116 575184	Kongsberg KA622190	622190AM	
Clutch Servo 	360717	Kongsberg KA622107	622107AM	
Clutch Servo 	360719	Kongsberg KA622109	622109AM	
Clutch Servo 	360720	Kongsberg KA622110		
Clutch Servo 	1337966	Kongsberg KA624199	624199AM	
Exhaust Brake Cylinder 	1332503	Wabco 421 455 000 0		

Bodied by Alexander (PS and Strider), East Lancs/Darwen (Cityzen, EL2000, European and Flyte), Northern Counties (Paladin), Plaxton (Derwent and Paramount), Van Hool (Alizee) and Wrightbus (Axxess, Endurance and Pathfinder)

Mechanical & Air Suspension

	Description	Scania Part Number	OE Part Number	Replacement Knorr-Bremse Part No	Remarks Note: Left and Right refer to the side of the vehicle when viewed from the driver's seat facing forward.
Front Axle	Brake Chamber (Type 16) 	1331428	1186699-01	1186699-01	Vehicles with short rear overhang 64 mm stroke Diaphragm 234189K
	Brake Chamber (Type 20LS) 	1305774 1313761 1313841 1313886	Wabco 423 105 084 0 425 105 451 0 425 105 450 0 425 105 457 0	<i>BX3419</i> II33782A	75 mm stroke Diaphragm 20LS
	Brake Chamber (Type 24LS) 	1305777 1313844	Wabco 423 106 088 0 425 106 450 0	<i>BX3538</i> II33783A	75 mm stroke Diaphragm 24LS
Rear Axle	Spring Brake (Type 20/24) 	1313829 1446037	Wabco 925 430 006 0 925 430 036 0	K2B0504X50	Spring Portion K2B0004X50 Diaphragm 234099K
	Spring Brake (Type 24-80) 	1350234	K2D0706	K2D0706X50	Diaphragm 24LS
	Spring Brake (Type 24-105) 	1307387 1350235	K2D3015 K2D0714	K2D0714X50	Spring Portion K2D0214X50 Diaphragm 24LS
	Spring Brake (Type 30-105) 	1350236	K2D0722	K2D0722X50	Up to Chassis 1823246 Spring Portion K2D0222X50 Diaphragm 30LS
	Spring Brake (Type 30-105) 	1361987	K2G0822	K2G0822X50	Up to Chassis 1823247 to 1825372 Spring Portion K2D0222X50 Diaphragm 30LS
	Spring Brake (Type 30/30) 	1354877	Wabco 925 431 411 0	K2B0522X50	Left side Spring Portion K2B0022X50 Diaphragm 234101K
	Spring Brake (Type 30/30) 	1354878	Wabco 925 431 412 0	K2B0522X50	Right side Spring Portion K2B0022X50 Diaphragm 234101K
Tag Axle	Brake Chamber (Type 12) 	309418	267316	295530	Diaphragm 234226K
	Spring Brake (Type 20/24) 	1446037	Wabco 925 430 036 0	K2B0504X50	Spring Portion K2B0004X50 Diaphragm 234099K

NOTE: X00 and X50 suffixes refer to Exchange Products which may be Remanufactured.







3 Series Bus

4 x 2 & 6 x 2

Mechanical & Air Suspension

SCANIA

Bodied by Alexander (PS and Strider), East Lancs/Darwen (Cityzen, EL2000, European and Flyte), Northern Counties (Paladin), Plaxton (Derwent and Paramount), Van Hool (Alizee) and Wrightbus (Axxess, Endurance and Pathfinder)

	Description	Scania Part Number	OE Part Number	Replacement Knorr-Bremse Part No	Remarks Note: Left and Right refer to the side of the vehicle when viewed from the driver's seat facing forward.
Front Axle	Manual Slack Adjuster 	1448111	267083	267083	Left side 50 mm offset, 165 mm hole centre
	Manual Slack Adjuster 	1448112	267084	267084	Right side 50 mm offset, 165 mm hole centre
Rear Axle	Manual Slack Adjuster 	1448115	267026	267026	Left side 25 mm offset plus crank, 165 mm hole centre
	Manual Slack Adjuster 	1448114	267027	267027	Right side 25 mm offset plus crank, 165 mm hole centre
Tag Axle	Manual Slack Adjuster 	1448116	272862	272862	Left side 15.9 mm offset, 130 mm hole centre
	Manual Slack Adjuster 	1448117	272863	272863	Right side 15.9 mm offset, 130 mm hole centre

Bodied by Alexander (PS and Strider), East Lancs/Darwen (Cityzen, EL2000, European and Flyte), Northern Counties (Paladin), Plaxton (Derwent and Paramount), Van Hool (Alizee) and Wrightbus (Axxess, Endurance and Pathfinder)

Mechanical & Air Suspension







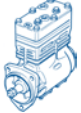
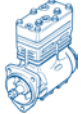
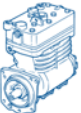
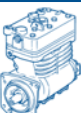
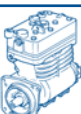

	Description	Scania Part Number	OE Part Number	Replacement Knorr-Bremse Part No	Remarks <small>Note: Left and Right refer to the side of the vehicle when viewed from the driver's seat facing forward.</small>
Front Axle	Automatic Slack Adjuster 	1112829	Haldex 72663	KB2215	Left side, mechanical suspension 50 mm offset, 0° inclination, 165 mm hole centre
	Automatic Slack Adjuster 	1112830	Haldex 72664	KB2210	Right side, mechanical suspension 50 mm offset, 0° inclination, 165 mm hole centre
	Automatic Slack Adjuster 	1112839	Haldex 72825	KB2360	Left side, air suspension 50 mm offset, 22° inclination, 165 mm hole centre
	Automatic Slack Adjuster 	1112840	Haldex 72826	KB2595	Right side, air suspension 50 mm offset, 22° inclination, 165 mm hole centre
Rear Axle	Automatic Slack Adjuster 	1112833	Haldex 72660	KB2220	Left side 25 mm offset, 165 mm hole centre
	Automatic Slack Adjuster 	1112834	Haldex 72661	KB2260	Right side 25 mm offset, 165 mm hole centre
Tag Axle	Automatic Slack Adjuster 	394189	Haldex 72727	KB2585	Left side 16 mm offset, 165 mm hole centre
	Automatic Slack Adjuster 	394190	Haldex 72728	KB2590	Right side 16 mm offset, 165 mm hole centre

NOTE: X00 and X50 suffixes refer to Exchange Products which may be Remanufactured.

**Remember! If it's not
Knorr-Bremse on the box
then it's not Knorr-Bremse
in the box**

Bodied by East Lancs/Darwen (Esteem, Olympus and OmniDekka), Irizar (Century), Plaxton (Derwent), Scania (Omnicity, Omnilink and Omnitown) and Wrightbus (Acess and Solar)

Mechanical & Air Suspension

Description	Scania Part Number	OE Part Number	Replacement Knorr-Bremse Part No	Remarks Note: Left and Right refer to the side of the vehicle when viewed from the driver's seat facing forward.
Air Compressor (2W440R) 	1303226	LP4814 I97492	LP4814 I97492X50	3 bolt flange mounted
Air Compressor (2W440R) 	1303227	LP4815 I97493	LP4815 I97493X50	3 bolt flange mounted
Air Compressor (2W600R) 	1380455	LP4964 II32687	LP4964 K002046X00	5 bolt flange mounted with ESS
Air Compressor (2W600R) 	1380457	LP4965 II32688	LK4941 K016615000	5 bolt flange mounted with ESS and through drive
Air Compressor (2W600R) 	1541705 1728435 1770607 1784109 1796663	LK4941 K003960 K012799 K014896 K016615	LK4941 K016615000	5 bolt flange mounted with ESS and through drive
Air Compressor (2W720R) 	1514066 1537798 1745702	LK4930 K009403	LK4930 K009403X00	Universal flange mounted
Governor Valve (D2) 	333851	267098	267098	8.6 bar Cut-out M10 ports
Air Dryer (Single Cartridge) 	470200 489834	Haldex 78986 86499	LA8227 II30181-B See Remarks	10.3 bar Cut-out. When using LA8227-II30181, reset unloader to 10.3 bar and change heater connector on wiring with 1185832
Air Dryer (Single Serviceable Cartridge) 	1369763 1441751	Wabco 432 410 010 0	LA8229 II30443N00 See Remarks	9.3 bar Cut-out, Deutsch heater connector on cable. Add Heater I87122004 to LA8229-II30443 and use Bolts SK3055/1
Condenser 	1492038	Haldex 90323		Later buses, mounted in engine compartment, upstream of Air Dryer
Four Circuit Protection Valve 	1381883 1395945	Wabco 934 714 028 0		
Four Circuit Protection Valve 	1431049	Wabco 934 714 128 0		With "Safety Feature"

NOTE: X00 and X50 suffixes refer to Exchange Products which may be Remanufactured.

4 Series Bus

4 x 2 & 6 x 2

Mechanical & Air Suspension







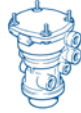
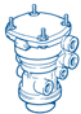

SCANIA

Bodied by East Lancs/Darwen (Esteem, Olympus and OmniDekka), Irizar (Century), Plaxton (Derwent), Scania (Omnicity, Omnilink and Omnitown) and Wrightbus (Acess and Solar)

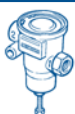
Description	Scania Part Number	OE Part Number	Replacement Knorr-Bremse Part No	Remarks
Single Check Valve 	448450	1186831	KW4648/1	M22 ports
Hand Control Valve 	469271	Wabco 961 723 021 0		With Interlock Valve
Hand Control Valve 	1108720	Wabco 961 722 214 0		
Interlock Valve 	1373080	Wabco 434 205 032 0		"Broms" brake
Dual Foot Valve 	469052	(DX80C) DX80D	DX80D	Complete with mounting plate, treadle, microswitches and retarder control for ZF Generation 1 retarder. Base Valve - DX81D
Dual Foot Valve 	461159	DX81D	DX81D	Complete with retarder control and microswitches. Base Valve is DX71BY Note: DX71BY requires a 7/16" dia ball bearing fitted in the upper piston
Dual Foot Valve 	492273	DX80E	DX80E	Complete with mounting plate and treadle For ZF Generation 2, Telma and Scania retarders.
Dual Foot Valve 	1324663	Wabco 461 315 180 0	0481064603000	Manifold porting
EBS Dual Foot Valve 	1793647	K001973	K001973N00	
Double Check Valve 	290017	295358	295358	M16 ports Bracket mounted
Relay Valve 	1350118 1425183	Wabco 973 011 050 0	0481026027000	
Relay Valve 	1313871 1411244	Wabco 973 011 002 0 973 011 010 0	AC574AXY	AC574AXY has integral silencer

Bodied by East Lancs/Darwen (Esteem, Olympus and OmniDekka), Irizar (Century), Plaxton (Derwent), Scania (Omnicity, Omnilink and Omnitown) and Wrightbus (Acess and Solar)

Mechanical & Air Suspension

Description	Scania Part Number	OE Part Number	Replacement Knorr-Bremse Part No	Remarks Note: Left and Right refer to the side of the vehicle when viewed from the driver's seat facing forward.
Quick Release Valve 	371574 1422152	KX2552/2 KX2552/3	KX2552/3	With internal by-pass
Trailer Control Valve 	489184	Wabco 973 009 120 0		On tag axle Ports 12 and 43 plugged
Trailer Control Valve 	1350096	Wabco 973 009 010 0	AC597A	For articulated vehicles
Pressure Limiting Valve 	1334846 1371429	0481009029000 0148009064000	0481009029000 or reset 0481009014000	8.0 bar, M16 ports
Pressure Limiting Valve 	367739 362425	0481009101000	0481009018000 or reset 0481009014000	For retarder circuit 7.3 bar, M16 ports
Pressure Limiting Valve 	475943	AC155F	AC155FA or reset 0481009014000	3.0 bar, M16 ports
Pressure Limiting Valve 	1374318	AC155E	AC155E or reset 0481009014000	For exhaust brake circuit 6.5 bar, M16 ports
Pressure Limiting Valve 	475944	AC155D	AC155D or reset 0481009014000	For retarder circuit 5.4 bar, M16 ports
Tilt Drain Valve 	1382866 1403463		KW2350/2	M22 thread
Test Connector 	303498	KW3731/1	AC784D	M22 thread

NOTE: X00 and X50 suffixes refer to Exchange Products which may be Remanufactured.













4 Series Bus

4 x 2 & 6 x 2

Mechanical & Air Suspension









SCANIA

Bodied by East Lancs/Darwen (Esteem, Olympus and OmniDekka), Irizar (Century), Plaxton (Derwent), Scania (Omnicity, Omnilink and Omnitown) and Wrightbus (Acess and Solar)

	Description	Scania Part Number	OE Part Number	Replacement Knorr-Bremse Part No	Remarks <small>Note: Left and Right refer to the side of the vehicle when viewed from the driver's seat facing forward.</small>
	Exhaust Silencer 	339877	0484210001000	SIL68B	For QRV up to Chassis 3503629 and Suspension Control Modules. M22 thread Alternative Silencers: 0484210001000 or ZB3150-I78074
	Exhaust Silencer 	485467	0484210018000	SIL68B	For Foot Valve and Relay Valve, and for Air Dryer up to Chassis 1832723 and QRV from 3503629. M22 thread
	Exhaust Silencer 	1313854	Wabco 432 407 070 0	SIL68ASP	For Air Dryer up to Chassis 1832722. Snap-on Alternative Silencers: 0484210017000 or ZB3163-I92999
	ABS Modulator 	1307040	Wabco 475 195 004 0	BR9152 II16278	
Front Axle	Wheel Speed Sensor 	483425 (LH) 483426 (RH)	Wabco 441 032 470 0 441 032 469 0		With drum brakes 90° sensor, cable length 2.26 m
	Wheel Speed Sensor 	483421 (LH) 483422 (RH)	Wabco 441 032 468 0 441 032 467 0		With drum brakes Straight sensor, cable length 2.24 m
	Wheel Speed Sensor 	1438888	Wabco 441 032 886 0		Left side, with drum brakes 90° sensor, cable length 2.54 m
	Wheel Speed Sensor 	1438889	Wabco 441 032 885 0		Right side with drum brakes 90° sensor, cable length 2.69 m
	Wheel Speed Sensor 	1360615	Wabco 441 032 729 0		With disc brakes Straight sensor, cable length 1.17 m
	Wheel Speed Sensor 	1431120	Wabco 441 032 410 0		With disc brakes Straight sensor, cable length 1.15 m
Drive Axle	Wheel Speed Sensor 	438423 1441274	0486000028000		Left side with drum brakes
	Wheel Speed Sensor 	438424 1441277	0486000029000		Right side with drum brakes

Bodied by East Lancs/Darwen (Esteem, Olympus and OmniDekka), Irizar (Century), Plaxton (Derwent), Scania (Omnicity, Omnilink and Omnitown) and Wrightbus (Acess and Solar)

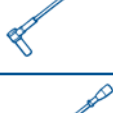
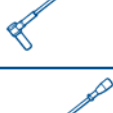
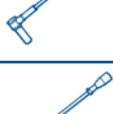
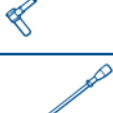
Mechanical & Air Suspension

	Description	Scania Part Number	OE Part Number	Replacement Knorr-Bremse Part No	Remarks <small>Note: Left and Right refer to the side of the vehicle when viewed from the driver's seat facing forward.</small>
Drive Axle (contd)	Wheel Speed Sensor 	136526 1428447	0265050143000	0265050143000	Left side AD/ADA1500P axle with drum brakes. 90° sensor, cable length 1.91 m
	Wheel Speed Sensor 	136529 1428443	0265050145000		Right side AD/ADA1500P axle with drum brakes. 90° sensor, cable length 1.75 m
	Wheel Speed Sensor 	1386289	0486001007000		Left side with disc brakes. Straight sensor, cable length 2.69 m
	Wheel Speed Sensor 	1386290	0486001006000		Right side with disc brakes. Straight sensor, cable length 2.69 m
	Wheel Speed Sensor 	1428451	Wabco 441 032 401 0 441 032 901 0		Left side with disc brakes. Straight sensor, cable length 2.68 m
	Wheel Speed Sensor 	1428452	Wabco 441 032 402 0 441 032 902 0		Right side with disc brakes. Straight sensor, cable length 2.68 m
Tag Axle	Wheel Speed Sensor 	483425 (LH) 483426 (RH)	Wabco 441 032 470 0 441 032 469 0		With drum brakes 90° sensor, cable length 2.26 m
	Wheel Speed Sensor 	483421 (LH) 483422 (RH)	Wabco 441 032 468 0 441 032 467 0		With drum brakes Straight sensor, cable length 2.24 m
	Wheel Speed Sensor 	1438888 (LH) 1438889 (RH)	Wabco 441 032 886 0 441 032 885 0		With drum brakes 90° sensor, cable length 2.54 m (LH), 2.69 m (RH)
	Wheel Speed Sensor 	1438889	Wabco 441 032 885 0		Right side with drum brakes 90° sensor, cable length 2.69 m
	Wheel Speed Sensor 	485209 1441278	Wabco 441 032 463 0 441 032 914 0		Left side ASA100X axle with disc brakes. Straight sensor, cable length 2.15 m
	Wheel Speed Sensor 	485208 1441275	Wabco 441 032 464 0 441 032 915 0		Right side ASA100X axle with disc brakes. Straight sensor, cable length 2.15 m

NOTE: X00 and X50 suffixes refer to Exchange Products which may be Remanufactured.













4 Series Bus

4 x 2 & 6 x 2

Mechanical & Air Suspension









SCANIA

Bodied by East Lancs/Darwen (Esteem, Olympus and OmniDekka), Irizar (Century), Plaxton (Derwent), Scania (Omnicity, Omnilink and Omnitown) and Wrightbus (Acess and Solar)

Description	Scania Part Number	OE Part Number	Replacement Knorr-Bremse Part No	Remarks Note: Left and Right refer to the side of the vehicle when viewed from the driver's seat facing forward.
ABS Electronic Control Unit (Type D) 	489814	Wabco 446 004 406 0		4 x 2 with EDC 4S4M system
ABS Electronic Control Unit (Type D) 	489813	Wabco 446 004 404 0		4 x 2 without EDC 4S4M system
ABS Electronic Control Unit (Type D) 	1400577 1412038	Wabco 446 003 403 0		6 x 2 DC9 6S6M system
ABS Electronic Control Unit (Type D) 	1446256	Wabco 446 003 416 0		6 x 2 DC913 & DC915 6S6M system
ABS Electronic Control Unit (Type D) 	483747	Wabco 446 003 079 0		6 x 2 DC912 up to Chassis 1837819 and DS19 6S6M system
ABS Electronic Control Unit (Type D) 	1431865	Wabco		6 x 2 DC912 from Chassis 1837820 6S6M system
ASR Solenoid Valve 	1340231 1421322	Norgren-Herion T.61.01.003		
EBS Axle Control Module (1 Channel) 	1773676	K000085	K000085N00	Front axle
EBS Axle Control Module (2 Channel) 	1773680	K000086	K000086N00	Rear axle
EBS Axle Control Module (2 Channel) 	1773677	K000088	K000086N00	Rear axle
EBS Electronic Control Unit (EBS5) 	1766306	0486106065000		Without Electronic Stability Program (ESP) Replacement ECU must be programmed before use Scania only
EBS Electronic Control Unit (EBS5) 	1766305	0486106050000		With Electronic Stability Program (ESP) Replacement ECU must be programmed before use Scania only

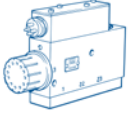
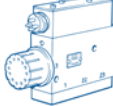
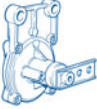
Bodied by East Lancs/Darwen (Esteem, Olympus and OmniDekka), Irizar (Century), Plaxton (Derwent), Scania (Omnicity, Omnilink and Omnitown) and Wrightbus (Acess and Solar)

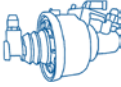
Mechanical & Air Suspension

Description	Scania Part Number	OE Part Number	Replacement Knorr-Bremse Part No	Remarks Note: Left and Right refer to the side of the vehicle when viewed from the driver's seat facing forward.
Yaw Rate Sensor (ESP) 	1441153	0486020003000	0486020002N00	
Steering Angle Sensor (ESP) 	1427269	0486021003000	0486021003N00	
Air Suspension Levelling Valve 	468568 475110	SV1323 I84808	SV1323 II32764	With datum adjustment
Air Suspension Levelling Valve 	455904 475111	SV1328 I86030	SV1328 II32765	
Air Suspension Electronic Control Unit 	483114 489555	0504004109000	0504004109000	
Air Suspension Control Module 	481831	0501100028000	0501100041100	Front axle With kneeling function
Air Suspension Control Module 	481830	0501100027000	0501100040100	Rear axle
Air Suspension Level Sensor 	481829	0504002111000	0504002113100	
Air Suspension Solenoid Valve 	481832	0501100032000	0501100038100	Load transfer control
Clutch Servo (Servomaster) 	1367453 1421186	Kongsberg KA625359 KA627692	629683AM	
Exhaust Brake Cylinder 	1376474 1400769	Wabco 421 411 312 0 421 411 314 0		
Throttle Control Cylinder 	1336634	Wabco 421 442 005 0 421 442 008 0		

NOTE: X00 and X50 suffixes refer to Exchange Products which may be Remanufactured.

4 Series Bus

4 x 2 & 6 x 2

Mechanical & Air Suspension





SCANIA





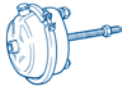

Bodied by East Lancs/Darwen (Esteem, Olympus and OmniDekka), Irizar (Century), Plaxton (Derwent), Scania (Omnicity, Omnilink and Omnitown) and Wrightbus (Acess and Solar)

	Description	Scania Part Number	OE Part Number	Replacement Knorr-Bremse Part No	Remarks <small>Note: Left and Right refer to the side of the vehicle when viewed from the driver's seat facing forward.</small>
Front Axle with Drum Brakes	Brake Chamber (Type 16) 	1331428	1186699-01	1186699-01	Vehicles with short rear overhang 64 mm stroke Diaphragm 234189K
	Brake Chamber (Type 20LS) 	1305774	Wabco 423 105 084 0	<i>BX3419</i> II33782A	75 mm stroke Diaphragm 20LS
	Brake Chamber (Type 20LS) 	1313761	Wabco 425 105 451 0	<i>BX3419</i> II33782A	75 mm stroke Diaphragm 20LS
	Brake Chamber (Type 20LS) 	1313841	Wabco 425 105 450 0	<i>BX3419</i> II33782A	75 mm stroke Diaphragm 20LS
	Brake Chamber (Type 24LS) 	1305777	Wabco 423 106 088 0	<i>BX3538</i> II33783A	75 mm stroke Diaphragm 24LS
	Brake Chamber (Type 24LS) 	1313844	Wabco 425 106 450 0	<i>BX3538</i> II33783A	75 mm stroke Diaphragm 24LS
Rear Axle with Drum Brakes	Spring Brake (Type 24/20) 	1372913 1446053	Wabco 925 431 402 0 925 431 422 0	K2B0514X50	Spring Portion K2B0014X50 Diaphragm 234100K
	Spring Brake (Type 24/30) 	1372914 1446054	Wabco 925 431 403 0 925 431 423 0	K2B0514X50	Spring Portion K2B0014X50 Diaphragm 234100K
	Spring Brake (Type 24/30HF) 	1369994 1446052	Wabco 925 431 410 0 925 431 490 0		Diaphragm 234100K

Bodied by East Lancs/Darwen (Esteem, Olympus and OmniDekka), Irizar (Century), Plaxton (Derwent), Scania (Omnicity, Omnilink and Omnitown) and Wrightbus (Acess and Solar)

Mechanical & Air Suspension

	Description	Scania Part Number	OE Part Number	Replacement Knorr-Bremse Part No	Remarks Note: Left and Right refer to the side of the vehicle when viewed from the driver's seat facing forward.
Tag Axle with Drum Brakes	Brake Chamber (Type 16) 	1331428	1186699-01	1186699-01	64 mm stroke Diaphragm 234189K
	Brake Chamber (Type 20LS) 	1305774	Wabco 423 105 084 0	BX3419 II33782A	75 mm stroke Diaphragm 20LS
	Spring Brake (Type 16-80) 	1331410	K2B0502	K2B0502X50	Spring Portion K2B0002X50 Diaphragm 234189K
	Spring Brake (Type 20/24) 	1313829 1446037	Wabco 925 430 006 0 925 430 036 0	K2B0504X50	Spring Portion K2B0004X50 Diaphragm 234099K

Front Axle	Manual Slack Adjuster 	1342543 1448120	1189483	1189483	Left side 65 mm offset, 165 mm hole centre
	Manual Slack Adjuster 	1342544 1448121	1189484	1189484	Right side 65 mm offset, 165 mm hole centre
Rear Axle	Manual Slack Adjuster 	1448115	267026	267026	Left side 25 mm offset plus crank, 165 mm hole centre
	Manual Slack Adjuster 	1448114	267027	267027	Right side 25 mm offset plus crank, 165 mm hole centre
Tag Axle	Manual Slack Adjuster 	1342543 1448120	1189483	1189483	Left side 65 mm offset, 165 mm hole centre
	Manual Slack Adjuster 	1342544 1448121	1189484	1189484	Right side 65 mm offset, 165 mm hole centre

NOTE: X00 and X50 suffixes refer to Exchange Products which may be Remanufactured.







4 Series Bus

4 x 2 & 6 x 2

Mechanical & Air Suspension

SCANIA













Bodied by East Lancs/Darwen (Esteem, Olympus and OmniDekka), Irizar (Century), Plaxton (Derwent), Scania (Omnicity, Omnilink and Omnitown) and Wrightbus (Acess and Solar)

	Description	Scania Part Number	OE Part Number	Replacement Knorr-Bremse Part No	Remarks <small>Note: Left and Right refer to the side of the vehicle when viewed from the driver's seat facing forward.</small>
Front Axle	Automatic Slack Adjuster 	1358635	Haldex 79443	KB2740	Left side 65 mm offset, 165 mm hole centre
	Automatic Slack Adjuster 	1358634	Haldex 79442	KB2735	Right side 65 mm offset, 165 mm hole centre
Rear Axle	Automatic Slack Adjuster 	1112833	Haldex 72660	KB2220	Left side 25 mm offset, 165 mm hole centre
	Automatic Slack Adjuster 	1112834	Haldex 72661	KB2260	Right side 25 mm offset, 165 mm hole centre
Tag Axle	Automatic Slack Adjuster 	1358635	Haldex 79443	KB2740	Left side 65 mm offset, 165 mm hole centre
	Automatic Slack Adjuster 	1358634	Haldex 79442	KB2735	Right side 65 mm offset, 165 mm hole centre

Value for money!
That'll be a genuine
Knorr-Bremse part

Bodied by East Lancs/Darwen (Esteem, Olympus and OmniDekka), Irizar (Century), Plaxton (Derwent), Scania (Omnicity, Omnilink and Omnitown) and Wrightbus (Acess and Solar)

Mechanical & Air Suspension

	Description	Scania Part Number	OE Part Number	Replacement Knorr-Bremse Part No	Remarks Note: Left and Right refer to the side of the vehicle when viewed from the driver's seat facing forward.
Front Axle with Disc Brakes	Brake Chamber (Type 24) 	1397381	BS3534 II36889	BS3509 II30618	Left side up to Chassis 1832703 Diaphragm C72337
	Brake Chamber (Type 24) 	1397382	BS3535 II36890	BS3509 II30618	Right side up to Chassis 1832703 Diaphragm C72337
	Brake Chamber (Type 24) 	1420134	BS3540 II37474	BS3509 II30618	From Chassis 1832704 Diaphragm C72337
	Brake Chamber (Type 24) 	1427479	BS2503 II38475F	BS2503 K006490N00 or BS3509 II30618	Diaphragm C72337
	Brake Chamber (Type 24 OBC) 	1851934	BS2503 K006490	BS2503 K006490N00 or BS3509 II30618	
Rear Axle with Disc Brakes	Spring Brake (Type 24/30) 	1424306	BS9536 II37747	BS8500 II38470F000	On Axial Air Disc Brakes Diaphragm C72337
	Spring Brake (Type 24/30) 	1427480	BS8500 II38470F	BS8500 II38470F000	On Axial Air Disc Brakes Diaphragm C72337
	Spring Brake (Type 24/30) 	1424801	BS9527 II34198	BS9527 II34198000	On ZF axle - Radial Air Disc Brakes Diaphragm C72337
Tag Axle with Disc Brakes	Brake Chamber (Type 16) 	1450301	BS3338 II39693F	BS3338 K006334N00	On ARA860D Rear Steer axle Diaphragm C72596
	Brake Chamber (Type 16 OBC) 	1450301	BS3338 K006334	BS3338 K006334N00	On ARA860D Rear Steer axle
	Spring Brake (Type 16/14) 	1450308 1485837	BS8302 II39687F	BS8302 II39687FN00	On ARA860D Rear Steer axle Diaphragm C72596
	Spring Brake (Type 24/30) 	1424801	BS9527 II34198	BS9527 II34198000	On ASA100X axle Diaphragm C72337

NOTE: X00 and X50 suffixes refer to Exchange Products which may be Remanufactured.













4 Series Bus

4 x 2 & 6 x 2

Mechanical & Air Suspension



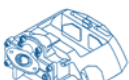



SCANIA

Bodied by East Lancs/Darwen (Esteem, Olympus and OmniDekka), Irizar (Century), Plaxton (Derwent), Scania (Omnicity, Omnilink and Omnitown) and Wrightbus (Acess and Solar)

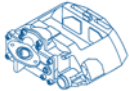
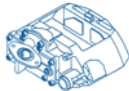
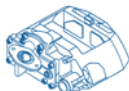
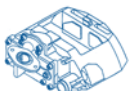
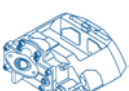
	Description	Scania Part Number	OE Part Number	Replacement Knorr-Bremse Part No	Remarks Note: Left and Right refer to the side of the vehicle when viewed from the driver's seat facing forward.
Front Axle	Air Disc Brake (Axial) 	1365720 1390432	SB7596 II33433	Caliper K003809	Left side, actuator mounting 0° With in-pad and electronic wear sensing Guide Pins & Bushes Kit K001532 In-pad Wear Sensor Kit K000683
	Air Disc Brake (Axial) 	1365719 1390431	SB7586 II33432	Caliper K003810	Right side, actuator mounting 0° With in-pad and electronic wear sensing Guide Pins & Bushes Kit K001532 In-pad Wear Sensor Kit K000683
	Air Disc Brake (Axial) 	1363748	SB7676 II33431	Caliper K003803	Left side, actuator mounting 0° With in-pad wear sensing Guide Pins & Bushes Kit K001532 In-pad Wear Sensor Kit K001271
	Air Disc Brake (Axial) 	1473365	SB7898 Z0013572	Caliper K003803	Left side, actuator mounting 0° With in-pad wear sensing Guide Pins & Bushes Kit K000375 In-pad Wear Sensor Kit K000683
	Air Disc Brake (Axial) 	1363749	SB7666 II33430	Caliper K003804	Right side, actuator mounting 0° With in-pad wear sensing Guide Pins & Bushes Kit K001532 In-pad Wear Sensor Kit K001271
	Air Disc Brake (Axial) 	1473364	SB7888 Z0013571	Caliper K003804	Right side, actuator mounting 0° With in-pad wear sensing Guide Pins & Bushes Kit K000375 In-pad Wear Sensor Kit K000683
Rear Axle	Air Disc Brake (Axial) 	1363748	SB7676 II33431	Caliper K003803	Left side, actuator mounting 0° With in-pad wear sensing Guide Pins & Bushes Kit K001532 In-pad Wear Sensor Kit K001271
	Air Disc Brake (Axial) 	1473365	SB7898 Z0013572	Caliper K003803	Left side, actuator mounting 0° With in-pad wear sensing Guide Pins & Bushes Kit K000375 In-pad Wear Sensor Kit K000683
	Air Disc Brake (Axial) 	1363749	SB7666 II33430	Caliper K003804	Right side, actuator mounting 0° With in-pad wear sensing Guide Pins & Bushes Kit K001532 In-pad Wear Sensor Kit K001271
	Air Disc Brake (Axial) 	1473364	SB7888 Z0013571	Caliper K003804	Right side, actuator mounting 0° With in-pad wear sensing Guide Pins & Bushes Kit K000375 In-pad Wear Sensor Kit K000683
	Air Disc Brake (Radial) 	1426663	SB7135 II37817	Caliper K002962	ADA1350D axle, left side Actuator mounting 93° With in-pad wear sensing Guide Pins & Bushes Kit II39769F0062 In-pad Wear Sensor Kit K001271
	Air Disc Brake (Radial) 	1426662	SB7125 II37816	Caliper K002963	ADA1350D axle, right side Actuator mounting 93° With in-pad wear sensing Guide Pins & Bushes Kit II39769F0062 In-pad Wear Sensor Kit K001271

Bodied by East Lancs/Darwen (Esteem, Olympus and OmniDekka), Irizar (Century), Plaxton (Derwent), Scania (Omnicity, Omnilink and Omnitown) and Wrightbus (Acess and Solar)

Mechanical & Air Suspension





	Description	Scania Part Number	OE Part Number	Replacement Knorr-Bremse Part No	Remarks Note: Left and Right refer to the side of the vehicle when viewed from the driver's seat facing forward.
Tag Axle	Air Disc Brake (Radial) 	1426663	SB7135 II37817	Caliper K002962	ASA100X axle, left side Actuator mounting 93° With in-pad wear sensing Guide Pins & Bushes Kit II39769F0062 In-pad Wear Sensor Kit K001271
	Air Disc Brake (Radial) 	1426662	SB7125 II37816	Caliper K002963	ASA100X axle, right side Actuator mounting 93° With in-pad wear sensing Guide Pins & Bushes Kit II39769F0062 In-pad Wear Sensor Kit K001271
	Air Disc Brake (Radial) 	1450417	SB7177 Z0014982	Caliper K002966	ARA860D Rear Steer axle, left side Actuator mounting 86° With in-pad wear sensing Guide Pins & Bushes Kit K000375 In-pad Wear Sensor Kit K000683
	Air Disc Brake (Radial) 	1480811	SB7199 K000263	Caliper K002966	ARA860D Rear Steer axle, left side Actuator mounting 86° With in-pad wear sensing Guide Pins & Bushes Kit K001532 In-pad Wear Sensor Kit K000683
	Air Disc Brake (Radial) 	1450416	SB7167 Z0014981	Caliper K002967	ARA860D Rear Steer axle, right side Actuator mounting 86° With in-pad wear sensing Guide Pins & Bushes Kit II39769F0062 In-pad Wear Sensor Kit K001271
	Air Disc Brake (Radial) 	1480812	SB7189 K000262	Caliper K002967	ARA860D Rear Steer axle, right side Actuator mounting 86° With in-pad wear sensing Guide Pins & Bushes Kit K001532 In-pad Wear Sensor Kit K000683
	Disc Brake Pad Set 	1521979		K006060	All axles
Front Axle	Brake Disc 	1402272		K000810	
Rear Axle	Brake Disc 			II371910061	ZF axle ZF Part No. 0501 316 953
Tag Axle	Brake Disc 	1415147			ASA100X axle
	Brake Disc 	1402272		K000810	ARA860D Rear Steer axle

NOTE: X00 and X50 suffixes refer to Exchange Products which may be Remanufactured.

**Increase your uptime -
reduce your downtime?
Fit genuine Knorr-Bremse
parts**

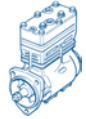
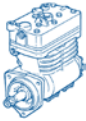
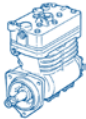
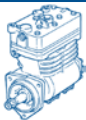
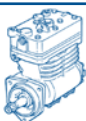
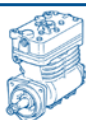
Bodied by Alexander (ALX200 and Dash), East Lancs/Darwen (EL2000, Flyte and Spryte), Marshall (C33), Northern Counties (Paladin), Plaxton (Pointer) and Wrightbus (Crusader)

Air Suspension

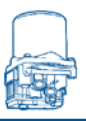
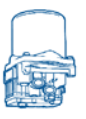
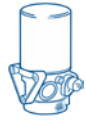
Description	Volvo Part Number	OE Part Number	Replacement Knorr-Bremse Part No	Remarks Note: Left and Right refer to the side of the vehicle when viewed from the driver's seat facing forward.
Air Compressor (2W440R) 	1613632	LP4813 I90499	LP4813 I90499X50	3 bolt flange mounted
Air Compressor (2W600R) 	3194908	LP4989 II38142F	LK4921 K001268000	B6LE 3 bolt flange mounted Replaced by 70303446
Air Compressor (2W600R) 	70303446	LP4996 II38845F	LK4921 K001268000	B6LE 3 bolt flange mounted Replaced by 70305892
Air Compressor (2W600R) 	70305892	LK4921 II39080F	LK4921 K001268000	B6LE 3 bolt flange mounted Replaced by 70330004
Air Compressor (2W600R) 	70330004	LK4921 K000233	LK4921 K001268000	B6LE 3 bolt flange mounted Replaced by 70330094
Air Compressor (2W600R) 	70330094	LK4921 K001268	LK4921 K001268000	B6LE 3 bolt flange mounted
Governor Valve (D2) 	1193532	267100	1189394000	8.1 bar cut-out. Replaced by 3126287.
Governor Valve (D2) 	3126287	267014	1189395000	8.5 bar cut-out
Governor Valve (D2) 	3944255	1189394	1189394000	8.1 bar cut-out
Air Dryer 	6795914	Haldex 71239		Up to Chassis 5556
Air Dryer 	9957299 3194896	Haldex 87296	LA8226 II30180-B	8.5 bar cut-out
Air Dryer 	1629927 1628915	LA6710 II16149	LA6711 II36936000	From Chassis 5557. Note: LA6711-II36936000 has heater cable with Volvo connector. Replacement cartridge is 272897SP

NOTE: X00 and X50 suffixes refer to Exchange Products which may be Remanufactured.











B6 & B6LE

VOLVO

4 x 2











Bodied by Alexander (ALX200 and Dash), East Lancs/Darwen (EL2000, Flyte and Spryte), Marshall (C33), Northern Counties (Paladin), Plaxton (Pointer) and Wrightbus (Crusader)

Air Suspension

Description	Volvo Part Number	OE Part Number	Replacement Knorr-Bremse Part No	Remarks <small>Note: Left and Right refer to the side of the vehicle when viewed from the driver's seat facing forward.</small>
Four Circuit Protection Valve 	3124013	AE4427 II15587	AE4427 II15587000	
Charging Valve without Feedback 	1612448	0481063036000	DR4381 K000647	7.0 bar, M22 ports. Kneeling system. Replaced By 8159736
Charging Valve without Feedback 	8159736	0481063041000	DR4381 K000647	7.0 bar, M22 ports. Kneeling system
Single Check Valve 	1626982	Wabco 434 012 003 0	KW4455/1	M22 ports By Four Circuit Protection Valve
Single Check Valve 	1609497	KW4648/1	KW4648/1	M22 ports By Air Dryer Replaced by 1629727
Single Check Valve 	1629727		KW4455/1	M22 ports By Air Dryer
Hand Control Valve 	9515443	HB1143 I82171	HB1143 I82171N00	
Interlock Valve 	1580024	Wabco 434 205 026 0		"Broms" brake
Dual Foot Valve 	6779938	0481064108000	0481064108000	Up to gearbox 36
Dual Foot Valve 	3028742	Wabco 461 324 018 0		With 4HP500 Gearbox. Has pneumatic retarder control
Pneumatic Control Valve	1695943	Wabco 461 324 520 0		Attached to Foot Valve

Bodied by Alexander (ALX200 and Dash), East Lancs/Darwen (EL2000, Flyte and Spryte), Marshall (C33), Northern Counties (Paladin), Plaxton (Pointer) and Wrightbus (Crusader)

Air Suspension

Description	Volvo Part Number	OE Part Number	Replacement Knorr-Bremse Part No	Remarks Note: Left and Right refer to the side of the vehicle when viewed from the driver's seat facing forward.
Double Check Valve 	9522564	Wabco 434 208 035 0	295358	M16 ports, bracket mounted
Double Check Valve 	1505044	295358	295358	M16 ports, bracket mounted
Relay Valve 	1082666	0481026019000	0481026021000 or AC574AXY	AC574AXY has integral silencer
Relay Valve 	3173824	0481026032000	AC574AXY	AC574AXY has integral silencer
Quick Release Valve 	1581929	RE2108 I70676	RE2108 I70676	On front axle. Replaced by 3173152
Quick Release Valve 	1588769	KX2196/1	KX2196/1	On rear axle Replaced by 9518619
Quick Release Valve 	3173152	Wabco 973 500 047 0	KX1294/1	Up to Chassis 5994
Quick Release Valve 	9518619	Wabco 973 500 039 0	KX2000/1	From Chassis 5995
Pressure Reducing Valve 	3032760	Wabco 475 009 021 0	KX2045/14000 See Remarks	1.2 bar, M12 ports Set replacement valve to 1.2 bar
Pressure Sensor 	1594236			Volvo only Replaced by 3987498
Pressure Sensor 	3987498			Fitted on Foot Valve

NOTE: X00 and X50 suffixes refer to Exchange Products which may be Remanufactured.











B6 & B6LE

VOLVO

4 x 2







Air Suspension

Bodied by Alexander (ALX200 and Dash), East Lancs/Darwen (EL2000, Flyte and Spryte), Marshall (C33), Northern Counties (Paladin), Plaxton (Pointer) and Wrightbus (Crusader)

Description	Volvo Part Number	OE Part Number	Replacement Knorr-Bremse Part No	Remarks <small>Note: Left and Right refer to the side of the vehicle when viewed from the driver's seat facing forward.</small>
Pressure Relief (Safety) Valve 	3173104 8151922	Wabco 434 608 220 0	KX1729/2	10 bar, M16 thread. On End Of Purge Tank Replaced By 1633432.
Pressure Relief (Safety) Valve 	1622432	KX1729/5	KX1729/5	Up To Chassis 5556 13 bar, M16 thread Note: LA6710 and LA6711 Air Dryers have an Internal Pressure Relief Valve
Tilt Drain Valve 	1081328	VA12A	KW2350/2	M22 thread
Test Connector 	1592924	KW4282/2	KW4282/2	M16 thread
Exhaust Silencer 	8150114 1079552	0484210013000 0484210017000	SIL68ASP	For Air Dryer Snap-on Replaced by 20467891
Exhaust Silencer 	20467891	Wabco 432 407 018 0	SIL68ASP	For Air Dryer Snap-on Alternative Silencers: 0484210017000 or ZB3163-192999
Exhaust Silencer 	1196335	0484210002000	0484210002000	For QRV and Knorr-Bremse Foot Valve M16 thread
Exhaust Silencer 	6792310	0484210004000	0484210004000	For Knorr-Bremse Foot Valve To suit 14 mm hose
Exhaust Silencer 	3028744	Wabco 432 407 070 0	0484210005000	For Wabco Foot Valve Snap-on Replaced by 3943370
Exhaust Silencer 	3943370	0484210005000	0484210005000	For Wabco Foot Valve Snap-on
Exhaust Silencer 	1197476	0484210001000	SIL68B	For QRV M22 thread Alternative Silencers: 0484210001000 or ZB3150-178074

Bodied by Alexander (ALX200 and Dash), East Lancs/Darwen (EL2000, Flyte and Spryte), Marshall (C33), Northern Counties (Paladin), Plaxton (Pointer) and Wrightbus (Crusader)

Air Suspension

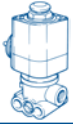
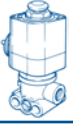
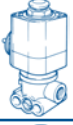
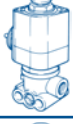
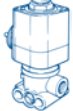
Description	Volvo Part Number	OE Part Number	Replacement Knorr-Bremse Part No	Remarks <small>Note: Left and Right refer to the side of the vehicle when viewed from the driver's seat facing forward.</small>
ABS Modulator 	1609241	Wabco 472 195 002 0		Up to Chassis 5971 M22 ports, Volvo electrical connector Replaced by 9520836
ABS Modulator 	9520836	Wabco 472 195 051 0		From Chassis 5972 M22 ports, Volvo electrical connector
Wheel Speed Sensor 	9955938	Wabco 441 032 093 0		B6 front and rear axles 90° sensor, cable length 1.54 m
ABS Electronic Control Unit (Type C2 - ABS & ASR) 	3944519	Wabco 446 004 054 0 446 004 064 0		B6 Replaced by 3943981
ABS Electronic Control Unit (Type C3 - ABS & ASR) 	3943981	Wabco 446 004 085 0		
Air Suspension Levelling Valve 	3036548	SV1412 I98292	SV1412 K000073	Standard air suspension system
Air Suspension Levelling Valve 	9518580	SV1399 II30525	SV1399 II30525	Air suspension system with ferry lift
Solenoid Valve 	1610570 1626100	Norgren-Herion 9042001374302400		For kneeling system Replaced by 8143021
Solenoid Valve 	8143021	Norgren-Herion 9042001374302400		For kneeling system and gearbox control
Solenoid Valve 	8158342	Norgren-Herion 9041005374302400		For diff lock and ride height control systems
Solenoid Valve 	8143019	Norgren-Herion 9041001374302400		For diff lock and exhaust pressure regulation control
Solenoid Valve 	3962640	Norgren-Herion 9042006374302400		For engine stop control

NOTE: X00 and X50 suffixes refer to Exchange Products which may be Remanufactured.



B6 & B6LE





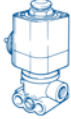

VOLVO

4 x 2

Air Suspension



Bodied by Alexander (ALX200 and Dash), East Lancs/Darwen (EL2000 and Spryte), Marshall (C33), Northern Counties (Paladin), Plaxton (Pointer) and Wrightbus (Crusader)

Description	Volvo Part Number	OE Part Number	Replacement Knorr-Bremse Part No	Remarks Note: Left and Right refer to the side of the vehicle when viewed from the driver's seat facing forward.
Solenoid Valve 	1662044			For gearbox control
Clutch Servo 	1655639	Kongsberg KA622080	626392AM	

Front Axle	Brake Chamber (Type 12) 	9517462	Wabco 423 070 110 0		Left side Diaphragm 234226K
	Brake Chamber (Type 12) 	9517463	Wabco 423 070 111 0		Right side Diaphragm 234226K
Rear Axle	Spring Brake (Type 12/16) 	9517465 9523476	Wabco 425 454 901 0	KZ1285/1X50	B6, left side Diaphragm 234226K
	Spring Brake (Type 12/16) 	9517464 9523475	Wabco 425 454 900 0	KZ1285/1X50	B6, right side Diaphragm 234226K
	Spring Brake (Type 17/16) 	3953958	Wabco 425 456 311 0		B6LE, left side
	Spring Brake (Type 17/16) 	3953957	Wabco 425 456 310 0		B6LE, right side

Bodied by Alexander (ALX400), Ayats (Bravo), East Lancs/Darwen (Myllenum and Nordic), Hispano (Habit), Northern Counties (Paladin), Plaxton (President) and Wrightbus (Eclipse and Streetcar)

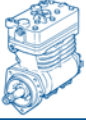
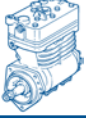
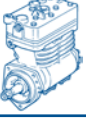
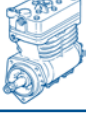
Air Suspension

Description	Volvo Part Number	OE Part Number	Replacement Knorr-Bremse Part No	Remarks <small>Note: Left and Right refer to the side of the vehicle when viewed from the driver's seat facing forward.</small>
Air Compressor (2W600R) 	3173001	LP4985 II37760	LP4985 K000229X00 or LP4992 K002031000 See Remarks	With sump drain boss. LP4992-K002031000 can be used when the no sump drain boss is required. Replaced by 70303442
Air Compressor (2W600R) 	70303442	LP4991 II38776F	LP4992 K002031000	Without sump drain boss. Replaced by 70305894
Air Compressor (2W600R) 	70305894	LP4992 II38777F	LP4992 K002031000	Without sump drain boss. Replaced by 70330006
Air Compressor (2W600R) 	70330006	LP4992 K000235	LP4992 K002031000	Without sump drain boss. Replaced by 70330098
Air Compressor (2W600R) 	70330098	LP4992 K002031	LP4992 K002031000	Without sump drain boss. Replaced by 20429343
Air Compressor (2W600R) 	20429343	LP4985 K000229	LP4985 K000229X00	Without sump drain boss.
Governor Valve (D2) 	3944251	272126	1189396000	12.0 bar cut-out With Wabco Air Dryer
Air Dryer (Single Cartridge) 	3194899	Haldex 87297	LA8286 II39752F00	Up to Chassis 1651 12.0 bar cut-out Replaced by 70313308
Air Dryer (Single Cartridge) 	3197854 20392573	Haldex 78990	LA8286 II39752F00	Up to Chassis 1764 12.0 bar cut-out Replaced by 70313308
Air Dryer (Single Cartridge) 	70313308	Haldex 89292 90548	LA8286 II39752F00	Up to Chassis 103362 12.5 bar cut-out
Air Dryer (Single Cartridge) 	70369130	Haldex 93097	LA8286 II39752F00	From Chassis 103363 12.5 bar cut-out
Air Dryer (Twin Cartridge) 	3035101	Wabco 432 431 274 0		

NOTE: X00 and X50 suffixes refer to Exchange Products which may be Remanufactured.













B7L & B7LA

4 x 2 & Artic

Air Suspension











VOLVO

Bodied by Alexander (ALX400), Ayats (Bravo), East Lancs/Darwen (Myllenum and Nordic), Hispano (Habit), Northern Counties (Paladin), Plaxton (President) and Wrightbus (Eclipse and Streetcar)

Description	Volvo Part Number	OE Part Number	Replacement Knorr-Bremse Part No	Remarks Note: Left and Right refer to the side of the vehicle when viewed from the driver's seat facing forward.
Condenser 	9519475	Haldex 92695		B7L
Condenser 	20518595	Haldex 92793		
Four Circuit Protection Valve 	3018549	AE4405 189408	AE4405 189408000	Up to Chassis 671 and 1454
Four Circuit Protection Valve 	3197585	AE4603 II36011	AE4603 II36011000	From Chassis 672 and 1455 Has "Safety Feature"
Four Circuit Protection Valve 	3197588	AE4604 II36012	AE4604 II36012000	With EBS Has "Safety Feature"
Charging Valve without Feedback 	8159736	0481063041000	DR4381 K000647	7.0 bar, M22 Ports. Air suspension system
Single Check Valve 	1626982		KW4455/1	M22 Ports In Four Circuit Protection Valve and supply to front Air Suspension Control Module
Single Check Valve 	1629727		KW4455/1	M22 Ports External charging circuit
Hand Control Valve 	9515443	HB1143 182171	HB1143 182171N00	
Interlock Valve 	1580024	Wabco 434 205 026 0		"Broms" brake
Dual Foot Valve 	9958670 70301712	Wabco 461 318 603 0		Up to Chassis 1696 Replaced by 70313310
Dual Foot Valve 	70313349	Wabco 461 318 608 0		Replaced by 70313310

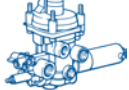
Bodied by Alexander (ALX400), Ayats (Bravo), East Lancs/Darwen (Myllenum and Nordic), Hispano (Habit), Northern Counties (Paladin), Plaxton (President) and Wrightbus (Eclipse and Streetcar)

Air Suspension

Description	Volvo Part Number	OE Part Number	Replacement Knorr-Bremse Part No	Remarks Note: Left and Right refer to the side of the vehicle when viewed from the driver's seat facing forward.
Dual Foot Valve 	70313310	Wabco 461 318 604 0		From Chassis 1697
Dual Foot Valve 	85101440	Wabco 461 315 073 0		Base Foot Valve for all of the above Foot Valves
EBS Dual Foot Valve 	70313353	K001974	K001974N00	For EBS 5
Double Check Valve 	9522564	Wabco 434 208 035 0	295358	M16 ports, bracket mounted
Relay Valve 	3173824	0481026032000	AC574AXY	AC574AXY has integral silencer
Quick Release Valve 	1588769	KX2196/1	KX2196/1	Supply port M22, delivery and exhaust ports M16 Replaced by 9518619
Quick Release Valve 	9518619	Wabco 973 500 039 0 973 500 044 0	KX2000/1	All ports M22
Load Sensing Valve (Air Suspension) 	9958760	Wabco 475 711 145 0		B7LA Artic, centre axle
Trailer Control Valve 	1589025	0481061020000	0481061020000	B7LA Artic
Pressure Limiting Valve 	1606720	0481009040000	0481009047000	7.5 bar, M22 ports
Pressure Limiting Valve 	70305736	0481009071000	0481009014000	2.0 bar, M22 ports Near rear axle, in door system Set replacement valve to 2.0 bar
Pressure Reducing Valve 	20399145	KX2045/16	KX2045/16000	7.5 bar, M12 ports In engine exhaust pressure regulation system

NOTE: X00 and X50 suffixes refer to Exchange Products which may be Remanufactured.













B7L & B7LA

4 x 2 & Artic

Air Suspension

VOLVO

Bodied by Alexander (ALX400), Ayats (Bravo), East Lancs/Darwen (Myllenium and Nordic), Hispano (Habit), Northern Counties (Paladin), Plaxton (President) and Wrightbus (Eclipse and Streetcar)

Description	Volvo Part Number	OE Part Number	Replacement Knorr-Bremse Part No	Remarks <small>Note: Left and Right refer to the side of the vehicle when viewed from the driver's seat facing forward.</small>
Stop Lamp Switch 	20382509			0.2 bar
Stop Lamp Switch 	20382505			0.3 bar
Stop Lamp Switch 	20382514			0.8 bar
Low Pressure Switch 	20382508			5.4 bar
Low Pressure Switch 	20382510			7.5 bar
Low Pressure Switch 	3195088			Boot is 1088453
Pressure Sensor 	815821			With EBS up to Chassis 103911
Pressure Sensor 	70351731			With EBS from Chassis 103912 up to Chassis 110797
Pressure Sensor 	70351745			With EBS from Chassis 110798
Pressure Sensor 	20428459			For pressure gauges
Pressure Sensor 	20528336			Replaced by 20829689
Pressure Sensor 	20829689			

Bodied by Alexander (ALX400), Ayats (Bravo), East Lancs/Darwen (Myllenum and Nordic), Hispano (Habit), Northern Counties (Paladin), Plaxton (President) and Wrightbus (Eclipse and Streetcar)

Air Suspension

Description	Volvo Part Number	OE Part Number	Replacement Knorr-Bremse Part No	Remarks Note: Left and Right refer to the side of the vehicle when viewed from the driver's seat facing forward.
Pressure Relief (Safety) Valve 	1622431	KX1729/2	KX1729/2	10 Bar, M16 thread Beside Pressure Limiting Valve
Pressure Relief (Safety) Valve 	1622432	KX1729/5	KX1729/5	13 Bar, M16 thread In distribution union by Four Circuit Protection Valve
Pressure Relief (Safety) Valve 	1607454			18 Bar, M16 thread In Ping Tank
Tilt Drain Valve 	1081328	Wabco 934 300 033 0	KW2350/2	M22 thread
Test Connector 	1592924	Wabco 463 703 120 0	KW4282/2	M16 thread
Exhaust Silencer 	3943370	0484210005000	SIL68ASP	For Foot Valve and Relay Valve Snap-on Alternative Silencers: 0484210017000 or ZB3163-192999
Exhaust Silencer 	1197476	Wabco 432 407 060 0	SIL68B	For QRV and Suspension Control Modules M22 thread Alternative Silencers: 0484210001000 or ZB3150-178074
ABS Modulator 	9520836	Wabco 472 195 051 0		M22 ports, Volvo electrical connector
ABS Modulator 	20516342	BR9191 II41119F	BR9154 II17776N00	M22 Voss ports, DIN 72585 bayonet electrical connector
Wheel Speed Sensor 	20528661	Wabco 441 032 957 0		Front axle, left side, up to Chassis 104821
Wheel Speed Sensor 	20554957	Wabco 441 032 979 0		Front axle, left side, from Chassis 104822
Wheel Speed Sensor 	20528660	Wabco 441 032 956 0		Front axle, right side, up to Chassis 104821

NOTE: X00 and X50 suffixes refer to Exchange Products which may be Remanufactured.













B7L & B7LA

4 x 2 & Artic

Air Suspension







VOLVO

Bodied by Alexander (ALX400), Ayats (Bravo), East Lancs/Darwen (Myllenium and Nordic), Hispano (Habit), Northern Counties (Paladin), Plaxton (President) and Wrightbus (Eclipse and Streetcar)

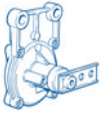
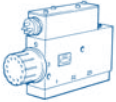
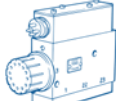
Description	Volvo Part Number	OE Part Number	Replacement Knorr-Bremse Part No	Remarks Note: Left and Right refer to the side of the vehicle when viewed from the driver's seat facing forward.
Wheel Speed Sensor 	20554956	Wabco 441 032 978 0		Front axle, right side, from Chassis 104822
Wheel Speed Sensor 	20528660	Wabco 441 032 956 0		Drive axle, left side
Wheel Speed Sensor 	20528661	Wabco 441 032 957 0		Drive axle, right side
ABS Electronic Control Unit (Type D, ABS only) 	3197782 3943980	Wabco 884 903 944 0 446 004 423 0		
ABS Electronic Control Unit (Type C2, ABS & ASR) 	8141342	Wabco 446 004 054 0		4 x 2, 4 channel system
ABS Electronic Control Unit (Type C2, ABS & ASR) 	8141345	Wabco 446 003 054 0		Artic, 6 channel system
EBS Axle Control Module (1 Channel) 	20570906	K000914	K000914N00	Front axle
EBS Axle Control Module (2 Channel) 	20570910	K001411	K000922N00	Rear axle
EBS Electronic Control Unit (EBS 2.3) 	3198461	0486106028000		Up to Chassis 103522 Replacement ECU must be programmed before use Volvo only
EBS Electronic Control Unit (EBS5) 	20540723 20555374 20589475	0486106063000		4 x 2 Replacement ECU must be programmed before use Volvo only
EBS Electronic Control Unit (EBS5) 	20537336 70377449 70377486	0486106068000		Artic Replacement ECU must be programmed before use Replaced by 20589476
EBS Electronic Control Unit (EBS5) 	20589476	0486106064000		Artic Replacement ECU must be programmed before use Volvo only

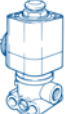
Bodied by Alexander (ALX400), Ayats (Bravo), East Lancs/Darwen (Myllenium and Nordic), Hispano (Habit), Northern Counties (Paladin), Plaxton (President) and Wrightbus (Eclipse and Streetcar)

Air Suspension

Description	Volvo Part Number	OE Part Number	Replacement Knorr-Bremse Part No	Remarks Note: Left and Right refer to the side of the vehicle when viewed from the driver's seat facing forward.
Air Suspension Level Sensor 	20514066	0504002107000	0504002112100	All axles
Air Suspension Control Module 	9957009	0501100035000	0501100041100	Front axle With kneeling function
Air Suspension Control Module 	3944717	0501100014000	0501100029000	4 x 2 rear axle Artic centre and rear axles
Air Suspension Electronic Control Unit 	3118073	0540004105000	0504004105000	B7L & B7LA from Chassis 203. Replacement ECU must be programmed before use
Solenoid Valve 	1078316	Norgren-Herion 9041025374602400		For door, steering adjustment and exhaust pressure regulator systems.
Solenoid Valve 	1078322			Artic, for jackknife warning system
Solenoid Valve 	1662044			For retarder control
Solenoid Valve 	9515215	Wabco 472 137 132 0		Traction control (ASR) Normally 'Closed', M12 ports, Volvo electrical connector
Door Operating Cock 	70344471			

NOTE: X00 and X50 suffixes refer to Exchange Products which may be Remanufactured.







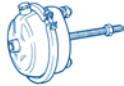
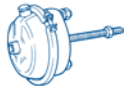

B7L & B7LA

4 x 2 & Artic

Air Suspension





VOLVO





Bodied by Alexander (ALX400), Ayats (Bravo), East Lancs/Darwen (Myllenum and Nordic), Hispano (Habit), Northern Counties (Paladin), Plaxton (President) and Wrightbus (Eclipse and Streetcar)

	Description	Volvo Part Number	OE Part Number	Replacement Knorr-Bremse Part No	Remarks <small>Note: Left and Right refer to the side of the vehicle when viewed from the driver's seat facing forward.</small>
Front Axle with Disc Brakes	Brake Chamber (Type 20HE) 	3112670	1186883-08	1186883-08	Independent suspension up to Chassis 780 On Meritor Disc Brake Diaphragm 20LS
	Brake Chamber (Type 24) 	70306611	Wabco 423 106 202 0	1186701-01	Independent suspension from Chassis 781 On Meritor Disc Brake Diaphragm 234100K
	Brake Chamber (Type 24) 	70330019	Wabco 423 506 120 0	<i>BS2504</i> K002556	Non-independent suspension On Meritor Disc Brake 15 mm push rod protrusion Diaphragm 234100K
Rear Axle with Drum Brakes	Spring Brake (Type 30/30) 	1608006	MGM 4130057 4131200	K2B1101X50	Up to Chassis 1434 With Drum Brakes M16 ports, 5/8" UNF push rod Diaphragm 234101K
	Spring Brake (Type 30/30HF) 	20499852	Wabco 925 492 103 0		From Chassis 1435 With Drum Brakes. M22 ports, M16 push rod. Replaced by 20827662 because of camshaft failures
	Spring Brake (Type 30/24) 	20827662	Wabco 925 492 201 0		With Drum Brakes M16 ports, 5/8" UNF push rod Diaphragm 234101K
Rear Axle - Disc Brakes	Spring Brake (Type 24/24) 	20535924	Wabco 925 461 154 0		With Meritor Disc Brakes 20 mm push rod protrusion, stroke 75 mm
Artic Centre Axle with Drum Brakes	Spring Brake (Type 30/30HF) 	20499852	Wabco 925 492 103 0		With Drum Brakes. M22 ports, M16 push rod. Diaphragm 234101K Replaced by 20827662 because of camshaft failures
	Spring Brake (Type 30/24) 	20827662	Wabco 925 492 201 0		With Drum Brakes M16 ports, 5/8" UNF push rod Diaphragm 234101K
Artic Centre Axle - Disc Brakes	Spring Brake (Type 24/24) 	20535924	Wabco 925 461 154 0		With Meritor Disc Brakes 20 mm push rod protrusion, stroke 75 mm

Bodied by Alexander (ALX400), Ayats (Bravo), East Lancs/Darwen (Myllenum and Nordic), Hispano (Habit), Northern Counties (Paladin), Plaxton (President) and Wrightbus (Eclipse and Streetcar)

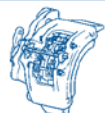
Air Suspension

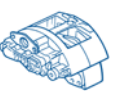
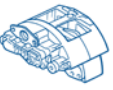
	Description		Volvo Part Number	OE Part Number	Replacement Knorr-Bremse Part No	Remarks Note: Left and Right refer to the side of the vehicle when viewed from the driver's seat facing forward.
Rear Axle	Automatic Slack Adjuster 		3193400	Haldex 79275	KB3910	Left side 50 mm offset, 165 mm hole centre
	Automatic Slack Adjuster 		3193401	Haldex 79276	KB3915	Right side 50 mm offset, 165 mm hole centre
Artic Centre Axle	Automatic Slack Adjuster 		3193402	Haldex 79713		Left side 45 mm offset, 145 mm hole centre
	Automatic Slack Adjuster 		3193403	Haldex 79714		Right side 45 mm offset, 145 mm hole centre

Front Axle	Air Disc Brake 		9957385 70301332 70306886 70311512 70330022	Meritor LRG592		Left side, Independent Suspension
	Air Disc Brake 		9957386 70301333 70306887 70311513 70330023	Meritor LRG593		Right side, Independent Suspension
	Disc Brake Pad Set 		8550611 3093919 85105485 20825594	Meritor MDP5061		Independent Suspension
	Air Disc Brake (Axial) 		20424072	Meritor		Left side, Non-independent Suspension
	Air Disc Brake (Axial) 		20424073	Meritor		Right side, Non-independent Suspension
	Disc Brake Pad Set 		20918891	Meritor MDP5057		Non-independent Suspension

NOTE: X00 and X50 suffixes refer to Exchange Products which may be Remanufactured.



B7L & B7LA





VOLVO

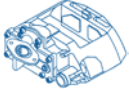
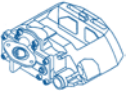







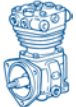

4 x 2 & Artic

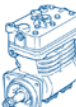
Air Suspension

Bodied by Alexander (ALX400), Ayats (Bravo), East Lancs/Darwen (Myllenium and Nordic), Hispano (Habit), Northern Counties (Paladin), Plaxton (President) and Wrightbus (Eclipse and Streetcar)

	Description		Volvo Part Number	OE Part Number	Replacement Knorr-Bremse Part No	Remarks Note: Left and Right refer to the side of the vehicle when viewed from the driver's seat facing forward.
Rear and Artic Centre Axles	Air Disc Brake (Radial) 		20535920	Meritor LRG669		Left side
	Air Disc Brake (Radial) 		20535921	Meritor LRG670		Right side
Rear and Artic Centre Axles	Disc Brake Pad Set 		85107768 20976509	Meritor MDP5099		

	Brake Disc 		3112965			Independent suspension
Front Axle	Brake Disc (Splined) 		3092710			Non-independent suspension Solid disc
	Brake Disc (Splined) 		85103803			Non-independent suspension Ventilated disc
Rear and Artic Centre Axles	Brake Disc 		20564467			

Description	Volvo Part Number	OE Part Number	Replacement Knorr-Bremse Part No	Remarks <small>Note: Left and Right refer to the side of the vehicle when viewed from the driver's seat facing forward.</small>
Air Compressor (1W213R) 	6795600	LK3813 I94314	LK3813 I94314000	Early vehicles 3 bolt flange mounted
Air Compressor (2W440R) 	1613632	LP4813 I90499	LP4813 I90499X50	Early vehicles 3 bolt flange mounted
Air Compressor (2W600R) 	70305892	LK4921 II39080F	LK4921 K001268000	3 bolt flange mounted Replaced by 70330004
Air Compressor (2W600R) 	70330004	LK4921 K000233	LK4921 K001268000	3 bolt flange mounted Replaced by 70330094
Air Compressor (2W600R) 	70330094	LK4921 K001268	LK4921 K001268000	3 bolt flange mounted
Air Compressor (2W704R) 	1626060	Wabco 911 505 150 0		3 bolt flange mounted
Air Dryer 	3194896 9957299 70313300	Haldex 87296	LA8226 II30180-B	B7R, 8.5 bar cut-out LA8226-II30180 has a heater which is not needed - leave disconnected
Air Dryer 	20733885	Haldex 92926	LA8226 II30180-B	B7RLE, 8.5 bar cut-out LA8226-II30180 has a heater which is not needed - leave disconnected
Air Dryer 	20392573	Haldex 78890	LA8286 II39752F00	B7RLE, 12.0 bar cut-out LA8286-II39752F has a heater which is not needed - leave disconnected. Replaced by 70313308
Air Dryer 	70313308	Haldex 89292 90548	LA8286 II39752F00	B7RLE, 12.0 bar cut-out LA8286-II39752F has a heater which is not needed - leave disconnected.
Air Dryer 	20409513 20416145	LA8271 II36256	LA8271 II39751F00	8.5 bar cut-out Replacement cartridge is 272897SP











B7R & B7RLE

4 x 2 & 6 x 2

Air Suspension

VOLVO

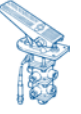
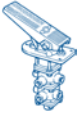





Bodied by Jonkheere (Modulo), Plaxton (Centro, Panther and Profile),
Sunsundegui (Sideral) and Wrightbus (Eclipse)

Description	Volvo Part Number	OE Part Number	Replacement Knorr-Bremse Part No	Remarks <small>Note: Left and Right refer to the side of the vehicle when viewed from the driver's seat facing forward.</small>
Four Circuit Protection Valve 	3197585	AE4603 II36011	AE4603 II36011000	8.5 bar system Has "Safety Feature"
Four Circuit Protection Valve 	3197588	AE4604 II36012	AE4604 II36012000	With EBS, 12.0 bar system Has "Safety Feature"
Single Check Valve 	1629982	Wabco 434 012 003 0	KW4455/1	M22 ports In Air Suspension circuit
Single Check Valve 	1629727		KW4455/1	M22 ports
Hand Control Valve 	9515443	HB1143 I82171	HB1143 I82171N00	
Interlock Valve 	1580024	Wabco 434 205 026 0		"Broms" brake
Dual Foot Valve 	3028741	Wabco 461 317 006 0		Without retarder control
Dual Foot Valve 	9519903	Wabco 461 318 023 0		With microswitch retarder control for Voith gearbox
Dual Foot Valve 	1698694	Wabco 461 315 479 0		Base valve for two Foot Valves above
Dual Foot Valve 	3028743	Wabco 461 318 005 0		With microswitch retarder control for Voith gearbox
Dual Foot Valve 	70301712	Wabco 461 318 603 0		With D7C engine Replaced by 70313310
Dual Foot Valve 	70313349	Wabco 461 318 608 0		With D7C engine Replaced by 70313310

Bodied by Jonkheere (Modulo), Plaxton (Centro, Panther and Profile),
Sunsundegui (Sideral) and Wrightbus (Eclipse)

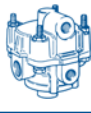
4 x 2 & 6 x 2

Air Suspension

Description	Volvo Part Number	OE Part Number	Replacement Knorr-Bremse Part No	Remarks <small>Note: Left and Right refer to the side of the vehicle when viewed from the driver's seat facing forward.</small>
Dual Foot Valve 	70313310	Wabco 461 318 604 0		With D7C engine
Dual Foot Valve 	3028742	Wabco 461 324 018 0		Left hand drive vehicles, with pneumatic retarder control for ZF HP500 gearbox
Dual Foot Valve 	3118798	Wabco 461 324 042 0		Right hand drive vehicles, with pneumatic retarder control for ZF HP500 gearbox
Dual Foot Valve 	1589620 6886123	Wabco 461 315 041 0		With pendant pedal
Dual Foot Valve 	8365045			With pendant pedal With Telma retarder
Dual Foot Valve 	8365406	Wabco 461 328 000 0		With pendant pedal With pneumatic control for ZF 4HP500 gearbox
EBS Dual Foot Valve 	70313353	K001974	K001974N00	For EBS 5
Double Check Valve 	9522564	Wabco 434 208 035 0	295358	M16 ports, bracket mounted
Relay Valve 	3173824	0481026032000	AC574AXY	AC574AXY has integral silencer
Quick Release Valve 	1588769	KX2196/1	KX2196/1	Supply port M22, delivery and exhaust ports M16 Replaced by 9518619
Quick Release Valve 	9518619	Wabco 973 500 039 0 973 500 044 0	KX2000/1	All ports M22
Pressure Limiting Valve 	70305736	0481009071000	0481009014000	2.0 bar, M22 ports Near rear axle, in door system Set replacement valve to 2.0 bar

NOTE: X00 and X50 suffixes refer to Exchange Products which may be Remanufactured.













B7R & B7RLE

4 x 2 & 6 x 2

Air Suspension

VOLVO

Bodied by Jonkheere (Modulo), Plaxton (Centro, Panther and Profile),
Sunsundegui (Sideral) and Wrightbus (Eclipse)

Description	Volvo Part Number	OE Part Number	Replacement Knorr-Bremse Part No	Remarks <small>Note: Left and Right refer to the side of the vehicle when viewed from the driver's seat facing forward.</small>
Stop Lamp Switch 	20382509			0.2 bar
Stop Lamp Switch 	20424053			Gearbox to neutral system
Stop Lamp Switch 	20382514			0.8 bar Gearbox to neutral system with multiplex wiring
Low Pressure Switch 	20382508			5.4 bar
Low Pressure Switch 	20382511			Air suspension system
Low Pressure Switch 	20424060			
Low Pressure Switch 	20382506			
Pressure Sensor 	20514065			
Pressure Sensor 	20528336			
Pressure Relief (Safety) Valve 	1622431	KX1729/2	KX1729/2	10 bar, M16 thread Near Four Circuit Protection Valve
Pressure Relief (Safety) Valve 	1622432	KX1729/5	KX1729/5	13 bar, M16 thread
Pressure Relief (Safety) Valve 	1607454			18 bar, M16 thread In Air Dryer or Ping Tank

Description	Volvo Part Number	OE Part Number	Replacement Knorr-Bremse Part No	Remarks Note: Left and Right refer to the side of the vehicle when viewed from the driver's seat facing forward.
Tilt Drain Valve 	1081328	Wabco 934 300 033 0	KW2350/2	M22 thread
Test Connector 	1592924	Wabco 463 703 120 0	KW4282/2	M16 thread
Test Connector 	1082480	KW3731/1	AC784D	M22 thread
Exhaust Silencer 	3943370	0484210005000	0484210005000	For Foot Valve and Relay Valve Snap-on
Exhaust Silencer 	1197476	Wabco 432 407 060 0	SIL68B	For QRV and Suspension Control Modules M22 thread Alternative Silencers: 0484210001000 or ZB3150-178074
ABS Modulator 	9520836	Wabco 472 195 051 0		M22 ports, Volvo electrical connector
ABS Modulator 	9959212	Wabco 472 195 058 0	BR9182 II38665F	M22 ports, DIN 72585 electrical connector With multiplex wiring
ABS Modulator 	20516342	BR9191 II41119F	BR9154 II17776N00	Front axle, with EBS. M22 Voss ports, DIN 72585 bayonet electrical connector
Wheel Speed Sensor 	20390737	Wabco 441 032 919 0		B7R front and rear axles, both sides. B7RLE rear axle, both sides. Straight sensor, cable length 1.7 m
Wheel Speed Sensor 	70351557	Wabco 441 032 110 0		B7RLE front axle, both sides. 90° sensor
Wheel Speed Sensor 	20528660	Wabco 441 032 956 0		Front and rear axles, left side. With multiplex wiring. Straight sensor
Wheel Speed Sensor 	20528661	Wabco 441 032 957 0		Front and rear axles, right side. With multiplex wiring. Straight sensor











B7R & B7RLE







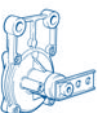
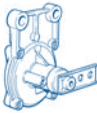

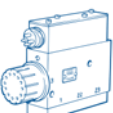
4 x 2 & 6 x 2

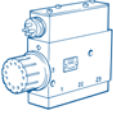
Air Suspension

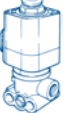
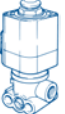
VOLVO

Bodied by Jonkheere (Modulo), Plaxton (Centro, Panther and Profile),
Sunsundegui (Sideral) and Wrightbus (Eclipse)

Description	Volvo Part Number	OE Part Number	Replacement Knorr-Bremse Part No	Remarks
ABS Electronic Control Unit (ABS + ASR) 	3197782	Wabco 446 004 423 0		
ABS Electronic Control Unit (Type D, ABS only) 	3198879	Wabco 446 004 305 0		Multiplex wiring generation 2
EBS Axle Control Module (1 Channel) 	20570906 20828237	K000914	K000914N00	Front axle
EBS Axle Control Module (2 Channel) 	20570910 20828241	K001411	K000922N00	Rear axle
EBS Electronic Control Unit (EBS5) 	20540723 20555374 20589475	0486106063000		4 x 2 Replacement ECU must be programmed before use Volvo only
EBS Electronic Control Unit (EBS5) 	20537336 70377449 70377486	0486106068000		6 x 2 Replacement ECU must be programmed before use Replaced by 20589476
EBS Electronic Control Unit (EBS5) 	20589476	0486106064000		6 x 2 Replacement ECU must be programmed before use Volvo only
Air Suspension Levelling Valve 	3036548	SV1412 I98292	SV1412 K000073	B7RLE, both axles
Air Suspension Level Sensor 	8144352 20514066	0504002107000	0504002112100	Both axles Replaced by 20850557
Air Suspension Level Sensor 	20850557	K013741		Both axles Volvo only
Air Suspension Control Module 	9957009	0501100035000	0501100041100	Front axle, independent suspension With kneeling function
Air Suspension Control Module 	3944716	0501100020000	0501100031000	Front axle, non-independent suspension

Description	Volvo Part Number	OE Part Number	Replacement Knorr-Bremse Part No	Remarks <small>Note: Left and Right refer to the side of the vehicle when viewed from the driver's seat facing forward.</small>
Air Suspension Control Module 	3944717	0501100014000	0501100029000	Rear axle
Air Suspension Electronic Control Unit 	3118073	0540004105000	0504004105000	Automatic ride height Replacement ECU must be programmed before use
Air Suspension Electronic Control Unit 	20503188 20569213			Replacement ECU must be programming before use
Solenoid Valve 	1078316	Norgren-Herion 9041025374602400		For door system.
Solenoid Valve 	8158342	Norgren-Herion 9041005374302400		For exhaust pressure regulation control system
Solenoid Valve 	9515215	Wabco 472 137 132 0		Traction control (ASR) Normally 'Closed', M12 ports, Volvo electrical connector
Auxiliary Charge Coupling 	3113946	K019270		Forster & Hales Part No. CX6
Clutch Servo 	1673067	Kongsberg KA622050	626392AM	
Clutch Servo 	1521371 1668501 1671953	Kongsberg KA626639	626639AM	With G8 gearbox
Clutch Master Cylinder 	1669488	FTE KG.28014.1.1		









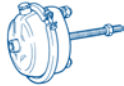
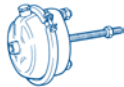
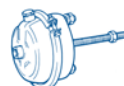

B7R & B7RLE



4 x 2 & 6 x 2

Air Suspension

VOLVO

Bodied by Jonkheere (Modulo), Plaxton (Centro, Panther and Profile),
Sunsundegui (Sideral) and Wrightbus (Eclipse)

	Description	Volvo Part Number	OE Part Number	Replacement Knorr-Bremse Part No	Remarks <small>Note: Left and Right refer to the side of the vehicle when viewed from the driver's seat facing forward.</small>
Front Axle with Drum Brakes	Brake Chamber (Type 30) 	3035900	MGM 1430202 1430223	1186702-01	Up to Chassis 5642 On Volvo 8" S-cam Brake Diaphragm 234101K
	Brake Chamber (Type 30) 	20504557	1186702-01	1186702-01	From Chassis 5643 On Volvo 8" S-cam Brake Diaphragm 234101K
	Brake Chamber (Type 24) 	9518358	MGM 1427202 1427218	1186701-01	4.8 m wheel base vehicles. On Volvo 8" S-cam Brake Diaphragm 234100K
Front Axle with Disc Brakes	Brake Chamber (Type 24) 	70306611	Wabco 423 106 202 0	1186701-01	B7RLE, on early Meritor Disc Brake Diaphragm 234100K
	Brake Chamber (Type 27) 	20512414	Wabco 423 509 020 0	BS3570 K002162	On Meritor Disc Brake 15 mm push rod protrusion
	Brake Chamber (Type 24) 	70330019	Wabco 423 506 120 0	BS2504 K002556	On Meritor Disc Brake, with EBS 15 mm push rod protrusion Diaphragm 234100K
Rear Axle with Drum Brakes	Spring Brake (Type 30/30) 	1608006	MGM 4130057 4131200	K2B1101X50	With mechanical suspension and Volvo S-cam Brakes M16 ports, 5/8" UNF push rod Diaphragm 234101K
	Spring Brake (Type 30/24) 	20827662	Wabco 925 492 201 0		With mechanical suspension and Volvo S-cam Brakes M16 ports, 5/8" UNF push rod Diaphragm 234101K
	Spring Brake (Type 24/24) 	1076326	Wabco 925 431 070 0	K2B0506X50	With air suspension and Volvo S-cam Brakes Diaphragm 234100K
	Spring Brake (Type 24/24) 	3159960 70330034	Wabco 925 431 090 0	K2B0506X50	With air suspension and Volvo S-cam Brakes, left side Diaphragm 234100K
	Spring Brake (Type 24/24) 	70330035	Wabco 925 431 091 0	K2B0506X50	With air suspension and Volvo S-cam Brakes, right side Diaphragm 234100K
Rear Axle - Disc Brakes	Spring Brake (Type 27/30) 	20512225	Wabco 925 489 101 0		Long wheelbase vehicles with ABS, left side. On Meritor Disc Brakes 15 mm push rod protrusion

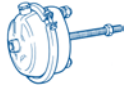
	Description	Volvo Part Number	OE Part Number	Replacement Knorr-Bremse Part No	Remarks <small>Note: Left and Right refer to the side of the vehicle when viewed from the driver's seat facing forward.</small>
Rear Axle with Disc Brakes (contd)	Spring Brake (Type 27/30) 	20524515	Wabco 925 489 100 0		Long wheelbase vehicles with ABS, right side. On Meritor Disc Brakes 15 mm push rod protrusion
	Spring Brake (Type 24/30) 	20527597	Wabco 925 481 103 0		Vehicles with EBS or short wheelbase vehicles with ABS, left side. On Meritor Disc Brakes 15 mm push rod protrusion
	Spring Brake (Type 24/30) 	20527614	Wabco 925 481 102 0		Vehicles with EBS or short wheelbase vehicles with ABS, right side. On Meritor Disc Brakes 15 mm push rod protrusion
Trailing Axle - Drum Brakes	Brake Chamber (Type 16) 	3028017	1185199	1185199	Diaphragm 234189K

Front Axle	Automatic Slack Adjuster 	1196322	Haldex 72167 72726	KB2295	152 mm hole centre
	Automatic Slack Adjuster 	1196321	Haldex 72166 72678	KB2275	140 mm hole centre
Rear Axle	Automatic Slack Adjuster 	1197965	Haldex 72784	KB3140	With mechanical suspension, left side 15 mm offset, 165 mm hole centre
	Automatic Slack Adjuster 	1197966	Haldex 72785	KB3135	With mechanical suspension, right side 15 mm offset, 165 mm hole centre
	Automatic Slack Adjuster 	3136246	Haldex 79641	KB4255	With air suspension, left side 28.5 mm offset, 185 mm hole centre
	Automatic Slack Adjuster 	3136247	Haldex 79642	KB4260	With air suspension, right side 28.5 mm offset, 185 mm hole centre
Trailing Axle	Automatic Slack Adjuster 	3177014	Haldex 79724		125 mm hole centre





B7R & B7RLE



VOLVO

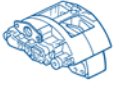

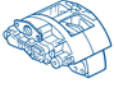

4 x 2 & 6 x 2

Bodied by Jonkheere (Modulo), Plaxton (Centro, Panther and Profile),
Sunsundegui (Sideral) and Wrightbus (Eclipse)

Air Suspension

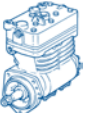
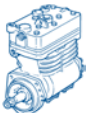
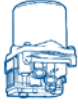
	Description		Volvo Part Number	OE Part Number	Replacement Knorr-Bremse Part No	Remarks <small>Note: Left and Right refer to the side of the vehicle when viewed from the driver's seat facing forward.</small>
Front and Rear Axles	Air Disc Brake		20424072	Meritor		Left side
	Air Disc Brake		20424073	Meritor		Right side
	Disc Brake Pad Set		20918891	Meritor MDP5057		
	Air Disc Brake		21024417	Meritor		Left side
	Air Disc Brake		21024419	Meritor		Right side
	Disc Brake Pad Set		21024702	Meritor		

Front Axle	Brake Disc		3112965			
Front and Rear Axles	Brake Disc (Splined)		3092710			Solid disc
	Brake Disc (Splined)		85103803			Ventilated disc

Description	Volvo Part Number	OE Part Number	Replacement Knorr-Bremse Part No	Remarks <small>Note: Left and Right refer to the side of the vehicle when viewed from the driver's seat facing forward.</small>
Air Compressor (2W600R) 	3173001	LP4985 II37760	LP4985 K000229X00 or LP4992 K002031000 See Remarks	With sump drain boss. LP4992-K002031000 can be used when the no sump drain boss is required. Replaced by 70303442
Air Compressor (2W600R) 	70303442	LP4991 II38776F	LP4992 K002031000	Without sump drain boss. Replaced by 70305894
Air Compressor (2W600R) 	70305894	LP4992 II38777F	LP4992 K002031000	Without sump drain boss. Replaced by 70330006
Air Compressor (2W600R) 	70330006	LP4992 K000235	LP4992 K002031000	Without sump drain boss. Replaced by 70330098
Air Compressor (2W600R) 	70330098	LP4992 K002031	LP4992 K002031000	Without sump drain boss. Replaced by 20429343
Air Compressor (2W600R) 	20429343	LP4985 K000229	LP4985 K000229X00	Without sump drain boss.
Air Dryer 	3194899	Haldex 87297	LA8286 II39752F00	Up to Chassis 1651 12.0 bar cut-out Replaced by 70313308
Air Dryer 	3197854 20392573	Haldex 78990	LA8286 II39752F00	12.0 bar cut-out Replaced by 70313308
Air Dryer 	70313308	Haldex 89292 90548	LA8286 II39752F00	Up to Chassis 103362 12.5 bar cut-out
Air Dryer 	70369130	Haldex 93097	LA8286 II39752F00	From Chassis 103363 12.5 bar cut-out
Condenser 	9519475	Haldex 92695		
Condenser 	20518595	Haldex 92793		

NOTE: X00 and X50 suffixes refer to Exchange Products which may be Remanufactured.









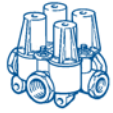

B7TL

4 x 2 double deck

Air Suspension

VOLVO

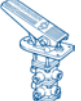
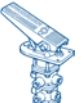
Bodied by Alexander (ALX400), East Lancs/Darwen (Vyking),
Plaxton (President) and Wrightbus (Eclipse)

Description	Volvo Part Number	OE Part Number	Replacement Knorr-Bremse Part No	Remarks <small>Note: Left and Right refer to the side of the vehicle when viewed from the driver's seat facing forward.</small>
Four Circuit Protection Valve 	3018549	AE4405 I89408	AE4405 I89408000	Up to Chassis 1454
Four Circuit Protection Valve 	3197585	AE4603 II36011	AE4603 II36011000	From Chassis 1455 Has "Safety Feature"
Four Circuit Protection Valve 	3197588	AE4604 II36012	AE4604 II36012000	With EBS Has "Safety Feature"
Charging Valve without Feedback 	8159736	0481063041000	DR4381 K000647	7.0 bar, M22 ports. Air suspension System
Single Check Valve 	1629727		KW4455/1	M22 ports External charging circuit
Hand Control Valve 	9515443	HB1143 I82171	HB1143 I82171N00	
Interlock Valve 	1580024	Wabco 434 205 026 0		"Broms" brake
Dual Foot Valve 	9958670 70301712	Wabco 461 318 603 0		Up to Chassis 1696 Replaced by 70313310
Dual Foot Valve 	70313349	Wabco 461 318 608 0		Replaced by 70313310
Dual Foot Valve 	70313310	Wabco 461 318 604 0		From Chassis 1697
Dual Foot Valve 	85101440	Wabco 461 315 073 0		Base Foot Valve for all of the above Foot Valves
EBS Dual Foot Valve 	70313353	K001974	K001974N00	For EBS 5

Description	Volvo Part Number	OE Part Number	Replacement Knorr-Bremse Part No	Remarks <small>Note: Left and Right refer to the side of the vehicle when viewed from the driver's seat facing forward.</small>
Double Check Valve 	9522564	Wabco 434 208 035 0	295358	M16 ports, bracket mounted
Relay Valve 	3173824	0481026032000	AC574AXY	AC574AXY has integral silencer
Quick Release Valve 	1588769	KX2196/1	KX2196/1	Supply port M22, delivery and exhaust ports M16 Replaced by 9518619
Quick Release Valve 	9518619	Wabco 973 500 039 0 973 500 044 0	KX2000/1	All ports M22
Pressure Limiting Valve 	1606720	0481009040000	0481009047000	7.5 bar, M22 ports
Pressure Limiting Valve 	70305736	0481009071000	0481009014000	2.0 bar, M22 ports Near rear axle, in door system Set replacement valve to 2.0 bar
Stop Lamp Switch 	20382509			0.2 bar
Stop Lamp Switch 	20382505			0.3 bar
Stop Lamp Switch 	20382514			0.8 bar
Low Pressure Switch 	20382508			5.4 bar
Low Pressure Switch 	20382510			7.5 bar
Low Pressure Switch 	3195088			Boot is Volvo Part No. 1088453











B7TL











4 x 2 double deck

Air Suspension

VOLVO

Bodied by Alexander (ALX400), East Lancs/Darwen (Vyking),
Plaxton (President) and Wrightbus (Eclipse)







Description	Volvo Part Number	OE Part Number	Replacement Knorr-Bremse Part No	Remarks
Pressure Sensor 	815821			With EBS up to Chassis 103911
Pressure Sensor 	70351731			With EBS from Chassis 103912 up to Chassis 110797
Pressure Sensor 	70351745			With EBS from Chassis 110798
Pressure Sensor 	20428459			For pressure gauges
Pressure Sensor 	20528336			Replaced by 20829689
Pressure Sensor 	20829689			
Pressure Relief (Safety) Valve 	1622431	KX1729/2	KX1729/2	10 bar, M16 thread Beside Pressure Limiting Valve
Pressure Relief (Safety) Valve 	1622432	KX1729/5	KX1729/5	13 bar, M16 thread In distribution union by Four Circuit Protection Valve
Tilt Drain Valve 	1081328	Wabco 934 300 033 0	KW2350/2	M22 thread
Test Connector 	1592924	Wabco 463 703 120 0	KW4282/2	M16 thread
Exhaust Silencer 	3943370	0484210005000	0484210005000	For Foot Valve and Relay Valve Snap-on
Exhaust Silencer 	1197476	Wabco 432 407 060 0	SIL68B	For QRV and Suspension Control Modules M22 thread Alternative Silencers: 0484210001000 or ZB3150-178074





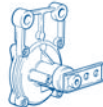
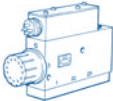
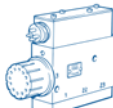

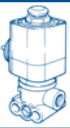
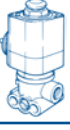

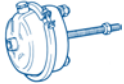
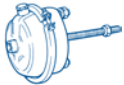

Description	Volvo Part Number	OE Part Number	Replacement Knorr-Bremse Part No	Remarks <small>Note: Left and Right refer to the side of the vehicle when viewed from the driver's seat facing forward.</small>
ABS Modulator 	9520836	Wabco 472 195 051 0		M22 ports, Volvo electrical connector
ABS Modulator 	20516342	BR9191 II41119F	BR9154 II17776N00	M22 Voss ports, DIN 72585 bayonet electrical connector
Wheel Speed Sensor 	20528661	Wabco 441 032 957 0		Front axle, left side, up to Chassis 104821
Wheel Speed Sensor 	20554957	Wabco 441 032 979 0		Front axle, left side, from Chassis 104822
Wheel Speed Sensor 	20528660	Wabco 441 032 956 0		Front axle, right side, up to Chassis 104821
Wheel Speed Sensor 	20554956	Wabco 441 032 978 0		Front axle, right side, from Chassis 104822
Wheel Speed Sensor 	20528660	Wabco 441 032 956 0		Drive axle, left side
Wheel Speed Sensor 	20528661	Wabco 441 032 957 0		Drive axle, right side
ABS Electronic Control Unit (ABS + ASR) 	3943980	Wabco 884 903 944 0		Up to Chassis 202
ABS Electronic Control Unit (ABS + ASR) 	3197782	Wabco 446 004 423 0		From Chassis 203
ABS Electronic Control Unit (Type C2, ABS + ASR) 	8141342	Wabco 446 004 054 0		4 x 2, 4 channel system

4 x 2 double deck

Bodied by Alexander (ALX400), East Lancs/Darwen (Vyking),
Plaxton (President) and Wrightbus (Eclipse)

Air Suspension

Description	Volvo Part Number	OE Part Number	Replacement Knorr-Bremse Part No	Remarks <small>Note: Left and Right refer to the side of the vehicle when viewed from the driver's seat facing forward.</small>
EBS Axle Control Module (1 Channel) 	20570906	K000914	K000914N00	Front axle
EBS Axle Control Module (2 Channel) 	20570910	K001411	K000922N00	Rear axle
EBS Electronic Control Unit (EBS 5) 	20589475	0486106063000		From Chassis 103511 Replacement ECU must be programmed before use Volvo only
Air Suspension Level Sensor 	20514066	0504002107000	0504002112100	Both axles
Air Suspension Control Module 	9957009	0501100035000	0501100041100	Front axle With kneeling function
Air Suspension Control Module 	3944717	0501100014000	0501100029000	Rear axle
Air Suspension Electronic Control Unit 	3118073	0540004105000	0504004105000	Replacement ECU must be programmed before use
Solenoid Valve 	1078316	Norgren-Herion 9041025374602400		For door, steering adjustment and exhaust pressure regulator systems.
Solenoid Valve 	1662044			For retarder control
Solenoid Valve 	9515215	Wabco 472 137 132 0		Traction control (ASR) Normally 'Closed', M12 ports, Volvo electrical connector
Auxiliary Charge Coupling 	3113946	K019270		Forster & Hales Part No. CX6

	Description	Volvo Part Number	OE Part Number	Replacement Knorr-Bremse Part No	Remarks <small>Note: Left and Right refer to the side of the vehicle when viewed from the driver's seat facing forward.</small>
Front Axle with Disc Brakes	Brake Chamber (Type 20HE) 	3112670	1186883-08	1186883-08	Independent suspension up to Chassis 1619 On Meritor Disc Brake Diaphragm 20LS
	Brake Chamber (Type 24) 	70306611	Wabco 423 106 202 0	1186701-01	Independent suspension from Chassis 1620 On Meritor Disc Brake Diaphragm 234100K
	Brake Chamber (Type 24) 	70330019	Wabco 423 506 120 0	BS2504 K002556	Non-independent suspension On Meritor Disc Brake 15 mm Push Rod protrusion Diaphragm 234100K
Rear Axle with Drum Brakes	Spring Brake (Type 30/30) 	1608006	MGM 4130057 4131200	K2B1101X50	Up to Chassis 2478 With Drum Brakes M16 ports, 5/8" UNF push rod Diaphragm 234101K
	Spring Brake (Type 30/30HF) 	20499852	Wabco 925 492 103 0		From Chassis 2479 With Drum Brakes. M22 ports, M16 push rod. Replaced by 20827662 because of camshaft failures
	Spring Brake (Type 30/24) 	20827662	Wabco 925 492 201 0		With Drum Brakes M16 ports, 5/8" UNF push rod Diaphragm 234101K
Rear Axle - Disc Brakes	Spring Brake (Type 24/24) 	20535924	Wabco 925 461 154 0		With Meritor Disc Brakes 20 mm Push Rod protrusion, stroke 75 mm
Front Axle	Automatic Slack Adjuster 	3193400	Haldex 79275	KB3910	Left side 50 mm offset, 165 mm hole centre
	Automatic Slack Adjuster 	3193401	Haldex 79276	KB3915	Right side 50 mm offset, 165 mm hole centre
Rear Axle	Automatic Slack Adjuster 	3193400	Haldex 79275	KB3910	Left side 50 mm offset, 165 mm hole centre
	Automatic Slack Adjuster 	3193401	Haldex 79276	KB3915	Right side 50 mm offset, 165 mm hole centre

NOTE: X00 and X50 suffixes refer to Exchange Products which may be Remanufactured.











B7TL

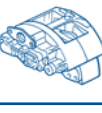





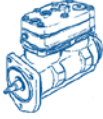

4 x 2 double deck

Air Suspension

VOLVO

Bodied by Alexander (ALX400), East Lancs/Darwen (Vyking),
Plaxton (President) and Wrightbus (Eclipse)

	Description	Volvo Part Number	OE Part Number	Replacement Knorr-Bremse Part No	Remarks <small>Note: Left and Right refer to the side of the vehicle when viewed from the driver's seat facing forward.</small>
Front Axle	Air Disc Brake 	70301332 70306886 70311512 70330022	Meritor LRG592		Left side, Independent Suspension
	Air Disc Brake 	70301333 70306887 70311513 70330023	Meritor LRG593		Right side, Independent Suspension
	Disc Brake Pad Set 	8550611 3093919 20825594	Meritor MDP5061		Independent Suspension
	Air Disc Brake (Axial) 	20424072	Meritor		Left side, Non-independent Suspension
	Air Disc Brake (Axial) 	20424073	Meritor		Right side, Non-independent Suspension
	Disc Brake Pad Set 	20918891	Meritor MDP5057		Non-independent Suspension
Rear Axle	Air Disc Brake (Radial) 	20535920	Meritor LRG669		Left side
	Air Disc Brake (Radial) 	20535921	Meritor LRG670		Right side
	Disc Brake Pad Set 	85107768 20976509	Meritor MDP5099		
Front Axle	Brake Disc 				Non-independent suspension
	Brake Disc 	3112965			Independent suspension
Rear Axle	Brake Disc 	20564467			

Description	Volvo Part Number	OE Part Number	Replacement Knorr-Bremse Part No	Remarks <small>Note: Left and Right refer to the side of the vehicle when viewed from the driver's seat facing forward.</small>
Air Compressor (2W704R) 	20866605	Wabco 412 704 016 0		3 bolt flange mounted
Air Dryer 	70369130	Haldex 93097	<i>LA8286</i> II39752F00	
Condenser 	20745320	Haldex 92939		
Four Circuit Protection Valve 	3197588	<i>AE4604</i> II36012	<i>AE4604</i> II36012000	Has "Safety Feature"
Charging Valve without Feedback 	8159736	0481063041000	<i>DR4381</i> K000647	7.0 bar, M22 ports
Single Check Valve 	1629982	Wabco 434 012 003 0	KW4455/1	M22 ports
Hand Control Valve 	9515443	<i>HB1143</i> I82171	<i>HB1143</i> I82171N00	
Interlock Valve 	1580024	Wabco 434 205 026 0		"Broms" brake
EBS Dual Foot Valve 	70313353	K001974	K001974N00	
Double Check Valve 	9522564	Wabco 434 208 035 0	295358	M16 ports, bracket mounted
Relay Valve 	3173824	0481026032000	AC574AXY	AC574AXY has integral silencer
Trailer Control Valve 	1589025	0481061020000	0481061020000	B9LA Artic

NOTE: X00 and X50 suffixes refer to Exchange Products which may be Remanufactured.











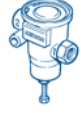

B9L & B9LA









4 x 2 & Artic

Air Suspension

VOLVO

Bodied by East Lancs/Darwen (Nordic) and Wrightbus (Streetcar)

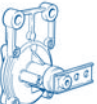
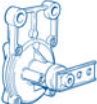
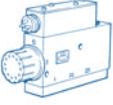
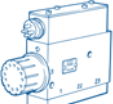
Description	Volvo Part Number	OE Part Number	Replacement Knorr-Bremse Part No	Remarks Note: Left and Right refer to the side of the vehicle when viewed from the driver's seat facing forward.
Pressure Limiting Valve 	1606720	0481009040000	0481009047000	7.5 bar, M22 ports
Low Pressure Switch 	20424056			
Pressure Sensor 	70351731			In manifold block attached to Four Circuit Protection Valve
Pressure Relief (Safety) Valve 	1622431	KX1729/2	KX1729/2	10 bar, M16 thread
Pressure Relief (Safety) Valve 	1622432	KX1729/5	KX1729/5	13 bar, M16 thread
Tilt Drain Valve 	1081328	Wabco 934 300 033 0	KW2350/2	M22 thread
Test Connector 	1592924	Wabco 463 703 120 0	KW4282/2	M16 thread
Test Connector 	1082480	KW3731/1	AC784D	M22 thread
Exhaust Silencer 	3943370	0484210005000	0484210005000	For Relay Valve Snap-on
Exhaust Silencer 	1197476	Wabco 432 407 060 0	SIL68B	For Suspension Control Modules M22 thread Alternative Silencers: 0484210001000 or ZB3150-178074
Exhaust Silencer 	20467891	Wabco 432 407 018 0	SIL68ASP	For Air Dryer Snap-on Alternative Silencers: 0484210017000 or ZB3163-192999
ABS Modulator 	20516342	BR9191 II41119F	BR9154 II17776N00	Front axle, with EBS. M22 Voss ports, DIN 72585 bayonet electrical connector

Description	Volvo Part Number	OE Part Number	Replacement Knorr-Bremse Part No	Remarks <small>Note: Left and Right refer to the side of the vehicle when viewed from the driver's seat facing forward.</small>
Wheel Speed Sensor 				
Wheel Speed Sensor 				
EBS Axle Control Module (1 Channel) 	20570906 20828237	K000914	K000914N00	Front axle and Artic trailing axle
EBS Axle Control Module (2 Channel) 	20570910 20828241	K001411	K000922N00	Rear axle
EBS Electronic Control Unit (EBS5) 	20540723 20555374 20589475	0486106063000		4 x 2 Replacement ECU must be programmed before use Volvo only
EBS Electronic Control Unit (EBS5) 	20537336 70377449 70377486	0486106068000		Artic Replacement ECU must be programmed before use Replaced by 20589476
EBS Electronic Control Unit (EBS5) 	20589476	0486106064000		Artic Replacement ECU must be programmed before use Volvo only
Air Suspension Level Sensor 	20514066	0504002107000	0504002112100	Both axles Replaced by 20850557
Air Suspension Level Sensor 	20850557	K013741		Both axles Volvo only
Air Suspension Control Module 	9957009	0501100035000	0501100041100	Front axle With kneeling function
Air Suspension Control Module 	3944717	0501100014000	0501100029000	Rear and B9LA Artic trailing axle
Air Suspension Electronic Control Unit 	20569213			Replacement ECU must be programmed before use



B9L & B9LA





4 x 2 & Artic



Air Suspension

VOLVO

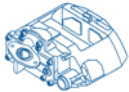
Bodied by East Lancs/Darwen (Nordic) and Wrightbus (Streetcar)







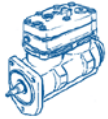
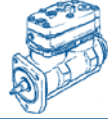
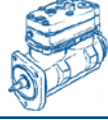

	Description		Volvo Part Number	OE Part Number	Replacement Knorr-Bremse Part No	Remarks Note: Left and Right refer to the side of the vehicle when viewed from the driver's seat facing forward.
Front Axle	Brake Chamber (Type 24)		70330019	Wabco 423 506 120 0	<i>BS2504</i> K002556	Long wheelbase vehicles On Meritor Disc Brake 15 mm Push Rod protrusion Diaphragm 234100K
	Brake Chamber (Type 27)		20512414	Wabco 423 509 020 0	<i>BS3570</i> K002162	Short wheelbase vehicles On Meritor Disc Brake 15 mm Push Rod protrusion
Rear & Artic Trailing Axles	Spring Brake (Type 24/24)		20535924	Wabco 925 461 154 0		On Meritor Disc Brakes 20 mm Push Rod protrusion, stroke 75 mm

Front Axle	Air Disc Brake (Axial)		20424072	Meritor		Left side
	Air Disc Brake (Axial)		20424073	Meritor		Right side
	Disc Brake Pad Set		20918891	Meritor MDP5057		
Rear & Artic Trailing Axles	Air Disc Brake (Radial)		20535921	Meritor LRG670		Left side
	Air Disc Brake (Radial)		20535920	Meritor LRG669		Right side
	Disc Brake Pad Set		20976509	Meritor MDP5099		

Description	Volvo Part Number	OE Part Number	Replacement Knorr-Bremse Part No	Remarks <small>Note: Left and Right refer to the side of the vehicle when viewed from the driver's seat facing forward.</small>
Brake Disc 	3092710			Solid disc
Brake Disc 	85103803			Ventilated disc
Artic Trailing Axle Brake Disc 	20564467			

Genuine Knorr-Bremse parts
- engineered for long life

**Keep your buses on the
run not on the sick
- fit genuine
Knorr-Bremse parts**

Description	Volvo Part Number	OE Part Number	Replacement Knorr-Bremse Part No	Remarks <small>Note: Left and Right refer to the side of the vehicle when viewed from the driver's seat facing forward.</small>
Air Compressor (2W704R) 	20574763	Wabco 412 704 007 0		Replaced by 20775224
Air Compressor (2W704R) 	20775224	Wabco 412 704 013 0		
Air Compressor (2W704R) 	20866605	Wabco 412 704 016 0		
Air Dryer 	70313308	Haldex 89292 90548	LA8286 II39752F00	12.0 bar cut-out
Air Dryer 	70369130	Haldex 93097	LA8286 II39752F00	12.0 bar cut-out
Condenser 	20518595	Haldex 92793		
Four Circuit Protection Valve 	3197585	AE4603 II36011	AE4603 II36011000	Has "Safety Feature"
Charging Valve without Feedback 	8159736	0481063041000	DR4381 K000647	7.0 bar, M22 ports
Charging Valve with Feedback 	3181898	Wabco 434 100 047 0	0481063037000	10.3 bar, M22 ports
Single Check Valve 	1626982	Wabco 434 012 003 0	KW4455/1	M22 ports In parking brake circuit
Single Check Valve 	1571924	Wabco 434 023 000 0	KW4648/1	M22 ports In Air Dryer











B9TL

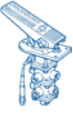

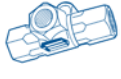
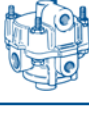









4 x 2 double deck

Air Suspension













VOLVO







Bodied by Alexander Dennis (Enviro 400), East Lancs/Darwen (Nordic, Olympus, Visionaire and Vyking) and Wrightbus (Eclipse)

Description	Volvo Part Number	OE Part Number	Replacement Knorr-Bremse Part No	Remarks Note: Left and Right refer to the side of the vehicle when viewed from the driver's seat facing forward.
Hand Control Valve 	9515443	HB1143 182171	HB1143 182171N00	
Interlock Valve 	1580024	Wabco 434 205 026 0		"Broms" brake
Dual Foot Valve 	70313310	Wabco 461 318 604 0		With potentiometer retarder control
Dual Foot Valve 	1698694	Wabco 461 315 479 0		Base Foot Valve for 70313310
EBS Dual Foot Valve 	70313353	K001974	K001974N00	
Double Check Valve 	9522564	Wabco 434 208 035 0	295358	M16 ports, bracket mounted
Relay Valve 	3173824	0481026032000	AC574AXY	AC574AXY has integral silencer
Quick Release Valve 	9518619	Wabco 973 500 039 0 973 500 044 0	KX2000/1	
Supply Dump Valve 	1585345	SDM2GA	SDM2GA	
Pressure Limiting Valve 	1606720	0481009040000	0481009047000	7.5 bar, M22 ports In auxiliaries circuit
Pressure Limiting Valve 	20539505			M22 ports In air suspension circuit
Pressure Limiting Valve 	70305736	0481009071000	0481009014000	2.0 bar, M22 ports In door brake circuit Reset 0481009014000 to 2.0 bar

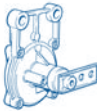
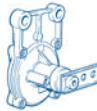
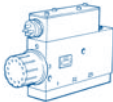
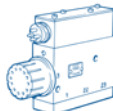
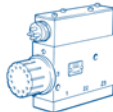
Description	Volvo Part Number	OE Part Number	Replacement Knorr-Bremse Part No	Remarks Note: Left and Right refer to the side of the vehicle when viewed from the driver's seat facing forward.
Pressure Switch 	20382506			2.0 bar
Stop Lamp Switch 	20382509			0.2 bar
Stop Lamp Switch 	20382514			0.8 bar
Low Pressure Switch 	20382511			5.6 bar
Low Pressure Switch 	20424061			Front axle air suspension
Low Pressure Switch 	20382508			5.4 bar
Pressure Sensor 	70351731			
Pressure Relief (Safety) Valve 	1622431	KX1729/2	KX1729/2	10 bar, M16 thread Near Four Circuit Protection Valve
Pressure Relief (Safety) Valve 	1622432	KX1729/5	KX1729/5	13 bar, M16 thread
Tilt Drain Valve 	1081328	Wabco 934 300 033 0	KW2350/2	M22 thread
Test Connector 	1592924	Wabco 463 703 120 0	KW4282/2	M16 thread
Test Connector 	1082480	KW3731/1	AC784D	M22 thread

NOTE: X00 and X50 suffixes refer to Exchange Products which may be Remanufactured.

Description	Volvo Part Number	OE Part Number	Replacement Knorr-Bremse Part No	Remarks
Exhaust Silencer 	3943370	0484210005000	0484210005000	For Foot Valve and Relay Valve Snap-on
Exhaust Silencer 	1197476	Wabco 432 407 060 0	0484210001000	For Suspension Control Modules M22 thread Alternative Silencers: 0484210001000 or ZB3150-178074
Exhaust Silencer 	1079552 20467891	Wabco 432 407 018 0	0484210017000	For Air Dryer Snap-on Alternative Silencers: 0484210017000 or ZB3163-192999
ABS Modulator 	9959212	Wabco 472 195 058 0	BR9182 II38665F	All axles with ABS only. M22 ports, DIN 72585 bayonet electrical connector
ABS Modulator 	20516342	BR9191 II41119F	BR9154 II17776N00	Front axle, with EBS. M22 Voss ports, DIN 72585 bayonet electrical connector
Wheel Speed Sensor 	70351557	Wabco 441 032 110 0		Front axle, both sides. 90° sensor
Wheel Speed Sensor 	9958574	0486000107000		Drive axle, both sides. 90° sensor, cable length 1.0 m Volvo only
Wheel Speed Sensor 	20390735	Wabco 441 032 884 0		Trailing axle, both sides. 90° sensor, cable length 1.7 m Replaced by 20566832
Wheel Speed Sensor 	20566832	Wabco 441 032 976 2		Trailing axle 90° sensor, cable length 1.7 m
ABS Electronic Control Unit (Type D, ABS only) 	3195235	Wabco 446 003 420 0		
EBS Axle Control Module (1 Channel) 	20828237	K000914	K000914N00	Front axle
EBS Axle Control Module (2 Channel) 	20570910 20828241	K001411	K000922N00	Rear axle

Description	Volvo Part Number	OE Part Number	Replacement Knorr-Bremse Part No	Remarks Note: Left and Right refer to the side of the vehicle when viewed from the driver's seat facing forward.
EBS Electronic Control Unit (EBS5) 	20589475	0486106063000		Replacement ECU must be programmed before use Volvo only
Air Suspension Level Sensor 	8144352 20514066	0504002107000	0504002112100	Both axles Replaced by 20850557
Air Suspension Level Sensor 	20850557	K013741		Both axles Volvo only
Air Suspension Control Module 	9957009	0501100035000	0501100041100	Front axle With kneeling function
Air Suspension Control Module 	3944717	0501100014000	0501100029000	Drive axle
Air Suspension Control Module 	9955466	0501100037000		Trailing axle Volvo only
Air Suspension Electronic Control Unit 	3118073	0504004105000	0504004105000	Replacement ECU must be programmed before use
Solenoid Valve 	1078316	Norgren-Herion 9041025374602400		For door system
Solenoid Valve 	9515215	Wabco 472 137 132 0		Traction control (ASR) Normally 'Closed', M12 ports, Volvo electrical connector
Auxiliary Charge Coupling 	3113946	K019270		Forster & Hales Part No. CX6
Exhaust Brake Control Valve 	20451967 20561888			





B9TL







4 x 2 double deck









Air Suspension

VOLVO

Bodied by Alexander Dennis (Enviro 400), East Lancs/Darwen (Nordic, Olympus, Visionaire and Vyking) and Wrightbus (Eclipse)

	Description	Volvo Part Number	OE Part Number	Replacement Knorr-Bremse Part No	Remarks Note: Left and Right refer to the side of the vehicle when viewed from the driver's seat facing forward.
Front Axle with Disc Brakes	Brake Chamber (Type 24) 	70306611	Wabco 423 106 202 0	1186701-01	Vehicles with ABS only. On early Meritor Disc Brake. Diaphragm 234100K
	Brake Chamber (Type 24) 	70330019	Wabco 423 506 120 0	BS2504 K002556	Vehicles with EBS. On Meritor Disc Brake 15 mm Push Rod protrusion Remove Breather Plugs from K002556
Rear Axle with Drum Brakes	Spring Brake (Type 24/24) 	70330086	Wabco 925 501 097 0	K2B0506X50 + Yoke 1185157	On S-cam Brakes M16 ports, 5/8" UNF Push Rod, 64 mm stroke Diaphragm 234100K
Trailing Axle with Drum Brakes	Spring Brake (Type 20/24) 	70330088	Wabco 925 500 160 0	K2B0504X50 + Yoke 1185157	On S-cam Brakes M16 ports, 5/8" UNF Push Rod, 64 mm stroke Diaphragm 234099K







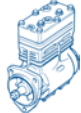
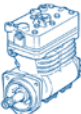
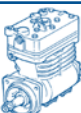
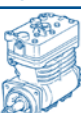

Front Axle	Air Disc Brake 	70330022	Meritor LRG592		Left side Early Meritor Disc Brake
	Air Disc Brake 	70330023	Meritor LRG593		Right side Early Meritor Disc Brake
	Disc Brake Pad Set 	3093919 85105485 20825594	Meritor MDP5061		
	Air Disc Brake 	20424072	Meritor		Vehicles with EBS, left side Later Meritor Disc Brake
	Air Disc Brake 	20424073	Meritor		Vehicles with EBS, right side Later Meritor Disc Brake
	Disc Brake Pad Set 	20918891	Meritor MDP5057		

	Description	Volvo Part Number	OE Part Number	Replacement Knorr-Bremse Part No	Remarks <small>Note: Left and Right refer to the side of the vehicle when viewed from the driver's seat facing forward.</small>
Front Axle (contd)	Air Disc Brake 	21024417	Meritor		Vehicles with EBS, left side Later Meritor Disc Brake
	Air Disc Brake 	21024419	Meritor		Vehicles with EBS, right side Later Meritor Disc Brake
	Disc Brake Pad Set 	21024702	Meritor		
	Brake Disc 	3112965			
	Brake Disc (Splined) 	3092710			Solid disc
	Brake Disc (Splined) 	85103803			Ventilated disc
Rear Axle	Automatic Slack Adjuster 	3193400	Haldex 79275	KB3910	Left side 50 mm offset, 165 mm hole centre
	Automatic Slack Adjuster 	3193401	Haldex 79276	KB3915	Right side 50 mm offset, 165 mm hole centre
Trailing Axle	Automatic Slack Adjuster 	1196321	Haldex 72166 72678	KB2275	140 mm hole centre

**Knorr Bremse
genuine parts,
the wisest choice
in the long run**

Bodied by Alexander (ALX300 and Strider), Northern Counties (Paladin), Plaxton (Prestige and Verde) and Wrightbus (Endurance, Liberator and Renown)

Mechanical & Air Suspension

Description	Volvo Part Number	OE Part Number	Replacement Knorr-Bremse Part No	Remarks <small>Note: Left and Right refer to the side of the vehicle when viewed from the driver's seat facing forward.</small>
Air Compressor (2W440R) 	1613632	LP4813 I90499	LP4813 I90499X50	Up to Chassis 123 3 bolt flange mounted
Air Compressor (2W600R) 	3037346	LP4934 II30895	LP4934 II30895X00	Up to Chassis 123 3 bolt flange mounted with ESS
Air Compressor (2W600R) 	9521675	LP4967 II33164	LP4967 II33164X00	From Chassis 124 3 bolt flange mounted with ESS Replaced by 3193734
Air Compressor (2W600R) 	3193734	LP4986 II37953	LK4918 K001267X00	3 bolt flange mounted Replaced by 70303443
Air Compressor (2W600R) 	70303443	LP4993 II38779F	LK4918 K001267X00	3 bolt flange mounted Replaced by 70305889
Air Compressor (2W600R) 	70305889	LK4918 II39077F	LK4918 K001267X00	3 bolt flange mounted Replaced by 70330001
Air Compressor (2W600R) 	70330001	LK4918 K000230	LK4918 K001267X00	3 bolt flange mounted Replaced by 70330081
Air Compressor (2W600R) 	70330081	LK4918 K001267	LK4918 K001267X00	3 bolt flange mounted
Governor Valve (D2) 	3944251 1607889	272126	1189396000	12.0 bar cut-out With kneeling system
Governor Valve (D2) 	6776870	267101	1189489000	10.0 bar cut-out Without kneeling system Replaced by 3944254
Governor Valve (D2) 	3944254	1189489	1189489000	10.0 bar cut-out Without kneeling system
Sychro Valve (SV1) 	1076379	5000824	5000824	Used with Compressors with ESS

NOTE: X00 and X50 suffixes refer to Exchange Products which may be Remanufactured.









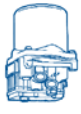

B10B & B10BLE

VOLVO

4 x 2











Mechanical & Air Suspension

Bodied by Alexander (ALX300 and Strider), Northern Counties (Paladin), Plaxton (Prestige and Verde) and Wrightbus (Endurance, Liberator and Renown)

Description	Volvo Part Number	OE Part Number	Replacement Knorr-Bremse Part No	Remarks
Air Dryer (AD2)	 1190405	267113	267121X50	
Air Dryer (Single Cartridge)	 9517283 9957313 3194899	Haldex 87297	LA8286 II39752F00	12.0 bar cut-out Replaced by 71313308
Air Dryer (Single Cartridge)	 70313308	Haldex 89292	LA8286 II39752F00	12.0 bar cut-out
Air Dryer (Twin Cartridge)	 3035101	Wabco 432 431 274 0		B10BLE Cartridge is 272897SP
Condenser	 9519475 20518595	Haldex 92695 92793		Replaced by 20745320
Condenser	 20745320	Haldex 92939		
Four Circuit Protection Valve	 3018549	AE4405 I89408	AE4405 I89408000	Up to Chassis 7826
Four Circuit Protection Valve	 3197585	AE4603 II36011	AE4603 II36011000	From Chassis 7827 Has "Safety Feature"
Four Circuit Protection Valve	 3197588	AE4604 II36012	AE4604 II36012000	12.0 bar systems Has "Safety Feature"
Charging Valve without Feedback	 8159736	0481063041000	DR4381 K000647	7.0 bar, M22 ports
Charging Valve with Feedback	 3181898	Wabco 434 100 047 0	0481063037000	10.3 bar, M22 ports Air suspension kneeling system
Single Check Valve	 1626982	Wabco 434 012 003 0	KW4455/1	M22 ports

Bodied by Alexander (ALX300 and Strider), Northern Counties (Paladin), Plaxton (Prestige and Verde) and Wrightbus (Endurance, Liberator and Renown)

Mechanical & Air Suspension

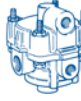
Description	Volvo Part Number	OE Part Number	Replacement Knorr-Bremse Part No	Remarks Note: Left and Right refer to the side of the vehicle when viewed from the driver's seat facing forward.
Single Check Valve 	1629727		KW4455/1	M22 ports
Single Check Valve 	3028396			M12(F)-M16(M) ports
Hand Control Valve 	9515443	HB1143 I82171	HB1143 I82171N00	
Interlock Valve 	1580024	Wabco 434 205 026 0		"Broms" brake
Dual Foot Valve 	3028741	Wabco 461 317 006 0		Without retarder control
Dual Foot Valve 	3028743	Wabco 461 318 005 0		With microswitch retarder control for Voith gearbox
Dual Foot Valve 	3028742	Wabco 461 324 018 0		With pneumatic retarder control for ZF HP500 gearbox
Dual Foot Valve 	70313349	Wabco 461 318 608 0		With multiplex wiring Replaced by 70313310
Dual Foot Valve 	70313310	Wabco 461 318 604 0		
Double Check Valve 	1505044	295358	295358	M16 ports, bracket mounted
Double Check Valve 	9522564	Wabco 434 208 035 0	295358	In retarder control circuit with ZF gearbox. M16 ports, bracket mounted
Relay Valve 	1082666	0481026019000	AC574AXY	AC574AXY has integral silencer Replaced by 3173824

NOTE: X00 and X50 suffixes refer to Exchange Products which may be Remanufactured.











B10B & B10BLE

VOLVO

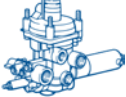
4 x 2









Mechanical & Air Suspension

Bodied by Alexander (ALX300 and Strider), Northern Counties (Paladin), Plaxton (Prestige and Verde) and Wrightbus (Endurance, Liberator and Renown)

Description	Volvo Part Number	OE Part Number	Replacement Knorr-Bremse Part No	Remarks
Relay Valve 	3173824	0481026032000	AC574AXY	AC574AXY has integral silencer
Quick Release Valve 	1581929	RE2108 I70676	RE2108 I70676	Front axle up to Chassis 1833 Replaced by 3173152
Quick Release Valve 	3173152	Wabco 973 500 047 0	KX1294/1	Front axle
Quick Release Valve 	1588769	KX2196/1	KX2196/1	Rear axle up to Chassis 1833
Quick Release Valve 	9518619	Wabco 973 500 039 0 973 500 044 0	KX2000/1	From Chassis 1834 M22 Voss ports
Load Sensing Valve (Air Suspension) 	3112968	Wabco 475 711 033 0		B10BLE, front axle, up to Chassis 7419
Pressure Limiting Valve 	1606720	0481009040000	0481009047000	7.5 bar, M22 ports
Pressure Reducing Valve 	3032760	Wabco 475 009 021 0	KX2045/14000 See Remarks	1.2 bar, M12 ports Retarder control system Set replacement valve to 1.2 bar
Pressure Reducing Valve 	9521613	Wabco 475 009 032 0	KX2045/14000 See Remarks	1.7 bar, M12 ports Retarder control system Set replacement valve to 1.7 bar
Pressure Reducing Valve 	70313806 3032762	Wabco 475 009 022 0 475 009 023 0	KX2045/14000 See Remarks	3.0 bar, M12 ports Retarder control system from Chassis 8270 Set replacement valve to 3.0 bar
Low Pressure Switch 	1594236			Volvo only Replaced by 3987498
Low Pressure Switch 	3987498			

Bodied by Alexander (ALX300 and Strider), Northern Counties (Paladin), Plaxton (Prestige and Verde) and Wrightbus (Endurance, Liberator and Renown)

Mechanical & Air Suspension

Description	Volvo Part Number	OE Part Number	Replacement Knorr-Bremse Part No	Remarks Note: Left and Right refer to the side of the vehicle when viewed from the driver's seat facing forward.
Pressure Switch 	3034073			Air suspension Replaced by 20382504
Pressure Switch 	20382504			Air suspension
Pressure Relief (Safety) Valve 	1622431	KX1729/2	KX1729/2	10 bar, M16 thread Beside Pressure Limiting Valve
Pressure Relief (Safety) Valve 	1622432	KX1729/5	KX1729/5	13 bar, M16 thread In distribution union by Four Circuit Protection Valve
Pressure Relief (Safety) Valve 	1607454			18 bar, M16 thread In ping tank and with Wabco Air Dryer
Tilt Drain Valve 	1081328	Wabco 934 300 033 0	KW2350/2	M22 thread
Test Connector 	1592924	Wabco 463 703 120 0	KW4282/2	M16 thread
Test Connector 	1082480	KW3731/1	AC784D	M22 thread
Exhaust Silencer 	3028744	Wabco 432 407 010 0 432 407 070 0	0484210005000	For Foot Valve Snap-on Replaced by 3943370
Exhaust Silencer 	3943370	0484210005000	0484210005000	For Foot Valve and Load Sensing Valve Snap-on
Exhaust Silencer 	3028745	Wabco 432 407 011 0 432 407 070 0	SIL68ASP	For Air Dryer Snap-on Replaced by 20467891
Exhaust Silencer 	20467891	Wabco 432 407 018 0	SIL68ASP	For Air Dryer Snap-on Alternative Silencers: 0484210017000 or ZB3163-I92999

NOTE: X00 and X50 suffixes refer to Exchange Products which may be Remanufactured.













B10B & B10BLE

VOLVO

4 x 2





Mechanical & Air Suspension

Bodied by Alexander (ALX300 and Strider), Northern Counties (Paladin), Plaxton (Prestige and Verde) and Wrightbus (Endurance, Liberator and Renown)

Description	Volvo Part Number	OE Part Number	Replacement Knorr-Bremse Part No	Remarks <small>Note: Left and Right refer to the side of the vehicle when viewed from the driver's seat facing forward.</small>
Exhaust Silencer 	1197476	Wabco 432 407 060 0	0484210001000	For QRV and Suspension Control Modules M22 thread Alternative Silencers: 0484210001000 or ZB3150-178074
Exhaust Silencer 	1196335	0484210002000	0484210002000	For QRV and Suspension Control Modules M16 thread
ABS Modulator 	1609241	Wabco 472 195 002 0		Up to Chassis 2097 M22 ports, Volvo electrical connector Replaced by 9520836
ABS Modulator 	9520836	Wabco 472 195 051 0		From Chassis 2098 M22 ports, Volvo electrical connector
Wheel Speed Sensor 	3033826			B10B front axle, up to Chassis 2696
Wheel Speed Sensor 	9955936	Wabco 441 032 801 0		B10B front axle, from Chassis 2696 90° sensor, cable length 1.8 m Replaced by 20490824
Wheel Speed Sensor 	9517128			B10BLE front axle, up to Chassis 2696
Wheel Speed Sensor 	9955937	Wabco 441 032 800 0		B10B front axle, from Chassis 2696 90° sensor, cable length 2.27 m Replaced by 20490824
Wheel Speed Sensor 	3036850			Rear axle, up to Chassis 2696
Wheel Speed Sensor 	9955937	Wabco 441 032 800 0		Rear axle, from Chassis 2696 90° sensor, cable length 2.27 m Replaced by 20490824
Wheel Speed Sensor 	20490824	Wabco 441 032 964 2		Replaced by 20490830
Wheel Speed Sensor 	20490830	Wabco 441 032 965 0		

Bodied by Alexander (ALX300 and Strider), Northern Counties (Paladin), Plaxton (Prestige and Verde) and Wrightbus (Endurance, Liberator and Renown)

Mechanical & Air Suspension

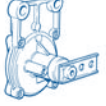
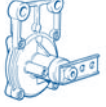
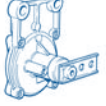
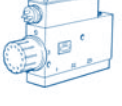
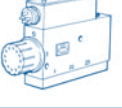
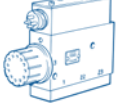
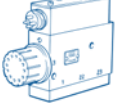
Description	Volvo Part Number	OE Part Number	Replacement Knorr-Bremse Part No	Remarks <small>Note: Left and Right refer to the side of the vehicle when viewed from the driver's seat facing forward.</small>
ABS Electronic Control Unit (Type C2 - ABS & ASR) 	3944519	Wabco 446 004 054 0		Replaced by 3943981
ABS Electronic Control Unit (Type C3 - ABS & ASR) 	3943981	Wabco 446 004 085 0		
ABS Electronic Control Unit (Type C3 - ABS & ASR) 	3962455	Wabco 446 004 079 0		
Air Suspension Levelling Valve 	3036548	SV1412 I98292	SV1412 K000073	Height control only
Air Suspension Levelling Valve 	9518580	SV1399 II30525	SV1399 II30525	With datum adjustment
Air Suspension Level Sensor 	9517678	0504002106000	0504002112100	Up to Chassis 3890. When replaced by 0504002112100 Volvo plug 3177294 is required.
Air Suspension Level Sensor 	8144352 20514066	0504002107000	0504002112100	From Chassis 3891. Replaced by 20850557
Air Suspension Level Sensor 	20850557	K013471	K013471N00	
Air Suspension Control Module 	3112824	0501100015000	0501100018000	Front axle up to Chassis 3890. With kneeling function. Can be replaced with 0501100041100 using Volvo plug 3177294.
Air Suspension Control Module 	9957009	0501100035000	0501100041100	Front axle from Chassis 3891. With kneeling function. Electrical connector DIN 72585 bayonet
Air Suspension Control Module 	3112823	0501100013000	0501100017000	Rear axle up to Chassis 3890. Can be replaced with 0501100029000 using Volvo plug 3177294.
Air Suspension Control Module 	3944717	0501100014000	0501100029000	Rear axle from Chassis 3891. Electrical connector DIN 72585 bayonet

NOTE: X00 and X50 suffixes refer to Exchange Products which may be Remanufactured.











B10B & B10BLE

VOLVO

4 x 2







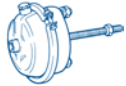
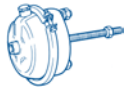

Mechanical & Air Suspension

Bodied by Alexander (ALX300 and Strider), Northern Counties (Paladin), Plaxton (Prestige and Verde) and Wrightbus (Endurance, Liberator and Renown)

Description	Volvo Part Number	OE Part Number	Replacement Knorr-Bremse Part No	Remarks <small>Note: Left and Right refer to the side of the vehicle when viewed from the driver's seat facing forward.</small>
Air Suspension Electronic Control Unit 	3118073	0540004105000	0504004105000	Replacement ECU must be programmed before use
Solenoid Valve 	1626100			For air suspension kneeling system and rear axle.
Solenoid Valve 	8158342	Norgren-Herion 9041005374302400		For air suspension rear axle and retarder control
Solenoid Valve 	8143021	Norgren-Herion 9042001374302400		For air suspension kneeling system, up to Chassis 2459 and for retarder control
Solenoid Valve 	9521600			For air suspension kneeling system, from Chassis 2460 and for retarder control. Replaced by 70303357
Solenoid Valve 	70303357			For air suspension kneeling system and retarder control from Chassis 8270
Solenoid Valve 	3986621	Norgren-Herion 9042006374302400		For retarder control with ZF Gearbox
Engine Stop Cylinder 	3979028			
Clutch Servo 	1655435	Kongsberg KA622090	626639AM	With G7 gearbox
Clutch Servo 	1521371 1668501 1671953	Kongsberg KA626639	626639AM	With G8 gearbox

Bodied by Alexander (ALX300 and Strider), Northern Counties (Paladin), Plaxton (Prestige and Verde) and Wrightbus (Endurance, Liberator and Renown)

Mechanical & Air Suspension

	Description	Volvo Part Number	OE Part Number	Replacement Knorr-Bremse Part No	Remarks <small>Note: Left and Right refer to the side of the vehicle when viewed from the driver's seat facing forward.</small>
Front Axle with Drum Brakes	Brake Chamber (Type 30) 	3035900	MGM 1430202 1430223	1186702-01	B10B with S-cam Brakes Diaphragm 234101K
	Brake Chamber (Type 30) 	3036656	MGM 1430202 1430279	1186702-01	B10B with Z-cam Brakes Diaphragm 234101K
	Brake Chamber (Type 24) 	9518358	MGM 1427202 1427218	1186701-01	B10BLE with S-cam Brakes Diaphragm 234100K
	Brake Chamber (Type 24) 	1618594	MGM 1427202	1186701-01	B10BLE with Z-cam Brakes Diaphragm 234100K
Front Axle with Disc Brakes	Brake Chamber (Type 20HE) 	3112670	1186883-08	1186883-08	B10BLE with Meritor Disc Brakes up to Chassis 7400 Diaphragm 20LS
	Brake Chamber (Type 24) 	70306611	Wabco 423 106 202 0	1186701-01	B10BLE with Meritor Disc Brakes from Chassis 7401 Diaphragm 234100K
Rear Axle with Drum Brakes	Spring Brake (Type 30/30) 	1608006	MGM 4130057 4131200	K2B1101X50	Rear axle with S-cam Brakes up to Chassis 8772 M16 ports, 5/8" UNF push rod Diaphragm 234101K
	Spring Brake (Type 30/30HF) 	20499852	Wabco 925 492 103 0		Rear axle with S-cam Brakes from Chassis 8773 M22 ports, M16 push rod
	Spring Brake (Type 30-98) 	1606834	MGM 4130055 4130059	K2B0521X50	Rear axle with Z-cam Brakes Diaphragm 234101K Alternative is K2B1222X50

NOTE: X00 and X50 suffixes refer to Exchange Products which may be Remanufactured.











B10B & B10BLE

VOLVO

4 x 2





Mechanical & Air Suspension

Bodied by Alexander (ALX300 and Strider), Northern Counties (Paladin), Plaxton (Prestige and Verde) and Wrightbus (Endurance, Liberator and Renown)

	Description		Volvo Part Number	OE Part Number	Replacement Knorr-Bremse Part No	Remarks Note: Left and Right refer to the side of the vehicle when viewed from the driver's seat facing forward.
Front Axle	Automatic Slack Adjuster		1196321	Haldex 72678	KB2275	B10B 140 mm hole centre
	Automatic Slack Adjuster		1196322	Haldex 72726	KB2295	B10B 152 mm hole centre
	Automatic Slack Adjuster		1196321	Haldex 72678	KB2275	B10BLE 140 mm hole centre
	Automatic Slack Adjuster		9518357	Haldex 79564		B10BLE 140 mm hole centre
Rear Axle	Automatic Slack Adjuster		1197965	Haldex 72784	KB3140	Left side 15 mm offset, 165 mm hole centre
	Automatic Slack Adjuster		1197966	Haldex 72785	KB3135	Right side 15 mm offset, 165 mm hole centre
Front Axle	Air Disc Brake		3118227	Meritor		Left side up to Chassis 2823
	Air Disc Brake		3118228	Meritor		Right side up to Chassis 2823
	Air Disc Brake		9524029	Meritor		Left side from Chassis 2824 to 3719
	Air Disc Brake		9524030	Meritor		Right side from Chassis 2824 to 3719

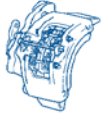

Bodied by Alexander (ALX300 and Strider), Northern Counties (Paladin), Plaxton (Prestige and Verde) and Wrightbus (Endurance, Liberator and Renown)

Mechanical & Air Suspension

	Description	Volvo Part Number	OE Part Number	Replacement Knorr-Bremse Part No	Remarks <small>Note: Left and Right refer to the side of the vehicle when viewed from the driver's seat facing forward.</small>
Front Axle (contd)	Air Disc Brake 	9957385 70301332 70306886 70311512 70330022	Meritor LRG592		Left side from Chassis 3720
	Air Disc Brake 	9957386 70301333 70306887 70311513 70330023	Meritor LRG593		Right side from Chassis 3720
	Disc Brake Pad Set 	3093919 85105485 20825594	Meritor MDP5061		
	Brake Disc 	3112965			

For safety's sake trust only genuine Knorr-Bremse parts

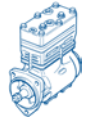
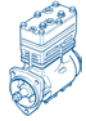
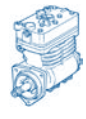
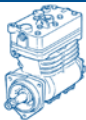
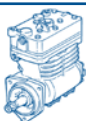
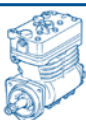
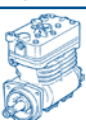
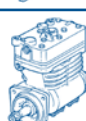
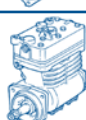
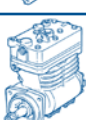
**Don't compromise your
vehicle – fit genuine
Knorr-Bremse parts**

Description	Volvo Part Number	OE Part Number	Replacement Knorr-Bremse Part No	Remarks <small>Note: Left and Right refer to the side of the vehicle when viewed from the driver's seat facing forward.</small>
Air Compressor (2W600R) 	3037346	LP4934 II15992 II30895	LP4934 II30895X00	3 bolt flange mounted with ESS
Air Compressor (2W600R) 	3118286	LP4949 II19191		3 bolt flange mounted with ESS and through drive. Volvo only
Air Compressor (2W600R) 	70305893 70330005 70330096	LK4922 II39141F K000234 K002030		3 bolt flange mounted with through drive. Volvo only
Air Compressor (2W600R) 	9521897	LP4968 II33514	LP4968 II33514X00	3 bolt offset flange mounted with ESS and through drive. Replaced by 3193733
Air Compressor (2W600R) 	3193733	LP4987 II37957	LK4919 K002029X00	3 bolt offset flange mounted with through drive. Replaced by 70303444
Air Compressor (2W600R) 	70303444	LP4994 II38780F	LK4919 K002029X00	3 bolt offset flange mounted with through drive. Replaced by 70305890
Air Compressor (2W600R) 	70305890 70330002 70330090	LK4919 II39078F K000231 K002029	LK4919 K002029X00	3 bolt offset flange mounted with through drive.
Air Compressor (2W600R) 	9521675	LP4967 II33164	LP4967 II33164X00	3 bolt offset flange mounted with ESS Replaced by 3193734
Air Compressor (2W600R) 	3193734	LP4986 II37953	LK4918 K001267X00	3 bolt offset flange mounted Replaced by 70303443
Air Compressor (2W600R) 	70303443 70305889	LP4993 II38779F II39077F	LK4918 K001267X00	3 bolt offset flange mounted Replaced by 70330001
Air Compressor (2W600R) 	70330001	LK4918 K000230	LK4918 K001267X00	3 bolt offset flange mounted Replaced by 70330081
Air Compressor (2W600R) 	70330081	LK4918 K001267	LK4918 K001267X00	3 bolt offset flange mounted

NOTE: X00 and X50 suffixes refer to Exchange Products which may be Remanufactured.









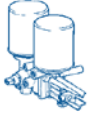

B10L & B10LA







VOLVO

4 x 2 & Artic

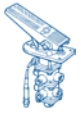
Bodied by Alexander (ALX300 and Ultra), Jonckheere (Mistral), Säffle and Wrightbus (Eclipse Fusion, Liberator and Renown)

Air Suspension

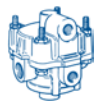
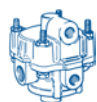
Description		Volvo Part Number	OE Part Number	Replacement Knorr-Bremse Part No	Remarks Note: Left and Right refer to the side of the vehicle when viewed from the driver's seat facing forward.
Governor Valve (D2)		3944251 1607889	272126	1189396000	12.0 bar cut-out
Air Dryer (Twin Cartridge)		3035101	Wabco 432 431 274 0		Replacement cartridge is 272897SP
Four Circuit Protection Valve		3018549	AE4405 I89408	AE4405 I89408000	Up to Chassis 1945
Four Circuit Protection Valve		3197585	AE4603 II36011	AE4603 II36011000	From Chassis 1946 Has "Safety Feature"
Charging Valve without Feedback		1612448 8159736	0481063036000 0481063041000	DR4381 K000647	7.0 bar, M22 ports
Charging Valve with Feedback		8159735	0481063037000	0481063037000	10.3 bar, M22 ports Replaced by 3181898
Charging Valve with Feedback		3181898	Wabco 434 100 047 0	0481063037000	10.3 bar, M22 ports
Single Check Valve		1571924	Wabco 434 023 000 0	KW4648/1	M22 ports
Single Check Valve		1629727		KW4455/1	M22 ports
Hand Control Valve		9515443	HB1143 I82171	HB1143 I82171N00	
Interlock Valve		1580024	Wabco 434 205 026 0		"Broms" brake

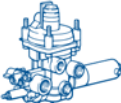
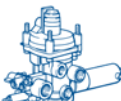
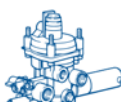
Description	Volvo Part Number	OE Part Number	Replacement Knorr-Bremse Part No	Remarks <small>Note: Left and Right refer to the side of the vehicle when viewed from the driver's seat facing forward.</small>
Dual Foot Valve 	9519903	Wabco 461 318 023 0		Up to Chassis 2007 With microswitch retarder control for Voith gearbox
Dual Foot Valve 	3118798	Wabco 461 324 042 0		Up to Chassis 2007 With pneumatic retarder control for ZF HP500 gearbox
Pneumatic Control Valve	1695943	Wabco 461 324 520 0		Fitted on side of above Foot Valve
Dual Foot Valve 	70313349	Wabco 461 318 608 0		From Chassis 2008 Replaced by 70313310
Dual Foot Valve 	70313310	Wabco 461 318 604 0		
Double Check Valve 	1505044	295358	295358	M16 ports, bracket mounted
Relay Valve 	1082666	0481026019000	AC574AXY	AC574AXY has integral silencer Replaced by 3173824
Relay Valve 	3173824	0481026032000	AC574AXY	AC574AXY has integral silencer
Quick Release Valve 	9518619	Wabco 973 500 039 0 973 500 044 0	KX2000/1	From Chassis 1834 M22 Voss ports
Load Sensing Valve (Air Suspension) 	3112968	Wabco 475 711 033 0		B10L, front axle up to Chassis 1817
Load Sensing Valve (Air Suspension) 	3031393	Wabco 475 711 038 0		B10L, front axle from Chassis 1818
Load Sensing Valve (Air Suspension) 	3031391	Wabco 475 711 040 0		B10LA, front and centre axles up to Chassis 1817









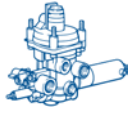
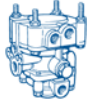

B10L & B10LA

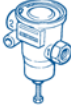
VOLVO

4 x 2 & Artic













Bodied by Alexander (ALX300 and Ultra), Jonckheere (Mistral), Säffle and Wrightbus (Eclipse Fusion, Liberator and Renown)

Air Suspension

Description	Volvo Part Number	OE Part Number	Replacement Knorr-Bremse Part No	Remarks Note: Left and Right refer to the side of the vehicle when viewed from the driver's seat facing forward.
Load Sensing Valve (Air Suspension) 	9958760	Wabco 475 711 145 0		B10LA, centre axle from Chassis 1818
Trailer Control Valve 	1589025	0481061020000	0481061020000	B10LA Artic
Pressure Limiting Valve 	1606720	0481009040000	0481009047000	7.5 bar, M22 ports
Pressure Limiting Valve 	70305736	0481009071000	0481009014000 See Remarks	2.0 bar, M22 ports, Door brake system Set replacement valve to 2.0 bar
Pressure Reducing Valve 	3032760	Wabco 475 009 021 0	KX2045/14000 See Remarks	1.2 bar, M12 ports Retarder control system Set replacement valve to 1.2 bar
Low Pressure Switch 	3987498			
Pressure Switch 	3034073			Replaced by 20382504
Pressure Switch 	20382504			
Pressure Relief (Safety) Valve 	1622431	KX1729/2	KX1729/2	10 bar, M16 thread
Pressure Relief (Safety) Valve 	1622432	KX1729/5	KX1729/5	13 bar, M16 thread
Tilt Drain Valve 	1081328	Wabco 934 300 033 0	KW2350/2	M22 thread
Test Connector 	1592924	Wabco 463 703 120 0	KW4282/2	M16 thread

Bodied by Alexander (ALX300 and Ultra), Jonckheere (Mistral), Säffle and Wrightbus (Eclipse Fusion, Liberator and Renown)

Air Suspension

Description	Volvo Part Number	OE Part Number	Replacement Knorr-Bremse Part No	Remarks Note: Left and Right refer to the side of the vehicle when viewed from the driver's seat facing forward.
Test Connector 	1082480	KW3731/1	AC784D	M22 thread
Exhaust Silencer 	3943370	0484210005000	0484210005000	For Foot Valve and Load Sensing Valve Snap-on
Exhaust Silencer 	1197476	Wabco 432 407 060 0	SIL68B	For QRV and Suspension Control Modules M22 thread Alternative Silencers: 0484210001000 or ZB3150-178074
ABS Modulator 	1609241	Wabco 472 195 002 0		Up to Chassis 2097 M22 ports, Volvo electrical connector Replaced by 9520836
ABS Modulator 	9520836	Wabco 472 195 051 0		From Chassis 2098 M22 ports, Volvo electrical connector
Wheel Speed Sensor 				
Wheel Speed Sensor 				
ABS Electronic Control Unit (Type C2 - ABS & ASR) 	8141342 3944519	Wabco 446 004 054 0		B10L Replaced by 3943981
ABS Electronic Control Unit (Type C3 - ABS & ASR) 	3943981	Wabco 446 004 085 0		B10L
ABS Electronic Control Unit (Type C3 - ABS & ASR) 	3962455	Wabco 446 004 079 0		B10L
ABS Electronic Control Unit (Type C2 - ABS & ASR) 	8141345	Wabco 446 003 054 0		B10LA Artic 6S6M system Replaced by 3930452
ABS Electronic Control Unit (Type C3 - ABS & ASR) 	3930452	Wabco 446 004 064 0		B10LA Artic 6S6M system

NOTE: X00 and X50 suffixes refer to Exchange Products which may be Remanufactured.







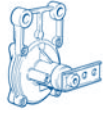
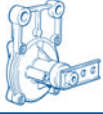
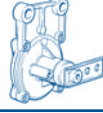
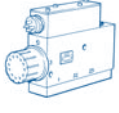
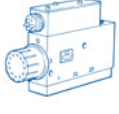

B10L & B10LA

VOLVO

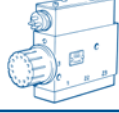
4 x 2 & Artic

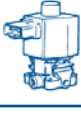





Bodied by Alexander (ALX300 and Ultra), Jonckheere (Mistral), Säffle and Wrightbus (Eclipse Fusion, Liberator and Renown)

Air Suspension

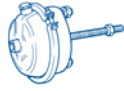
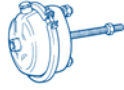
Description	Volvo Part Number	OE Part Number	Replacement Knorr-Bremse Part No	Remarks
Air Suspension Level Sensor 	9517678	0504002106000	0504002112100	Up to Chassis 1227. When replaced by 0504002112100 Volvo plug 3177294 is required.
Air Suspension Level Sensor 	8144352 20514066	0504002107000	0504002112100	From Chassis 1228. Replaced by 20850557
Air Suspension Level Sensor 	20850557	K013471	K013471N00	
Air Suspension Control Module 	3112824	0501100015000	0501100018000	Front axle up to Chassis 1228. With kneeling function. Can be replaced with 0501100041100 using Volvo plug 3177294.
Air Suspension Control Module 	9957009	0501100035000	0501100041100	Front axle from Chassis 1228. With kneeling function. Electrical connector DIN 72585 bayonet
Air Suspension Control Module 	3112823	0501100013000	0501100017000	Rear axle up to Chassis 1227. Can be replaced with 0501100029000 using Volvo plug 3177294.
Air Suspension Control Module 	3944717	0501100014000	0501100029000	Rear axle from Chassis 1228. Electrical connector DIN 72585 bayonet
Air Suspension Electronic Control Unit 	3118073	0540004105000	0504004105000	Replacement ECU must be programmed before use
Solenoid Valve 	1078316	Norgren-Herion 9041025374602400		Door brake system
Solenoid Valve 	9521600			B10LA centre axle and for retarder control Replaced by 70303357
Solenoid Valve 	70303357			B10LA centre axle and for retarder control
Solenoid Valve 	9515215	Wabco 472 137 132 0		Traction control (ASR) Normally 'Closed', M12 ports, Volvo electrical connector

Bodied by Alexander (ALX300 and Ultra), Jonckheere (Mistral), Säffle and Wrightbus (Eclipse Fusion, Liberator and Renown)

Air Suspension

	Description		Volvo Part Number	OE Part Number	Replacement Knorr-Bremse Part No	Remarks Note: Left and Right refer to the side of the vehicle when viewed from the driver's seat facing forward.
	Engine Stop Cylinder 		3979028			
Front Axle with Disc Brakes	Brake Chamber (Type 20HE) 		3112670	1186883-08	1186883-08	With Meritor Disc Brakes up to Chassis 2002 Diaphragm 20LS
	Brake Chamber (Type 24) 		70306611	Wabco 423 106 202 0	1186701-01	With Meritor Disc Brakes from Chassis 2003 Diaphragm 234100K
Drive Axle with Drum Brakes	Spring Brake (Type 30/30) 		1608006	MGM 4130057 4131200	K2B1101X50	Rear axle with S-cam Brakes M16 ports, 5/8" UNF push rod Diaphragm 234101K
	Spring Brake (Type 30/30HF) 		20499852	Wabco 925 492 103 0		Rear axle with S-cam Brakes M22 ports, M16 push rod
	Spring Brake (Type 30-98) 		1606834	MGM 4130055 4130059	K2B0521X50	Rear axle with Z-cam Brakes Diaphragm 234101K Alternative is K2B1222X50
B10LA Centre Axle with Drum Brakes	Spring Brake (Type 30/30) 		1608006	MGM 4130057 4131200	K2B1101X50	Rear axle with S-cam Brakes M16 ports, 5/8" UNF push rod Diaphragm 234101K
	Spring Brake (Type 30/30HF) 		20499852	Wabco 925 492 103 0		Rear axle with S-cam Brakes M22 ports, M16 push rod
	Spring Brake (Type 30-98) 		1606834	MGM 4130055 4130059	K2B0521X50	Rear axle with Z-cam Brakes Diaphragm 234101K Alternative is K2B1222X50

NOTE: X00 and X50 suffixes refer to Exchange Products which may be Remanufactured.







B10L & B10LA

VOLVO

4 x 2 & Artic

Bodied by Alexander (ALX300 and Ultra), Jonckheere (Mistral), Säffle and Wrightbus (Eclipse Fusion, Liberator and Renown)

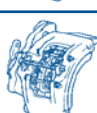
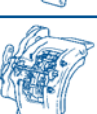
Air Suspension



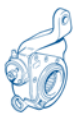

	Description	Volvo Part Number	OE Part Number	Replacement Knorr-Bremse Part No	Remarks Note: Left and Right refer to the side of the vehicle when viewed from the driver's seat facing forward.
Front Axle	Air Disc Brake 	3118227	Meritor		Left side up to Chassis 437
	Air Disc Brake 	3118228	Meritor		Right side up to Chassis 2437
	Air Disc Brake 	9524029	Meritor		Left side from Chassis 438 to 1141
	Air Disc Brake 	9524030	Meritor		Right side from Chassis 438 to 1141
	Air Disc Brake 	70301332 70306886 70311512 70330022	Meritor LRG592		Left side from Chassis 1142
	Air Disc Brake 	70301333 70306887 70311513 70330023	Meritor LRG593		Right side from Chassis 1142
	Disc Brake Pad Set 	3093919 85105485 20825594	Meritor MDP5061		
	Brake Disc 	3112965			

Drive and B10LA Centre Axles	Automatic Slack Adjuster 	3193402	Haldex 79713		Left side 45 mm offset, 145 mm hole centre
	Automatic Slack Adjuster 	3193403	Haldex 79714		Right side 45 mm offset, 145 mm hole centre

See Notes on Chassis Nos. for different
Marks at the end of this section

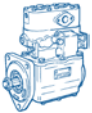
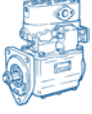
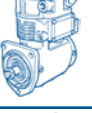
Bodied by Alexander (PS and Q), Duple (300), East Lancs (Flyte), Jonckheere

(Deauville and Jubilee), Northern Counties (Paladin), Plaxton (Excalibur, Expression, Mechanical & Air Suspension
Paragon, Paramount and Premiere), Säftele and Van Hool (Alizee, Astral and Exeter)

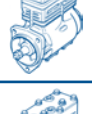
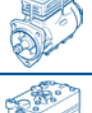
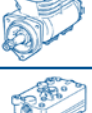
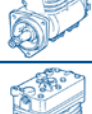
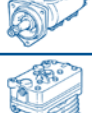
Description	Volvo Part Number	OE Part Number	Replacement Knorr-Bremse Part No	Remarks Note: Left and Right refer to the side of the vehicle when viewed from the driver's seat facing forward.
Air Compressor (EL1300) 	1586339	GMR		Mk 1, 3 bolt flange mounted Replaced by 6882116
Air Compressor (EL1600) 	6882116 3038354	GMR		Mk 1, 3 bolt flange mounted
Air Compressor (2W440D) 	3018546	KZ433/6	KZ433/6X50	Mk 1 & 2, 3 bolt flange mounted
Air Compressor (2W440R) 	1613632	LP4813 I90499	LP4813 I90499X50	Mk 3 and City Bus 3 bolt flange mounted
Air Compressor (2W440R) 	8150407	LP4825 II15993	LP4825 II15993X00	Mk 3, from Chassis 313512 3 bolt flange mounted with ESS
Air Compressor (2W600R) 	3037346	LP4934 II30895	LP4934 II30895X00	Mk 4, 3 bolt flange mounted with ESS Replaced by 70303446
Air Compressor (2W600R) 	70303446	LP4996 II38845F	LK4921 K001268000	Mk 4, 3 bolt flange mounted Replaced by 70305892
Air Compressor (2W600R) 	70305892 70330004 70330094	LK4921 II39080F K000233 K001268	LK4921 K001268000	Mk 4, 3 bolt flange mounted
Air Compressor (2W600R) 	9521675	LP4967 II33164	LP4967 II33164X00	Mk 4, 3 bolt offset flange mounted with ESS Replaced by 3193734
Air Compressor (2W600R) 	3193734	LP4986 II37953	LK4918 K001267X00	Mk 4, 3 bolt offset flange mounted Replaced by 70303443
Air Compressor (2W600R) 	70303443	LP4993 II38779F	LK4918 K001267X00	Mk 4, 3 bolt offset flange mounted Replaced by 70330001
Air Compressor (2W600R) 	70330001	LK4918 K000230	LK4918 K001267X00	Mk 4, 3 bolt offset flange mounted Replaced by 70330081

NOTE: X00 and X50 suffixes refer to Exchange Products which may be Remanufactured.

B10M/MA Mk 1, 2, 3 & 4









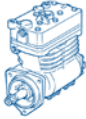
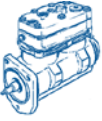

VOLVO

4 x 2, Artic & City Bus (double deck)

See Notes on Chassis Nos. for different Marks at the end of this section

Mechanical & Air Suspension

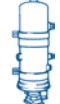
Bodied by Alexander (PS and Q), Duple (300), East Lancs (Flyte), Jonckheere (Deauville and Jubilee), Northern Counties (Paladin), Plaxton (Excalibur, Expression, Paragon, Paramount and Premiere), Säfte and Van Hool (Alizee, Astral and Exeter)

Description	Volvo Part Number	OE Part Number	Replacement Knorr-Bremse Part No	Remarks Note: Left and Right refer to the side of the vehicle when viewed from the driver's seat facing forward.
Air Compressor (2W600R) 	70330081	LK4918 K001267	LK4918 K001267X00	Mk 4, 3 bolt offset flange mounted
Air Compressor (2W704R) 	3037344	Wabco 911 505 151 0		Mk 4 and City Bus
Governor Valve (D2) 	6865623 3126847 3944255	267036 267100	1189394000	B10M with mechanical suspension and City Bus 8.1 bar cut-out
Governor Valve (D2) 	3944520 1193532	1189395	1189395000	B10M with mechanical suspension and City Bus 8.5 bar cut-out
Governor Valve (D2) 	3944251 1607889	272126	1189396000	Vehicles with air suspension and kneeling system 12.0 bar cut-out
Governor Valve (D2) 	3944254	1189489	1189489000	Vehicles with air suspension without kneeling system 10.0 bar cut-out
Governor Valve (D2) 	8124135			With LA6710 Air Dryer
Sychro Valve (SV1) 	1076379	5000824	5000824	Used with Compressors with ESS
Alcohol Evaporator 	1505045	295357	295521	Mk 1 & 2 without Air Dryer
Alcohol Evaporator Check Valve 	1591676	KW1873/10	KW1873/10	Mk 1 & 2 without Air Dryer
Air Dryer (AD2) 	1190405 1599631	267113 267121	267121X50	Mk 2 and some retrofit on Mk 3 and City Bus.
Air Dryer (Twin Cartridge) 	1622637	Wabco 432 430 173 0		Mk 3 up to Chassis 20266

See Notes on Chassis Nos. for different







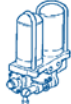
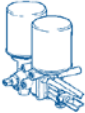

Marks at the end of this section

Bodied by Alexander (PS and Q), Duple (300), East Lancs (Flyte), Jonckheere

(Deauville and Jubilee), Northern Counties (Paladin), Plaxton (Excalibur, Expression,

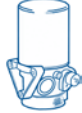
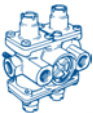
Paragon, Paramount and Premiere), Säftele and Van Hool (Alizee, Astral and Exeter)

Mechanical & Air Suspension

Description	Volvo Part Number	OE Part Number	Replacement Knorr-Bremse Part No	Remarks Note: Left and Right refer to the side of the vehicle when viewed from the driver's seat facing forward.
Air Dryer (Twin Cartridge) 	3031949	Wabco 432 430 174 0		Mk 3 from Chassis 20267 and City Bus
Air Dryer (Twin Cartridge) 	3035101	Wabco 432 431 274 0		Mk 4 up to Chassis 46792 and 60431 and City Bus Replacement cartridge is 272897SP
Air Dryer 	3194899	Haldex 87297	LA8286 II39752F00	Mk 4, up to Chassis 4850 and 60771 12.0 bar cut-out Replaced by 70313308
Air Dryer 	70313308	Haldex 89292 90548	LA8286 II39752F00	12.5 bar cut-out
Air Dryer 	3194898 70313304	Haldex 87282	LA8219 II19483N00	Mk 4, from Chassis 48591 and 60772 10.8 bar cut-out
Air Dryer 	3194897 70313302	Haldex 87337	LA8227 II30181-B	Mk 4 special vehicles 10.0 bar cut-out
Air Dryer 	1629927	LA6710 II16149	LA6711 II36936000	Replacement cartridge is 272897SP
Four Circuit Protection Valve 	1573255	Wabco 934 702 042 0	AE4158 I70615	Mk 1 and some Mk 2 vehicles Replaced by 8152899
Four Circuit Protection Valve 	1618635	AE4409 I92503	AE4409 I92503	Some Mk 2 and Mk 3 vehicles Replaced by 8152899
Four Circuit Protection Valve 	8152899	AE4428 II15588	AE4428 II15588000	
Four Circuit Protection Valve 	3018549	AE4405 I89408	AE4405 I89408000	Some Mk 3 and Mk 4 vehicles and City Bus

NOTE: X00 and X50 suffixes refer to Exchange Products which may be Remanufactured.

B10M/MA Mk 1, 2, 3 & 4











VOLVO

4 x 2, Artic & City Bus (double deck)

See Notes on Chassis Nos. for different Marks at the end of this section

Mechanical & Air Suspension



Bodied by Alexander (PS and Q), Duple (300), East Lancs (Flyte), Jonckheere (Deauville and Jubilee), Northern Counties (Paladin), Plaxton (Excalibur, Expression, Paragon, Paramount and Premiere), Säftele and Van Hool (Alizee, Astral and Exeter)

Description	Volvo Part Number	OE Part Number	Replacement Knorr-Bremse Part No	Remarks Note: Left and Right refer to the side of the vehicle when viewed from the driver's seat facing forward.
Charging Valve without Feedback 	366695	Wabco 434 100 102 0	<i>DR4340</i> K000639	Mk 2 vehicles 4.5 bar, M22 ports Replaced by 1590129
Charging Valve without Feedback 	1590129	<i>DR4340</i> 169856	<i>DR4340</i> K000639	Mk 2 vehicles 4.5 bar, M22 ports
Charging Valve without Feedback 	1612448 8159736	0481063036000 0481063041000	<i>DR4381</i> K000647	Mk 3 and Mk 4 vehicles and City Bus 7.0 bar, M22 ports
Single Check Valve 	1571924	Wabco 434 023 000 0	KW4648/1	M22 ports
Single Check Valve 	1585876 1629727	KW4455/1	KW4455/1	M22 ports
Single Check Valve 	1626982 1505049 8120600	Wabco 434 012 003 0 434 023 010 0	KW4455/1	M22 ports
Single Check Valve 	3028396			M12(F)-M16(M) ports
Hand Control Valve 	4822431 9515443	<i>HB1143</i> 161720 182171	<i>HB1143</i> 182171N00	
Interlock Valve 	1580024	Wabco 434 205 026 0		"Broms" brake
Dual Foot Valve 	1134519	Wabco 461 307 520 0		MK 1 and Mk 2 vehicles Without retarder control
Dual Foot Valve 	1134518	Wabco 461 310 562 0		MK 1 and Mk 2 vehicles With microswitch retarder control for Voith gearbox
Dual Foot Valve 	1193173	Wabco 461 324 016 0		MK 1 and Mk 2 vehicles With pneumatic retarder control for ZF gearbox

See Notes on Chassis Nos. for different Marks at the end of this section

Bodied by Alexander (PS and Q), Duple (300), East Lancs (Flyte), Jonckheere

(Deauville and Jubilee), Northern Counties (Paladin), Plaxton (Excalibur, Expression, Mechanical & Air Suspension Paragon, Paramount and Premiere), Säftele and Van Hool (Alizee, Astral and Exeter)

Description	Volvo Part Number	OE Part Number	Replacement Knorr-Bremse Part No	Remarks Note: Left and Right refer to the side of the vehicle when viewed from the driver's seat facing forward.
Dual Foot Valve 	3028741	Wabco 461 317 006 0		Mk 3 and Mk 4 vehicles Without retarder control
Dual Foot Valve 	3028743	Wabco 461 318 005 0		Mk 3 and Mk 4 vehicles and City Bus With microswitch retarder control for Voith gearbox
Dual Foot Valve 	3028742	Wabco 461 324 018 0		Mk 3 and Mk 4 vehicles and City Bus With pneumatic retarder control for ZF gearbox
Pneumatic Control Valve	1695943	Wabco 461 324 520 0		Fitted on side of above Foot Valve
Dual Foot Valve 	8365045			With pendant pedal With Telma retarder
Double Check Valve 	1505044	295358	295358	Mk 1, Mk 2, Mk 3 and Mk 4 vehicles up to Chassis 46957 and 60445, and City Bus M16 ports, bracket mounted
Double Check Valve 	9522564	Wabco 434 208 035 0	295358	Mk 4 vehicles from Chassis 46958 and 60446, and City Bus M16 ports, bracket mounted
Relay Valve (R6) 	1505036	295199	295199	Mk 1 and Mk 2 vehicles
Relay Valve 	1197892	0481026021000	AC574AXY	Mk 3 vehicles AC574AXY has integral silencer Replaced by 1082666
Relay Valve 	1082666	Wabco 973 011 000 0	AC574AXY	Mk 3 vehicles AC574AXY has integral silencer Replaced by 3173824
Relay Valve 	6886834 3162118	0481026005000	0481026005000	Mk 4 vehicles Replaced by 3173150
Relay Valve 	3173150 3173824	0481026032000	AC574AXY	Mk 4 vehicles and City Bus AC574AXY has integral silencer

NOTE: X00 and X50 suffixes refer to Exchange Products which may be Remanufactured.

B10M/MA Mk 1, 2, 3 & 4









VOLVO

4 x 2, Artic & City Bus (double deck)

See Notes on Chassis Nos. for different Marks at the end of this section

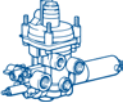
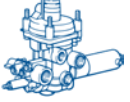
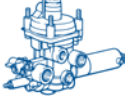
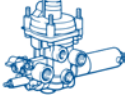
Mechanical & Air Suspension









Bodied by Alexander (PS and Q), Duple (300), East Lancs (Flyte), Jonckheere (Deauville and Jubilee), Northern Counties (Paladin), Plaxton (Excalibur, Expression, Paragon, Paramount and Premiere), Säftele and Van Hool (Alizee, Astral and Exeter)

Description	Volvo Part Number	OE Part Number	Replacement Knorr-Bremse Part No	Remarks Note: Left and Right refer to the side of the vehicle when viewed from the driver's seat facing forward.
Quick Release Valve 	1581929	RE2108 170676	RE2108 170676	Front axle, Mk 1, Mk 2, Mk 3 and Mk 4 vehicles up to Chassis 42911 and City Bus Replaced by 3173152
Quick Release Valve 	3173152	Wabco 973 500 047 0	KX1294/1	Front axle, Mk 1, Mk 2, Mk 3 and Mk 4 vehicles up to Chassis 42911
Quick Release Valve 	1588769	KX2196/1	KX2196/1	Rear axle, Mk 1, Mk 2, Mk 3 and Mk 4 vehicles up to Chassis 42911 and City Bus
Quick Release Valve 	9518619	Wabco 973 500 039 0 973 500 044 0	KX2000/1	Front and rear axle, Mk 4 vehicles from Chassis 42912 Voss ports
Exhaust Check Valve 	6865728	KX2016/1	KX2016/1	Fitted to QRV on City Bus
Load Sensing Valve (Air Suspension) 	1197827	Wabco 475 711 020 0		Mk 1 vehicles
Load Sensing Valve (Air Suspension) 	3031391	Wabco 475 711 040 0		Rear axle, Mk 2, Mk 3 and Mk 4 vehicles and City Bus. See Notes
Load Sensing Valve (Air Suspension) 	3031392	Wabco 475 711 039 0		B10MA Mk 3 and Mk4 non-steered trailer axle (10.5 tonne)
Load Sensing Valve (Air Suspension) 	3031393	Wabco 475 711 038 0		B10MA Mk 3 and Mk4 steered trailer axle (8.0 tonne)
Trailer Control Valve 	1589025	0481061020000	0481061020000	B10MA Artic
Pressure Limiting Valve 	1606720	0481009040000	0481009047000	7.5 bar, M22 ports
Low Pressure Switch 	3987498			Volvo only

See Notes on Chassis Nos. for different
Marks at the end of this section

Bodied by Alexander (PS and Q), Duple (300), East Lancs (Flyte), Jonckheere

(Deauville and Jubilee), Northern Counties (Paladin), Plaxton (Excalibur, Expression, Mechanical & Air Suspension
Paragon, Paramount and Premiere), Säftele and Van Hool (Alizee, Astral and Exeter)

Description	Volvo Part Number	OE Part Number	Replacement Knorr-Bremse Part No	Remarks Note: Left and Right refer to the side of the vehicle when viewed from the driver's seat facing forward.
Pressure Switch 	3034073			Front axle air suspension Volvo only
Pressure Relief (Safety) Valve 	1588148	KX1729/1	KX1729/1	Mk 1 and Mk 2 vehicles without air suspension and City Bus 9.3 bar, M16 thread
Pressure Relief (Safety) Valve 	1622431	KX1729/2	KX1729/2	Mk 3 vehicles and City Bus 10 bar, M16 thread
Pressure Relief (Safety) Valve 	1622432	KX1729/5	KX1729/5	Mk 3 vehicles and City Bus 13 bar, M16 thread
Pressure Relief (Safety) Valve 	3173104	Wabco 434 608 220 0	KX1729/2	Mk 4 vehicles and City Bus 10 bar, M16 thread
Pressure Relief (Safety) Valve 	1607454			Mk 4 vehicles 18 bar, M16 thread Volvo only
Tilt Drain Valve 	1081328 1581425	Wabco 934 300 001 0 934 300 033 0	KW2350/2	M22 thread
Test Connector 	1592924	Wabco 463 703 120 0	KW4282/2	M16 thread
Test Connector 	1082480	KW3731/1	AC784D	M22 thread
Exhaust Silencer 	3028745	Wabco 423 407 070 0	SIL68ASP	On Wabco Air Dryer Snap-on Alternative Silencers: 0484210017000 or ZB3163-192999
Exhaust Silencer 	3943370	0484210005000	0484210005000	For Foot Valve and Load Sensing Valve Snap-on
Exhaust Silencer 	1197476	Wabco 432 407 060 0	SIL68B	For Relay Valve and Suspension Control Modules M22 thread Alternative Silencers: 0484210001000 or ZB3150-178074

NOTE: X00 and X50 suffixes refer to Exchange Products which may be Remanufactured.

B10M/MA Mk 1, 2, 3 & 4













VOLVO

4 x 2, Artic & City Bus (double deck)

See Notes on Chassis Nos. for different Marks at the end of this section

Mechanical & Air Suspension

Bodied by Alexander (PS and Q), Duple (300), East Lancs (Flyte), Jonckheere (Deauville and Jubilee), Northern Counties (Paladin), Plaxton (Excalibur, Expression, Paragon, Paramount and Premiere), Säfte and Van Hool (Alizee, Astral and Exeter)

Description	Volvo Part Number	OE Part Number	Replacement Knorr-Bremse Part No	Remarks Note: Left and Right refer to the side of the vehicle when viewed from the driver's seat facing forward.
Exhaust Silencer 	1196335	0484210002000	0484210002000	For Relay Valve and Suspension Control Modules M16 thread
ABS Modulator 	1609241	Wabco 472 195 002 0		Mk 3 vehicles M22 ports, Volvo electrical connector Replaced by 9520836
ABS Modulator 	9520836	Wabco 472 195 051 0		Mk 3 and Mk 4 vehicles M22 ports, Volvo electrical connector
Wheel Speed Sensor 	9955937	Wabco 441 032 800 0		90° sensor, Volvo connector, cable length 2.265 m. Replaced by 20490824
Wheel Speed Sensor 	9515896	Wabco 441 032 779 0		90° sensor, Volvo connector, cable length 2.265 m. Replaced by 20490824
Wheel Speed Sensor 	9955938	Wabco 441 032 093 0		90° sensor, cable length 1.54 m. Replaced by 20490824
Wheel Speed Sensor 	20490824	Wabco 441 032 964 2		
ABS Electronic Control Unit (Type C1 - ABS & ASR) 	1610913	Wabco 446 004 011 0		Mk 3 vehicles Replaced by 3943981
ABS Electronic Control Unit (Type C2 - ABS & ASR) 	3944519 8141342	Wabco 446 004 054 0		Mk 3 vehicles and City Bus Replaced by 3943981
ABS Electronic Control Unit (Type C3 - ABS & ASR) 	3943981	Wabco 446 004 085 0		Mk 4 vehicles
ABS Electronic Control Unit (Type C3 - ABS & ASR) 	3962455	Wabco 446 004 079 0		Mk 4 vehicles
ABS Electronic Control Unit (Type C1 - ABS & ASR) 	1610915	Wabco 446 003 001 0		Mk 3 B10MA vehicles 6S6M system Replaced by 3930452

See Notes on Chassis Nos. for different









Marks at the end of this section

Bodied by Alexander (PS and Q), Duple (300), East Lancs (Flyte), Jonckheere

(Deauville and Jubilee), Northern Counties (Paladin), Plaxton (Excalibur, Expression,

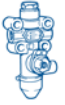
Paragon, Paramount and Premiere), Säftele and Van Hool (Alizee, Astral and Exeter)

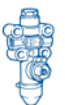
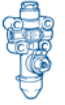
Mechanical & Air Suspension

Description	Volvo Part Number	OE Part Number	Replacement Knorr-Bremse Part No	Remarks Note: Left and Right refer to the side of the vehicle when viewed from the driver's seat facing forward.
ABS Electronic Control Unit (Type C2 - ABS & ASR) 	8141345	Wabco 446 003 054 0		Mk 4 B10MA vehicles 6S6M system Replaced by 3930452
ABS Electronic Control Unit (Type C3 - ABS & ASR) 	3930452	Wabco 446 004 064 0		Mk 4 B10MA vehicles 6S6M system
Air Suspension Levelling Valve 	367839	0500005007000	0500005007000	Rear axle, left side up to Chassis 310373 and some City Bus
Air Suspension Levelling Valve 	367838	0500005006000	0500005006000	Rear axle, right side up to Chassis 310373 and some City Bus
Air Suspension Levelling Valve 	1607728	Wabco 464 006 000 0	SV1460 II36088	Mk 3 and some Mk 4 vehicles and some City Bus Replaced by 3036549
Air Suspension Levelling Valve 	3036549 9518580	SV1399 I94622 II30525	SV1399 II30525	Mk 3 and some Mk 4 vehicles with lift facility or kneeling facility on the trailer. Replaced by 3036549
Air Suspension Levelling Valve 	3036548	SV1412 I98292	SV1412 K000073	Mk 4 from Chassis 47541 to 60445 without lift facility
Air Suspension Levelling Valve 	8365777	SV1326 I85673	SV1295 I85698	Drive axle, Mk 4 from Chassis 310374 to 311209 Replaced by 3038069
Air Suspension Levelling Valve 	3038069 20356526	SV1295 I85698	SV1295 I85698	Drive axle, Mk 4
Actuating Cylinder 	1136085	0482005015000	0482005015000	30 mm dia., 45 mm stroke Air suspension lift facility
Actuating Cylinder 	1194376	0482005018000	0482005018000	30 mm dia., 80 mm stroke Air suspension lift facility

NOTE: X00 and X50 suffixes refer to Exchange Products which may be Remanufactured.

B10M/MA Mk 1, 2, 3 & 4





VOLVO

4 x 2, Artic & City Bus (double deck)

See Notes on Chassis Nos. for different
Marks at the end of this section

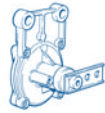
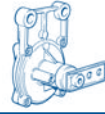
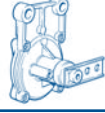
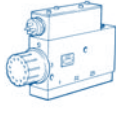
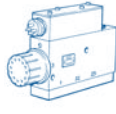
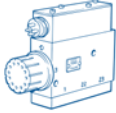
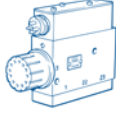
Mechanical & Air Suspension

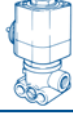
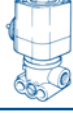





Bodied by Alexander (PS and Q), Duple (300), East Lancs (Flyte), Jonckheere (Deauville and Jubilee), Northern Counties (Paladin), Plaxton (Excalibur, Expression, Paragon, Paramount and Premiere), Säftele and Van Hool (Alizee, Astral and Exeter)





Description	Volvo Part Number	OE Part Number	Replacement Knorr-Bremse Part No	Remarks Note: Left and Right refer to the side of the vehicle when viewed from the driver's seat facing forward.
Air Suspension Level Sensor 	9517678	0504002106000	0504002112100	MK 4 vehicles up to Chassis 48590 and 60725. When replaced by 0504002112100 Volvo plug 3177294 is required.
Air Suspension Level Sensor 	8144352 20514066	0504002107000	0504002112100	MK 4 vehicles from Chassis 48591 and 60726. Replaced by 20850557
Air Suspension Level Sensor 	20850557	K013741	K013741N00	
Air Suspension Control Module 	3112824	0501100015000	0501100018000	Mk 4 front axle up to Chassis 48590 and 60725. With kneeling function. Can be replaced with 0501100041100 using Volvo plug 3177294.
Air Suspension Control Module 	9957009	0501100035000	0501100041100	MK 4 front axle from Chassis 48591 and 60726. With kneeling function. Electrical connector DIN 72585 bayonet
Air Suspension Control Module 	3112823	0501100013000	0501100017000	Mk 4 rear axle up to Chassis 48590 and 60725. Can be replaced with 0501100029100 using Volvo plug 3177294.
Air Suspension Control Module 	3944717	0501100014000	0501100029000	MK 4 rear axle from Chassis 48591 and 60726. Electrical connector DIN 72585 bayonet
Air Suspension Electronic Control Unit 	3118073	0540004105000	0504004105000	Mk 4 vehicles Replacement ECU must be programmed before use
Solenoid Valve 	8158342	Norgren-Herion 9041005374302400		Air suspension and engine stop systems
Solenoid Valve 	8143021	Norgren-Herion 9042001374302400		Air suspension and retarder control systems
Solenoid Valve 	1626100			Air suspension
Solenoid Valve 	9515215	Wabco 462 137 132 0		Traction control (ASR) Normally 'Closed', M12 ports, Volvo electrical connector

See Notes on Chassis Nos. for different
Marks at the end of this section

4 x 2, Artic & City Bus (double deck)

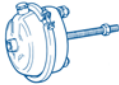
Bodied by Alexander (PS and Q), Duple (300), East Lancs (Flyte), Jonckheere
(Deauville and Jubilee), Northern Counties (Paladin), Plaxton (Excalibur, Expression, Mechanical & Air Suspension
Paragon, Paramount and Premiere), Säftele and Van Hool (Alizee, Astral and Exeter)

Description	Volvo Part Number	OE Part Number	Replacement Knorr-Bremse Part No	Remarks Note: Left and Right refer to the side of the vehicle when viewed from the driver's seat facing forward.
Engine Stop Cylinder 	469882			
Clutch Servo 	1655639	Kongsberg KA622080	626392AM	Replaced by 1673067
Clutch Servo 	1673067	Kongsberg KA622050	626392AM	
Clutch Servo 	1655435	Kongsberg KA622090	626639AM	With G7 gearbox
Clutch Servo 	1521371 1668501 1671953	Kongsberg KA626639	626639AM	With G8 gearbox
Clutch Master Cylinder 	1620462 1669488			

Front Axle	Brake Chamber (Type 24) 	1194637	272098	295555 + Yoke 1185157	B10M Mk 1 and Mk 2 vehicles B10MA Mk 2 and Mk 3 vehicles Diaphragm 234100K
	Brake Chamber (Type 24) 	9518358	MGM 1427218 1427202	1186701-01	B10M Mk 2 vehicles B10MA Mk 2 and Mk 3 vehicles City Bus Diaphragm 234100K
	Brake Chamber (Type 30) 	3027758	1185225	1186702-01	Mk 3 vehicles up to Chassis 26793 and City Bus Diaphragm 234101K
	Brake Chamber (Type 30) 	1077718 1081461 3035900	MGM 1430223 1430202	1186702-01	Mk 3 from Chassis 26794 and Mk 4 vehicles Diaphragm 234101K
	Brake Chamber (Type 30) 	1575981	295514		M22 port, 5/8" UNF push rod Volvo only Diaphragm 234101K

NOTE: X00 and X50 suffixes refer to Exchange Products which may be Remanufactured.

B10M/MA Mk 1, 2, 3 & 4







VOLVO

4 x 2, Artic & City Bus (double deck)

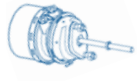
See Notes on Chassis Nos. for different
Marks at the end of this section

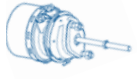
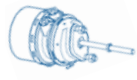
Mechanical & Air Suspension

Bodied by Alexander (PS and Q), Duple (300), East Lancs (Flyte), Jonckheere (Deauville and Jubilee), Northern Counties (Paladin), Plaxton (Excalibur, Expression, Paragon, Paramount and Premiere), Säfte and Van Hool (Alizee, Astral and Exeter)

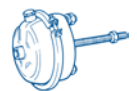









	Description	Volvo Part Number	OE Part Number	Replacement Knorr-Bremse Part No	Remarks Note: Left and Right refer to the side of the vehicle when viewed from the driver's seat facing forward.
B10M Rear Axle	Spring Brake (Type 30/30) 	1608006	MGM 4130057 4131200	K2B1101X50	Mk 1, Mk 2, Mk 3 and Mk 4 vehicles and City Bus M16 ports, 5/8" UNF push rod Diaphragm 234101K
	Spring Brake (Type 30/30HF) 	20499852	Wabco 925 492 103 0		Mk 1, Mk 2, Mk 3 and Mk 4 vehicles and City Bus M22 ports, M16 push rod
B10MA Centre Axle	Spring Brake (Type 30/30) 	1608006	MGM 4130057 4131200	K2B1101X50	M16 ports, 5/8" UNF push rod Diaphragm 234101K
	Spring Brake (Type 30/30HF) 	20499852	Wabco 925 492 103 0		M22 ports, M16 push rod. Replaced by 20827662 because of camshaft failures
	Spring Brake (Type 30/24) 	20827662	Wabco 925 492 201 0		M16 ports, 5/8" UNF push rod Diaphragm 234101K
B10MA Rear Axle	Spring Brake (Type 30/30) 	1608006	MGM 4130057 4131200	K2B1101X50	B10MA Mk 3 and Mk 4 vehicles, 10.5 tonne drive axle M16 ports, 5/8" UNF push rod Diaphragm 234101K
	Spring Brake (Type 30/30HF) 	20499852	Wabco 925 492 103 0		B10MA Mk 3 and Mk 4 vehicles, 10.5 tonne drive axle M16 ports, M16 push rod
	Brake Chamber (Type 24) 	1194637	272098	295555 + Yoke 1185157	B10MA Mk 4 vehicles, 8.0 tonne steering axle Diaphragm 234100K Replaced by 9518358
	Brake Chamber (Type 24) 	9518358	MGM 1427218 1427202	1186701-01	B10MA Mk 4 vehicles, 8.0 tonne steering axle Diaphragm 234100K

See Notes on Chassis Nos. for different

Marks at the end of this section

Bodied by Alexander (PS and Q), Duple (300), East Lancs (Flyte), Jonckheere

(Deauville and Jubilee), Northern Counties (Paladin), Plaxton (Excalibur, Expression, Mechanical & Air Suspension Paragon, Paramount and Premiere), Säftele and Van Hool (Alizee, Astral and Exeter)

	Description		Volvo Part Number	OE Part Number	Replacement Knorr-Bremse Part No	Remarks Note: Left and Right refer to the side of the vehicle when viewed from the driver's seat facing forward.
Front Axle	Automatic Slack Adjuster		1135004	Haldex 70902 72667	KB2255	Early B10M vehicles and City Bus 140 mm hole centre Control arm 60 mm
	Automatic Slack Adjuster		1196321	Haldex 72166 72678	KB2275	Later vehicles 140 mm hole centre Control arm 100 mm
B10M Rear Axle	Automatic Slack Adjuster		1136432	Haldex 70909 72723	KB2285	Mk 1 and Mk 2 vehicles and City Bus, left side 15 mm offset, 134 mm hole centre
	Automatic Slack Adjuster		1136433	Haldex 70910 72724	KB2290	Mk 1 and Mk 2 vehicles and City Bus, right side 15 mm offset, 134 mm hole centre
	Automatic Slack Adjuster		1195461	Haldex 72782	KB2280	Mk 3 and Mk 4 vehicles, left side 15 mm offset, 145 mm hole centre
	Automatic Slack Adjuster		1195462	Haldex 72783	KB2300	Mk 3 and Mk 4 vehicles, right side 15 mm offset, 145 mm hole centre
B10MA Centre Axle	Automatic Slack Adjuster		1195461	Haldex 72782	KB2280	Left side 15 mm offset, 145 mm hole centre
	Automatic Slack Adjuster		1195462	Haldex 72783	KB2300	Right side 15 mm offset, 145 mm hole centre
B10MA Rear Axle	Automatic Slack Adjuster		1196321	Haldex 72166 72678	KB2275	8.0 tonne steering axle 140 mm hole centre
	Automatic Slack Adjuster		1195461	Haldex 72782	KB2280	10.5 tonne axle, left side 15 mm offset, 145 mm hole centre
	Automatic Slack Adjuster		1195462	Haldex 72783	KB2300	10.5 tonne drive axle, right side 15 mm offset, 145 mm hole centre

NOTE: X00 and X50 suffixes refer to Exchange Products which may be Remanufactured.

B10M/MA Mk 1, 2, 3 & 4

VOLVO

4 x 2, Artic & City Bus (double deck)

Mechanical & Air Suspension

Bodied by Alexander (PS and Q), Duple (300), East Lancs (Flyte), Jonckheere (Deauville and Jubilee), Northern Counties (Paladin), Plaxton (Excalibur, Expression, Paragon, Paramount and Premiere), Säfte and Van Hool (Alizee, Astral and Exeter)

NOTES

1. Chassis Designations:

<u>Chassis No.</u>	<u>Vehicle Mark</u>
0001 - 11499	Mk 1
11500 - 20000	Mk 2
20001 - 30000	Mk 3 (double deck version is the City Bus)
40000 upward	Mk 4 built in Sweden
60000 upward	Mk 4 built in Scotland







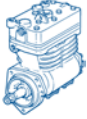
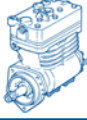
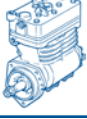
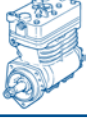

2. References quoting “up to/from Chassis 4..... and 6.....” show the vehicles built in the two locations.
3. The Compressor fitted depends on the engine, suspension and whether the vehicle is articulated. It is important to identify the correct Compressor from the data on the plate affixed to the ‘non-driven’ end.
4. In some instances Volvo recommended the removal of the Load Sensing Valve and its replacement with Relay Valve 1082666 for which AC574AXY is the replacement.

Only the best will do! -
Knorr Bremse genuine
parts

Bodied by Berkhof (Axial), Caetano (Levante), Irizar (Intercentury), Jonckheere (Mistral), Plaxton (Panther and Paragon) and Van Hool (Alizee and Astromega)

4 x 2, 6 x 2 & Artic

Air Suspension

Description	Volvo Part Number	OE Part Number	Replacement Knorr-Bremse Part No	Remarks <small>Note: Left and Right refer to the side of the vehicle when viewed from the driver's seat facing forward.</small>
Air Compressor (2W600R) 	70305894	LP4992 II38777F	LP4992 K002031000	5 bolt flange mounted. Without sump drain boss. Replaced by 70330006
Air Compressor (2W600R) 	70330006	LP4992 K000235	LP4992 K002031000	5 bolt flange mounted. Without sump drain boss. Replaced by 70330098
Air Compressor (2W600R) 	70330098	LP4992 K002031	LP4992 K002031000	5 bolt flange mounted. Without sump drain boss. Replaced by 20429343
Air Compressor (2W600R) 	20429343	LP4985 K000229	LP4985 K000229X00 or LP4992 K002031000 See Remarks	With sump drain boss. LP4992-K002031000 can be used when the no sump drain boss is required.
Air Compressor (2W704R) 	20770303	Wabco		
Air Dryer 	70313304	Haldex 87282	LA8219 II19483N00	11.0 bar cut-out
Air Dryer 	70369129	Haldex 93096	LA8219 II19483N00	11.0 bar cut-out
Air Dryer 	70313308	Haldex 89292 90548	LA8286 II39752F00	Low floor vehicles 12.0 bar cut-out Volvo heater connector
Air Dryer 	70369130	Haldex 93097	LA8286 II39752F00	Low floor vehicles 12.0 bar cut-out Volvo heater connector
Condenser 	20518595	Haldex 92793		
Condenser 	20745320	Haldex 92939		
Four Circuit Protection Valve 	3197588	AE4604 II36012	AE4604 II36012000	Has "Safety Feature"

NOTE: X00 and X50 suffixes refer to Exchange Products which may be Remanufactured.



B12B

4 x 2, 6 x 2 & Artic

Air Suspension



VOLVO

Bodied by Berkhof (Axial), Caetano (Levante), Irizar (Intercentury), Jonckheere (Mistral), Plaxton (Panther and Paragon) and Van Hool (Alizee and Astromega)

Description	Volvo Part Number	OE Part Number	Replacement Knorr-Bremse Part No	Remarks
Charging Valve with Limited Feedback 	1598426	Wabco 434 100 222 0	DR4260 K000634	6.2 bar, M22 ports
Charging Valve without Feedback 	8159736	0481063041000	DR4381 K000647	7.0 bar, M22 ports
Single Check Valve 	1571924	Wabco 434 023 000 0	KW4648/1	M22 ports
Single Check Valve 	1629982	Wabco 434 012 003 0	KW4455/1	M22 ports
Single Check Valve 	3028396 70313312			6 x 2 trailing axle M12(F)-M16(M) ports Fitted to Air Suspension Control Module
Hand Control Valve 	9515443	HB1143 I82171	HB1143 I82171N00	
Interlock Valve 	1580024	Wabco 434 205 026 0		"Broms" brake
EBS Dual Foot Valve 	70313316	0486200202000		Volvo only
EBS Dual Foot Valve 	70313353	K001974	K001974N00	
Double Check Valve 	9522564	Wabco 434 208 035 0	295358	M16 ports, bracket mounted
Relay Valve 	3173824	0481026032000	AC574AXY	AC574AXY has integral silencer
Quick Release Valve 	1588769	KX2196/1	KX2196/1	Supply port M22, delivery and exhaust ports M16 Replaced by 9518619

Bodied by Berkhof (Axial), Caetano (Levante), Irizar (Intercentury), Jonckheere (Mistral), Plaxton (Panther and Paragon) and Van Hool (Alizee and Astromega)

Air Suspension

Description	Volvo Part Number	OE Part Number	Replacement Knorr-Bremse Part No	Remarks Note: Left and Right refer to the side of the vehicle when viewed from the driver's seat facing forward.
Quick Release Valve 	9518619	Wabco 973 500 039 0	KX2000/1	All ports M22
Pressure Limiting Valve 	70305736	0481009071000	0481009014000 See Remarks	2.0 bar, M22 ports Door brake circuit Reset replacement valve to 2.0 bar
Pressure Proportioning Valve 	1082318	Wabco 473 301 002 0	DB2118 I86156	6 x 2 trailing axle Ratio 1.35:1
Pressure Switch 	20382505 20382509			
Pressure Switch 	20382514			'Gearbox to neutral during braking' system
Pressure Sensor 	20528336			For cab pressure gauges
Pressure Sensor 	20428459			
Pressure Sensor 	20514065			Air suspension system
Test Connector 	1592924	Wabco 463 703 120 0	KW4282/2	M16 thread
Test Connector 	1082480	KW3731/1	AC784D	M22 thread
Exhaust Silencer 	3943370	0484210005000	0484210005000	For Relay Valve Snap-on
Exhaust Silencer 	1197476	Wabco 432 407 060 0	SIL68B	For QRV and Suspension Control Modules M22 thread Alternative Silencers: 0484210001000 or ZB3150-I78074

NOTE: X00 and X50 suffixes refer to Exchange Products which may be Remanufactured.













B12B









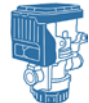

4 x 2, 6 x 2 & Artic

Air Suspension

VOLVO

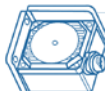
Bodied by Berkhof (Axial), Caetano (Levante), Irizar (Intercentury), Jonckheere (Mistral), Plaxton (Panther and Paragon) and Van Hool (Alizee and Astromega)

Description	Volvo Part Number	OE Part Number	Replacement Knorr-Bremse Part No	Remarks
Exhaust Silencer 	1079552	0484210017000	SIL68ASP	For Air Dryer Snap-on Replaced by 20467891 Alternative Silencers: 0484210017000 or ZB3163-192999
Exhaust Silencer 	20467891	Wabco 432 407 018 0	SIL68ASP	For Air Dryer Snap-on Alternative Silencers: 0484210017000 or ZB3163-192999
ABS Modulator 	20516342	BR9191 II41119F	BR9154 II17776N00	Front axle, with EBS. M22 Voss ports, DIN 72585 bayonet electrical connector
Wheel Speed Sensor 	20528660	Wabco 441 032 956 0		4 x 2 front and rear axles, left side
Wheel Speed Sensor 	20528661	Wabco 441 032 957 0		4 x 2 front and rear axles, right side
Wheel Speed Sensor 	20554956	Wabco 441 032 978 0		4 x 2 front and rear axles, left side
Wheel Speed Sensor 	20554957	Wabco 441 032 979 0		4 x 2 front and rear axles, right side
Wheel Speed Sensor 	70351557	Wabco 441 032 110 0		6 x 2 front axle
Wheel Speed Sensor 	20390737	Wabco 441 032 919 0		6 x 2 second and third axles
Wheel Speed Sensor 	20554956	Wabco 441 032 978 0		Artic front axle, left side
Wheel Speed Sensor 	20554957	Wabco 441 032 979 0		Artic front axle, right side
ABS Electronic Control Unit (Type D - ABS only) 	3943980	Wabco 446 004 423 0		

Description	Volvo Part Number	OE Part Number	Replacement Knorr-Bremse Part No	Remarks <small>Note: Left and Right refer to the side of the vehicle when viewed from the driver's seat facing forward.</small>
ABS Electronic Control Unit (Type C3 - ABS & ASR) 	3962455	Wabco 446 004 079 0		
EBS Axle Control Module (1 Channel) 	20374944 20542734	0486203033000		Front axle and 6 x 2 trailing axle without ABS Modulators Volvo only
EBS Axle Control Module (1 Channel) 	20570906 20828237	K000914	K000914N00	Front axle and 6 x 2 trailing axle with ABS Modulators (EBS5) & Artic trailer axle
EBS Axle Control Module (2 Channel) 	20374945 20542735	0486204025000		4 x 2 and 6 x 2 rear axle Volvo only
EBS Axle Control Module (2 Channel) 	20570910 20828241	K001411	K000922N00	4 x 2 and 6 x 2 rear axle Artic drive axle
EBS Electronic Control Unit (EBS5) 	20540723 20555374 20589475	0486106063000		4 x 2 Replacement ECU must be programmed before use Volvo only
EBS Electronic Control Unit (EBS5) 	20537336 70377449 70377486	0486106068000		6 x 2 and Artic Replacement ECU must be programmed before use Replaced by 20589476
EBS Electronic Control Unit (EBS5) 	20589476	0486106064000		6 x 2 and Artic Replacement ECU must be programmed before use Volvo only
Yaw Rate Sensor (ESP) 	3198467	0486020001000	0486020002N00	
Steering Angle Sensor (ESP) 	3198466	0486021001000	0486021001N00	
Electronic Stability Program (ESP) ECU 	20428758	0486108001000		Replaced by 20493818
Electronic Stability Program (ESP) ECU 	20493818	0486108004000		Volvo only







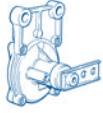
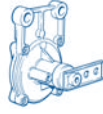
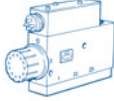
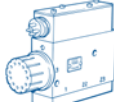
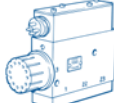

B12B

4 x 2, 6 x 2 & Artic

Air Suspension

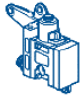
VOLVO













Bodied by Berkhof (Axial), Caetano (Levante), Irizar (Intercentury), Jonckheere (Mistral), Plaxton (Panther and Paragon) and Van Hool (Alizee and Astromega)

Description	Volvo Part Number	OE Part Number	Replacement Knorr-Bremse Part No	Remarks Note: Left and Right refer to the side of the vehicle when viewed from the driver's seat facing forward.
Air Suspension Level Sensor 	20514066	0504002107000	0504002112100	All axles Replaced by 20850557
Air Suspension Level Sensor 	20850557	K013741	K013741N00	All axles
Air Suspension Control Module 	9957009	0501100035000	0501100041100	Front axle With kneeling function
Air Suspension Control Module 	3944717	0501100014000	0501100029000	4 x 2, 6 x 2 and Artic drive axles
Air Suspension Control Module 	9955466	0501100037000		6 x 2 trailing axle Volvo only
Air Suspension Electronic Control Unit 	3118073 20503188			Replacement ECU must be programmed before use
Solenoid Valve 	1078316	Norgren-Herion 9041025374602400		Door brake and traction control systems
Solenoid Valve 	1610568	Norgren-Herion 9041001374302400		Exhaust pressure regulation control system
Exhaust Brake Control Valve 	20451967 20561888			
Clutch Servo 	8171721	Kongsberg KA627804	629277AM	
Clutch Servo 	8171722	Kongsberg KA627805	628494AM	
Clutch Master Cylinder 	1628218	FTE KG.28012.1.1		

Bodied by Berkhof (Axial), Caetano (Levante), Irizar (Intercentury), Jonckheere (Mistral), Plaxton (Panther and Paragon) and Van Hool (Alizee and Astromega)

4 x 2, 6 x 2 & Artic

Air Suspension

	Description	Volvo Part Number	OE Part Number	Replacement Knorr-Bremse Part No	Remarks <small>Note: Left and Right refer to the side of the vehicle when viewed from the driver's seat facing forward.</small>
Front Axle	Brake Chamber (Type 24) 	3177338 70330020	Wabco 423 506 070 0 423 506 121 0	<i>BS3532</i> K002420	Up to Chassis 753 On Meritor Disc Brake 15 mm push rod protrusion Diaphragm 234100K
	Brake Chamber (Type 24) 	3177339 70330019	Wabco 423 506 071 0 423 506 120 0	<i>BS2504</i> K002556	Up to Chassis 753 On Meritor Disc Brake 15 mm push rod protrusion Diaphragm 234100K
	Brake Chamber (Type 24) 	70369120	Wabco 423 506 123 0	<i>BS2504</i> K002556	Left side On Meritor Disc Brake 15 mm push rod protrusion Diaphragm 234100K
	Brake Chamber (Type 24) 	70369119	Wabco 423 506 124 0	<i>BS2504</i> K002556	Right side On Meritor Disc Brake 15 mm push rod protrusion Diaphragm 234100K
	Brake Chamber (Type 27) 	20512414	Wabco 423 509 020 0	<i>BS3570</i> K002162	Long wheelbase vehicles with non-independent suspension On Meritor Disc Brake 15 mm push rod protrusion
	Brake Chamber (Type 24) 	70330019	Wabco 423 506 120 0	<i>BS2504</i> K002556	Short wheelbase vehicles with non-independent suspension On Meritor Disc Brake 15 mm push rod protrusion
	Brake Chamber (Type 24) 	70330020	Wabco 423 506 121 0	<i>BS3532</i> K002420	Short wheelbase vehicles with non-independent suspension On Meritor Disc Brake 15 mm push rod protrusion
	Brake Chamber (Type 24) 	70306611	Wabco 423 106 202 0	1186701-01	Low floor vehicles with independent suspension On Meritor Disc Brake Diaphragm 234100K
Drive Axle	Spring Brake (Type 24/30) 	3177336	Wabco 925 461 471 0		Left side On Meritor Disc Brakes 15 mm push rod protrusion, with quick release wind-off feature
	Spring Brake (Type 24/30) 	3177337	Wabco 925 461 470 0		Right side On Meritor Disc Brakes 15 mm push rod protrusion, with quick release wind-off feature
	Spring Brake (Type 24/30) 	20527597	Wabco 925 481 103 0		Short wheelbase vehicles, pre-EBS, left side On Meritor Disc Brakes 15 mm push rod protrusion, with quick release wind-off feature
	Spring Brake (Type 24/30) 	20527614	Wabco 925 481 102 0		Short wheelbase vehicles, pre-EBS, right side On Meritor Disc Brakes 15 mm push rod protrusion, with quick release wind-off feature

NOTE: X00 and X50 suffixes refer to Exchange Products which may be Remanufactured.









B12B

4 x 2, 6 x 2 & Artic

Air Suspension









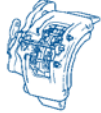
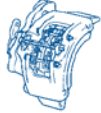

VOLVO

Bodied by Berkhof (Axial), Caetano (Levante), Irizar (Intercentury), Jonckheere (Mistral), Plaxton (Panther and Paragon) and Van Hool (Alizee and Astromega)

	Description	Volvo Part Number	OE Part Number	Replacement Knorr-Bremse Part No	Remarks <small>Note: Left and Right refer to the side of the vehicle when viewed from the driver's seat facing forward.</small>
Drive Axle (contd)	Spring Brake (Type 27/30) 	20512225	Wabco 925 489 101 0		Long wheelbase vehicles, pre-EBS, left side On Meritor Disc Brakes 15 mm push rod protrusion, with quick release wind-off feature
	Spring Brake (Type 27/30) 	20524515	Wabco 925 489 100 0		Long wheelbase vehicles, pre-EBS, right side On Meritor Disc Brakes 15 mm push rod protrusion, with quick release wind-off feature
	Spring Brake (Type 24/30) 	20527597	Wabco 925 481 103 0		Vehicles with EBS, left side On Meritor Disc Brakes 15 mm push rod protrusion, with quick release wind-off feature
	Spring Brake (Type 24/30) 	20527614	Wabco 925 481 102 0		Vehicles with EBS, right side On Meritor Disc Brakes 15 mm push rod protrusion, with quick release wind-off feature
6 x 2 Trailing Axle	Brake Chamber (Type 24) 	3177338	Wabco 423 506 070 0	<i>BS3532</i> K002420	Up to Chassis 753 On Meritor Disc Brake 15 mm push rod protrusion Diaphragm 234100K
	Brake Chamber (Type 24) 	3177339	Wabco 423 506 071 0	<i>BS2504</i> K002556	Up to Chassis 753 On Meritor Disc Brake 15 mm push rod protrusion Diaphragm 234100K
	Brake Chamber (Type 24) 	70330019	Wabco 423 506 120 0	<i>BS2504</i> K002556	On Meritor Disc Brake 15 mm push rod protrusion Diaphragm 234100K
	Brake Chamber (Type 24) 	70330020	Wabco 423 506 121 0	<i>BS3532</i> K002420	On Meritor Disc Brake 15 mm push rod protrusion Diaphragm 234100K
Artic Trailing Axle	Spring Brake (Type 24/24) 	20535924	Wabco 925 461 154 0		On Meritor Disc Brakes 15 mm push rod protrusion, stroke 75 mm

Bodied by Berkhof (Axial), Caetano (Levante), Irizar (Intercentury), Jonckheere (Mistral), Plaxton (Panther and Paragon) and Van Hool (Alizee and Astromega)

Air Suspension

	Description	Volvo Part Number	OE Part Number	Replacement Knorr-Bremse Part No	Remarks <small>Note: Left and Right refer to the side of the vehicle when viewed from the driver's seat facing forward.</small>
Front Axle	Air Disc Brake 	70330022	Meritor LRG592		Low floor vehicles with independent suspension, left side
	Air Disc Brake 	70330023	Meritor LRG593		Low floor vehicles with independent suspension, right side
	Disc Brake Pad Set 	85105485 20825594	Meritor MDP5061		
Front and Drive Axles	Air Disc Brake (Axial) 	20390670	Meritor LRG596		Left side up to Chassis 201
	Air Disc Brake (Axial) 	20390671	Meritor LRG597		Right side up to Chassis 201
	Air Disc Brake (Axial) 	20424074	Meritor		Left side from Chassis 202
	Air Disc Brake (Axial) 	20424075	Meritor		Right side from Chassis 202
	Disc Brake Pad Set 		Meritor		
6 x 2 Trailing Axle	Air Disc Brake (Axial) 	20424072	Meritor		Left side
	Air Disc Brake (Axial) 	20424073	Meritor		Right side
	Disc Brake Pad Set 	20918891	Meritor 5057		

NOTE: X00 and X50 suffixes refer to Exchange Products which may be Remanufactured.







B12B

4 x 2, 6 x 2 & Artic

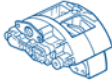
Air Suspension

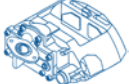
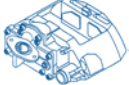







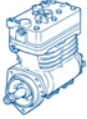
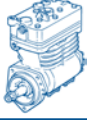

VOLVO

Bodied by Berkhof (Axial), Caetano (Levante), Irizar (Intercentury), Jonckheere (Mistral), Plaxton (Panther and Paragon) and Van Hool (Alizee and Astromega)

	Description	Volvo Part Number	OE Part Number	Replacement Knorr-Bremse Part No	Remarks Note: Left and Right refer to the side of the vehicle when viewed from the driver's seat facing forward.
6 x 2 Trailing Axle (contd)	Air Disc Brake (Axial) 	20424074	Meritor		Left side
	Air Disc Brake (Axial) 	20424075	Meritor		Right side
	Disc Brake Pad Set 		Meritor		
Artic Trailing Axle	Air Disc Brake (Radial) 	20535920	Meritor LRG669		Left side
	Air Disc Brake (Radial) 	20535921	Meritor LRG670		Right side
	Disc Brake Pad Set 	20976509	Meritor MDP5099		
	Brake Disc 	3112965			
	Brake Disc (Splined) 	3092710			Solid disc
	Brake Disc (Splined) 	85103803			Ventilated disc

Bodied by Berkhof (Axial), Caetano (Levante), Jonckheere (Mistral), Plaxton (Panther, Paragon and Profile), Sunsundegui (Sideral) and Van Hool (Alizee)

Air Suspension

Description	Volvo Part Number	OE Part Number	Replacement Knorr-Bremse Part No	Remarks Note: Left and Right refer to the side of the vehicle when viewed from the driver's seat facing forward.
Air Compressor (2W600R) 	70305891	LK4920 II39079F	LK4920 K002032000	5 bolt flange mounted Replaced by 70330092
Air Compressor (2W600R) 	70330092	LK4920 K002032	LK4920 K002032000	5 bolt flange mounted
Air Dryer 	3194898 70313304	Haldex 87282	LA8219 II19483N00	11.0 bar cut-out Replaced by 70313304
Air Dryer 	70369129	Haldex 93096	LA8219 II19483N00	11.0 bar cut-out
Condenser 	20745320	Haldex 92939		
Four Circuit Protection Valve 	1075765	AE4452 II31480	AE4452 II31480000	Up to Chassis 117
Four Circuit Protection Valve 	3197588	AE4604 II36012	AE4604 II36012000	From Chassis 118. Has "Safety Feature"
Charging Valve without Feedback 	3181897	Wabco 434 100 130 0	DR4381 K000647	Artic trailer 7.0 bar, M22 ports
Charging Valve without Feedback 	8159736	0481063041000	DR4381 K000647	7.0 bar, M22 ports
Single Check Valve 	1571924	Wabco 434 023 000 0	KW4648/1	M22 ports
Single Check Valve 	3028396 70313312			6 x 2 trailing axle M12(F)-M16(M) ports Fitted to Air Suspension Control Module
Hand Control Valve 	9515443	HB1143 I82171	HB1143 I82171N00	

NOTE: X00 and X50 suffixes refer to Exchange Products which may be Remanufactured.

B12M & B12MA

VOLVO

4 x 2, 6 x 2 & Artic













Air Suspension

Bodied by Berkhof (Axial), Caetano (Levante), Jonckheere (Mistral), Plaxton (Panther, Paragon and Profile), Sunsundegui (Sideral) and Van Hool (Alizee)

Description	Volvo Part Number	OE Part Number	Replacement Knorr-Bremse Part No	Remarks Note: Left and Right refer to the side of the vehicle when viewed from the driver's seat facing forward.
Interlock Valve 	1580024	Wabco 434 205 026 0		"Broms" brake
Dual Foot Valve 	9958670 70301712	Wabco 461 318 603 0		With D7C engine Replaced by 70313310
Dual Foot Valve 	70313349	Wabco 461 318 608 0		With D7C engine Replaced by 70313310
Dual Foot Valve 	70313310	Wabco 461 318 604 0		With D7C engine
Dual Foot Valve 	8365045			With pendant pedal With Telma retarder
EBS Dual Foot Valve 	70313316	0486200202000		Volvo only
EBS Dual Foot Valve 	70313353	K001974	K001974N00	
Double Check Valve 	9522564	Wabco 434 208 035 0	295358	M16 ports, bracket mounted
Trailer Control Valve 	1589025	0481061020000	0481061020000	B12MA Artic
Relay Valve 	3173824	0481026032000	AC574AXY	AC574AXY has integral silencer
Quick Release Valve 	1588769	KX2196/1	KX2196/1	Supply port M22, delivery and exhaust ports M16 Replaced by 9518619
Quick Release Valve 	9518619	Wabco 973 500 039 0	KX2000/1	All ports M22

Bodied by Berkhof (Axial), Caetano (Levante), Jonckheere (Mistral), Plaxton (Panther, Paragon and Profile), Sunsundegui (Sideral) and Van Hool (Alizee)

Air Suspension

Description		Volvo Part Number	OE Part Number	Replacement Knorr-Bremse Part No	Remarks Note: Left and Right refer to the side of the vehicle when viewed from the driver's seat facing forward.
Pressure Limiting Valve		1606720	0481009040000	0481009047000	7.5 bar, M22 ports
Pressure Limiting Valve		20382312	Wabco 475 015 063 0	AC156B	Front axle air suspension 8.5 bar, M16 ports
Pressure Limiting Valve		70305736	0481009071000	0481009014000 See Remarks	2.0 bar, M22 ports Door brake circuit Reset replacement valve to 2.0 bar
Pressure Proportioning Valve		1082318	Wabco 473 301 002 0	DB2118 I86156	6 x 2 trailing axle Ratio 1.35:1
Pressure Switch		20382505 20382509			
Pressure Switch		20382514			Gearbox to neutral system during braking
Pressure Sensor		20528336 20829689			For cab pressure gauges
Pressure Sensor		8158821			Air suspension system
Pressure Sensor		3173630	0484205007000	0484205007000	Air suspension system
Pressure Relief (Safety) Valve		1622431	KX1729/2	KX1729/2	10 bar, M16 thread
Pressure Relief (Safety) Valve		1607454			18 bar, M16 thread Volvo only
Tilt Drain Valve		1081328	Wabco 934 300 033 0	KW2350/2	M22 thread

NOTE: X00 and X50 suffixes refer to Exchange Products which may be Remanufactured.











B12M & B12MA

VOLVO

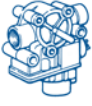
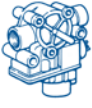
4 x 2, 6 x 2 & Artic













Air Suspension

Bodied by Berkhof (Axial), Caetano (Levante), Jonckheere (Mistral), Plaxton (Panther, Paragon and Profile), Sunsundegui (Sideral) and Van Hool (Alizee)

Description	Volvo Part Number	OE Part Number	Replacement Knorr-Bremse Part No	Remarks Note: Left and Right refer to the side of the vehicle when viewed from the driver's seat facing forward.
Test Connector 	1592924	Wabco 463 703 120 0	KW4282/2	M16 thread
Test Connector 	1082480	KW3731/1	AC784D	M22 thread
Exhaust Silencer 	3943370	0484210005000	0484210005000	For Foot Valve and Relay Valve Snap-on
Exhaust Silencer 	1197476	Wabco 432 407 060 0	SIL68B	For QRV and Suspension Control Modules M22 thread Alternative Silencers: 0484210001000 or ZB3150-I78074
ABS Modulator 	9959212	Wabco 472 195 058 0	BR9182 II38665F	All axles with ABS only. M22 ports, DIN 72585 bayonet electrical connector
ABS Modulator 	20516342	BR9191 II41119F	BR9154 II17776N00	Front axle, with EBS. M22 Voss ports, DIN 72585 bayonet electrical connector
Wheel Speed Sensor 	3987936	Wabco 441 032 838 0		4 x 2 and 6 x 2 with S-cam Brakes, all axles, both sides 90° sensor, cable length 1.54 m
Wheel Speed Sensor 	9955936	Wabco 441 032 800 0 441 032 801 0		Artic with S-cam Brakes, all axles, both sides 90° sensor, cable length 2.265 m
Wheel Speed Sensor 	20390737	Wabco 441 032 919 0		4 x 2, 6 x 2 and Artic with Disc Brakes, all axles, both sides Straight sensor, cable length 1.7 m
ABS Electronic Control Unit (Type D - ABS only) 	3197782 3943980	Wabco 446 004 423 0		4S4M system
ABS Electronic Control Unit (Type C3 - ABS & ASR) 	3962455	Wabco 446 004 079 0		4S4M system

Bodied by Berkhof (Axial), Caetano (Levante), Jonckheere (Mistral), Plaxton (Panther, Paragon and Profile), Sunsundegui (Sideral) and Van Hool (Alizee)

Air Suspension

Description	Volvo Part Number	OE Part Number	Replacement Knorr-Bremse Part No	Remarks <small>Note: Left and Right refer to the side of the vehicle when viewed from the driver's seat facing forward.</small>
EBS Axle Control Module (1 Channel) 	20374944 20542734	0486203033000		Front axle and 6 x 2 trailing axle without ABS Modulators Volvo only
EBS Axle Control Module (1 Channel) 	20570906 20828237	K000914	K000914N00	Front axle and 6 x 2 trailing axle with ABS Modulators (EBS5)
EBS Axle Control Module (1 Channel) 	20570906 20828237	K000914	K000914N00	Artic trailer axle
EBS Axle Control Module (2 Channel) 	20374945 20542735	0486204025000		4 x 2 and 6 x 2 rear axle Volvo only
EBS Axle Control Module (2 Channel) 	20570910 20828241	K001411	K000922N00	4 x 2 and 6 x 2 rear axle Artic drive axle
EBS Electronic Control Unit (EBS5) 	20540723 20555374 20589475	0486106063000		4 x 2 Replacement ECU must be programmed before use Volvo only
EBS Electronic Control Unit (EBS5) 	20537336 70377449 70377486	0486106068000		6 x 2 and Artic Replacement ECU must be programmed before use Replaced by 20589476
EBS Electronic Control Unit (EBS5) 	20589476	0486106064000		6 x 2 and Artic Replacement ECU must be programmed before use Volvo only
Yaw Rate Sensor (ESP) 	3198467	0486020001000	0486020002N00	
Steering Angle Sensor (ESP) 	3198466	0486021001000	0486021001N00	
Electronic Stability Program (ESP) ECU 	20428758	0486108001000		Replaced by 20493818
Electronic Stability Program (ESP) ECU 	20493818	0486108004000		Volvo only

NOTE: X00 and X50 suffixes refer to Exchange Products which may be Remanufactured.





B12M & B12MA

VOLVO

4 x 2, 6 x 2 & Artic

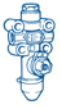
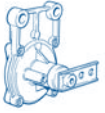
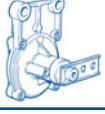
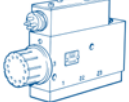
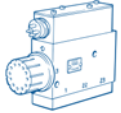
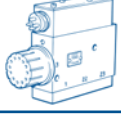

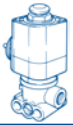
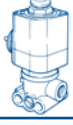

Air Suspension

Bodied by Berkhof (Axial), Caetano (Levante), Jonckheere (Mistral), Plaxton (Panther, Paragon and Profile), Sunsundegui (Sideral) and Van Hool (Alizee)

Description	Volvo Part Number	OE Part Number	Replacement Knorr-Bremse Part No	Remarks
Air Suspension Levelling Valve 	20356526	SV1295 I85698	SV1295 I85698	Front and rear axles
Air Suspension Level Sensor 	8144352 20514066	0504002107000	0504002112100	All axles Replaced by 20850557
Air Suspension Level Sensor 	20850557	K013741	K013741N00	All axles
Air Suspension Control Module 	9957009	0501100035000	0501100041100	Front axle With kneeling function
Air Suspension Control Module 	3944717	0501100014000	0501100029000	4 x 2, 6 x 2 and Artic drive axles
Air Suspension Control Module 	9955466	0501100037000		6 x 2 trailing axle Volvo only
Air Suspension Electronic Control Unit 	3118073 20503188			Replacement ECU must be programmed before use
Solenoid Valve 	1078316	Norgren-Herion 9041025374602400		Door brake system
Solenoid Valve 	1610568	Norgren-Herion 9041001374302400		For exhaust pressure regulation control system
Solenoid Valve 	1610566	Norgren-Herion 9042006374302400		For engine stop control
Solenoid Valve 	9515215	Wabco 472 137 132 0		Traction control (ASR) Normally 'Closed', M12 ports, Volvo electrical connector

Bodied by Berkhof (Axial), Caetano (Levante), Jonckheere (Mistral), Plaxton (Panther, Paragon and Profile), Sunsundegui (Sideral) and Van Hool (Alizee)

Air Suspension

Description	Volvo Part Number	OE Part Number	Replacement Knorr-Bremse Part No	Remarks Note: Left and Right refer to the side of the vehicle when viewed from the driver's seat facing forward.
Exhaust Brake Control Valve 	20451967 20561888			
Clutch Servo 	1655435	Kongsberg KA622090	626639AM	With G7 gearbox
Clutch Servo 	1671953	Kongsberg KA626639	626639AM	With G8 gearbox
Clutch Servo 	1655639	Kongsberg KA622080	626392AM	Replaced by 1673067
Clutch Servo 	1673067	Kongsberg KA622050	626392AM	
Clutch Servo 	3192126	Kongsberg KA627208	629276AM	Replaced by 8171721
Clutch Servo 	8171721	Kongsberg KA627804	629277AM	
Clutch Servo 	3192977	Kongsberg KA627303	628494AM	Replaced by 8171722
Clutch Servo 	8171722	Kongsberg KA627805	628494AM	
Clutch Master Cylinder 	1628218	FTE KG.28012.1.1		

NOTE: X00 and X50 suffixes refer to Exchange Products which may be Remanufactured.







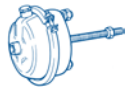
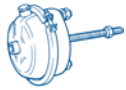

B12M & B12MA

VOLVO

4 x 2, 6 x 2 & Artic









Bodied by Berkhof (Axial), Caetano (Levante), Jonckheere (Mistral), Plaxton (Panther, Paragon and Profile), Sunundegui (Sideral) and Van Hool (Alizee)

Air Suspension

	Description	Volvo Part Number	OE Part Number	Replacement Knorr-Bremse Part No	Remarks Note: Left and Right refer to the side of the vehicle when viewed from the driver's seat facing forward.
Front Axle with Drum Brakes	Brake Chamber (Type 30) 	3035900	MGM 1430223 1430202	1186702-01	Up to Chassis 1128 With S-cam Brakes Diaphragm 234101K
	Brake Chamber (Type 30) 	20504557	1186702-01	1186702-01	From Chassis 1129 With S-cam Brakes Diaphragm 234101K
Front Axle with Disc Brakes	Brake Chamber (Type 24) 	3177339	Wabco 423 506 071 0	BS2504 K002556	Up to Chassis 598 with non-independent suspension On Meritor Disc Brake 15 mm push rod protrusion Diaphragm 234100K
	Brake Chamber (Type 24) 	70330019	Wabco 423 506 120 0	BS2504 K002556	From Chassis 599 with non-independent suspension On Meritor Disc Brake 15 mm push rod protrusion
	Brake Chamber (Type 24) 	3177338	Wabco 423 506 070 0	BS3532 K002420	Up to Chassis 598 with independent suspension On Meritor Disc Brake 15 mm push rod protrusion Diaphragm 234100K
	Brake Chamber (Type 24) 	70330020	Wabco 423 506 121 0	BS3532 K002420	From Chassis 599 with independent suspension On Meritor Disc Brake 15 mm push rod protrusion
Rear Axle with Drum Brakes	Spring Brake (Type 30/30) 	1608006	MGM 4130057 4131200	K2B1101X50	Up to Chassis 1158 With Drum Brakes M16 ports, 5/8" UNF push rod Diaphragm 234101K
	Spring Brake (Type 30/30HF) 	20499852	Wabco 925 492 103 0		From Chassis 1159 With Drum Brakes. M22 ports, M16 push rod
Rear Axle with Disc Brakes	Spring Brake (Type 24/30) 	3177336	Wabco 925 461 471 0		Left side On Meritor Disc Brakes 15 mm push rod protrusion, with quick release wind-off feature
	Spring Brake (Type 24/30) 	3177337	Wabco 925 461 470 0		Right side On Meritor Disc Brakes 15 mm push rod protrusion, with quick release wind-off feature

Bodied by Berkhof (Axial), Caetano (Levante), Jonckheere (Mistral), Plaxton (Panther, Paragon and Profile), Sunsundegui (Sideral) and Van Hool (Alizee)

Air Suspension

	Description	Volvo Part Number	OE Part Number	Replacement Knorr-Bremse Part No	Remarks Note: Left and Right refer to the side of the vehicle when viewed from the driver's seat facing forward.
6 x 2 Trailing Axle	Brake Chamber (Type 24) 	3177339	Wabco 423 506 071 0	<i>BS2504</i> K002556	Up to Chassis 598 with non-independent suspension On Meritor Disc Brake 15 mm push rod protrusion Diaphragm 234100K
	Brake Chamber (Type 24) 	70330019	Wabco 423 506 120 0	<i>BS2504</i> K002556	From Chassis 599 with non-independent suspension On Meritor Disc Brake 15 mm push rod protrusion
	Brake Chamber (Type 24) 	3177338	Wabco 423 506 070 0	<i>BS3532</i> K002420	Up to Chassis 598 with independent suspension On Meritor Disc Brake 15 mm push rod protrusion Diaphragm 234100K
	Brake Chamber (Type 24) 	70330020	Wabco 423 506 121 0	<i>BS3532</i> K002420	From Chassis 599 with independent suspension On Meritor Disc Brake 15 mm push rod protrusion
Artic Trailing Axle with Drum Brakes	Spring Brake (Type 30/30HF) 	20499852	Wabco 925 492 103 0		With Drum Brakes. M22 ports, M16 push rod. Replaced by 20827662 because of camshaft failures
	Spring Brake (Type 30/24) 	20827662	Wabco 925 492 201 0		With Drum Brakes M16 ports, 5/8" UNF push rod Diaphragm 234101K
Artic Trailing Axle with Disc Brakes	Spring Brake (Type 24/24) 	20522028 20522029	Wabco 925 481 050 0 925 481 051 0		8.0 tonne axle On Meritor Disc Brakes 15 mm push rod protrusion CAUTION: ports are 'handed' on these units
	Spring Brake (Type 24/30) 	3177336	Wabco 925 461 471 0		10.5 tonne axle, left side On Meritor Disc Brakes 15 mm push rod protrusion, with quick release wind-off feature
	Spring Brake (Type 24/30) 	3177337	Wabco 925 461 470 0		10.5 tonne axle, right side On Meritor Disc Brakes 15 mm push rod protrusion, with quick release wind-off feature

NOTE: X00 and X50 suffixes refer to Exchange Products which may be Remanufactured.









B12M & B12MA

VOLVO

4 x 2, 6 x 2 & Artic













Bodied by Berkhof (Axial), Caetano (Levante), Jonckheere (Mistral), Plaxton (Panther, Paragon and Profile), Sunsundegui (Sideral) and Van Hool (Alizee)

Air Suspension

	Description		Volvo Part Number	OE Part Number	Replacement Knorr-Bremse Part No	Remarks <small>Note: Left and Right refer to the side of the vehicle when viewed from the driver's seat facing forward.</small>
Front Axle	Automatic Slack Adjuster		1196322	Haldex 72167 72726	KB2295	152 mm hole centre
Rear Axle	Automatic Slack Adjuster		1195461	Haldex 72782	KB2280	Short wheelbase vehicles Left side 15 mm offset, 145 mm hole centre
	Automatic Slack Adjuster		1195462	Haldex 72783	KB2300	Short wheelbase vehicles Right side 15 mm offset, 145 mm hole centre
	Automatic Slack Adjuster		1195465	Haldex 72784	KB3140	Long wheelbase vehicles Left side 15 mm offset, 165 mm hole centre
	Automatic Slack Adjuster		1195466	Haldex 72785	KB3135	Long wheelbase vehicles Right side 15 mm offset, 165 mm hole centre
	Automatic Slack Adjuster		1197965	Haldex 72784	KB3140	Long wheelbase vehicles Left side 15 mm offset, 165 mm hole centre
Artic Trailing Axle	Automatic Slack Adjuster		1197966	Haldex 72785	KB3135	Long wheelbase vehicles Right side 15 mm offset, 165 mm hole centre

Bodied by Berkhof (Axial), Caetano (Levante), Jonckheere (Mistral), Plaxton (Panther, Paragon and Profile), Sunsundegui (Sideral) and Van Hool (Alizee)

Air Suspension

	Description	Volvo Part Number	OE Part Number	Replacement Knorr-Bremse Part No	Remarks <small>Note: Left and Right refer to the side of the vehicle when viewed from the driver's seat facing forward.</small>
Front Axle	Air Disc Brake 	20424072	Meritor		With non-independent suspension Left side
	Air Disc Brake 	20424073	Meritor		With non-independent suspension Right side
	Disc Brake Pad Set 	20918891	Meritor MDP5057		
	Air Disc Brake 	20424074	Meritor		With independent suspension Left side
	Air Disc Brake 	20424075	Meritor		With independent suspension Right side
	Disc Brake Pad Set 		Meritor		
	Air Disc Brake 	21024417	Meritor		Left side
	Air Disc Brake 	21024419	Meritor		Right side
	Disc Brake Pad Set 	21024702	Meritor		
Drive Axle	Air Disc Brake 	20424072	Meritor		Left side
	Air Disc Brake 	20424073	Meritor		Right side
	Disc Brake Pad Set 	20918891	Meritor MDP5057		

NOTE: X00 and X50 suffixes refer to Exchange Products which may be Remanufactured.



B12M & B12MA

VOLVO

4 x 2, 6 x 2 & Artic







Air Suspension

Bodied by Berkhof (Axial), Caetano (Levante), Jonckheere (Mistral), Plaxton (Panther, Paragon and Profile), Sunsundegui (Sideral) and Van Hool (Alizee)

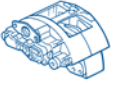
	Description	Volvo Part Number	OE Part Number	Replacement Knorr-Bremse Part No	Remarks <small>Note: Left and Right refer to the side of the vehicle when viewed from the driver's seat facing forward.</small>
6 x 2 Trailing Axle	Air Disc Brake 	20424072	Meritor		Left side
	Air Disc Brake 	20424073	Meritor		Right side
	Disc Brake Pad Set 	20918891	Meritor MDP5057		
	Air Disc Brake 	21024417	Meritor		Left side
	Air Disc Brake 	21024419	Meritor		Right side
	Disc Brake Pad Set 	21024702	Meritor		
Artic Trailing Axle	Air Disc Brake 	20424070	Meritor LRG598		8.0 tonne axle Left side
	Air Disc Brake 	20424071	Meritor LRG599		8.0 tonne axle Right side
	Disc Brake Pad Set 		Meritor		
	Air Disc Brake 	21024421	Meritor		8.0 tonne axle Left side
	Air Disc Brake 	21024422	Meritor		8.0 tonne axle Right side
	Disc Brake Pad Set 		Meritor		

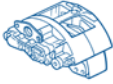







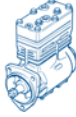

Bodied by Berkhof (Axial), Caetano (Levante), Jonckheere (Mistral), Plaxton (Panther, Paragon and Profile), Sunsundegui (Sideral) and Van Hool (Alizee)

Air Suspension









	Description	Volvo Part Number	OE Part Number	Replacement Knorr-Bremse Part No	Remarks Note: Left and Right refer to the side of the vehicle when viewed from the driver's seat facing forward.
Artic Trailing Axle (Contd)	Air Disc Brake 	20424072	Meritor		10.5 tonne axle Left side
	Air Disc Brake 	20424073	Meritor		10.5 tonne axle Right side
	Disc Brake Pad Set 	20918891	Meritor MDP5057		
	Air Disc Brake 	21024417	Meritor		10.5 tonne axle Left side
	Air Disc Brake 	21024419	Meritor		10.5 tonne axle Right side
	Disc Brake Pad Set 	21024702	Meritor		
	Brake Disc (Splined) 	3092710			Solid disc
	Brake Disc (Splined) 	85103803			Ventilated disc



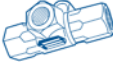

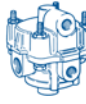



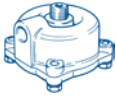

NOTE: X00 and X50 suffixes refer to Exchange Products which may be Remanufactured.



**Invest in the best,
fit only genuine parts
from Knorr-Bremse**





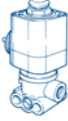

Description	Volvo Part Number	OE Part Number	Replacement Knorr-Bremse Part No	Remarks <small>Note: Left and Right refer to the side of the vehicle when viewed from the driver's seat facing forward.</small>
Air Compressor (2W440R) 	1613632	LP4813 I90499	LP4813 I90499X50	3 bolt flange mounted On Volvo engine
Air Compressor		Cummins 3067469		On Cummins engine
Governor Valve (D2) 	1193532 3944255	267100	1189394000	8.1 bar cut-out, M10 ports
Governor Valve (D2) 	3126287	1189395	1189395000	8.5 bar cut-out, M10 ports
Air Dryer (AD2) 	1599631	267113	267121X50	
In-line Filter 	1591031	Wabco 432 500 000 0	LA2103 I99660	M22 ports
Four Circuit Protection Valve 	3018549	AE4405 I89408	AE4405 I89408000	
Single Circuit Protection Valve 	3113259	KW4081/1	KW4081/1	
Single Check Valve 	1571924	Wabco 434 023 000 0	KW4648/1	M22 ports
Hand Control Valve 	9515443	HB1143 I82171	HB1143 I82171N00	
Interlock Valve 	1580024	Wabco 434 205 026 0		"Broms" brake
Dual Foot Valve 	3028742	Wabco 461 324 018 0		Without pneumatic retarder control for ZF HP500 gearbox

NOTE: X00 and X50 suffixes refer to Exchange Products which may be Remanufactured.

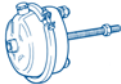
Description	Volvo Part Number	OE Part Number	Replacement Knorr-Bremse Part No	Remarks <small>Note: Left and Right refer to the side of the vehicle when viewed from the driver's seat facing forward.</small>
Dual Foot Valve 	3028743	Wabco 461 318 005 0		With microswitch retarder control for Voith gearbox
Dual Foot Valve 	3177975	Wabco 461 318 030 0		With microswitch retarder control for Voith gearbox
Dual Foot Valve 	8365045			With pendant pedal With Telma retarder
Double Check Valve 	1505044	295358	295358	M16 ports, bracket mounted
Double Check Valve 	9522564	Wabco 434 208 035 0	295358	M16 ports, bracket mounted
Relay Valve 	1082666	Wabco 973 011 000 0	AC574AXY	Replaced by 3173824 AC574AXY has integral silencer
Relay Valve 	3173824	0481026032000	AC574AXY	AC574AXY has integral silencer
Quick Release Valve 	1588769	KX2196/1	KX2196/1	Up to Chassis 26576 Supply port M22, delivery and exhaust ports M16
Quick Release Valve 	9518619	Wabco 973 500 039 0 973 500 044 0	KX2000/1	From Chassis 26577 M22 Voss ports
Low Pressure Switch 	20382508			Front air suspension 5.4 bar
Low Pressure Switch 	1594236 3987498			
Pressure Relief (Safety) Valve 	1622431	KX1729/2	KX1729/2	10 bar, M16 thread In Air Dryer

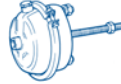







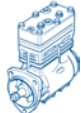
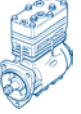
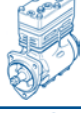

Description	Volvo Part Number	OE Part Number	Replacement Knorr-Bremse Part No	Remarks <small>Note: Left and Right refer to the side of the vehicle when viewed from the driver's seat facing forward.</small>
Tilt Drain Valve 	1081328	Wabco 934 300 033 0	KW2350/2	M22 thread
Automatic Drain Valve 	1607503	KX2068/7V	KX2068/7000	M16 side and top ports (side port plugged)
Test Connector 	1592924	Wabco 463 703 120 0	KW4282/2	M16 thread
Exhaust Silencer 	3028744	Wabco 432 407 010 0	0484210005000	For Foot Valve and Relay Valve Snap-on
Exhaust Silencer 	3943370	0484210005000	0484210005000	For Foot Valve and Relay Valve Snap-on
ABS Modulator 	1609241	Wabco 472 195 002 0		M22 ports, Volvo electrical connector Replaced by 9520836
ABS Modulator 	9520836	Wabco 472 195 051 0		M22 ports, Volvo electrical connector
Wheel Speed Sensor 	9955937	Wabco 441 032 800 0		90° sensor, cable length 2.265 m Replaced by 20490824
Wheel Speed Sensor 	20490824	Wabco 441 032 964 2		
ABS Electronic Control Unit (Type C3, ABS + ASR) 	3943981	Wabco 446 004 079 0		
Air Suspension Levelling Valve 	3036548	SV1412 I98292	SV1412 K000073	
Damping Valve	3116916			Front axle air suspension

Description	Volvo Part Number	OE Part Number	Replacement Knorr-Bremse Part No	Remarks Note: Left and Right refer to the side of the vehicle when viewed from the driver's seat facing forward.
Solenoid Valve 	9515215	Wabco 472 137 132 0		M12 ports, Volvo electrical connector Traction control (ASR)
Solenoid Valve 	8158342	Norgren-Herion 9041005374302400		
Solenoid Valve 	3962640 3986621	Norgren-Herion 9042006374302400		Throttle control
Engine Stop Cylinder 	3979028			

Front Axle	Brake Chamber (Type 30) 	1605736	272094	1186702-01	Left side, up to Chassis 28856 On Z-cam Brakes Diaphragm 234101K
	Brake Chamber (Type 30) 	1614661	1185177	1186702-01	Right side, up to Chassis 28856 On Z-cam Brakes Diaphragm 234101K
	Brake Chamber (Type 30) 	3987120 3036656	MGM 1430202	1186702-01	From Chassis 28857 On Z-cam Brakes Diaphragm 234101K
Rear Axle	Spring Brake (Type 30-80) 	3117314	K2B1097	K2B1097X50	Left side, up to Chassis 28856 On Z-cam Brakes Diaphragm 234101K
	Spring Brake (Type 30-80) 	3117313	K2B1096	K2B1096X50	Right side, up to Chassis 28856 On Z-cam Brakes Diaphragm 234101K
	Spring Brake (Type 30/30) 	1066850 70330015	MGM 4130063	K2B0521X50	Left side, from Chassis 28857 On Z-cam Brakes Diaphragm 234101K
	Spring Brake (Type 30/30) 	1066849	MGM 4130063	K2B0521X50	Right side, from Chassis 28857 On Z-cam Brakes Diaphragm 234101K

Bodied by Alexander (ALX500) and Wrightbus (Explorer)

Air Suspension

Description	Volvo Part Number	OE Part Number	Replacement Knorr-Bremse Part No	Remarks <small>Note: Left and Right refer to the side of the vehicle when viewed from the driver's seat facing forward.</small>
Air Compressor (2W600R) 	70303446	LP4996 II38845F	LK4921 K001268000	Early vehicles 3 bolt flange mounted Replaced by 70305892
Air Compressor (2W600R) 	70305892	LK4921 II39080F	LK4921 K001268000	3 bolt flange mounted Replaced by 70330004
Air Compressor (2W600R) 	70330004	LK4921 K000233	LK4921 K001268000	3 bolt flange mounted Replaced by 70330094
Air Compressor (2W600R) 	70330094	LK4921 K001268	LK4921 K001268000	3 bolt flange mounted
Air Dryer 	3197854 20392573	Haldex 78890	LA8286 II39752F00	12.0 bar cut-out LA8286-II39752F has a heater which is not needed - leave disconnected. Replaced by 70313308
Air Dryer 	70313308	Haldex 89292 90548	LA8286 II39752F00	12.0 bar cut-out LA8286-II39752F has a heater which is not needed - leave disconnected.
In-line Filter 	1591031	Wabco 432 500 000 0	LA2103 I99660	M22 ports
Four Circuit Protection Valve 	3018549	AE4405 I89408	AE4405 I89408000	
Charging Valve without Feedback 	8159736	0481063041000	DR4381 K000647	7.0 bar, M22 ports
Single Check Valve 	1626982	Wabco 434 012 003 0	KW4455/1	M22 ports
Single Check Valve 	1629727	KW5271/1	KW4455/1	M22 ports
Hand Control Valve 	9515443	HB1143 I82171	HB1143 I82171N00	

NOTE: X00 and X50 suffixes refer to Exchange Products which may be Remanufactured.











Super Olympian (B10TL)

VOLVO

6 x 2

Bodied by Alexander (ALX500) and Wrightbus (Explorer)

Air Suspension

Description	Volvo Part Number	OE Part Number	Replacement Knorr-Bremse Part No	Remarks <small>Note: Left and Right refer to the side of the vehicle when viewed from the driver's seat facing forward.</small>
Interlock Valve 	1580024	Wabco 434 205 026 0		"Broms" brake
Dual Foot Valve 	3118798	Wabco 461 324 042 0		Without pneumatic retarder control for ZF HP500 gearbox
Dual Foot Valve 	3177975	Wabco 461 318 030 0		With microswitch retarder control for Voith gearbox
Double Check Valve 	9522564	Wabco 434 208 035 0	295358	M16 ports, bracket mounted
Relay Valve 	3173824	0481026032000	AC574AXY	AC574AXY has integral silencer
Quick Release Valve 	9518619	Wabco 973 500 039 0 973 500 044 0	KX2000/1	From Chassis 26577 M22 Voss ports
Supply Dump Valve 	1585345	Wabco 973 002 422 0	SDM2GA	
Pressure Limiting Valve 	3987429	0481009069000	0481009055000	8.5 bar, M22 ports Set replacement valve to 8.5 bar
Pressure Reducing Valve 	3032760	Wabco 475 009 021 0	KX2045/14000 See Remarks	1.2 bar, M12 ports Set replacement valve to 1.2 bar
Low Pressure Switch 	3987498			
Low Pressure Switch 	20382510			

Bodied by Alexander (ALX500) and Wrightbus (Explorer)

Air Suspension

Description		Volvo Part Number	OE Part Number	Replacement Knorr-Bremse Part No	Remarks Note: Left and Right refer to the side of the vehicle when viewed from the driver's seat facing forward.
Pressure Relief (Safety) Valve		1622431	KX1729/2	KX1729/2	10 bar, M16 thread
Pressure Relief (Safety) Valve		1622432	KX1729/5	KX1729/5	13 bar, M16 thread
Pressure Relief (Safety) Valve		1607454 20941236			18 bar, M16 thread In ping tank Volvo only
Tilt Drain Valve		1081328	Wabco 934 300 033 0	KW2350/2	M22 thread
Automatic Drain Valve		1607503	KX2068/7V	KX2068/7000	M16 side and top ports (side port plugged)
Test Connector		1592924	Wabco 463 703 120 0	KW4282/2	M16 thread
Exhaust Silencer		3028744	Wabco 432 407 010 0	0484210005000	For Foot Valve and Relay Valve Snap-on
Exhaust Silencer		1197476	Wabco 432 407 060 0	SIL68B	For QRV and Suspension Control Modules M22 thread Alternative Silencers: 0484210001000 or ZB3150-178074
ABS Modulator		9520836	Wabco 472 195 051 0		M22 ports, Volvo electrical connector
Wheel Speed Sensor		9955937	Wabco 441 032 800 0		90° sensor, cable length 2.265 m Replaced by 20490824
Wheel Speed Sensor		20490824	Wabco 441 032 964 2		
ABS Electronic Control Unit (Type C3, ABS + ASR)		3943981	Wabco 446 004 079 0		

NOTE: X00 and X50 suffixes refer to Exchange Products which may be Remanufactured.





Super Olympian (B10TL)

VOLVO

6 x 2

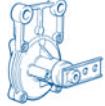
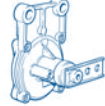
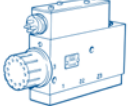
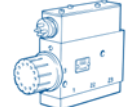

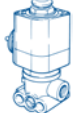
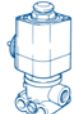
Bodied by Alexander (ALX500) and Wrightbus (Explorer)



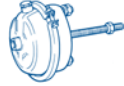
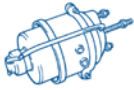

Air Suspension

Description	Volvo Part Number	OE Part Number	Replacement Knorr-Bremse Part No	Remarks Note: Left and Right refer to the side of the vehicle when viewed from the driver's seat facing forward.
Air Suspension Level Sensor 	20514066	0504002107000	0504002112100	All axles Replaced by 20850557
Air Suspension Level Sensor 	20850557	K013741	K013741N00	All axles
Air Suspension Control Module 	9957009	0501100035000	0501100041100	Front axle, independent suspension. With kneeling function
Air Suspension Control Module 	3944717	0501100014000	0501100029000	Rear axle
Air Suspension Electronic Control Unit 	3118073	0540004105000	0504004105000	Automatic ride height Replacement ECU must be programmed before use
Solenoid Valve 	9515215	Wabco 472 137 132 0		Traction control (ASR) Normally 'Closed', M12 ports, Volvo electrical connector
Solenoid Valve 	8158342	Norgren-Herion 9041005374302400		Exhaust pressure regulator system
Solenoid Valve 	3986621	Norgren-Herion 9042006374302400		Throttle control
Solenoid Valve 	8143021	Norgren-Herion 9042001374302400		Parking brake and retarder control
Engine Stop Cylinder 	3979028			

Bodied by Alexander (ALX500) and Wrightbus (Explorer)

Air Suspension

	Description		Volvo Part Number	OE Part Number	Replacement Knorr-Bremse Part No	Remarks Note: Left and Right refer to the side of the vehicle when viewed from the driver's seat facing forward.
Front Axle with Disc Brakes	Brake Chamber (Type 20HE) 		3112670	1186883-08	1186883-08	On Meritor Disc Brakes Diaphragm 20LS
Rear Axle with Drum Brakes	Spring Brake (Type 30/30) 		1066850 70330015	MGM 4130063	K2B0521X50	On Z-cam Brakes Diaphragm 234101K
Trailing Axle with Drum Brakes	Spring Brake (Type 20/) 		1066851 70330017	Wabco		On Z-cam Brakes Diaphragm 234099K

Front Axle	Air Disc Brake 		70301332 70306886 70311512 70330022	Meritor LRG592		Left side
	Air Disc Brake 		70301333 70306887 70311513 70330023	Meritor LRG593		Right side
	Disc Brake Pad Set 		85105485 20825594	Meritor MDP5061		
	Brake Disc 		3112965			Ventilated disc

NOTE: X00 and X50 suffixes refer to Exchange Products which may be Remanufactured.

**Knorr-Bremse
the world leader in
original equipment**

Knorr-Bremse Air Disc Brakes

Service Parts

Knorr-Bremse offers a range of Rationalised Calipers to service the majority of its Air Disc Brakes. It should be noted that these Rationalised Calipers are not fitted with Brake Pads and do not come with the Carrier, although a fitting kit for attaching the Caliper to the existing Carrier on the vehicle is included. In this Bus Catalogue the Rationalised Caliper is offered as the preferred replacement for an Air Disc Brake and it is identified as "*Caliper*" followed by the part number.

In addition Knorr-Bremse offers a wide range of service kits for the maintenance of Air Disc Brakes. The part numbers for these are listed within this catalogue.

Remember: Always wind out and check the Tappets and Boots within the Caliper at every Pad change. If the Brake Pads have been in the Air Disc Brake for more than two years, when you are changing the Pads, fit new Tappets and Boots regardless of their appearance. Obtain and read the Service Manual from our website: www.Knorr-BremseCVS.com or from the Applics CD.

Important note: To obtain maximum braking efficiency and component life it is critical that genuine Knorr-Bremse Brake Pads are used. If non-genuine pads are used then lower braking efficiency will probably result combined with rapid wear of the Brake Pads and/or the Brake Disc.

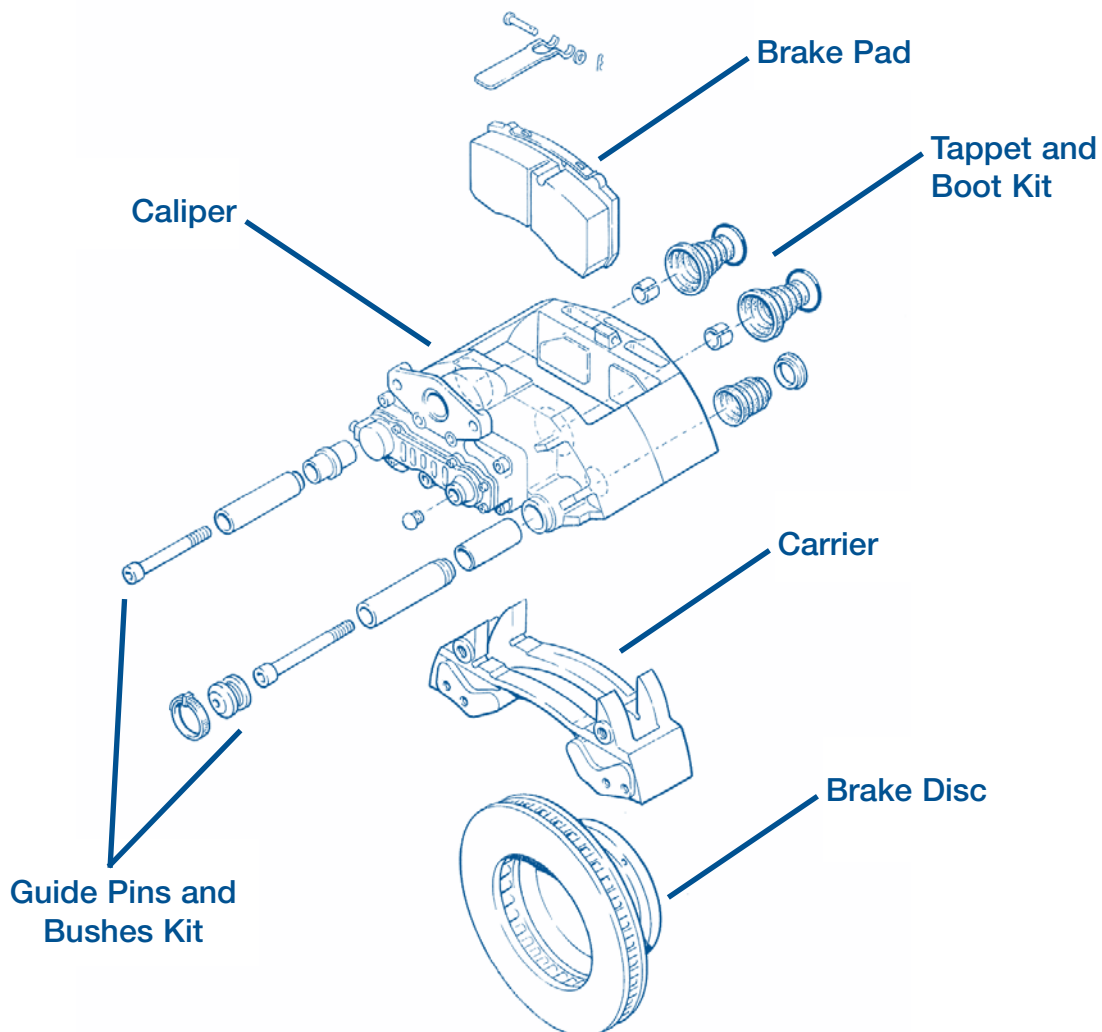

More than 1 billion people
put their trust in the
safety of Knorr-Bremse
products every day

Knorr-Bremse Systems for Commercial Vehicles Ltd.

Century House, Folly Brook Road
Emerald Park East, Emersons Green
Bristol BS16 7FE, United Kingdom
Tel: +44 (0) 117 9846 100
Fax: +44 (0) 117 9846 101
www.knorr-bremseCVS.com
www.knorr-bremse.co.uk

Europe – Africa

Austria
Knorr-Bremse GmbH
Systeme für Nutzfahrzeuge
Mödling
Tel: +43 2236 409-436
Fax: +43 2236 409-434

Belgium
Knorr-Bremse Benelux B.V.B.A.
Heist-op-den-Berg
Tel: +32 1525 7900
Fax: +32 1524 9240

Czech Republic
**Knorr-Bremse Systémy pro
užitkovú vozidla, CR, s.r.o.**
Hejnice
Tel: +420 482 363-611
Fax: +420 482 363-711

France
Knorr-Bremse
**Systèmes pour Véhicules
Utilitaires France S.A.**
Lisieux Cedex
Tel: +33 2 3132 1200
Fax: +33 2 3132 1303

Germany
Hasse & Wrede GmbH
Berlin
Tel: +49 30 9392-3101
Fax: +49 30 7009-0811

Germany
**Knorr-Bremse Systeme für
Nutzfahrzeuge GmbH**
Munich
Tel: +49 89 3547-0
Fax: +49 89 3547-2767

Hungary
Knorr-Bremse
Fékkrendszerek Kft.
Kecskemét
Tel: +36 76 511 100
Fax: +36 76 481 100

Italy
Knorr-Bremse
**Sistemi per Autoveicoli
Commerciali S.p.A.**
Arcore
Tel: +39 039 6075-1
Fax: +39 039 6075-435

Netherlands
Knorr-Bremse Benelux B.V.B.A.
Mydrecht
Tel: +31 297 239-330
Fax: +31 297 239-339

Poland
Knorr-Bremse Polska SfN Sp. z o.o.
Warsaw
Tel: +48 22 887-3870
Fax: +48 22 531-4170

Russia
Knorr-Bremse RUS
Nizhniy Novgorod
Tel: +7 8312 57-6661
Fax: +7 8312 57-6791

Russia
Knorr-Bremse
Systeme für Nutzfahrzeuge GmbH
Moscow
Tel: +7 495 234-4995
Fax: +7 495 234-4996

South Africa
Knorr-Bremse S.A. Pty. Ltd.
Kempton Park
Tel: +27 11 961-7800
Fax: +27 11 975-8249

Spain
Bost Ibérica, S.L.
Irun (Guipuzcoa)
Tel: +34 902 100-569
Fax: +34 943 614-063

Sweden
Knorr-Bremse
System for Tunga Fordon AB
Malmö
Tel: +46 40 680 5880
Fax: +46 40 937490

Switzerland
Knorr-Bremse
Systeme für Nutzfahrzeuge GmbH
Bassersdorf
Tel: +41 44 888 77-55
Fax: +41 44 888 77-50

Turkey
Knorr-Bremse
Systeme für Nutzfahrzeuge GmbH
Findikli - Istanbul
Tel: +90 212 293-4742
Fax: +90 212 293-4743

United Kingdom
Knorr-Bremse
**Systems for Commercial
Vehicles Ltd.**
Bristol
Tel: +44 117 9846-100
Fax: +44 117 9846-101

America

Brazil
Knorr-Bremse
**Sistemas para Veículos
Comerciais Brasil Ltda.**
São Paulo
Tel: +55 11 5681 1104
Fax: +55 11 5686 3905

USA
**Bendix Commercial Vehicle
Systems LLC**
Elyria, OH
Tel: +1 440 329-9100
Fax: +1 440 329-9105

Asia – Australia

Australia
Knorr-Bremse
Australia Pty. Ltd.
Granville NSW
Tel: +61 2 8863-6500
Fax: +61 2 8863-6151

China
Knorr-Bremse
**Brake Equipment (Shanghai)
Co. Ltd.**
Shanghai
Tel: +86 21 6891-7500
Fax: +86 21 6891-7510

China
Knorr-Bremse
**Asia Pacific (Holding) Limited
Truck Brake Systems Division**
Hong Kong
Tel: +852 3657-9800
Fax: +852 3657-9901

India
Knorr-Bremse
**Systems for Commercial Vehicles
India Private Ltd.**
Pune
Tel: +91 20 2293-9141-47
Fax: +91 20 2293-9148

Japan
Knorr-Bremse
**Commercial Vehicle Systems
Japan Ltd.**
Tokyo
Tel: +81 3 3971-8501
Fax: +81 3 3971-8579

Korea
Knorr-Bremse
Korea Ltd. Truck Brake Division
Seoul
Tel: +82 2 2273-1182
Fax: +82 2 2273-1184

This publication is subject to alteration without notice. A printed copy of this document may not be the latest revision. Please check our website www.knorr-bremseCVS.com for the latest update or contact your local Knorr-Bremse representative. The figurative mark "K" and the trademarks KNORR and KNORR-BREMSE are registered in the name of Knorr-Bremse AG. Copyright 2007 © Knorr-Bremse AG - all rights reserved, including industrial property rights applications. Knorr-Bremse AG retains any power of disposal, such as for copying and transferring. Released 12/2007