

BOMBAS DE AGUA • WATER PUMPS • WASSERPUMPEN • POMPES A EAU



DOLZ

Truck

2007

DOLZ

Truck
2007

INDUSTRIAS DOLZ, S.A.

C/Vall de Uxó nº 1 · 12004 · Castellón · SPAIN
T.: +34 964 34 00 38 · F: +34 964 24 13 01
e-mail: dolz@idolz.com · www.idolz.com

DOLZ ARGENTINA, S.A.

Av. Marcelo T. de Alvear 3894
Ciudadela Bs/As · Argentina · C/P: 1702
Telefax: 5411-4488-3397/2849
e-mail: dolzar@idolz.com · www.idolz.com



BOMBAS DE AGUA • WATER PUMPS

tecnología

Con más de 70 años de **liderazgo** en la investigación, desarrollo y fabricación de bombas de agua, Industrias Dolz ha creado una nueva generación de productos con los que consigue situarse en la vanguardia internacional del mercado. La **calidad** certificada de todas las referencias, partiendo de diseños y componentes **originales** y fruto de una constante y exigente labor de I+D, nos permite ofrecer la **gama** de bombas de agua más amplia del mercado. Por este motivo, las bombas DOLZ están plenamente adaptadas a todas las exigencias de la industria de la automoción y continúan nuestra filosofía, cuyo objetivo parte del firme compromiso que avala toda nuestra trayectoria: **satisfacer las necesidades de nuestros clientes.**

In its more than 70 years at the head of research, development and manufacturing of water pumps, Dolz has created a new generation of products which have placed it in prime position in the market. The certified quality of all our models, from original designs and components to the highest and most exacting R&D, have enabled us to supply the fullest range of pumps. Dolz pumps are fully adapted to the demands of the motor industry and continue our basic philosophy which is: to satisfy the needs of our customers.

technology

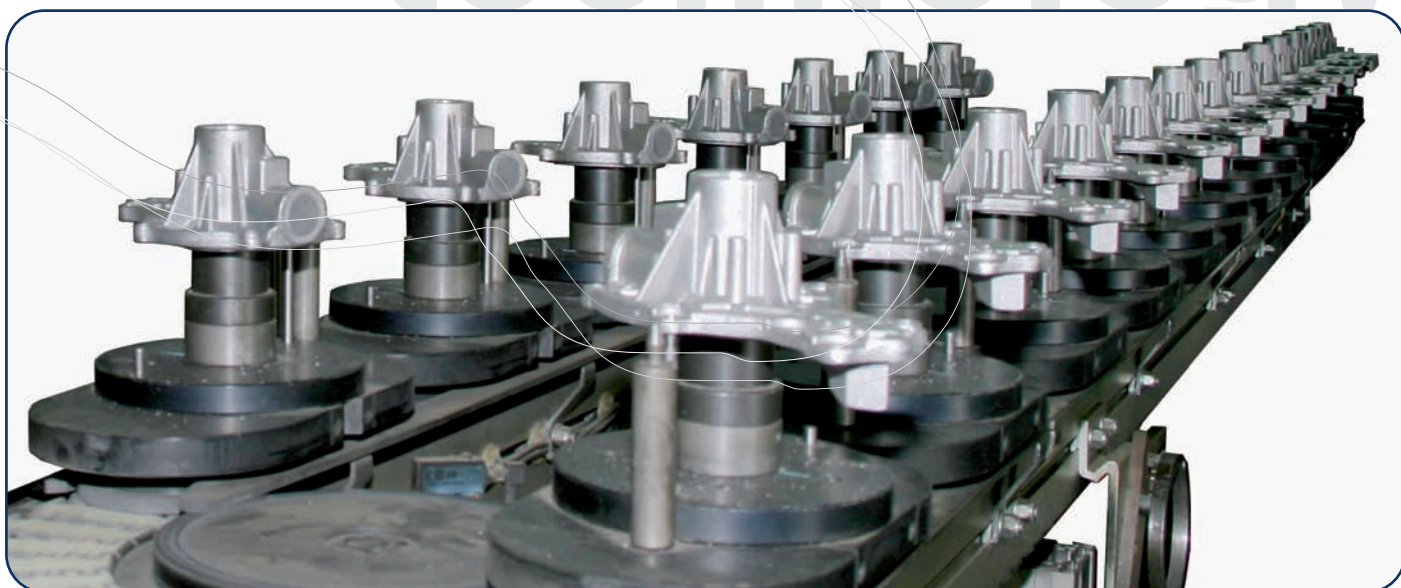

DOLZ

Truck

WASSERPUMPEN • POMPES A EAU



Ampliamos nuestra gama de producto en este catálogo, al mismo tiempo que actualizamos y modernizamos nuestros procesos productivos situándonos a la vanguardia en tecnología y rendimiento en nuestra fabricación.

While our catalogue increases, we continue to modernize our means of production, placing us at the forefront in technical productivity.

CONFIGURACION DE UNA BOMBA DE AGUA

WATER PUMP CONFIGURATION

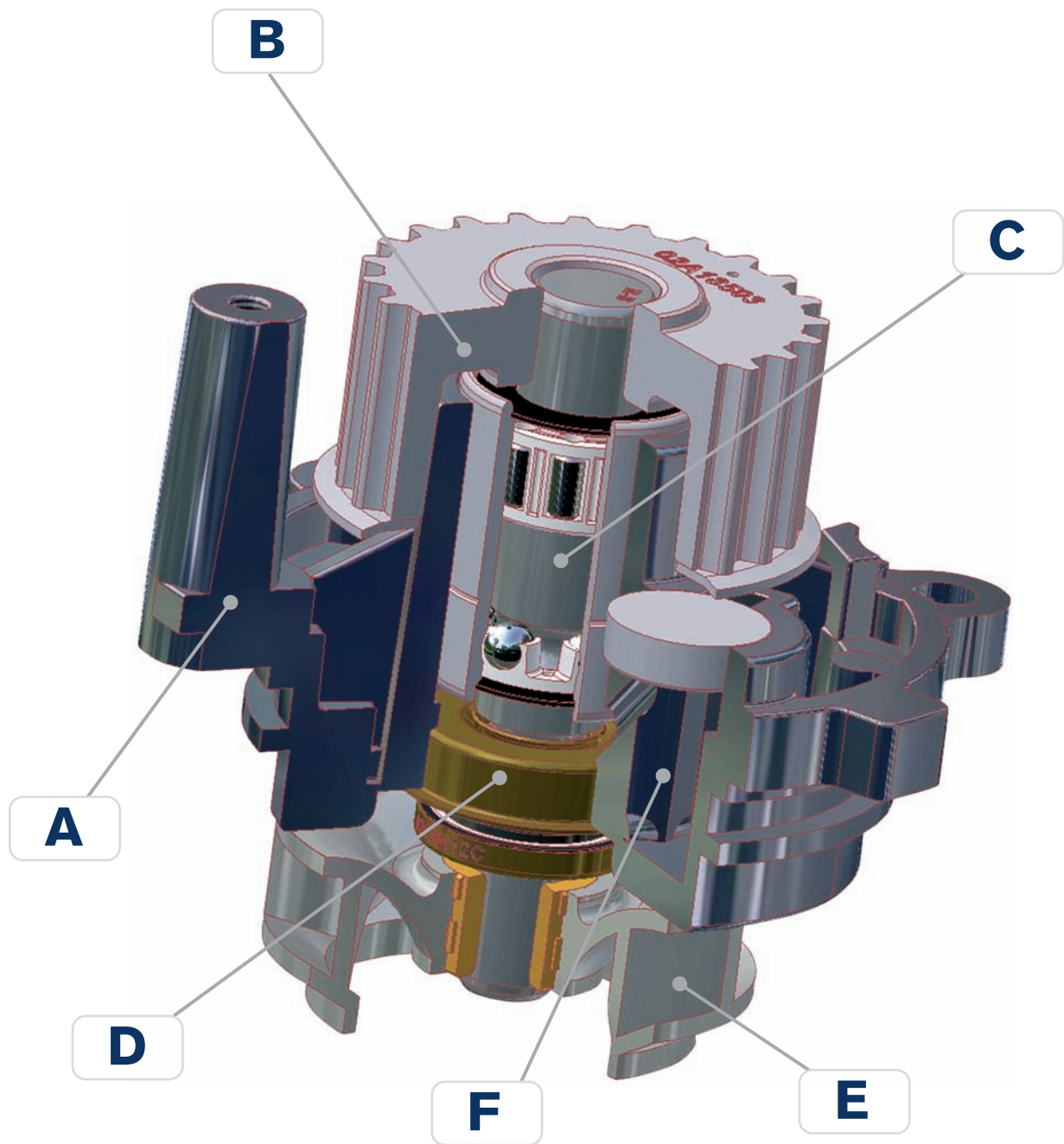

- A.** Cuerpo de la bomba · Pump housing
- B.** Polea · Pulley
- C.** Eje armado · Integrated shaft and bearing
- D.** Cierre/Sello dinámico · Dynamic seal
- E.** Turbina · Impeller
- F.** Cámara de evaporación · Leakage collector and evaporation chamber

LISTA DE APLICACIONES

005

LIST OF APPLICATIONS · TABLEAU D'APPLICATIONS ·
ELENCO DELLE APPLICAZIONI · LISTE DER ANWENDUNGEN

• BARREIROS	006..
• BEDFORD	007..
• CASE INTERNACIONAL.....	008
• CUMMINS	009..
• D.A.F.....	009..
• DITER	009..
• EBRO.....	010..
• FIAT	010
• FIAT-IVECO-OM-UNIC.....	010
• FORD.....	016..
• HANOMAG HENSCHEL.....	017
• HITACHI-SIMIT	017..
• ISUZU	018..
• IVECO	018..
• JOHN DEERE.....	021..
• KASSBOHRER.....	021..
• LEYLAND-BCM-SAVA	021
• MAN	022
• MASSEY FERGUSON.....	029
• MERCEDES.....	029..
• NEW HOLLAND.....	038..
• NISSAN.....	041..
• PEGASO	042..
• PERKINS	043..
• RENAULT.....	050..
• RENAULT V.I.....	051..
• SCANIA.....	051..
• VOLVO	052..

ÍNDICE DE REFERENCIAS DOLZ

053

THE BUYERS GUIDE · INDEX-RÉFÉRENCES DOLZ ·
INDICE DEI CODICI DOLZ · ARTIKELVERZEICHNIS

CRUCE REFERENCIAS ORIGINALES-DOLZ

057

CROSS REFERENCE LISTING ORIGINALS-DOLZ ·
LISTE DE CORRESPONDANCE RÉFÉRENCES D'ORIGINE-DOLZ ·
TABOLE COMPARATIVE RIFERIMENTI ORIGINALI-DOLZ ·
VERGLEICHSNUMMERNLISTE ORIGINALES-DOLZ

KITS DE REPARACIÓN

064

REPAIR KIT · KIT DE REPARATION · REPARATUR DES WERZEUGS







ABREVIATURAS • ABBREVIATIONS • ABRÉVIATIONS • ABBREVIAZIONI • ABKÜRZUNGEN

	ESPAÑOL	ENGLISH	FRANÇAIS	ITALIANO	DEUTSCH
					
"CCR"	cuenta revoluc.mec.	rev. counter	compte tours mec.	contagiri meccanico	Drehzahlmesser
"CD"	con dinamo	with dynamo	avec dynamo	con dinamo	mit Dynamo
"CA"	con alternador	with alternator	avec alternateur	con alternatore	mit Lichtmaschine
"A.A"	con aire acondicionado	with air conditioning	avec air conditionnée	con aria condizionata	mit Klimaanlage
"SA"	sin aire acondicionado	without air conditioning	sans air conditionnée	senza aria condizionata	ohne Klimaanlage
"DA"	direccion asistida	power assisted steering	direction assistée	servosterzo	mit Servolenkung
"T.T"	todos los tipos	all models	tous types	tutti i modelli	alle Modelle
"VA"	ventilador automático	automatic fan	ventilateur automatique	ventilatore automatico	automatisches Lüfterrad
"VF"	ventilador fijo	fixed fan	ventilateur fixe	ventilatore fisso	Festes Lüfterrad
"RB"	rodamiento reforzado	reinforced bearing	roulement renforcé	cuscinetto rinforzato	verstärktes Lager
"C.IZQ"	conduccion izquierda	left-hand drive	conduite à gauche	guida sinistra	Linkslenker
"C.DCH"	conduccion derecha	right-hand drive	conduite à droite	guida destra	Rechtslenker
CH-->	desde chasis	from chassis no.	du châssis no.	dal telaio	ab Fahrgestellnr
.->CH	hasta chasis	to chassis no.	au châssis no.	fino al telaio	bis Fahrgestellnr
M-->	desde motor	from engine no.	du moteur no.	dal motore	ab Motornr
.->M	hasta motor	to engine no.	au moteur no.	fino al motore	bis Motornr
PR-->	desde producción	from production no.	de la production no.	dalla produzione	ab Produktionsnr
.->PR	hasta producción	to production no.	à la production no.	fino alla produzione	bis Produktionsnr
C-->	desde cambio n°	from gear box no.	de la boîte de vitesse no.	dal cambio	ab Getriebenr
.->C	hasta cambio n°	to gear box no.	à la boîte de vitesse no.	fino al cambio	bis Getriebenr
HP	altura plato o polea	hub or pulley height	"hauteur du plateau ou de la poulie"	altezza mozzo o puleggia	Höhe der Scheibe / Riemenscheibe
Øp	diámetro plato o polea	hub or pulley diameter	"diamètre du plateau ou de la poulie"	diametro mozzo o puleggia	Scheiben- / Riemenscheibendurchmesser
HT	altura turbina	impeller height	hauteur de turbine	altezza girante	Schaufelrad Höhe
ØT	diametro turbina	impeller diameter	diamètre de turbine	diametro girante	Schaufelrad Durchmesser
D	distancia	distance	distance	distanza	Abstand
Z	número de dientes	number of teeth	nombre de dents	numero di denti	Zähnezahl
NP	número de palas	number of blades	nombre de pâles	numero di pale	Anzahl Schaufeln / Flügel
HD	altura de diente	tooth height	hauteur de dent	altezza dente	Zahnhöhe
Ⓚ	TAPA kit de reparación disponible para esta bomba	back housing repair kit available for this model	couvercle kit de reparation disponible pour ce modèle	coperchio kit di riparazione disponibile per questa pompa	Gehäuse Das Reparatur-Werkzeug ist für diese Wasserpumpe vorhanden



LISTA DE APLICACIONES

LIST OF APPLICATIONS
TABLEAU D'APPLICATIONS
ELENCO DELLE APPLICAZIONI
ANWENDUNGEN GELISTET

DOLZ
Truck

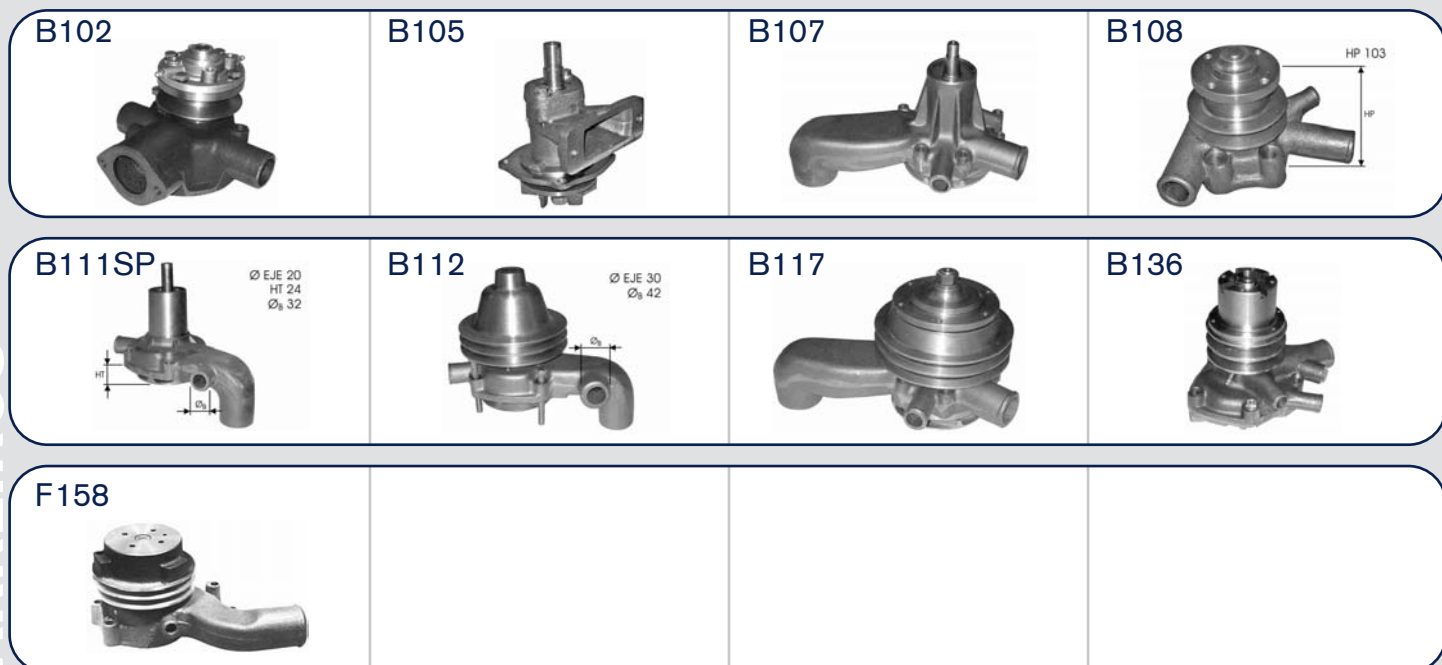
	C.C.			DOLZ	OEM
BARREIROS					
115	soporte cojinete/bearing holder			B105	OS13211010
230-20/210-20		DOGE		B112	5430013192-5430013351
4220	cabina fija/fixed cabin	115 Y 150 HP	B-24/B-26	B105	OS13211010
AUTOBUSES / BUSSES 4600			DOGE	B136 / B156	4011390720
B - 36		170 HP	RENAULT D-17, D-20 T	B110SP	
		170 HP	TALBOT DODGE C-17, C-20 T	B110SP	
		170 HP	RENAULT D-17, D-20	B111SP	0062612300-BA13211010-BJ13211000
			TALBOT DODGE C-17, C-20 sin turbo/without turbo	B111SP	0062612300-BA13211010-BJ13211000
B - 36 / 4220	cabina abatible/moveable cabin		T	B110	0063847100
	cabina abatible/moveable cabin	170 HP		B111	0063847300
B - 36 moderno / modern 2626, 4238, 6426, 8285 TS				B107	4000133920-4000134120
BS - 36 / 2626, 4238, 6426, 8285 TS	moderno/modern			B117	4000133920-4000134120-BV13211012
BS - 36 / C3464		300 HP	T	B117	4000133920-4000134120-BV13211012
		300HP	T	B107	4000133920-4000134120
C - 14 Y C - 16	cabina abatible/moveable cabin			D101 	0022704900-622607310065- 922917310105-920317310105
			DODGE TD 229/6		
			RENAULT D-14 Y D-16		
			229 embarcaciones /boats		
	6cil. con 6 culatas/6cyl. and 6 heads				
			DITER 202.225		
C - 60 Y C - 65			C-60	B160	0063864900-BJ13211070-CA13211001- CC13211000
CAMIONES/TRUCKS 42.14, 42.45, 42.55			DOGE	B136 / B156	4011390720
DR 340-38				B117	4000133920-4000134120-BV13211012
EB	4-6 cil..con indicador-bomba en culata/ 4-6 cyl. with inditator, pump attached to head		A-23/A-24/A-26	B102	4011016120-AM13211000
GRAN RUTA/AZOR/ SUPER AZOR 4216, 4217		115 Y 150 HP	B-24/B-26	B105	OS13211010



		C.C.			DOLZ	OEM
BARREIROS						
HALCON - SAETA	Bomba en tapa de distribución / Pump on the distributor cover		A-24/A-26		B108	4011363620-AA13211003
	Cuello corto/short stem		A-23		B108	4011363620-AA13211003
	Bomba en tapa de distribución / Pump on the distributor cover		A-26		B109	4011363520-AA13211000
HALCON - SAETA-CAMION SAETA 35/65	Cuello largo/long stem		A-23		B109	4011363520-AA13211000
HALCON - SAETA-TRACTOR 350 VIÑEDO 335			A-24		B109	4011363520-AA13211000
HALCON - SAETA-TRACTOR 4000 V/ 5000 V / 5055 V			A-26	70->	B109	4011363520-AA13211000
HALCON - SAETA-TRACTOR R500	3 Ó 4 Cil./Cyl.				B109	4011363520-AA13211000
TRACTOR 5500, 7000, 7070			DOGE		B136 / B156	4011390720
			DODGE D-24, D-34, D-36, D-90		B136 / B156	4011390720
BEDFORD						
CF/CH/CJ/EF/EH/EJ/TK - SERIE DIESEL 220 cu. in.		3614	6000001/6002598	68-73	F156	2701605-2705259-2712239-7182777-9962669
		3614	6032382 -->	68-73		
		3614	6032382 -->	69-84		
SERIES 300 / 330 cu. in.			6032382 -->	69-77		
		5420	-->C.H LW106169	80-81		
SERIES 300 / 330 cu. in.-330 CH/CJ/EH/EJ		5420	6000001/6002598	68-73		
TK / TL RANGE-SERIES SD/SH 330 CU. IN.			TD	81-84	F158	91074231
TK / TL RANGE-SERIES DD/DH 330 CU. IN.			TD	81-84	F158	91074231

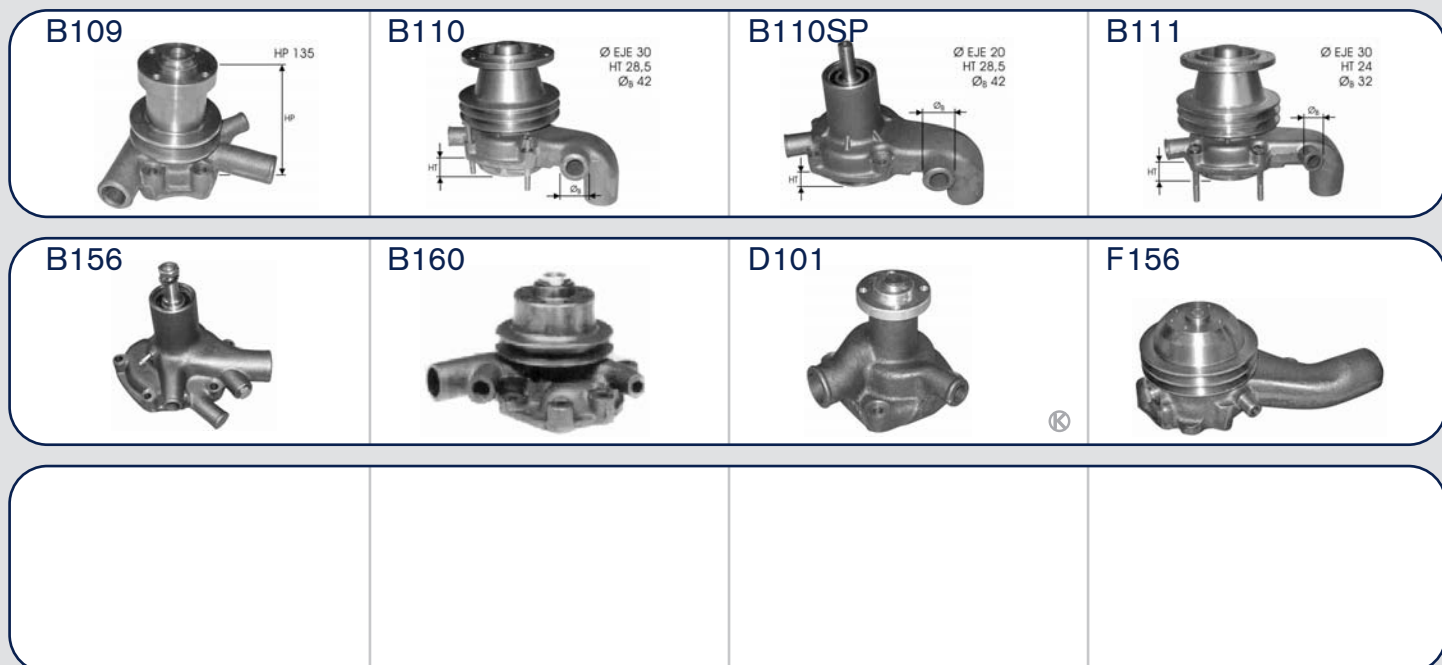



C.C.

**DOLZ****OEM**

CASE INTERNACIONAL

1660 - 1680		6T-830		L215	A77704-J802479-3804883-3913430
7110 - 7120 - 7130	BASE TRIANGULAR	6T 830		L215	A77704-J802479-3804883-3913430
7140		6TA 830		L215	A77704-J802479-3804883-3913430
INTERNACIONAL				I108	3144661R93
SERIE D	Tubo roscado /threaded tube eje/axis 16 mm	SERIE D		I105	763613R95
	Con polea/with pulley	D-214		I106	718891R97
	Con polea/with pulley	D-215		I106	718891R97
	Con polea/with pulley	D-217		I106	718891R97
	Con polea/with pulley	D-219		I106	718891R97
	Con polea/with pulley	D-212		I106	718891R97
TRACTOR 1056XL, 1255,1255XL,1455		DT-358		I107	3138936R92-3144456R93
TRACTOR 1455XL	TURBINA/IMPELLER 112 mm	DT-402		I107	3138936R92-3144456R93
TRACTOR 510				I107	3138936R92-3144456R93
TRACTOR 743, 743XL,845,845XL	4 Cil./Cyl.	D-239		I102 ☉	3132738R92-3132741R93
TRACTOR 8445, 844X2,845,845X2	4 Cil./Cyl.	D-239		I102 ☉	3132738R92-3132741R93
TRACTOR 856XL	4 Cil./Cyl. (Turbina/impeller 112 mm)	DT-239		I102 ☉	3132738R92-3132741R93
TRACTOR 955, 955S, 955XL, 956		D-310		I107	3138936R92-3144456R93
TRACTOR 956XL, 1055, 105XL, 1056		D-358		I107	3138936R92-3144456R93
TRACTOR SU-533, 262 F.A.I.	4 Cil./Cyl.	D-155		I102 ☉	3132738R92-3132741R93
TRACTOR SU-633	4 Cil./Cyl. (Turbina/impeller 98 mm)	D-206		I102 ☉	3132738R92-3132741R93
TRACTOR SU-644	4 Cil./Cyl.	D-268		I102 ☉	3132738R92-3132741R93
TRACTOR TD-7E, TE-BE, 100E-125E	4 Cil./Cyl.			I102 ☉	3132738R92-3132741R93
TRACTORES / TRACTORS 474-584-585-574-674-684-685		DT-358		I104 ☉	3132739R92-3136053R92
TRACTORES / TRACTORS 484,584, 585XL, 684, 685XL		D.206		I104 ☉	3132739R92-3136053R92
TRACTORES / TRACTORS 544/2544/3514	TURBINA/IMPELLER 112 mm- 4 Cil./Cyl.			I104 ☉	3132739R92-3136053R92
TRACTORES / TRACTORS 574	3 Y 4 Cil./Cyl.. (TURBINA/IMPELLER 98 mm)			I104 ☉	3132739R92-3136053R92
TRACTORES / TRACTORS 574/ 2500 A/2500 B/ 2510 B/3500 A				I104 ☉	3132739R92-3136053R92

D101



D201



D202



I102



I108

















L214



L215





CASE INTERNACIONAL

	C.C.			DOLZ	OEM
CASE INTERNACIONAL					
TRACTORES / TRACTORS 784, 785XL, 2530 TC		D-239		I104 	3132739R92-3136053R92
TRACTORES / TRACTORS 784-785-884-885	TURBINA /IMPELLER 112 mm	DT-358		I104 	3132739R92-3136053R92
TRACTORES / TRACTORS 858 F		DT-358		I104 	3132739R92-3136053R92
TRACTORES / TRACTORS 884, 885XL		D-268		I104 	3132739R92-3136053R92
TRACTORES / TRACTORS H84, 248, 258, 268, 278	4 4 Cil./Cyl.	D-179		I104 	3132739R92-3136053R92
TRACTORES UK / TRACTORS UK 85-454-484-485	TURBINA /IMPELLER 98 mm	DT-358J		I104 	3132739R92-3136053R92
		D-239		I104 	3132739R92-3136053R92
CUMMINS					
SERIE C		6TA-830		L215	A77704-J802479-3804883-3913430
D.A.F.					
45 / 55 TODOS/ALL 80-85-95		WS 242 L		D202 	CBU2148-473742-3927015-J802358
		WS 268 L		D202 	0681653-0682258-0682968
		WS 295		D202 	0681653-0682258-0682968
		WS 315 G		D202 	0681653-0682258-0682968
95 / XF		430 CV 480 CV		D201	0683225-0683225R-1609871
DAF 1000	6 4 Cil./Cyl.	5.9 L		L214	CBU2148-473742-3927015-J802358
DAF 600	4 4 Cil./Cyl.	3.4 L		L214	CBU2148-473742-3927015-J802358
DAF 800				L214	CBU2148-473742-3927015-J802358
DITER					
C-14/ C-16/ D-14/ D-16		RENAULT 6/6 CULATAS		D101 	0022704900-622607310065- 922917310105-920317310105
D 225 - D 229	3, 4 Y 6 4 Cil./Cyl.	D 225/ D 229			
FEND-TRACTOR 226/ 227		DITER			
Tractores / tractors 766-1080		DITER 225/ 229			





I104		I105		I106		I107	
	HP 107 Ø, 112						HP 100 Ø, 112

--	--	--	--	--	--	--	--

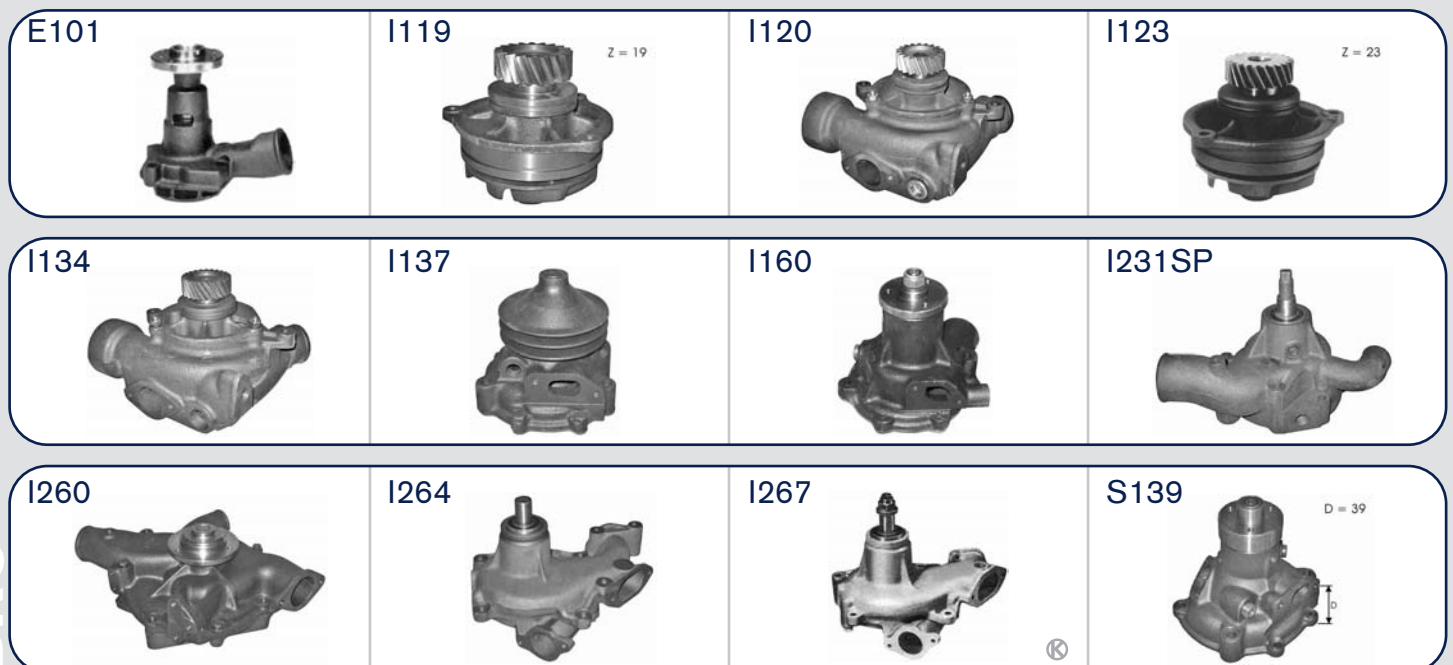
--	--	--	--	--	--	--	--

	C.C.			DOLZ	OEM
EBRO					
11 / 2-3 TON M SERIES 11/2-7 TON			57-65	E101	DKN8501-DKW8501B
11 / 4-4 TON THAMES VAN	4 4 Cil./Cyl.		57-65	E101	DKN8501-DKW8501B
4D-COST-CUTTER TRUCKS THAMES TRADE			57-67	E101	DKN8501-DKW8501B
FORD (U.K.) THAMES TRADER		DIESEL	57-65	E101	DKN8501-DKW8501B
FORD (U.K.) THAMES TRADER 200.300 CU. ING.		GASOLINA/ PETROL	57-65	E101	DKN8501-DKW8501B
FORDSON MAJOR			51-57	E101	DKN8501-DKW8501B
K SERIES 200/ 300			57-65	E101	DKN8501-DKW8501B
K SERIES FORD (U.K.)		GASOLINA/ PETROL	57-65	E101	DKN8501-DKW8501B
THAMES TRADER FC. NC.			53-57	E101	DKN8501-DKW8501B
TRACTOR EBRO 48-55-160 / SUPER 55			57-65	E101	DKN8501-DKW8501B
FIAT					
ARO - 244				S139	4639182-4655010-4655054-4679242 93191101-4603885-4616667-4639182 46545010-4655050-4655054-4655118 4655119-4679242-4679303-4679304 93191101
FL14C-S15B- S15BHD				I267 Ⓞ	79014642
FIAT-IVECO-OM-UNIC					
115.17-135.17(2ªSERIE)-135.17 VENEZUELA				I127 Ⓞ	4777806-4786730-4803730-4813730 4815259-98497114-98497115-4835043
145.17-150.17 ARGENTINA- CHILE-175.17					
165.24				I241 Ⓞ	61690377-61690384



	C.C.			DOLZ	OEM
FIAT-IVECO-OM-UNIC					
170.20 - 190.20 - OM 170 - OM 20 - 190 OM 20	POLEA/PULLEY Ø 156			I240	61690371-61690374
175.24 T. RSU-190.24 190.26 - 190.32 Tru-Turbotech - 220.32 - 240.32 - 260.32 - 240.26 Tru	Engranaje/Gear H 20mm-Z 23	8460.21		I123	93190288
175.24 T. RSU-190.24 190.26 - 190.32 Tru-Turbotech - 220.32 - 240.32 - 260.32 - 240.26 Tru -Turbotech.	Engranaje/Gear H 20mm-Z 23	8460.21		I133	61315464
180.24	Sin racor/without racor			I241  I264	61690377-61690384 4752137
190 PAC 26 - 190.26 M-190PC 30-190.30 H-260 PAC 26 260.26 H- 330 PC 26 330.26 H - 330.30 H		8210.02.269/731-8201.22.235/269			
190.36 Tru-Turbotech-G.V.-190.36 Turbostar E.S. - 220.36 Tru Turbotech -240.36 Tru Turbotech - 240.36 Turbostar E.S.-260.36 Tru Turbotech-260.36 Turbostar E.S.	Engranaje/Gear H 22mm-Z 19	8210.42 Economy		I119	42530033-93190287
	Engranaje/Gear H 22mm-Z 19	8210.42 Economy		I120	99458099-98468832
190.36 Turbotech - 190.36 Turbostar - 220.36 - 240.36 Tru-240.36 Turbostar - 260.36 Tru - 330.36 H - HT - HW	Engranaje/Gear H 23mm-Z 24	8210.42		I124	42530032-93190286-98468831-99456317
	Engranaje/Gear H 23mm-Z 24	8210.42		I134	99458098-4808471-98468830
190.42 TURBOSTAR GAMMA TRU-TS		8280.22		I260	4695786-4737154-4764156
190.48 - 220.48 - 240.48 - 260.48 - 190E52 - 240E52 - 440E52	TURBOSTAR	8280.42		I257	4812406-500300470
315.8.17				I137	4760948-93191104
315.8.18 Poker III				I126	98415831
331A		8200.02		I250	4606023-4952496
370.10.20		8020.02.710/834		I231SP	61690370-61690375
370.10.24		8220.22		I231SP	61690370-61690375

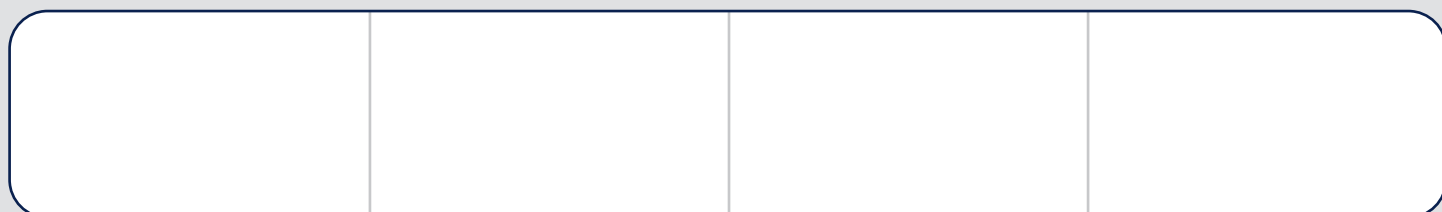



C.C.

**DOLZ**

OEM

FIAT-IVECO-OM-UNIC

370.10.25 - 370.12.25-270.12.25L 370.12.26		8260.02.405		I260	4695786-4737154-4764156
		8210.02		I250	4606023-4952496
		8210.02.405/434		I250	4606023-4952496
		8210.02		I250	4606023-4952496
		8210.02.405/434		I250	4606023-4952496
370.12.30		8210.22		I252 Ⓚ	4692698-4710552-4777222
370.12.35		8280.02.405		I260	4695786-4737154-4764156
370.S.24 -480.10.21- 480.12.21-580.12.21- 680.12.26 - 490 E 10.22 R - 490 E 10.22 R CNG - 590 E.12.22 R CNG.	Engranaje/Gear H 20mm- Z 20	8460.21 - 8460.41		I123	93190288
	Engranaje/Gear H 20mm- Z 23	8460.21 - 8460.41		I133	61315464
470.10.20-470.12.20- 471.10.20-471.12.20- U-EFFEUNO-570. 10.20-570.12.20- 571.10.20-571.12.20- S-EFFEUNO- 670.12.20				I259	61690510
50 AL - 329		C03		I256	4629770-8829770
60.11-65.12-79.12- 109.14 - 115.17 - 135.17 - 145.17 - 175.17 - 115.14 - 135.14				I127 Ⓚ	4777806-4786730-4803730-4813730 4815259-98497114-98497115-4835043
60.11-65.12-79.12 - 50.9Z-65.9Z-79.12Z			92->	S239	98497117-98465322-98497118
60.11-65.12-79.12-79. 14-109.14(4°SERIE)		8040.25.230		I127 Ⓚ	4777806-4786730-4803730-4813730 4815259-98497114-98497115-4835043
615 N1 - 1100TN				I157	4543905
619NI-643N-643N1- 683N-684N-684NP- 684NP-T-TP-690N4- 691N-T-693N1-697N- T-NP-180NC-300PC- PT-UNIC 190 PAC26- 190.26N-260 PAC26- 260.26N-260.26NW- 330 PAC26-330.26N				I250	4606023-4952496
642 N6 - N65 - N65R - 671N3				I166	761312
643 N-309-619-AD12				I261	4557736-4579897

I121

Z = 21



I123

Z = 23

I127**I131****I163**

Z = 23

I164**I166****I236****I259****I260****I261****I267**

	C.C.			DOLZ	OEM
FIAT-IVECO-OM-UNIC					
671.24	POLEA/PULLEY Ø125			I236	61690511
80251005				I267 ®	79014642
95.14-109.14- 110.14(4x4)-115.14- 135.14(2ªSERIE)		8040.25.220		I127 ®	4777806-4786730-4803730-4813730 4815259-98497114-98497115-4835043
A 55.10 1ª-2ª-3ª SERIE /A 60.10 1ª-2ª SERIE /A 70.12 1ª-2ª SERIE				I255	4711706-4796535
A 90.14 3ªSERIE	MODELO ANTIGUO / FORMER MODEL	8040.25.203		I127 ®	4777806-4786730-4803730-4813730 4815259-98497114-98497115-4835043
Bus Euroclass 380. 10.29 - 380.12.29 - 391.12.29-490.18.29 590.18.29-370.12.35 380.10.35 Domino - 380.12.35-380.12.38 HD Topclass Orlandi	Engranaje/Gear H 20mm- Z 23	8460.41 R - 8460.41 S		I163	93190284-500350798
Bus Euroclass 380. 10.29 - 380.12.29 - 391.12.29-490.18.29 590.18.29 Motor 8460.41 R-370.12.35 380.10.35 Domino - 380.12.35-380.12.38 HD Topclass Orlandi.	Engranaje/Gear H 20mm- Z 23	8460.41S		I164	99445447-61318938
City class 491.10.22- 491.12.22-191.10.27 491.12.27-591.10.22 591.12.22-591.10.27 591.12.27-370 S - E9.27 - 490.18.29 - 490E.12.22- 590E.12.22				I121 I132	42532082-42535615 98479917
D 140 - D 160				N453	8822883-8829787
Eurocargo 120E27 - 150E27 - 320E27 - 260E27KE	Engranaje/Gear H 20mm- Z 21			I131	98439476
	Engranaje/Gear H 20mm- Z 21			I121	42532082-42535615
EUROCARGO 120E23-130E23- 150E23-260E23- 280E23-135E24W EUROFIRE				I140	4838676

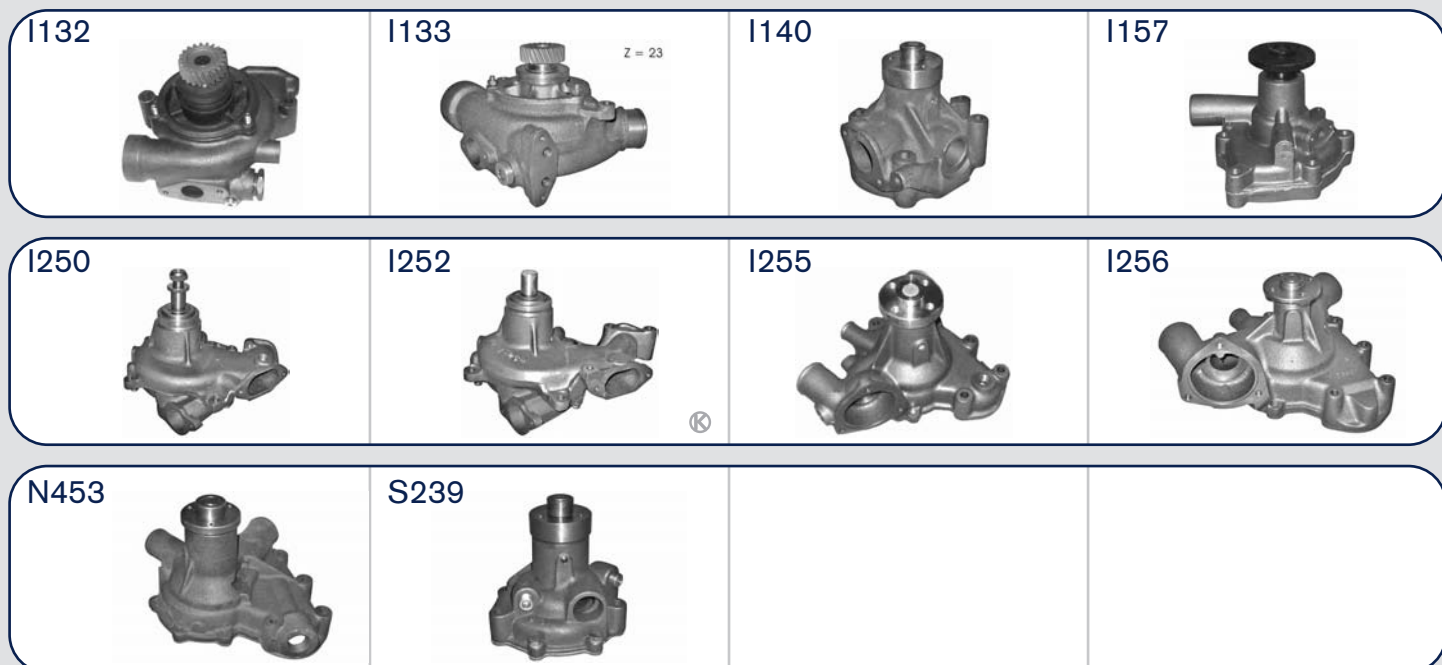



C.C.

**DOLZ**

OEM

FIAT-IVECO-OM-UNIC

Eurocargo 60E10 - 60E12-60E14-65E10- 65E12-65E14-70E10- 75E12-75E14-80E15- 80E18-80E21-100E15 100E18-100E21- 120E15-120E18- 130E15-130E18- 130E21-150E18		8040.45.5101		I126	98415831
		8060.25.5101		I126	98415831
		8060.45.5101		I126	98415831
		8040.45D.5101		I126	98415831
Eurotech 180E24 - 180E27 - 190E24 - 190E27 - 325E27	Engranaje/Gear H 20mm- Z 21	Euro 2		I121	42532082-42535615
	Engranaje/Gear H 20mm- Z 21	Euro 2		I122	500373092-99446891
	Engranaje/Gear H 20mm- Z 21			I121	42532082-42535615
	Engranaje/Gear H 20mm- Z 21			I132	98479917
Eurotech 180E42 - 190E42 - 240E42 - 260E42 - 400E42 - 440E42 - 440E47. / Eurostar 190E42 - 240E42 - 440E42 - 190E47 - 240E47 - 440E47./Eurotrakker 190E31 -190E37H - 380E37H/W - 400E37H- 410E37H- 720E37HT- 240E42- 260E42H - 380E42H/W - 410E42H-720E42HT	Engranaje/Gear H 22mm- Z 19	8210.42 K-L-L SPR - S.5000 (Motor N° 438826-->)	96->	I130	99453848-98447661-500350783
	Engranaje/Gear H 22mm- Z 19	8210.42 K-L-L SPR - S.5000 (Motor N° 438826-->)		I169	500350785-93190285-98479675 99445447
Eurotech 180E42 - 190E42 - 240E42 - 260E42 - 400E42 - 440E42 /Eurotrakker 190E37H-280E37H/W 410E37H-720E37HT 380E42H/W - 410E42H- 720E42 HT /Eurostar 190E42 - 240E42 - 400E42 - 440E42 - 290E47 - 440E47 - 240E47	Engranaje/Gear H 22mm- Z 19	8210.42 L/K/L SPR (-->Motor n° 438825)	-->95	I130	99453848-98447661-500350783
	Engranaje/Gear H 22mm- Z 19	8210.42 L/K/L SPR (-->Motor N° 438825)		I169	500350785-93190285-98479675 99445447

I121



Z = 21

I122



I126



I128



I169



Z = 19

I240







I252





I254



	C.C.			DOLZ	OEM
FIAT-IVECO-OM-UNIC					
Eurotrakker 190E34H 380 E 34 H. / Eurotech 180E30 - 180E34 - 190E30 - 190E34 - 190E38 - 240E38 - 400E34 - 400E38 - 440E34 - 440E38	Engranaje/Gear H 20mm- Z 23	8460 SPR (-->Motor N° 433405)	-->95	I128	61318939-500361227-61321400
	Engranaje/Gear H 20mm- Z 23	8460 SPR (Motor N° 433406-->)	96-->	I128	61318939-500361227-61321400
	Engranaje/Gear H 20mm- Z 23	8460 SPR (-->Motor n° 433405)	-->95	I163	93190284-500350798
	Engranaje/Gear H 20mm- Z 23	8460 SPR (Motor n° 433406-->)	96-->	I163	93190284-500350798
FIAT 130.20-140.20				I240	61690371-61690374
FIAT 150.20-159.20				I240	61690371-61690374
FIAT 160-160NC- 170.26-190.26-220.26 300.26-190NC-160.26 170.26-180.26-190.30 190.33 TURBOSTAR 240.30				I252 	4692698-4710552-4777222
FIAT 170.33-170.35- 190.33 - 190.35 - 220.35 - 330.35				I260	4695786-4737154-4764156
FIAT 50.8 2ª SERIE "DA" - 79.13 (1ª-2ª SERIE) - 79.14 (3ª SERIE) 80.13-80.13A- 90.13-90.13A-100.13- 110.14 -120.13				I254	93191103
FIAT 50F8-F9-F10- 55F8-F9-F10-65F10- 70F10-75F10				I255	4711706-4796535
Fiat 645-650- 650E- 662-213-C40-C50				I161	4544917-4581366
FIAT 80 NC-90 NC- N100 -N100EC- 80F13-90F13- 100FS-110PC-NC				I254	93191103
IVECO 170.35-190.35 260 PC 35-260.35H- 330.35H-190.38- 220.38-240.38-190.38	TURBOSTAR			I260	4695786-4737154-4764156
IVECO 50.9 - 50.10- 55.9 - 55.10 - 60.10- 65.10 -70.10 -75.10- 79.10 1ª-2ª-3ª SERIE				I255	4711706-4796535



	C.C.			DOLZ	OEM
FIAT-IVECO-OM-UNIC					
Leoncino 1ª y 2ª serie				I162	552113
OM 50-55-65-70-75-80-90 N100/10-UNIC 50-55-65-70-80-90-100U10		C03 VAR 41 - C03 VAR 49		I256	4629770-8829770
OM 80 - 90		C03 VAR 7		I258	8829769
OM 80 OM 13-90 OM 13-100 OM 13-N100 UNIC 110 NC 110 U13				I254	93191103
OM LEONCINO-TIGROTTO-50-55-65-LUPETTO 25-30-CERBIATTO-DAINO	DAINO MOT C03			I251	8823323-8829154
OM N100 - D140 - D160 MOTOR: C03/80 - C03/80 VAR 7-CN3-C03/70				N453	8822883-8829787
Tigrotto - Leoncino - 3ª serie				I159	8807763
UNIC 150U20-159U20				I240	61690371-61690374
UNIC 80 - 90		C03 VAR 7		I258	8829769
		OM50-OM8-OM9-OM10-55 OM8-OM9-OM10		I255	4711706-4796535
FORD					
DEXTA - MAJOR	MAJOR 4000		64-71	F113	C5NE8501A-C5NN8501A-D8NN8501UC
	SUPER DEXTA 6000		64-68	F113	C5NE8501A-C5NN8501A-D8NN8501UC
	SUPER MAJOR 4000		64-68	F113	C5NE8501A-C5NN8501A-D8NN8501UC
	DEXTA 2000		64-71	F113	C5NE8501A-C5NN8501A-D8NN8501UC
SERIES D / D1000 / 240-330CU.IN.ENG.		DIESEL	65-69	F144	2705E8K500-703F8K500AAC
SERIES D / D1000 / 250, 363, 380 CU. IN.ENG.		D	69-81	F144	2705E8K500-703F8K500AAC
SERIES D / D1000 / 360 CU.IN		TD	68-69	F144	2705E8K500-703F8K500AAC
TRACTOR 230 A/B, 231,233	4 4 Cil./Cyl.	FORD		F113	C5NE8501A-C5NN8501A-D8NN8501UC

F113



F123



F144



I159



I255



I256





I258







I267



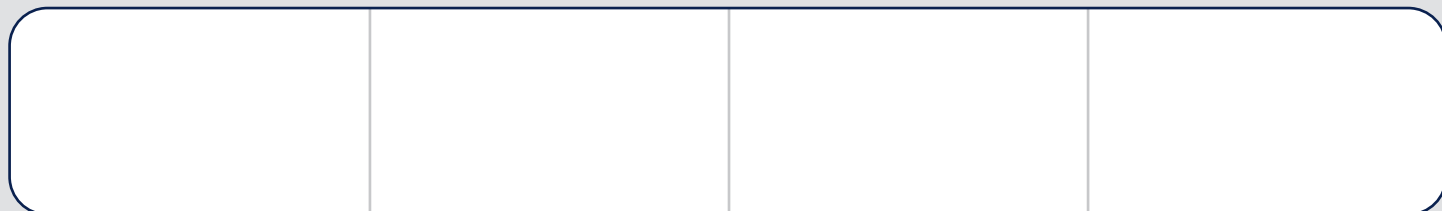



®

	C.C.			DOLZ	OEM
FORD					
TRACTOR 2310, 2610,2810,2910, 3610,3910	3 Y 4 4 Cil./Cyl.	FORD	81-->	F113	C5NE8501A-C5NN8501A-D8NN8501UC
TRACTOR 2600, 3600,3900,4100, 4600,5600	3 Y 4 4 Cil./Cyl.	FORD	-->81	F113	C5NE8501A-C5NN8501A-D8NN8501UC
TRACTOR 333,335, 420	4 4 Cil./Cyl.	FORD		F113	C5NE8501A-C5NN8501A-D8NN8501UC
TRACTOR 4110, 4610,5610,5900	3 Y 4 4 Cil./Cyl.	FORD	81-->	F113	C5NE8501A-C5NN8501A-D8NN8501UC
TRACTOR 442,515, 530 A/B,532,535	4 4 Cil./Cyl.	FORD		F113	C5NE8501A-C5NN8501A-D8NN8501UC
TRACTOR 5700, 6600,6700,7600,7700	3 Y 4 4 Cil./Cyl.	FORD	-->81	F113	C5NE8501A-C5NN8501A-D8NN8501UC
TRACTOR 6610, 6710,7610,7710	3 Y 4 4 Cil./Cyl.	FORD	81-->	F113	C5NE8501A-C5NN8501A-D8NN8501UC
Tractores/tractors SERIES 7.6,7.7, 8.0,8.6,8.7,9.0,9.6,9.7			68	F123	D5NF8501E-D5NN8501E
Tractores/tractors SERIES 7A 2.6, 3.6,4.1,4.6,5.6,6.6,6.7			68	F123	D5NF8501E-D5NN8501E
HANOMAG HENSCHEL					
F 130	TURBINA/IMPELLER Ø 95mm	OM 352		M612 Ⓞ	3532005601-3522003401-3522005401 3522007201-3522007501-3522008101 3522008501-3522008901-3522009201 3522009501-3522009601-3522009701 3532001601-3532001701-3532003801
F 193 - F 263		OM 403 -->N 129660		M617	4032004901-4032007001-5000281838 51065006228-51065009228 8132000475-4032003501-4032002701 432003201-4032003401-8311999133 8312000475
F40/45/46/55/65		OM 314		M613 Ⓞ	3142000601-3142000801-3142001901 3142002101-3142002401-3142002901 3142003701-3142003901-3142004201
HITACHI-SIMIT					
SLC15B-FD20-FL20				I267 Ⓞ	79014642

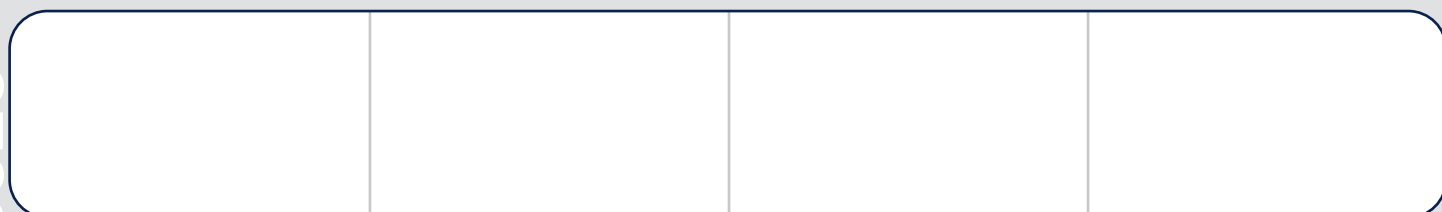

	C.C.			DOLZ	OEM
ISUZU					
V. INDUSTRIAL CARRETILLA / DUMPER HYSTER MODERNA 1600-2000		ISUZU C.2		I201	Z8943768630
V. INDUSTRIAL CARRETILLA / DUMPER ISUZU TCM 1600-2000		ISUZU C.2		I201	Z8943768630
V. INDUSTRIAL CARRETILLA / DUMPER KOMATSU				I201	Z8943768630
V. INDUSTRIAL TECNOCAR	4 Cil./Cyl.	C240-PKJ / PKF-19		I201	Z8943768630
IVECO					
100EC-100NC- 110NC	5,1 L	8060.02		S139	4639182-4655010-4655054-4679242 93191101-4603885-4616667-4639182 46545010-4655050-4655054-4655118 4655119-4679242-4679303-4679304 93191101
314/3	5,1L-6L	8060.12			
40NC-40 / 35NC / 50NC-55NC-65C	3,5 L	8040.02			
616N2-N3-N4	2,3 L	803A			
	2,6 L	8030.02			
625N2-N3	3,1 L	804A			
	3,5 L	8040.02			
645N1-N2-23	4,7 L	806A			
	5,1 L	8060.02			
650N1-N2 / 650E1	4,7 L	213 / 806A			
655N-N1	4,7 L	806A			
	5,1 L	8060.02			
662N1-N2 / 672N	4,7 L	8860.02			
	5,1 L	8060.02			
8031 i 05-8041 i 05- 8051 i 05-8061 i 05- 8061 si 05-8061 si 15 8061 si 25-8065 si 25			-->93	S239	98497117-98465322-98497118
80NC-80.13-90NC / PC / PM / 90.13	5,1L	8060.02		I254	93191103
8210 i - 8210 i 03				I250	4606023-4952496
8210 sri 10 - 8210 sri 25				I252 	4692698-4710552-4777222
8220 H var. 713				I259	61690510
8280 i - 8280 sri - 8281 si 01 - 8281 sri 03				I260	4695786-4737154-4764156



	C.C.			DOLZ	OEM	
IVECO						
8361 i 000-861 i 001-8361 si 10				N460	4796537	
8361 si 11-8361 SRI 10-8361 SRI 15				N460	4796537	
8365 Si				I273	98410023	
A90.10 / A90.14 / 315.13 / 315.17 / 316.13	5,5 L orsetto	8060.04 / 8060.24		S139	4639182-4655010-4655054-4679242 93191101-4603885-4616667-4639182 46545010-4655050-4655054-4655118 4655119-4679242-4679303-4679304 93191101	
DAILY 35.10	2,5L	8140.21 TD	82-90	S150	7303056-99459755	
DAILY 40.8 - 40.10	2,5L	8140.61 TD	82-90	S150	7303056-99459755	
DAILY-GRINTA 28.8 - 30.8 - 32.8 - 35.8	2,5L	8140.61 D	78-90	S151	4714636-4754850-4764761-5001001274 7303009-7701462808-7701468342	
DAILY-GRINTA 40.8 - 40.10	2,5L	8140.61 D	78-90		98437726-99440728	
DAILY-GRINTA 45.10 - 49.10	2,5L	8140.21 TD	82-90	S150	7303056-99459755	
DAILY-GRINTA A30.8-A 35.-A 40.8	2,5L	8140.61	-->90	S151	4714636-4754850-4764761-5001001274 7303009-7701462808-7701468342 98437726-99440728	
EUROTRAKKER	190 E 38 W	12880	F3BE0681G	01-->	I110	500356553
	190 E 44	12880	F3BE0681C	01-->	I110	500356553
	340 E 44 H - HB	12880	F3BE0681G	01-->	I110	500356553
	260 E 38 H - W	12880	F3BE0681G	01-->	I110	500356553
	260 E 44 H - W	12880	F3BE0681C	01-->	I110	500356553
	340 E 38 H - HB	12880	F3BE0681C	01-->	I110	500356553
	380 E 38 H - W	12880	F3BE0681G	01-->	I110	500356553
	380 E 44 H - W	12880	F3BE0681C	01-->	I110	500356553
410 E 38 H	12880	F3BE0681G	01-->	I110	500356553	
NEW DAILY 28.8 - 30.8 - 32.8 - 35.8		2,5L	8140.61	90-->	S151	4714636-4754850-4764761-5001001274 7303009-7701462808-7701468342 98437726-99440728
	VA	2,5L	8140.61	90-->		
	VA	2,5L	8140.61	90-91	S152	4720031-4755003-4764782-7303050 7301592-7302358-98435994-99459757 5000288046-5000807860-5000813420 5001833230-5001837263-5001837264 98418986
NEW DAILY 35.10	2,5L	8140.21 TD	90-->	S151	4714636-4754850-4764761-5001001274 7303009-7701462808-7701468342 98437726-99440728	

I254



I259



I260



I273





S152



S239



		C.C.			DOLZ	OEM
IVECO						
NEW DAILY 35.10	VA	2,5L	8140.21 TD	90-->	S152	4720031-4755003-4764782-7303050 7301592-7302358-98435994-99459757 5000288046-5000807860-5000813420 5001833230-5001837263-5001837264 98418986
NEW DAILY 40.8		2,5L	8140.61	90-->	S151	4714636-4754850-4764761-5001001274 7303009-7701462808-7701468342 98437726-99440728
NEW DAILY 40.8 - 40.10	VA	2,5L	8140.61 TD	90-->	S152	4720031-4755003-4764782-7303050 7301592-7302358-98435994-99459757 5000288046-5000807860-5000813420 5001833230-5001837263-5001837264 98418986
NEW DAILY 40.10		2,5L	8140.21 TD	90-->	S151	4714636-4754850-4764761-5001001274 7303009-7701462808-7701468342 98437726-99440728
NEW DAILY 45.10 - 49.10	VA	2,5L	8140.21 TD	90-->		4720031-4755003-4764782-7303050 7301592-7302358-98435994-99459757 5000288046-5000807860-5000813420 5001833230-5001837263-5001837264 98418986
NEW DAILY A30.8 - A 35.8 - A 40.8		2,5L	8140.61	90-->	S151	4714636-4754850-4764761-5001001274 7303009-7701462808-7701468342 98437726-99440728
	VA	2,5L	8140.61	90-->	S152	4720031-4755003-4764782-7303050 7301592-7302358-98435994-99459757 5000288046-5000807860-5000813420 5001833230-5001837263-5001837264 98418986
OM100 / 110		5,1L	8060.02		I254	93191103
OM616		3,5 L	8040.02		S139	4639182-4655010-4655054-4679242
OM-OM40 / 35		3,5 L	8040.02			93191101-4603885-4616667-4639182
ORSETTO						46545010-4655050-4655054-4655118 4655119-4679242-4679303-4679304 93191101
STRALIS	260 S 48	12880	F3BE0681E	01-->	I110	500356553
	260 S 54 / PS	12880	F3BE0681A	01-->	I110	500356553
	440 S 48	12880	F3BE0681E	01-->	I110	500356553
	440 S 54 / TP	12880	F3BE0681E	01-->	I110	500356553

A110



A111



A114



A118



J111



M617





P307



P357





	C.C.			DOLZ	OEM
JOHN DEERE					
515 TRACTORES/ TRACTORS	3 4 Cil./Cyl.	PERKINS		P357 P307	41312155-U5MW0057-U5MW0096 747542M91
TRACTORES / TRACTORS SERIES 20-30-35	Sin enfriador de aceite / Without oil cooler	2120,2020,2030, 1120,1020,1130, 2130,2035,1035, 1635		J110	AT27018
	Con tubos para enfriador de aceite / With cooling tubes	2120,2020,2030, 1120,1020,1130, 2130,2035,1035, 1635,1750		J111	13243
VIÑEDO 817	3 4 Cil./Cyl.	PERKINS		P307	747542M91
				P357	41312155-U5MW0057-U5MW0096

KASSBOHRER					
5130 - 5140	TURBINA/IMPELLER Ø 125mm	OM 407 H		M617	4032004901-4032007001-5000281838 51065006228-51065009228
S 140 - S 200 - SG 180	TURBINA/IMPELLER Ø 125mm	OM 401 - OM 407			8132000475-4032003501-4032002701 432003201-4032003401-8311999133 8312000475

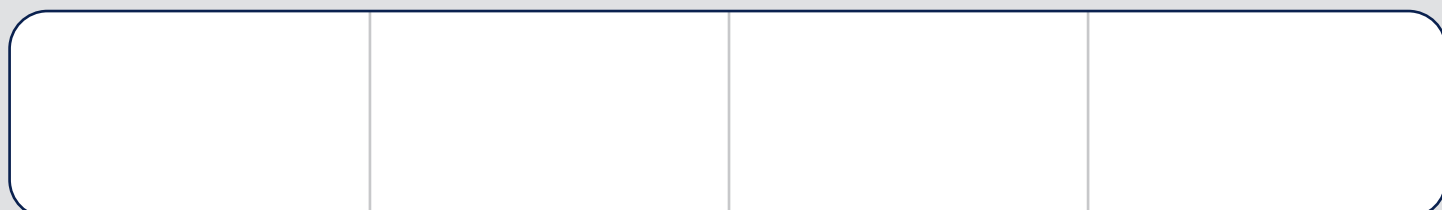
LEYLAND-BMC-SAVA					
2.5 Con plato/With hub 213.5721		14 HP		68-->	A118 12B2438-12B2747-801943-818358
415	4 4 Cil./Cyl.	77 CV	9702/5		A114 37D0457-CMK2044-CMK2045
420 FG / 550 FG / 700 FG / 3BL			9702 D	70-->	A114 37D0457-CMK2044-CMK2045
BATHGATE / BMC 3.8 Y 5.7 L / BERLIET 3.8L.			9702 D	70-72	A114 37D0457-CMK2044-CMK2045
BMC 3.4 /3.8/ 5.1/ 5.7 L MCC		18 HP		51-72	A110 AMK2807
BMC Y BRITISH LEYLAND		18 HP	D		A120 AMK2367-AMK279-AMK2808
COSMOS 5744		5,1-5,7L	9702 D	64-67	A114 37D0457-CMK2044-CMK2045
JCB EXCAVADORA/ EXCAVATOR	Todos los modelos / all models BMC		9702	68-->	A114 37D0457-CMK2044-CMK2045
LDO - 5211.211 - BMC 2.2/2.5 L		14 HP		51-71	A111 16K0099
LEYLAND FG		14 HP- 2,2 L D		69-->	A118 12B2438-12B2747-801943-818358
NUFFIELD TRACTOR		18 HP			A120 AMK2367-AMK279-AMK2808



	C.C.			DOLZ	OEM	
LEYLAND-BMC-SAVA						
S-213, S-213/1, S-213/2		14 HP		A118	12B2438-12B2747-801943-818358	
S-215 / S-217-511 / S-515			9702	A114	37D0457-CMK2044-CMK2045	
TERRIER LAIRD BOXER	Todos los modelos/ all models		9702	A114	37D0457-CMK2044-CMK2045	
		18 HP-3,8L	AUSTIN DIESEL SERIE I/II	A110	AMK2807	
		18 HP 3,4 L		55-56	A120	AMK2367-AMK279-AMK2808
		18 HP 3,8-5,1-5,7 L		55-71	A120	AMK2367-AMK279-AMK2808
MAN						
16,192		141/ 192 CV	D 0226 MKFA/ MKH	M302 ☉	51065006302-51065006374 51065006394-51065006416 51065006432-51065009432 51065006423-51065009423	
12,168 - 14,168 - 15,168	TURBINA/IMPELLER Ø 125mm		D 2555 M	M628	51065006222	
12,192F/FL/FS/FK		141/ 192 CV	D 0226 MKFA/ MKH	M302 ☉	51065006302-51065006374 51065006394-51065006416 51065006432-51065009432 51065006423-51065009423	
13,168 HA/HAK/HK	TURBINA/IMPELLER Ø 125mm		D 2556 MXF	M628	51065006222	
13,240 - 15,200 - 15,240	TURBINA/IMPELLER Ø 125mm		D 2556 M/MF	M628	51065006222	
14,170F/FL/FS/FK		125/ 170 CV	D 0226 MKF/170	M302 ☉	51065006302-51065006374 51065006394-51065006416 51065006432-51065009432 51065006423-51065009423	
14,192 H - 20, 192 D/DHR	TURBINA/IMPELLER Ø 125mm		D 2555 M/MX	M628	51065006222	
14,192F/FL/FS/FK		141/ 192 CV	D 0226 MKFA/ MKH	M302 ☉	51065006302-51065006374 51065006394-51065006416 51065006432-51065009432 51065006423-51065009423	
14,220F/FL/FS/FK		162/ 220 CV	D 0826 LF			
14.240-15.240-16.240-19.240-20.240-26.240-32.240	Interior de turbina / impeller interior diameter 12mm		D 2566 / M desde 491060-->	M178 ☉	4032004401-4032005101-4032007101 51065006282-8311999299-8311999369	

A110



A114





A118



A120



	C.C.			DOLZ	OEM
MAN					
15,192 - 16,162 - 22,192		TURBINA/IMPELLER Ø 125mm	D 2556 MF	M628	51065006222
15,220F/FL/FS/FK	162/ 220 CV		D 0826 LF	M302 Ⓚ	51065006302-51065006374 51065006394-51065006416 51065006432-51065009432 51065006423-51065009423
15,240-16.240-19.240-22.240 FNL-26.240-30.240VF		Interior de turbina / impeller interior diameter 12mm	D 2566 / MF desde 491060-->	M178 Ⓚ	4032004401-4032005101-4032007101 51065006282-8311999299-8311999369
16,168 - 19,168		TURBINA/IMPELLER Ø 125mm	D 2556 M/MX	M628	51065006222
16,220F/FL/FS/FK			D 0824 GF	M302 Ⓚ	51065006302-51065006374 51065006394-51065006416 51065006432-51065009432 51065006423-51065009423
16,240 F - 19,240 H/HA		TURBINA/IMPELLER Ø 125mm	D 2556	M628	51065006222
16,240 FT-16,200 F-19,200		TURBINA/IMPELLER Ø 125mm		M628	51065006222
16,240 H/HK/HT/HAK/HAT		TURBINA/IMPELLER Ø 125mm		M628	51065006222
16.256-19.256-26.256-30.256-32.256		Interior de turbina / impeller interior diameter 12mm	D 2538M / MF desde 3581001-->	M178 Ⓚ	4032004401-4032005101-4032007101 51065006282-8311999299-8311999369
16.262-24.262-32.262-33.262-40.262-41.262		Interior de turbina / impeller interior diameter 12mm	D 2865-D 2865 LF	M178 Ⓚ	4032004401-4032005101-4032007101 51065006282-8311999299-8311999369
16.280-20.280FVLS-22.280 FNL-26.280-30.280 VF		Interior de turbina / impeller interior diameter 12mm	D 2566 MTF desde 3644048-->	M178 Ⓚ	4032004401-4032005101-4032007101 51065006282-8311999299-8311999369
16.281 FTS-19.281F		Interior de turbina / 12mm impeller interior diameter	D 2566 MKF / 280	M178 Ⓚ	4032004401-4032005101-4032007101 51065006282-8311999299-8311999369
17,170F/FL/FS/FK	125/ 170 CV		D 0226 MKF/170	M302 Ⓚ	51065006302-51065006374 51065006394-51065006416 51065006432-51065009432 51065006423-51065009423
17,192F/FL/FS/FK/FAK	141/ 192 CV		D 0226 MKFA/ MKH		
17,220F/FL/FS/FK			D 0224 M		
18.420 HOCL			D 2866	M278 Ⓚ	4222001001-4222000501-4572000101 4572000004-51065006408-8311999928 4032004401-4032005101-4032007101 51065006282-8311999299-8311999369
19.242-24.242-32.242-33.242-40.242-41.242-48.242		Interior de turbina / impeller interior diameter 12mm	D 2866 F	M178 Ⓚ	4032004401-4032005101-4032007101 51065006282-8311999299-8311999369
19.280-26.280-32.280		Interior de turbina / 12mm impeller interior diameter	D 2566 MT desde 3644049-->	M178 Ⓚ	4032004401-4032005101-4032007101 51065006282-8311999299-8311999369



















M178

Ø 125

**M278**

Ø 135

**M302****M628**

	C.C.			DOLZ	OEM
MAN					
19.281 H.26.281 DH	Interior de turbina /12mm impeller interior diameter	D 2566 MK		M178 	4032004401-4032005101-4032007101 51065006282-8311999299-8311999369
19.292 - 32.292 - 33.292 - 40.292 - 41.292 - 48.292		D 2866 LFZ/290		M278 	4222001001-4222000501-4572000101 4572000004-51065006408-8311999928
19.332 U / UL - 24.332 UN -32.332- 33.332 - 40.332 - 41.332 - 48.292		D 2866 LFZ		M278 	4222001001-4222000501-4572000101 4572000004-51065006408-8311999928
19.343 - 33.343 F2000		D 2865		M278 	4222001001-4222000501-4572000101 4572000004-51065006408-8311999928
19.362 F/FK/FL/FS/ FT/U/UL - 33.362 - 40.362 - 41.362 - 48.362		D 2866 KF		M278 	4222001001-4222000501-4572000101 4572000004-51065006408-8311999928
19.372 - 25.372 - 26.372 -33.372 F 90		D 2866		M278 	4222001001-4222000501-4572000101 4572000004-51065006408-8311999928
19.403 - 26.403 - 33.403 - 41.403 F 2000		D 2866		M278 	4222001001-4222000501-4572000101 4572000004-51065006408-8311999928
19.422 - 25.422 - 26.422 -33.422 F 90		D 2876		M278 	4222001001-4222000501-4572000101 4572000004-51065006408-8311999928
19.462 F/FK/FL/FS		D 2840 LF/460		M278 	4222001001-4222000501-4572000101- 4572000004-51065006408-8311999928
19.463 - 26.463 - 33.463 - 41.463 F 2000		D 2866		M278 	4222001001-4222000501-4572000101 4572000004-51065006408-8311999928
20.281 FVLS-22.281 FNL-26.281 D-30.281 V	Interior de turbina / impeller interior diameter 12mm	D 2566 MKF		M178 	4032004401-4032005101-4032007101 51065006282-8311999299-8311999369
20.320 FVLS- 22.320 FNL	Interior de turbina /12mm impeller interior diameter	D 2530 MF		M178 	4032004401-4032005101-4032007101 51065006282-8311999299-8311999369
22,192 FNL/FNML	TURBINA/IMPELLER Ø 125mm			M628	51065006222
22,24 -24,240 FVL - 26,240/DF-30,240 - 24,192 FVL	TURBINA/IMPELLER Ø 125mm			M628	51065006222
24.362 UNL-32.362- 33.362		D 2866 KFZ		M278 	4222001001-4222000501-4572000101 4572000004-51065006408-8311999928
32,232 DH/DHA - 32,240 DH/DHA	TURBINA /IMPELLER Ø 125mm			M628	51065006222
32.462 - 33.462 - 40.462 - 48.462		D 2540		M278 	4222001001-4222000501-4572000101 4572000004-51065006408-8311999928
33.365		D 2840 MF		M278 	4222001001-4222000501-4572000101 4572000004-51065006408-8311999928



M178

Ø125



**M278**

Ø135

**M302****M303****M632****M633****M634**

	C.C.			DOLZ	OEM
MAN					
8,192 - 13,168 F - 13,192 F	TURBINA/IMPELLER Ø 125mm		D 2555	M628	51065006222
AUTOCARRI-12,170 F/FL/FS/FK		125/170 CV	D 0226 MKF/170	M302 Ⓞ	51065006302-51065006374 51065006394-51065006416 51065006432-51065009432 51065006423-51065009423
D2865/2866/2876			OM-422/441/442	M633 Ⓞ	4222001201-51065006479 51065009479-4032011701 51065010214-4032007501-8311998320
F 2000 SERIES	6 4 Cil./Cyl.		D 2866 LF/LXF - D 2876 LF/LXF	M632	51065006492
			19503 D 2840 LF-19603 D 2840 LF	M634	51065006426-51065009426
F 90 SERIES	5 4 Cil./Cyl.		D 2865 LF	M632	51065006492
			D 2840 L-19502-26502 - 33502	M634	51065006426-51065009426
FRH 422/L - FRH 422 / S			D 2866	M278 Ⓞ	4222001001-4222000501-4572000101 4572000004-51065006408-8311999928
L 2000 SERIES 6.103 6.113- 8.153- 8.163- 8.224- 9.153- 10.153- 10.224	TURBINA/IMPELLER Ø 125mm			M303 Ⓞ	51065006476-51065009476
L 90 SERIES 6.100- 8.150-9.150-10.150	TURBINA/IMPELLER Ø 125mm		D0824LF-D0826LF D 0826 LF 01/05- D 0826 LF 02/06- D 0826 LF 214	M303 Ⓞ	51065006476-51065009476
M 2000 SERIES 12.192 - 12.232 - 14.232 - 11.224 - 13.224 - 15.224	TURBINA/IMPELLER Ø 125mm			M303 Ⓞ	51065006476-51065009476
M90 SERIES 12.192 14.232 - 17.232	TURBINA/IMPELLER Ø 125mm		D 0824 LFL - D 0826 LFL 03	M303 Ⓞ	51065006476-51065009476
SERIE F 2000	5 4 Cil./Cyl.		D 2865 LF	M618	51065006547
	5 Cil./Cyl.		D 2865 LF	M619	51065006546
	6 Cil./Cyl.		D 2866 LF - LXF	M618	51065006547
	6 Cil./Cyl.		D 2866 LF - LXF	M619	51065006546
	6 Cil./Cyl.		D 2876 LF	M618	51065006547
	6 Cil./Cyl.		D 2876 LF	M619	51065006546
SG 192 - SL 200 - SUE 240	TURBINA/IMPELLER Ø 125mm		4091102 - 4077098	M617	4032004901-4032007001-5000281838 51065006228-51065009228
SR 240 - SR 280	TURBINA/IMPELLER Ø 125mm		D 2566 MUH - D 2566 MTUH - D 2530		8132000475-4032003501-4032002701 432003201-4032003401-8311999133 8312000475

M617**M618****M619****M628**



	C.C.			DOLZ	OEM
MAN					
SR 280 FRH - SG 280	Turbina/impeller Ø 125mm		D 2538 - D 2556 - D 2566	M617	4032004901-4032007001-5000281838 51065006228-51065009228 8132000475-4032003501-4032002701 432003201-4032003401-8311999133 8312000475
TGA 18.480 FAC/ FAK/FAK-L/FC	PLATFORM / CHASSIS	12816 - 353KW 480 CV	D 2876 LF12	09/02	M307 51065007045-51065007047 51065007048-51065007065 51065007066-51065009048
TGA 18.480 FK/ FLC/FLLC/FLLW	DUMP TRUCK	12816- 353KW 480 CV	D 2876 LF12	09/02	51065009052-51065009066 51065009548-51065007052 51065007051-51065007043
TGA 18.480 FLS/ FLLS/FLLS- N/FLS-TS	PLATFORM / CHASSIS	12816- 353KW 480 CV	D 2876 LF12	09/02	51065007036-51065007033
TGA 18.510 FC/ FLC/FLLC/FLLC-N	PLATFORM / CHASSIS	12816- 375KW 510 CV	D 2876 LF05	09/00	
TGA 18.510 FLS/ FLLS-N/FLLW	TRUCK TRACTOR	12816- 375KW 510 CV	D 2876 LF05	04/00	
TGA 18.530 FC/ FLC/FLLC/FLLW/ FLS/FLLS	TRUCK TRACTOR	12816- 390KW 530 CV	D 2876 LF13	09/02	
TGA 18.530 FLLS-N/FLLW	TRUCK TRACTOR	12816- 390KW 530 CV	D 2876 LF13	09/02	
TGA 24.480 FDAC/ FDAQ/FDAS/ FDC/FDLC	PLATFORM / CHASSIS	12816- 353KW 480 CV	D 2876 LF12	09/02	
TGA 24.480 FDK/ FDLK/FDS/ FDLS/FDLS-M	PLATFORM / CHASSIS	12816 - 353KW 480 CV	D 2876 LF12	09/02	
TGA 24.480 FD-TM/ FNLC/FNLLC/ FVLC/FVLLW	PLATFORM / CHASSIS	12816- 353KW 480 CV	D 2876 LF12	09/02	
TGA 24.480 FNLS/ FNLLS/FPLS/ FVLS/FVL-KO	PLATFORM / CHASSIS	12816- 353KW 480 CV	D 2876 LF12	09/02	
TGA 24.480 FNNLC-N	PLATFORM / CHASSIS	12816- 353KW 480 CV	D 2876 LF12	09/02	
TGA 24.510 FNLLC-N	PLATFORM / CHASSIS	12816- 375KW	D 2876 LF05	09/01	

M307



M617







		C.C.			DOLZ	OEM
MAN						
TGA 24.530 FBLLC-N	PLATFORM / CHASSIS	12816- 390KW 530 CV	D 2876 LF13	09/01	M307	51065007045-51065007047 51065007048-51065007065 51065007066-51065009048 51065009052-51065009066 51065009548-51065007052 51065007051-51065007043 51065007036-51065007033
TGA 26.510 FDC/ FDLC/FDC-M/ FDS/FDLS	PLATFORM / CHASSIS	12816- 375KW 510 CV	D 2876 LF05	01/01		
TGA 26.510 FDC/ FDLC/FDC-M/ FDS/FDLS	TRUCK TRACTOR	12816- 375KW 510 CV	D 2876 LF05	01/01		
TGA 26.510 FDLS- M/FNLC/FNLLC/ FNLLW	PLATFORM / CHASSIS	12816- 375KW 510 CV	D 2876 LF05	12/00		
TGA 26.510 FVLC/ FNLS/FNLLS/ FPLS/FLS	PLATFORM / CHASSIS	12816- 375KW 510 CV	D 2876 LF05	09/00		
TGA 26.530 FDC/ FDLC/FDC-M/ FDS/FDLS	PLATFORM / CHASSIS	12816- 390KW 530 CV	D 2876 LF13	01/01		
TGA 26.530 FDC/ FDLC/FDC-M/ FDS/FDLS	TRUCK TRACTOR	12816- 390KW 530 CV	D 2876 LF13	01/01		
TGA 26.530 FDLS- M/FNLC/FNLLC/ FNLLW	PLATFORM / CHASSIS	12816- 390KW 530 CV	D 2876 LF13	01/01		
TGA 26.530 FVLC/ FNLS/FNLLS/ FPLS/FLS	PLATFORM / CHASSIS	12816- 390KW 530 CV	D 2876 LF13	09/02		
TGA 26.530 FVLS/ FPLS	PLATFORM / CHASSIS	12816- 390KW 530 CV	D 2876 LF13	09/02		
TGA 32.480 FFDLC/ FFDLC/FFDK/ FFDLK/FFD-TM	PLATFORM / CHASSIS	12816- 353KW 480 CV	D 2876 LF12	09/02		
TGA 32.480 FFDLC/ FFDLC/FFDK/ FFDLK/FFD-TM	CONCRETE MIXER	12816- 353KW 480 CV	D 2876 LF12	09/02		
TGA 33.480 FDAC/ FDAK/FDAS/ FDC/FDK	PLATFORM / CHASSIS	12816- 353KW 480 CV	D 2876 LF12	09/02		
TGA 33.480 FDAC/ FDAK/FDAS/ FDC/FDK	DUMP TRUCK	12816- 353KW 480 CV	D 2876 LF12	09/02		



--	--	--	--	--	--	--

--	--	--	--	--	--	--



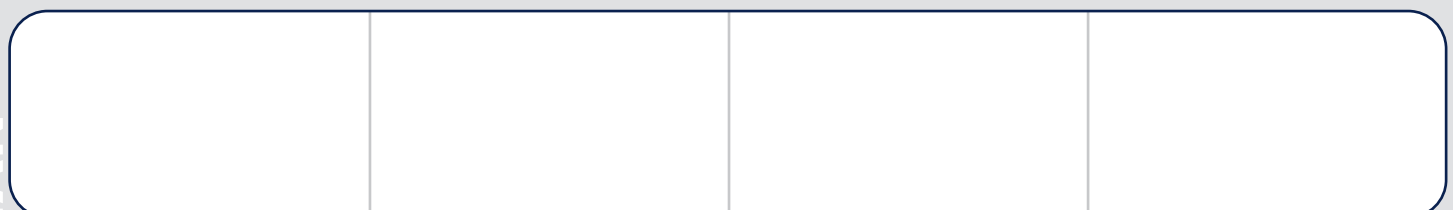
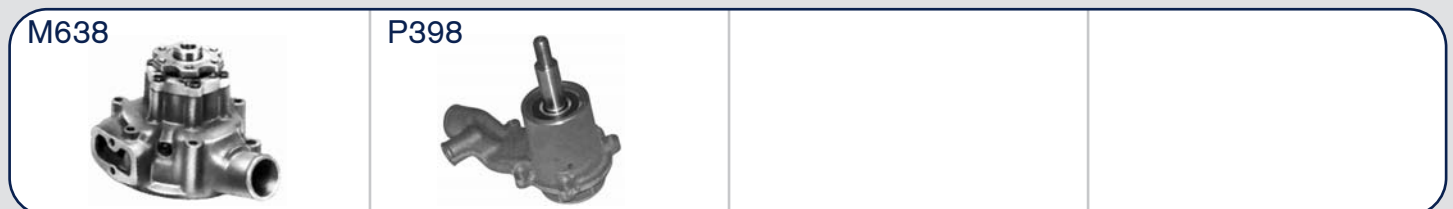









--	--	--	--	--	--	--

	C.C.			DOLZ	OEM		
MAN							
TGA 33.480 FDAC/ FDAK/FDAS/ FDC/FDK	TRUCK TRACTOR	12816- 353KW 480 CV	D 2876 LF12	09/02	M307	51065007045-51065007047 51065007048-51065007065 51065007066-51065009048 51065009052-51065009066 51065009548-51065007052 51065007051-51065007043 51065007036-51065007033	
TGA 33.480 FDS/ FD-TM	PLATFORM / CHASSIS	12816- 353KW 480 CV	D 2876 LF12	09/02			
TGA 33.480 FDS/FD-TM	TRUCK TRACTOR	12816- 353KW 480 CV	D 2876 LF12	09/02			
TGA 33.480 FDS/FD-TM	CONCRETE MIXER	12816- 353KW 480 CV	D 2876 LF12	09/02			
TGA 33.510 FDC/ FDC-M/FDS	TRUCK TRACTOR	12816- 375KW 510 CV	D 2876 LF05	09/00			
TGA 33.530 FDC/ FDC-M/FDS	PLATFORM / CHASSIS	12816- 390KW 530 CV	D 2876 LF13	09/02			
V 4200 (TGA)			D 2866 LF26/28/ 32/36/37				
V 4300 (TGA)			D 2876 LF04/07				
	Interior de turbina/ 8mm impeller interior diameter		OM 441 - OM 442			M078	4412000201-4412000301
	Interior de turbina/ 8mm impeller interior diameter		BM 441.900/19			M078	4412000201-4412000301
			D 0226 MC/ MCFO/M		M302 	51065006302-51065006374 51065006394-51065006416 51065006432-51065009432 51065006423-51065009423	
			D 0826 GF/ GFA 01				
	Turbina/impeller Ø 125mm		D 2530 MXF/ MXFR/MXH -->3358072			M617	4032004901-4032007001-5000281838 51065006228-51065009228 8132000475-4032003501-4032002701 432003201-4032003401-8311999133 8312000475
	Turbina/impeller Ø 125mm		D 2538 M/MR/MF/ MFR 2001001 -->3581000				
	Turbina/impeller Ø 125mm		D 2556 M/MX/ MXF/MR/MFR/ MXR/MXFR/MFO/ MXFO/MXFOR				
	Turbina/impeller Ø 125mm		D 2566 MT/ MTF-->3644048				
	Turbina/impeller Ø 125mm		D 2566 M/MR/ MF/MFR -->4091059				





	C.C.			DOLZ	OEM
MASSEY FERGUSON					
MF 22 C - MF 220	Eje largo/long axis 198,65 mm			P398	41313226-41313233-41313212 U5MW0106
MERCEDES					
0302 OM	Turbina/impeller Ø 95mm	OM 352		M612 Ⓢ	3532005601-3522003401-3522005401 3522007201-3522007501-3522008101 3522008501-3522008901-3522009201 3522009501-3522009601-3522009701 3532001601-3532001701-3532003801
0309 D	Turbina/impeller Ø 95mm	OM 352			
1000 / 441		OM 352 A		M638	3532002001
1017		148/ 201 CV	OM 366 LA	M610 Ⓢ	3662005901-3662000401-3662000901
1019 - 1219 - 1419 F/L/LS/S	Turbina/impeller Ø 125mm			M617	4032004901-4032007001-5000281838 51065006228-51065009228 8132000475-4032003501-4032002701 432003201-4032003401-8311999133 8312000475
1019-1219-1419- 1619L	Turbina/impeller Ø 125mm	OM 401 BM 356			
1019-1219-1419F/L/ LS/S-1424/F-1619L- 1619S-1719-1819- 1919-2219/L/K-2419	Interior de turbina / impeller interior diameter 12mm	OM 401.129661->		M178 Ⓢ	4032004401-4032005101-4032007101 51065006282-8311999299-8311999369
1113-1114-1516	6 Cil./Cyl.-W/OUT BACKPLATAE	OM 352	69-->	M611	3522003801-3522004901-3522007401 3522008401-3522009301-3522009401 3532000301-3532000401-3532002101 3532003601-3532003701
1114		100/ 136 CV	OM 366	M610 Ⓢ	3662005901-3662000401-3662000901
1117		125/ 170 CV	OM 366 A	M610 Ⓢ	3662005901-3662000401-3662000901
1120		148/ 201 CV	OM 366 LA	M610 Ⓢ	3662005901-3662000401-3662000901
1215			OM 366 1215- 1615-2115 Y LOS MOD OH	M610 Ⓢ	3662005901-3662000401-3662000901
1217 S OM 362- 1419 C/CL/L/LS - 1420-1420L-1617- 1619 C-1620-2219- 2219 CL-2220- 2222 OM 362 LA	Turbina/impeller Ø 95mm	OM 362		M612 Ⓢ	3532005601-3522003401-3522005401 3522007201-3522007501-3522008101 3522008501-3522008901-3522009201 3522009501-3522009601-3522009701 3532001601-3532001701-3532003801
1222-1422-1621S- 1622-OH 1622- 1922-2221	Interior de turbina / impeller interior diameter 12mm	OM 421			







M610**M611****M612****M617**

	C.C.			DOLZ	OEM
MERCEDES					
1222-1422-1622- 1722-1922-2222- 2225-2422-2426- 2429		OM 441 --> .504397		M178 	4032004401-4032005101-4032007101 51065006282-8311999299-8311999369
1300/443-1500/443		OM 352		M637	3532003901
1314	100/ 136 CV	OM 366		M610 	3662005901-3662000401-3662000901
1317	125/ 170 CV	OM 366 A		M610 	3662005901-3662000401-3662000901
1319 - OF 1417 - LA 1517		OM 360		M623	3602004601
1320 - 1320 S	148/ 201 CV	OM 366 LA		M610 	3662005901-3662000401-3662000901
1414	100/ 136 CV	OM 366		M610 	3662005901-3662000401-3662000901
1417-1517-1120- 1320	170 CV	OM 366 LA EURO 2 357,920 / 927		M636	3662000301-3662000501-3662001501 3662006001
1417 - OH 1417	125/ 170 CV	OM 366 A		M610 	3662005901-3662000401-3662000901
1419 C/CL/L/LS	148/ 201 CV	OM 366 LA		M610 	3662005901-3662000401-3662000901
1424 F - 1619 L/S - 1719 - 1819	Turbina/impeller Ø 125mm			M617	4032004901-4032007001-5000281838 51065006228-51065009228 8132000475-4032003501-4032002701 432003201-4032003401-8311999133 8312000475
1425-1625-1628- 1928-2025-2028- 2225-2228-2628- 3025-3028-3228- 3328		OM 422		M178 	4032004401-4032005101-4032007101 51065006282-8311999299-8311999369
1426-1625-1726- 1729-1928-1929- 2225-2422-2426- 2429-2629-3529		OM 442 -->.504397		M178 	4032004401-4032005101-4032007101 51065006282-8311999299-8311999369
1517 - 1813 - 323 - O 321H- O 321HL	Turbina/impeller Ø 87mm Turbina/impeller Ø 87mm Turbina/impeller Ø 87mm			M620 M620 M620	3532004001 3532004001 3532004001
1520		148/ 201 CV	OM 366 LA	M610 	3662005901-3662000401-3662000901
1520 - 1720 - 1820		211 CV		M636	3662000301-3662000501-3662001501 3662006001









M178**M610****M617****M620**

		C.C.			DOLZ	OEM
MERCEDES						
1528	Atego - L Atego	205KW 280 CV	OM 906.910 LA		M630	9042002601-9042000801-9042000401 9042004901-9042010701-9042010201 9042000601-9042002201-9042002001
1614		100/ 136 CV	OM 366		M610 Ⓢ	3662005901-3662000401-3662000901
1617		125/ 170 CV	OM 366 A		M610 Ⓢ	3662005901-3662000401-3662000901
		148/ 201 CV	OM 366 LA		M610 Ⓢ	3662005901-3662000401-3662000901
1619		148/ 201 CV	OM 366 LA		M610 Ⓢ	3662005901-3662000401-3662000901
1619 - 1621 - 1817 - 1819 - 2219			OM 360		M623	3602004601
1619-2219-1719- 1919			OM 401 A		M617	4032004901-4032007001-5000281838 51065006228-51065009228 8132000475-4032003501-4032002701 432003201-4032003401-8311999133 8312000475
1620		148/ 201 CV	OM 366 LA		M610 Ⓢ	3662005901-3662000401-3662000901
1623 K/L/LP - 1926 - 1932	Turbina/impeller Ø 125mm				M617	4032004901-4032007001-5000281838 51065006228-51065009228
1624 - 1626 K/L/LP- 1924 L	Turbina/impeller Ø 125mm					8132000475-4032003501-4032002701 432003201-4032003401-8311999133 8312000475
1624-1626K/L/LP- 1924L-1926K/AK- 2026-2224B/K- 2226-2626AB/AK	Interior de turbina / impeller interior diameter 12mm		OM 402.129661->		M178 Ⓢ	4032004401-4032005101-4032007101 51065006282-8311999299-8311999369
1626K/L/LP-1632K/ L/LP-1929-1932- 2032 6x2-2226-2232 2626AB/AK-2632AK /AS-3032 8x4	Interior de turbina / impeller interior diameter 12mm		OM 403.129661->		M178 Ⓢ	4032004401-4032005101-4032007101 51065006282-8311999299-8311999369
1628-1733-2228- 2433			OM 441 LA -->.504397		M178 Ⓢ	4032004401-4032005101-4032007101 51065006282-8311999299-8311999369
1633-1933-2033- 2233-2633-3333 8x4			OM 422 A		M178 Ⓢ	4032004401-4032005101-4032007101 51065006282-8311999299-8311999369
1635-1635L-1735- 1935-2035S/LS- 2235-2435-2635- 3235-3535			OM 442 A -->.504397		M178 Ⓢ	4032004401-4032005101-4032007101 51065006282-8311999299-8311999369
1636-1936-2036- 2236-2636-3333 8x4			OM 423		M178 Ⓢ	4032004401-4032005101-4032007101 51065006282-8311999299-8311999369













M623**M630****M636****M637**

	C.C.			DOLZ	OEM
MERCEDES					
1638-1938-2238-2638		OM 422 LA		M178 	4032004401-4032005101-4032007101 51065006282-8311999299-8311999369
1644-1748-1944-1944S-1948-2244-2448-2644-2648		OM 442 LA -->.504397		M178 	4032004401-4032005101-4032007101 51065006282-8311999299-8311999369
1720 NAW	150/ 204 CV	OM 366 LA		M610 	3662005901-3662000401-3662000901
1819-1424-1624-1924		OM 402		M617	4032004901-4032007001-5000281838 51065006228-51065009228 8132000475-4032003501-4032002701 432003201-4032003401-8311999133 8312000475
1823	ATEGO - L ATEGO - AK ATEGO	170KW 231CV	OM 906.920 LA	M630	9042002601-9042000801-9042000401 9042004901-9042010701-9042010201 9042000601-9042002201-9042002001
	K ATEGO - LS ATEGO	170KW 231CV	OM 906.920 LA		
	A ATEGO - K ATEGO - L ATEGO	205KW 280CV	OM 906.921 LA		
	AK ATEGO - LS ATEGO	205KW 280CV	OM 906.923 LA		
1831 -1835 -1840 -1843	Sin retardador/ without retarder CHASIS SA088414 - SA088613		OM 501 LA - OM 502 A	M624	5412000101-5412000001-5412000201 5412000701-5412001101-5412001201 5422000501-5422001501-5422001901 5422010001-5422010301
	Con retardador/with retarder chasis SA088414-SA088613		OM 501 LA - OM 502 A	M625	5412001001-5412010101-5412010301 5422000601-5422002001-5422010401
1848 - 1853 - 1857	Sin retardador/ without retarder		OM 502 LA	M624	5412000101-5412000001-5412000201 5412000701-5412001101-5412001201 5422000501-5422001501-5422001901 5422010001-5422010301
	Con retardador/ with retarder		OM 502 LA	M625	5412001001-5412010101-5412010301 5422000601-5422002001-5422010401
1919 - 2219 L/LK - 2419	Turbina/impeller Ø 125mm			M617	4032004901-4032007001-5000281838 51065006228-51065009228 8132000475-4032003501-4032002701 432003201-4032003401-8311999133 8312000475
1924		177/ 240HP	OM 355 BRAZIL	M615 	3452007101
1926 K/AK - 2026 - 2224 B/K	Turbina/impeller Ø 125mm			M617	4032004901-4032007001-5000281838 51065006228-51065009228 8132000475-4032003501-4032002701 432003201-4032003401-8311999133 8312000475

M178**M278****M610****M612****M625****M629****M630****M648**

	C.C.			DOLZ	OEM
MERCEDES					
1929		OM 355 BRAZIL		M615 	3452007101
1938 - 1938 S - 1938 LS	Turbina/impeller Ø 135mm	OM 457 LA		M629	4572000201-4572000104
1944 S - 1944 L - 1944 LS	Turbina/impeller Ø 135mm	OM 457 LA		M629	4572000201-4572000104
2032 6x2 - 2226 - 2232 - 2626 AB/AK	Turbina/impeller Ø 125mm			M617	4032004901-4032007001-5000281838 51065006228-51065009228 8132000475-4032003501-4032002701 432003201-4032003401-8311999133 8312000475
2219		148/ 201 CV	OM 366 LA	M610 	3662005901-3662000401-3662000901
		141/ 192 HP	OM 355 BRAZIL	M615 	3452007101
2220 - 2222		148/ 201 CV	OM 366 LA	M610 	3662005901-3662000401-3662000901
2224-1626-1926- 2626			OM 403 BM 910-935	M617	4032004901-4032007001-5000281838 51065006228-51065009228 8132000475-4032003501-4032002701 432003201-4032003401-8311999133 8312000475
2226 - 2626 AB/AK- 1626 K/L/LP	Turbina/impeller Ø 125mm				
2523	L ATEGO	205KW 280CV	OM 906.923 LA	M630	9042002601-9042000801-9042000401 9042004901-9042010701-9042010201 9042000601-9042002201-9042002001
2528	L ATEGO	205KW 280CV	OM 906.923 LA		
2628	ATEGO - B ATEGO - K ATEGO	205KW 280CV	OM 906.921 LA		
2638 - 1944 LK	Turbina/impeller Ø135mm		OM 457 LA	M629	4572000201-4572000104
311 L/LA/LP/LAP - 312 L/LA/LP/LAP	Turbina/impeller Ø 87mm		OM 352 --> 018151	M620	3532004001
322 - 327 - 1113 - 1313 - 1317	Turbina/impeller Ø 87mm			M620	3532004001
3250 - 3850 - 4050			OM423 LA 500CV	M278 	4222001001-4222000501-4572000101 4572000004-51065006408-8311999928
328 L/LA/LP/LAP - 911 L/LA/LP/LAP	Turbina/impeller Ø 87mm		OM 352 --> 034435	M620	3532004001
352 BM	Turbina/impeller Ø 95mm		OM 352	M612	3532005601-3522003401-3522005401 3522007201-3522007501-3522008101 3522008501-3522008901-3522009201 3522009501-3522009601-3522009701 3532001601-3532001701-3532003801
352 BM 353	Turbina/impeller Ø 95mm		OM 353		
408 - 508 - LF 508 - 608			OM 314 459637 --->	M648	3142004101-3142004701

M615**M617****M620****M624**

	C.C.			DOLZ	OEM
MERCEDES					
408-508-LF508-608		62,5/ 85 CV	OM 314	M613 	3142000601-3142000801-3142001901 3142002101-3142002401-3142002901 3142003701-3142003901-3142004201
709 - 808 - 809			OM 314 459637 --->	M648	3142004101-3142004701
710 - 911 B/L/LA - O 322	Turbina/impeller Ø 87mm		OM 352 --> 011957	M620	3532004001
808-809		62,5/ 85 CV	OM 314	M613 	3142000601-3142000801-3142001901 3142002101-3142002401-3142002901 3142003701-3142003901-3142004201
814			OM366	M610 	3662005901-3662000401-3662000901
817			OM366	M610 	3662005901-3662000401-3662000901
817 - 917 - 1117 - 1317		125KW 155KW	OM 366 LA EURO 2 357,900 / 919	M636	3662000301-3662000501-3662001501 3662006001
914		100/ 136 CV	OM 366	M610 	3662005901-3662000401-3662000901
914/15/16/18	Turbina/impeller Ø 125mm		OM 421 017467 -->129660	M617	4032004901-4032007001-5000281838 51065006228-51065009228 8132000475-4032003501-4032002701 432003201-4032003401-8311999133 8312000475
917		125/ 170 CV	OM 366 A	M610 	3662005901-3662000401-3662000901
BM 355 910, 912- 914,916,918,960, 962-967,969,977- 984				M614 	3552000101-3552000501-3552000601 3552000801-3552000901-3552001101 3552001501
BM 355 A					
ECOLINER / 1850 - 2050			OM 423 LA	M278 	4222001001-4222000501-4572000101 4572000004-51065006408-8311999928
F 150 - LP 1317 - OF 1317			OM 360	M623	3602004601
H 905/908/909/910/ 911/913/914/915/ 916/918 / O 305 - O 305 G - O 307	Interior de turbina/ impeller interior diameter 12 mm		OM 407 . 017498-->	M178 	4032004401-4032005101-4032007101 51065006282-8311999299-8311999369
LP 1317 - OF 1317 - OF 1417 - LP 1517	"C. IZQ"		OM 360	M622	3602003701-3602004501
LP 1517 - LA 1519 - LP 1519			OM 360	M623	3602004601
LP 1519 - LP 1617 - 1619 - OF 1621 - 2219	"C. IZQ"		OM 360	M622	3602003701-3602004501



M178

Ø125

**M278**



Ø135

**M610****M612****M620****M622****M623****M636**

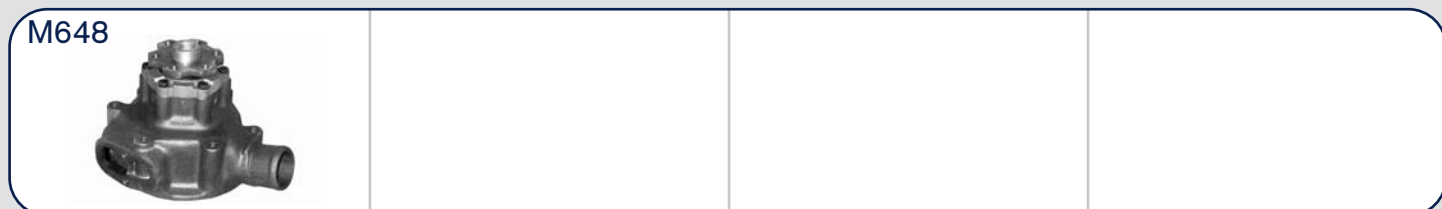
	C.C.			DOLZ	OEM
MERCEDES					
LP 1632-LP 2232- O 303		OM 404		M617	4032004901-4032007001-5000281838 51065006228-51065009228 8132000475-4032003501-4032002701 432003201-4032003401-8311999133 8312000475
LP 810 - LP 813 - 911B	Turbina/impeller Ø 95mm	OM 352.985		M612 Ⓢ	3532005601-3522003401-3522005401 3522007201-3522007501-3522008101 3522008501-3522008901-3522009201 3522009501-3522009601-3522009701 3532001601-3532001701-3532003801
MB-TRAC 65/70		70/ 95 CV	OM 314	M613 Ⓢ	3142000601-3142000801-3142001901 3142002101-3142002401-3142002901 3142003701-3142003901-3142004201
MB-TRAC 700/440		48/ 65 CV	OM 314		
MB-TRAC 800/440		48/ 65 CV	OM 314		
MB-TRAC 900/440		48/ 65 CV	OM 314		
MB-TRAC 95/105		70/ 95 CV	OM 314		
O 301		100/ 136 CV	OM 366	M610 Ⓢ	3662005901-3662000401-3662000901
		125/ 170 CV	OM 366 A	M610 Ⓢ	3662005901-3662000401-3662000901
O 303	Interior de turbina/ 12 mm impeller interior diameter		OM 401 . 129661-->	M178 Ⓢ	4032004401-4032005101-4032007101 51065006282-8311999299-8311999369
			OM 402 . 129661-->		
			OM 403 . 129661-->		
			OM 421 - 421 A		
			OM 422 - 422 A		
			OM 441-441 A -->.504397		
O 303 - O 305 - O 305 G	Turbina/impeller Ø 125mm Turbina/impeller Ø 125mm		OM 401 ---> 129660	M616	4032003701-4032005201-4032007201 8311231928
			OM 401 - OM 402	M617	4032004901-4032007001-5000281838 51065006228-51065009228 8132000475-4032003501-4032002701 432003201-4032003401-8311999133 8312000475



MERCEDES

	C.C.			DOLZ	OEM
MERCEDES					
O 303 - O 330 - O 305 G		OM 402 LA EURO1 - BM 984		M626	4032007301-4032005301-8311999294
O 305-O 307		OM 404 A		M617	4032004901-4032007001-5000281838 51065006228-51065009228 8132000475-4032003501-4032002701 432003201-4032003401-8311999133 8312000475
O 307	Cambio automático y retardador/Automatic transmission and retarder	OM 407 ---> 017497		M616	4032003701-4032005201-4032007201 8311231928
O 307 - 905/8/9/ 10/11/13	Turbina/impeller Ø 125mm	OM 403 - OM 407 H		M617	4032004901-4032007001-5000281838 51065006228-51065009228 8132000475-4032003501-4032002701 432003201-4032003401-8311999133 8312000475
O 309-O 309 D		63,5/ 85 CV	OM 314	M613 Ⓢ	3142000601-3142000801-3142001901 3142002101-3142002401-3142002901 3142003701-3142003901-3142004201
O 355-O 364		177/ 240HP	OM 355 BRAZIL	M615 Ⓢ	3452007101
O 402		100/ 132 CV	OM 366	M610	3662005901-3662000401-3662000901
		125/ 170 CV	OM 366 A	M610	3662005901-3662000401-3662000901
O 405 - O 405 N1 - O 405 G		OM 407 /H/A/LA/ HA - BM 919		M626	4032007301-4032005301-8311999294
O 405 GN		OM 427 H - BM 905 -BM 911		M626	4032007301-4032005301-8311999294
O 405 GN1		BM 920 -OM 427/ A/LA/HA -BM 950		M626	4032007301-4032005301-8311999294
O 405 GTD - O 405 H		OM 441 A/LA - BM 994		M626	4032007301-4032005301-8311999294
O 405 ST		OM 427 H.910		M178 Ⓢ	4032004401-4032005101-4032007101 51065006282-8311999299-8311999369
O 405 ST/BU 5-25/ BGU-25/BGH 4-23/ BH 3-N		BM 951 - BM 952		M626	4032007301-4032005301-8311999294
O 409 DG		63,5/ 85 CV	OM 314	M613 Ⓢ	3142000601-3142000801-3142001901 3142002101-3142002401-3142002901 3142003701-3142003901-3142004201
O302 OM-352 BM- 352 BM 353 - O 309 D OM 352	Turbina/impeller Ø 95mm	OM 362 LA		M612 Ⓢ	3532005601-3522003401-3522005401 3522007201-3522007501-3522008101 3522008501-3522008901-3522009201 3522009501-3522009601-3522009701 3532001601-3532001701-3532003801

M078



M178



M610



M612



M626



M627









M630







M633





	C.C.			DOLZ	OEM	
MERCEDES						
OH 1419/1517/1519		OM 355 BRAZIL		M615 	3452007101	
OM 441 LA/ 442 LA	Versiones con cambio de marcha automatico/automatic transmission versions	OM-441/422/442		M633 	4222001201-51065006479 51065009479-4032011701 51065010214-4032007501-8311998320	
OM 904 - OM 906 - OM909				M630	9042002601-9042000801-9042000401 9042004901-9042010701-9042010201 9042000601-9042002201-9042002001	
OM 910 - OM 911 - OM 919						
OM 920 - OM 921						
OM 922 - OM 923						
TODOS LOS MODELOS/ ALL MODELS	cambio automático y retardador, turbina 135mm/automatic transmission and retarder, impeller 135mm	OM 422 ---> 146024		M627	4222001101-8311999929	
U 1000 - U 1000 L - U 1000 T				M637	3532003901	
U 110/406 - U 110/416 - U 120/425		OM 352 A		M637	3532003901	
U 1200 - U 1300 L - U 1500				M637	3532003901	
U 1700 L				M637	3532003901	
U 54/403		40/ 50 CV	OM 314	M613 	3142000601-3142000801-3142001901 3142002101-3142002401-3142002901 3142003701-3142003901-3142004201	
U 60/413		59/ 80 CV	OM 314.953			
U 66/403		48/ 65 CV	OM 314			
U 72/403-U 72/413			OM 314			
U 80/413-U 80/416			OM 314			
U 800-U 800 L		55/ 75 CV	OM 314			
	Interior de turbina / 8mm impeller interior diameter		OM 441 - OM 442		M078	4412000201-4412000301
	Interior de turbina / 8mm impeller interior diameter		BM 441.900/19		M078	4412000201-4412000301
			OM 407	M617	4032004901-4032007001-5000281838 51065006228-51065009228 8132000475-4032003501-4032002701 432003201-4032003401-8311999133 8312000475	
			OM 407 A BM 900-918/930-952			
			OM 447 HLA EURO2-BM 970- BM 994		M626	4032007301-4032005301-8311999294



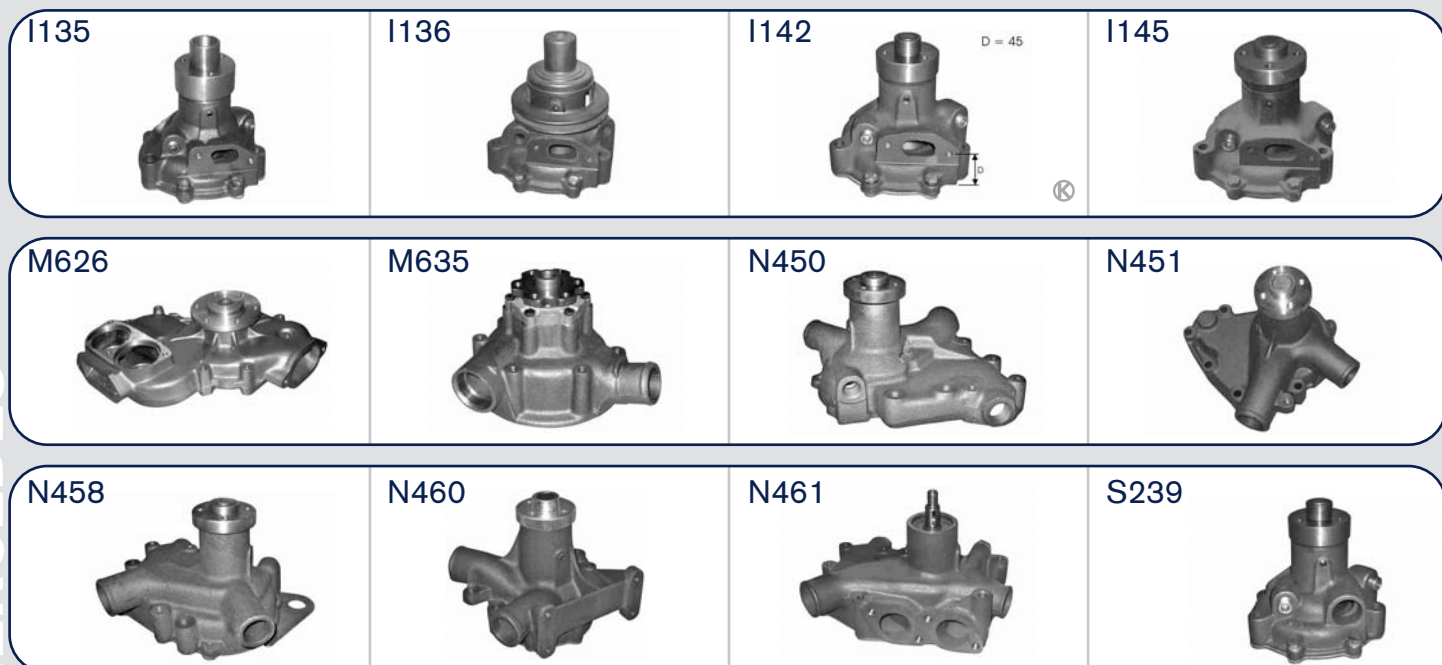





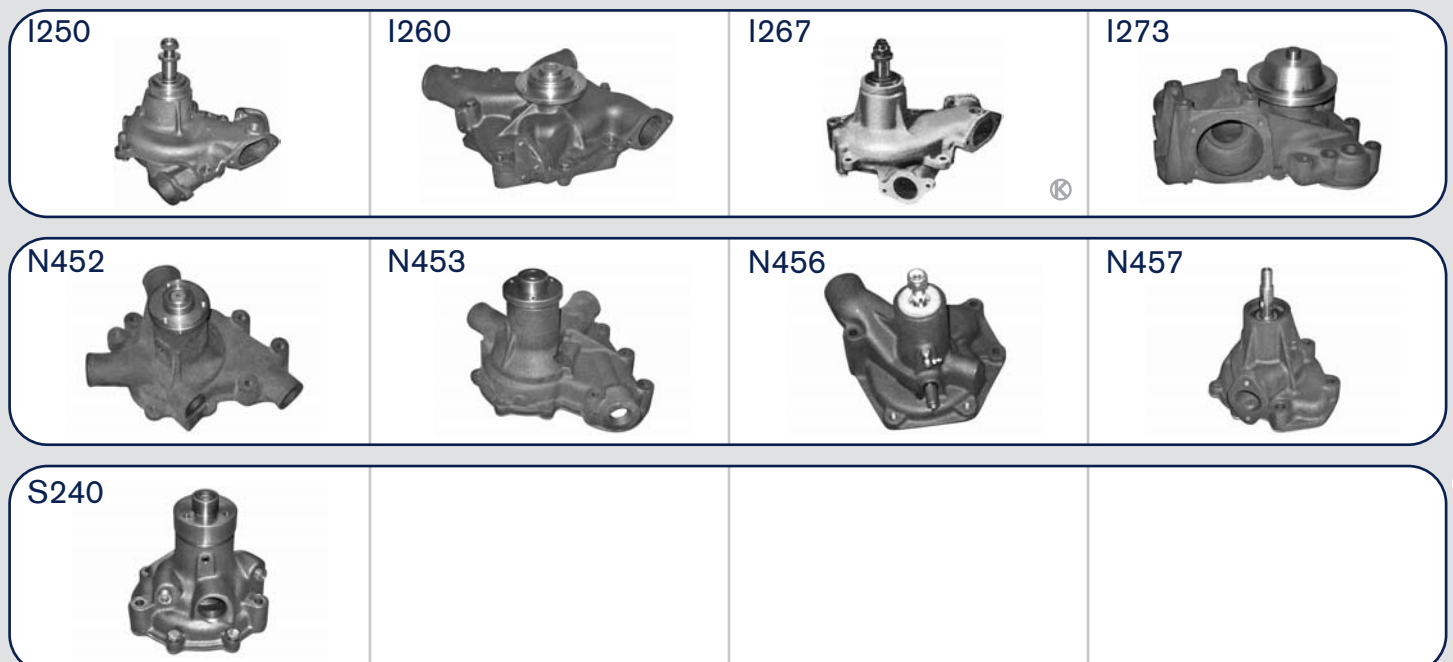







M613**M615****M616****M617****M637**

	C.C.			DOLZ	OEM
MERCEDES					
		OM 447/A/LA/HA-BM 950/1/2/3/55/56/57/59/80/1/2/3/4/86		M626	4032007301-4032005301-8311999294
		OM 447 H - BM 905/7/8/10/11/13/14/16		M626	4032007301-4032005301-8311999294
		OM 364 /A/LA - BM 354,900/1/2/3/20/1/2/3/4/5		M635	3642000101-3642000901-3642002001
		BM 364,906/7/11/12/13/16/17/18/19/20/21/50/52/54/5/6/7/8/81/82/3/4/5/6/7		M635	3642000101-3642000901-3642002001
NEW HOLLAND					
100 C-10 CTA-10 LCP-FL 10 C-FD 14-FD 14 E-FL 14 E-FR 15-FR 15 B				I136 I273	4817651 98410023
1300 - 1300DT- SOMECA 1300 - SOMECA 1300 DT				N450	8829805
1355 C		83.65.05.590		N451	4796534
14C-14LGP-14CTA				I267 	79014642
1580		TD 83.65.25.501		N451	4796534
1580 - 1580		TD 83.65.05.500		N451	4796534
160.90 - 160.90		TD 83.65.25.503		N451	4796534
180.90 - 180.90		TD 83.65.25.502		N451	4796534
1880 - 1880		TD 83.65.25.500		N451	4796534
20				I250	4606023-4952496
200 - 211- 215 -400- 411 - 415 FL4 - SOMECA M 75 - 20D - 35 - 411 C - 220C				N456	566997
35 - 40 - 45 - 50 - 512 - 513 - FL6				N457	577837
3700 -3790 -3790 R				I260 N460	4695786-4737154-4764156 4796537









	C.C.			DOLZ	OEM
NEW HOLLAND					
45.66- 50.66- 55.46/ .65/.66-55.90-60 .46/.65/.66/.90-65 .45/.66/.90-70.65/ .66-70.90-80.65/ .66/.90-85.55-90 .90-95.55C-100.90 -115.90-140.90 DT Serie 76-86-93-94			1/93-12/95	S239	98497117-98465322-98497118
45.66-50.66-55.46/ .65/.66-55.90-60 .46/.65/.66/.90-65 .45/.66/.90-70.65/ .66			01/96-->	S240	99454833
5 - FL6				N453	8822883-8829787
580-580DT-680- 680DT-780-780DT- 855C				I135	1909627-1930925-1940104-4696707
65 B		8061.05.000- 8065105.000		I145	8107660
70.90-80.65/.66/.90- 85.55-90.90-95 .55C-100.90-115 .90-140.90DT Serie 76 - 86 - 93 - 94			01/96-->	S240	99454833
7C - FL8C				N458	4757341-4757340
7D - S9 - SL9 - SR9 - S11 - SL11				N458	4757341-4757340
8 - 8B -FL9 - 10 B - FL 10 - FL 10B				N461	8829780
80 C- 100 C- 120 C				N458	4757341-4757340
880 - 880		TD C03/75 VAR. 2/4/10/12/14		N452	8829790
90C		C03.130T VAR 2.300		N458	4757341-4757340
AD-BD14-AD14 L - BD14-14B				I250	4606023-4952496
F10-FL10 E-FR10tel.	78Y00102 --->		-->12/92	I142 Ⓢ	4813370-4784454
FA120-FH120-FR130- FH150-FR150 3B- FH200/200-LC/200 3B200 EL			-->12/92	I142 Ⓢ	4813370-4784454
FD 30 B - FD 30 C				I260	4695786-4737154-4764156







	C.C.			DOLZ	OEM
NEW HOLLAND					
FD 30 HA / HUI / HSU / HR				I260	4695786-4737154-4764156
FD5-FL5 tel.	201361 ---->		-->12/92	I142 	4813370-4784454
FE 20/LC/HD/M/MLC/MHD-FE 24-FE 28 LC/HD/M/MLC/MHD-FP 40-FG 75-FG 85-FG 95				I136 I273	4817651 98410023
FE12 L-FE12 LC tel.	00054 ---->		-->12/92	I142 	4813370-4784454
FE12 MLC tel.	00034 ---->		-->12/92	I142 	4813370-4784454
FE12 R tel.	00134 ---->		-->12/92	I142 	4813370-4784454
FE16 tel.	00145 ---->		-->12/92	I142 	4813370-4784454
FE18 LC tel.	00096 ---->		-->12/92	I142 	4813370-4784454
FE18 M tel.	00030 ---->		-->12/92	I142 	4813370-4784454
FE18 MLC tel.	00102 ---->		-->12/92	I142 	4813370-4784454
FE18 tel.	00481 ---->		-->12/92	I142 	4813370-4784454
FH 150 W - FH 150 WT				I127 	4777806-4786730-4803730-4813730 4815259-98497114-98497115-4835043
FH 220 LC-FH 220 3B-FH 300-FH 300 T-FH 220-FA 150				I136 I273	4817651 98410023
FH 400	Engranaje/gear H=23mm- Z 24			I124	42530032-93190286-98468831-99456317
FL4 M/FD5-FL5-FL5 B-FB7 B/FD7-FD7 B -FL7-FL7 B-FR7/FR7 B-FR 7 C/FD9/FR9/ FD10-FL10 E/FR10/ FR10 B-FR10 C/ FR 11/FE12/2 LC/12 MLC/12 L/12 R/FE16 /FE18/18 LC/18M/ 18 MLC/FA120- FH120-FR130-FH150 -FH 150 3B/FH200/ 200 LC/200 3B/200E			01/93-->	S239	98497117-98465322-98497118
FL12				I250	4606023-4952496
FL14-FL14 B				I250	4606023-4952496
FL4 M tel.	400457 ---->		-->12/92	I142 	4813370-4784454
FL5-FB7 B-FD7-FD7 B tel.	250905 ---->		-->12/92	I142 	4813370-4784454
FL7 tel.	250910 ---->		-->12/92	I142 	4813370-4784454
FR 220	Engranaje/gear H 20 mm Z 23			I123 I133	93190288 61315464

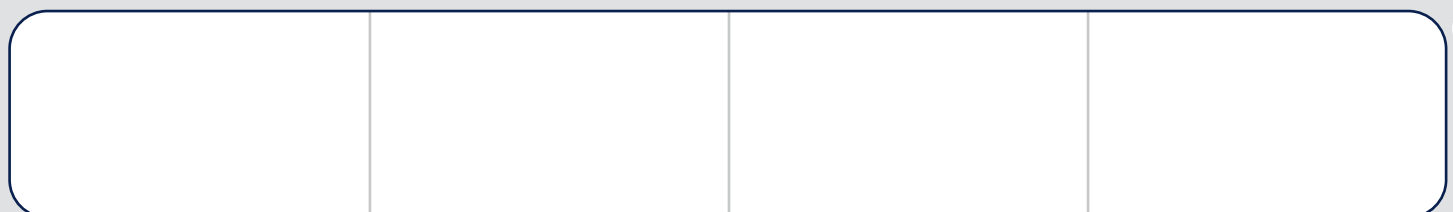



I123**I124****I127****I133****I260****I271****I273****N124****P317****P318****P333****S239**

	C.C.			DOLZ	OEM
NEW HOLLAND					
FR10 B-FR10 C- FR11-FE12 tel.	00125 --->		-->12/92	I142 	4813370-4784454
FR12 B-FE18 R- FE18 RM tel.	00179-->			S239	
FR35				I260	4695786-4737154-4764156
FR7 B-FR7 C-FD9- FR9 tel.	00349 --->		-->12/92	I142 	4813370-4784454
FR7 tel.	000441 ---->		-->12/92	I142 	4813370-4784454
FR9 B				N462	8830732
FR9 B-FR9 C				I146	99454834
M100		C03/70		N453	8822883-8829787
		C02D		N457	577837
M150 - M 152		CP3 I VAR.1 - VAR.51		I271	8829779
MX240 -MX240R				I250	4606023-4952496
MX300-MX300 R				I252	4692698-4710552-4777222
S15 BHD	MATR.38/096			I250	4606023-4952496
S15B	MATR.24/159			I250	4606023-4952496
S701 - S70M - SR70 - 590				N453	8822883-8829787
SLC15 B	MATR.29/022			I250	4606023-4952496
NISSAN					
EBRO 100				P313 P333	41312725K3
	P-313 sin polea/ without pulley				
L 35		4165, A428		P317	741001052-999099-999107-741001122 909107
L 35,L-35.08, L-35.08F,L-45.08	2820 CC	A428 II		P318	741001042-741001133-999108 999118
L 50 /L 80 /L-50.09 / L-60.09 / L-35.09		B440		N124	741001144
L 50 /L 80 /L-80.14 / L-80.09		B440		N124	741001144
L 50 /L 80/M-110.14		B660		N124	741001144
L 50 /L 80 / M-125.14/M-125.17				N124	741001144

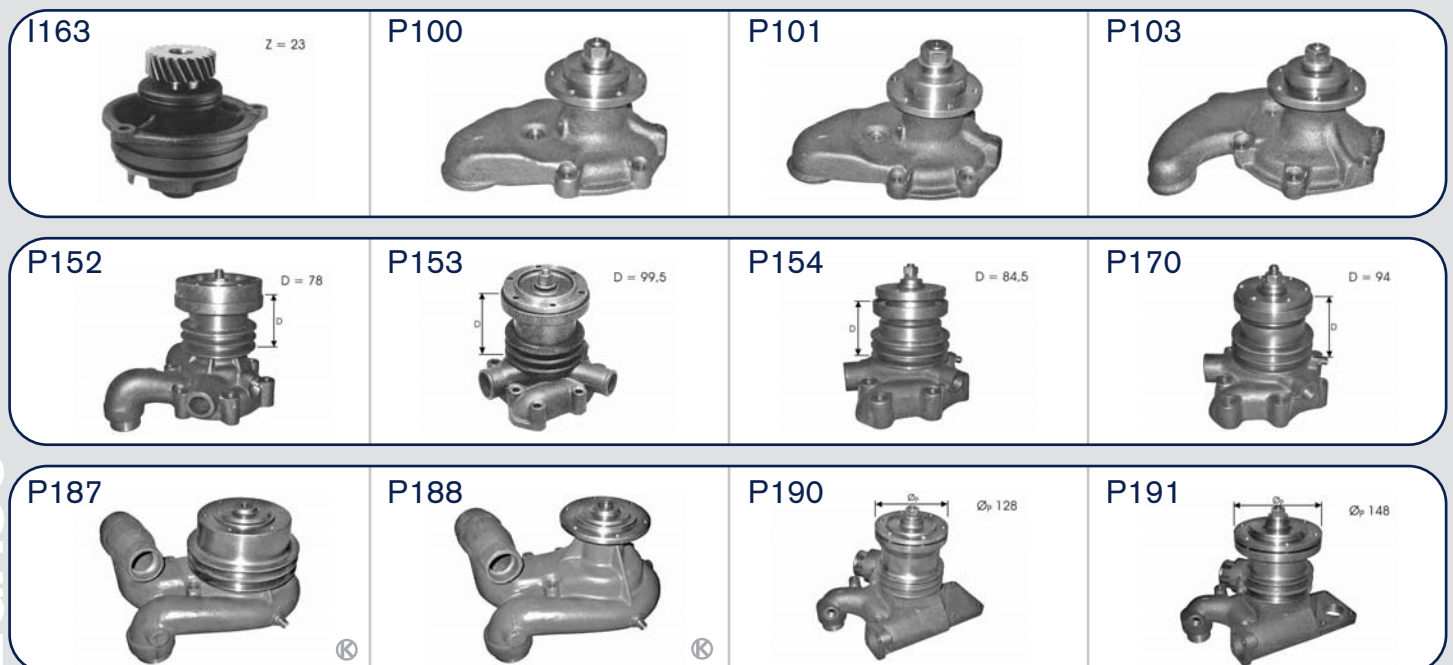



	C.C.			DOLZ	OEM
PEGASO					
1061	200 CV	9105/17		P150	642988
1061 / 1063 / 1066	200 CV	9105.17		P170	560314-560316-642970-642980-642981 645928-646793-646979-647506
1063	200 CV	9105/17		P150	642988
1065 EUROPA	170 CV	9100		P170	560314-560316-642970-642980-642981 645928-646793-646979-647506
1066	200 CV	9105/17		P150	642988
1083	260 CV	9109 / 1646 T		P152	640688
	200 CV	9105.42		P153	578640
	200 CV	9109.2		P183	576380
	260 CV	9109 / 1646 T		P152	640688
1086	260 CV	9109 / 1646 T		P152	640688
	260 CV	9109 / 1646 T		P152	640688
	200 CV	9109.2		P183	576380
	200 CV	9109.2		P183	576380
1121 - L / 5	6550 CC		8/85	P104	585769
1135	230 CV	TURBO		P191	
1183	Cabina abatible/moveable cabin	260 CV	9109 T	P260	647148
1185	Cabina abatible/moveable cabin	260 CV	9109 T	P260	647148
1217	230 CV			P196	770131
1217/6 AUTOMATICO				I163	93190284-500350798
1223	230 CV			P196	770131
1226.38	230 CV	260 INTERCOOLER		P186	197164-648344-648894
170 MODERNO/ MODERN	230 CV	9220		P186	197164-648344-648894
2011 / 50	260 CV	TURBO		P150	642988
2080 / 50	200 CV	9109.2		P183	576380
2080 / 50, 2080 / 51	260 CV	9109 / 1646 T		P152	640688
2180	Cabina abatible/moveable cabin	260 CV	9109 TURBO	P184	647355
2323	230 CV			P196	770131
2334 / 36	340- 360 CV	96 R1AX21500		P188 	774082
AUTOBUS	Motor trasero/rear mounted motor	170 CV		P154	576047
AUTOBUS 5035 NA		230 CV	260 TURBO	P186	197164-648344-648894
C-1		230 CV		P190	
COMET			9100.42	P151	746004-770185
COMET 1000	Antiguo 1 salida/former 1outlet	6.54 L	9040/9020	P100	604006
COMET 1090	2 Salidas/outlets		9020	P103	584509-587214
COMET 1091	2 Salidas/outlets		9020	P103	584509-587214
COMET 1095	2 Salidas/outlets		9020	P103	584509-587214



	C.C.			DOLZ	OEM
PEGASO					
COMET 1216	Moderno/modern-Cabina abatible/moveable cabin		TURBO 9135.15	P105	193921-19392101-585817-745901 745906
EUROPA MODERNO/MODERN SIN AGUJERO EN EL CUERPO		230 CV		P196	770131
SUPER COMET 1091	2 Salidas/outlets			P104	585769
SUPER COMET 1098	2 Salidas/outlets			P104	585769
SUPER COMET 1101	1 Salida/outlet		9140	P101	587218-635097-635098
TECNO 1234		340-360 CV	96R1AX21500	P188 	774082
TRACTORA 1231.T		306-310-352 CV	9156	P184	647355
TRONER 1236/1238		340-360 CV	96R1EX21500	P187 	773242
		306-310-352 CV	9156	P184	647355
		232 CV	9154.1	P185	648362
PERKINS					
1759		1,76 L	4.108 D	P303	41312459-68VB8501A-68VB8501B 999067-999076-999089-999105-999113 U5MW0054
4 A.212		3.45 L	4.236	P359	3637411M91-41313131P-U5MW0104
4 A.236		2.84 L	4.236	P359	3637411M91-41313131P-U5MW0104
4 A.248		4.04 L	4.236	P359	3637411M91-41313131P-U5MW0104



	C.C.			DOLZ	OEM	
PERKINS						
AVIA 1000/1250		4.108		P303	41312459-68VB8501A-68VB8501B 999067-999076-999089-999105-999113 U5MW0054	
AVIA 2000/1600	2710cc	4.165		P317	741001052-999099-999107-741001122 909107	
AVIA 2500-5000		A4.203-A4.192		P301	999018-9900184-999016	
	Bomba en culata/ pump attached to head	A4.203-A4.192		P301	999018-9900184-999016	
AVIA 4.203	Bomba en tapa distribucion/ pump on the distributor cover-4 Cil./Cyl.	4.203		P307	747542M91	
AVIA 5000	4 Cil./Cyl.	4.236		P309	990091-999037K	
AVIA 8000 MT		6.354.3		P313	41312725K3	
	P-313 sin polea/without pulley	6.354.3		P333		
AVIA P4	bomba en culata/pump attached to head	A4.203-A4.192		P301	999018-9900184-999016	
Carretilla/Dumper FENWICK	Baja posicion/ low position	5,8 L.	P-4 6.354	P376	0950134	
Carretilla/Dumper HYSTER MODELO H30,50F			4.192 / 4.203	64-67	P355	241331-41312574
Carretilla/Dumper V.30, V.40, V.50	Baja posicion/ low position	5,8 L	6.354		P319	41312784
TECNOCAR					P324	8445212
CARTERPILLAR	Motores industriales / industrial motors		4.236		P378	109890
CATERPILLAR 428	Sin turbo/without turbo		RETRO MIXTO		P377	
	TURBO		RETRO MIXTO		P377	
CF 220 / 250 VAN			4.108		P312	8853765-91002682
COMMER	CHRYSLER U.K. (Baja posicion/low position)	5,8 L	6.354	48-68	P322	75221910-41313045-U5MW0111
COMMER (Chrysler UK)- DENNIS-SEDON		5,8 L	MOTOR 6.354 Baja posicion/ low position	48-->	P332	41312107-41312169-5046229
COMMER-DENNIS- SEDON	Chrysler UK	5,8 L	6.354	48-->	P321	41312059
	CHRYSLER U.K. (Baja posicion/low position)	5,8 L		48-->	P322	75221910-41313045-U5MW0111
COSECHADORA MF 3640 - 5650 - 1175 - 1175 DS	6 Cil./Cyl. M.FERGUSON		A 6.354/4		P361	
DENNIS PAX IV, V		5,8 L	MOTOR 6.354 Baja posicion/ low position	60-70	P332	41312107-41312169-5046229

P301



P303



P307



P308



P319



P321



P322



P324



P355



P357





P358





P359





		C.C.			DOLZ	OEM
PERKINS						
EBRO	SERIE L - 180		4.212/4.236/4.248		P354	41313228
EBRO 152E			3.152		P351	U5MW0023-U5MW0097
EBRO D 700/ E-95/ E-110 / E-160	6 Cil./Cyl.	4,97 L	6.305		P308	41312518-U5MW0019
EBRO D-550 / E-35/ E-60 /E-70 / E-90	4 Cil./Cyl.		4.236		P359	3637411M91-41313131P-U5MW0104
	4 Cil./Cyl.		4.236		P309	990091-999037K
EBRO D-700	6 Cil./Cyl.		6.305		P358	41312207
EBRO E-110/P-112/ P-317/P-160/ M-100/M-125			6.354.3		P313	41312725K3
	P-313 sin polea/ without pulley		6.354.3		P333	
EBRO E-35/ E - 60/ E - 350	Articulado/articulated - 4 Cil./Cyl.		4.203		P357	41312155-U5MW0057-U5MW0096
	4 Cil./Cyl.		4.203		P307	747542M91
EBRO E-95 E-110 E-160	6 Cil./Cyl.		6.305		P358	41312207
EBRO F103/108/ 260/275/280			4.108		P303	41312459-68VB8501A-68VB8501B 999067-999076-999089-999105-999113- U5MW0054



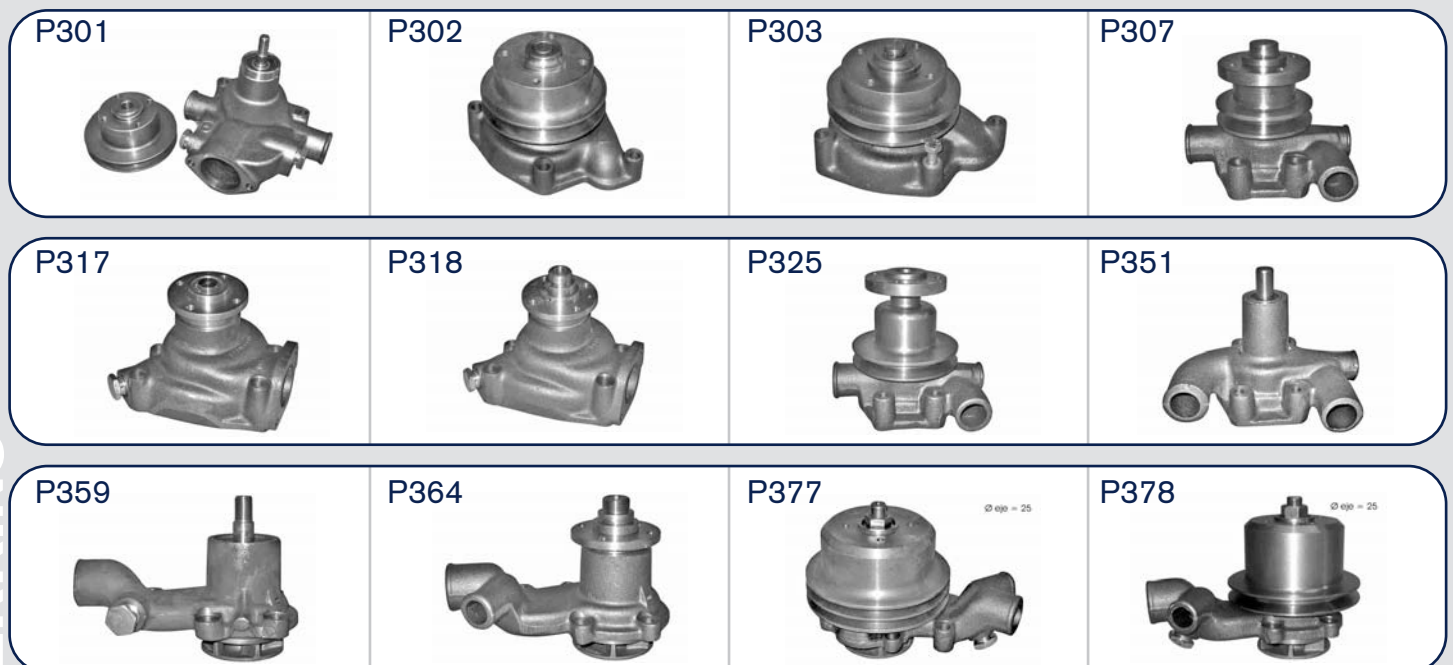

	C.C.			DOLZ	OEM
PERKINS					
EBRO SERIE L		4.236 SERIE 180		P314	220008KL-41313209-999071K
EBRO TRACTOR 3-183 / E-684	6 Cil./Cyl.	6.305		P358	41312207
EBRO TRACTOR E-183 E-684	6 Cil./Cyl.	6.305		P308	41312518-U5MW0019
F.I.R.E.	Motores industriales/ industrial motors	4.236		P378	109890
FORD TRANSIT		1,76 L 4.108		P303	41312459-68VB8501A-68VB8501B 999067-999076-999089-999105 999113-U5MW0054
H30,60H		4.192 / 4.203	64-67	P355	241331-41312574
H60,80C		4.192 / 4.203	64-67	P355	241331-41312574
HORMIGONERA/ mobile cement mixer	4 Cil./Cyl.	4.203		P307	747542M91
JCB	4 Cil./Cyl.	4.203		P357	41312155-U5MW0057-U5MW0096
	TURBO - NORMAL	RETRO MIXTO		P377	
	Motores industriales/ industrial motors	4.236		P378	109890
JEEP TOLEDO		A4.203-A4.192		P302	41312034-41312456-999114
L -35 EBRO F-350	Con tapon adicional/ with extra plug	4.165		P317	741001052-999099-999107-741001122 909107
	Con tapon adicional/ with extra plug - VV	4.165		P318	741001042-741001133-999108-999118
L-35 / L-45 / L-60 / L-80 EBRO	VENT. VISCOSO/ viscous fun	4.236		P364	220230K
LAND ROVER COMANDO		4.165		P317	741001052-999099-999107-741001122 909107
		4.165		P318	741001042-741001133-999108-999118
MASSEY FERGUSON 130		4.107		P303	41312459-68VB8501A-68VB8501B 999067-999076-999089-999105 999113-U5MW0054
MASSEY FERGUSON 178 / 188 / 185 EXPORT		4.212 / 4.236 / 4.248		P314	220008KL-41313209-999071K
MASSEY FERGUSON		A4.203-A4.192		P301	999018-9990184-999016
		A4.203-A4.192		P301	999018-9990184-999016
MASSEY FERGUSON 35 7 65		A 3.152		P351	U5MW0023-U5MW0097
MASSEY FERGUSON 133 MKIII DIESEL		D 3.152	71-->	P351	U5MW0023-U5MW0097
MASSEY FERGUSON 135 MKIII hasta/up to 152UA5276D		D 3.152	71-->	P351	U5MW0023-U5MW0097

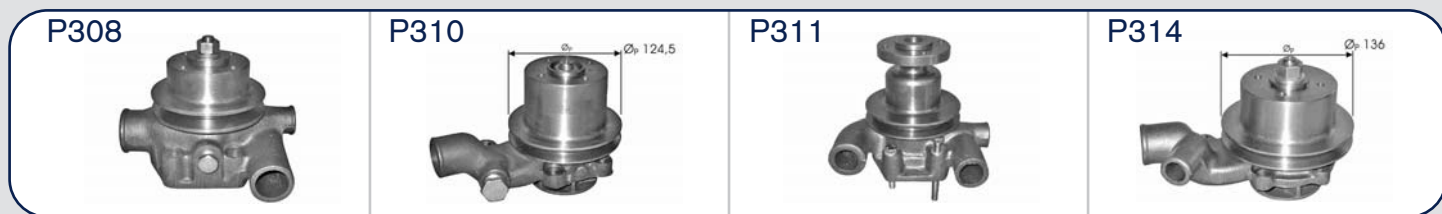

	C.C.			DOLZ	OEM
PERKINS					
MASSEY FERGUSON 148		T 3.152		P351	U5MW0023-U5MW0097
MASSEY FERGUSON 165		4.212 / 4.236 / 4.248 D		P310	999038
MASSEY FERGUSON 168	DIESEL	4.192 / 4.203	64-67	P355	241331-41312574
MASSEY FERGUSON 168 / 175 / 178 / 147		4.212 / 4.236 / 4.248		P359	3637411M91-41313131P-U5MW0104
MASSEY FERGUSON 168 / 175 / 178 / 147		4.236/4.248 D		P310	999038
MASSEY FERGUSON 175	DIESEL 4822574 -->	4.212 / 4.236 / 4.248		P359	3637411M91-41313131P-U5MW0104
MASSEY FERGUSON 185	DIESEL	4.212 / 4.236 / 4.248		P359	3637411M91-41313131P-U5MW0104
MASSEY FERGUSON 188	DIESEL 248UA46991 -->	4.212 / 4.236 / 4.248		P359	3637411M91-41313131P-U5MW0104
MASSEY FERGUSON 20		3152 CC	A3.152	P311	41312154-41312159-41312487-41312495 70990318-70991414-41312784
MASSEY FERGUSON 230 / 240/247/250/260		T 3.152		P351	U5MW0023-U5MW0097
MASSEY FERGUSON 243 hasta/up to 522354		3.152		P351	U5MW0023-U5MW0097
MASSEY FERGUSON 250 / 300		4.212 / 4.236 / 4.248		P354	41313228
MASSEY FERGUSON 265	DIESEL hasta/up to 193552	4.212 / 4.236 / 4.248		P359	3637411M91-41313131P-U5MW0104
	DIESEL hasta/up to 212836	4.212 / 4.236 / 4.248		P359	3637411M91-41313131P-U5MW0104
MASSEY FERGUSON 290	hasta/up to 371735 / 371736 -->	4.212 / 4.236 / 4.248		P359	3637411M91-41313131P-U5MW0104
MASSEY FERGUSON 3050		4.212 / 4.236 / 4.248		P359	3637411M91-41313131P-U5MW0104
MASSEY FERGUSON 3060		4.212 / 4.236 / 4.248		P359	3637411M91-41313131P-U5MW0104
MASSEY FERGUSON 350 / 355		3.152		P351	U5MW0023-U5MW0097
MASSEY FERGUSON 35X				P325	



	C.C.			DOLZ	OEM
PERKINS					
MASSEY FERGUSON 375 / 365	212837 -->	4.212 / 4.236 / 4.248		P359	3637411M91-41313131P-U5MW0104
MASSEY FERGUSON 487	DIESEL	4.212 / 4.236 / 4.248		P359	3637411M91-41313131P-U5MW0104
MASSEY FERGUSON 550/ 644/2135/2500/4500		3.152		P351	U5MW0023-U5MW0097
MASSEY FERGUSON 565	hasta/up to 658915 / 658916 -->	4.212 / 4.236 / 4.248		P359	3637411M91-41313131P-U5MW0104
MASSEY FERGUSON 575	DIESEL	4.212 / 4.236 / 4.248		P359	3637411M91-41313131P-U5MW0104
MASSEY FERGUSON 590	DIESEL	4.212 / 4.236 / 4.248		P359	3637411M91-41313131P-U5MW0104
MASSEY FERGUSON 65		4.192 / 4.203	60-64	P315	241331-3637372M91-41312063 41312167-U5MW0062
MASSEY FERGUSON 65 / 158 / 165 / 175		4.192 / 4.203	60-64	P316	41312812-41312892-U5MW0089
MASSEY FERGUSON 675	DIESEL	4.212 / 4.236 / 4.248		P359	3637411M91-41313131P-U5MW0104
MASSEY FERGUSON 690	DIESEL	4.212 / 4.236 / 4.248		P359	3637411M91-41313131P-U5MW0104
MOTORES INDUSTRIALES		4/99		P302	41312034-41312456-999114
	CANAL ESTRECHO/ narrow belts			P366	
		3.152-4.203		P367	41312536
	CANAL ANCHO/ wide belts			P375	122663600
NISSAN PATROL	VENTILADOR FIJO	4.165		P317	741001052-999099-999107-741001122 909107
P-3	Motores industriales/ industrial motors	3.152		P307	747542M91
		T 3.152		P319	41312784
	Motores industriales/ industrial motors	3.152		P357	41312155-U5MW0057-U5MW0096
P-309/P-310/P-359	CON PLATO/with hug PORTA POLEAS			P360	3637411M91-41312143-41312201 41312323-41312366-41312551 41312915-41313201-41313232 4131A013-70991096-74100071 741000710-999024
RENAULT 88	6 Cil./Cyl.	6.305		P308	41312518-U5MW0019
	6 Cil./Cyl.	6.305		P358	41312207

P302



P303



P307



P308



P318



P319



P321



P325



P359



P360





P361



P365



	C.C.			DOLZ	OEM
PERKINS					
SEAT 124/132/131 S. MIRAFIORI/1430		4.108		P303	41312459-68VB8501A-68VB8501B 999067-999076-999089-999105-999113 U5MW0054
SEDON	Todos los modelos/ all models	5,8 L	MOTOR 6.354 Baja posicion/ low position	P332	41312107-41312169-5046229
SP 8000 - CP 27	6 Cil./Cyl.		T 6.354/4	P361	
Todos los modelos / all models MOTOR PERKINS	BAJA POCISION / low position	5,8 L	6.354	P321	41312059
TRACTOR CBT 2500 - 8260	6 Cil./Cyl.		AT 6.354/4	P361	
TRACTOR FORDSON DEXTA	3 Cil./Cyl.	39 CV.	INDUSTRIAL	P325	
TRACTOR MF 296- 297- 299	6 Cil./Cyl. MAXION		QB20B 6.354/4	P361	
TRACTOR R-30				P365	964217907
U5MW0061 con polea/with pulley	P-316 con tubo/with tube DE 39C			P386	U5MW0061
	DIESEL ADAPTADO / adapted diesel BEDFORD 1759		4.108	P312	8853765-91002682
	AVIA 2000/1600	2710 CC	4.165	P318	741001042-741001133-999108-999118

P312



P315



P316



P317



P332



P351



P357



P358



P366



P367





P375



P386



	C.C.			DOLZ	OEM
PERKINS					
Con doble canal/double pulley runners		4.108		P323	220270K
4-5-6 Y 12 TONELADAS/ TONNES	5,8 L	MOTOR 6.354 Baja posicion/ low position		P332	41312107-41312169-5046229
4 Cil./Cyl.		4.203		P357	41312155-U5MW0057-U5MW0096
		4.336		P377	
P-377/P-378 sin polea/ without pulley				P397	41312327-U5MW0108-41313218
Eje largo/long axis 198,65 mm		A4.248		P398	41313226-41313233-41313212 U5MW0106

RENAULT

R.V.I.-	GBH 260 (6x6), GBH 280 (6x6)		MD 06.35.40, MDS 06.35.40	79-->	B116 ☉	0000773983-5010323187-0000773450
	GLM 280, TLM 280		MIDS 06.35.40		B116 ☉	0000773983-5010323187-0000773450
	GLM/TLM 280 - GR/TR 280		MIDA 06.35.40		B116 ☉	0000773983-5010323187-0000773450
	GR 280 (6x4), TBH 280 (6x4)		MIDS 06.35.40		B116 ☉	0000773983-5010323187-0000773450
	GR 280-PX 28, TR 280-PX 28T		MIDS 06.35.40	79-->	B116 ☉	0000773983-5010323187-0000773450
	GRH 305 (6x4) PX 30 V		MDR 06.35.40	79-->	B116 ☉	0000773983-5010323187-0000773450
	GRH/TRH 305- R310/310T		MDS 06.35.40		B116 ☉	0000773983-5010323187-0000773450
	PR 14 SR/SL	264 CV	MIDR 06.20.30		B116 ☉	0000773983-5010323187-0000773450
	R 310 (4x2) /T/TD		MIDR 06.35.40		B116 ☉	0000773983-5010323187-0000773450
	R 310 (6x4) /T/TD		MIDR 06.35.40		B116 ☉	0000773983-5010323187-0000773450
	R 310/T/TD		MIDR 06.35.40		B116 ☉	0000773983-5010323187-0000773450
	TBH 280 (6x6)		MIDS 06.35.40	79-->	B116 ☉	0000773983-5010323187-0000773450
	THR 305 (6x4) PX 30 VT		MIDR 06.35.40	79-->	B116 ☉	0000773983-5010323187-0000773450
	TR 305-PX 30T, GR 305-PX 30		MDR 06.35.40A, MIDR 06.35.40B		B116 ☉	0000773983-5010323187-0000773450
R.V.I.-R-340, R-365	FRANCES			B116 ☉	0000773983-5010323187-0000773450	
R.V.I.-GLC-GLR190- GLR230 - PGC/ GR191 - GB231 - GLR230		MID 06.20.30		B181	5000663009	
R.V.I.-GR350-TR350- GRH350 (6X4) - TRH350 (6X4) - R360 - R360T - R360(6X4) - R370(6X4) - R370T/TS(6X4)		MIVS 08.35.30		B182	5000670157	

B113



B115



B116



B181



E114



E115



E118



M617



P377



P397





P398











R200



	C.C.			DOLZ	OEM
RENAULT					
R.V.I.-GRH235-PR14 PR100M - PR180		MDIS 06.20.30 T		B181	5000663009
		MIPS 06.20.30		B181	5000663009
R.V.I.-PR 100.2		MIPS 06.20.45		B182	5000670157
		MIPS 06.20.45 E		B182	5000670157
RENAULT (R.V.I.)	B-110 S/P con eje/axis de 25 mm			B115	
RENAULT (R.V.I.) BT 70-35D / BT 70- 45D / B90				S152	4720031-4755003-4764782-7303050 7301592-7302358-98435994-99459757 5000288046-5000807860-5000813420 5001833230-5001837263-5001837264 98418986
RENAULT (R.V.I.)- CAMION/TRUCK BARREIROS 4216				B113	
RENAULT (R.V.I.)- CAMION/TRUCK BARREIROS 4217				B113	
RENAULT (R.V.I.)- TRACTOR BARREIROS R-545 I	B-111 S/P + polea canal roscado/adjustable threaded pulley 100 mm			B113	
SAVIEM	DIESEL	580/591/599/712/ 720/712		R200	0987045300-5000248443-7701450514 7701450837
TRACTOR RURAL SUPER 7		PERKINS 3152		P376	0950134
RENAULT V.I					
GR 251 - TR 251 - PS 30 - HI 38		D 2566 MTSF		M617	4032007001
SCANIA					
112 / 114 / 124 SERIES	Todos los modelos/ all models	DSC 11-DSC 12		E114 ☉	1353072-570951
144	SERIE 4	14L		E115	1365841-570952-570956-1508534
92 / 93		MOTOR DS 9		E112	1338490-397957-1377571
L 112, T 112, G, P, R 112		379 CV DS11		E110 ☉	1314406-292761
L112/K112/K113		379CV DSC 11		E110 ☉	1314406-292761
P 94	SERIE 4	9L		E113	1380897-1486098-1510490-570953 571157
SERIE 142	Todos los modelos/all models	DS 14 - DSC 14		E118	320592
	Todos los modelos/ all models	DS 14.06 - DSC 14.01		E118	320592

B182**E110****E112****E113****P323****P332****P357****P376****S152**

		C.C.			DOLZ	OEM
SCANIA						
SERIE 143	Todos los modelos/ all models		DSC 14 03 - DSC 14 06		E120	382183-1375838
SERIES 111	Todos los modelos/ all models		D 11-DS 11		E111 	259065
VOLVO						
F 10	Desde/from 314000--> Desde/from 25001-->				V201 	1545261-1699786-1675945-422791 1698620-1699790-3184802-478845 479931-8149937
F 10 INTERCOOLER 320						
F 12	--->Final/end 34000 Desde/from 34001--> Desde/from 314000-->					
F 12 INTERCOOLER 420						
FE 6-TD 61/FL 6- TD 63/FL 6-D6/FE7- TD 71/FL 7-FS 7- TD 73/FL 7-FS 7-D7					V200	3183908-3183909-477770-8112185 8113522-8192050
FH 12 - FM 12			D 12 C	08/98-->	V207	8170305-20431135
FH12 D12 A-FL1 D 12 A-FL 12 D 12 A	Para versión con cambio automático/for automatic transmission version				V204	1547155-8113117-8148460-8149941 8149882
FL 10					V201 	1545261-1699786-1675945-422791 1698620-1699790-3184802-478845 479931-8149937
FL 10 - FS 10 - F 12						
FL 10 INTERCOOLER 320						
FL 12 - NL 10 - NL 10 S - NL 12						
FM 12 BR - NH 12			D 12 C	08/98-->	V207	8170305-20431135
N 10 - NL 10 - NL 10 S - N 10 MARK II			TD 100 B		V206	1545248-1699788
			TD 100 BG		V206	1545248-1699788
			TD 100 G		V206	1545248-1699788
			TD 101 G		V206	1545248-1699788
			TD 102		V206	1545248-1699788
N 12	-->Final/end 12000 Desde/from 12001-->				V201 	1545261-1699786-1675945-422791 1698620-1699790-3184802-478845 479931-8149937
NH 12 BR			D 12 C	08/98-->	V207	8170305-20431135
NL 10 S TD 121 GA - NL 12 - NL 12S NL 12 S					V201 	1545261-1699786-1675945-422791 1698620-1699790-3184802-478845 479931-8149937

E111



E120



V200



V201



V204



V206



V207



INDICE DE REFERENCIAS DOLZ

THE BUYERS GUIDE
INDEX-RÉFÉRENCES DOLZ
INDICE DEI CODICI DOLZ
ARTIKELVERZEICHNIS

DOLZ
Truck

DOLZ PAGES.**A**

A110	20,22
A111	20
A114	20,22
A118	20,22
A120	21,22

B

B102	6
B105	6
B107	6
B108	6
B109	7
B110	7
B110SP	7
B111	7
B111SP	6
B112	6
B113	50
B115	50
B116	50
B117	6
B136	6
B156	7
B160	7
B181	50
B182	51

D

D101	7,8
D201	8
D202	8

E

E101	10
E110	51
E111	52
E112	51
E113	51
E114	50
E115	50
E118	50
E120	52

F

F113	16
F123	16
F144	16
F156	7
F158	6

I

I102	8
I104	9
I105	9
I106	9
I107	9
I108	8

DOLZ PAGES.**I**

I110	18,21
I119	10
I120	10
I121	12,14
I122	14
I123	10,12,40
I124	11,40
I126	11,14
I127	11,12,40
I128	14
I130	15
I131	12
I132	13,15
I133	11,13,40
I134	10
I135	38
I136	38,41
I137	10
I140	13
I142	38,41
I145	38
I146	41
I157	13
I159	16
I160	10
I161	15
I162	17
I163	12,15,42
I164	12
I166	12
I169	14
I201	18
I231SP	10
I236	12
I240	11,14,17
I241	11
I250	11,13,18,39,41
I251	17
I252	13,14,18
I254	14,17,19,21
I255	13,15,16
I256	13,16
I257	11
I258	16
I259	12,19
I260	10,12,15,19,39,40
I261	12
I264	10
I267	10,12,16,39
I271	40
I273	19,39,40

J

J110	21
J111	20

L

L214	8
L215	8

DOLZ PAGES.**M**

M078	28,36
M178	23,24,28,30,32,34,36
M278	23,24,32,34
M302	23,24,28
M303	24
M307	26,28
M610	29,30,32,34,36
M611	29
M612	17,29,32,34,36
M613	17,35,37
M614	35
M615	33,37
M616	35,37
M617	17,20,25,26,29,30,33, 35,37,50
M618	25
M619	25
M620	30,33,34
M622	34
M623	31,34
M624	33
M625	32
M626	36,38
M627	36
M628	23,25
M629	32
M630	31,32,36
M632	24
M633	24,36
M634	24
M635	38
M636	31,34
M637	31,37
M638	28
M648	32,35

N

N124	40
N450	38
N451	38
N452	39
N453	13,17,39,41
N456	39
N457	39,41
N458	38
N460	18,38
N461	38
N462	41

P

P100	42
P101	42
P103	42
P104	43
P105	43
P150	43
P151	43
P152	42
P153	42
P154	42
P170	42
P183	43
P184	43

DOLZ **PAGS.****P**

P185	43
P186	43
P187	42
P188	42
P190	42
P191	42
P196	43
P260	43
P301	44,46
P302	46,48
P303	43,44,48
P307	20,44,46,48
P308	44,47,48
P309	45
P310	47
P311	47
P312	45,49
P313	41,45
P314	47
P315	49
P316	49
P317	40,45,46,49
P318	40,46,48
P319	44,48
P321	44,48
P322	44
P323	51
P324	44
P325	46,48
P332	45,49,51
P333	40,45
P351	45,46,49
P354	45,47
P355	44,47
P357	20,44,47,49,51
P358	44,47,49
P359	43,44,46,48
P360	48
P361	45,48
P364	46
P365	48
P366	49
P367	49
P375	49
P376	45,51
P377	45,46,50
P378	45,46
P386	49
P397	50
P398	28,50

R

R200	50
-------------	----

S

S139	10,18,21
S150	18
S151	18,21
S152	19,21,51
S239	13,19,38,40
S240	39

DOLZ **PAGS.****V**

V200	52
V201	52
V204	52
V206	52
V207	52

REFERENCIAS NUEVAS • NEW MODELS

E118	I258	M303	M625	P187KR	V201KR
E120	I273	M307	M629	P188KR	V206
I102KR	L215	M624	M630	P361	V207
I110					

REFERENCIAS ELIMINADAS • ELIMINATED PUMPS

B183	I144KR	I167	I266	M613KR	S405
B184	I149	I237	I267KR	M621	T200
I125	I151	I244SP	I270	P301A	T201
I141	I155	I253	I272	S403	V205
I144	I165	I265	J112	S404	

REFERENCIAS SUSTITUIDAS • REPLACED PUMPS

E110KR	→ E110KRT	I129	→ I128	N459	→ N458
	→ E110KRE	I147	→ I127	P333SP	→ P333
E111KR	→ E111KRE	I168	→ I130	S167	→ I254
	→ E110KRT	I242	→ I241	V203	→ V201

REFERENCIAS EN EXTINCION • PUMPS IN EXTINCTION

Disponibles hasta agotar existencias • limited to end of stock

B102	B160	B181	I160	I254
-------------	-------------	-------------	-------------	-------------

CRUCE DE REFERENCIAS ORIGINALES-DOLZ

CROSS REFERENCE LISTING ORIGINALS-DOLZ
LISTE DE CORRESPONDANCE RÉFÉRENCES D'ORIGINE-DOLZ
TABOLE COMPARATIVE RIFERIMENTI ORIGINALI-DOLZ
VERGLEICHSNUMMERNLISTE ORIGINALES-DOLZ

DOLZ

Truck

OEM	DOLZ
BARREIROS	
0022704900	D101
0062612300	B111SP
0063847100	B110
0063847300	B111
0063864900	B160
4000133920	B107
4000133920	B117
4000134120	B107
4000134120	B117
4011016120	B102
4011363520	B109
4011363620	B108
4011390720	B136
4011390720	B156
5430013192	B112
5430013351	B112
622607310065	D101
920317310105	D101
922917310105	D101
AA13211000	B109
AA13211003	B108
AM13211000	B102
BA13211010	B111SP
BJ13211000	B111SP
BJ13211070	B160
BV13211012	B117
CA13211001	B160
CC13211000	B160
OS13211010	B105
BEDFORD	
2701605	F156
2705259	F156
2712239	F156
7182777	F156
91074231	F158
9962669	F156
CASE-INTERNACIONAL	
3132738R92	I102
3132739R92	I104
3132741R93	I102
3136053R92	I104
3138936R92	I107
3144456R93	I107
3144661R93	I108
3804883	L215
3913430	L215
718891R97	I106
763613R95	I105
A77704	L215
J802479	L215
CUMMINS	
3804883	L215
3913430	L215
A77704	L215
J802479	L215

OEM	DOLZ
D.A.F.	
0681653	D202
0682258	D202
0682968	D202
0683225	D201
0683225R	D201
1609871	D201
3927015	L214
473742	L214
CBU2148	L214
J802358	L214
DITER	
0022704900	D101
622607310065	D101
922917310105	D101
920317310105	D101
EBRO	
DKN8501	E101
DKW8501B	E101
FIAT	
4603885	S139
4616667	S139
4639182	S139
46545010	S139
4655010	S139
4655050	S139
4655054	S139
4655118	S139
4655119	S139
4679242	S139
4679303	S139
4679304	S139
79014642	I267
93191101	S139
FIAT-IVECO-OM-UNIC	
4606023	I250
4838676	I140
4952496	I250
42532082	I121
61318938	I164
61318939	I128
93191103	I254
98415831	I126
98439476	I131
98447661	I130
98468831	I124
98497115	I127
98497117	S239
99445447	I164
99453848	I130
99456317	I124
99458098	I134
99458098	I134
99458099	I120
42530032	I124
42530033	I119
42532082	I121

OEM	DOLZ
FIAT-IVECO-OM-UNIC	
42535615	I121
4543905	I157
4544917	I161
4557736	I261
4579897	I261
4581366	I161
4606023	I250
4629770	I256
4692698	I252
4695786	I260
4710552	I252
4711706	I255
4737154	I260
4752137	I264
4760948	I137
4764156	I260
4777222	I252
4777806	I127
4786730	I127
4796535	I255
4803730	I127
4808471	I134
4812406	I257
4813730	I127
4815259	I127
4835043	I127
4838676	I140
4952496	I250
500300470	I257
500350783	I130
500350785	I169
500350798	I163
500361227	I128
500373092	I122
552113	I162
61315464	I133
61318939	I128
61321400	I128
61690370	I231SP
61690371	I240
61690374	I240
61690375	I231SP
61690377	I241
61690384	I241
61690510	I259
61690511	I236
761312	I166
79014642	I267
8807763	I159
8822883	N453
8823323	I251
8829154	I251
8829769	I258
8829770	I256
8829787	N453
93190284	I163
93190285	I169
93190286	I124
93190287	I119
93190288	I123
93191103	I254
93191104	I137
98415831	I126
98439476	I131

OEM	DOLZ
FIAT-IVECO-OM-UNIC	
98447661	I130
98465322	S239
98468830	I134
98468831	I124
98468832	I120
98479675	I169
98479917	I132
98497114	I127
98497115	I127
98497117	S239
98497118	S239
99445447	I169
99446891	I122
99456317	I124
99458099	I120
FORD	
2705E8K500	F144
703F8K500AAC	F144
C5NE8501A	F113
C5NN8501A	F113
D5NF8501E	F123
D5NN8501E	F123
D8NN8501UC	F113
HANOMAG HENSCHEL	
3142000601	M613
3142000801	M613
3142001901	M613
3142002101	M613
3142002401	M613
3142002901	M613
3142003701	M613
3142003901	M613
3142004201	M613
3522003401	M612
3522005401	M612
3522007201	M612
3522007501	M612
3522008101	M612
3522008501	M612
3522008901	M612
3522009201	M612
3522009501	M612
3522009601	M612
3522009701	M612
3532001601	M612
3532001701	M612
3532003801	M612
3532005601	M612
3532005601	M612
4032002701	M617
4032003401	M617
4032003501	M617
4032004901	M617
4032007001	M617
432003201	M617
5000281838	M617
51065006228	M617
51065009228	M617
8132000475	M617

OEM	<i>DOLZ</i>
HANOMAG HENSCHEL	
8311999133	M617
8312000475	M617
HITACHI-SIMIT	
79014642	I267
ISUZU	
Z8943768630	I201
IVECO	
4606023	I250
4639182	S139
4655010	S139
4655054	S139
4679242	S139
4714636	S151
4720031	S152
4754850	S151
4755003	S152
4764761	S151
4764782	S152
4952496	I250
7303009	S151
7303050	S152
7303056	S150
93191101	S139
93191103	I254
98437726	S151
98497117	S239
5001001274	S151
7701462808	S151
7701468342	S151
4603885	S139
4606023	I250
4616667	S139
4639182	S139
46545010	S139
4655010	S139
4655050	S139
4655054	S139
4655118	S139
4655119	S139
4679242	S139
4679303	S139
4679304	S139
4692698	I252
4695786	I260
4710552	I252
4714636	S151
4720031	S152
4737154	I260
4754850	S151
4755003	S152
4764156	I260
4764761	S151
4764782	S152
4777222	I252
4796537	N460
4952496	I250
5000288046	S152
5000807860	S152

OEM	<i>DOLZ</i>
IVECO	
5000813420	S152
5001001274	S151
5001833230	S152
5001837263	S152
5001837264	S152
500356553	I110
61690510	I259
7301592	S152
7302358	S152
7303009	S151
7303050	S152
7701462808	S151
8823323	I251
8829154	I251
93191101	S139
93191103	I254
98410023	I273
98418986	S152
98435994	S152
98437726	S151
98465322	S239
98497117	S239
98497118	S239
99440728	S151
99459755	S150
99459757	S152
JOHN DEERE	
13243	J111
13243	J111
41312155	P357
747542M91	P307
AT27018	J110
U5MW0057	P357
U5MW0096	P357
KASSBOHRER	
4032002701	M617
4032003401	M617
4032003501	M617
4032004901	M617
4032007001	M617
432003201	M617
5000281838	M617
51065006228	M617
51065009228	M617
8132000475	M617
8311999133	M617
8312000475	M617
LEYLAND-BMC- SAVA	
12B2438	A118
12B2747	A118
16K0099	A111
37D0457	A114
801943	A118
818358	A118
AMK2367	A120
AMK279	A120
AMK2807	A110
AMK2808	A120

OEM	<i>DOLZ</i>
LEYLAND-BMC- SAVA	
CMK2044	A114
CMK2045	A114
MAN	
4222001001	M278
4032002701	M617
4032003401	M617
4032003501	M617
4032004401	M178
4032004901	M617
4032005101	M178
4032007001	M617
4032007101	M178
4222000501	M278
4222001001	M278
432003201	M617
4412000201	M078
4412000301	M078
4572000004	M278
4572000101	M278
5000281838	M617
51065006222	M628
51065006228	M617
51065006282	M178
51065006302	M302
51065006374	M302
51065006394	M302
51065006408	M278
51065006416	M302
51065006423	M302
51065006426	M634
51065006432	M302
51065006476	M303
51065006492	M632
51065006546	M619
51065006547	M618
51065007033	M307
51065007036	M307
51065007043	M307
51065007045	M307
51065007047	M307
51065007048	M307
51065007051	M307
51065007052	M307
51065007065	M307
51065007066	M307
51065009048	M307
51065009052	M307
51065009066	M307
51065009228	M617
51065009423	M302
51065009426	M634
51065009432	M302
51065009476	M303
51065009548	M307
8132000475	M617
8311999133	M617
8311999299	M178
8311999369	M178
8311999928	M278
8312000475	M617
9042000401	M630
9042000601	M630

OEM	<i>DOLZ</i>
MAN	
9042000801	M630
9042002001	M630
9042002201	M630
9042002601	M630
9042004901	M630
9042010201	M630
9042010701	M630
MASSEY FERGUSON	
41313226	P398
41313233	P398
41313212	P398
U5MW0106	P398
MERCEDES	
3532005601	M612
3662005901	M610
4032007301	M626
4222001001	M278
3142000601	M613
3142000801	M613
3142001901	M613
3142002101	M613
3142002401	M613
3142002901	M613
3142003701	M613
3142003901	M613
3142004101	M648
3142004201	M613
3142004701	M648
3452007101	M615
3522003401	M612
3522003801	M611
3522004901	M611
3522005401	M612
3522007201	M612
3522007401	M611
3522007501	M612
3522008101	M612
3522008401	M611
3522008501	M612
3522008901	M612
3522009201	M612
3522009301	M611
3522009401	M611
3522009501	M612
3522009601	M612
3522009701	M612
3532000301	M611
3532000401	M611
3532001601	M612
3532001701	M612
3532002001	M638
3532002101	M611
3532003601	M611
3532003701	M611
3532003801	M612
3532003901	M637
3532004001	M620
3532005601	M612
3552000101	M614
3552000501	M614

OEM	<i>DOLZ</i>
MERCEDES	
3552000601	M614
3552000801	M614
3552000901	M614
3552001101	M614
3552001501	M614
3602003701	M622
3602004501	M622
3602004601	M623
3642000101	M635
3642000901	M635
3642002001	M635
3662000301	M636
3662000401	M610
3662000501	M636
3662000901	M610
3662001501	M636
3662005901	M610
3662006001	M636
4032002701	M617
4032003401	M617
4032003501	M617
4032003701	M616
4032004401	M178
4032004901	M617
4032005101	M178
4032005201	M616
4032005301	M626
4032007001	M617
4032007101	M178
4032007201	M616
4032007501	M633
4032011701	M633
4222000501	M278
4222001001	M278
4222001101	M627
4222001201	M633
432003201	M617
4412000201	M078
4412000301	M078
4572000004	M278
4572000101	M278
4572000104	M629
4572000201	M629
5000281838	M617
51065006228	M617
51065006282	M178
51065006408	M278
51065006426	M634
51065006479	M633
51065009228	M617
51065009426	M634
51065009479	M633
51065010214	M633
5412000001	M624
5412000101	M624
5412000201	M624
5412000701	M624
5412001001	M625
5412001101	M624
5412001201	M624
5412010101	M625
5412010301	M625
5422000501	M624
5422000601	M625
5422001501	M624

OEM	<i>DOLZ</i>
MERCEDES	
5422001901	M624
5422002001	M625
5422010001	M624
5422010301	M624
5422010401	M625
8132000475	M617
8311231928	M616
8311998320	M633
8311999133	M617
8311999294	M626
8311999299	M178
8311999369	M178
8311999928	M278
8311999929	M627
8312000475	M617
9042000401	M630
9042000601	M630
9042000801	M630
9042002001	M630
9042002201	M630
9042002601	M630
9042004901	M630
9042010201	M630
9042010701	M630
NEW HOLLAND	
4606023	I250
4813370	I142
4952496	I250
8829779	I271
8829790	N452
98468831	I124
98497115	I127
98497117	S239
99456317	I124
1909627	I135
1930925	I135
1940104	I135
42530032	I124
4606023	I250
4692698	I252
4695786	I260
4696707	I135
4710552	I252
4737154	I260
4757340	N458
4757341	N458
4764156	I260
4777222	I252
4777806	I127
4784454	I142
4786730	I127
4796534	N451
4796537	N460
4803730	I127
4813370	I142
4813730	I127
4815259	I127
4817651	I136
4835043	I127
4952496	I250
566997	N456
577837	N457
61315464	I133

OEM	<i>DOLZ</i>
NEW HOLLAND	
79014642	I267
8107660	I145
8822883	N453
8829779	I271
8829780	N461
8829787	N453
8829790	N452
8829805	N450
8830732	N462
93190286	I124
93190288	I123
98410023	I273
98465322	S239
98468831	I124
98497114	I127
98497115	I127
98497117	S239
98497118	S239
99454833	S240
99454833	S240
99454834	I146
99456317	I124
NISSAN	
41312725K3	P313
741001042	P318
741001052	P317
741001122	P317
741001133	P318
741001144	N124
909107	P317
999099	P317
999107	P317
999108	P318
999118	P318
PEGASO	
193921	P105
19392101	P105
197164	P186
500350798	I163
560314	P170
560316	P170
576047	P154
576380	P183
578640	P153
584509	P103
585769	P104
585817	P105
587214	P103
587218	P101
604006	P100
635097	P101
635098	P101
640688	P152
642970	P170
642980	P170
642981	P170
642988	P150
645928	P170
646793	P170
646979	P170
647148	P260

OEM	<i>DOLZ</i>
PEGASO	
647355	P184
647506	P170
648344	P186
648362	P185
648894	P186
745901	P105
745906	P105
746004	P151
770131	P196
770185	P151
773242	P187
774082	P188
93190284	I163
PERKINS	
109890	P378
41312327	P397
41312536	P367
41312784	P319
41313228	P354
122663600	P375
0950134	P376
220008KL	P314
220270K	P323
241331	P315
241331	P355
3637372M91	P315
3637411M91	P359
3637411M91	P360
41312034	P302
41312059	P321
41312063	P315
41312107	P332
41312143	P360
41312154	P311
41312155	P357
41312159	P311
41312167	P315
41312169	P332
41312201	P360
41312207	P358
41312323	P360
41312366	P360
41312456	P302
41312459	P303
41312487	P311
41312495	P311
41312518	P308
41312551	P360
41312574	P355
41312725K3	P313
41312784	P311
41312812	P316
41312892	P316
41312915	P360
41313045	P322
41313131P	P359
41313201	P360
41313209	P314
41313212	P398
41313218	P397
41313226	P398
41313232	P360
41313233	P398

OEM	<i>DOLZ</i>
PERKINS	
4131A013	P360
5046229	P332
68VB8501A	P303
68VB8501B	P303
70990318	P311
70991096	P360
70991414	P311
74100071	P360
741000710	P360
741001042	P318
741001052	P317
741001122	P317
741001133	P318
747542M91	P307
75221910	P322
8445212	P324
8853765	P312
909107	P317
91002682	P312
964217907	P365
9900184	P301
990091	P309
999016	P301
999018	P301
999024	P360
999037K	P309
999038	P310
999067	P303
999071K	P314
999076	P303
999089	P303
999099	P317
999105	P303
999107	P317
999108	P318
999113	P303
999114	P302
999118	P318
U5MW0019	P308
U5MW0023	P351
U5MW0054	P303
U5MW0057	P357
U5MW0061	P386
U5MW0062	P315
U5MW0089	P316
U5MW0096	P357
U5MW0097	P351
U5MW0104	P359
U5MW0106	P398
U5MW0108	P397
U5MW0111	P322
RENAULT	
4720031	S152
4755003	S152
4764782	S152
7303050	S152
0000773450	B116
0000773983	B116
0950134	P376
0987045300	R200
4720031	S152
4755003	S152
4764782	S152

OEM	<i>DOLZ</i>
RENAULT	
5000248443	R200
5000288046	S152
5000663009	B181
5000670157	B182
5000807860	S152
5000813420	S152
5001833230	S152
5001837263	S152
5001837264	S152
5010323187	B116
7301592	S152
7302358	S152
7303050	S152
7701450514	R200
7701450837	R200
98418986	S152
98435994	S152
99459757	S152
RENAULT V.I	
4032002701	M617
4032003401	M617
4032003501	M617
4032004901	M617
4032007001	M617
432003201	M617
5000281838	M617
51065006228	M617
51065009228	M617
8132000475	M617
8311999133	M617
8312000475	M617
SCANIA	
1314406	E110
1338490	E112
1353072	E114
1365841	E115
1375838	E120
1377571	E112
1380897	E113
1486098	E113
1508534	E115
1510490	E113
259065	E111
292761	E110
320592	E118
382183	E120
397957	E112
570951	E114
570952	E115
570953	E113
570956	E115
571157	E113
VOLVO	
1545248	V206
1545261	V201
1547155	V204
1675945	V201
1698620	V201
1699786	V201

OEM	<i>DOLZ</i>
VOLVO	
1699788	V206
1699790	V201
20431135	V207
3183908	V200
3183909	V200
3184802	V201
422791	V201
477770	V200
478845	V201
479931	V201
8112185	V200
8113117	V204
8113522	V200
8148460	V204
8149882	V204
8149937	V201
8149941	V204
8170305	V207
8192050	V200

INSTRUCCIONES DE MONTAJE

ASSEMBLING INSTRUCTIONS

1

Seleccionar la bomba adecuada al vehículo.

Choose the correct pump for you vehicle.

Wählen sie die dem fahrzeug entsprechende pumpe aus.

Choisir la pompe adaptée au véhicule.



2

Vaciar y limpiar el circuito de refrigeración.

Empty the system completely of water.

Leeren und säubern sie den kühlkreislauf.

Vider toute l'eau du circuit.

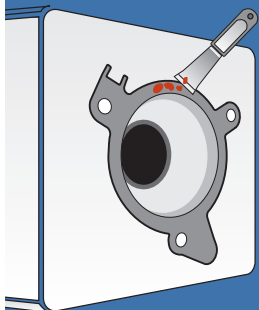

3

Al desmontar la Bomba de Agua vieja, limpiar los restos que haya en la cara de junta y alojamiento de la turbina.

When disassembling the old pump clean the gasket surface and the impellor backhousing.

Entfernen sie beim abmontiern der alten pumpe reste, die noch auf der dichtungsobenseite und auf dem sitz der turbine sein können.

Au démontage de la vieille pompe, nettoyer la surface du joint et le logement de la turbine.

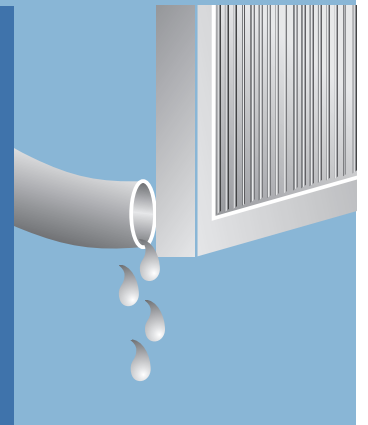

4

Colocar la nueva junta con sellante.

Fit the new gasket using the correct gasket sealer.

Die neue dichtung einsetzen und mit dichtungsmasse abdichten.

Fie le nouveau joint en utilisant la colle à joint appropriée.

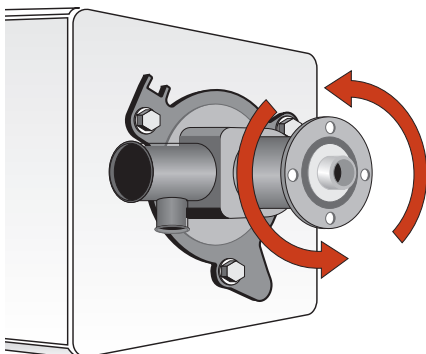
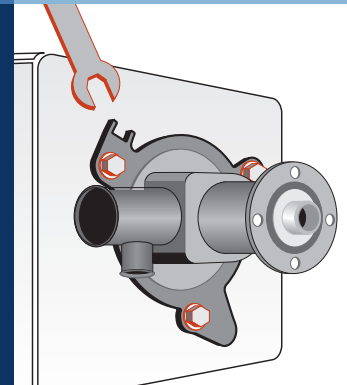
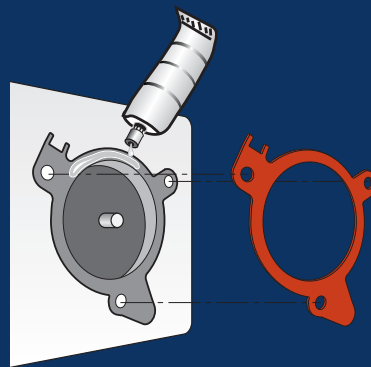

5

Apretar los tornillos de forma alternativa y uniforme. Comprobar que la Bomba esté bien posicionada y verificar el doble giro.

Tighten the screws uniformly and alternatively. Check that the pump is located correctly and turns.

Die schrauben gleichmässig anziehen. Überprüfen sie den richtigen sitz und den freien lauf der pumpe.

Serrer les vis uniformément et alternativement. Vérifier que la pompe est logée correctement et tourne.



6 Dejar secar el sellante.
Wait for the glue paste to dry.
Die dichtungsmasse trocknen lassen.
Attendre le séchage de la colle.

7 Verificar que los manguitos y conexiones están en buenas condiciones y bien conectados.

Be sure that all pipes and rubber connections are still in good condition and correctly connected.
Überprüfen sie, dass die muffen und anschlüsse in gutem zustand und richtig angeschlossen sind.
S'assurer que les tuyaux et les joints de caoutchouc sont encore en bon état et correctement fixés.

8 Verificar ventilador y correa, especialmente cuando se trate de viscoso.
Check the fan and belt to ensure in good order, in the case of an electrical fan ensure it works correctly before installing.
Überprüfen sie den ventilator und den keilriemen, insbesondere bei visco-kupplungen.
Vérifier le ventilateur et la courroie et en cas de ventilateur électrique s'assurer de son fonctionnement avant l'installation.

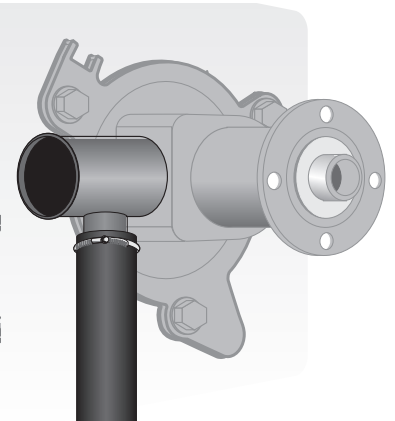
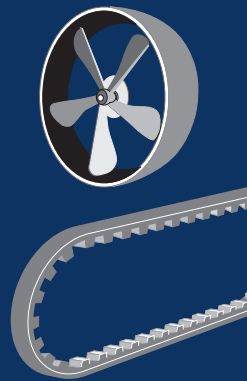

9 Tensar la correa de acuerdo al manual del constructor.

Apply the correct belt tension according to manufacturers instruction.
Spannen sie den riemen gemäß anleitung des herstellere.
Tendre la courroie selon le instructions du Constructeur.

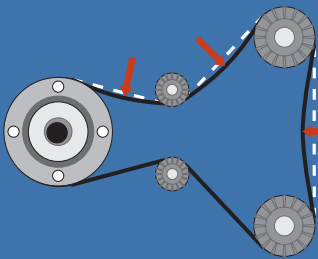

10 Llenar el circuito con líquido refrigerante adecuado al material del circuito, y de la calidad contractada

Fill the system with the correct cooling liquid right according to the manufacturers specifications.
Füllen sie den kreislauf mit kühlflüssigkeit entsprechend dem material des kreislaufs und der qualität konzentrats.
Remplir le circuit du liquide de refroidissement spécifié par le Constructeur.

11 Iniciar prueba de funcionamiento. (Posible goteo inicial)

Start the function test, it is possible that an initial leak will occur from the pump, it should stop within a few minutes.
Beginnen sie mit einem probelauf (anfänglich könnte es möglicher weise tropfen).
Tester le bon fonctionnement. Un début de fuite de la pompe peut apparaitre, mais il doit s'arrêter au bout de quelques minutes.

DOLZ
Truck

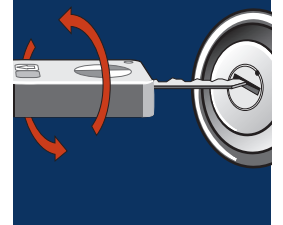

KITS DE REPARACIÓN

REPAIR KIT · KIT DE REPARATION · REPARATUR DES WERZEUGS

<i>DOLZ</i>	KIT	OEM
B116	B116KR	
D101	D101KR	
D202	D202KR	
E110	E110KRE	550167
E110/E111	E110KRT	550044
E111	E111KRE	550142-550044-550141
E114	E114KR	
I102	I102KR	
I104	I104KR	
I127	I127KR	
I142	I124KR	
I241	I240KR	1902654
I252	I252KR	
I267	I267KR	79047638-76032967
M178	M178KR	4222000060-4222000104-4222000204-51065996033
M278	M278KR	
M302	M302KR	
M303	M303KR	51065996022-51065996023-51065996039-51065996040
M610	M610KR	
M612	M612KR	3662000804-3662000060-3662000304
M613	M613KR	3522000860-3522002404-3522004504
M614	M614KR	3142000060-3142000304-551355
M615	M615KR	3552000404-3552000160
M633	M633KR	3552000704-3552000106-4222000404
P187	P187KR	
P188	P188KR	
V201	V201KR	275615

DOLZ
Truck



www.idolz.com

DOLZ

INDUSTRIAS DOLZ, S.A.

C/Vall de Uxó nº 1 · 12004 · Castellón · SPAIN
T.: +34 964 34 00 38 · F: +34 964 24 13 01
e-mail: dolz@idolz.com · www.idolz.com

DOLZ ARGENTINA, S.A.

Av. Marcelo T. de Alvear 3894
Ciudadela Bs/As · Argentina · C/P: 1702
Telefax: 5411-4488-3397/2849
e-mail: dolzar@idolz.com · www.idolz.com