

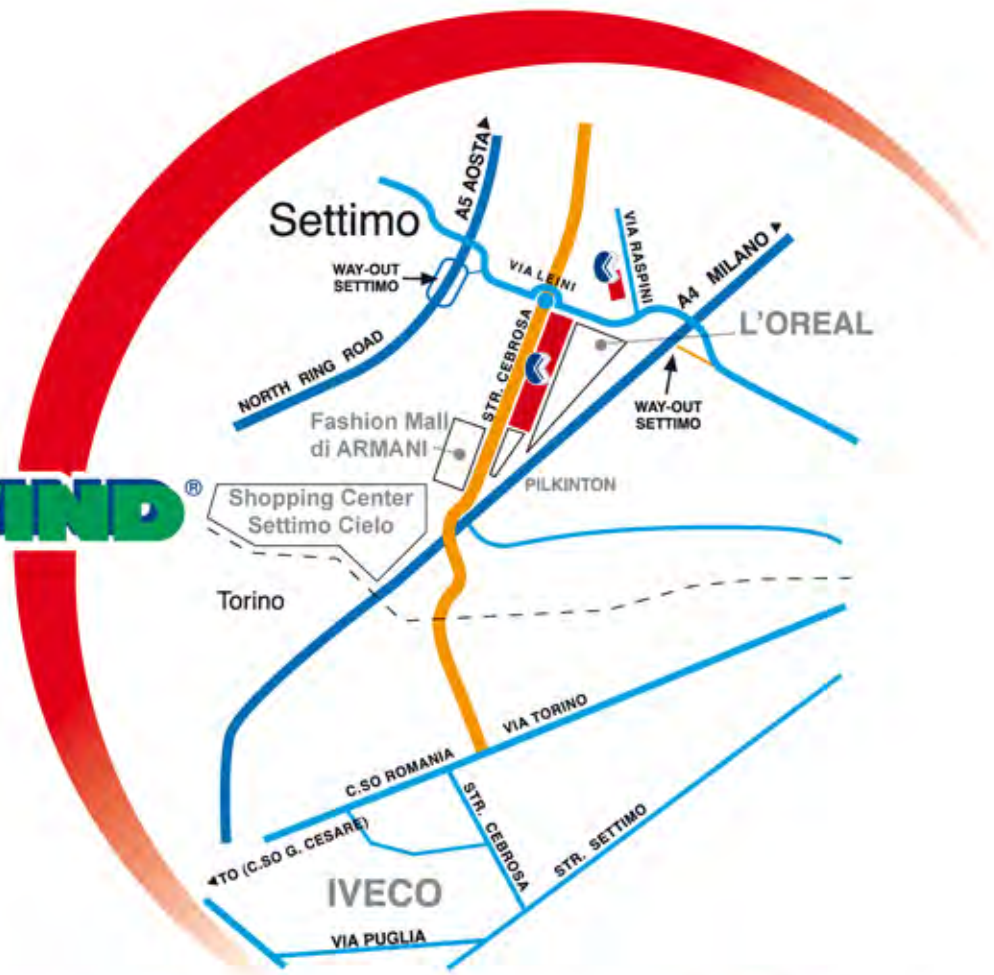

ORIGINAL COVID

2 0 1 2

VOLVO



- Autostrada Motorway
- Tangenziale Circular Road
- Provinciale Country Road
- Comunale Municipal Road



COVIND S.p.A.
Strada della Cebrosa, 68/70/72 Settimo T.se (TO)



STAMPAUTO S.r.l.
Via Alessandria, 59/61 Cascine Vica, Rivoli (TO)



KARMAN STAMPOTECH S.r.l.
Via Torino, 10/12 Airasca (TO)



VOLVO

Febbraio 2012 - February 2012



**BUREAU
VERITAS**

SGS



www.covind.it





Tutti i particolari qui elencati, pur essendo perfettamente intercambiabili con gli originali, **non sono originali**. Gli stessi vengono impiegati ed utilizzati solo per i veicoli in circolazione e solo dopo autorizzazione da parte del proprietario del veicolo in riparazione. I numeri di riferimento originali sono riportati a puro titolo informativo. Nelle trattative e nelle ordinazioni si prega di voler sempre citare i nostri numeri di riferimento. Il presente catalogo annulla e sostituisce tutti i precedenti.



Todos los elementos detallados a continuación, aunque totalmente intercambiables con los originales, **no son originales**. Estos mismos se emplean y utilizan unicamente para vehículos en circulación y previa autorización del propietario del vehículo en reparación. Los numeros de referencia originales se citan a título informativo. En las negociaciones y en los pedidos se ruega citar siempre nuestros numeros de referencia. El presente catálogo anula y substituye todos los anteriores.



Κάθε ανταλλακτικό που απαριθμείται εδώ, ακόμα κι αν όντας τέλεια ανταλλάξιμο με το γνήσιο, **δεν είναι γνήσιο**. Αυτά τα μέρη χρησιμοποιούνται μόνο στα οχήματα που είναι σε κυκλοφορία και αποκλειστικά μετά από την έγκριση του ιδιοκτήτη του οχήματος για επισκευή. Οι γνήσιοι κωδικοί που αναφέρονται υπάρχουν για πληροφοριακούς λόγους μόνο. Παρακαλούμε όπως χρησιμοποιείτε για οποιαδήποτε συναλλαγή/ παραγγελία σας τους δικούς μας αναφερόμενους κωδικούς. Ο παρών κατάλογος ακυρώνει και αντικαθιστά προηγούμενους.



Spare parts listed here, even though perfectly interchangeable with the original ones, **are not original**. These parts are used only on vehicles in circulation and exclusively under authorization of the owner of the vehicle in repair. The original reference codes are indicated for information only. You are kindly requested to indicate our reference codes in negotiations and order sheets. The present catalogue list cancels and replaces previous ones.



Veškeré zde uvedené součástky **nejsou originální díly**, i když jsou za ně stoprocentně zaměnitelné. Tyto součástky je možné použít pouze pro vozidla v provozu a pouze se souhlasem majitele vozidla, které má být opraveno. Referenční čísla originálních dílů jsou uvedena pouze informativně. Při jednáních a na objednávkách je nutné vždy uvést naše referenční čísla. Tento katalog anuluje a nahrazuje veškeré předchozí katalogy.



Hoewel elk reserveonderdeel dat hier vermeld wordt perfekt kan worden gebruikt in de plaats van de originele stukken, **gaat het hier dus niet om originele onderdelen**. Deze onderdelen worden enkel gebruikt voor voertuigen in circulatie en enkel met de toestemming van de eigenaar van het voertuig dat in reparatie is. De originele referentiecodes worden enkel ter informatie weergegeven. U wordt vriendelijk verzocht om onze referentiecodes te gebruiken in gesprekken en op de bestelformulieren. De huidige catalogoog annuleert en vervangt de vorige versies.



Reservedelene som er oppført her, er ikke **originale reservedeler**, selv om de fullt ut kan benyttes ved utskiftning av de opprinnelige delene. De skal kun benyttes på kjøretøy som er i bruk og med eierens samtykke. De opprinnelige referansekodene angis kun til etterretning. Vennligst angi våre referansekoder under forhandling og ved bestilling. Denne katalogen annullerer og erstatter alle tidligere kataloger.



Toate produsele enumerate in continuare, chiar daca sunt perfect interschimbabile cu cele originale, **nu sunt originale**. Ele sunt utilizate, numai pentru autovehiculele in circulatie si exclusiv cu acordul proprietarului autovehiculului de reparat. Codurile originale sunt indicate numai in scop informativ. Cu ocazia tratativelor verbale, cat si a emiterii ordinelor scrise, clientii sunt rugati sa utilizeze codurile noastre(COVIND) ca referinta.Prezentul catalog anuleaza si le inlocuieste pe cele precedente.



Wszystkie detale tu podane ,choć będąc doskonałe wymienne z oryginałami, **nie są oryginalne**. Te same zostają zastosowane i użyte tylko dla pojazdów w obiegu i tylko po autoryzacji ze strony właściciela pojazdu będącego w naprawie. Oryginalne numery referencyjne są umieszczone w celu czysto informacyjnym. W czasie rozmów handlowych i zamówień, prosi się zechcieć zawsze cytować nasze numery referencyjne. Niniejszy katalog anuluje i zastępuje wszystkie poprzednie.



Todas as peças aqui listadas, ainda que sejam perfeitamente intercambiáveis com as originais, **não são originais**. Estas peças só são empregues e utilizadas nos veículos em circulação e só após autorização prévia por parte do proprietário do veículo a reparar. Os números de referência originais têm um carácter puramente informativo. Nos contactos e encomendas, indique sempre os números de referência, por favor.



Selv om de sagtens kan bruges i stedet for de originale er de reservedele der indgår i **denne liste ikke originale**. Disse reservedele bruges kun til aktive køretøjer og udelukkende med ejerens tilladelse, mens reparationen udføres. De originale referencekoder fremstår kun som en oplysning. De bedes angive vores referencekoder i.f.m. forhandlinger og bestillingssedler. Det nye katalog annullerer og erstatter alle tidligere udgaver.



Reservdelarna i denna lista är inte originaldelar trots att de är **fullkomligt utbytbara med de ursprungliga**. Dessa delar används endast på fordon i cirkulation och enbart efter godkännande av ägaren till det fordon som lämnats på reparation. De originala referenskoderna anges endast för information. Var god ange våra referensnummer i negocieringar och beställningssblanketter. Den nuvarande kataloglistan annullerar och ersätter de föregående.





Alle hier aufgeführten Bestandteile sind exakt austauschbar mit den Originalteilen, **aber es sind keine Originale**. Diese Teile werden nur angewendet und eingesetzt für die Fahrzeuge die im Umlauf sind und nur nach Einverständnis mit dem Eigentümer, dessen Fahrzeug in der Reparatur ist. Die Original-Referenznummern wurden rein informativ nochmals wiedergegeben. Bei Anfragen und bei Bestellungen bitten wir Sie immer die Referenznummern anzugeben. Der beigelegte Katalog ersetzt und annulliert die vorhergehenden Kataloge.



Всички особености изредени по-долу, независимо от това, че са взаимозаменяеми с оригиналите, **не са оригинали**. Те биват използвани само за превозните средства в движение и само след упълномощаване от страна на собственика на превозното средство в ремонт.



Toutes les pièces détaillées ci-dessus, tout en étant parfaitement interchangeable avec les pièces d'origine, **ne sont pas originales**. Les mêmes pièces sont utilisées exclusivement sur les véhicules en circulation et seulement sous autorisation du propriétaire du véhicule en réparation. Les codes de référence originales sont indiqués à titre purement documentaire. Dans les négociations et les commandes veuillez bien citer nos codes de référence. Le présent catalogue annule et remplace tous les précédents.



Все перечисленные запчасти не являются оригинальными, **хотя могут отлично их заменить**. Эти запчасти используются при ремонте автомобилей только с согласия владельца.

Ссылки на порядковый номер оригинальных запчастей указаны исключительно в ориентировочных целях.

При покупках и заказах рекомендуем указывать НАШИ номера запчастей.

Настоящий каталог анулирует и заменяет все предыдущие.

Оригинальные ориентировочные номера са изнесени само за ваша информация. При преговори и при поръчки молим винаги да цитирате нашите ориентировочни номера.

Настоящият каталог анулира и замества всички съществуващи до момента.



Tässä luetteloidut varaosat eivät ole alkuperäisiä, vaikka **ne ovatkin laadultaan alkuperäisiä vastaavia**. Osat on tarkoitettu käytettäväksi liikenteessä olevissa autoissa ja niitä käytetään vain korjattavan ajoneuvon omistajan luvalla. Alkuperäiset tuotekoodit mainitaan vain tiedon vuoksi. Pyydämme teitä käyttämään neuvotteluissa ja tilauslomakkeissa meidän tuotekoodejamme. Uusi tuoteluettelo peruuttaa ja korvaa aikaisemmat luettelot.



Selles nimekirjas olevad varuosad ei ole originaalid vaatamata sellele, **et on originaalidega võrdväärset kasutatavad**. Neid osasid kasutada ainult töös olevatel sõidukitel ja üksnes remonditava sõiduki omaniku loal. Originaali viitenumbrid on ära toodud ainult infoks. Palume müügi- ja tellimislehtedel ära märkida meie viitenumbrid. Käesoleva kataloogi nimekiri tühistab ja asendab varasemad.



Devamında detaylandırılan tüm elementler, orijinalleri ile tamamen değiştirilebilir olmasına rağmen, **orijinal değildirler**. Bunlar, yalnızca dolaşımda bulunan araçlarda ve tamirde bulunan aracın sahibinden ön onay alınması kaydıyla uygulanabilir ve kullanılabilir.

Orijinallerin referans numaraları bilgi başlığında yer almaktadır.

Görüşmelerde ve siparişlerde referans numaralarımızın her zaman belirtilmesi rica olunur.

Bu katalog tüm önceki versiyonları geçersiz kılar ve bunların yerine geçer.



Kaut arī uzskaitītās rezerves daļas var pilnīgi aizstāt oriģinālās, **tās nav oriģinālas**. Šīs rezerves daļas tiek izmantotas vienīgi apgrozībā esošiem transporta līdzekļiem un tikai ar remontējamā transporta līdzekļa īpašnieka atļauju.

Oriģinālais atsauces numurs tiek uzrādīts vienīgi informācijai.

Lūdzam norādīt jūsu atsauces numurus sarunu laikā un uz pasūtījuma lapas. Šis kataloga saraksts anulē un aizstāj visus iepriekšējos.



Az itt felsorolt tartalék alkatrészek, még akkor is, ha megfelelően felcserélhetők az eredetiekkel, nem az eredetiek. Ezeket az alkatrészeket csak forgalomban lévő járművek javításánál használják és kizárólag a jármű tulajdonosának engedélyével.

Az eredeti referencia kódokat csak információs célból jelzik. Kérjük legyen szíves jelezze a referencia kódjainkat a tárgyalásokon és a megrendelési dokumentumban.

A jelenlegi katalógus lista vissza van vonva és újra az előző lista van érvényben.



Ovdje popisani prièuvni dijelovi, èak i kada savršeno zamjenjuju izvorne, **nisu izvorni**. Ti dijelovi mogu se uporabiti jedino na vozilima u cirkulaciji i na temelju izrièlitoga odobrenja vlasnika vozila na popravku.

Brojevi dijela izvornih dijelova navedeni su samo kao primjer. Najljepše vas molimo da u vašim zahtjevima i narudžbama navedete brojeve dijela.

Sadašnji katalog ukida valjanost svih prethodnih kataloga.



كافة التفاصيل المذكوره هنا وبالرغم من قابليتها للتبديل مع التفاصيل الاصلية بشكل متطابق تماما، إلا انها ليست الأصلية، نفس التفاصيل يتم الاستعانه بها واستخدامها فقط للعربات السائره و فقط بعد الحصول على التصريح بالموافقه من مالك العربيه التي يتم إصلاحها.

الأرقام الارشاديه الأصلية يتم وضعها بغرض الاستعلام، نرجو أن يتم دائما ذكر أرقامنا الخاصه الارشاديه في التعاقدات وطلبات الشراء.

هذا الكاتالوج يلغي كافة الكاتالوجات السابقه ويحل محلها.



Перелічені тут запасні частини не є оригінальними, але цілком взаємозамінні з оригінальними. Ці запасні частини застосовуються тільки на транспортних засобах, що знаходяться в експлуатації і винятково з дозволу власника, що здав транспортний засіб у ремонт.

Коди оригінальних запасних частин наводяться тільки для довідки. Прохання вказувати довідкові коди запасних частин при веденні переговорів і на бланках замовлення.

Даний каталог скасовує дію раніше виданих каталогів і замінює ці каталоги.



Ėeprav jih je moĖno perfektno izmenjati z originalnimi deli, tukaj navedeni nadomestni deli niso originalni. Te dele se uporabljajo samo v vozilih v prometu in izkljuĖeno samo pod pogojem, da lastnika vozila v popravilu izda zato dovoljenje. Navedene originalne referenĖne kode so le informativne. Prosimo vas, da navedite naĖe referenĖne kode pri pogajanju in na naroĖilih. S sedanjim seznamom prenehajo veljati preĖjnji sezname in jih nadomesti.



Ėia iĖvardytos atsarginĖs dalys nĖra originalios, taĖiau jomis galima pakeisti originaliaĖias. Ŗios dalys naudojamos tik apyvartoje esanĖiuose automobiliuose ir tik gavus remontuojamo automobilio savininko sutikimą.

Originalių dalių kodai nurodomi tik informacijos sumetimais. Maloniai praĖome nusiskundimuose ir uĖsakymų lapuose nurodyti dalių kodus.

Ŗiame kataloge pateikiamas saraĖas anuliuoja ir pakeiĖia ankstesniusius.



قطعات قيد شده در اينجا با اينكه آنها كاملا قابل تعويض با قطعات اصلي مي باشند. قطعات اصلي نيستند. اين قطعات تنها براي خودروهايي كه در جريان مي باشند (خارج از محل توليد مي باشند) مورد استفاده قرار مي گيرند و منحصرآ تحت اختيار و نضر مالكه خودروي در حال تعمير مي باشند. با احترامات ما از شما شماره كد ارجاع اصلي تنها براي اطلاعات مي باشند. تقاضا داريم كه شماره كد ارجاع را در زمان مذاكره و در ورقه تقاضا مشخص كنيد. ليست



Indice | Index

▼ pagina | page

Medi / Medium

- 1 FL 2006
- 5 FE 2006
- 9 FM7-FM10-FM12 seconda serie / second series
- 15 FM7-FM10-FM12 prima serie / first series

Pesanti / Trucks

- 23 FH13 terza serie 2008 / third series 2008
- 33 FH12-FH16 seconda serie / second series
- 41 FH12-FH16 prima serie / first series
- 49 F12

Tabelle Comparative | Cross Reference
VOLVO / COVIND

Tabelle Comparative | Cross Reference
COVIND / VOLVO

Cod. Originale O.E.M. Ref.	Cod. Covind Covind ref.	pag. Cat. page Cat.	Cod. Originale O.E.M. Ref.	Cod. Covind Covind ref.	pag. Cat. page Cat.	Cod. Originale O.E.M. Ref.	Cod. Covind Covind ref.	pag. Cat. page Cat.
-	0FH/144	43	1406622	385/194	3	1587659-2	V12/165	-
-	0FH/920	44	1407256	385/195	3	1587660-0	V12/164	-
-	0FH/921	44	1500858	V12/175	54	1588269-9	N12/231	-
-	940/110	17	1500859	V12/174	54	1588270-7	N12/230	-
-	940/112	50	1508953	V12/113	54	1588723-5	V12/105	51
-	940/113	50	1508954	V12/115	54	1588740-9	V12/216	52
-	940/116	17	1509510-2	V12/214	52	1588741-7	V12/215	52
-	N12/ 2	-	1509511-0	V12/212	52	1588738-3	V12/147	-
-	N12/ 3	-	1509801-5	V12/251	51	1589309	V12/243	52
158612-6	V12/244	52	1509799-1	V12/250	51	1590507	V12/619	52
677950	V12/173	54	1509805-6	V12/252	51	1590947	V12/429	50
680662	V12/172	54	1509844-5	V12/240	-	1590948	V12/428	50
680663	V12/171	54	1509846-0	V12/242	52	1591054-0	V12/455	-
687895	V12/196	54	1509922-9	V12/211	52	1591057-3	V12/456	-
1062133	0FM/241	18	1509924-5	V12/210	52	1591146	V12/800	52
1062134	0FM/240	18	1509932	V12/170	-	1591558	V12/260	51
1062190	0FH/650	43	1509937	V12/270	51	1592458	V12/375	50
1062547	0FH/135	43	1509945-0	V12/230	52	1593174	V12/257	51
1062548	0FH/134	43	1509987	V12/238	52	1593411-0	V12/145	-
1063327	0FH/193	45	1517957-5	V12/108	50	1593850-9	N12/800	-
1063328	0FH/192	45	1521324	V12/156	51	1594077-8	V12/248	51
1063509	0FH/150	43	1570895	V12/180	54	1599297	0FH/510	46
1063726	0FM/210	18	1570896	V12/179	54	1605245	V12/196	54
1079981	2FH/510	39	1570897	V12/163	54	1605420-7	V12/149	-
1080926	V12/ 90	50	1570898	V12/162	54	1605421-5	V12/148	-
1081346-7	N12/205	-	1570986-8	V12/316	52	1606375	0FH/166	45
1081350-9	N12/140	-	1571117	V12/ 5	51	1607094-8	V12/370	50
1081347-5	N12/204	-	1571118	V12/ 4	51	1607103-7	N12/365	-
1083666-6	V12/155	50	1573732	V12/600	51	1607178	V12/271	51
1086222	V12/ 19	-	1575818	V12/ 19	-	1607238	V12/435	-
1086223	V12/ 18	-	1575819	V12/ 18	-	1607250	V12/434	-
1086533	0FH/ 5	45	1578408	V12/140	-	1607898	V12/168	50
1086534	0FH/ 4	45	1578428-3	V12/231	52	1610713-8	N12/315	-
1088870-9	V12/ 89	50	1584316-2	V12/ 94	51	1610782-3	V12/159	51
1088871-7	V12/ 88	50	1585210-6	V12/146	-	1610783-1	V12/158	51
1089122-4	V12/ 99	50	1586120-6	V12/244	52	1610787	V12/427	50
1089123-2	V12/ 98	50	1586124-4	V12/243	52	1610788	V12/426	50
1089967	V12/230	52	1586591-8	V12/131	-	1610808-6	V12/204	50
1254749	V12/196	54	1586592-6	V12/130	-	1610809	V12/203	50

Cod. Originale O.E.M. Ref.	Cod. Covind Covind ref.	pag. Cat. page Cat.	Cod. Originale O.E.M. Ref.	Cod. Covind Covind ref.	pag. Cat. page Cat.	Cod. Originale O.E.M. Ref.	Cod. Covind Covind ref.	pag. Cat. page Cat.
1611178-3	V12/100	50	1626679	0FH/ 93	43	3175419	2FH/ 96	35
1611590-9	V12/150	-	1626680	0FH/ 92	43	3175545	2FH/155	36
1611754	V12/166	50	1660358	V12/340	50	3175546	2FH/154	36
1612331	V12/169	50	1661382	V12/343	50	3175547	2FH/157	36
1612622-9	V12/ 74	52	1661854	V12/345	50	3175548	2FH/156	36
1612621-1	V12/ 75	52	1664215	V12/340	50	3175863	0FH/155	43
1612764-9	N12/109	-	1665132	V12/347	50	3175927	2FH/201	37
1612762-3	N12/103	-	1676400	2FH/620	-	3175928	2FH/200	37
1612763-1	N12/102	-	1696262-3	V12/104	51	3175929	2FH/207	37
1612978-5	V12/460	-	1697860-3	N12/161	-	3175930	2FH/206	37
1613085	V12/195	53	1697861-1	N12/160	-	3175933	2FH/205	37
1614048	0FH/700	43	1697967-6	V12/ 7	50	3175934	2FH/204	37
1614428-9	V12/103	51	1697968-4	V12/ 6	50	3175937	2FH/203	-
1614429-7	V12/102	51	1697976-7	V12/110	51	3175938	2FH/202	-
1614457-8	V12/ 84	52	1697978-3	V12/ 11	-	3176545	0FM/175	19
1614458-6	V12/ 87	52	1697979-1	V12/ 10	-	3176546	0FM/174	19
1614459-4	V12/ 86	52	1698145-8	V12/156	51	3953182	0FH/166	45
1614456-0	V12/ 85	52	1698146-6	V12/135	50	3980869	0FH/135	43
1614460-2	V12/ 83	52	1698147-4	V12/134	50	3980870	0FH/134	43
1614461-0	V12/ 82	52	1698144-1	V12/157	51	3981593	0FH/710	43
1614490-9	V12/246	51	1698650-7	V12/ 3	50	3981666	0FH/610	43
1614491-7	V12/247	51	1698651-5	V12/ 2	50	3981668	0FH/604	43
1614503-9	V12/315	-	1699059	V12/900	-	3981923	0FM/175	19
1614589-8	V12/317	52	3090484	0FH/196	45	3981924	0FM/174	19
1617429	N12/145	-	3090971	0FH/134	43	3987252	2FH/517	39
1619254	0FH/800	43	3090972	0FH/135	43	3175367+3175366	2FH/110	36
1621181-5	V12/160	50	3127594	2FH/619	40	6778814	V12/167	50
1621182	V12/112	50	3175029	0FH/190	45	8141003	0FH/241	44
1621183	V12/111	50	3175032	0FH/700	43	8141004	0FH/240	44
1621184	V12/135	50	3175032	V12/700	50	8141236	0FH/205	44
1621185	V12/134	50	3175158	0FM/201	18	8141237	0FH/204	44
1621325	V12/157	51	3175159	0FM/200	18	8141289	0FH/ 95	43
1621376	V12/155	50	3175246	0FH/201	44	8141290	0FH/ 94	43
1621903	V12/ 99	50	3175247	0FH/200	44	8141312	0FH/243	44
1621904	V12/ 98	50	3175376	2FM/145	11	8141313	0FH/242	44
1623459	0FH/320	44	3175406	2FH/241	37	8144107	0FH/201	44
1623888-3	V12/200	50	3175407	2FH/240	37	8144108	0FH/200	44
1623942	V12/600	51	3175417	2FH/ 89	35	8144454	0FH/ 90	43
1624923-7	V12/ 95	-	3175418	2FH/ 97	35	8144455	0FH/145	43

Cod. Originale O.E.M. Ref.	Cod. Covind Covind ref.	pag. Cat. page Cat.	Cod. Originale O.E.M. Ref.	Cod. Covind Covind ref.	pag. Cat. page Cat.	Cod. Originale O.E.M. Ref.	Cod. Covind Covind ref.	pag. Cat. page Cat.
8144482	0FH/150	43	20360789	2FH/208	37	20425627	2FH/ 92	35
8144524	0FH/146	43	20372123	2FM/149	-	20429679	2FH/ 80	35
8144525	0FH/147	43	20372226	0FH/ 93	43	20429680	2FH/ 85	35
8144526	0FH/149	43	20372227	0FH/ 92	43	20429681	2FH/ 84	35
8144527	0FH/148	43	20379171	2FM/161	-	20452847	2FH/133	36
8150689	V12/ 90	50	20379172	2FM/160	-	20452848	2FH/132	36
8152595	N12/ 90	-	20379175	2FH/161	36	20452886	2FH/135	36
8152722	0FH/ 96	43	20379176	2FH/160	36	20452887	2FH/134	36
8155808	0FH/515	46	20379437	0FH/215	44	20453627	2FH/ 99	36
8156540	0FH/321	44	20379438	0FH/212	44	20453676	2FH/237	35
8156551	0FH/518	46	20379439	0FH/210	44	20453677	2FH/236	35
8156554	0FH/519	46	20379593	0FH/191	45	20453690	3FH/ 85	27
8156556	0FH/510	46	20382691	2FH/800	-	20453716	2FH/150	36
8158216	V12/ 90	50	20391450	2FM/148	-	20453900	2FH/325	37
8189092	0FH/161	44	20391451	2FM/146	-	20453930	2FH/ 95	36
8189093	0FH/160	44	20391452	2FM/147	-	20453931	2FH/ 94	36
8189130	0FH/105	43	20392544	2FH/505	39	20456550	2FH/100	35
8189295	0FH/105	43	20392599	2FH/518	39	20456804	2FH/ 86	35
8189329	0FH/ 90	43	20398253	2FH/145	36	20456805	2FH/ 88	35
8190106	0FH/515	46	20398385	0FH/135	43	20456806	2FH/ 87	35
8191220	0FH/110	43	20398386	0FH/134	43	20456963	2FH/153	36
8191313	0FH/215	44	20398387	0FM/135	17	20467037	2FH/ 5	38
8191314	0FH/212	44	20398388	0FM/134	17	20467038	2FH/ 4	38
8191315	0FH/210	44	20398466	0FH/195	45	20467053	2FH/115	36
8191316	0FH/105	43	20398467	0FH/194	45	20467142	2FH/143	36
8191406	0FM/145	17	20398707	2FH/ 85	35	20467143	2FH/142	36
8191409	0FM/161	17	20398708	2FH/ 84	35	20467442	2FH/100	35
8191412	0FM/160	17	20398709	2FH/ 80	35	20499243	2FH/ 80	35
8191421	0FM/110	17	20398907	0FH/ 5	45	20507020	2FH/ 95	36
8191593	0FM/241	18	20398908	0FH/ 4	45	20507021	2FH/ 94	36
8191594	0FM/240	18	20409818	2FH/152	36	20507252	2FH/619	40
8191826	0FM/217	18	20409874	2FH/605	-	20516776	2FH/150	36
8191827	0FM/216	18	20409874	2FH/607	36	20523232	2FM/144	-
9520400	0FH/670	48	20409875	2FH/604	-	20529638	2FH/241	37
20360266	2FH/145	36	20409875	2FH/606	36	20529640	2FH/240	37
20360507	0FH/145	43	20425418	2FH/137	36	20529668	2FH/163	36
20360542	2FH/ 3	38	20425419	2FH/136	36	20529672	2FH/162	36
20360543	2FH/ 2	38	20425625	2FH/ 90	35	20529682	2FH/205	37
20360788	2FH/209	37	20425626	2FH/ 93	35	20529684	2FH/204	37

Cod. Originale O.E.M. Ref.	Cod. Covind Covind ref.	pag. Cat. page Cat.	Cod. Originale O.E.M. Ref.	Cod. Covind Covind ref.	pag. Cat. page Cat.	Cod. Originale O.E.M. Ref.	Cod. Covind Covind ref.	pag. Cat. page Cat.
20529704	2FH/158	-	21078545	3FH/136	28	82215391	3FH/143	26
20529705	2FH/155	36	21094391	3FH/515	31	82215401	3FH/142	26
20529706	2FH/154	36	21094392	3FH/522	31	82367098	3FH/ 99	28
20529707	2FH/157	36	21094393	3FH/523	31	82367957	3FH/ 98	28
20529708	2FH/156	36	21094394	3FH/525	31	501544026	385/213	2
20529738	2FH/111	36	21094394	3FH/525	31	501544027	385/212	2
20529740	2FH/ 89	35	21094457	3FH/510	31	501544029	385/217	7
20529741	2FH/ 97	35	21190825	3FH/140	26	501544030	385/216	7
20529742	2FH/ 96	35	21425186	3FH/ 85	27	5001836267	385/195	3
20529765	0FH/199	44	21445302	3FH/150	27	5001836268	385/194	3
20530146	2FH/110	36	21445754	3FH/151	27	5001858129	385/195	3
20533138	2FH/159	-	21448885	3FH/609	-	5001858130	385/194	3
20534600	2FH/ 99	36	21451000	3FH/ 95	28	5010225181	385/210	7
20534601	2FH/ 98	36	21451002	3FH/ 94	28	5010225398	385/215	2
20538006	MDL/241	2	21478481	3FH/155	27	5010353495	MDL/241	2
20545094	2FH/149	36	21478751	3FH/608	-	5010353496	MDL/240	2
20545095	2FH/148	36	21478755	3FH/134	28	5010441020	0FH/190	45
20583434	2FH/513	39	21478759	3FH/135	28	5010544526	385/215	2
20583434	2FH/517	39	20383543+3175366	2FH/111	36	5010544527	385/215	2
20583440	2FH/514	39	82052484	3FH/ 95	28	5010578381	PRM/245	7
20711859	2FH/ 80	35	82056727	3FH/140	26	5010578387	PRM/244	7
20711860	2FH/ 85	35	82056840	3FH/150	27	7420498623	PRM/515	32
20711861	2FH/ 84	35	82062209	3FH/157	27	7420726748	2FH/515	39
20789440	2FH/610	36	82063513	3FH/154	27	7420819613	PRM/ 98	6
20826211	2FH/607	36	82063911	3FH/156	27	7420819616	PRM/ 99	6
20826213	2FH/606	36	82065120	3FH/155	27			
20826227	2FH/137	36	82065609	3FH/155	27			
20826231	2FH/136	36	82066238	3FH/ 97	28			
20827042	2FH/ 99	36	82066335	3FH/ 96	28			
20827044	2FH/ 98	36	82072463	3FH/152	27			
20861583	2FH/601	-	82076158	3FH/135	28			
20861584	2FH/600	-	82076266	3FH/134	28			
20888780	2FM/144	-	82090257	3FH/151	27			
20917957	2FH/ 99	36	82114502	3FH/608	-			
20917958	2FH/ 98	36	82114504	3FH/609	-			
20936759	2FH/515	39	82209788	3FH/ 99	28			
20936759	2FH/515	39	(82053690+169898-01)	3FH/ 99				
20936769	2FH/520	39	82209849	3FH/ 98	28			
21078543	3FH/137	28	(82056986+169898-02)	3FH/ 98				

Cod. Covind Covind ref.	Cod. Originale O.E.M. Ref.	pag. Cat. page Cat.	Cod. Covind Covind ref.	Cod. Originale O.E.M. Ref.	pag. Cat. page Cat.	Cod. Covind Covind ref.	Cod. Originale O.E.M. Ref.	pag. Cat. page Cat.
OFH/ 4	1086534	45	OFH/190	3175029	45	OFH/710	3981593	43
OFH/ 4	20398908	45	OFH/190	5010441020	45	OFH/800	1619254	43
OFH/ 5	1086533	45	OFH/191	20379593	45	OFH/920	-	44
OFH/ 5	20398907	45	OFH/192	1063328	45	OFH/921	-	44
OFH/ 90	8144454	43	OFH/193	1063327	45	OFM/110	8191421	17
OFH/ 90	8189329	43	OFH/194	20398467	45	OFM/134	20398388	17
OFH/ 92	1626680	43	OFH/195	20398466	45	OFM/135	20398387	17
OFH/ 92	20372227	43	OFH/196	3090484	45	OFM/145	8191406	17
OFH/ 93	1626679	43	OFH/199	20529765	44	OFM/160	8191412	17
OFH/ 93	20372226	43	OFH/200	3175247	44	OFM/161	8191409	17
OFH/ 94	8141290	43	OFH/200	8144108	44	OFM/174	3176546	19
OFH/ 95	8141289	43	OFH/201	3175246	44	OFM/174	3981924	19
OFH/ 96	8152722	43	OFH/201	8144107	44	OFM/175	3981923	19
OFH/105	8191316	43	OFH/204	8141237	44	OFM/175	3176545	19
OFH/105	8189130	43	OFH/205	8141236	44	OFM/200	3175159	18
OFH/105	8189295	43	OFH/210	8191315	44	OFM/201	3175158	18
OFH/110	8191220	43	OFH/210	20379439	44	OFM/210	1063726	18
OFH/134	1062548	43	OFH/212	8191314	44	OFM/216	8191827	18
OFH/134	3980870	43	OFH/212	20379438	44	OFM/217	8191826	18
OFH/134	20398386	43	OFH/215	8191313	44	OFM/240	1062134	18
OFH/134	3090971	43	OFH/215	20379437	44	OFM/240	8191594	18
OFH/135	1062547	43	OFH/240	8141004	44	OFM/241	1062133	18
OFH/135	3980869	43	OFH/241	8141003	44	OFM/241	8191593	18
OFH/135	20398385	43	OFH/242	8141313	44	2FH/ 2	20360543	38
OFH/135	3090972	43	OFH/243	8141312	44	2FH/ 3	20360542	38
OFH/144	-	43	OFH/320	1623459	44	2FH/ 4	20467038	38
OFH/145	20360507	43	OFH/321	8156540	44	2FH/ 5	20467037	38
OFH/145	8144455	43	OFH/510	1599297	46	2FH/ 80	20398709	35
OFH/146	8144524	43	OFH/510	8156556	46	2FH/ 80	20429679	35
OFH/147	8144525	43	OFH/515	8155808	46	2FH/ 80	20499243	35
OFH/148	8144527	43	OFH/515	8190106	46	2FH/ 80	20711859	35
OFH/149	8144526	43	OFH/518	8156551	46	2FH/ 84	20398708	35
OFH/150	1063509	43	OFH/519	8156554	46	2FH/ 84	20429681	35
OFH/150	8144482	43	OFH/604	3981668	43	2FH/ 84	20711861	35
OFH/155	3175863	43	OFH/610	3981666	43	2FH/ 85	20398707	35
OFH/160	8189093	44	OFH/650	1062190	43	2FH/ 85	20429680	35
OFH/161	8189092	44	OFH/670	9520400	48	2FH/ 85	20711860	35
OFH/166	3953182	45	OFH/700	3175032	43	2FH/ 86	20456804	35
OFH/166	1606375	45	OFH/700	1614048	43	2FH/ 87	20456806	35

Cod. Covind Covind ref.	Cod. Originale O.E.M. Ref.	pag. Cat. page Cat.	Cod. Covind Covind ref.	Cod. Originale O.E.M. Ref.	pag. Cat. page Cat.	Cod. Covind Covind ref.	Cod. Originale O.E.M. Ref.	pag. Cat. page Cat.
2FH/ 88	20456805	35	2FH/145	20398253	36	2FH/325	20453900	37
2FH/ 89	20529740	35	2FH/148	20545095	36	2FH/505	20392544	39
2FH/ 89	3175417	35	2FH/149	20545094	36	2FH/510	1079981	39
2FH/ 90	20425625	35	2FH/150	20453716	36	2FH/513	20583434	39
2FH/ 92	20425627	35	2FH/150	20516776	36	2FH/514	20583440	39
2FH/ 93	20425626	35	2FH/152	20409818	36	2FH/515	20936759	39
2FH/ 94	20453931	36	2FH/153	20456963	36	2FH/515	7420726748	39
2FH/ 94	20507021	36	2FH/154	3175546	36	2FH/515	20936759	39
2FH/ 95	20453930	36	2FH/154	20529706	36	2FH/517	3987252	39
2FH/ 95	20507020	36	2FH/155	3175545	36	2FH/517	20583434	39
2FH/ 96	3175419	35	2FH/155	20529705	36	2FH/518	20392599	39
2FH/ 96	20529742	35	2FH/156	3175548	36	2FH/520	20936769	39
2FH/ 97	3175418	35	2FH/156	20529708	36	2FH/600	20861584	-
2FH/ 97	20529741	35	2FH/157	3175547	36	2FH/601	20861583	-
2FH/ 98	20534601	36	2FH/157	20529707	36	2FH/604	20409875	-
2FH/ 98	20827044	36	2FH/158	20529704	-	2FH/605	20409874	-
2FH/ 98	20917958	36	2FH/159	20533138	-	2FH/606	20409875	36
2FH/ 99	20453627	36	2FH/160	20379176	36	2FH/606	20826213	36
2FH/ 99	20827042	36	2FH/161	20379175	36	2FH/607	20409874	36
2FH/ 99	20917957	36	2FH/162	20529672	36	2FH/607	20826211	36
2FH/ 99	20534600	36	2FH/163	20529668	36	2FH/610	20789440	36
2FH/100	20456550	35	2FH/200	3175928	37	2FH/619	3127594	40
2FH/100	20467442	35	2FH/201	3175927	37	2FH/619	20507252	40
2FH/110	20530146	36	2FH/202	3175938	-	2FH/620	1676400	-
2FH/110	3175367+3175366	36	2FH/203	3175937	-	2FH/800	20382691	-
2FH/111	20383543+3175366	36	2FH/204	3175934	37	2FM/144	20523232	-
2FH/111	20529738	36	2FH/204	20529684	37	2FM/144	20888780	-
2FH/115	20467053	36	2FH/205	3175933	37	2FM/145	3175376	11
2FH/132	20452848	36	2FH/205	20529682	37	2FM/146	20391451	-
2FH/133	20452847	36	2FH/206	3175930	37	2FM/147	20391452	-
2FH/134	20452887	36	2FH/207	3175929	37	2FM/148	20391450	-
2FH/135	20452886	36	2FH/208	20360789	37	2FM/149	20372123	-
2FH/136	20425419	36	2FH/209	20360788	37	2FM/160	20379172	-
2FH/136	20826231	36	2FH/236	20453677	35	2FM/161	20379171	-
2FH/137	20425418	36	2FH/237	20453676	35	385/194	1406622	3
2FH/137	20826227	36	2FH/240	3175407	37	385/194	5001858130	3
2FH/142	20467143	36	2FH/240	20529640	37	385/194	5001836268	3
2FH/143	20467142	36	2FH/241	3175406	37	385/195	1407256	3
2FH/145	20360266	36	2FH/241	20529638	37	385/195	5001858129	3

Cod. Covind Covind ref.	Cod. Originale O.E.M. Ref.	pag. Cat. page Cat.	Cod. Covind Covind ref.	Cod. Originale O.E.M. Ref.	pag. Cat. page Cat.	Cod. Covind Covind ref.	Cod. Originale O.E.M. Ref.	pag. Cat. page Cat.
385/195	5001836267	3	3FH/155	82065120	27	PRM/ 99	7420819616	6
385/210	5010225181	7	3FH/155	82065609	27	PRM/244	5010578387	7
385/212	501544027	2	3FH/156	82063911	27	PRM/245	5010578381	7
385/213	501544026	2	3FH/157	82062209	27	PRM/515	7420498623	32
385/215	5010225398	2	3FH/510	21094457	31	V12/ 2	1698651-5	50
385/215	5010544526	2	3FH/515	21094391	31	V12/ 3	1698650-7	50
385/215	5010544527	2	3FH/522	21094392	31	V12/ 4	1571118	51
385/216	501544030	7	3FH/523	21094393	31	V12/ 5	1571117	51
385/217	501544029	7	3FH/525	21094394	31	V12/ 6	1697968-4	50
3FH/ 85	21425186	27	3FH/525	21094394	31	V12/ 7	1697967-6	50
3FH/ 85	20453690	27	3FH/608	21478751	-	V12/ 10	1697979-1	-
3FH/ 94	21451002	28	3FH/608	82114502	-	V12/ 11	1697978-3	-
3FH/ 95	21451000	28	3FH/609	21448885	-	V12/ 18	1086223	-
3FH/ 95	82052484	28	3FH/609	82114504	-	V12/ 18	1575819	-
3FH/ 96	82066335	28	940/110	-	17	V12/ 19	1086222	-
3FH/ 97	82066238	28	940/112	-	50	V12/ 19	1575818	-
3FH/ 98	82209849	28	940/113	-	50	V12/ 74	1612622-9	52
	(82056986+169898-02)		940/116	-	17	V12/ 75	1612621-1	52
3FH/ 98	82367957	28	MDL/240	5010353496	2	V12/ 82	1614461-0	52
3FH/ 99	82209788	28	MDL/241	20538006	2	V12/ 83	1614460-2	52
	(82053690+169898-01)		MDL/241	5010353495	2	V12/ 84	1614457-8	52
3FH/ 99	82367098	28	N12/ 2	-	-	V12/ 85	1614456-0	52
3FH/134	21478755	28	N12/ 3	-	-	V12/ 86	1614459-4	52
3FH/134	82076266	28	N12/ 90	8152595	-	V12/ 87	1614458-6	52
3FH/135	21478759	28	N12/102	1612763-1	-	V12/ 88	1088871-7	50
3FH/135	82076158	28	N12/103	1612762-3	-	V12/ 89	1088870-9	50
3FH/136	21078545	28	N12/109	1612764-9	-	V12/ 90	1080926	50
3FH/137	21078543	28	N12/140	1081350-9	-	V12/ 90	8158216	50
3FH/140	21190825	26	N12/145	1617429	-	V12/ 90	8150689	50
3FH/140	82056727	26	N12/160	1697861-1	-	V12/ 94	1584316-2	51
3FH/142	82215401	26	N12/161	1697860-3	-	V12/ 95	1624923-7	-
3FH/143	82215391	26	N12/204	1081347-5	-	V12/ 98	1621904	50
3FH/150	21445302	27	N12/205	1081346-7	-	V12/ 98	1089123-2	50
3FH/150	82056840	27	N12/230	1588270-7	-	V12/ 99	1621903	50
3FH/151	21445754	27	N12/231	1588269-9	-	V12/ 99	1089122-4	50
3FH/151	82090257	27	N12/315	1610713-8	-	V12/100	1611178-3	50
3FH/152	82072463	27	N12/365	1607103-7	-	V12/102	1614429-7	51
3FH/154	82063513	27	N12/800	1593850-9	-	V12/103	1614428-9	51
3FH/155	21478481	27	PRM/ 98	7420819613	6	V12/104	1696262-3	51

Cod. Covind Covind ref.	Cod. Originale O.E.M. Ref.	pag. Cat. page Cat.	Cod. Covind Covind ref.	Cod. Originale O.E.M. Ref.	pag. Cat. page Cat.	Cod. Covind Covind ref.	Cod. Originale O.E.M. Ref.	pag. Cat. page Cat.
V12/105	1588723-5	51	V12/172	680662	54	V12/315	1614503-9	-
V12/108	1517957-5	50	V12/173	677950	54	V12/316	1570986-8	52
V12/110	1697976-7	51	V12/174	1500859	54	V12/317	1614589-8	52
V12/111	1621183	50	V12/175	1500858	54	V12/340	1660358	50
V12/112	1621182	50	V12/179	1570896	54	V12/340	1664215	50
V12/113	1508953	54	V12/180	1570895	54	V12/343	1661382	50
V12/115	1508954	54	V12/195	1613085	53	V12/345	1661854	50
V12/130	1586592-6	-	V12/196	687895	54	V12/347	1665132	50
V12/131	1586591-8	-	V12/196	1254749	54	V12/370	1607094-8	50
V12/134	1621185	50	V12/196	1605245	54	V12/375	1592458	50
V12/134	1698147-4	50	V12/200	1623888-3	50	V12/426	1610788	50
V12/135	1621184	50	V12/203	1610809	50	V12/427	1610787	50
V12/135	1698146-6	50	V12/204	1610808-6	50	V12/428	1590948	50
V12/140	1578408	-	V12/210	1509924-5	52	V12/429	1590947	50
V12/145	1593411-0	-	V12/211	1509922-9	52	V12/434	1607250	-
V12/146	1585210-6	-	V12/212	1509511-0	52	V12/435	1607238	-
V12/147	1588738-3	-	V12/214	1509510-2	52	V12/455	1591054-0	-
V12/148	1605421-5	-	V12/215	1588741-7	52	V12/456	1591057-3	-
V12/149	1605420-7	-	V12/216	1588740-9	52	V12/460	1612978-5	-
V12/150	1611590-9	-	V12/230	1089967	52	V12/600	1623942	51
V12/155	1621376	50	V12/230	1509945-0	52	V12/600	1573732	51
V12/155	1083666-6	50	V12/231	1578428-3	52	V12/619	1590507	52
V12/156	1521324	51	V12/238	1509987	52	V12/700	3175032	50
V12/156	1698145-8	51	V12/240	1509844-5	-	V12/800	1591146	52
V12/157	1621325	51	V12/242	1509846-0	52	V12/900	1699059	-
V12/157	1698144-1	51	V12/243	1589309	52			
V12/158	1610783-1	51	V12/243	1586124-4	52			
V12/159	1610782-3	51	V12/244	1586120-6	52			
V12/160	1621181-5	50	V12/244	158612-6	52			
V12/162	1570898	54	V12/246	1614490-9	51			
V12/163	1570897	54	V12/247	1614491-7	51			
V12/164	1587660-0	-	V12/248	1594077-8	51			
V12/165	1587659-2	-	V12/250	1509799-1	51			
V12/166	1611754	50	V12/251	1509801-5	51			
V12/167	6778814	50	V12/252	1509805-6	51			
V12/168	1607898	50	V12/257	1593174	51			
V12/169	1612331	50	V12/260	1591558	51			
V12/170	1509932	-	V12/270	1509937	51			
V12/171	680663	54	V12/271	1607178	51			

VOLVO

VOLVO FL 2006



1

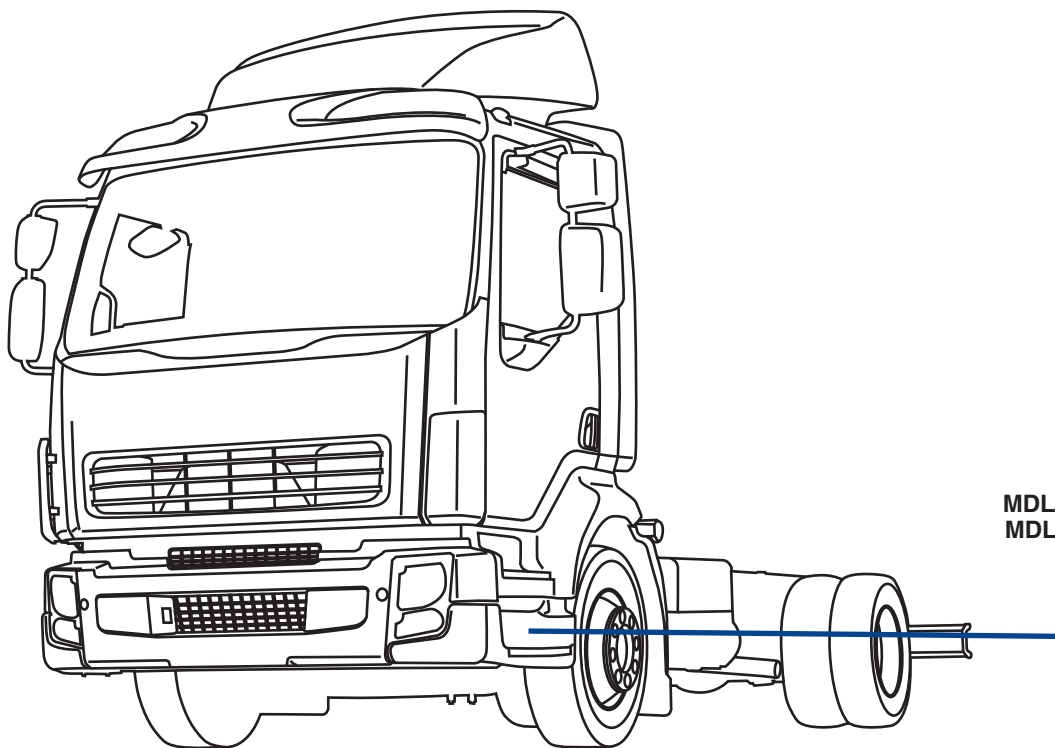

MDL/240 d/rh
MDL/241 s/lh

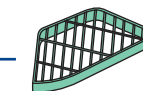
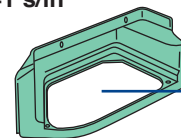

385/215
d/s - rh/lh
alluminio
aluminium
385/212 d/rh
385/213 s/lh
polipropilene
polypropylene

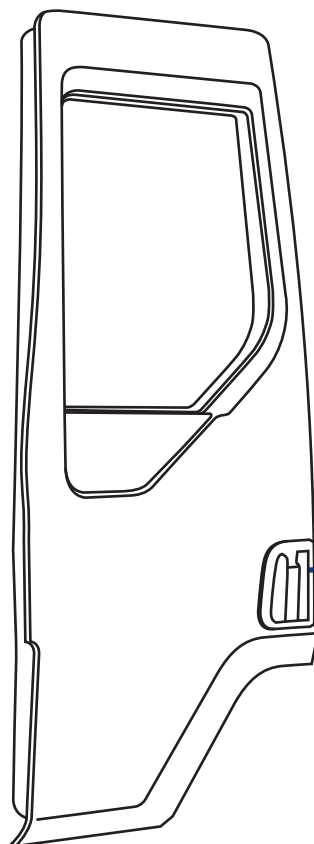

385/194 d/rh/rechts
385/195 s/lh/links
s/chiave - s/nottolino - nera
without key - without plug - black

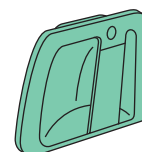



3

124L

400

VOLVO

VOLVO FE 2006



5

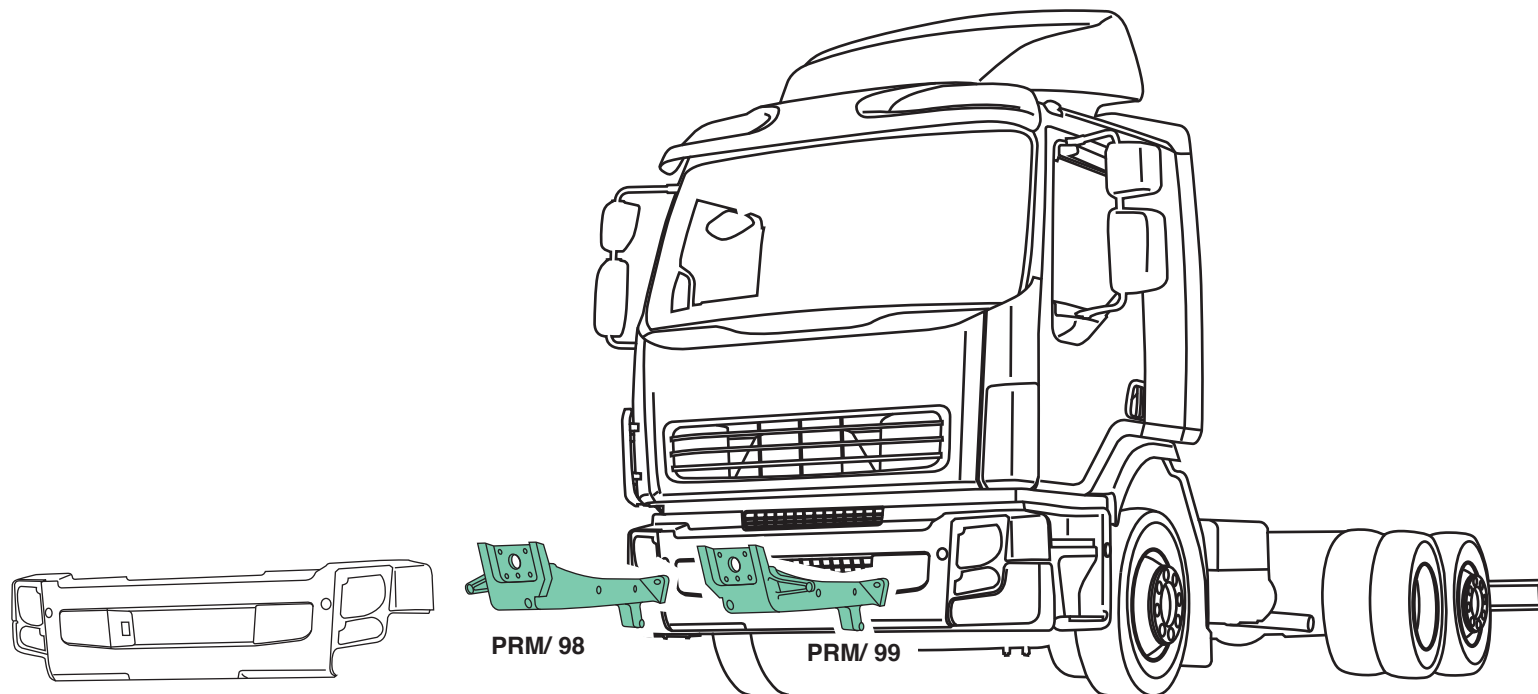

(*) vernice di fondo
 (*) unprocessed

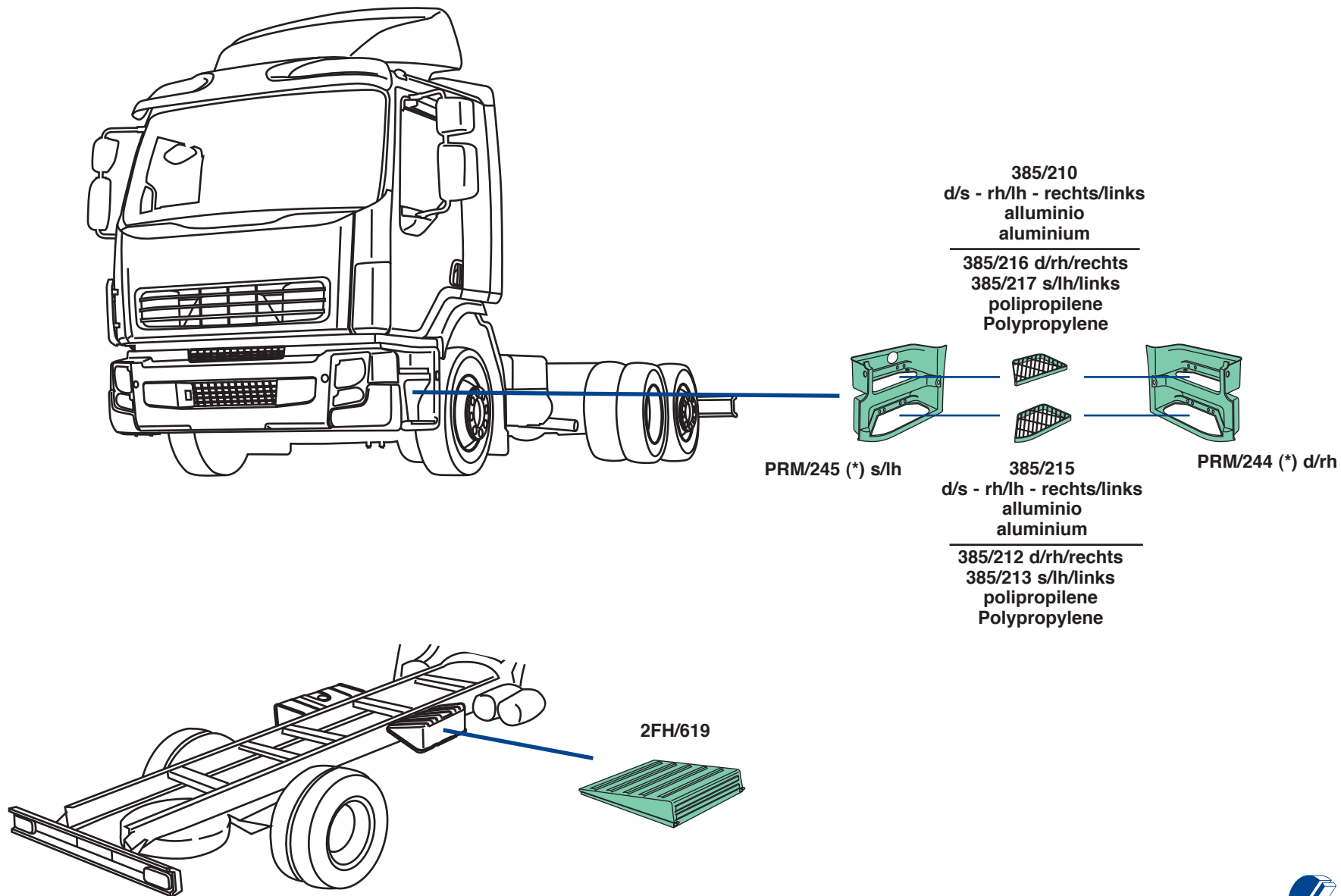

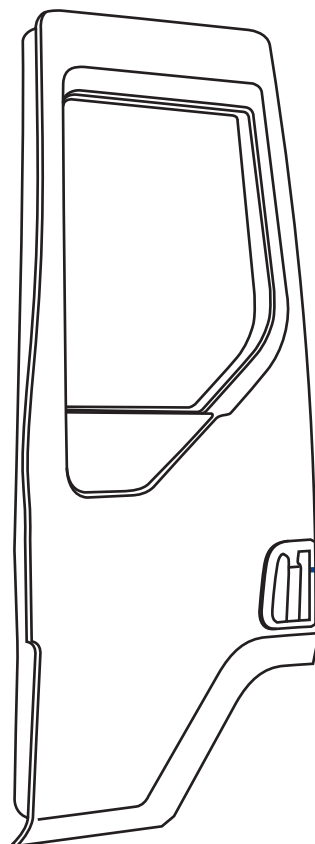

385/194 d/rh/rechts
385/195 s/lh/links
s/chiave - s/nottolino - nera
without key - without plug - black

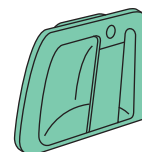

VOLVO

VOLVO FM7-FM10-FM12
seconda serie - second series



9



VOLVO FM7-FM10-FM12 seconda serie - second series

(*) >2007 singole - singles
2007> 2FH/152 + 2FH/153 (in coppia - a pair of)

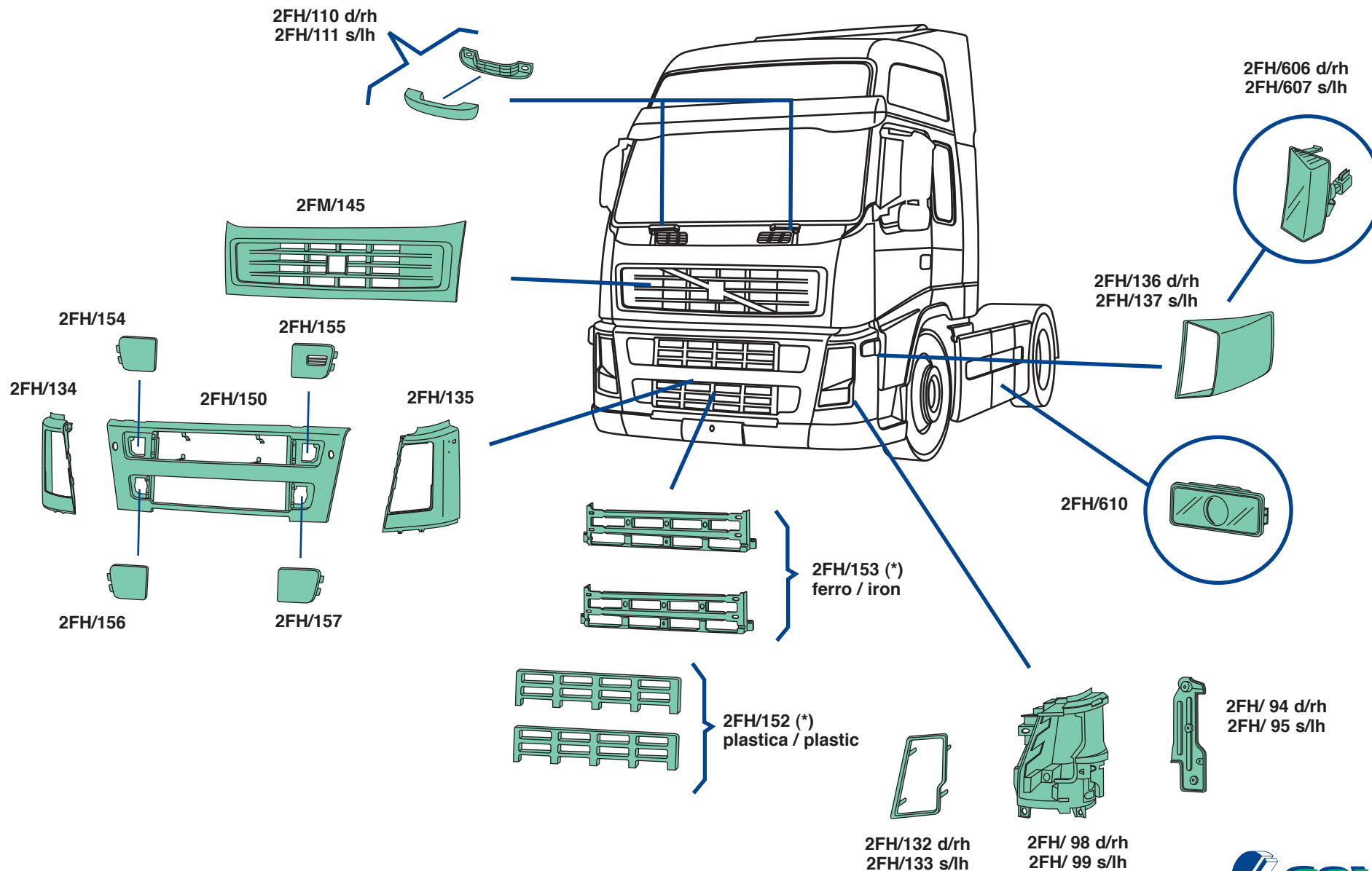

VOLVO FM7-FM10-FM12 seconda serie - second series

(*) Vernice di fondo
(*) Unprocessed

(°) Verniciato nero
(°) Black painted

0FH/190

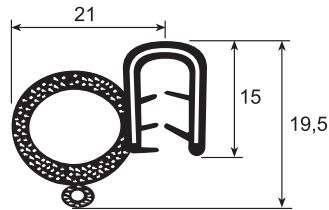

12

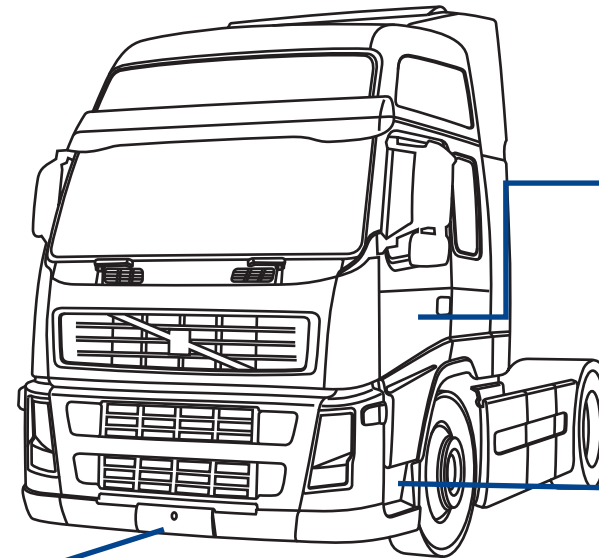

0FH/190

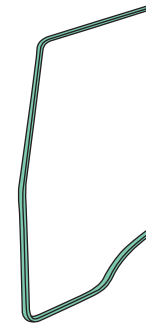

0FM/200 d/rh
0FM/201 s/lh

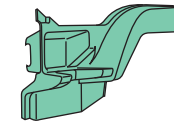

0FM/210
d/s - rh/lh

2FH/208 d/rh
2FH/209 s/lh

2FH/240 d/rh
2FH/241 s/lh

2FH/ 84
cava/cantiere
yard & quarry version
ferro / iron



2FH/ 80
cava/cantiere
yard & quarry version
ferro / iron

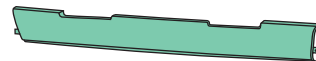

2FH/ 85
cava/cantiere
yard & quarry version
ferro / iron



2FH/236 d/rh
2FH/237 s/lh



2FH/ 92(*)
plastica / plastic



2FH/ 96(°)
plastica / plastic

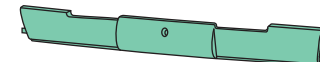

2FH/ 90(*)
plastica / plastic



2FH/ 93(*)
plastica / plastic

2FH/ 89(°)
plastica / plastic

2FH/ 97(°)
plastica / plastic

2FH/ 87
plastica / plastic



2FH/ 86
plastica / plastic



2FH/ 88
plastica / plastic



VOLVO FM7-FM10-FM12 seconda serie - second series

(*) Applicabile con il cinghietto 2FH/510 / Applied with stretcher 2FH/510
 (°) Applicabile con il cinghietto PRM/515 / Applied with stretcher PRM/515

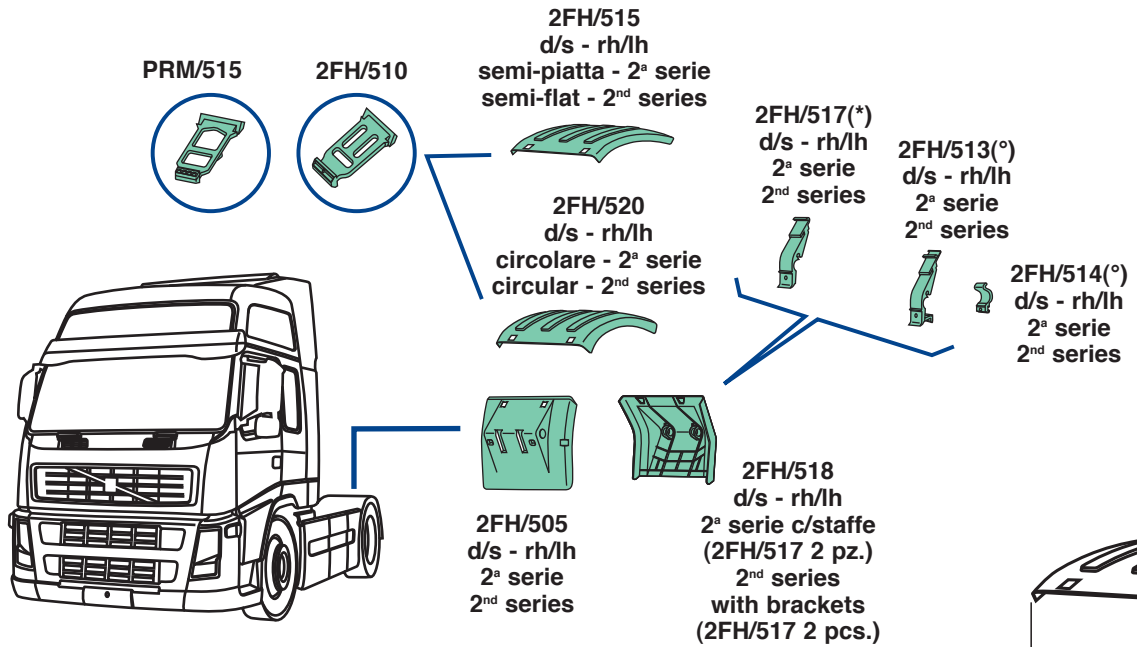

- con anti-spray/with anti-spray **A**
- senza anti-spray/without anti-spray **B**
- con cinghietti/with stretcher **C**
- senza cinghietti/without stretcher **D**

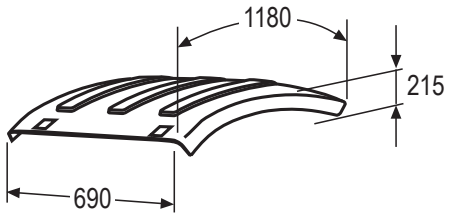

D
2FH/515
d/s-rh/lh

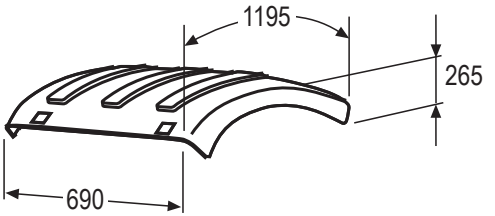

D
2FH/520
d/s-rh/lh

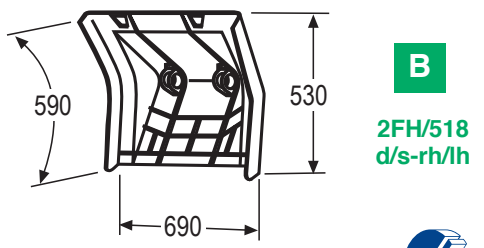
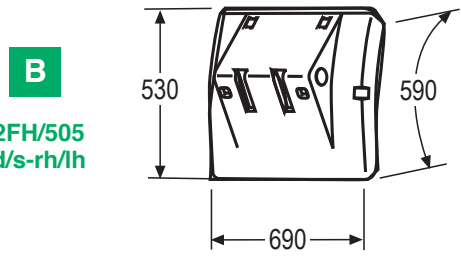

0FH/670

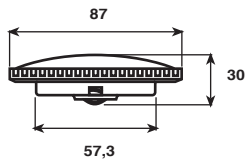

0FH/670
senza chiave
without key

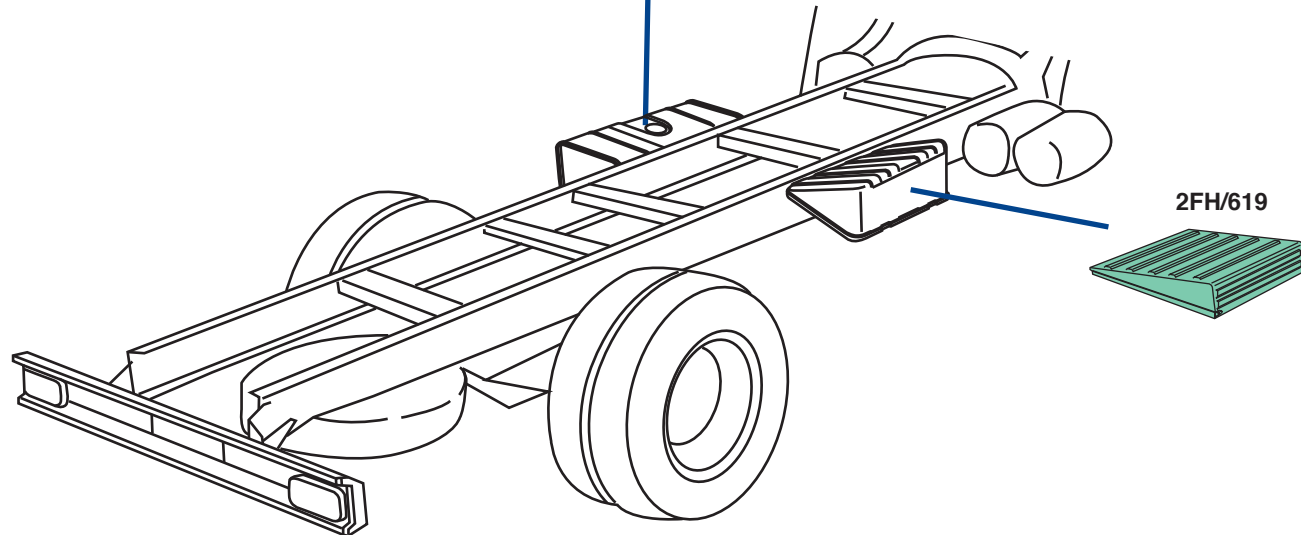
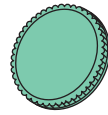

VOLVO

VOLVO FM7-FM10-FM12
prima serie - first series



15



VOLVO FM7-FM10-FM12
prima serie - first series

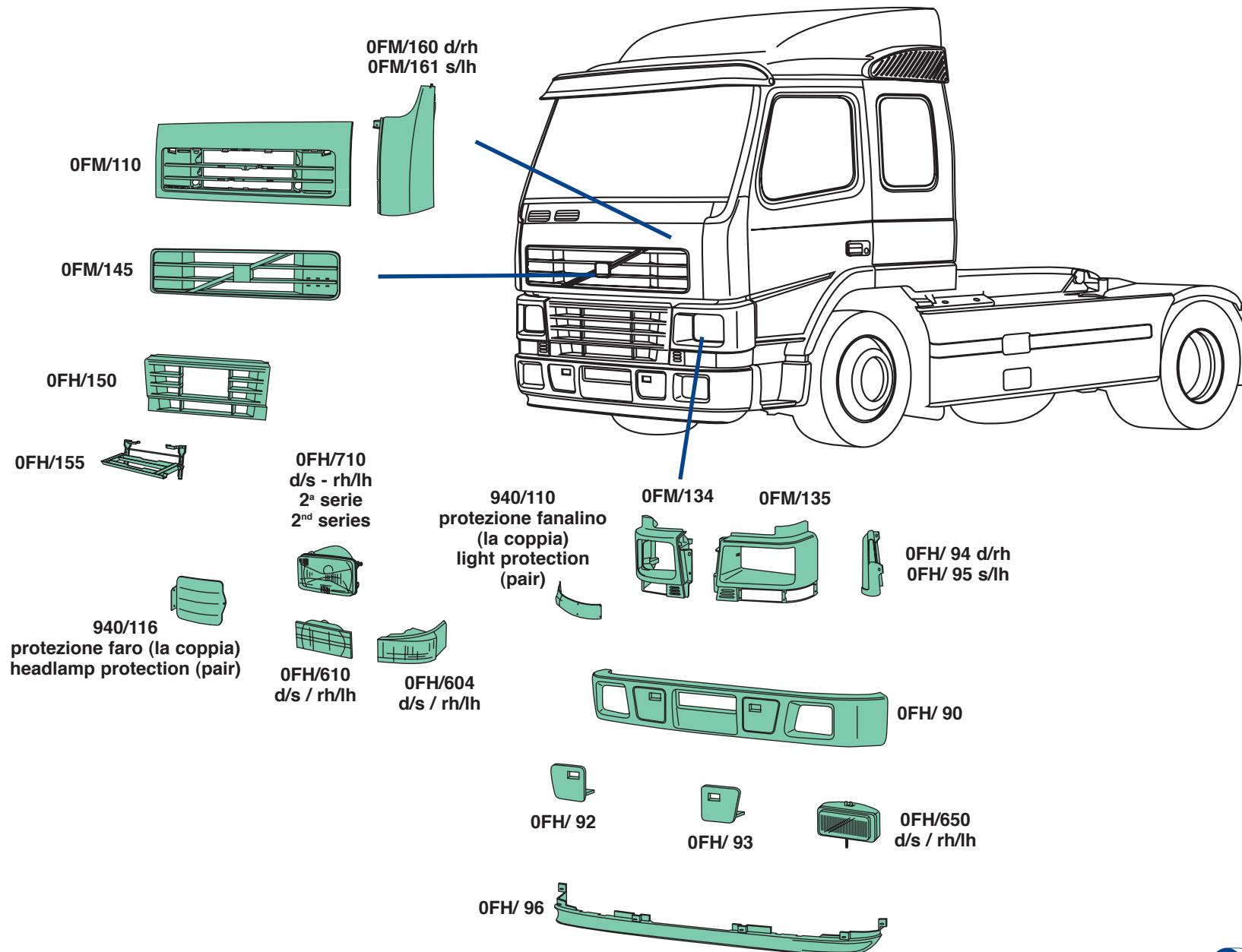

VOLVO FM7-FM10-FM12
prima serie - first series

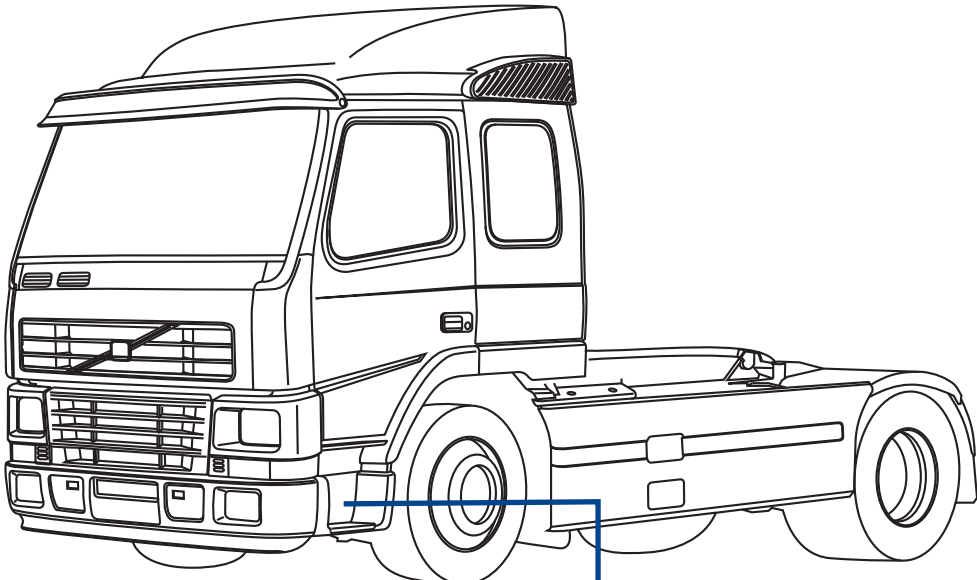

OFM/200 d/rh
OFM/201 s/lh

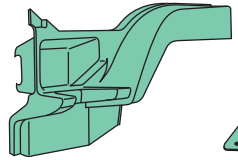

OFM/210
d/s - rh/lh

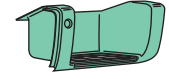
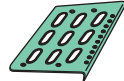

OFM/240 d/rh
OFM/241 s/lh

OFM/216 d/rh
OFM/217 s/lh

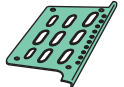

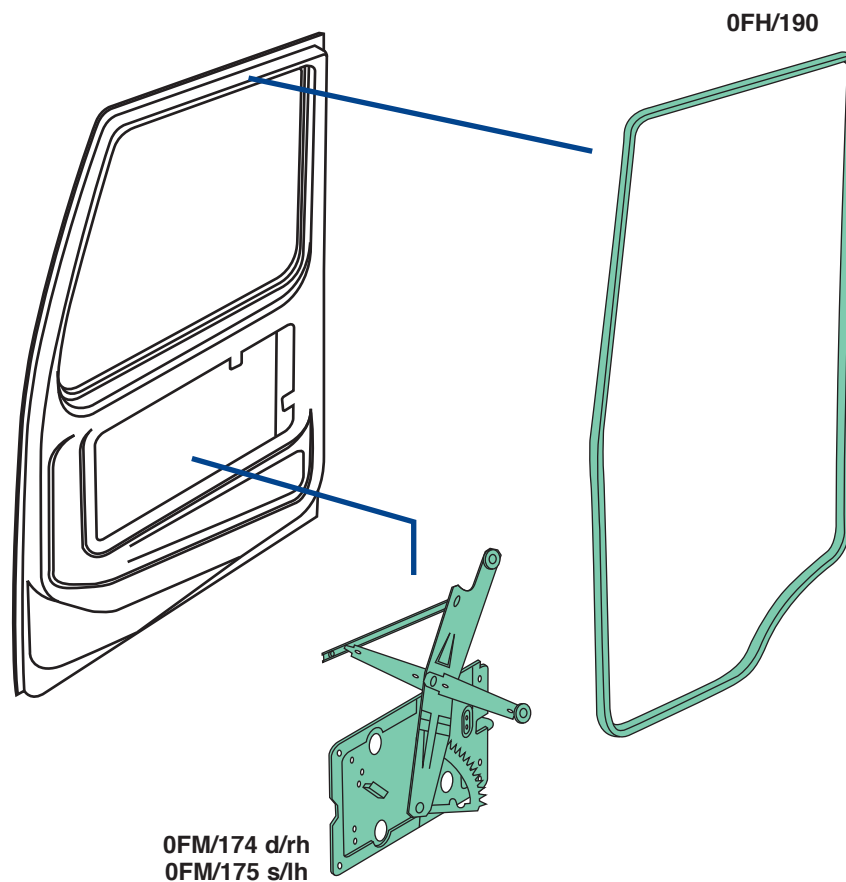
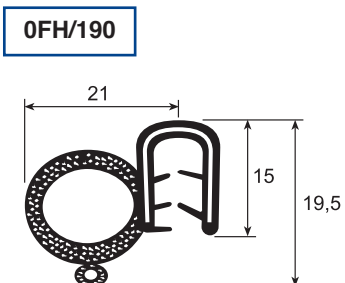
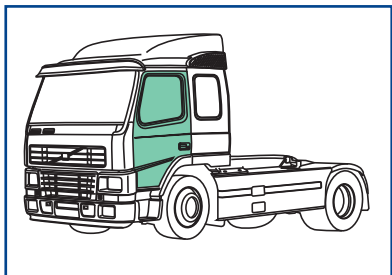

VOLVO FM7-FM10-FM12
prima serie - first series

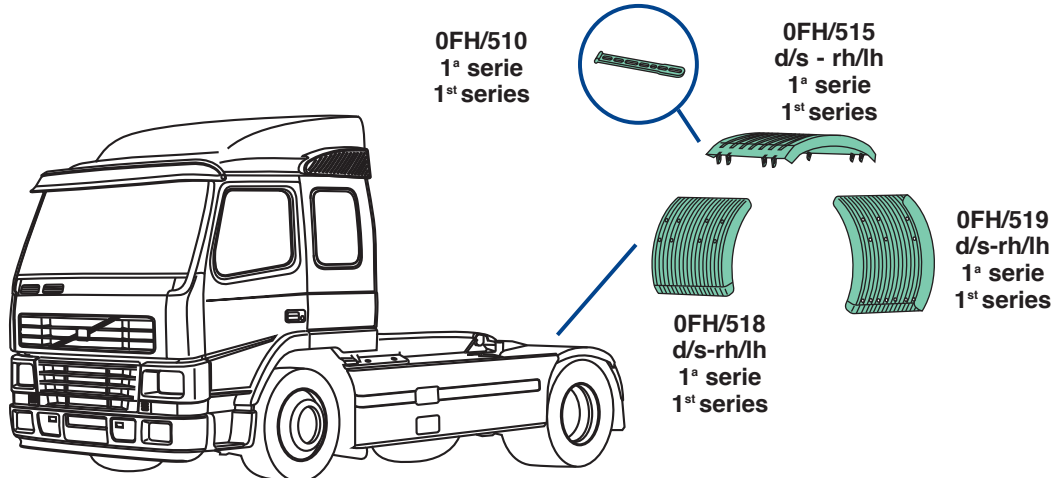

- con anti-spray/with anti-spray **A**
- senza anti-spray/without anti-spray **B**
- con cinghietti/with stretcher **C**
- senza cinghietti/without stretcher **D**

C

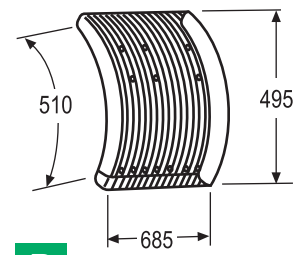
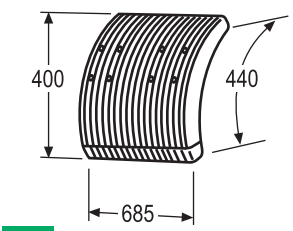
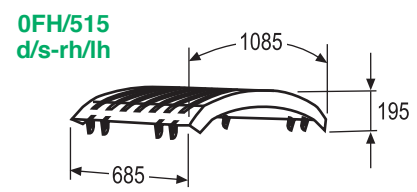

VOLVO FM7-FM10-FM12 prima serie - first series

(*) Applicabile con il cinghietto 2FH/510 / Applied with stretcher 2FH/510
 (°) Applicabile con il cinghietto PRM/515 / Applied with stretcher PRM/515

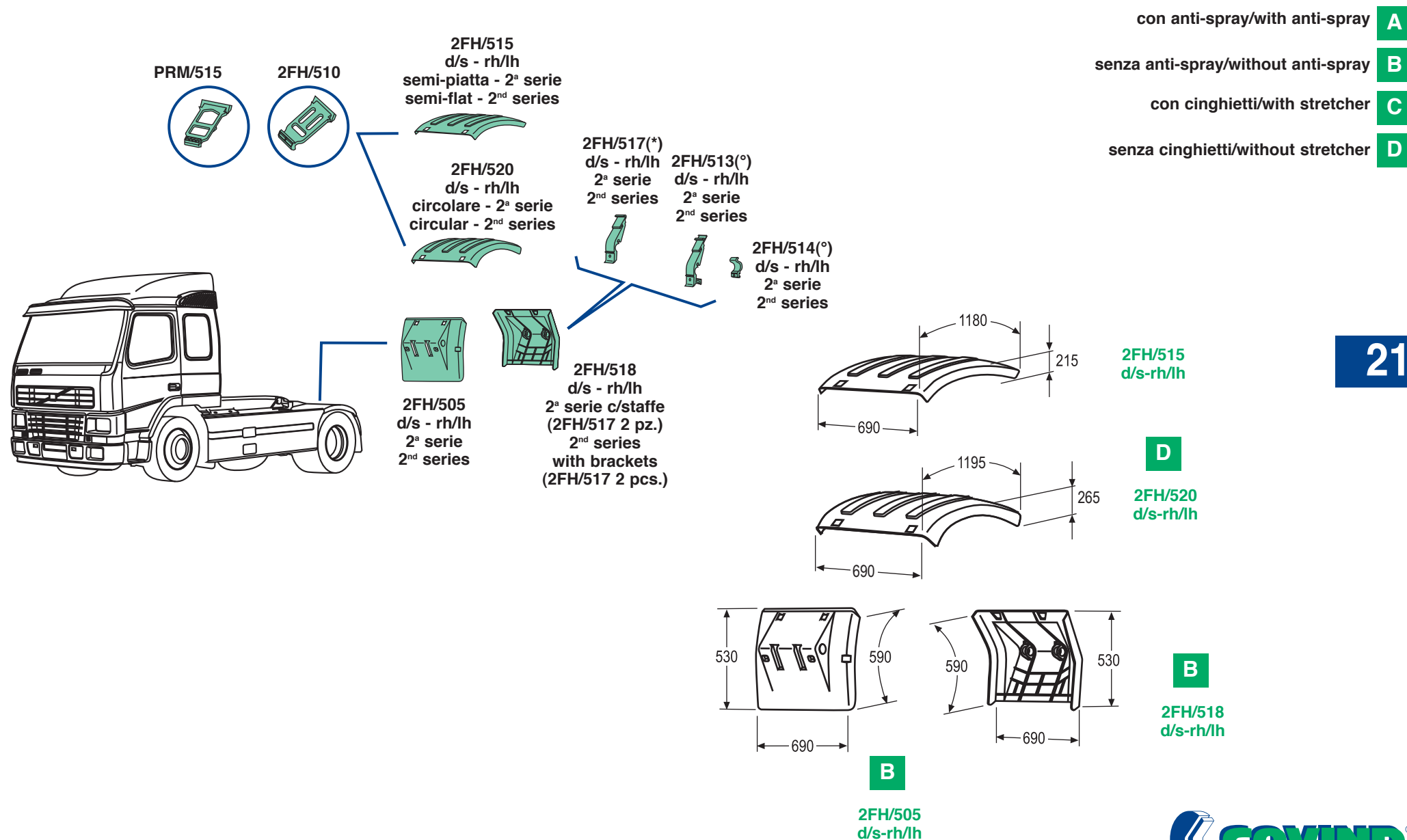

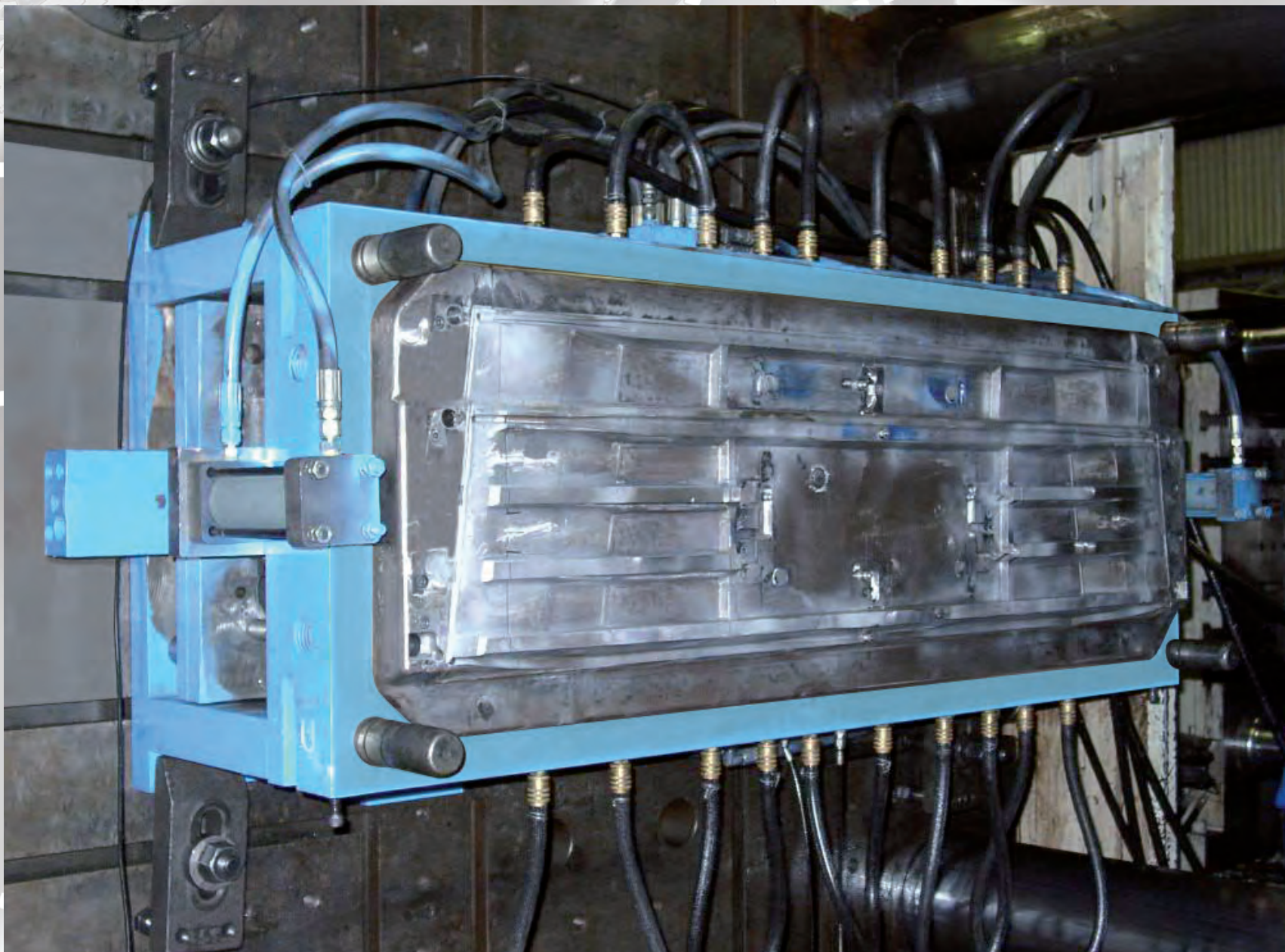

▲ Stampo a iniezione per la produzione della griglia inferiore per il veicolo Volvo (Codice Covind 0FH/150) - Injection mould for the production of the lower grille for the Volvo vehicle (Cod. Covind 0FH/150)

VOLVO

VOLVO FH13 terza serie 2008
third series 2008



23

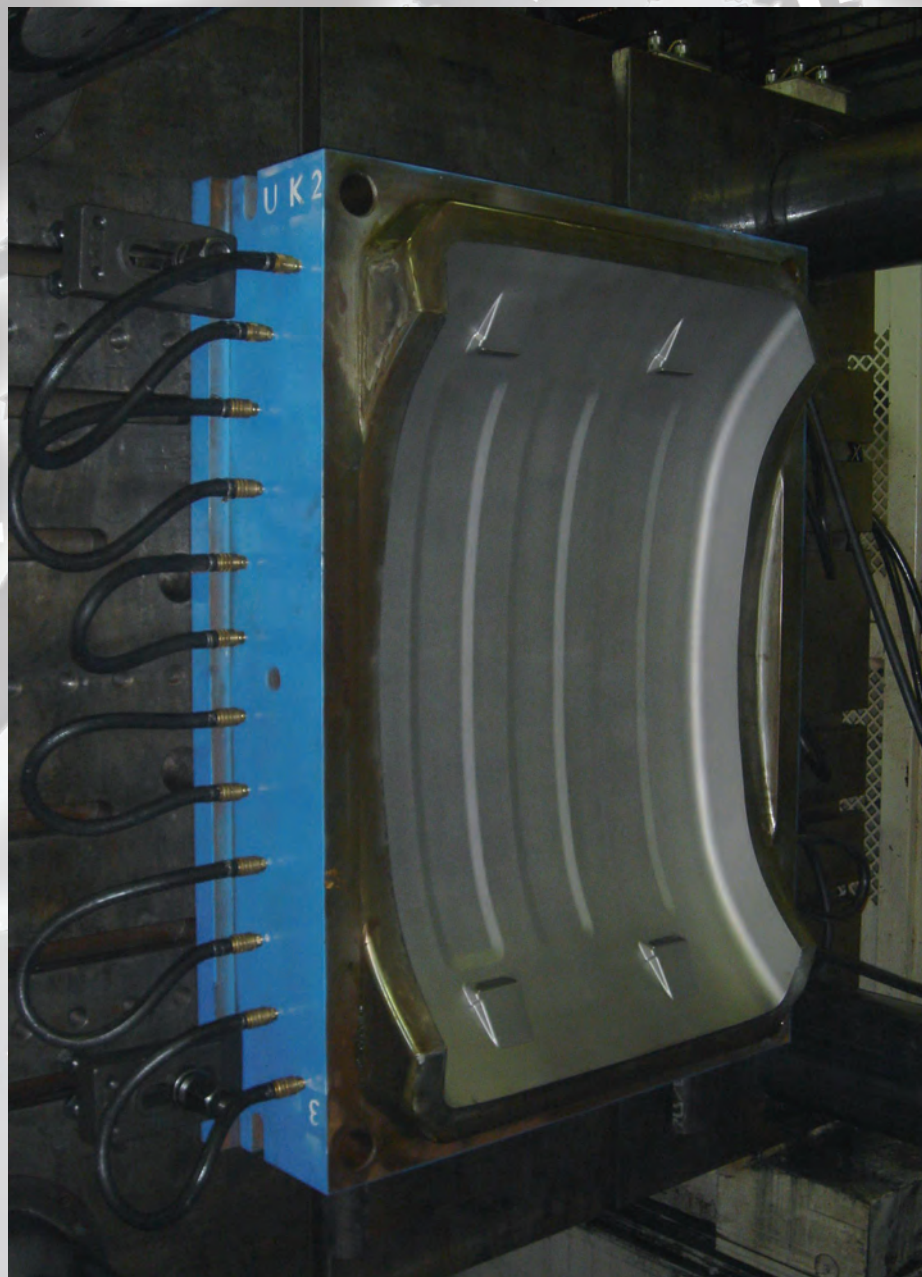

▲ Stampo a iniezione per la produzione della calotta posteriore del veicolo Volvo (Cod. Covind 2FH/515) - Injection mould for the production of the rear top guard for the Volvo vehicles (Cod. Covind 2FH/515)

(*) Vernice di fondo

(*) Unprocessed

(°) Verniciato nero

(°) Black painted

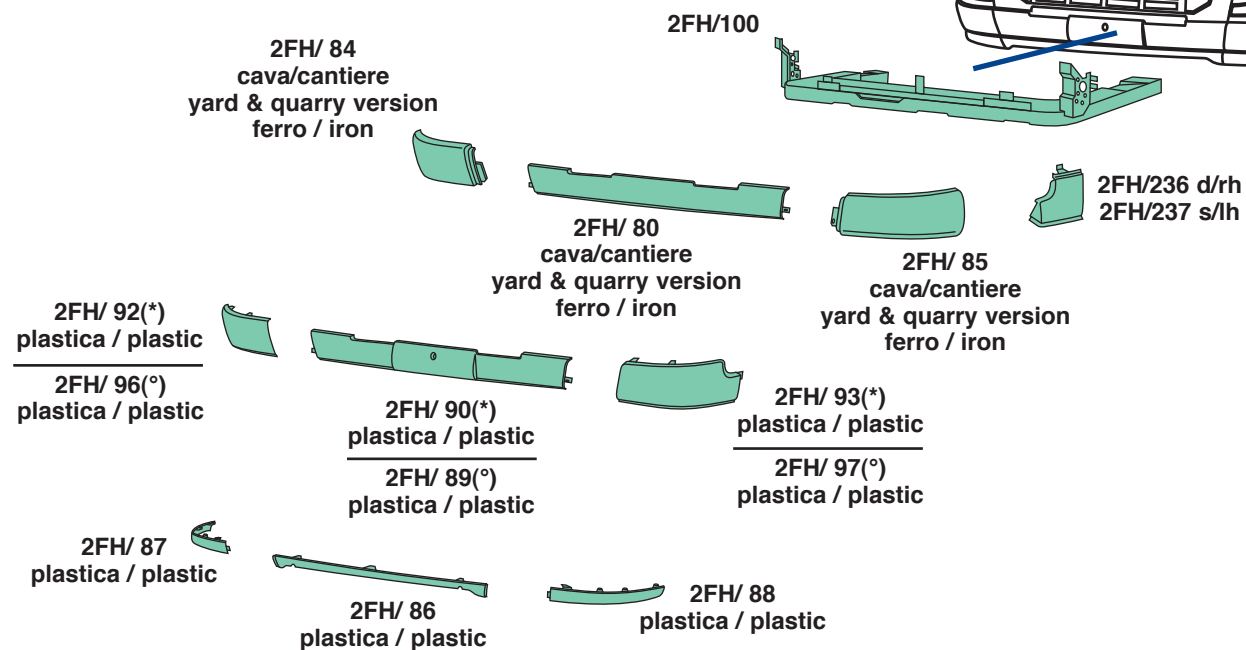

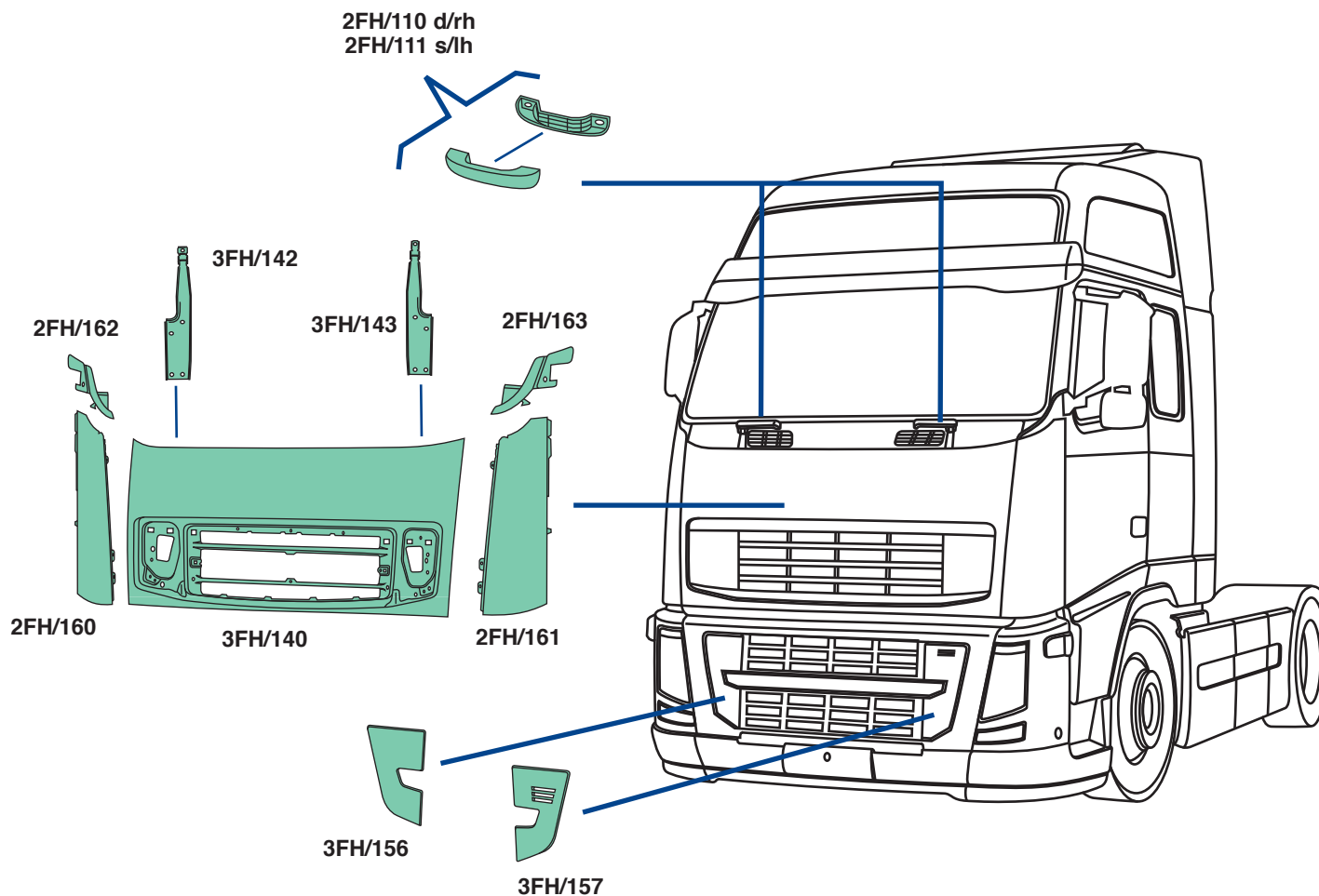

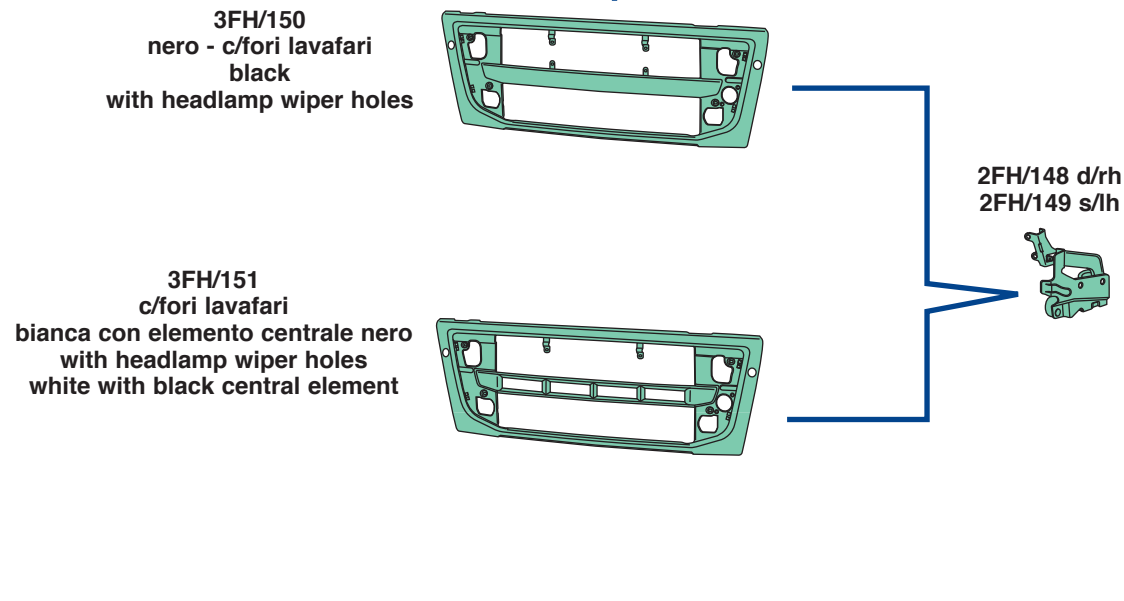
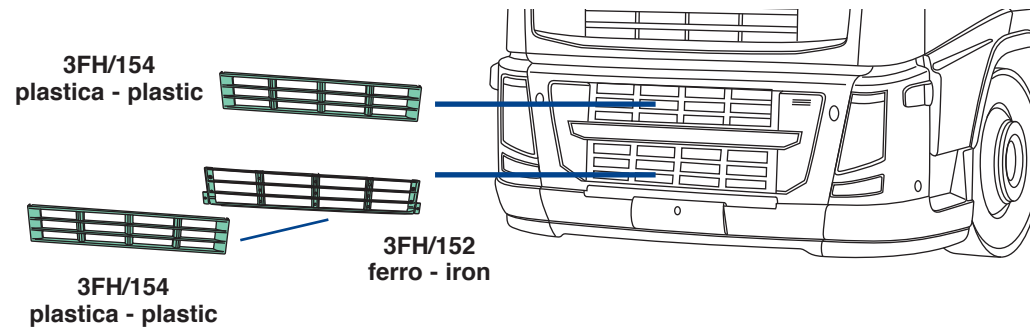

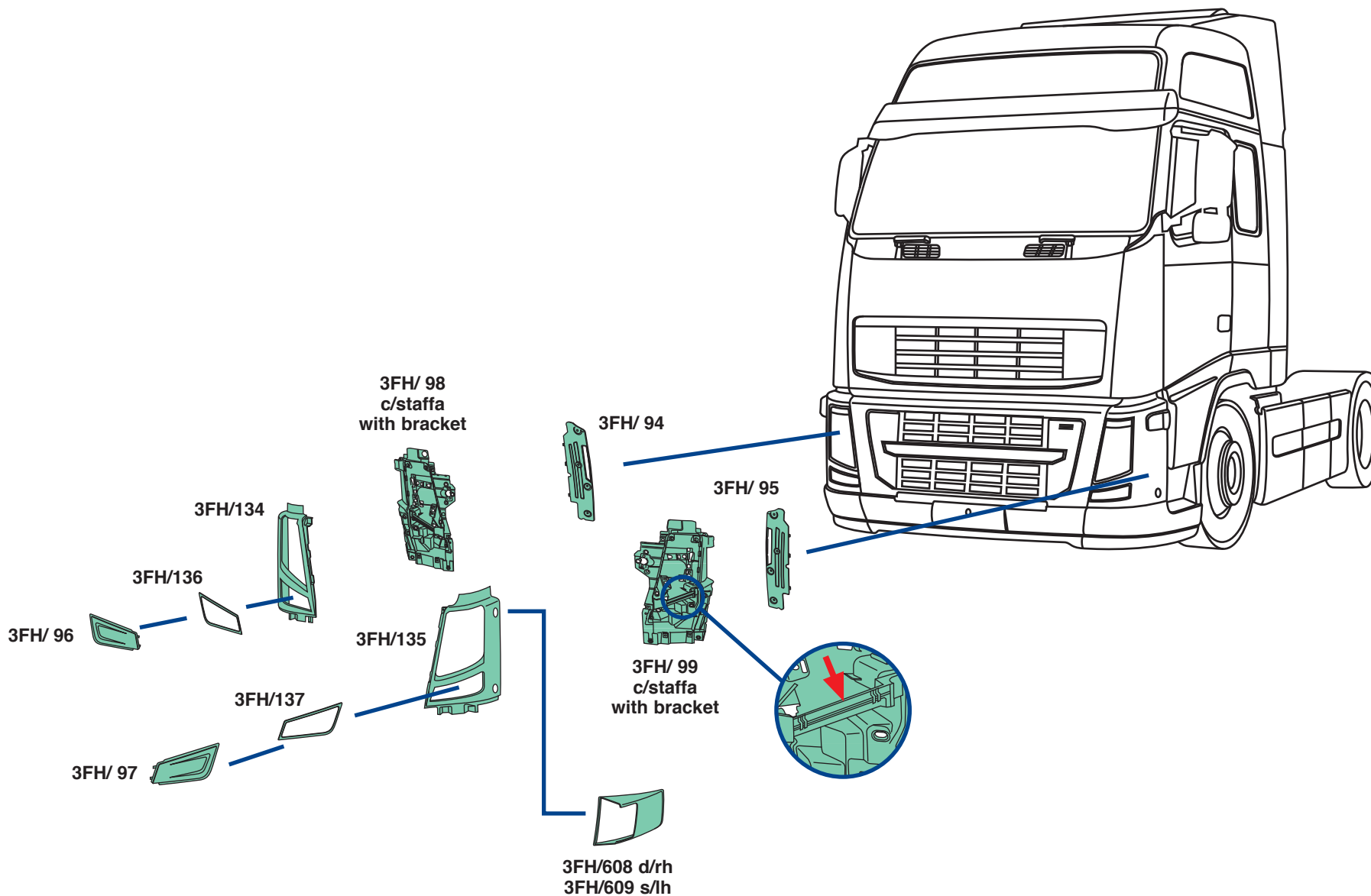

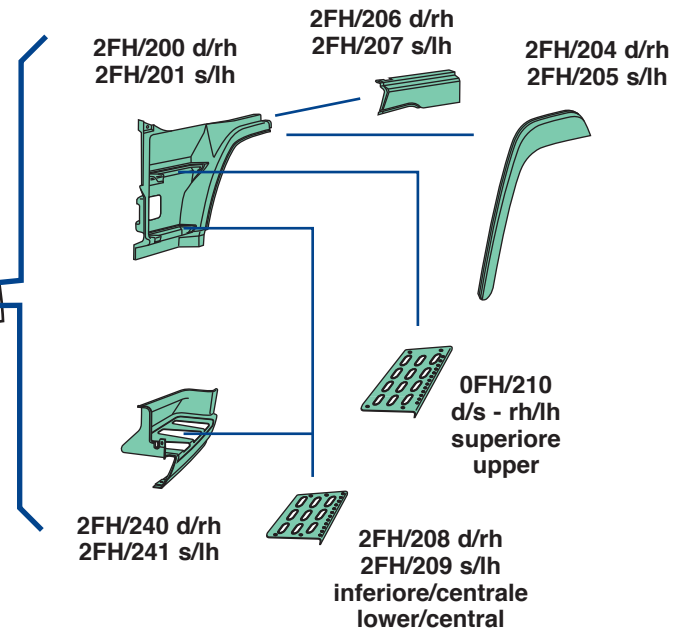
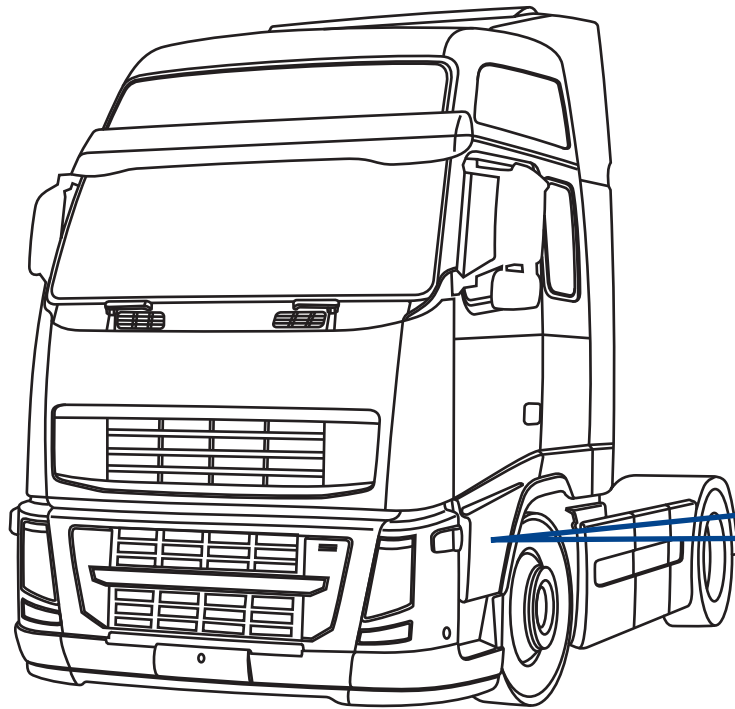

OFH/190

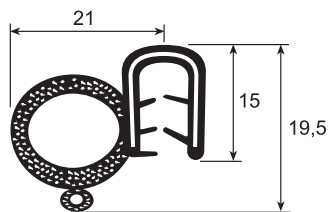

30

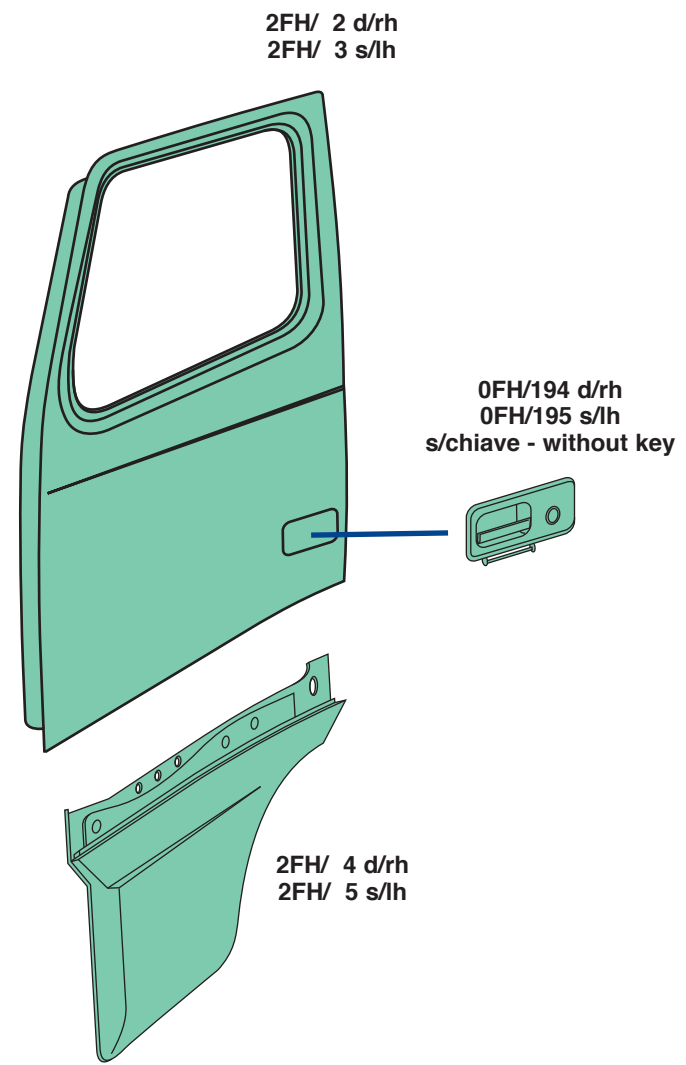
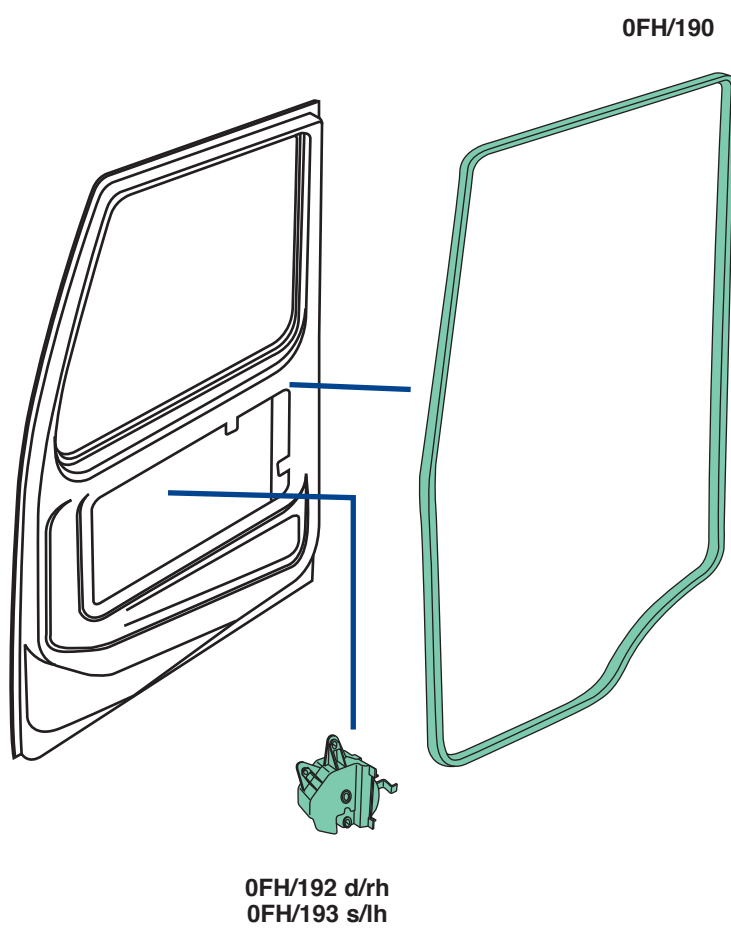

VOLVO FH13

terza serie 2008 - third series 2008

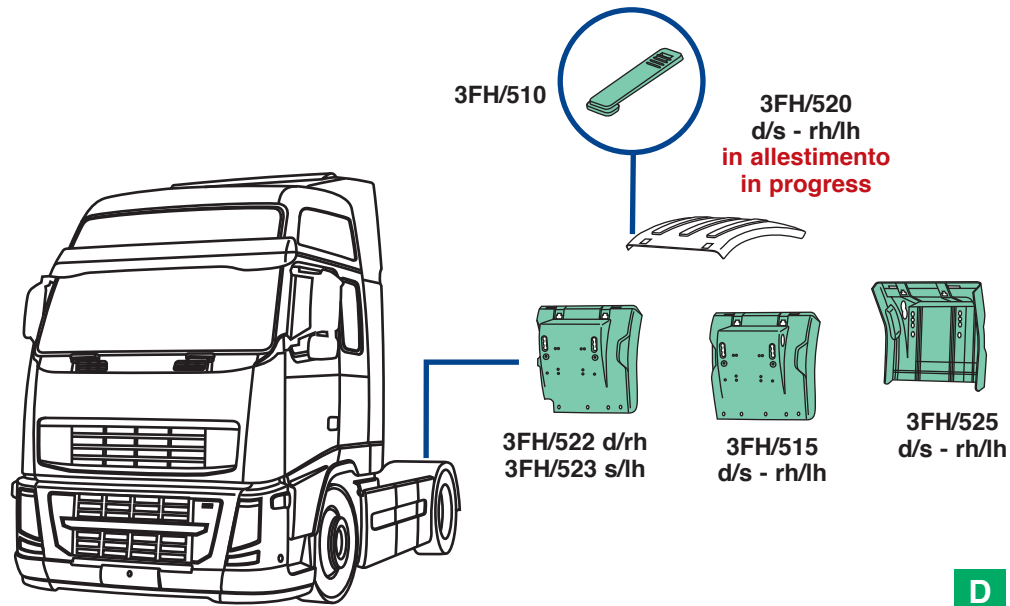

- con anti-spray/with anti-spray **A**
- senza anti-spray/without anti-spray **B**
- con cinghietti/with stretcher **C**
- senza cinghietti/without stretcher **D**

D

3FH/520
d/s - rh/lh

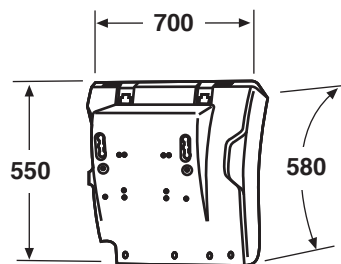
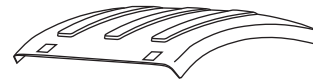

B

3FH/522 d/rh
3FH/523 s/lh

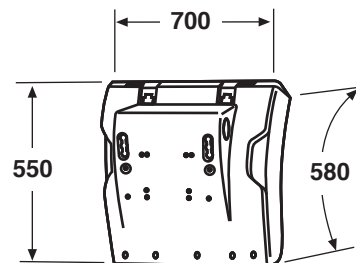

B

3FH/515
d/s - rh/lh

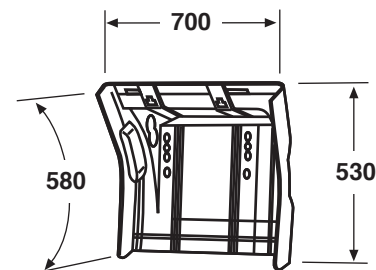

B

3FH/525
d/s - rh/lh

(*) Applicabile con il cinghietto 2FH/510 / Applied with stretcher 2FH/510
 (°) Applicabile con il cinghietto PRM/515 / Applied with stretcher PRM/515

- con anti-spray/with anti-spray **A**
- senza anti-spray/without anti-spray **B**
- con cinghietti/with stretcher **C**
- senza cinghietti/without stretcher **D**

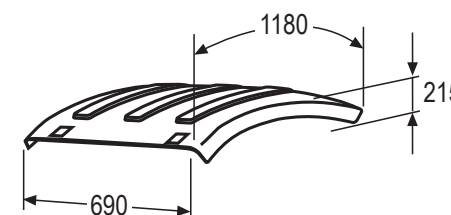
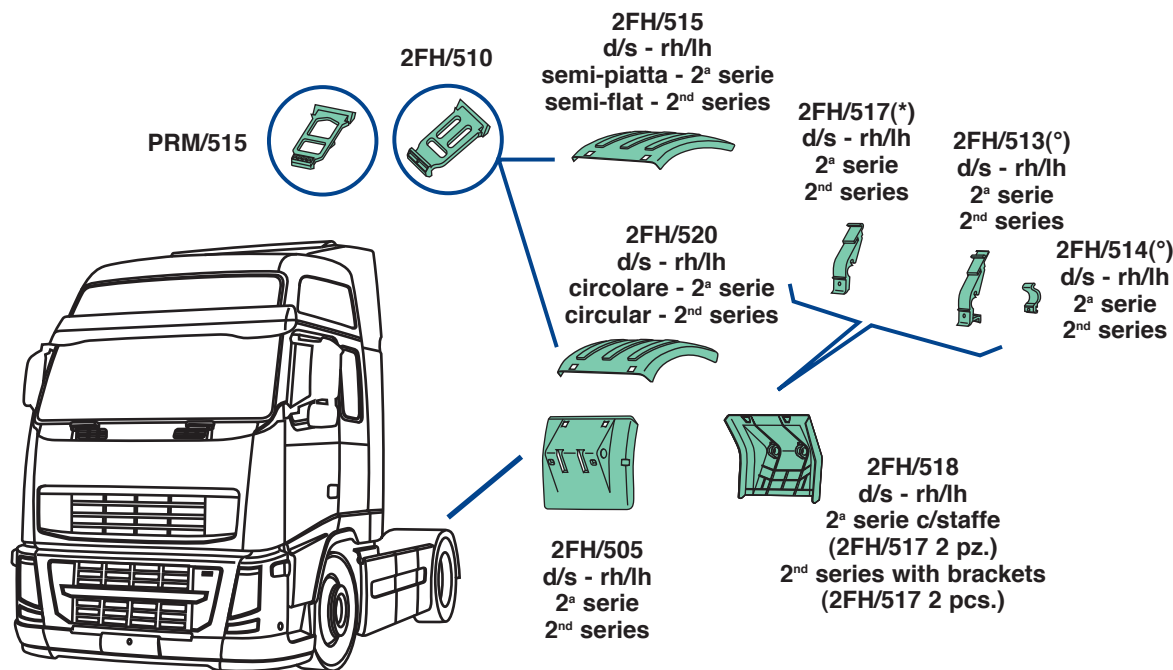

D
2FH/515
d/s-rh/lh

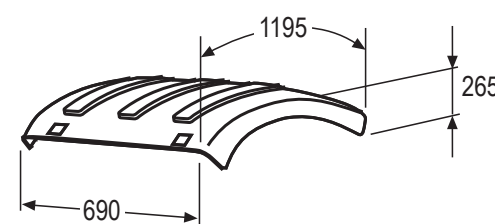

D
2FH/520
d/s-rh/lh

B
2FH/505
d/s-rh/lh

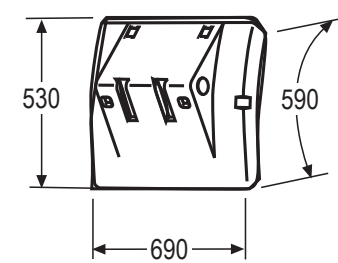

B
2FH/518
d/s-rh/lh

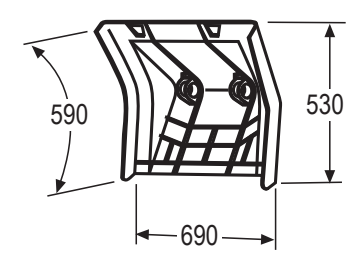

VOLVO

VOLVO FH12 - FH16
seconda serie - second series

33





▲ Esemplare dell'angolare portafaro per il veicolo Volvo (Codice Covind 0FH/135) - Model of the headlamp rim for the Volvo vehicle (Cod. Covind 0FH/135)

(*) Vernice di fondo
(*) Unprocessed

(°) Verniciato nero
(°) Black painted

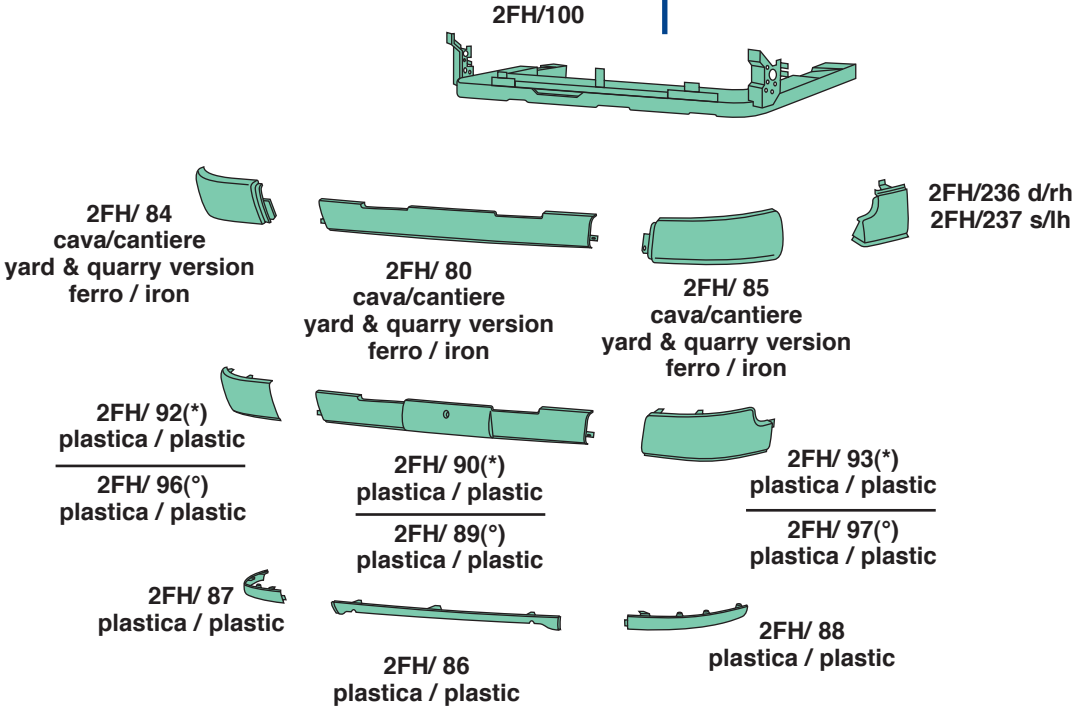
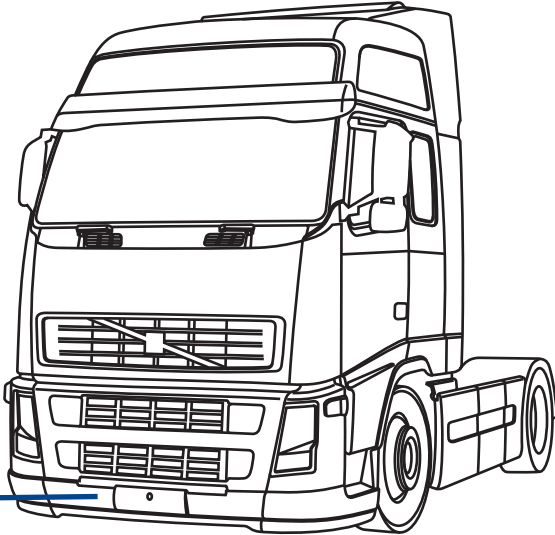

VOLVO FH12-FH16 seconda serie - second series

(*) >2007 singole - singles
2007> 2FH/152 + 2FH/153 (in coppia - a pair of)

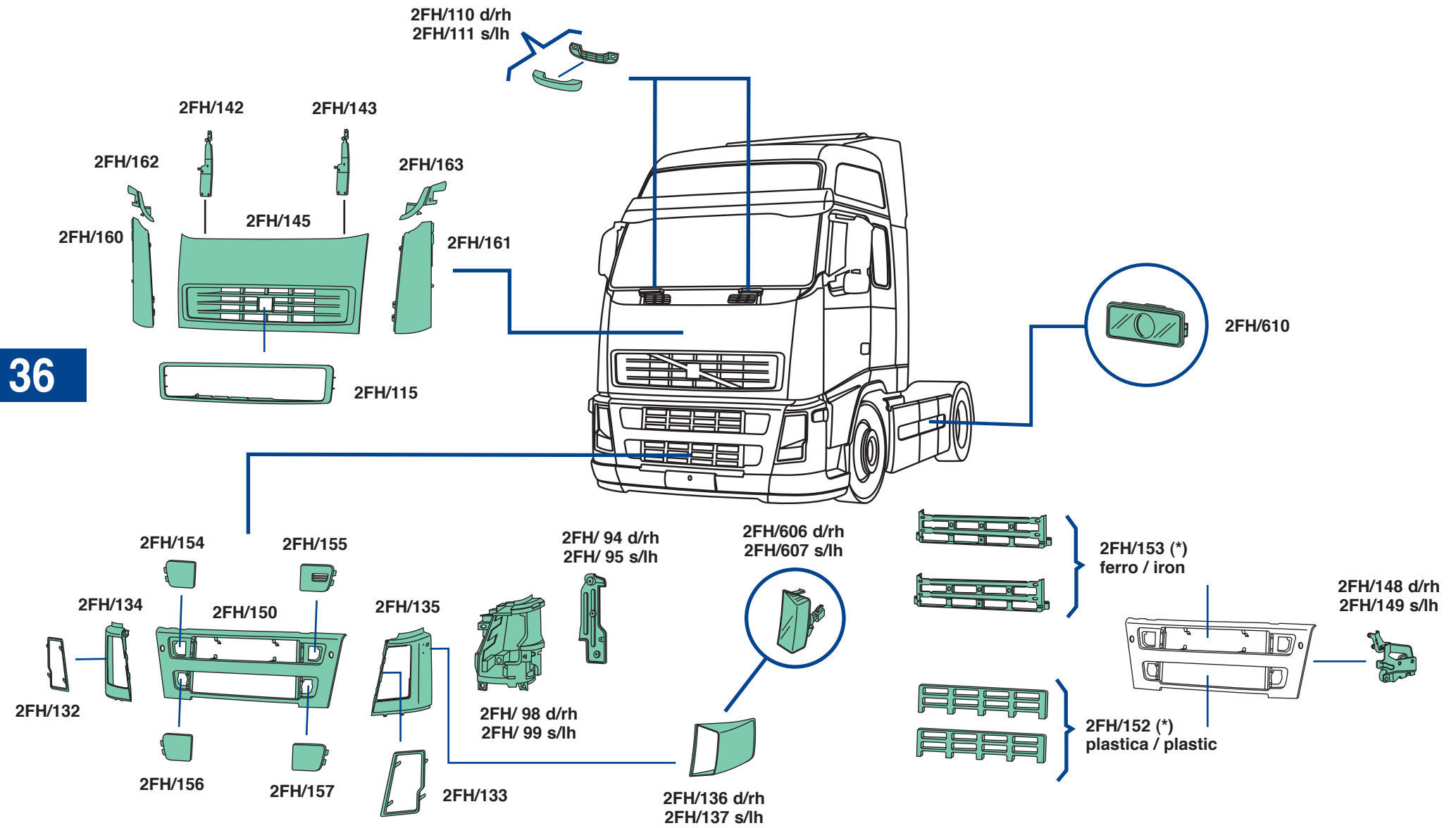

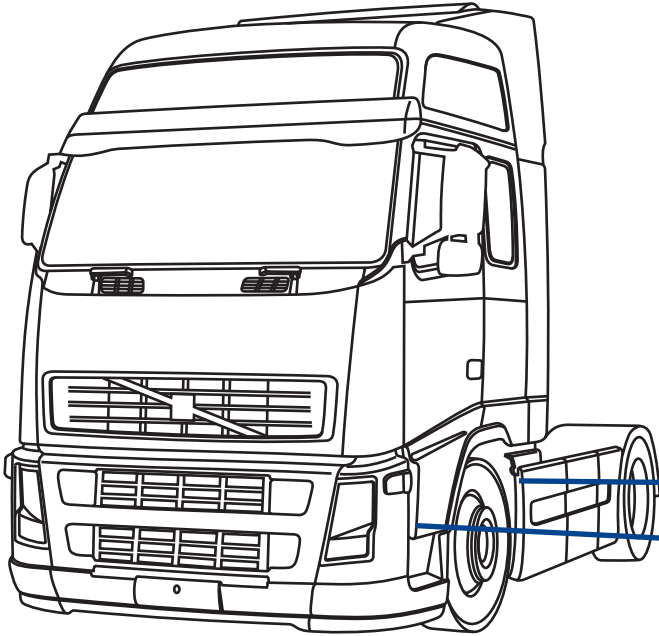

2FH/325
d/s - rh/lh

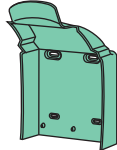

2FH/200 d/rh
2FH/201 s/lh

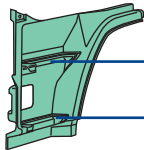

2FH/206 d/rh
2FH/207 s/lh

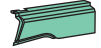

2FH/204 d/rh
2FH/205 s/lh

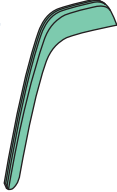

0FH/210
d/s - rh/lh
superiore
upper



2FH/240 d/rh
2FH/241 s/lh



2FH/208 d/rh
2FH/209 s/lh
inferiore/centrale
lower/central



0FH/190

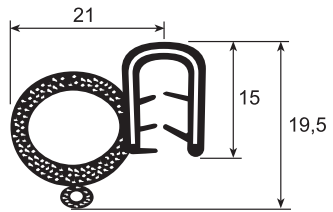

38

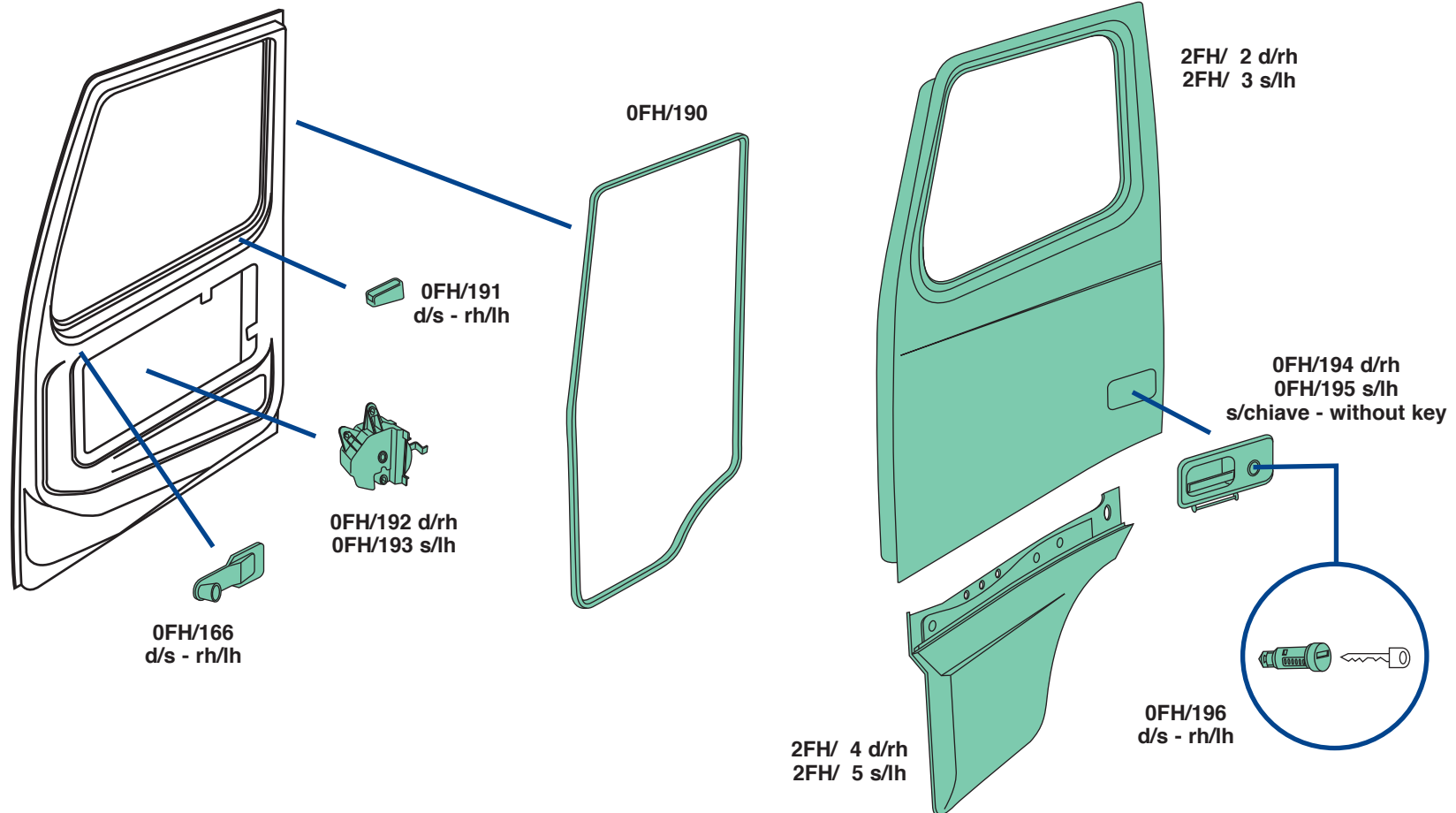

VOLVO FH12-FH16 seconda serie - second series

(*) Applicabile con il cinghietto 2FH/510 / Applied with stretcher 2FH/510

(°) Applicabile con il cinghietto PRM/515 / Applied with stretcher PRM/515

- con anti-spray/with anti-spray **A**
- senza anti-spray/without anti-spray **B**
- con cinghietti/with stretcher **C**
- senza cinghietti/without stretcher **D**

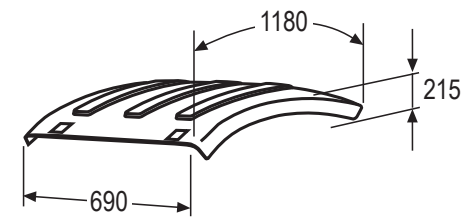
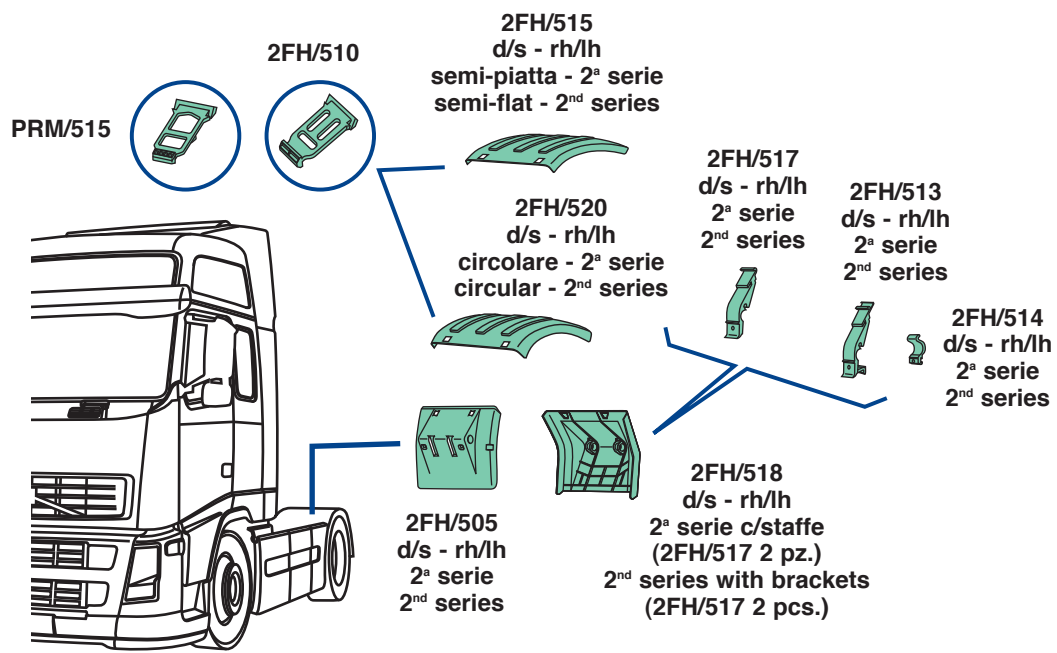

D
2FH/515
d/s-rh/lh

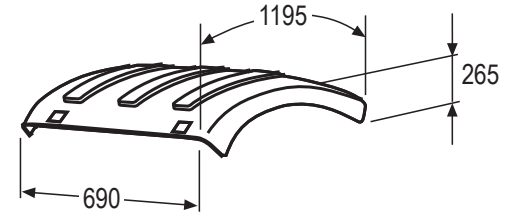

D
2FH/520
d/s-rh/lh

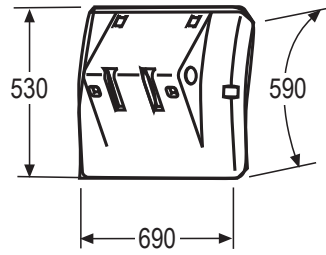

B
2FH/505
d/s-rh/lh

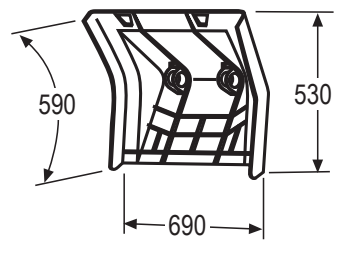

B
2FH/518
d/s-rh/lh

0FH/670

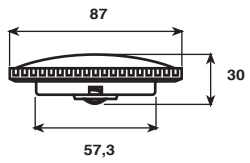

0FH/670
senza chiave
without key

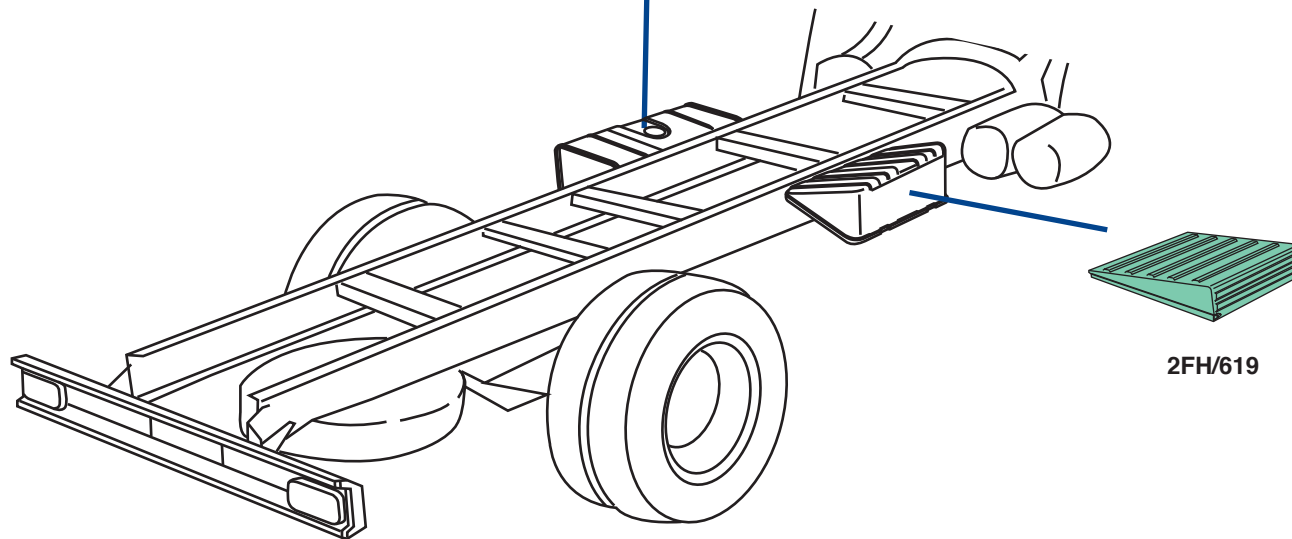
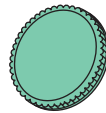

VOLVO

VOLVO FH12-FH16
prima serie - first series



41

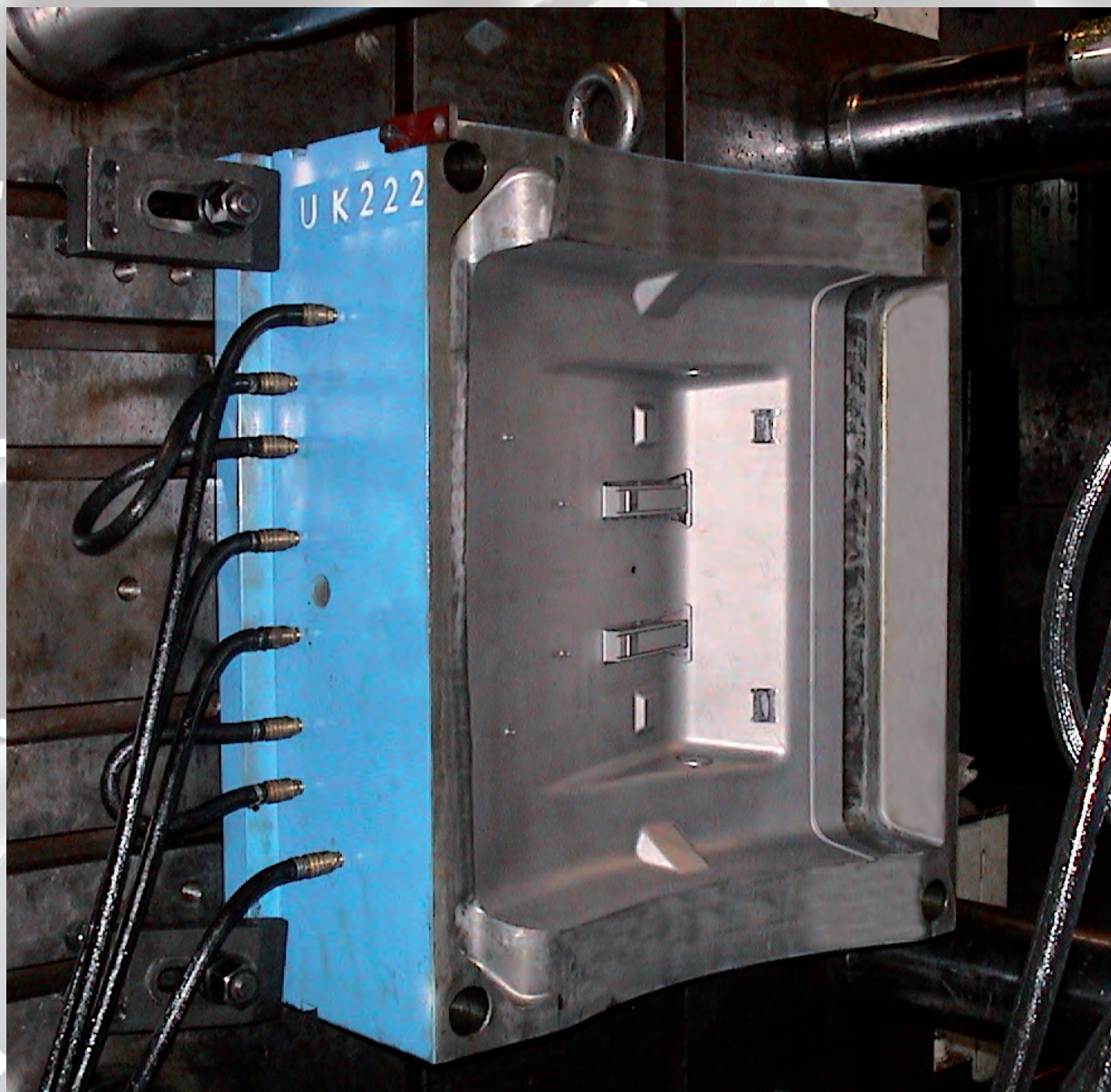

▲ Stampo a iniezione per la produzione del parafrangente posteriore del veicolo Volvo (Cod. Covind 2FH/518) - Injection mould for the production of the rear mudguard for the Volvo vehicles (Cod. Covind 2FH/518)

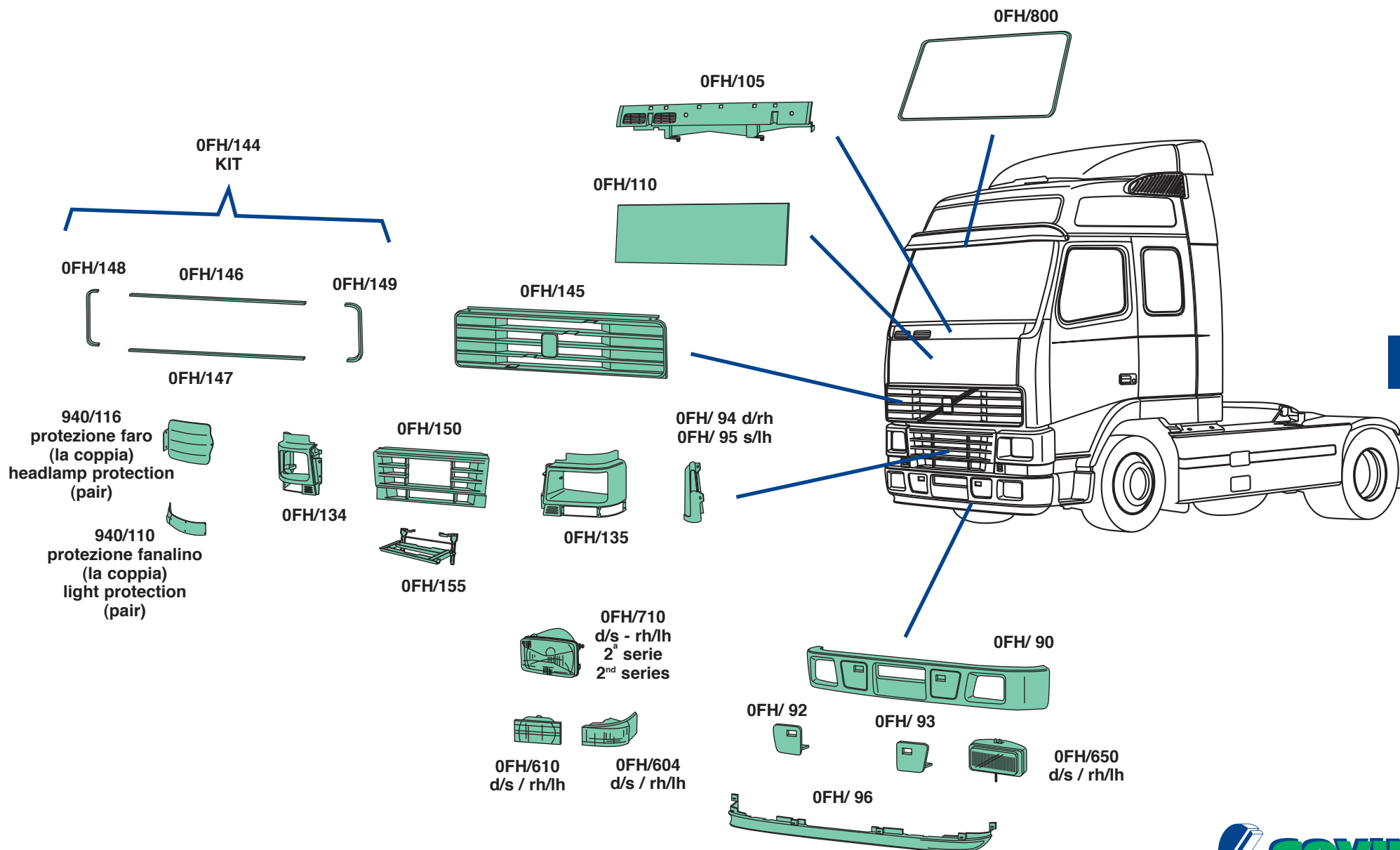

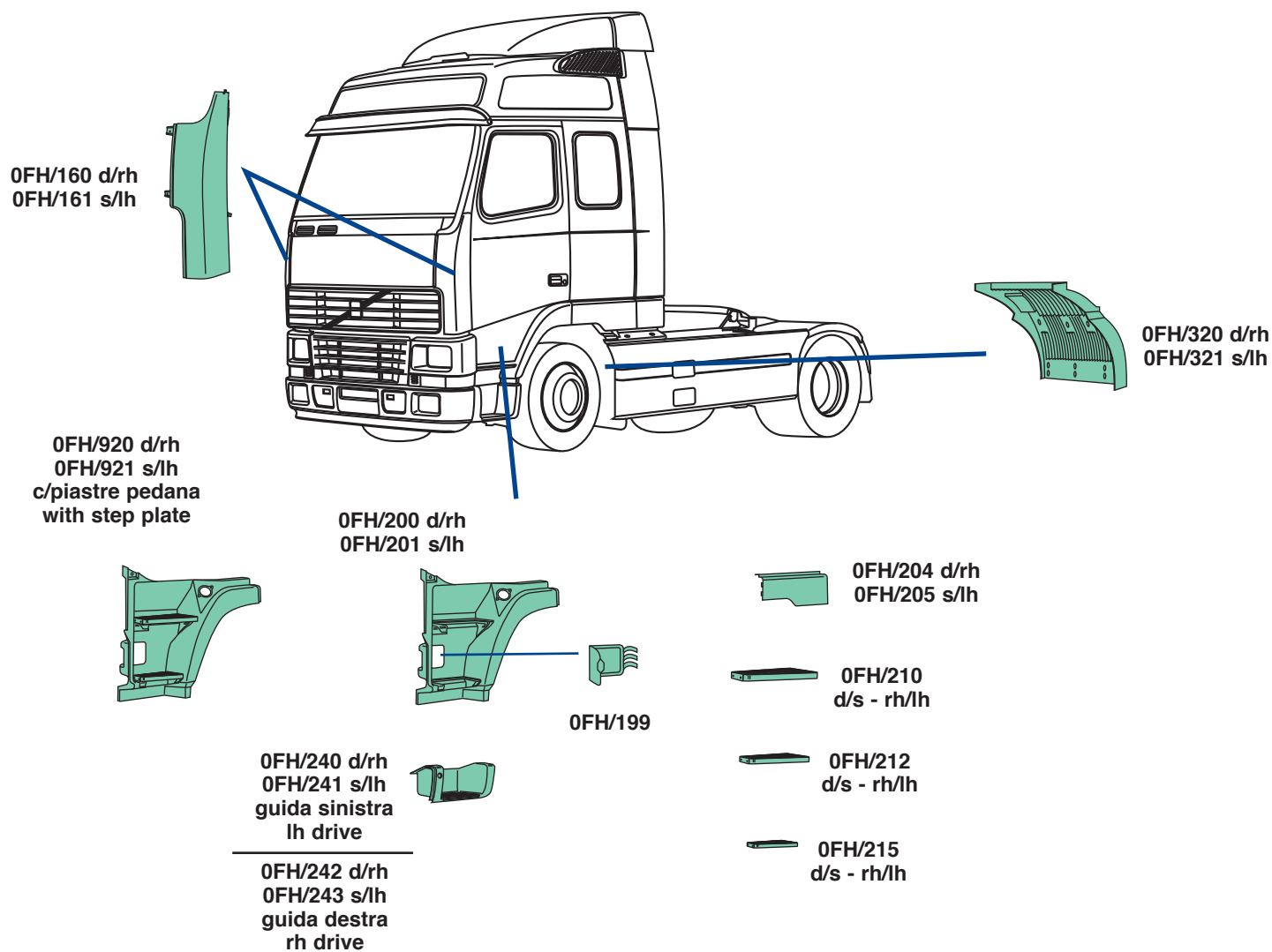

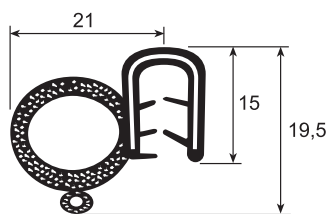

0FH/190

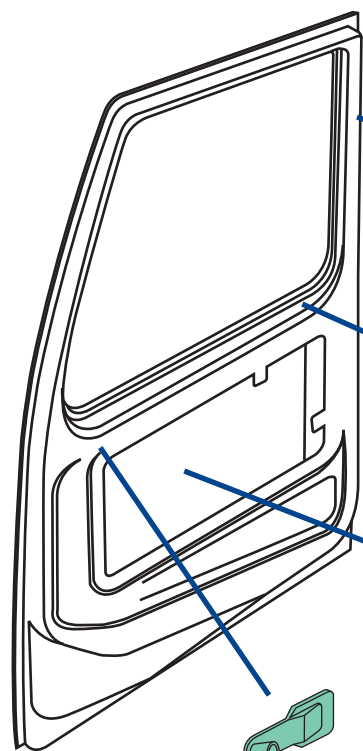

0FH/191
d/s - rh/lh



0FH/192 d/rh
0FH/193 s/lh



0FH/166
d/s - rh/lh

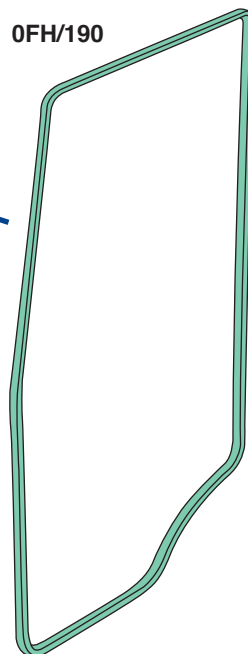

0FH/190

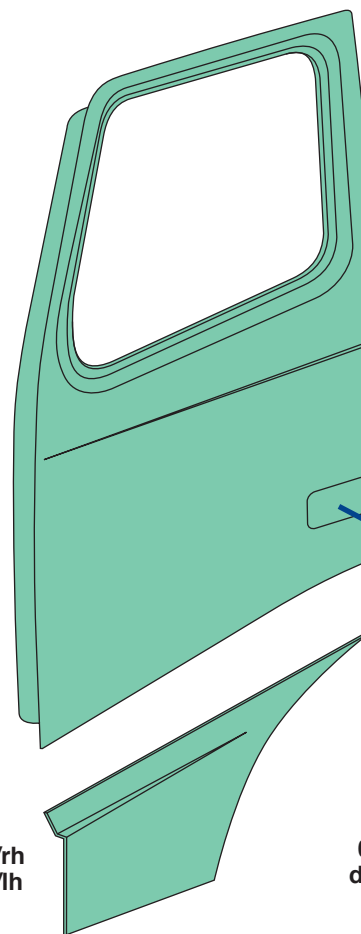

2FH/ 2 d/rh
2FH/ 3 s/lh

0FH/194 d/rh
0FH/195 s/lh
s/chiave - without key



0FH/ 4 d/rh
0FH/ 5 s/lh

0FH/196
d/s - rh/lh

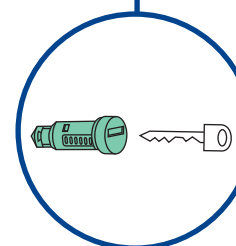

VOLVO FH12-FH16 prima serie - first series

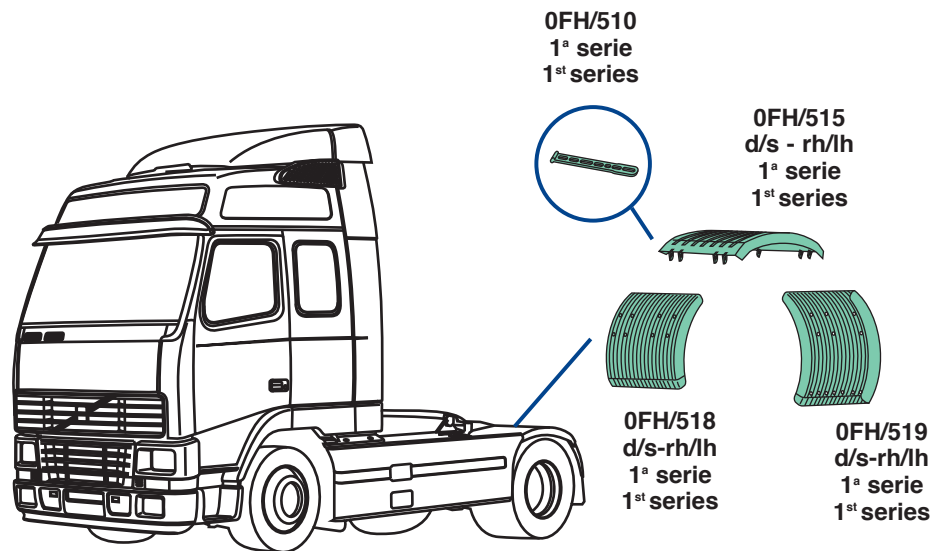

con anti-spray/with anti-spray **A**

senza anti-spray/without anti-spray **B**

con cinghietti/with stretcher **C**

senza cinghietti/without stretcher **D**

46

C

0FH/515
d/s-rh/lh

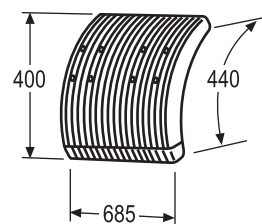
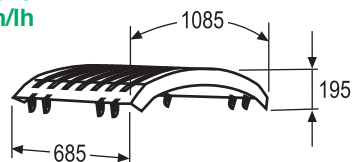

B

0FH/518
d/s-rh/lh

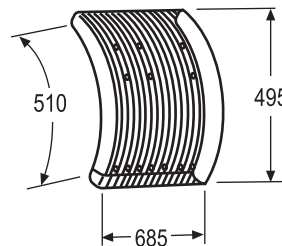

B

0FH/519
d/s-rh/lh

VOLVO FH12-FH16 prima serie - first series

(*) Applicabile con il cinghietto 2FH/510 / Applied with stretcher 2FH/510

(°) Applicabile con il cinghietto PRM/515 / Applied with stretcher PRM/515

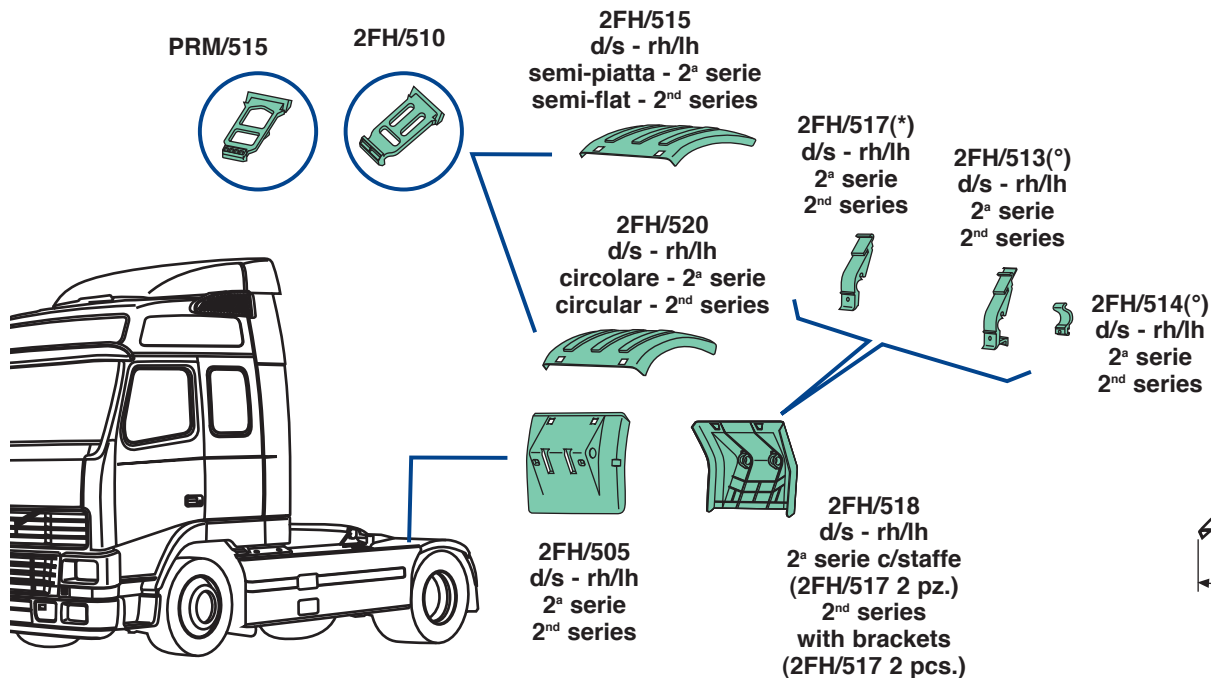

- con anti-spray/with anti-spray **A**
- senza anti-spray/without anti-spray **B**
- con cinghietti/with stretcher **C**
- senza cinghietti/without stretcher **D**

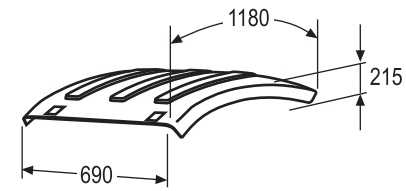

D
2FH/515
d/s-rh/lh

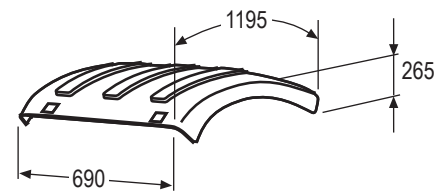

D
2FH/520
d/s-rh/lh

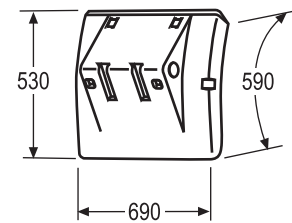

B
2FH/505
d/s-rh/lh

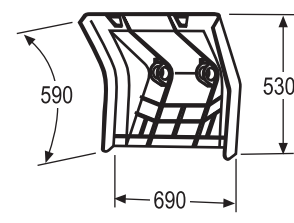

B
2FH/518
d/s-rh/lh

0FH/670

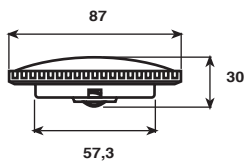

0FH/670
senza chiave
without key

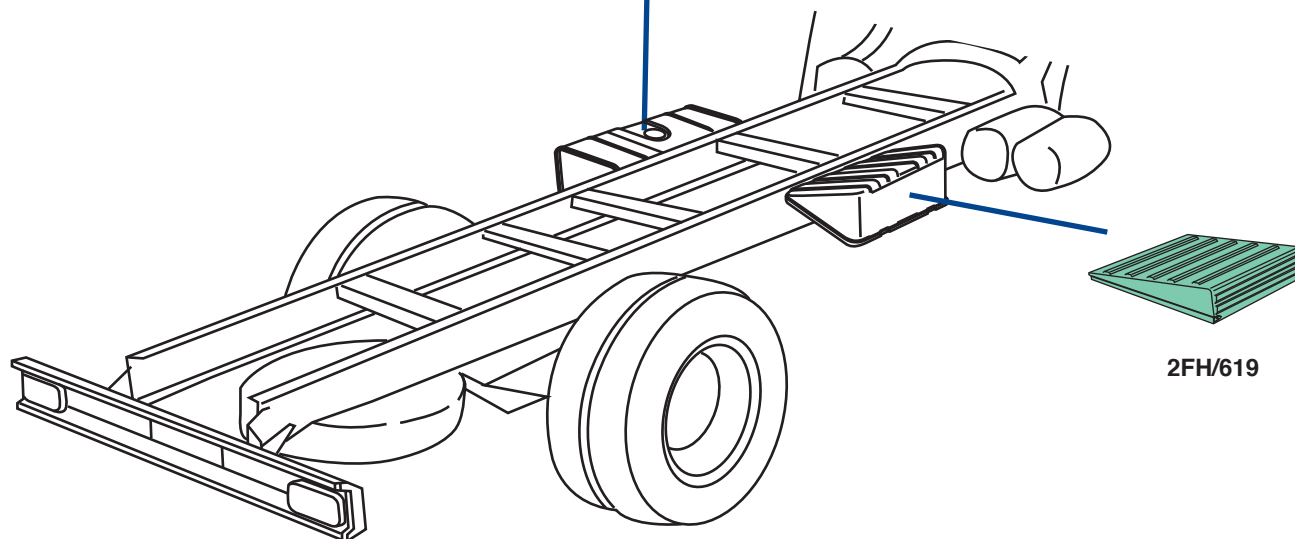
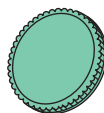

2FH/619

VOLVO

VOLVO F12



49

0FH/670

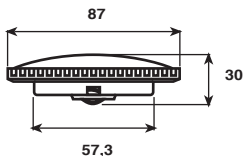

50

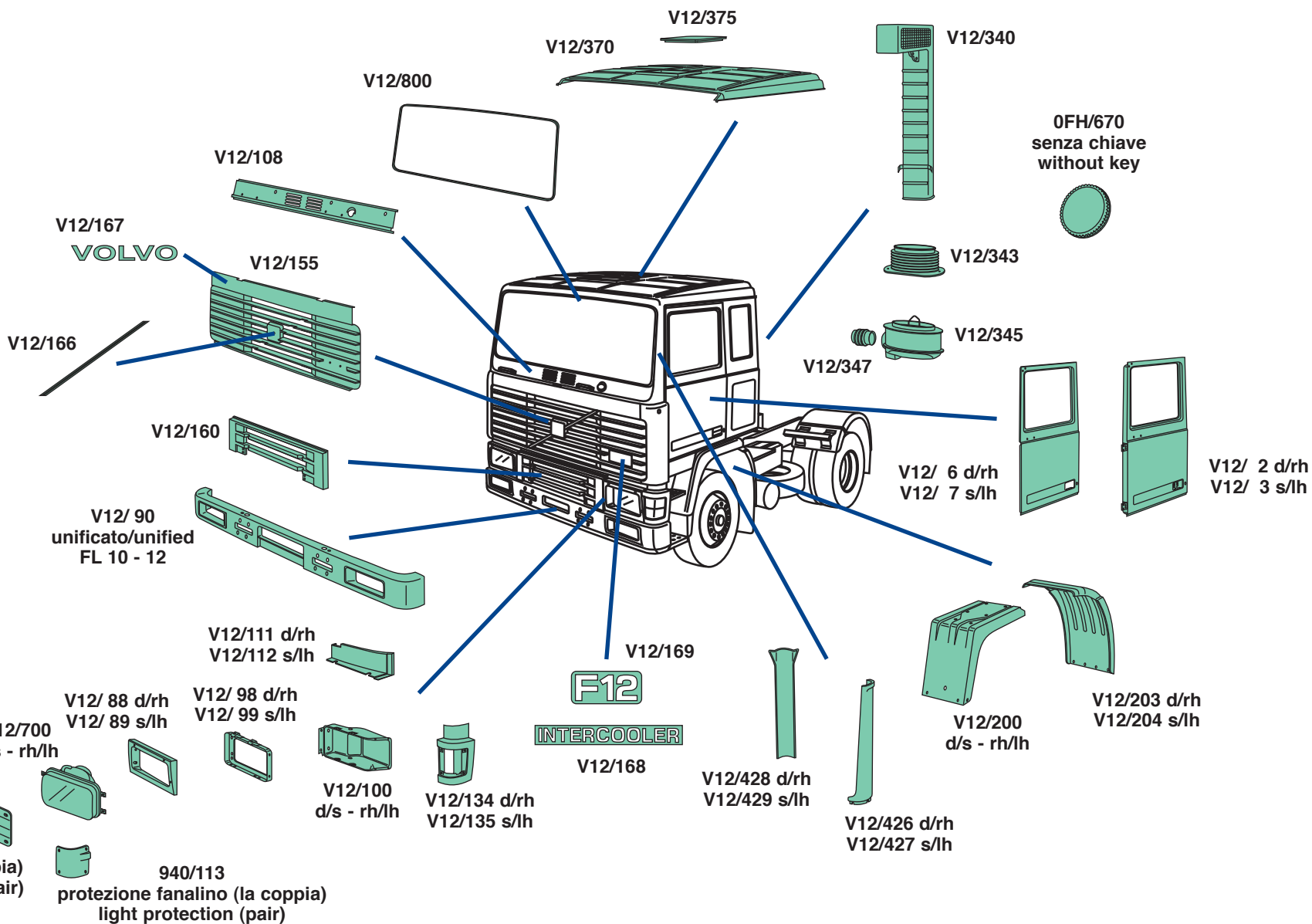

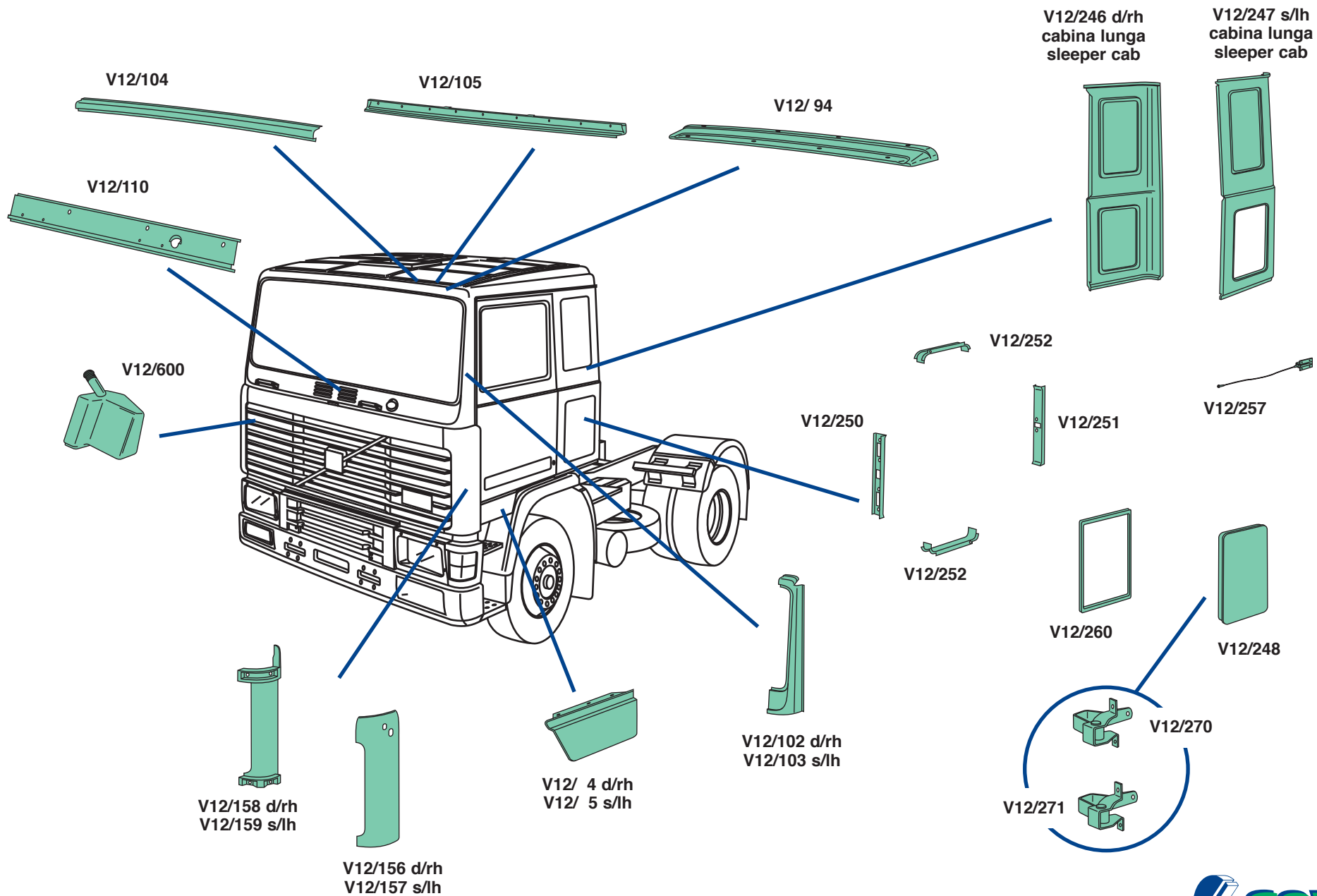

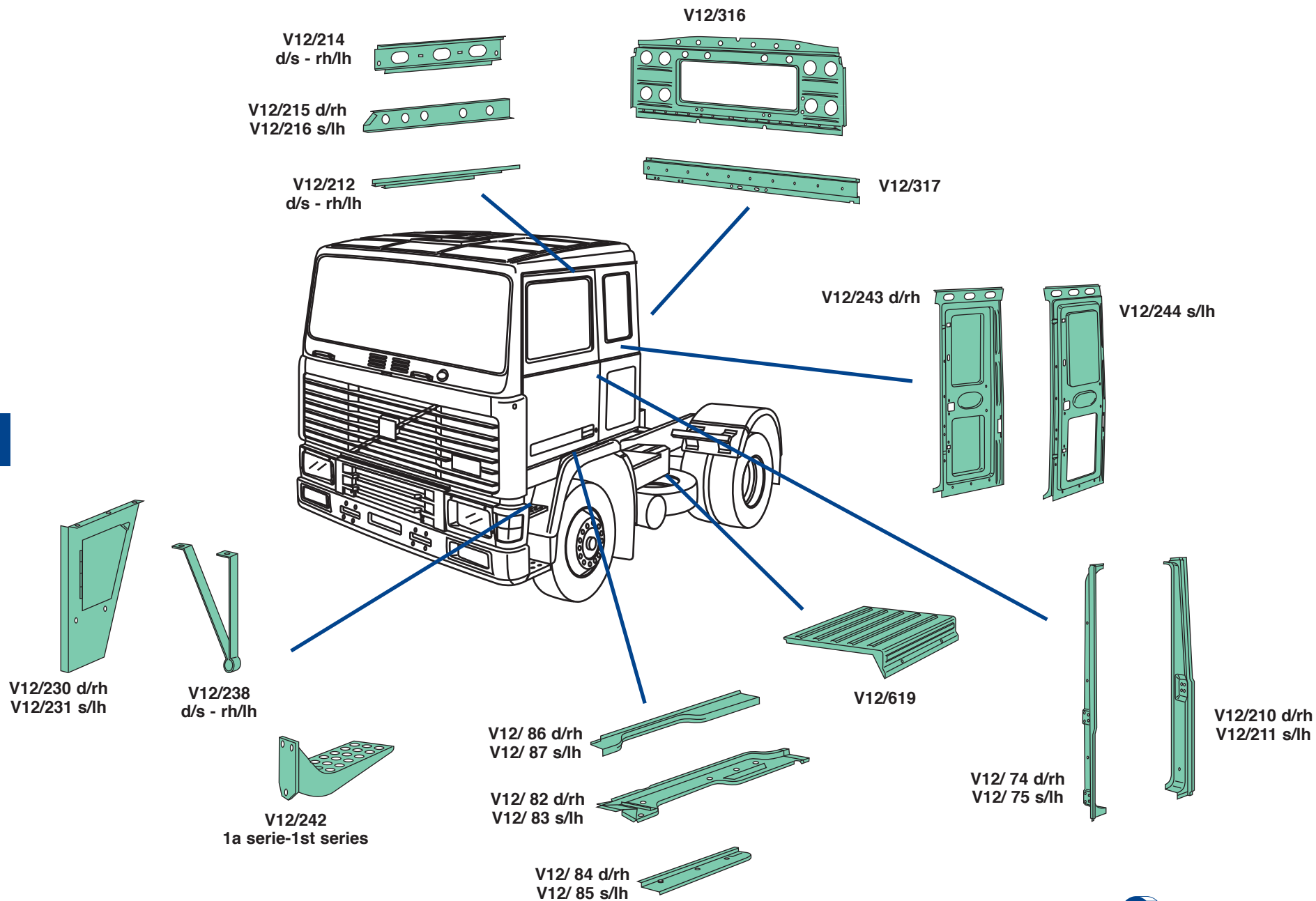

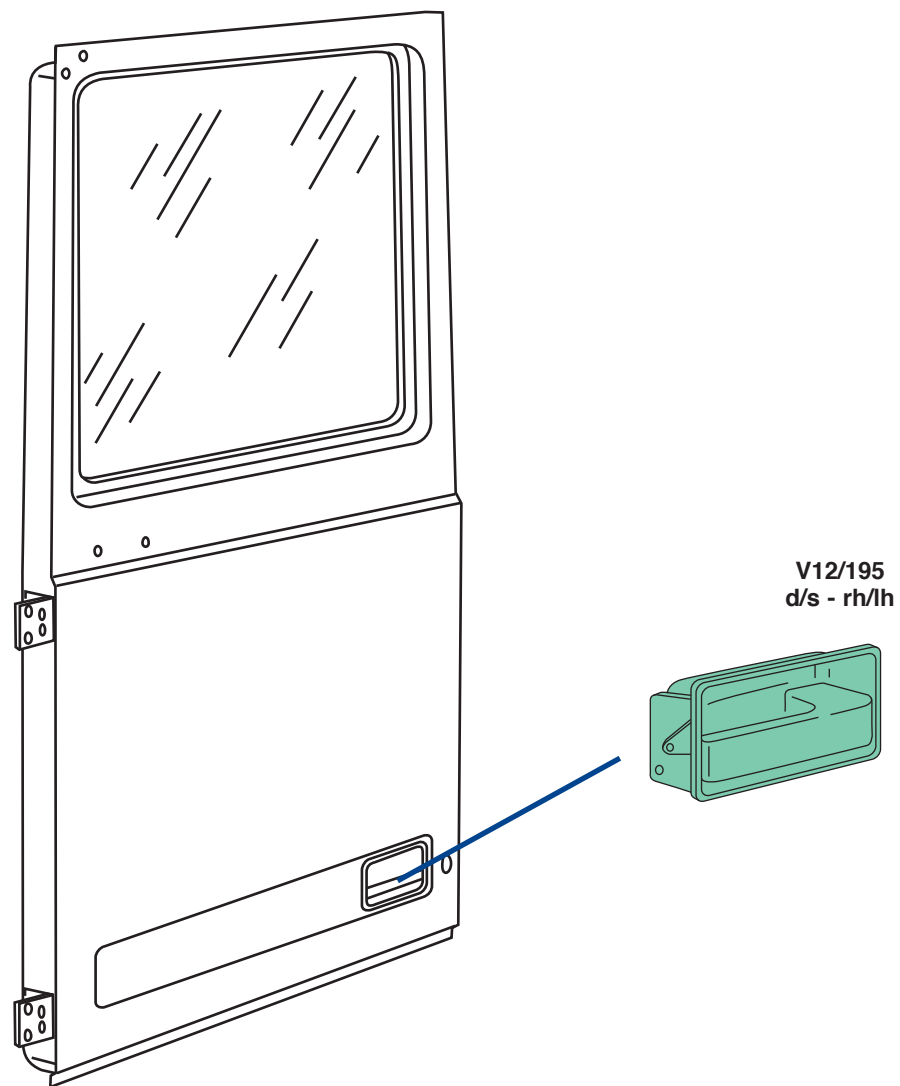

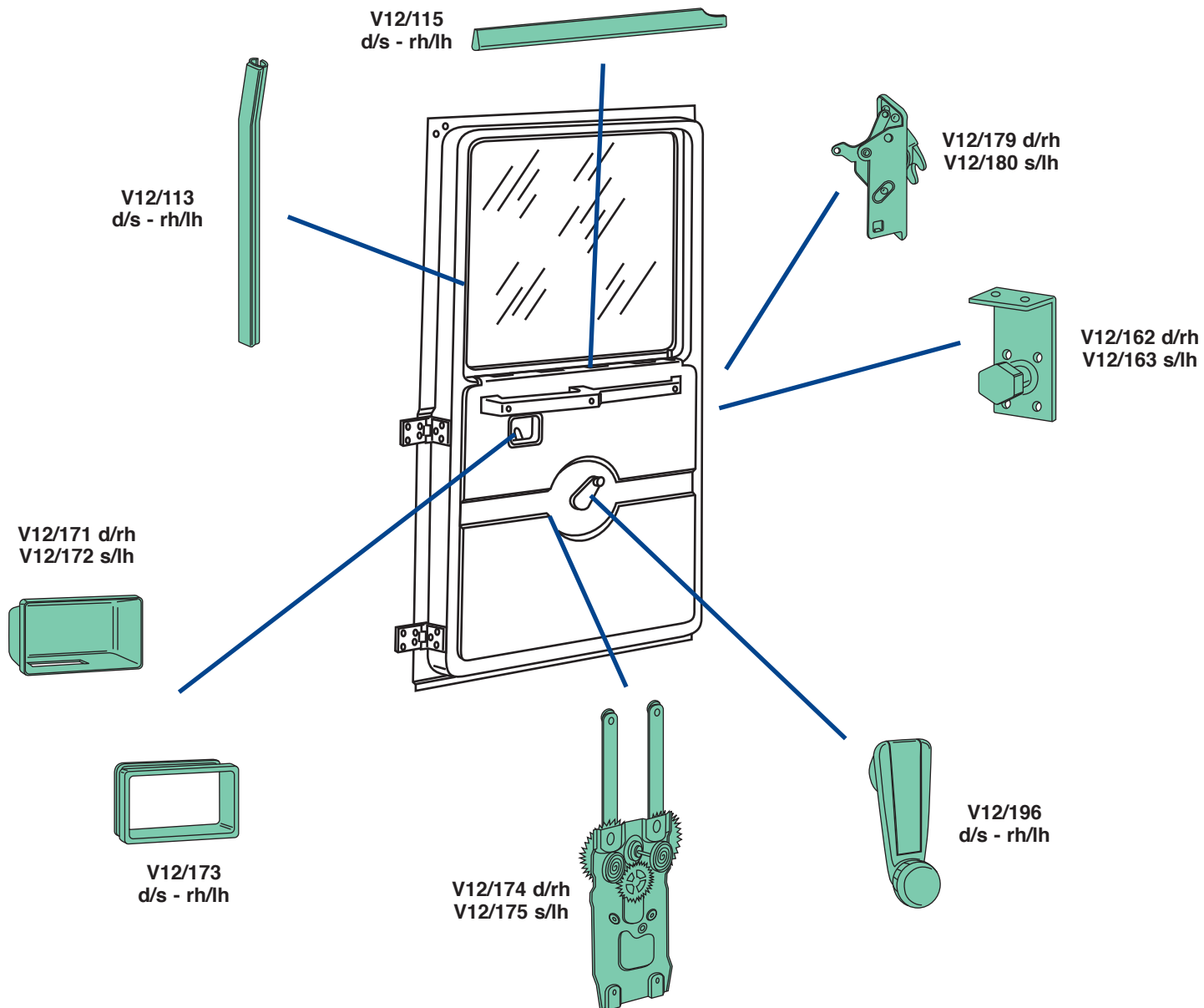

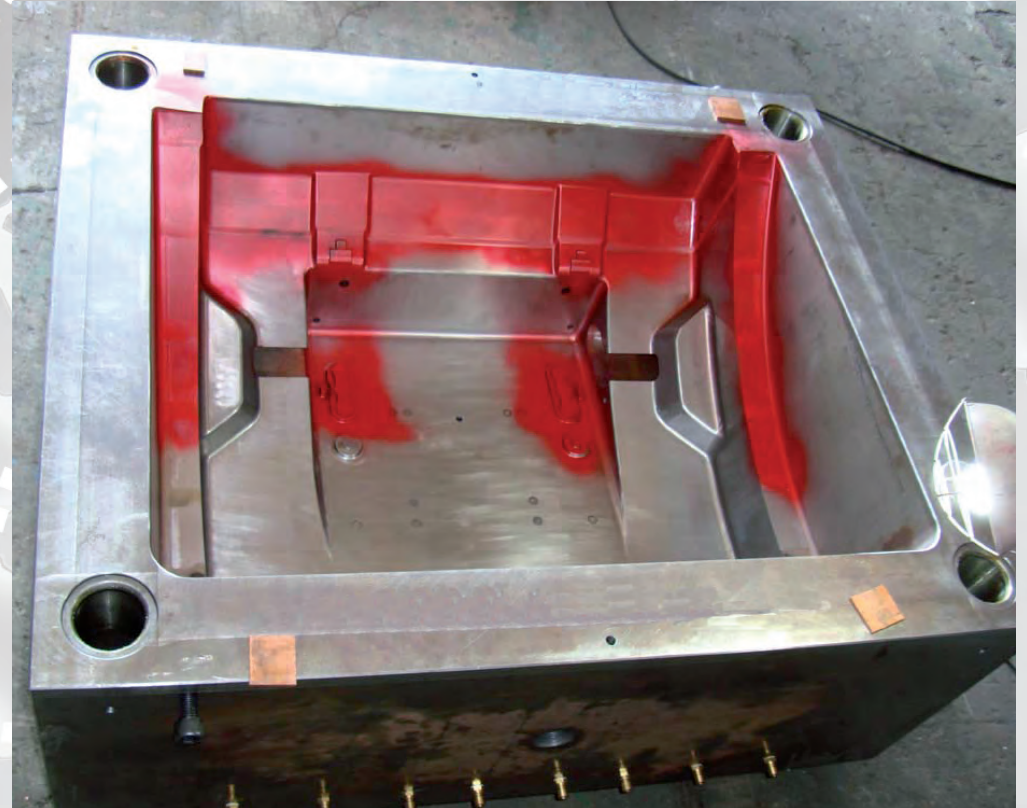
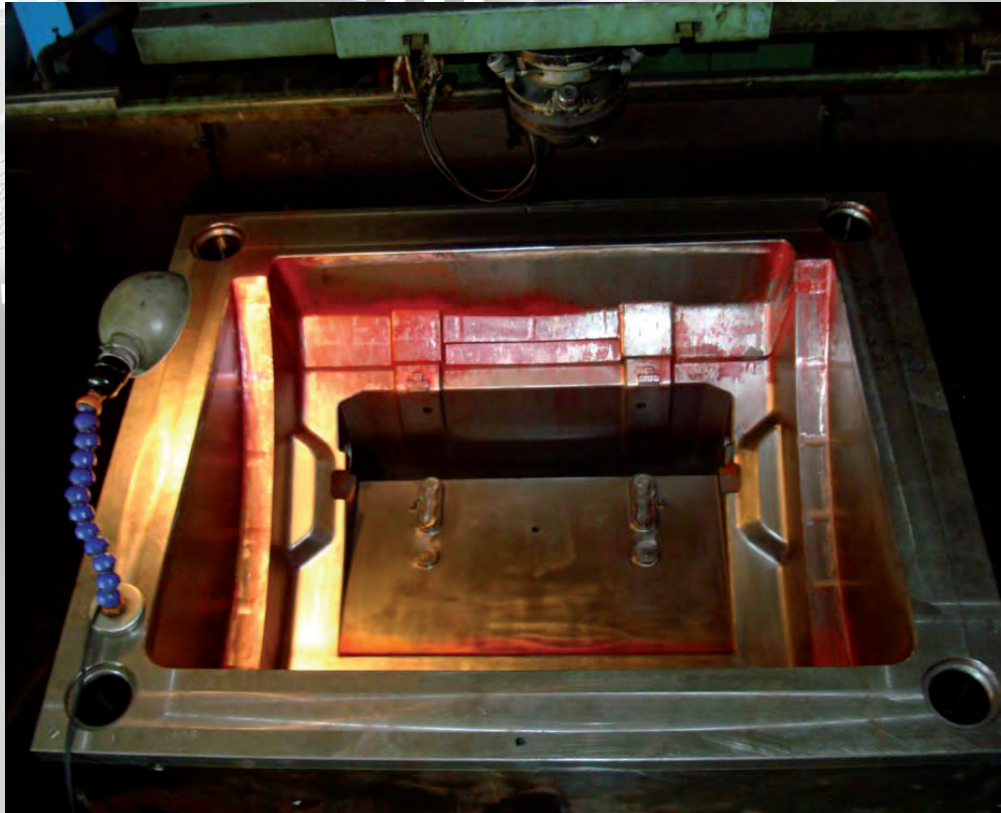

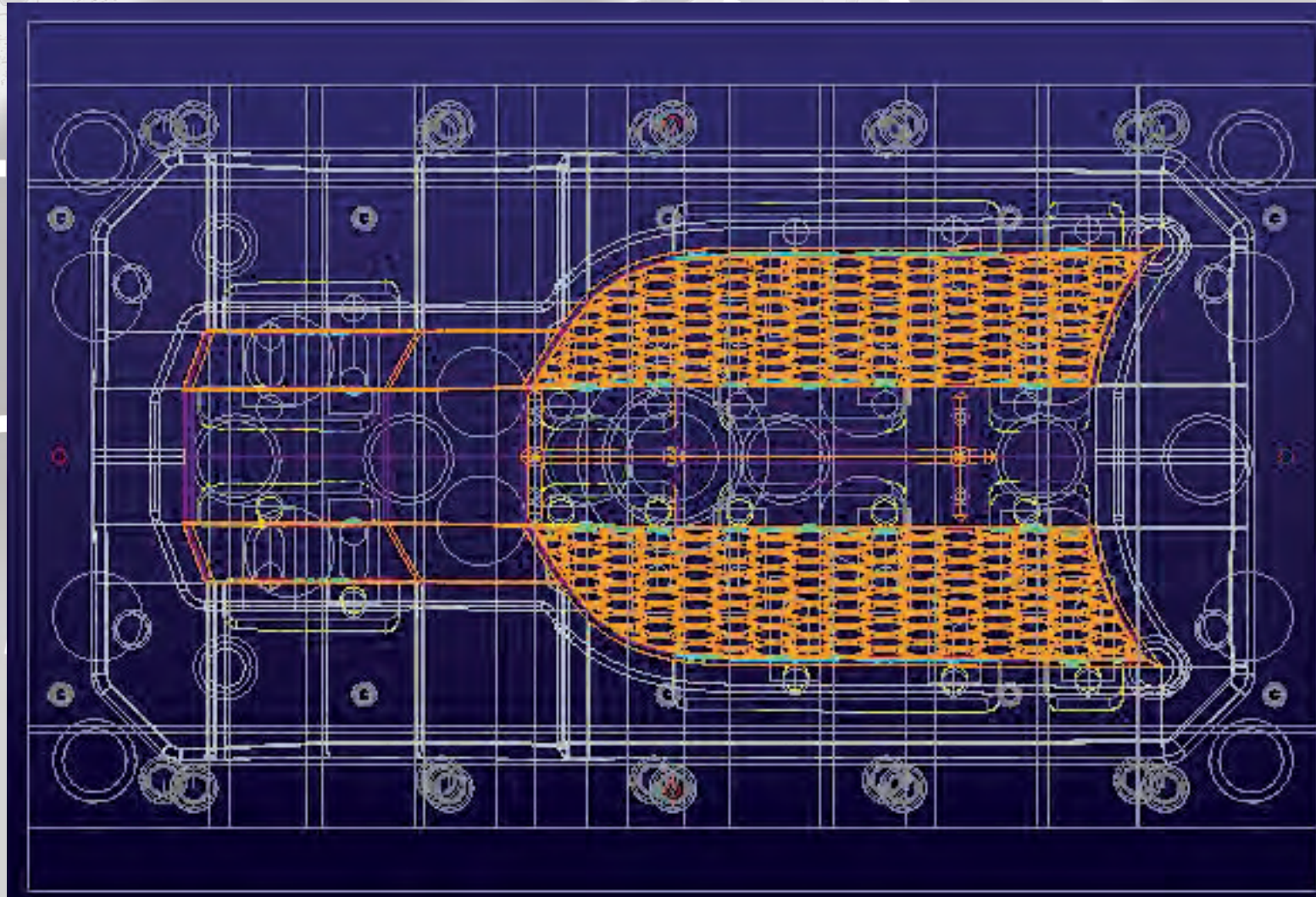

▲ IT Stampo per lo stampaggio ad iniezione del semiparafango posteriore per il Volvo
UK Mold finishing process





IT Progetto in 3D dello stampo ad iniezione per la produzione di griglie
UK Numerical control milling machine working on a mold for bumper

COVIND SPA

SERVIZIO VENDITE ITALIA DOMESTIC SALES OPT.

 . +39 011 8965702

 . +39 011 8965714

 . +39 011 8965719

 . +39 011 8965723

 . +39 011 8965756

E.MAIL vendite@covind.it

SERVIZIO VENDITE ESTERO INTERNATIONAL SALES OPT.

 . +39 011 8965713

 . +39 011 8965716

 . +39 011 8965736

 . +39 011 8965738

 . +39 011 8965739

 . +39 011 8965744

 . +39 011 8005149

E.MAIL export@covind.it



COVIND S.P.A.

Strada della Cebrosa, 68-70-72
10036 Settimo Torinese (TO) - ITALY

☎ . +39 011 8965711

☎ . +39 011 8977830

✉ marketing@covind.it

www.covind.it



MOD2VOL09

