

Scania

Alternative and interchangeable
spare parts

cosibo



For Scania A totally reliable range of alternative and interchangeable spare parts

Cosibo guarantee the high quality of their products.

A staff of mechanical engineers, studies, analyses and "re-designs" original spare parts. It is a very delicate stage, because in order to guarantee to **Cosibo** products the same characteristics of original spare parts, it is necessary to have great mastery of the employed technologies and a perfect knowledge of the characteristics of the materials to be used. After this stage, another fundamental step is related to the identification of the many companies and contractors to which **Cosibo** commissions the realisation of its large range of products.

Cosibo strength and quality are witnessed by the several partnership co-operations in force between the Company and some of the most qualified producers in different sectors: mechanic, electronic, plastic materials moulding, oil hydraulic, electric and all the others specialised in the production of spare parts.

According to the company philosophy, **Cosibo** has with all these companies well established and clear co-operations with the consequence that they can offer not only high quality products but also short lead-times while respecting the agreed delivery dates. The aim is to offer reliable and efficient answers to any single customer all over the world.

This catalogue shows the whole range of spare parts for **Scania** trucks.

A very rich range to guarantee the availability of the spare parts for the various components of the vehicle:

Engine · Clutch · Speed gear · Propeller shaft · Front axle · Differential gear · Rear axle · Hubs and wheels

Braking system · Suspension · Steering · Engine bonnet · Electric unit · Cab · Lights · Mirrors · Body parts

Accessories

NOTES

IMPORTANT

- All the components listed in our catalogue are not original, though perfectly interchangeable.
- Reference numbers, either original or of a different nature, are for information purposes only. When placing an order, please, always use Cosibo reference numbers and do not mention the original reference of the truck manufactures in the invoice to vehicle owners or to anybody else.
- If the customer does not apply with what above he takes all his own responsibilities.

LEGEND

- All the spare parts in this catalogue are divided into **Groups** on the basis of the part of the truck they are destined to.
- Each **Group** is identified by a letter from the alphabet as it follows:

A	ENGINE
B	CLUTCH
C	SPEED GEAR
D	PROPELLER SHAFT
E	FRONT AXLE
F	REAR AXLE
G	HUBS AND WHEELS
H	BRAKING SYSTEM
I	MIRRORS BODY PARTS AND ELECTRIC MATERIAL
J	CAB
L	SUSPENSION
M	STEERING
N	LIGHTS AND ELECTRIC UNIT
O	ACCELERATOR PEDAL

- Each product in the catalogue is identified by specific **Codes**:

Code (Cosibo code)

Re. OEM (original code)

Re. ex OEM (ex original code)

- With reference to each product, truck **Models** and **Applications** it is destined to are shown:

● **Model** (marked by a dot)

★ **Application** (marked by a star)

- Page numbering is determined by the **Letter** indicating the Group + a progressive **number** (in bold) to indicate the sub-group + a progressive **number** to indicate the order of appearance in the catalogue:

A.1.25

- Two **General Indexes** are at the end of the catalogue. The first one is on the basis of the **Cosibo codes** and the second one is on the basis of the **OEM codes** (original codes).

CATALOGUE STRUCTURE

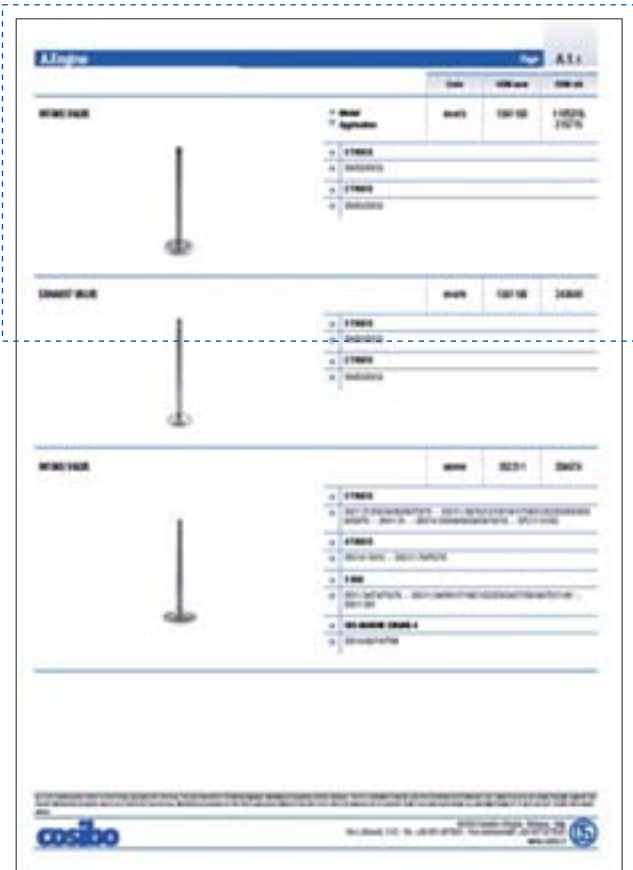

Group it is referred to

Page numbering

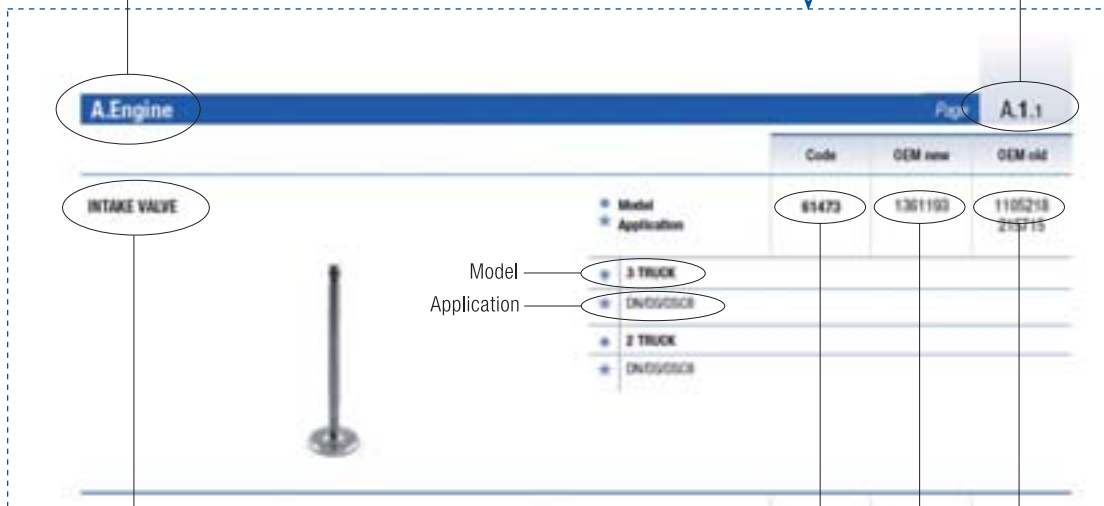

Product description

Cosibo code

Original code

Ex original code

All the components listed in our catalogue are not original, though perfectly interchangeable. Reference numbers, either original or of a different nature, are for information purposes only. When placing an order, please, always use cosibo reference numbers and do not mention the original reference numbers of the truck manufacturers in the invoice to vehicle owners or to anybody else. The customer takes his own responsibility if he does not comply with what above.

GOODS TO BE RETURNED AND COMPLAINTS

When the goods are delivered, the customer has to check that the number of boxes corresponds to what it is shown in the delivery note and that packaging is intact.

If not, when accepting the goods, he will have to clearly mention "subject to inspection" in the delivery note and he will inform immediately or, anyway, within 8 days from the delivery date Cosibo SpA.

In case the goods are made of body parts, lighting and mirrors, the delivery note and/or the CMR will have to be signed **always** by mentioning "subject to inspection" even if the delivered boxes are intact.

It has to be taken into account that only when showing the above mentioned document there will be the chance to have the goods promptly replaced.

And this is valid when carriage is paid both by the sender (Cosibo SpA) and by the customer who receives the goods.

Customer is made aware that no dispute concerning these cases will be accepted by Cosibo SpA unless it has been formalised in the delivery note at the moment of the delivery of the goods.

CHARACTERISTICS OF THE COMPLAINT:

LACK: customer reckons not to have received in full or partially what it is mentioned in a delivery note;

SURPLUS: customer reckons to have received a bigger quantity than what it is mentioned in a delivery note;

INVERSION: customer reckons to have received a different product from what it is mentioned in a delivery note;

QUALITY: customer reckons that the purchased goods do not meet technical characteristics as per what it is mentioned in the catalogue;

BREAKS: customer reckons to have received damaged goods.

In all these cases the customer has to inform Cosibo SpA in writing within 8 days from the delivery date of the goods.

This is valid as well when the customer reckons some prices and/or discounts that have been applied are different from what it was agreed.

Any dispute not formalised according to these procedures and timing will be rejected by Cosibo SpA.

PROCEDURE

GOODS TO BE RETURNED: for any request to return some goods the customer will have to fill in the "authorisation to return the good" form in a proper and detailed way and will send it to Cosibo SpA together with a picture of the piece claimed to be defective; after that, he will wait for the authorisation to return the piece.

Without such an authorisation by Cosibo SpA any returned good will be rejected. Should Cosibo SpA urge the customer to send the pictures if these are not sent within ten days from the solicitation warranty on the product will be considered no more in force. Any good authorised to be returned will have to be shipped to Cosibo SpA possibly in its original packaging together with the "authorisation to return the good" form and a copy of the delivery note signed by both the customer and the freight agent; moreover, it will have to be a good under standard production to be recognised by the computer system as an active code.

Cosibo SpA reserve the right to check the returned good; should the piece turn out to have been tempered or not to be defective the customer will be charged with freight costs and the greater damage as well.

ORDER MISTAKES: if the mistake can be attributed to the customer Cosibo SpA reserve the right to authorise the return. Anyway, the customer will be charged with any freight costs.

RETURNED GOODS NOT PRODUCED BY COSIBO SPA: Cosibo SpA will send back the goods and will charge the customer of the sum of € 50,00 + V.A.T. as administration costs. The same applies when the returned goods were delivered years before. Both cases the customer within three days from the rejection of the returned goods by Cosibo SpA will have to send the authorisation to scrap the goods. On the contrary, Cosibo SpA will send back the goods according to what above.

COMPLAINTS INTERRUPTION: each year all the complaint sent during the month of August and from December 15th to January 15th will be put on hold.

All these complaints will be taken into account starting from 15 days after the above mentioned periods.

TERMS AND CONDITIONS: Cosibo SpA will not recognise any warranty right if no communication is sent within eight days from the moment the defect has arisen and anyway after more than year from the delivery.

	Code	OEM new	OEM old
INTAKE VALVE	61473	1361193	1105218 215715
● Model			
★ Application			
● 2 TRUCK			
★ DN/DS/DSC8			
● 3 TRUCK			
★ DN/DS/DSC8			



EXHAUST VALVE	61475	1361196	243648
● 2 TRUCK			
★ DN/DS/DSC8			
● 3 TRUCK			
★ DN/DS/DSC8			



INTAKE VALVE	60010	352211	294674
● 3 BUS			
★ DS11 34/ 74/ 75/ 78 - DSC11 04/ 08/ 17/ 18/ 21/ 22/ 23/ 24/ 27/ 35/ 36/ 70/ 71/ 81 - DSI11 E01			
● IND. MARINE ENGINE 4			
★ DSI14 68/ 74/ 75M			
● 3 TRUCK			
★ DS11 21/ 23/ 34/ 35/ 36/ 73/ 75 - DSC11 08/ 10/ 12/ 13/ 16/ 17/ 18/ 21/ 22/ 23/ 30/ 35/ 36/ 39/ 70 - DN11 01 - DSC14 03/ 04/ 06/ 08/ 09/ 10/ 16 - DTC11 01/ 02			
● 4 TRUCK			
★ DSC14 13/ 15 - DSC11 74/ 75/ 79			



	Code	OEM new	OEM old
INTAKE VALVE	65336	1360836	
● Model			
★ Application			
● 3 BUS			
★ OSC11 G01			
● 4 TRUCK			
★ OSC11 G03			



EXHAUST VALVE	60014	1397521	1100997 1360834 232018 352347
● 3 BUS			
★ DS11 34/ 74/ 75/ 78 - DSC11 04/ 08/ 17/ 18/ 21/ 22/ 23/ 24/ 27/ 35/ 36/ 70/ 71/ 81 - DSI11 E01 - OSC11 G01			
● IND. MARINE ENGINE 4			
★ DSI14 68/ 74/ 75M			
● 3 TRUCK			
★ DS11 34/ 73/ 75 - DSC11 08/ 10/ 12/ 13/ 16/ 17/ 18/ 21/ 22/ 23/ 30/ 34/ 35/ 36/ 39/ 70/ 73 - DN11 01 - DSC14 03/ 04/ 06/ 08/ 09/ 10/ 16 - DTC11 01/ 02			
● 4 TRUCK			
★ DSC11 74/ 75/ 79 - OSC11 G03			



EXHAUST VALVE	62108	1116987	263427
● 3 BUS			
★ DSC11 24/ 27 - DSI11 E01			
● 3 TRUCK			
★ DS11 34/ 73/ 75 - DSC11 08/ 10/ 12/ 13/ 16/ 17/ 18/ 21/ 22/ 23/ 30/ 35/ 36/ 70 - DN11 01 - DSC14 03/ 04/ 06/ 08/ 09/ 10/ 16 - DTC11 01/ 02			
● 4 TRUCK			
★ DSC14 13/ 15			



ALL THE COMPONENTS LISTED IN OUR CATALOGUE ARE NOT ORIGINAL, THOUGH PERFECTLY INTERCHANGEABLE. REFERENCE NUMBERS, EITHER ORIGINAL OR OF A DIFFERENT NATURE, ARE FOR INFORMATION PURPOSES ONLY WHEN PLACING AN ORDER, PLEASE, ALWAYS USE COSIBO REFERENCE NUMBERS AND DO NOT MENTION THE ORIGINAL REFERENCE NUMBERS OF THE TRUCK MANUFACTURERS IN THE INVOICE TO VEHICLE OWNERS OR TO ANYBODY ELSE. THE CUSTOMER TAKES HIS OWN RESPONSIBILITY IF HE DOES NOT COMPLY WITH WHAT ABOVE.

	Code	OEM new	OEM old
INTAKE VALVE	65334	1386647	
<ul style="list-style-type: none"> ● Model ★ Application 			
<ul style="list-style-type: none"> ● 4 BUS 			
★ DC9 01/ 02/ 03/ 04/ / 05/ 06			
<ul style="list-style-type: none"> ● 4 TRUCK 			
★ DC9 01/ 02/ 03/ 04/ / 05/ 06			



EXHAUST VALVE	65335	1386648	1414395
<ul style="list-style-type: none"> ● 4 BUS 			
★ DC9 01/ 02/ 03/ 04/ / 05/ 06			
<ul style="list-style-type: none"> ● 4 TRUCK 			
★ DC9 01/ 02/ 03/ 04/ / 05/ 06			



INTAKE VALVE	63546	1785076	1333230 1477022
<ul style="list-style-type: none"> ● 4 BUS 			
★ DSC12 01/ 02/ 03/ 05 - DC11 01/ 02/ 03/ 04/ 06/ 07 - DC12 01/ 02/ 09/ 16 - DC9 19/ 20/ 21			
<ul style="list-style-type: none"> ● F-K-N BUS 			
★ PDE HPI			
<ul style="list-style-type: none"> ● IND. MARINE ENGINE 4 			
★ D12M EMS - DI12 69M - SGI 12A - DC12 50A/ 54A/ 57A - DC16 A - D12A EMS - DI16 48A/ 56A - D16M			
<ul style="list-style-type: none"> ● IND. MARINE ENGINE 5 			
★ SG9 A280 - DC9 EMS			
<ul style="list-style-type: none"> ● 4 TRUCK 			
★ DSC12 01/ 02/ 03/ 05 - DC11 01/ 02/ 03/ 04/ 06/ 07 - DC12 01/ 02/ 03/ 09/ 16 - DC9 19/ 20/ 21 - DT12 02/ 08 L01 - DT12 10 - DC16			
<ul style="list-style-type: none"> ● P-G-R-T TRUCK 			
★ PDE HPI			



		Code	OEM new	OEM old
EXHAUST VALVE	● Model	63545	1791152	1328537 1445830
	★ Application			
	● 4 BUS			
	★	DSC12 01/ 02/ 03/ 05 - DC11 01/ 02/ 03/ 04/ 06/ 07 - DC12 01/ 02/ 09/ 16 - DC9 19/ 20/ 21		
	● F-K-N BUS			
	★	PDE HPI		
	● IND. MARINE ENGINE 4			
	★	D12M EMS - DI12 69M - SGI 12A - DC12 50A/ 54A/ 57A - DC16 A - D12A EMS - DI16 48A/ 53A - D16 M		
	● IND. MARINE ENGINE 5			
	★	SG9 A280 - DC9A EMS		
	● 4 TRUCK			
	★	DSC12 01/ 02/ 03/ 05 - DC11 01/ 02/ 03/ 04/ 06/ 07 - DC12 01/ 02/ 03/ 09/ 16 - DT12 02/ 08/ L01/ L02 - DT12 10 - DC9 19/ 20/ 21 - DC16		
● P-G-R-T TRUCK				
★	PDE HPI			

		61476	1801529	1319081 391608
INTAKE VALVE	● 3 BUS			
	★	DS/ DSC9		
	● 4 BUS			
	★	DSC9 - DS19 E01 - OSC9		
	● IND. MARINE ENGINE 4			
	★	SG9 A280 - D/ DS9 90/ 92A - DC DSC9 46/ 47/ 49/ 50/ 51A - DI/ DS19 48/ 51/ 53A - DC9 51/ 53/ 54/ 55A - DI9 56A		
	● 3 TRUCK			
	★	DN/ DS9 - DSC9 2/ 7/ 8/ 9/ 10		
	● 4 TRUCK			
	★	DSC9		

ALL THE COMPONENTS LISTED IN OUR CATALOGUE ARE NOT ORIGINAL, THOUGH PERFECTLY INTERCHANGEABLE. REFERENCE NUMBERS, EITHER ORIGINAL OR OF A DIFFERENT NATURE, ARE FOR INFORMATION PURPOSES ONLY WHEN PLACING AN ORDER, PLEASE, ALWAYS USE COSIBO REFERENCE NUMBERS AND DO NOT MENTION THE ORIGINAL REFERENCE NUMBERS OF THE TRUCK MANUFACTURERS IN THE INVOICE TO VEHICLE OWNERS OR TO ANYBODY ELSE. THE CUSTOMER TAKES HIS OWN RESPONSIBILITY IF HE DOES NOT COMPLY WITH WHAT ABOVE.

		Code	OEM new	OEM old
EXHAUST VALVE	● Model	61477	1360833	278102
	★ Application			
	● 3 BUS			
	★	DS/ DSC9		
	● 4 BUS			
	★	DSC9 - DSI9 E01 - OSC9		
	● IND. MARINE ENGINE 4			
	★	SG9 A280 - D/ DS9 46/ 47/ 49/ 50/ 51A - DI/ DSI9 48/ 51/ 53A - DC9 51/ 53/ 54/ 55A - DI9 56A - D/ DS9 90/ 92A - DC/ DSC9 46/ 47/ 49/ 50/ 51A		
	● 3 TRUCK			
	★	DN/ DS9 - DSC9 2/ 7/ 8/ 9/ 10		
	● 4 TRUCK			
	★	DSC9		

		60017	1523410	269715 300957
INTAKE VALVE GUIDE	● 3 BUS			
	★	DS11 34/ 74/ 75/ 78 - DSC11 04/ 08/ 17/ 18/ 21/ 22/ 23/ 35/ 36/ 71 - DS/ DSC9		
	● IND. MARINE ENGINE 4			
	★	DSI14 68/ 74/ 75M		
	● 3 TRUCK			
	★	DN9 - DS9 - DSC9 02/ 07/ 08/ 10 - DS11 34/ 73/ 75 - DSC11 08/ 10/ 12/ 13/ 16/ 17/ 18/ 21/ 22/ 23/ 30/ 35/ 36/ 39 - DN11 01 - DSC14 03/ 04/ 06/ 08/ 09/ 10 - DTC11 01		
	● 4 TRUCK			
	★	DSC11 74/ 75 - OSC11 G03		
				

ALL THE COMPONENTS LISTED IN OUR CATALOGUE ARE NOT ORIGINAL, THOUGH PERFECTLY INTERCHANGEABLE. REFERENCE NUMBERS, EITHER ORIGINAL OR OF A DIFFERENT NATURE, ARE FOR INFORMATION PURPOSES ONLY WHEN PLACING AN ORDER, PLEASE, ALWAYS USE COSIBO REFERENCE NUMBERS AND DO NOT MENTION THE ORIGINAL REFERENCE NUMBERS OF THE TRUCK MANUFACTURERS IN THE INVOICE TO VEHICLE OWNERS OR TO ANYBODY ELSE. THE CUSTOMER TAKES HIS OWN RESPONSIBILITY IF HE DOES NOT COMPLY WITH WHAT ABOVE.

	Code	OEM new	OEM old
INTAKE VALVE GUIDE	62105	1521210	393263
● Model			
★ Application			
● 3 BUS			
★ DS11 70/ 78 - DSC11 21/ 24/ 27/ 70/ 71/ 81 - DSI11 E01 - OSC11 G01			
● 4 BUS			
★ OSC9			
● IND. MARINE ENGINE 4			
★ SG9 A280			
● 3 TRUCK			
★ DN/ DS9 - DSC9 07/ 09/ 10 - DSC14 08/ 09/ 10 ENG 5 550 362 - DSC11 70 - DTC11 02 - DSC14 16			
● 4 TRUCK			
★ DSC11 79 - DSC14 13/ 15			



EXHAUST VALVE GUIDE	60018	1521209	1398624 223635 269716 300958 393264
● 3 BUS			
★ DS11 34/ 74/ 75/ 78 - DSC11 04/ 08/ 17/ 18/ 21/ 22/ 23/ 24/ 27/ 35/ 36/ 70/ 71/ 81 - DS/ DSC9 - DSI11 E01 - OSC11 G01			
● 4 BUS			
★ DC9 01/ 02/ 03/ 04/ 05/ 06 ALSO INTAKE - OSC9 - DS19 E01 ALSO INTAKE - DSC9 ALSO INTAKE			
● IND. MARINE ENGINE 4			
★ SG9 A280 - DSI14 68/74/75M - D/DS9 90/92A ALSO INTAKE - DC/DSC9 46/47/49/50/51A ALSO INTAKE - DI/DS19 48/51/53A ALSO INTAKE - DC9 51/53/54/55A ALSO INTAKE - DI9 56A ALSO INTAKE			
● 3 TRUCK			
★ DN/ DS9 - DSC9 02/ 07/ 08/ 09/ 10 - DS11 34/ 73/ 75 - DSC11 08/ 10/ 12/ 13/ 16/ 17/ 18/ 21/ 23/ 30/ 35/ 36/ 39/ 70 - DN11 01 - DSC14 03/ 04/ 06/ 08/ 09/ 10/ 16 - DTC11 01/ 02			
● 4 TRUCK			
★ DSC11 74/ 75/ 79 - OSC11 G03 - DSC14 13/ 15 - DSC9 ALSO INTAKE - DC9 01/ 02/ 03/ 04/ 05/ 06 ALSO INTAKE			



ALL THE COMPONENTS LISTED IN OUR CATALOGUE ARE NOT ORIGINAL, THOUGH PERFECTLY INTERCHANGEABLE. REFERENCE NUMBERS, EITHER ORIGINAL OR OF A DIFFERENT NATURE, ARE FOR INFORMATION PURPOSES ONLY WHEN PLACING AN ORDER, PLEASE, ALWAYS USE COSIBO REFERENCE NUMBERS AND DO NOT MENTION THE ORIGINAL REFERENCE NUMBERS OF THE TRUCK MANUFACTURERS IN THE INVOICE TO VEHICLE OWNERS OR TO ANYBODY ELSE. THE CUSTOMER TAKES HIS OWN RESPONSIBILITY IF HE DOES NOT COMPLY WITH WHAT ABOVE.

INTAKE AND EXHAUST VALVE GUIDE



	Code	OEM new	OEM old
● Model	63896	1403823	
★ Application			
● 4 BUS			
★	DSC12 01/ 02/ 03/ 05 - DC11 01/ 02/ 03/ 04/ 06/ 07 - DC12 01/ 02/ 09/ 16 - DC9 19/ 20/ 21		
● F-K-N BUS			
★	PDE HPI - XPI		
● IND. MARINE ENGINE 4			
★	D12M EMS - DI12 69M - SG12A - DC12 50A/ 54A/ 57A - DC16A - D12A EMS - DI16 48A/ 53A - DI16M		
● IND. MARINE ENGINE 5			
★	SG9 A280 - DC9A EMS		
● 4 TRUCK			
★	DSC12 01/ 02/ 03/ 05 - DC11 01/ 02/ 03/ 04/ 06/ 07 - DC12 01/ 02/ 03/ 09/ 16 - DC9 19/ 20/ 21 - DT12 02/ 08 L01/ L02 - DT12 10 - DC16		
● P-G-R-T TRUCK			
★	PDE HPI - XPI		

ALL THE COMPONENTS LISTED IN OUR CATALOGUE ARE NOT ORIGINAL, THOUGH PERFECTLY INTERCHANGEABLE. REFERENCE NUMBERS, EITHER ORIGINAL OR OF A DIFFERENT NATURE, ARE FOR INFORMATION PURPOSES ONLY WHEN PLACING AN ORDER, PLEASE, ALWAYS USE COSIBO REFERENCE NUMBERS AND DO NOT MENTION THE ORIGINAL REFERENCE NUMBERS OF THE TRUCK MANUFACTURERS IN THE INVOICE TO VEHICLE OWNERS OR TO ANYBODY ELSE. THE CUSTOMER TAKES HIS OWN RESPONSIBILITY IF HE DOES NOT COMPLY WITH WHAT ABOVE.

FLYWHEEL



	Code	OEM new	OEM old
● Model	60109	393151	306993
★ Application			
● 3 BUS			
★			
● 4 BUS			
★	DSC9 - DC9 01/ 02/ 03/ 04/ 05/ 06 - K/ L/ N 94 - DC9 - DSC9 - DS19 E01 - OSC9 G01 - DSC9 K94		
● IND. MARINE ENGINE 4			
★	D9A/ M		
● 3 TRUCK			
★	DS/ DSC11 FOR K422 8/ 9/ 12/ 13 - K432 3 - K402 1/ 3/ 4		
● 4 TRUCK			
★	DSC9 - DC9 01/ 02/ 03/ 04/ 05/ 06 - DSC11		

RING GEAR



	60101	1471237	139625
● 3 BUS			
★			
● 4 BUS			
★	DSC9/ DC9 01/ 02/ 03/ 04/ 05/ 06 ENG 6028487 - ENG 8028902 - ENG 6028486 - ENG 8028901 - DC9 19/ 20/ 21 ENG 8103229 - ENG/ MAG 8103230 - K/ L/ N94 - DSC9 - DS19 E01 - DC9 - OSC9 G01 - DSC9 K94		
● F-K-N BUS			
★	D11/ D12 - D9 PDE - D9 XPI - DC9 19/ 20/ 21 - D9 PDE K/ N - D12K		
● IND. MARINE ENGINE 4			
★	D9A/ M		
● IND. MARINE ENGINE 5			
★	SG9 A280 - DC9A EMS ENG 6299926 SSS - 6299927 SSS - ENG 8103229 SLA - ENG 8103220 SLA - DC9A EMS CLARK 15"/17" ENG 8103230 SLA - ENG 6299926 SSS - ENG 6299927 SSS - ENG 8103229 SLA - DC9A EMS SAE 11.5"/14" ENG 6299926 SSS - ENG 6299927 SSS - ENG 8103229 SLA - ENG 8103230 SLA		
● 3 TRUCK			
★	DS/ DSC11 - DTC11 - P93 D9 GA750 - P93/ 113 - D9/ 11 GA850/ 850R		
● 4 TRUCK			
★	DSC9/ DC9 01/ 02/ 03/ 04/ 05/ 06 ENG G 6028487 - ENG G 8028902 - ENG G 6028486 - ENG G 8028901 - DC9 19/ 20/ 21 ENG G 8103229 - ENG G/ MAG 8103230 - DSC11 - DSC12 03/ 05 - DC12 - DT12 - OSC11 G03		
● P-G-R-T TRUCK			
★	D11/ D12 - D9 PDE - D9 XPI - D13		

ALL THE COMPONENTS LISTED IN OUR CATALOGUE ARE NOT ORIGINAL, THOUGH PERFECTLY INTERCHANGEABLE. REFERENCE NUMBERS, EITHER ORIGINAL OR OF A DIFFERENT NATURE, ARE FOR INFORMATION PURPOSES ONLY WHEN PLACING AN ORDER, PLEASE, ALWAYS USE COSIBO REFERENCE NUMBERS AND DO NOT MENTION THE ORIGINAL REFERENCE NUMBERS OF THE TRUCK MANUFACTURERS IN THE INVOICE TO VEHICLE OWNERS OR TO ANYBODY ELSE. THE CUSTOMER TAKES HIS OWN RESPONSIBILITY IF HE DOES NOT COMPLY WITH WHAT ABOVE.

		Code	OEM new	OEM old
RING GEAR	● Model	60591	1891445	1465410 1487567 1527914 170069
	★ Application			
	● IND. MARINE ENGINE 4			
	★			
	● 3 TRUCK			
	★			
	● 4 TRUCK			
	★ DSC14 13/ 15			

		64378	1527913	1487566
RING GEAR	● 4 BUS			
	★ D11 ENG 6302553 - ENG 8103229 - D12 ENG 6302553 - ENG 8103229 - K114/124			
	● IND. MARINE ENGINE 4			
	★ D112 68M ENG 8712210 SLA - ENG 8712209 SLA - D12M EMS ENG 6514494 SSS - D112 49A/DC12 57A ENG 6514494 SSS - ENG 6514495 SSS - ENG 8712209 SLA - ENG 8712210 SLA - D12M EMS ENG 6514495 SSS - ENG 8712209 SLA - ENG 8712210 SLA - SG9 A280 - DC16A - D16M			
	● 4 TRUCK			
	★ D11 ENG 6302553 - ENG 8103229 - DSC12 01/ 02 ENG 5719204 - ENG 5719205 - DSC12 03/ 05 - DC12 - DT12 - OSC11 G03 - DC16			

ALL THE COMPONENTS LISTED IN OUR CATALOGUE ARE NOT ORIGINAL, THOUGH PERFECTLY INTERCHANGEABLE. REFERENCE NUMBERS, EITHER ORIGINAL OR OF A DIFFERENT NATURE, ARE FOR INFORMATION PURPOSES ONLY WHEN PLACING AN ORDER, PLEASE, ALWAYS USE COSIBO REFERENCE NUMBERS AND DO NOT MENTION THE ORIGINAL REFERENCE NUMBERS OF THE TRUCK MANUFACTURERS IN THE INVOICE TO VEHICLE OWNERS OR TO ANYBODY ELSE. THE CUSTOMER TAKES HIS OWN RESPONSIBILITY IF HE DOES NOT COMPLY WITH WHAT ABOVE.

	Code	OEM new	OEM old
BEARING	63750	1313606	168248
● Model			
★ Application			
● 3 BUS			
★ G/GS/GR - GR801 - GR801R - DSC11 22/70 EDC - DSC11 - DSC11 21 - K/L 113 - K 93			
● 3 TRUCK			
★ G/GR/GS/GRS - DS/DSC11 - DTC11			
● 4 BUS			
★ DSC9 - DC9 01/02/03/04/05/06/19/20/21 - DS19 E01 - OSC9 G01 - D12 - D11 - K/L/N 94 - K 114/124			
● 4 TRUCK			
★ DSC9 - DC9 01/02/03/04/05/06/19/20/21 - DSC11 - DSC12 01/02/03/05 - DC12 - DT12 - DSC14 13/15 - OSC11 G03 - D11 - DC16			
● F-K-N BUS			
★ D9 PDE - D11 - D12 - F			
● IND. MARINE ENGINE 4			
★ D9 A/M - DC16 A			
● IND. MARINE ENGINE 5			
★ DC9A EMS			
● P-G-R-T TRUCK			
★ D9 PDE - D11 - D12 - D16			



	60102	353843	131120 271488
CRANKSHAFT PINION			
● 3 TRUCK			
★ DS/ DSC11 - DTC11 - DS11 75 - DSC11 21/ 22/ 23/ 35/ 36/ 39/ 70 - DTC11 01/ 02			
● 4 TRUCK			
★ OSC11 G03			
● 3 BUS			
★			
● IND. MARINE ENGINE 4			
★			



	Code	OEM new	OEM old
VIBRATION DAMPER	64352	1373127	
● Model			
★ Application			
● 3 TRUCK			
★	ENG 5116676 SSS - ENG 4018171 SNL - ENG 4018542 SNL - ENG 4019401 SNL - ENG 5354630 SSS - DS/DSC11 ENG 5354630 SSS - ENG 4105387 SNL - DTC11 ENG 5354630 SSS - ENG 4105387 SNL		
● 4 TRUCK			
★	DSC9 - DC9 01/02/03/04/05/06 ENG 6028487 SSS - ENG 8028902 SLA - ENG 6028486 SSS - ENG 8028901 SLA - DSC11 - OSC11 G03		
● 3 BUS			
★	ENG 5354630 SSS - ENG 5116676 SSS		
● 4 BUS			
★	DSC9-DC9 01/02/03/04/05/06 ENG 6028487 SSS - ENG 8028902 SLA - ENG 6028486 SSS - ENG 8028901 SLA - K/L/N94 - DSC9 - DS19 E01 - DC9 - OSC9 G01 - DSC9 K94		
● IND. MARINE ENGINE 4			
★	SG9 A280		



OIL SEAL 35X52X10	61109	1122620	
● 3 TRUCK			
★	DSC14 08/09/10/16		
● IND. MARINE ENGINE 4			
★			



	Code	OEM new	OEM old
CYLINDER HEAD GASKET	60002	373472	257375 346143
● Model			
★ Application			
● 3 BUS			
★ DS11 34/ 74/ 75/ 78 - DSC11 04/ 08/ 17/ 18/ 21/ 22/ 23/ 24/ 27/ 35/ 36/ 70/ 71/ 81 - DSI11 E01 - OSC11 G01			
● 4 BUS			
★ DSC11 - OSC11 G03			
● 3 TRUCK			
★ DS11 34/ 73/ 75 - DSC11 08/ 10/ 12/ 13/ 16/ 17/ 18/ 21/ 22/ 23/ 30/ 35/ 36/ 39/ 70 - DN11 01 - DTC11 01/ 02			
● 4 TRUCK			
★ DSC11 - OSC11 G03 - DSC11 74/ 75/ 79			

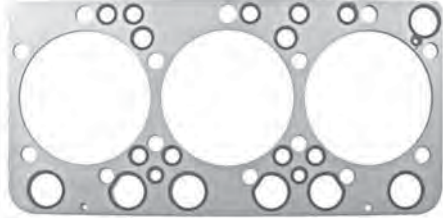

CYLINDER HEAD GASKET	60003	1403587	1313459 170274 367569
● IND. MARINE ENGINE 4			
★ D14 A/ M			
● 3 TRUCK			
★ DSC14 03/ 04/ 06/ 08/ 09/ 10/ 16			
● 4 TRUCK			
★ DSC14 13/ 15			

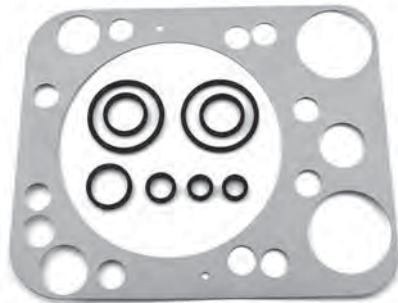

		Code	OEM new	OEM old
CYLINDER HEAD GASKET	● Model	63565	1444941	1377039
	★ Application			
	● 4 BUS			
	★	(DSC12 01/02 - DC11 07 ENG 6150649 SSS - ENG 8021834 SLA) - (DSC12 03/05/ DC12 ENG 6102922 SSS - ENG 6107146 - 6109703 SSS - ENG 3138021 SLA) - (DSC12 03/05 - DC12 ENG 6102923 - 6107145 SSS - ENG 6109704 - 6150649 SSS - ENG 3138022 - 8021834 SLA) - (DC11 01/02/03/04/06 ENG 6102921 SSS - ENG 6104629 - 6105125 SSS - ENG 3138021 SLA) - (DC11 01/02/03/04/06 ENG 6102922 - 6104628 SSS/ENG 6105126 - 6150649 SSS - ENG 3138022 - 8021834 SLA) - (DC11/D12 ENG 6119599 SSS - ENG 8004779 SLA) - (DSC12 01/02 ENG 5740731 SSS - ENG 3125405 SLA) - (DC11 01/02/03/04/06 - DSC12 03/05 - DC12 - DT12 ENG 6119599 SSS - ENG 8004779 SLA) - (DSC12 01/02 - DC11 07 ENG 5740732 - 6119599 SSS - ENG 3125406 - 8004779 SLA)		
	● IND. MARINE ENGINE 4			
★	(ENG 6150649 - ENG 8021834) - (D12A/ M ENG 6119599 - ENG 8004779)			
● 4 TRUCK				
★	(DSC12 01/02 - DC11 07 ENG 6150649 SSS - ENG 8021834 SLA) - (DSC12 03/05/ DC12 ENG 6102922 SSS - ENG 6107146 - 6109703 SSS - ENG 3138021 SLA) - (DSC12 03/05 - DC12 ENG 6102923 - 6107145 SSS - ENG 6109704 - 6150649 SSS - ENG 3138022 - 8021834 SLA) - (DC11 01/02/03/04/06 ENG 6102921 SSS - ENG 6104629 - 6105125 SSS - ENG 3138021 SLA) - (DC11 01/02/03/04/06 ENG 6102922 - 6104628 SSS/ENG 6105126 - 6150649 SSS - ENG 3138022 - 8021834 SLA) - (DC11/D12 ENG 6119599 SSS - ENG 8004779 SLA) - (DSC12 01/02 ENG 5740731 SSS - ENG 3125405 SLA) - (DC11 01/02/03/04/06 - DSC12 03/05 - DC12 - DT12 ENG 6119599 SSS - ENG 8004779 SLA) - (DSC12 01/02 - DC11 07 ENG 5740732 - 6119599 SSS - ENG 3125406 - 8004779 SLA)			

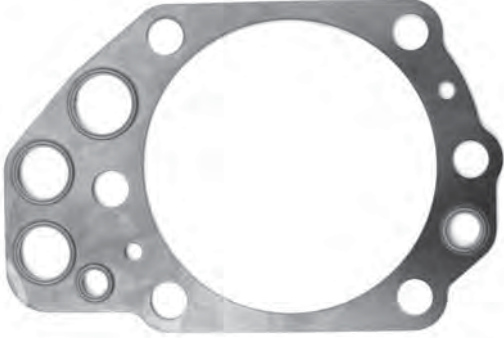
CYLINDER HEAD GASKET		60970	1403258	387503
	● 3 BUS			
	★	DS/DSC9		
	● 3 TRUCK			
★	DN/DS9 - DSC9 02/07/08/09/10			
● 4 BUS				
★	DSC9 - DS19 E01 - DC9 01/02/03/04/05/06 - OSC9 G01			
● 4 TRUCK				
★	DSC9 - DC9 01/02/03/04/05/06 - DS19 E01 - OSC9 G01			
● IND. MARINE ENGINE 4				
★	SG9 A280 - D/DS9 90/92A - DC/DSC9 46/47/49/50/51A - DI/DS19 48/51/53A - DC9 51/53/54/55A - DI9 56A - D9/DSC9 A/M			

ALL THE COMPONENTS LISTED IN OUR CATALOGUE ARE NOT ORIGINAL, THOUGH PERFECTLY INTERCHANGEABLE. REFERENCE NUMBERS, EITHER ORIGINAL OR OF A DIFFERENT NATURE, ARE FOR INFORMATION PURPOSES ONLY WHEN PLACING AN ORDER, PLEASE, ALWAYS USE COSIBO REFERENCE NUMBERS AND DO NOT MENTION THE ORIGINAL REFERENCE NUMBERS OF THE TRUCK MANUFACTURERS IN THE INVOICE TO VEHICLE OWNERS OR TO ANYBODY ELSE. THE CUSTOMER TAKES HIS OWN RESPONSIBILITY IF HE DOES NOT COMPLY WITH WHAT ABOVE.

	Code	OEM new	OEM old
CYLINDER HEAD GASKET	63933	1468555	
● Model			
★ Application			
● 3 TRUCK			
★	DSC12 01/02 - DC11 07 - DC12 03/05 - DC12 - DC11 01/02/03/04/06 - DC9 19/20/21 - DSC12 05 - DC12 01/02/09/16 - DC11 - D12 - DSC12 05 - DT12 - DT12 02/08 L01 - DC12 03 - DT12 02/08 L02 - DT12 10 - DC16		
● 4 BUS			
★	(DSC12 01/02 - DC11 07 ENG 6150649 SSS - ENG 8021834 SLA) - (DC12 03/05 - DC12 ENG 6102923 - 6107145 SSS - ENG 6109704 - 6150649 SSS - ENG 3138022 - 8021834 SLA) - (DC11 01/02/03/04/06 ENG 6102922 - 6104628 SSS - ENG 6105126 - 6150649 SSS - ENG 3138022 - 8021834 SLA) - (DSC12 01/02 - DC11 07 ENG 6150650 SSS - ENG 8021835 SLA) - DC9 19/20/21 - (DC11 01/02/03/04/06 ENG 6150650 SSS - ENG 8021835 SLA) - (DSC12 05 - DC12 01/02/09/16 ENG 6150650 SSS - ENG 8021835 SLA) - (DC11 - D12 ENG 6119600 SSS - ENG 8004780 SLA) - DC9 19/20/21 - (DSC12 01/02 - DC11 07 ENG 6119600 SSS - ENG 8004780 SLA) - DC11 01/02/03/04/06 - DSC12 05 - DC12 - DT12 ENG 6119600 SSS - ENG 8004780 SLA)		
● P-G-R-T TRUCK			
★	PDE - HPI - D9 - D11 - D12 - D16		
● IND. MARINE ENGINE 4			
★	D12M EMS - DI12 69M - SGH12A - DC12 50A/54A/57A - DC16A - D12A EMS - DI16 48A/53A - (D16M ENG 6507872 - 6510537 SSS - ENG 6510538 - 6513510 SSS - ENG 1039758 SSS) - D12A/M - (D12M EMS ENG 6515877 SSS - ENG 8710546 SLA - ENG 6515878 SSS - ENG 8710547 SLA) - (DSC12 03/05 - DC12 ENG 6150649 SSS - ENG 8021834 SLA)		
● IND. MARINE ENGINE 5			
★	SG9 A280 - DC9 EMS - DC9A EMS		
● F-K-N BUS			
★	PDE - HPI - D9 - D11 - D12 - D16		



CYLINDER HEAD GASKET SET

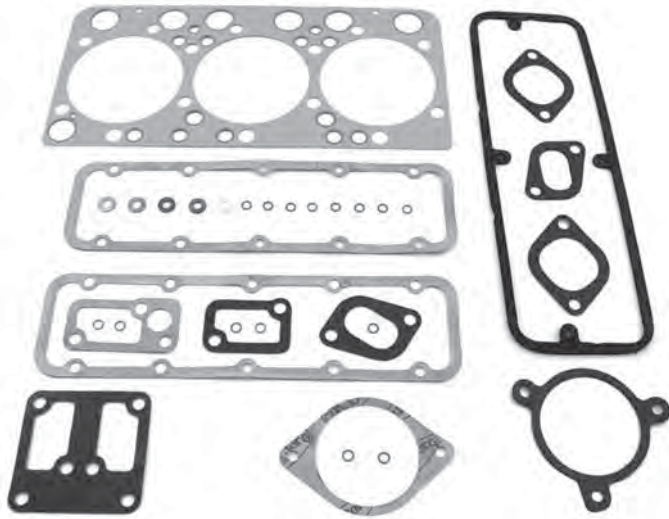

	Code	OEM new	OEM old
● Model	60573	551456	551513
★ Application			
● 3 TRUCK			
★	ENG 5307760 - ENG 4070104 - ENG 3075634 SSB		

CYLINDER HEAD GASKET SET

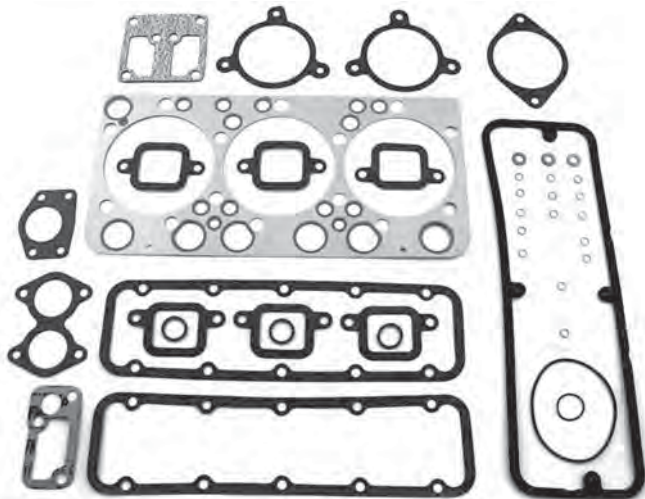

	61560	551512	551500
● 3 BUS			
★			
● 3 TRUCK			
★	ENG 5307761 - ENG 4070105 - ENG 3075635 SSB		

CYLINDER HEAD GASKET SET



	60587	551469	550214
● 3 TRUCK			
★	DSC14		
● 4 TRUCK			
★	DSC14 13/ 15		

ALL THE COMPONENTS LISTED IN OUR CATALOGUE ARE NOT ORIGINAL, THOUGH PERFECTLY INTERCHANGEABLE. REFERENCE NUMBERS, EITHER ORIGINAL OR OF A DIFFERENT NATURE, ARE FOR INFORMATION PURPOSES ONLY WHEN PLACING AN ORDER, PLEASE, ALWAYS USE COSIBO REFERENCE NUMBERS AND DO NOT MENTION THE ORIGINAL REFERENCE NUMBERS OF THE TRUCK MANUFACTURERS IN THE INVOICE TO VEHICLE OWNERS OR TO ANYBODY ELSE. THE CUSTOMER TAKES HIS OWN RESPONSIBILITY IF HE DOES NOT COMPLY WITH WHAT ABOVE.

	Code	OEM new	OEM old
CYLINDER HEAD GASKET SET	60972	551484	
<ul style="list-style-type: none"> ● Model ★ Application 			
<ul style="list-style-type: none"> ● 3 TRUCK ★ DS9 - DSC9 			
<ul style="list-style-type: none"> ● 3 BUS ★ DS9 - DSC9 			

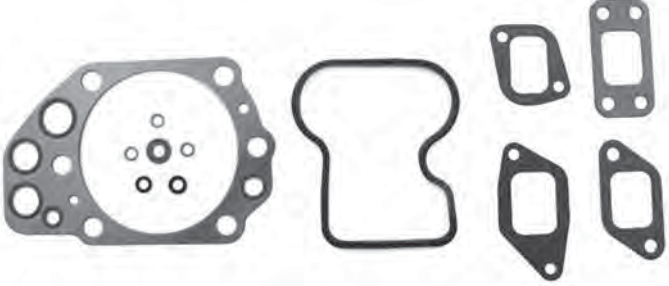

CYLINDER HEAD GASKET KIT	63280	551350	
<ul style="list-style-type: none"> ● 4 TRUCK ★ (DSC12 01/ 02 - DC11 07 ENG 6150649 - ENG 8021834) - (DSC12 01/ 02 ENG 5719204) - (DSC12 01/ 02/ DC1107 ENG 5719205) - (DSC12 01/ 02 ENG 574073 - ENG3125405) - DSC12 01/ 02 			
<ul style="list-style-type: none"> ● 4 BUS ★ (DSC12 01/ 02 - DC11 07 ENG 6150649 - ENG 8021834) - (DSC12 01/ 02 ENG 5719204) - (DSC12 01/ 02/ DC1107 ENG 5719205) - (DSC12 01/ 02 ENG 5740731 - ENG3125405) 			

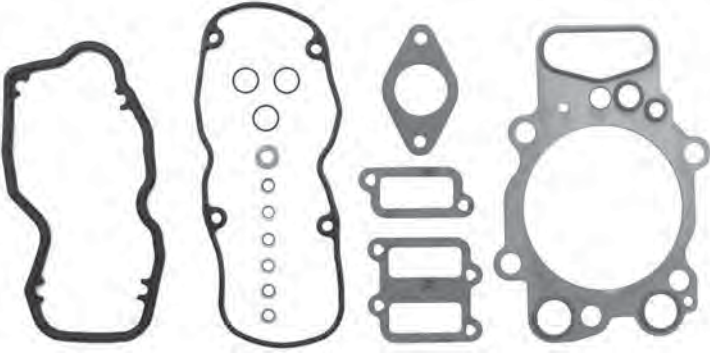

ALL THE COMPONENTS LISTED IN OUR CATALOGUE ARE NOT ORIGINAL, THOUGH PERFECTLY INTERCHANGEABLE. REFERENCE NUMBERS, EITHER ORIGINAL OR OF A DIFFERENT NATURE, ARE FOR INFORMATION PURPOSES ONLY WHEN PLACING AN ORDER, PLEASE, ALWAYS USE COSIBO REFERENCE NUMBERS AND DO NOT MENTION THE ORIGINAL REFERENCE NUMBERS OF THE TRUCK MANUFACTURERS IN THE INVOICE TO VEHICLE OWNERS OR TO ANYBODY ELSE. THE CUSTOMER TAKES HIS OWN RESPONSIBILITY IF HE DOES NOT COMPLY WITH WHAT ABOVE.

CYLINDER HEAD GASKET KIT

- Model
- ★ Application

Code	OEM new	OEM old
63281	551363	

- 4 TRUCK

- ★ (DSC12 01/02 - DC11 07 EN 6150649 SSS - EN 8021834 SLA) - (DSC12 03/05 - DC12 EN 6102922 SSS EN 6107146 - 6109703 SSS EN 3138021 SLA) - (DSC12 03/05 - DC12 EN 6102923 - 6107145 SSS EN 6109704 - 6150649 SSS - EN 3138022 - 8021834 SLA) - (DSC12 03/05 EN 5731918 SSS - EN 5731798 SNL - EN 5731559 SAN - EN 3123646 SLA) - (DSC12 03/05 - DC12 - DT12 EN 5731919 SSS - EN 5731799 SNL - EN 5731560 SAN - EN 3123647 SLA) - (DC11 01/02/03/04/06 EN 6102921 SSS - EN 6104629 - 6105125 SSS - EN 3138021 SLA) - (DC11 01/02/03/04/06 EN 6102922 - 6104628 SSS - EN 6105126 - 6150649 SSS - EN 3138022 - 8021834 SLA) - (DC11 01/02/03/04/06 - DSC12 03/05 - DC12 - DT12 EN 6119599 SSS - EN 8004779 SLA) - (DSC12 01/02 - DC11 07 EN 5740732 - 6119599 SSS - EN 3125406 - 8004779 SLA)

- 4 BUS

- ★ (DSC12 01/02 - DC11 07 EN 6150649 SSS - EN 8021834 SLA) - (DSC12 03/05 - DC12 EN 6102922 SSS EN 6107146 - 6109703 SSS EN 3138021 SLA) - (DSC12 03/05 - DC12 EN 6102923 - 6107145 SSS EN 6109704 - 6150649 SSS - EN 3138022 - 8021834 SLA) - (DSC12 03/05 EN 5731918 SSS - EN 5731798 SNL - EN 5731559 SAN - EN 3123646 SLA) - (DSC12 03/05 - DC12 - DT12 EN 5731919 SSS - EN 5731799 SNL - EN 5731560 SAN - EN 3123647 SLA) - (DC11 01/02/03/04/06 EN 6102921 SSS - EN 6104629 - 6105125 SSS - EN 3138021 SLA) - (DC11 01/02/03/04/06 EN 6102922 - 6104628 SSS - EN 6105126 - 6150649 SSS - EN 3138022 - 8021834 SLA) - (DC11 01/02/03/04/06 - DSC12 03/05 - DC12 - DT12 EN 6119599 SSS - EN 8004779 SLA) - (DSC12 01/02 - DC11 07 EN 5740732 - 6119599 SSS - EN 3125406 - 8004779 SLA) - DC11/D12

- IND. MARINE ENGINE 4

- ★ D12M EMS - D112 69M - DC12 50/ 54/ 57A - D12A/ M

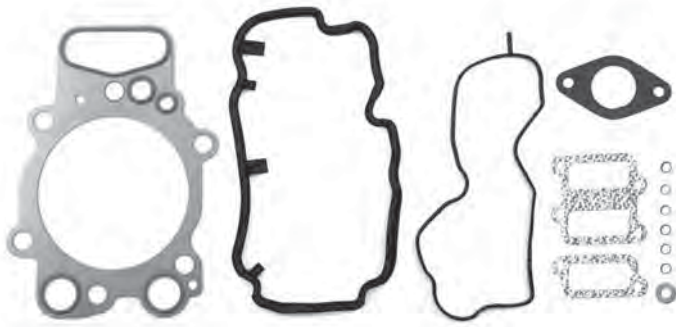

GASKET

60207	384464	
-------	--------	--

- 3 TRUCK

- ★ CP/CR/CT 113 - DSC11 18 ENG 5314214

- 3 BUS

- ★

- IND. MARINE ENGINE 4

- ★ DS/DSC/DSI 11A



ALL THE COMPONENTS LISTED IN OUR CATALOGUE ARE NOT ORIGINAL, THOUGH PERFECTLY INTERCHANGEABLE. REFERENCE NUMBERS, EITHER ORIGINAL OR OF A DIFFERENT NATURE, ARE FOR INFORMATION PURPOSES ONLY WHEN PLACING AN ORDER, PLEASE, ALWAYS USE COSIBO REFERENCE NUMBERS AND DO NOT MENTION THE ORIGINAL REFERENCE NUMBERS OF THE TRUCK MANUFACTURERS IN THE INVOICE TO VEHICLE OWNERS OR TO ANYBODY ELSE. THE CUSTOMER TAKES HIS OWN RESPONSIBILITY IF HE DOES NOT COMPLY WITH WHAT ABOVE.

CYLINDER HEAD GASKET SET

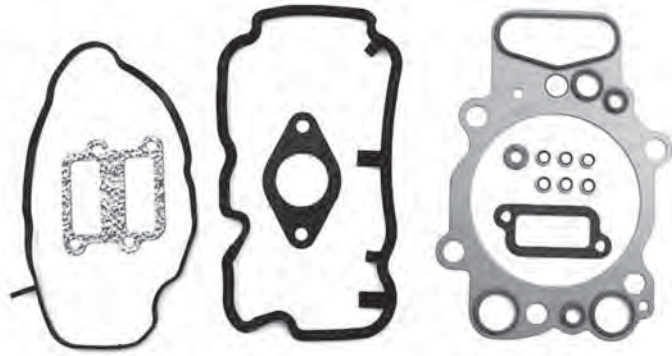

	Code	OEM new	OEM old
● Model	63931	550469	
★ Application			
● 4 TRUCK			
★	(DSC12 03/05 - DC12 ENG 6102923 - 6107145 SSS - ENG 6109704 - 6150649 SSS - ENG 3138022 - 8021834 SLA) - (DSC12 03/05//DC12/DT12 ENG 5731919 SSS - ENG 5731799 SNL - ENG 5731560 SAN - ENG 3123647 SLA) - (DC11 01/02/03/04/06 ENG 6102922 - 6104628 SSS - ENG 6105126 - 6150649 SSS - ENG 3138022 - 8021834 SLA) - (DC11 01/02/03/04/06 ENG 6150650 SSS - ENG 8021835 SLA) - (DSC12 05/DC12 01/02/09/16 ENG 6150650 SSS - ENG 8021835 SLA) - (DC11 01/02/03/04/06 - DCS12 05 - DC12 - DT12 ENG 6119600 SSS - ENG 8004780 SLA) - (DT12 02/08 L01 ENG 6150649 - 6150650 SSS) - (DC12 03 ENG 6214000 - 6214001 SSS) - DT12 02/08 L02 - DT12 10 - (DC16 ENG 1018724 SSS)		
● 4 BUS			
★	(DSC12 03/05 - DC12 ENG 6102923 - 6107145 SSS - ENG 6109704 - 6150649 SSS - ENG 3138022 - 8021834 SLA) - (DSC12 03/05//DC12/DT12 ENG 5731919 SSS - ENG 5731799 SNL - ENG 5731560 SAN - ENG 3123647 SLA) - (DC11 01/02/03/04/06 ENG 6102922 - 6104628 SSS - ENG 6105126 - 6150649 SSS - ENG 3138022 - 8021834 SLA) - (DC11 01/02/03/04/06 ENG 6150650 SSS - ENG 8021835 SLA) - (DSC12 05/DC12 01/02/09/16 ENG 6150650 SSS - ENG 8021835 SLA) - (DC11 01/02/03/04/06 - DCS12 05 - DC12 - DT12 ENG 6119600 SSS - ENG 8004780 SLA)		
● IND. MARINE ENGINE 4			
★	(DC16A ENG 1018724 SSS) - (DC16A ENG 6500001 - 6513503 SSS) - D12A EMS - D116 48A/53A - (DC16A ENG 1018690 - 1047797 SSS) - (DC16A ENG 1047798 - 1059136 SSS) - (DCS16 ENG 1059137 - 1059142 SSS) - (DC16A ENG 1059143 - 1059238 SSS) - (DC16A ENG 1059239 SSS) - (DC16A ENG 1061165 SSS) - (D12M EMS ENG 6515877 SSS - ENG 8710546 SLA) - D12A EMS - (D16M ENG 6500001 - 6507871 SSS) - (D16M ENG 6507872 - 6510537 SSS) - (D116 48A/53A		

CYLINDER HEAD GASKET SET

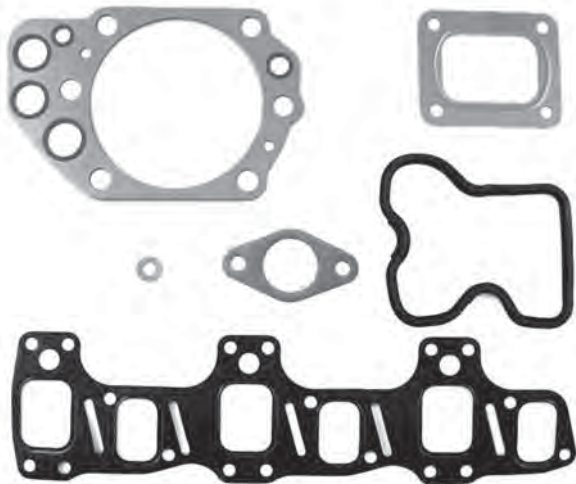

	Code	OEM new	OEM old
	64274	551573	
● 4 TRUCK			
★	DC9 01/ 02/ 03/ 04/ 05/ 06		
● 4 BUS			
★	DC9 01/ 02/ 03/ 04/ 05/ 06		

ALL THE COMPONENTS LISTED IN OUR CATALOGUE ARE NOT ORIGINAL, THOUGH PERFECTLY INTERCHANGEABLE. REFERENCE NUMBERS, EITHER ORIGINAL OR OF A DIFFERENT NATURE, ARE FOR INFORMATION PURPOSES ONLY WHEN PLACING AN ORDER, PLEASE, ALWAYS USE COSIBO REFERENCE NUMBERS AND DO NOT MENTION THE ORIGINAL REFERENCE NUMBERS OF THE TRUCK MANUFACTURERS IN THE INVOICE TO VEHICLE OWNERS OR TO ANYBODY ELSE. THE CUSTOMER TAKES HIS OWN RESPONSIBILITY IF HE DOES NOT COMPLY WITH WHAT ABOVE.

CYLINDER HEAD GASKET SET

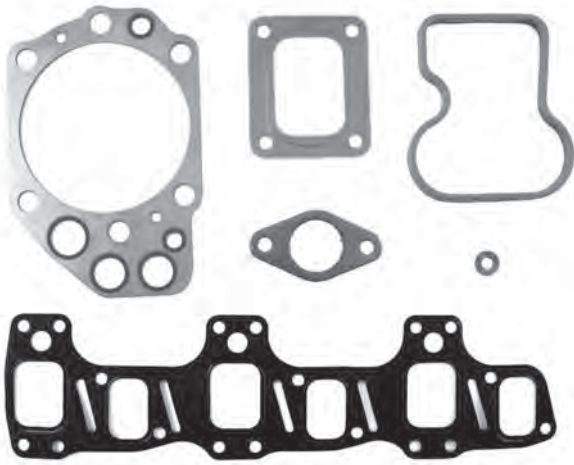

	Code	OEM new	OEM old
● Model	64275	551570	550270
★ Application			
● 4 TRUCK			
★ DSC9 - DC9 01/ 02/ 03/ 04/ 05/ 06 - OSC9 - DSI9			
● 4 BUS			
★ DSC9 - DC9 01/ 02/ 03/ 04/ 05/ 06 - OSC9 - DSI9 - DSC9 F94 - K/ L/ N94 - DSI9 E01 N94			
● IND. MARINE ENGINE 4			
★ D/ DS9 90/ 92A - DC/ DSC9 46/ 47/ 49/ 50/ 51A - DI/ DSI9 48/ 41/ 53A - DC9 51/ 53/ 54/ 55A - DI9 56A - DC9 M - D9 A/ M - SG9 A280			

CYLINDER HEAD GASKET SET

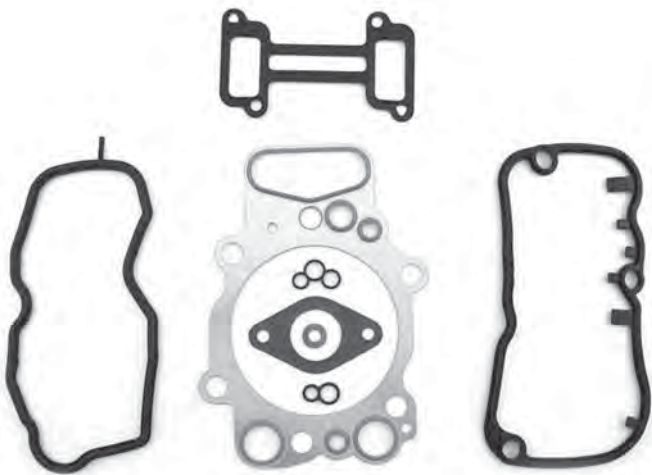

	64306	1725112	
● 4 TRUCK			
★ DC9 19/ 20/ 21 - DC16			
● P-G-R-T TRUCK			
★ PDE HPI - D11 - D12 - D9 PDE - D9 - D16			
● 4 BUS			
★ DC9 19/ 20/ 21			
● IND. MARINE ENGINE 4			
★ SG12A - DC16A - D12M EMS - D16M			
● IND. MARINE ENGINE 5			
★ SG9 A280 - DC9A EMS			
● F-K-N BUS			
★ PDE HPI - D11 - D12 - D9 PDE - D9 - D16			

ALL THE COMPONENTS LISTED IN OUR CATALOGUE ARE NOT ORIGINAL, THOUGH PERFECTLY INTERCHANGEABLE. REFERENCE NUMBERS, EITHER ORIGINAL OR OF A DIFFERENT NATURE, ARE FOR INFORMATION PURPOSES ONLY WHEN PLACING AN ORDER, PLEASE, ALWAYS USE COSIBO REFERENCE NUMBERS AND DO NOT MENTION THE ORIGINAL REFERENCE NUMBERS OF THE TRUCK MANUFACTURERS IN THE INVOICE TO VEHICLE OWNERS OR TO ANYBODY ELSE. THE CUSTOMER TAKES HIS OWN RESPONSIBILITY IF HE DOES NOT COMPLY WITH WHAT ABOVE.

CYLINDER HEAD GASKET SET

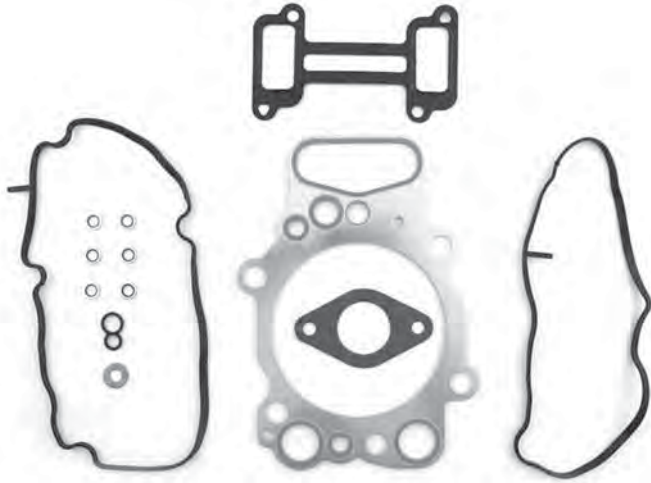

● Model

★ Application

Code

OEM new

OEM old

65340

1765974

● 4 TRUCK

★ (DSC12 01/ 02 - DC11 07 ENG 6150649 - ENG 8021834) - (DSC12 01/ 02 - DC11 07 ENG 6150650 - ENG 8021835) - (DSC12 01/ 02 - DC11 07 ENG 5719205) - (DSC12 01/ 02 - DC11 07 ENG 6119600 - ENG 8004780)

● 4 BUS

★ (DSC12 01/ 02 - DC11 07 ENG 6150649 - ENG 8021834) - (DSC12 01/ 02 - DC11 07 ENG 6150650 - ENG 8021835) - (DSC12 01/ 02 - DC11 07 ENG 5719205) - (DSC12 01/ 02 - DC11 07 ENG 6119600 - ENG 8004780)

● IND. MARINE ENGINE 4

★ D12A/ M AFTER YEAR 2000

	Code	OEM new	OEM old
ENGINE GASKET SET	60362	551370	
<ul style="list-style-type: none"> ● Model ★ Application 			
<ul style="list-style-type: none"> ● 4 TRUCK ★ DSC14 13/ 15 			

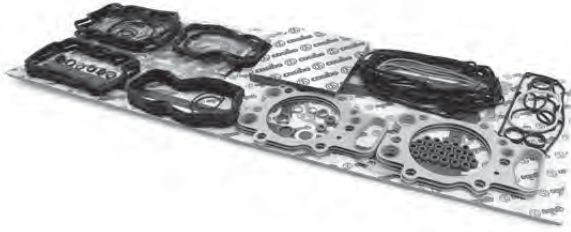

ENGINE GASKET SET	60575	551516	551457 551459
<ul style="list-style-type: none"> ● 3 BUS ★ K 113 ENG DS1173B01 - DSC1113B01 - DSC1116B01 			
<ul style="list-style-type: none"> ● 3 TRUCK ★ CH 5307760 CH 3075634 CH 4070104 			



ENGINE GASKET SET	64749	551520	551505
<ul style="list-style-type: none"> ● 3 BUS ★ 			

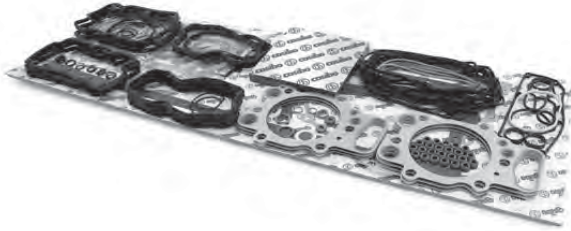

ENGINE GASKET SET	60576	551470	
<ul style="list-style-type: none"> ● 3 TRUCK ★ 			



ALL THE COMPONENTS LISTED IN OUR CATALOGUE ARE NOT ORIGINAL, THOUGH PERFECTLY INTERCHANGEABLE. REFERENCE NUMBERS, EITHER ORIGINAL OR OF A DIFFERENT NATURE, ARE FOR INFORMATION PURPOSES ONLY WHEN PLACING AN ORDER, PLEASE, ALWAYS USE COSIBO REFERENCE NUMBERS AND DO NOT MENTION THE ORIGINAL REFERENCE NUMBERS OF THE TRUCK MANUFACTURERS IN THE INVOICE TO VEHICLE OWNERS OR TO ANYBODY ELSE. THE CUSTOMER TAKES HIS OWN RESPONSIBILITY IF HE DOES NOT COMPLY WITH WHAT ABOVE.

	Code	OEM new	OEM old
ENGINE GASKET SET	60971	551449	
<ul style="list-style-type: none"> ● Model ★ Application 			
<ul style="list-style-type: none"> ● 3 BUS ★ 			
<ul style="list-style-type: none"> ● 3 TRUCK ★ 			

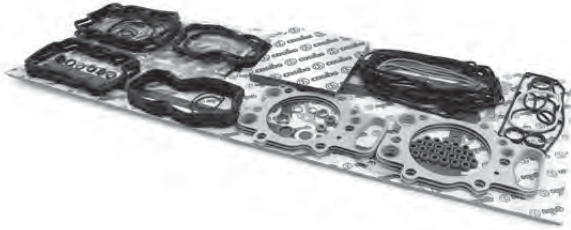

ENGINE GASKET SET	61829	551519	551504
<ul style="list-style-type: none"> ● 3 BUS ★ K113 ENG DS 1173B01 - ENG DSC 1113B01 - ENG DSC 1116B01 - D11 			
<ul style="list-style-type: none"> ● 3 TRUCK ★ ENG 5307761 ENG 3075635 ENG 4070105 			



ENGINE GASKET SET	63558	551356	
<ul style="list-style-type: none"> ● 4 BUS ★ DSC12 01/ 02/ 03/ 05 - DC11 01/ 02/ 03/ 04/ 06/ 07 - DC12 - DT12 - D12 			
<ul style="list-style-type: none"> ● 4 TRUCK ★ DSC12 01/ 02/ 03/ 05 - DC11 01/ 02/ 03/ 04/ 06/ 07 - DC12 - DT12 - D12 - D12 CP/ CR/ CT - DC11/ D12 ED120 22/ 37 			

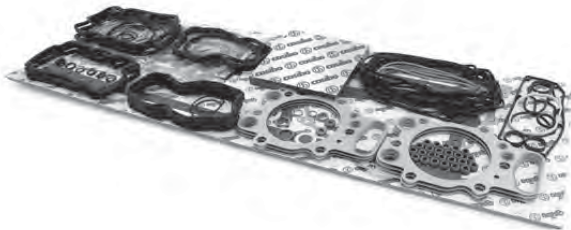

ENGINE GASKET SET	64273	551560	551526
<ul style="list-style-type: none"> ● 4 BUS ★ DSC9 - DC9 01/ 02/ 03/ 04/ 05/ 06 - DS19 E01 - OSC9 G01 - SC9 F94 - K/ L/ N94 - DS19 E01 N94 - D9 - K94 			
<ul style="list-style-type: none"> ● IND. MARINE ENGINE 4 ★ SG9 A280 			
<ul style="list-style-type: none"> ● 4 TRUCK ★ DSC9 - DC9 01/ 02/ 03/ 04/ 05/ 06 - DS19 E01 - OSC9 G01 - CP 19F FRONTLINE 			



ALL THE COMPONENTS LISTED IN OUR CATALOGUE ARE NOT ORIGINAL, THOUGH PERFECTLY INTERCHANGEABLE. REFERENCE NUMBERS, EITHER ORIGINAL OR OF A DIFFERENT NATURE, ARE FOR INFORMATION PURPOSES ONLY WHEN PLACING AN ORDER, PLEASE, ALWAYS USE COSIBO REFERENCE NUMBERS AND DO NOT MENTION THE ORIGINAL REFERENCE NUMBERS OF THE TRUCK MANUFACTURERS IN THE INVOICE TO VEHICLE OWNERS OR TO ANYBODY ELSE. THE CUSTOMER TAKES HIS OWN RESPONSIBILITY IF HE DOES NOT COMPLY WITH WHAT ABOVE.

	Code	OEM new	OEM old
ENGINE GASKET SET	64750	1849922	
<ul style="list-style-type: none"> ● Model ★ Application 			
<ul style="list-style-type: none"> ● IND. MARINE ENGINE 4 			
<ul style="list-style-type: none"> ★ DI16 48A/53A 			

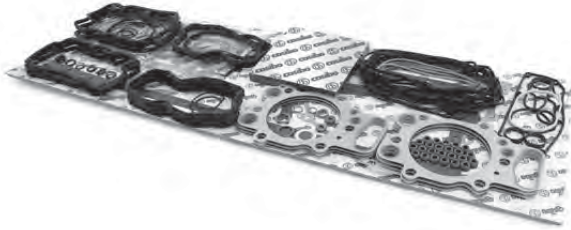

ENGINE GASKET SET	64751	1488658	
<ul style="list-style-type: none"> ● IND. MARINE ENGINE 4 			
<ul style="list-style-type: none"> ★ DI16 40/41A 			



ENGINE GASKET SET	65337	551387	
<ul style="list-style-type: none"> ● IND. MARINE ENGINE 4 			
<ul style="list-style-type: none"> ★ DC16 - DC16 A - DC16 A - SAE B 			
<ul style="list-style-type: none"> ● 4 TRUCK 			
<ul style="list-style-type: none"> ★ DC16 			



ENGINE GASKET SET	65338	551528	
<ul style="list-style-type: none"> ● 4 BUS 			
<ul style="list-style-type: none"> ★ DSC11 - OSC11 G03 			
<ul style="list-style-type: none"> ● 4 TRUCK 			
<ul style="list-style-type: none"> ★ DSC11 - OSC11 G03 - DSC11 74/ 75/ 79 - DSC11/ OSC11 CP/ CR - DSC11 CT 			



ALL THE COMPONENTS LISTED IN OUR CATALOGUE ARE NOT ORIGINAL, THOUGH PERFECTLY INTERCHANGEABLE. REFERENCE NUMBERS, EITHER ORIGINAL OR OF A DIFFERENT NATURE, ARE FOR INFORMATION PURPOSES ONLY WHEN PLACING AN ORDER, PLEASE, ALWAYS USE COSIBO REFERENCE NUMBERS AND DO NOT MENTION THE ORIGINAL REFERENCE NUMBERS OF THE TRUCK MANUFACTURERS IN THE INVOICE TO VEHICLE OWNERS OR TO ANYBODY ELSE. THE CUSTOMER TAKES HIS OWN RESPONSIBILITY IF HE DOES NOT COMPLY WITH WHAT ABOVE.

ENGINE GASKET SET



● Model

★ Application

Code

OEM new

OEM old

65339

551386

● 4 BUS

★ DSC12 01/ 02/ 03/ 05 - DC11 01/ 02/ 03/ 04/ 06/ 07 - DC12 - DT12 - DC12 01/ 02/ 09/ 16 - D12 - DC11

● 4 TRUCK

★ DSC12 01/ 02/ 03/ 05 - DC11 01/ 02/ 03/ 04/ 06/ 07 - DC12 - DT12 - DC12 01/ 02/ 09/ 16 - D12 - DC11 - DT12 02/ 08 L01/ L02 - DC12 03 - DT12 10 - DC11 CP/ CR - DC11/ D12 CP/ CR

O-RING DIAM.26,2X3

60635

197800

392661



● 3 BUS

★ DSC11 04/08/27 - N113

● 3 TRUCK

★

● 4 BUS

★ K94 DC9 19/20/21 - DC9 01/02/03/04/05/06 - DSC9 - K/L/N94 - DSI9 E01 - OSC9 G01 - DSC11 - OSC11 G03

● 4 TRUCK

★ DC9 01/02/03/04/05/06/19/20/21 - DSC11 - OSC11 G03 - DSC9 - DSI9 E01 - OSC9 G01

● F-K-N BUS

★ D9 PDE - D9 XPI

● IND. MARINE ENGINE 5

★ DC9A EMS - SG9 A280

● IND. MARINE ENGINE 4

★ D9M - DC9 51/53/54/55A - DS/DSC14 - DSI14 68/70/72/73/75/74/77/78/79 M40/41 - DSC9/DC9 A/M

● P-G-R-T TRUCK

★ D9 PDE - D9 XPI

		Code	OEM new	OEM old
GASKET	● Model	62490	1368061	
	★ Application			
	● 4 BUS			
	★	DC11/D12 ENG 6119599 SSS - ENG 8004779 SLA - ENG 6119600 SSS - ENG 8004780 SLA - DC9 19/20/21 ENG 6281664 SSS - ENG 8066509 SLA - ENG 6281665 SSS - ENG 8066510 SLA - DC11 01/02/03/04/06 - DSC12 03/05 - DC12 - DT12 ENG 6119599 SSS - ENG 8004779 SLA - ENG 6119600 SSS - ENG 8004780 SLA - DSC12 01/02 - DC11 07 ENG 5740732 - 6119599 SSS - ENG 3125406 - 8004779 SLA - ENG 6119600 SSS - ENG 8004780 SLA - ENG 6173205 SSS - ENG 8016535 SLA - DSC12 03/05 ENG 6173205 SSS - ENG 8016535 SLA - DSC12 02 - D11/D12 PDE ENG 6217072 - 6290341 SSS - ENG 8031704 - 8066511 SLA - ENG 6290342 SSS - ENG 8066512 SLA - K114/124 ENG 6173206 - 6217071 SSS - ENG 8016536 - 8031704 SLA - DC11 01/02/03/04/06 ENG 6173205 SSS - ENG 8016535 SLA		
	● F-K-N BUS			
	★	D9 - D11 - D12 - 16 - D11/ D12 PDE - F.D9 - K.D9 - N.D9 - N.D9.UD		
	● IND. MARINE ENGINE 4			
	★	D12A/M ENG 6119599 SSS - ENG 8004779 SLA - D12M EMS ENG 6515877 SSS - ENG 8710546 SLA - ENG 6515878 SSS - ENG 8710547 SLA - ENG 6511717 SSS - ENG 6511718 SSS - D12A EMS ENG 6509333 - 6514807 SSS - ENG 8709241 SLA - ENG 6514808 SSS - ENG 8709242 SLA - ENG 6509332 SSS - DC16 - DC16A ENG 6500001 - 6513503 SSS - ENG 1018690 - 1018724 SSS - ENG 1018725 SSS - D16M ENG 6500001 - 6507871 SSS - ENG 6507872 - 6510537 SSS - ENG 6510538 - 6513510 SSS - ENG 1039758 SSS - DI16 40/41A/45M/48A/53A - DI12 40/41/42/43/44/45M/46A/49A/50/51/52A - DC12 40/41/42/46/47/48A 57A - DI12 68M STD RH/LH - DSC12 40 - 41/A - DSI12 40A - D16A ENG 6500001 - 6513503 SSS - ENG 1012035 SSS - ENG 1012036 SSS -		
	● IND. MARINE ENGINE 5			
	★	DC9A EMS		
● 4 TRUCK				
★	DC11/D12 ENG 6119599 SSS - ENG 8004779 SLA - ENG 6119600 SSS - ENG 8004780 SLA - ENG 6242516 SSS - ENG 8044475 SLA - DC9 19/20/21 ENG 6280449 SSS - ENG 8066948 SLA - ENG 6280450 SSS - ENG 8066949 SLA - DC11 01/02/03/04/06 - DSC12 03/05 - DC12 - DT12 ENG 6119599 SSS - ENG 8004779 SLA - ENG 6119600 SSS - ENG 8004780 SLA - DSC12 01/02 - DC11 07 ENG 5740732 - 6119599 SSS - ENG 3125406 - 8004779 SLA - ENG 6119600 SSS - ENG 8004780 SLA - ENG 6173205 SSS - ENG 8016535 SLA - DSC12 03/05 ENG 6173205 SSS - ENG 8016535 SLA - ENG 6173206 - 6217071 SSS - ENG 8016536 - 8031703 SLA - DC16 ENG 1018724 SSS - ENG 1018725 SSS - DSC12 01 - DSC12 02 ENG 5707810 SSS - DC16 01/02 ENG 1012035 SSS - ENG 1012036 SSS - D11/D12 PDE ENG 6217072 - 6242515 SSS - ENG 8031704 - 8044474 SLA - DC12 01/02 ENG 6173206 - 6217071 SSS - ENG 8016536 - 8031703 SLA - DC11 01/02/03/04/06 ENG 6173206 - 6217071 SSS - ENG 8016536 - 8031703 SLA - ENG 6173205 SSS - ENG 8016535 SLA			
● P-G-R-T TRUCK				
★	D9 - D11 - D12 - 16 - DC9 11/ 12/ 13 PDE - DC9 16/ 17/ 18 PDE - DC 1108 L01 - DC 1109 - 4X4/ 6X6 - DC11 08 L02 - DC12 06/ 17 PDE - DC16 05/ 06/ 08/ 09/ 17/ 18/ 19 - D16			



		Code	OEM new	OEM old
BUSHING	● Model	63385	131115	
	★ Application			
	● 3 BUS			
	★			
	● 3 TRUCK			
	★	DS11 34/73/75 - DSC11 08/10/12/13/16/17/18/21/22/23/30/35/36/39/70 - DN11 01 - DTC11 01/02		
● 4 TRUCK				
★	DSC11 - OSC11 G03			
● IND. MARINE ENGINE 4				
★				



		63386	157274	
BUSHING	● 3 BUS			
	★			
	● 3 TRUCK			
	★	DS11 34/73/75 - DSC11 08/10/12/13/16/17/18/21/22/23/30/35/36/39/70 - DN11 01 - DTC11 01/02		
	● 4 TRUCK			
	★	DSC11 - OSC11 G03		
● IND. MARINE ENGINE 4				
★				



		63387	131455	
BUSHING	● 3 BUS			
	★			
	● IND. MARINE ENGINE 4			
	★			
	● 3 TRUCK			
	★	DS11 34/73/75 - DSC11 08/10/12/13/16/17/18/21/22/23/30/35/36/39/70 - DN11 01 - DTC11 01/02		
● 4 TRUCK				
★	DSC11 - OSC11 G03			



ALL THE COMPONENTS LISTED IN OUR CATALOGUE ARE NOT ORIGINAL, THOUGH PERFECTLY INTERCHANGEABLE. REFERENCE NUMBERS, EITHER ORIGINAL OR OF A DIFFERENT NATURE, ARE FOR INFORMATION PURPOSES ONLY WHEN PLACING AN ORDER, PLEASE, ALWAYS USE COSIBO REFERENCE NUMBERS AND DO NOT MENTION THE ORIGINAL REFERENCE NUMBERS OF THE TRUCK MANUFACTURERS IN THE INVOICE TO VEHICLE OWNERS OR TO ANYBODY ELSE. THE CUSTOMER TAKES HIS OWN RESPONSIBILITY IF HE DOES NOT COMPLY WITH WHAT ABOVE.

		Code	OEM new	OEM old
CONN. ROD BUSHING	● Model	63372	1304292	
	★ Application			
	● 3 BUS			
	★			
	● IND. MARINE ENGINE 4			
	★			
	● 3 TRUCK			
	★ DS/ DSC11 - DTC11			
	● 4 TRUCK			
	★ DS11 - DSC14 13/ 15 - OSC11 G03			



		Code	OEM new	OEM old
CONN. ROD BUSHING		63416	1320973	
	● 3 BUS			
	★			
	● 4 BUS			
	★ DSC9 - DC9 01/ 02/ 03/ 04/ 05/ 06 - K/ L/ N94 - DSC9 - DS19 E01 - DC9 - OSC9 G01 - DSC9 K94			
	● IND. MARINE ENGINE 4			
	★ SG9 A280 - D9A/ M			
	● 3 TRUCK			
	★			
● 4 TRUCK				
★ DSC9 - DC9 01/ 02/ 03/ 04/ 05/ 06				



	Code	OEM new	OEM old
CONN. ROD BUSHING	63550	1440359	1339877 1437123
● Model			
★ Application			
● 4 BUS			
★ DC9 19/ 20/ 21 - D11 - D12 - K114/ 124			
● F-K-N BUS			
★ D11/D12 ENG 6302553 - ENG 8103229 - ENG 6302554 - ENG 8103230 - D9 PDE ENG 6299926 - ENG 8103229 - ENG 6299927 - ENG 8103230 - DC9 19/20/21 ENG 8103230 - D9 PDE K/N ENG 6299926 - ENG 8103229 - ENG 6299927 - ENG 8103230 - D12 K ENG 6302553 - ENG 8103229 - ENG 6302554 - ENG 8103230			
● IND. MARINE ENGINE 4			
★ DI12 68M - D12M EMS - DI12 49A - DC12 57A - DC16A - DI16 40/ 41A/ 48A/ 53A - D16M			
● IND. MARINE ENGINE 5			
★ SG9 A280 - DC9A EMS ENG 6299926 - ENG 6299927 - ENG 8103229 - ENG 8103230 - DC9A EMS.CLARK 15"/17" ENG 8103230 - ENG 6299926 - ENG 6299927 - ENG 8103229 - DC9A EMS.SAE 11.5"/14" ENG 6299926 - ENG 6299927 - ENG 8103229 - ENG 8103230			
● 4 TRUCK			
★ DC9 19/ 20/ 21 - D11 - DSC12 01/ 02 - DSC12 03/ 05 - DC12 - DT12 - DC16			
● P-G-R-T TRUCK			
★ D11/ D12 - D9 PDE - D16			



PISTON RING SET



	63708	550247	
● 3 BUS			
★ DS/DSC11 - DS11 34/74/75/78 - DSC11 04/08/18/21/22/23/35/36/70/71 - DSI1 E01			
● 3 TRUCK			
★ DN/DS/DSC11 - DSC14 - DSC11 08/10/21/22/23/35/36/70 - DS11 75 - DTC11 01/02			
● 4 TRUCK			
★ DSC11			

ALL THE COMPONENTS LISTED IN OUR CATALOGUE ARE NOT ORIGINAL, THOUGH PERFECTLY INTERCHANGEABLE. REFERENCE NUMBERS, EITHER ORIGINAL OR OF A DIFFERENT NATURE, ARE FOR INFORMATION PURPOSES ONLY WHEN PLACING AN ORDER, PLEASE, ALWAYS USE COSIBO REFERENCE NUMBERS AND DO NOT MENTION THE ORIGINAL REFERENCE NUMBERS OF THE TRUCK MANUFACTURERS IN THE INVOICE TO VEHICLE OWNERS OR TO ANYBODY ELSE. THE CUSTOMER TAKES HIS OWN RESPONSIBILITY IF HE DOES NOT COMPLY WITH WHAT ABOVE.

		Code	OEM new	OEM old
CONN. ROD SCREW	● Model	61199	1100867	170132
	★ Application			
	● 3 BUS			
	★			
	● 4 BUS			
	★	DSC9/ DC9 01/ 02/ 03/ 04/ 05/ 06 - DC9 19/ 20/ 21 - D11 - K/ L/ N94 - DSC9 - DSI9 E01 - DC9 - OSC9 G01 - DSC9 K94		
	● F-K-N BUS			
	★	D11 - D12 - D9 PDE K/ N - D12K		
	● IND. MARINE ENGINE 4			
	★	D112 68M - D12M EMS - DI12 49A - DC12 57A - D12M EMS - SG9 A280 - D9A/ M		
	● IND. MARINE ENGINE 5			
	★	DC9A EMS - DC9A EMS.CLARK 15"/ 17" - DC9A EMS.SAE 11.5"/ 14"		
● 3 TRUCK				
★	DS/ DSC11 - DTC11			
● 4 TRUCK				
★	DSC9/ DC9 01/ 02/ 03/ 04/ 05/ 06 - DC9 19/ 20/ 21 - DSC11 - DSC12 01/ 02 - DSC12 03/ 05 - DC12 - DT12 - DSC14 13/ 15 - OSC11 G03			
● P-G-R-T TRUCK				
★	D11/ D12 - D9 PDE			



SEAL RING		64103	1871043	1376911
	● 4 BUS			
	★	DC11/D12 - DC11 07 - DSC12 02		
● IND. MARINE ENGINE 4				
★	SGI 12A - DC16A - D16M - D12A/D12M EMS - DC9 EMS - DI12 41/42/43/44/45/57M - DSC12 40/42A - DC12 40/42A			
● 4 TRUCK				
★	DSC12 01/02 - DC11/D12 - DC11 07			



FILTER REPAIR KIT



- Model
- ★ Application

Code

OEM new

OEM old

63994

561991

- 4 TRUCK

- ★ D16

- P-G-R-T TRUCK

- ★ D16

REPAIR KIT



64748

64748

- 4 TRUCK

- ★ D16 --- COMPOSED BY: NO.1 PC 61193 - NO.1 PC 61194 - NO.1 PC 65313 - NO.1 PC 61902

- P-G-R-T TRUCK

- ★ D16 --- COMPOSED BY: NO.1 PC 61193 - NO.1 PC 61194 - NO.1 PC 65313 - NO.1 PC 61902

OIL FILTER GASKET



64197

1466382

1456041

- 4 TRUCK

- ★ DC16

- IND. MARINE ENGINE 4

- ★ D16A/M - DC16A - D116 48/53/A

- P-G-R-T TRUCK

- ★ D16

ALL THE COMPONENTS LISTED IN OUR CATALOGUE ARE NOT ORIGINAL, THOUGH PERFECTLY INTERCHANGEABLE. REFERENCE NUMBERS, EITHER ORIGINAL OR OF A DIFFERENT NATURE, ARE FOR INFORMATION PURPOSES ONLY WHEN PLACING AN ORDER, PLEASE, ALWAYS USE COSIBO REFERENCE NUMBERS AND DO NOT MENTION THE ORIGINAL REFERENCE NUMBERS OF THE TRUCK MANUFACTURERS IN THE INVOICE TO VEHICLE OWNERS OR TO ANYBODY ELSE. THE CUSTOMER TAKES HIS OWN RESPONSIBILITY IF HE DOES NOT COMPLY WITH WHAT ABOVE.

	Code	OEM new	OEM old
FILTER	64145	1539675	
● Model			
★ Application			
● 4 TRUCK			
★ DC9 19/20/21			
● F-K.N BUS			
★ F			
● IND. MARINE ENGINE 4			
★ DC12 57A			
● IND. MARINE ENGINE 5			
★ DC9A EMS			
● P-G-R-T TRUCK			
★ D11 - DC12 - DT12 - D9 PDE			



	61731	285248	
RUBBER BUFFER			
● 3 TRUCK			
★ CR19 - STREAMLINE			
● IND. MARINE ENGINE 4			
★ D9/D11 - D12A/M - D14A/M - D16M - DC16			
● IND. MARINE ENGINE 5			
★ DC9A EMS			



	66581/1	488372	
RUBBER SLEEVE			
● 4 BUS			
★ K 94/114/124 - DC9 19/20/21 - F94 LHD			
● F-K-N BUS			
★ K/N - NUD - CNUD			
● IND. MARINE ENGINE 5			
★ SG9 A280			



ALL THE COMPONENTS LISTED IN OUR CATALOGUE ARE NOT ORIGINAL, THOUGH PERFECTLY INTERCHANGEABLE. REFERENCE NUMBERS, EITHER ORIGINAL OR OF A DIFFERENT NATURE, ARE FOR INFORMATION PURPOSES ONLY WHEN PLACING AN ORDER, PLEASE, ALWAYS USE COSIBO REFERENCE NUMBERS AND DO NOT MENTION THE ORIGINAL REFERENCE NUMBERS OF THE TRUCK MANUFACTURERS IN THE INVOICE TO VEHICLE OWNERS OR TO ANYBODY ELSE. THE CUSTOMER TAKES HIS OWN RESPONSIBILITY IF HE DOES NOT COMPLY WITH WHAT ABOVE.

	Code	OEM new	OEM old
RUBBER BUFFER	62214	295297	
<ul style="list-style-type: none"> ● Model ★ Application 			
<ul style="list-style-type: none"> ● 3 TRUCK ★ CR19 			





BOOT	62215	338395	
<ul style="list-style-type: none"> ● 3 TRUCK ★ CR19 			



RUBBER SLEEVE	62216	352543	
<ul style="list-style-type: none"> ● 3 TRUCK ★ LHD/RHD 4X2 6X2 6X4 - DS/DSC11 CH 1154400 - CH 4286035 			



	Code	OEM new	OEM old
RUBBER SLEEVE	62217	1307953	
	<ul style="list-style-type: none"> ● Model ★ Application 		
	<ul style="list-style-type: none"> ● 3 BUS ★ DSC11 21/22/23/24/35/36/70/71/81 - OSC11 G01 		
	<ul style="list-style-type: none"> ● 3 TRUCK ★ DSC11 21/22/23/30/35/36/39/70 - DS - DTC11 		
	<ul style="list-style-type: none"> ● IND. MARINE ENGINE 4 ★ DI12 41M - DSI11 73/76/77/78/79/80/81 - DSC9/DC9 47 A04S - DS/DSC11 - D16M 		

RUBBER SLEEVE	62218	1108488	
	<ul style="list-style-type: none"> ● 3 BUS ★ DS11 34 - DSC11 08/17/18 		
	<ul style="list-style-type: none"> ● 3 TRUCK ★ DS11 34/75 - DSC11 08/10/17/18/21/23/35/36 - 6X4 CH 1154401 - CH 4286036 		
	<ul style="list-style-type: none"> ● IND. MARINE ENGINE 4 ★ DS11 		

ALL THE COMPONENTS LISTED IN OUR CATALOGUE ARE NOT ORIGINAL, THOUGH PERFECTLY INTERCHANGEABLE. REFERENCE NUMBERS, EITHER ORIGINAL OR OF A DIFFERENT NATURE, ARE FOR INFORMATION PURPOSES ONLY WHEN PLACING AN ORDER, PLEASE, ALWAYS USE COSIBO REFERENCE NUMBERS AND DO NOT MENTION THE ORIGINAL REFERENCE NUMBERS OF THE TRUCK MANUFACTURERS IN THE INVOICE TO VEHICLE OWNERS OR TO ANYBODY ELSE. THE CUSTOMER TAKES HIS OWN RESPONSIBILITY IF HE DOES NOT COMPLY WITH WHAT ABOVE.

		Code	OEM new	OEM old
O-RING	● Model	61630	323662	
	★ Application			
	● 3 BUS			
	★	DS9 05/08		
	● 4 BUS			
	★	DSC9 - OSC9 - DS19 - DC9 01/02/03/04/05/06 - DS19 E01 - OSC9 G01 - D9		
	● IND. MARINE ENGINE 4			
	★	SG9 A280 - D9 A/M - DSC9 - DC9 01/02/03/04/05/06		
	● 3 TRUCK			
	★	DS/DSC9 - DN/DS/DSC9		
● 4 TRUCK				
★	DSC9 - OSC9 - DS19 - DC9 01/02/03/04/05/06 - DS19 E01 - OSC9 G01			



		61631	1302828	342989
SEAL RING	● 3 BUS			
	★	DS11 34/74/75/78 - DSC11 04/08/21/22/23/24/27/35/36/70/71/81 - DS/DSC/OSC11 -		
	● 4 BUS			
	★	OSC11 G03 - DSC11 - DSI11 E01		
	● IND. MARINE ENGINE 4			
	★	D14A/M - DS/DSC/DSI 11A - DS11 98/99 - DSI11 73/74/75/76/77/78/79/80/81		
	● 3 TRUCK			
	★	DS11 34/73/75 - DSC11 08/10/12/13/16/17/18/21/22/23/30/35/36/39/70 - DN11 01 - DSC14 - DTC11 01/02		
	● 4 TRUCK			
	★	DSC14 13/15 - DSC11 - OSC11 G03		

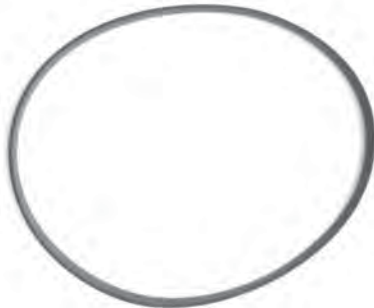

	Code	OEM new	OEM old
SEAL RING	61837	1302827	362408
● Model			
★ Application			
● 3 BUS			
★ DS9 05/08			
● 4 BUS			
★ DSC9 - DC9 01/02/03/04/05/06 - DS19 E01 - OSC9 G01 - D9			
● IND. MARINE ENGINE 4			
★ SG9 A280 - D9 A/M - DSC9 - DC9 01/02/03/04/05/06			
● 3 TRUCK			
★ DN/DS/DSC9			
● 4 TRUCK			
★ DSC9 - DC9 01/02/03/04/05/06 - DS19 E01 - OSC9 G01			



	61632	1312934	323641
O-RING			
● 3 BUS			
★ DSC11 - OSC11 - DS11 34/74/75/78 - DSC11 04/08/17/18/21/22/23/24/27/35/36/70/71/81 - DS11 E01			
● 4 BUS			
★ DSC11 - OSC11 G03			
● IND. MARINE ENGINE 4			
★ D14A/M - DS/DSC/DSI 11A - DS11 98/99 - DSI11 73/74/75/76/77/78/79/80/81			
● 3 TRUCK			
★ DN/DS/DSC11 - DS11 34/73/75 - DSC11 08/10/12/13/16/17/18/21/22/23/30/35/36/39/70 - DN11 01 - DTC11 01/02			
● 4 TRUCK			
★ DSC - DSC11 - DSC14 13/15 - OSC11 G03			

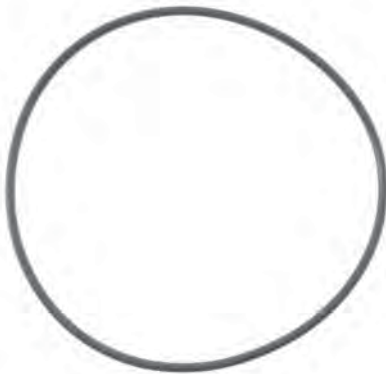

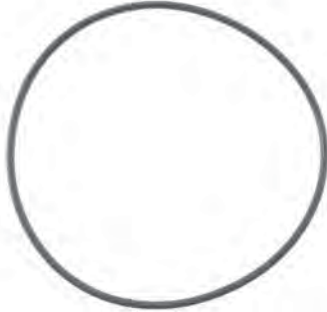

		Code	OEM new	OEM old
O-RING	● Model	63388	323451	
	★ Application			
	● 3 BUS			
	★			
	● 4 BUS			
	★	DSC11 - OSC11 G03 OK		
	● IND. MARINE ENGINE 4			
	★	OK		
	● 3 TRUCK			
	★			
● 4 TRUCK				
★	DSC11 - OSC11 G03 OK			



O-RING		63548	1862376	1317682 1433063
	● 4 BUS			
	★	DC11 - D12 - DC9 19/20/21		
	● F-K-N BUS			
	★	D9 - D11 - D12 - D9 PDE		
	● IND. MARINE ENGINE 4			
	★	D12M EMS - DI12 41/42/43/44/45/57/68M - DC12 41/42/45/46/47/48/50/52/53/54/55/56/57/58/59/60A - D12A EMS - D12/16M - DC16 A - DI16 48/53A - DC16 - DI12 46/49/50/51/52/54/56A - DSC12 41A - DSC/DSI/DC/DI12 40A		
	● IND. MARINE ENGINE 5			
	★	DC9A EMS		
	● 4 TRUCK			
★	DC16 - D12 - DC9 19/20/21 - DC11			
● P-G-R-T TRUCK				
★	D9 - D11 - D12 - D16 - D9 PDE			



		Code	OEM new	OEM old
O-RING 	● Model	63549	1328995	
	★ Application			
	● 4 BUS			
	★ DC11 - D12 - DC9 19/20/21			
	● F-K-N BUS			
	★ D9 - D11 - D12 - D9 PDE			
	● IND. MARINE ENGINE 4			
	★ D12M EMS - DI12 41/42/43/44/45/57/68M - DC12 41/42/45/46/47/48/50/52/53/54/55/56/57/58/59/60A - D12A EMS - D12/16M - DC16 A - DI16 48A/53A - DC16 - DI12 46/49/50/51/52/54/56A - DSC12 41A - DSC/DSI/DC/DI12 40A			
	● IND. MARINE ENGINE 5			
	★ DC9A EMS			
● 4 TRUCK				
★ DC16 - D12 - DC9 19/20/21 - DC11				
● P-G-R-T TRUCK				
★ D9 - D11 - D12 - D16 - D9 PDE				

		63554	1484765	1352885
O-RING 	● 4 BUS			
	★ DC9 19/20/21 - DC11 - D12			
	● F-K-N BUS			
	★ D9 PDE - D11 - D12 - D9 XPI			
	● IND. MARINE ENGINE 4			
	★ D12 A/M - DI12 68/69M - DC16 A - DI16 48/53A - D16 M - DC16			
	● IND. MARINE ENGINE 5			
	★ DC9 A EMS - SG9 A280			
	● 4 TRUCK			
	★ DC16 - D12 - DC9 19/20/21 - DC11			
● P-G-R-T TRUCK				
★ D9 PDE - D11 - D12 - D9 XPI - D16 - D13				

ALL THE COMPONENTS LISTED IN OUR CATALOGUE ARE NOT ORIGINAL, THOUGH PERFECTLY INTERCHANGEABLE. REFERENCE NUMBERS, EITHER ORIGINAL OR OF A DIFFERENT NATURE, ARE FOR INFORMATION PURPOSES ONLY WHEN PLACING AN ORDER, PLEASE, ALWAYS USE COSIBO REFERENCE NUMBERS AND DO NOT MENTION THE ORIGINAL REFERENCE NUMBERS OF THE TRUCK MANUFACTURERS IN THE INVOICE TO VEHICLE OWNERS OR TO ANYBODY ELSE. THE CUSTOMER TAKES HIS OWN RESPONSIBILITY IF HE DOES NOT COMPLY WITH WHAT ABOVE.

		Code	OEM new	OEM old
O-RING	● Model	63555	1484766	1352866
	★ Application			
	● 4 BUS			
	★	DC9 19/20/21 - DC11 - D12		
	● F-K-N BUS			
	★	D9 PDE - D11 - D12 - D9 XPI		
	● IND. MARINE ENGINE 4			
	★	D12 A/M - DI12 68/69M - D16A - DI16 48/53A - D16 M - DC16		
	● IND. MARINE ENGINE 5			
	★	DC9 EMS - SG9 A280		
	● 4 TRUCK			
	★	DC16 - D12 - DC9 19/20/21 - DC11		
● P-G-R-T TRUCK				
★	D9 PDE - D11 - D12 - D9 XPI - D16 - D13			



		61762	1388684	371492
GASKET	● 3 BUS			
	★			
	● 4 BUS			
	★	DSC11 - OSC11 G03		
	● IND. MARINE ENGINE 4			
	★			
	● 3 TRUCK			
	★			
	● 4 TRUCK			
	★	DSC11 - OSC11 G03		

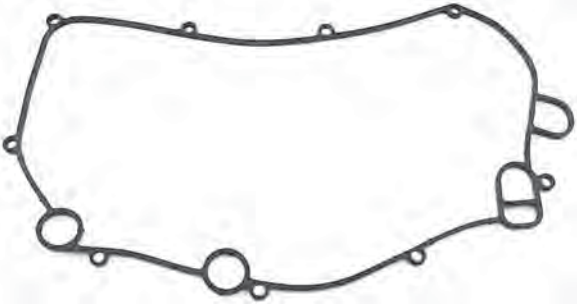

		Code	OEM new	OEM old
GASKET	● Model	63559	1349497	
	★ Application			
	● 4 BUS			
	★ D12 - DC11			
	● IND. MARINE ENGINE 4			
	★ D12 A/M			
	● 4 TRUCK			
	★ D12 - DC11			

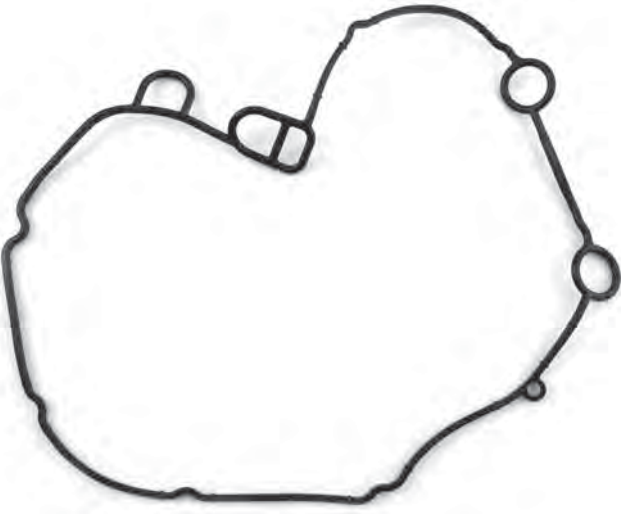
		64137	1502798	1433886
GASKET	● 4 BUS			
	★ DC9 19/20/21 - DC11/D12			
	● F-K-N BUS			
	★ D9 PDE - D11 - D12			
	● IND. MARINE ENGINE 4			
	★ D12 A/M - DI12 68/69M			
	● IND. MARINE ENGINE 5			
	★ DC9A EMS - SG9 A280			
	● 4 TRUCK			
	★ DC9 19/20/21 - DC11/D12			
	● P-G-R-T TRUCK			
	★ D9 PDE - D11 - D12			

ALL THE COMPONENTS LISTED IN OUR CATALOGUE ARE NOT ORIGINAL, THOUGH PERFECTLY INTERCHANGEABLE. REFERENCE NUMBERS, EITHER ORIGINAL OR OF A DIFFERENT NATURE, ARE FOR INFORMATION PURPOSES ONLY WHEN PLACING AN ORDER, PLEASE, ALWAYS USE COSIBO REFERENCE NUMBERS AND DO NOT MENTION THE ORIGINAL REFERENCE NUMBERS OF THE TRUCK MANUFACTURERS IN THE INVOICE TO VEHICLE OWNERS OR TO ANYBODY ELSE. THE CUSTOMER TAKES HIS OWN RESPONSIBILITY IF HE DOES NOT COMPLY WITH WHAT ABOVE.

	Code	OEM new	OEM old
VALVE TAPPET (OLD VERSION)	60415	1116635	1103422
● Model			
★ Application			
● 3 BUS			
★ DSC11 04/08/17/18/21/22/23/24/27/35/36/70/71/81 - DS11 34/74/75/78 - DSI11 E01 - OSC11 G01			
● IND. MARINE ENGINE 4			
★			
● 3 TRUCK			
★ DS11 34/73/75 - DSC11 08/10/12/13/16/17/18/21/22/23/30/35/36/39/70 - DN11 01 - DSC14 03/04/06/08/09/10/16 - DTC11 01/02			
● 4 TRUCK			
★ DSC14 13/15 - DSC11 - OSC11 G03			



	Code	OEM new	OEM old
VALVE TAPPET (NEW VERSION)	61187	1522013	1361198 1420836
● Model			
★ Application			
● 3 BUS			
★ DSC11 04/08/17/18/21/22/23/24/27/35/36/70/71/81 - DS11 34/74/75/78 - DSI11 E01 - OSC11 G01			
● IND. MARINE ENGINE 4			
★			
● 3 TRUCK			
★ DS11 34/73/75 - DSC11 08/10/12/13/16/17/18/21/22/23/30/35/36/39/70 - DN11 01 - DSC14 03/04/06/08/09/10/16 - DTC11 01/02			
● 4 TRUCK			
★ DSC14 13/15 - DSC11 - OSC11 G03			



		Code	OEM new	OEM old
GASKET	● Model	64142	1746135	
	★ Application			
	● 4 BUS			
	★ DC9 19/20/21 - DC11/D12			
	● F-K-N BUS			
	★ D9 PDE - D11 - D12			
	● IND. MARINE ENGINE 4			
	★ DI12 68/69M - D12 A/M			
	● IND. MARINE ENGINE 5			
	★ DC9A EMS - SG9 A280			
● 4 TRUCK				
★ DC9 19/20/21 - DC11/D12				
● P-G-R-T TRUCK				
★ D9 PDE - D11 - D12				



		64226	1466383	1423202
GASKET	● 4 TRUCK			
	★ DC16			
	● IND. MARINE ENGINE 4			
	★ DC16 A/M - DC16 - DI16 48/53A			
	● P-G-R-T TRUCK			
	★ D16			



	Code	OEM new	OEM old
GASKET	64232	1509813	1467166
<ul style="list-style-type: none"> ● Model ★ Application 			
<ul style="list-style-type: none"> ● 4 TRUCK 			
<ul style="list-style-type: none"> ★ DC16 			
<ul style="list-style-type: none"> ● IND. MARINE ENGINE 4 			
<ul style="list-style-type: none"> ★ DC16 - DC16 A/M - DI16 48/53A 			
<ul style="list-style-type: none"> ● P-G-R-T TRUCK 			
<ul style="list-style-type: none"> ★ D16 			

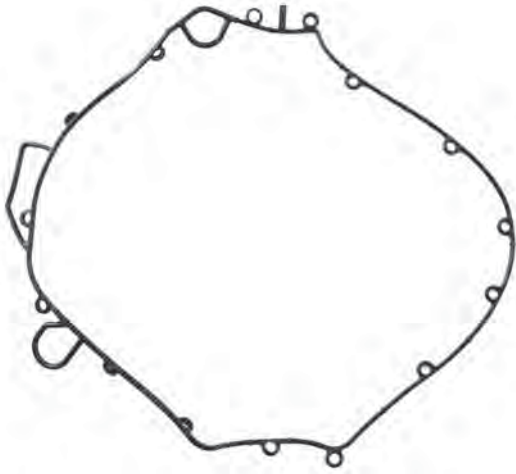

OIL COOLER REPAIR SET	64138	64138	
<ul style="list-style-type: none"> ● 4 BUS 			
<ul style="list-style-type: none"> ★ DC9 19/20/21 - DC11/D12 			
<ul style="list-style-type: none"> ● F-K-N BUS 			
<ul style="list-style-type: none"> ★ D9 PDE - D11 - D12 			
<ul style="list-style-type: none"> ● IND. MARINE ENGINE 4 			
<ul style="list-style-type: none"> ★ D12 A/M - DI12 68/69M 			
<ul style="list-style-type: none"> ● IND. MARINE ENGINE 5 			
<ul style="list-style-type: none"> ★ DC9A EMS - SG9 A280 			
<ul style="list-style-type: none"> ● 4 TRUCK 			
<ul style="list-style-type: none"> ★ DC9 19/20/21 - DC11/D12 			
<ul style="list-style-type: none"> ● P-G-R-T TRUCK 			
<ul style="list-style-type: none"> ★ D9 PDE - D11 - D12 			

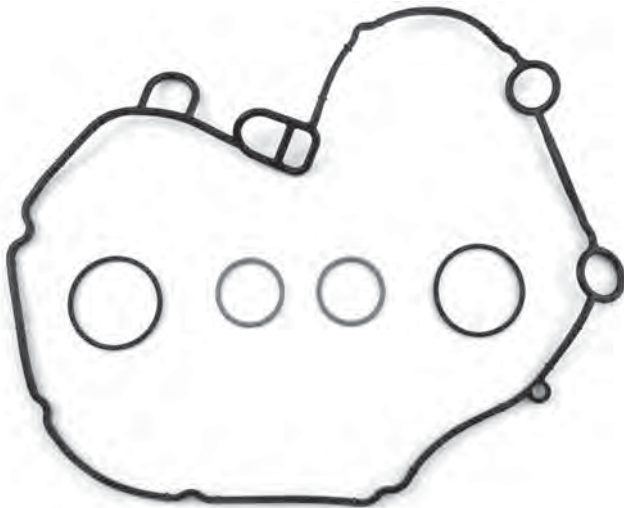

ALL THE COMPONENTS LISTED IN OUR CATALOGUE ARE NOT ORIGINAL, THOUGH PERFECTLY INTERCHANGEABLE. REFERENCE NUMBERS, EITHER ORIGINAL OR OF A DIFFERENT NATURE, ARE FOR INFORMATION PURPOSES ONLY WHEN PLACING AN ORDER, PLEASE, ALWAYS USE COSIBO REFERENCE NUMBERS AND DO NOT MENTION THE ORIGINAL REFERENCE NUMBERS OF THE TRUCK MANUFACTURERS IN THE INVOICE TO VEHICLE OWNERS OR TO ANYBODY ELSE. THE CUSTOMER TAKES HIS OWN RESPONSIBILITY IF HE DOES NOT COMPLY WITH WHAT ABOVE.

OIL COOLER REPAIR SET

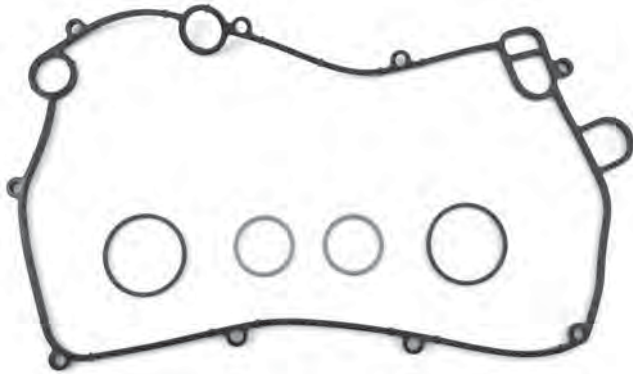

- Model
- ★ Application

Code	OEM new	OEM old
64140	64140	

- 4 BUS
- ★ D12 - DC11 FOR OUR 62519
- IND. MARINE ENGINE 4
- ★ D12 A/M FOR OUR 62519
- 4 TRUCK
- ★ D12 - DC11 FOR OUR 62519

OIL COOLER GASKET KIT



- 3 BUS
- ★ FOR OUR 61759 & 64383
- IND. MARINE ENGINE 4
- ★ FOR OUR 61759 & 64383

64385	64385	
-------	-------	--

- 3 TRUCK
- ★ DS - DSC11 FOR OUR 61759 & 64383
- 4 TRUCK
- ★ DSC11 - OSC11 G03 FOR OUR 61759 & 64383

OIL COOLER GASKET KIT



- 4 TRUCK
- ★ DSC14 13/15 FOR OUR 63952

64386	64386	
-------	-------	--

ALL THE COMPONENTS LISTED IN OUR CATALOGUE ARE NOT ORIGINAL, THOUGH PERFECTLY INTERCHANGEABLE. REFERENCE NUMBERS, EITHER ORIGINAL OR OF A DIFFERENT NATURE, ARE FOR INFORMATION PURPOSES ONLY WHEN PLACING AN ORDER, PLEASE, ALWAYS USE COSIBO REFERENCE NUMBERS AND DO NOT MENTION THE ORIGINAL REFERENCE NUMBERS OF THE TRUCK MANUFACTURERS IN THE INVOICE TO VEHICLE OWNERS OR TO ANYBODY ELSE. THE CUSTOMER TAKES HIS OWN RESPONSIBILITY IF HE DOES NOT COMPLY WITH WHAT ABOVE.

OIL COOLER



- Model
- ★ Application

Code	OEM new	OEM old
61759	1368736	1350909 1362222 1368735 350061

- 3 BUS
- ★
- IND. MARINE ENGINE 4
- ★
- 3 TRUCK
- ★ DS - DSC11

OIL COOLER



Code	OEM new	OEM old
62519	1543688	1333183

- 4 BUS
- ★ DC11 - DC11/D12
- F-K-N BUS
- ★ D9 PDE - D11 - D12 - D9 XPI
- IND. MARINE ENGINE 4
- ★ D12 A/M - DI12 68/69M
- 4 TRUCK
- ★ DC11 - DC11/D12 - DC16
- P-G-R-T TRUCK
- ★ D9 PDE - D11 - D12 - D9 XPI - D16 - D13

ALL THE COMPONENTS LISTED IN OUR CATALOGUE ARE NOT ORIGINAL, THOUGH PERFECTLY INTERCHANGEABLE. REFERENCE NUMBERS, EITHER ORIGINAL OR OF A DIFFERENT NATURE, ARE FOR INFORMATION PURPOSES ONLY WHEN PLACING AN ORDER, PLEASE, ALWAYS USE COSIBO REFERENCE NUMBERS AND DO NOT MENTION THE ORIGINAL REFERENCE NUMBERS OF THE TRUCK MANUFACTURERS IN THE INVOICE TO VEHICLE OWNERS OR TO ANYBODY ELSE. THE CUSTOMER TAKES HIS OWN RESPONSIBILITY IF HE DOES NOT COMPLY WITH WHAT ABOVE.

OIL PUMP



- Model
- ★ Application

Code

OEM new

OEM old

60111

1369981

1318091
301473

- 3 BUS

- ★ ENG 5347666 - ENG 5333759 - ENG 5333760 - DSC1117 ENG 5347666 - ENG 5319702

- IND. MARINE ENGINE 4

★

- 3 TRUCK

- ★ DSC1117: ENG 4082208 - ENG 5319701 - ENG 5319702 - ENG 5333759 - ENG 5333760 - ENG 3154338 - ENG 3154339 - ENG 5347666 - ENG 4089251 - ENG 4089252

- 4 TRUCK

- ★ DSC11 - OSC11 G03

OIL PUMP BUSHING



60016

319110

139110

- 3 BUS

- ★ ENG 5347666 - ENG 5333759 - ENG 5333760 - DSC1117 ENG 5347666 - ENG 5319702

- IND. MARINE ENGINE 4

★

- 3 TRUCK

- ★ DSC1117: ENG 4082208 - ENG 5319701 - ENG 5319702 - ENG 5333759 - ENG 5333760 - ENG 3154338 - ENG 3154339 - ENG 5347666 - ENG 4089251 - ENG 4089252

- 4 TRUCK

- ★ DSC11 - OSC11 G03

		Code	OEM new	OEM old
OIL PUMP GEAR	● Model	60112	154621	
	★ Application			
	● 3 BUS			
	★	ENG 5347666 - ENG 5333759 - ENG 5333760 - DSC1117 ENG 5347666 - ENG 5319702		
	● IND. MARINE ENGINE 4			
	★			
● 3 TRUCK				
★	DSC1117:ENG 4082208 - ENG 5319701 - ENG 5319702 - ENG 5333759 - ENG 5333760 - ENG 3154338 - ENG 3154339 - ENG 5347666 - ENG 4089251 - ENG 4089252			
● 4 TRUCK				
★	DSC11 - OSC11 G03			



		60113	225931	
OIL PUMP GEAR	● 3 BUS			
	★	ENG 5347666 - ENG 5333759 - ENG 5333760 - DSC1117 ENG 5347666 - ENG 5319702		
	● IND. MARINE ENGINE 4			
	★			
	● 3 TRUCK			
	★	DSC1117:ENG 4082208 - ENG 5319701 - ENG 5319702 - ENG 5333759 - ENG 5333760 - ENG 3154338 - ENG 3154339 - ENG 5347666 - ENG 4089251 - ENG 4089252		
● 4 TRUCK				
★	DSC11 - OSC11 G03			



		Code	OEM new	OEM old
OIL PUMP GEAR	● Model	60114	225353	
	★ Application			
	● 3 BUS			
	★	ENG 5347666 - ENG 5333759 - ENG 5333760 - DSC1117 ENG 5347666 - ENG 5319702		
	● IND. MARINE ENGINE 4			
	★			
● 3 TRUCK				
★	DSC1117:ENG 4082208 - ENG 5319701 - ENG 5319702 - ENG 5333759 - ENG 5333760 - ENG 3154338 - ENG 3154339 - ENG 5347666 - ENG 4089251 - ENG 4089252			
● 4 TRUCK				
★	DSC11 - OSC11 G03			



		60115	225354	
OIL PUMP GEAR	● 3 BUS			
	★	ENG 5347666 - ENG 5333759 - ENG 5333760 - DSC1117 ENG 5347666 - ENG 5319702		
	● IND. MARINE ENGINE 4			
	★			
	● 3 TRUCK			
	★	DSC1117:ENG 4082208 - ENG 5319701 - ENG 5319702 - ENG 5333759 - ENG 5333760 - ENG 3154338 - ENG 3154339 - ENG 5347666 - ENG 4089251 - ENG 4089252		
● 4 TRUCK				
★	DSC11 - OSC11 G03			



	Code	OEM new	OEM old
OIL PUMP GASKET	60116	238777	
<ul style="list-style-type: none"> ● Model ★ Application 			
<ul style="list-style-type: none"> ● 3 BUS 			
<ul style="list-style-type: none"> ★ ENG 5347666 - ENG 5333759 - ENG 5333760 - DSC1117 ENG 5347666 - ENG 5319702 			
<ul style="list-style-type: none"> ● IND. MARINE ENGINE 4 			
<ul style="list-style-type: none"> ★ 			
<ul style="list-style-type: none"> ● 3 TRUCK 			
<ul style="list-style-type: none"> ★ DSC1117:ENG 4082208 - ENG 5319701 - ENG 5319702 - ENG 5333759 - ENG 5333760 - ENG 3154338 - ENG 3154339 - ENG 5347666 - ENG 4089251 - ENG 4089252 			
<ul style="list-style-type: none"> ● 4 TRUCK 			
<ul style="list-style-type: none"> ★ DSC11 - OSC11 G03 			



	Code	OEM new	OEM old
OIL PUMP	60391	263161	
<ul style="list-style-type: none"> ● 3 TRUCK 			
<ul style="list-style-type: none"> ★ DSC14 03/04/06 - DSC14 08/09/10 ENG 5549166 - ENG 4189352 			



	Code	OEM new	OEM old
OIL PUMP GEAR	60407	242299	
<ul style="list-style-type: none"> ● 3 TRUCK 			
<ul style="list-style-type: none"> ★ DSC14 03/04/06 - DSC14 08/09/10 ENG 5549166 - ENG 4189352 			



	Code	OEM new	OEM old
OIL PUMP GEAR	60408	242297	
<ul style="list-style-type: none"> ● Model ★ Application 			
<ul style="list-style-type: none"> ● 3 TRUCK 			
<ul style="list-style-type: none"> ★ DSC14 03/04/06 - DSC14 08/09/10 ENG 5549166 - ENG 4189352 			



OIL PUMP GEAR	60409	242298	
<ul style="list-style-type: none"> ● 3 TRUCK 			
<ul style="list-style-type: none"> ★ DSC14 03/04/06 - DSC14 08/09/10 ENG 5549166 - ENG 4189352 			



GASKET	61240	242300	
<ul style="list-style-type: none"> ● 3 TRUCK 			
<ul style="list-style-type: none"> ★ DSC14 03/04/06/08/09/10 			



OIL PUMP



- Model
- ★ Application

Code

OEM new

OEM old

61460

1370254

- 4 TRUCK

- ★ DSC14 13/15

OIL PUMP



61461

1888025

1448659

- 4 BUS

- ★ DC11 - D12 ENG 6120948 - ENG 6120949 - ENG 8005013 - ENG 8005014

- F-K-N BUS

- ★ D11 - D12K

- IND. MARINE ENGINE 4

- ★ D12 A/M - DI12 49A - DC12 57A - DI12 68/69M

- 4 TRUCK

- ★ D12 - DSC12 - DC12 - DC11

- P-G-R-T TRUCK

- ★ D11 - D12

ALL THE COMPONENTS LISTED IN OUR CATALOGUE ARE NOT ORIGINAL, THOUGH PERFECTLY INTERCHANGEABLE. REFERENCE NUMBERS, EITHER ORIGINAL OR OF A DIFFERENT NATURE, ARE FOR INFORMATION PURPOSES ONLY WHEN PLACING AN ORDER, PLEASE, ALWAYS USE COSIBO REFERENCE NUMBERS AND DO NOT MENTION THE ORIGINAL REFERENCE NUMBERS OF THE TRUCK MANUFACTURERS IN THE INVOICE TO VEHICLE OWNERS OR TO ANYBODY ELSE. THE CUSTOMER TAKES HIS OWN RESPONSIBILITY IF HE DOES NOT COMPLY WITH WHAT ABOVE.

OIL PUMP



	Code	OEM new	OEM old
● Model ★ Application	61909	1402400	1102581 1318075 1322142 1402401

● 3 BUS			
★	ENG 5109548 - ENG 5109549		

● 4 BUS			
★	DSC9 - DC9 01/02/03/04/05/06 ENG 4031032 - ENG 4031029 - ENG 5127534 - DSC9 - DSI9 E01 - DC9 - K/L/N94 - DSC9 - DSI9 E01 - DC9 - OSC9 G01 - K94 DSC9		

● IND. MARINE ENGINE 4			
★	SG9 A280 - D9M - D9A/M ENG 5127534		

● 3 TRUCK			
★	ENG 4013962 - ENG 5109548 - ENG 5109549		

● 4 TRUCK			
★	DSC9 - DC9 01/02/03/04/05/06 ENG 4031032 - ENG 4031029 - ENG 5127534 - DSC9 ENG 4031031 - ENG 4031028 - ENG 5127533		



OIL PUMP



	61916	1323823	
● IND. MARINE ENGINE 4			
★			

● 3 TRUCK			
★	DSC14 08/09/10/16 ENG 5549167 - ENG 4189353		

ALL THE COMPONENTS LISTED IN OUR CATALOGUE ARE NOT ORIGINAL, THOUGH PERFECTLY INTERCHANGEABLE. REFERENCE NUMBERS, EITHER ORIGINAL OR OF A DIFFERENT NATURE, ARE FOR INFORMATION PURPOSES ONLY WHEN PLACING AN ORDER, PLEASE, ALWAYS USE COSIBO REFERENCE NUMBERS AND DO NOT MENTION THE ORIGINAL REFERENCE NUMBERS OF THE TRUCK MANUFACTURERS IN THE INVOICE TO VEHICLE OWNERS OR TO ANYBODY ELSE. THE CUSTOMER TAKES HIS OWN RESPONSIBILITY IF HE DOES NOT COMPLY WITH WHAT ABOVE.

	Code	OEM new	OEM old
SEAL RING	64143	381235	
	<ul style="list-style-type: none"> ● Model ★ Application 		
	<ul style="list-style-type: none"> ● 3 BUS ★ 		
	<ul style="list-style-type: none"> ● 3 TRUCK ★ 		
	<ul style="list-style-type: none"> ● 4 BUS ★ DC11 - D12 - DSC9 - DS19 E01 - DC9 01/02/03/04/05/06 - OSC9 G01 - K/L/N 94 		
	<ul style="list-style-type: none"> ● 4 TRUCK ★ D12 - DSC9 - DC9 01/02/03/04/05/06 - DC11 - DS19 E01 - OSC9 G01 		
	<ul style="list-style-type: none"> ● IND. MARINE ENGINE 4 ★ D12 A/M - SG9 A280 - D9 A/M - DSC9 		
O-RING	64144	1351692	
	<ul style="list-style-type: none"> ● 4 BUS ★ DC11 - D12 - DC9 19/20/21 - K 94 		
	<ul style="list-style-type: none"> ● 4 TRUCK ★ DC11 - D12 - DC9 19/20/21 		
	<ul style="list-style-type: none"> ● F-K-N BUS ★ D9 PDE - D11 - D12 K 		
	<ul style="list-style-type: none"> ● IND. MARINE ENGINE 4 ★ D12 A/M - DI12 49A - DC12 57A - DI12 68/69M 		
	<ul style="list-style-type: none"> ● IND. MARINE ENGINE 5 ★ DC9 A EMS - SG9 A280 		
	<ul style="list-style-type: none"> ● P-G-R-T TRUCK ★ D9 PDE - D11 - D12 		

ALL THE COMPONENTS LISTED IN OUR CATALOGUE ARE NOT ORIGINAL, THOUGH PERFECTLY INTERCHANGEABLE. REFERENCE NUMBERS, EITHER ORIGINAL OR OF A DIFFERENT NATURE, ARE FOR INFORMATION PURPOSES ONLY WHEN PLACING AN ORDER, PLEASE, ALWAYS USE COSIBO REFERENCE NUMBERS AND DO NOT MENTION THE ORIGINAL REFERENCE NUMBERS OF THE TRUCK MANUFACTURERS IN THE INVOICE TO VEHICLE OWNERS OR TO ANYBODY ELSE. THE CUSTOMER TAKES HIS OWN RESPONSIBILITY IF HE DOES NOT COMPLY WITH WHAT ABOVE.

	Code	OEM new	OEM old
REPAIR SET	64190	64190	
<ul style="list-style-type: none"> ● Model ★ Application 			
<ul style="list-style-type: none"> ● 3 BUS 			
★ COMPOSED BY: N.2 PCS 64143 - N.1 PC 64144			
<ul style="list-style-type: none"> ● 3 TRUCK 			
★ COMPOSED BY: N.2 PCS 64143 - N.1 PC 64144			
<ul style="list-style-type: none"> ● 4 BUS 			
★ DC11 - D12 - DSC9 - DS19 E01 - DC9 01/02/03/04/05/06 - OSC9 G01 - K/L/N 94 - COMPOSED BY: N.2 PCS 64143 - N.1 PC 64144			
<ul style="list-style-type: none"> ● 4 TRUCK 			
★ D12 - DSC9 - DC9 01/02/03/04/05/06 - DC11 - DS19 E01 - OSC9 G01 - COMPOSED BY: N.2 PCS 64143 - N.1 PC 64144			
<ul style="list-style-type: none"> ● IND. MARINE ENGINE 4 			
★ D12 A/M - SG9 A280 - D9 A/M - DSC9 - COMPOSED BY: N.2 PCS 64143 - N.1 PC 64144			



		Code	OEM new	OEM old
GASKET	● Model	60206	1388678	371507
	★ Application			
	● 3 BUS			
	★	DS11 34/74/75/78 - DSC11 04/08/17/18/21/22/23/24/27/35/36/70/71/81 - DSI11 E01 - OSC11 G01		
	● 4 BUS			
	★	OSC11 G03		
	● IND. MARINE ENGINE 4			
	★	DS DSC DSI11 A		
	● 3 TRUCK			
	★	DS11 34/73/75 - DSC11 08/10/12/13/16/17/18/21/22/23/30/35/36/39/70 - DN11 01 - DTC11 01/02		
● 4 TRUCK				
★	DSC11 74/75/79 - OSC11 G03			



		60561	258459	
GASKET	● 3 BUS			
	★			
	● 4 BUS			
	★	DSC11 OSC11 G03		
	● IND. MARINE ENGINE 4			
	★	DS/DSC/DSI11A		
	● 3 TRUCK			
	★			
	● 4 TRUCK			
	★	DSC11 OSC11 G03		



		Code	OEM new	OEM old
GASKET	● Model	61237	378299	344426
	★ Application			
	● 3 BUS			
	★ DSC9 UP TO ENG 5130020 - ENG 4032264			
● 3 TRUCK				
★ DSC9 UP TO ENG 5130020 - ENG 4032264				



		61716	1378226	371511
GASKET	● IND. MARINE ENGINE 4			
	★ D14 A/M - D14			
	● 3 TRUCK			
	★ CR/CT 143			
● 4 TRUCK				
★ DSC14 13/15 - D14				



		61834	1305959	170610 381638
GASKET	● IND. MARINE ENGINE 4			
	★ D/DC/D14/D114 A/M			
	● 3 TRUCK			
	★			
● 4 TRUCK				
★ DSC14 13/15				



ALL THE COMPONENTS LISTED IN OUR CATALOGUE ARE NOT ORIGINAL, THOUGH PERFECTLY INTERCHANGEABLE. REFERENCE NUMBERS, EITHER ORIGINAL OR OF A DIFFERENT NATURE, ARE FOR INFORMATION PURPOSES ONLY WHEN PLACING AN ORDER, PLEASE, ALWAYS USE COSIBO REFERENCE NUMBERS AND DO NOT MENTION THE ORIGINAL REFERENCE NUMBERS OF THE TRUCK MANUFACTURERS IN THE INVOICE TO VEHICLE OWNERS OR TO ANYBODY ELSE. THE CUSTOMER TAKES HIS OWN RESPONSIBILITY IF HE DOES NOT COMPLY WITH WHAT ABOVE.

		Code	OEM new	OEM old
GASKET	● Model	62489	1420776	
	★ Application			
	● 4 BUS			
	★	DSC9 - DS19 E01 - DC9 01/ 02/ 03/ 04/ 05/ 06 - OSC9 G01 - OSC9 - DS19 - DSC9 ENG 5130021 - ENG 4032265 - DSC9 - DS19 E01 OSC9 G01 ENG 5130021 - ENG 4032265 - ENG 3127204 - DSC9 DS19 E01 ENG 5130021 - ENG 4032264		
	● IND. MARINE ENGINE 4			
	★	D - DC - DI 9A/ 9M - SG9 A280 - D9 A/ M - DSC9/ DC9 A/ M - FOR ENG 5130021 - ENG 4032265		
	● 4 TRUCK			
	★	DSC9 - DS19 E01 - DC9 01/ 02/ 03/ 04/ 05/ 06 - OSC9 G01 - OSC9 - DS19 - DSC9 ENG 5130021 - ENG 4032265		

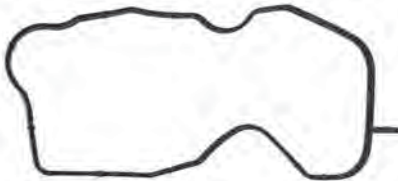
		63083	1401982	
GASKET	● 4 BUS			
	★	DSC12 01/02/03/05 - DC12 - DT12 - DC11 01/02/03/04/05/06/07 - D12		
	● IND. MARINE ENGINE 4			
	★	D12A/M - D12A EMS - D12M EMS - SGI12A - DC16A - D16M - DI16 48A/53A		
	● IND. MARINE ENGINE 5			
	★	SG9 A280		
	● 4 TRUCK			
	★	DSC12 01/02/03/05 - DC12 - DT12 - DC11 01/02/03/04/05/06/07 - D12 - DC16		

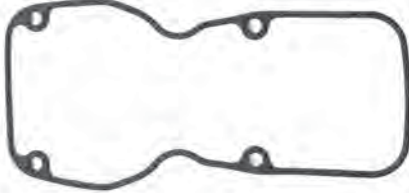
		63085	1367028	
GASKET	● 4 BUS			
	★	DSC12 01/02 - DC11 07 - DC11 - DC12		
	● IND. MARINE ENGINE 4			
	★	D12A		
	● 4 TRUCK			
	★	DSC12 01/02 - DC11 07 - DC11 - DC12		

		Code	OEM new	OEM old
GASKET	● Model	63627	291826	
	★ Application			
	● 3 BUS			
	★	DS11 34/74/75/78 - DSC11 08/17/18/21/22/23/35/36/70/71 - DS11 - N113 - K113 GR801 DS11 34 DSC11 21 - L113 G776 GS771/772 GR801 GA775/781/R - F113 RH - GR801R		
	● 4 BUS			
	★	DSC11 - OSC11 G03		
	● IND. MARINE ENGINE 4			
	★	D11 - DS/DSC/DSI 11A		
	● 3 TRUCK			
	★	DS11 34/73/75 - DSC11 08/10/12/13/16/17/18/21/22/23/30/35/36/39/70 - DN11 01 - DTC11 01/02 - CP/CR/CT 113 - CR13/19 D11 - CP/CR DSC11 21/22(EDC)/23 - CP/CR/CT 113 GR/GRS900R - CP113 ML/HL 4X2 6X2 GA850 - GA850R (HD4060PR)		
● 4 TRUCK				
★	DSC11 - OSC11 G03 - CP/CR/CT DSC11 74/75/79			



		Code	OEM new	OEM old
GASKET		63804	1367027	
	● 4 BUS			
	★	DSC12 01/02 - DC11 07 - D12		
● 4 TRUCK				
★	DSC12 01/02 - DC11 07 - D12			



		Code	OEM new	OEM old
GASKET		63853	1411851	
	● 4 BUS			
	★	DSC12 01/02/03/05 - DC12 - DT12 - DC11 01/02/03/04/06/07		
	● IND. MARINE ENGINE 4			
	★	DC16 - DC16A - D16A - D16M - D12M EMS - D12A EMS - D116 48A/53A - D12A/M		
● 4 TRUCK				
★	DSC12 01/02/03/05 - DC12 - DT12 - DC11 01/02/03/04/06/07 - DC16			

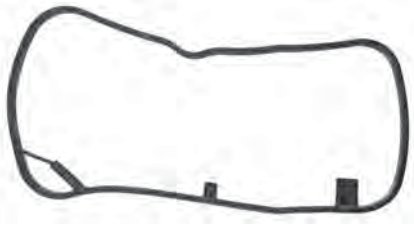

		Code	OEM new	OEM old
GASKET	● Model	63854	1401984	
	★ Application			
	● 4 BUS			
	★ DSC12 01/02/03/05 - DC12 - D12 - DC11 01/02/03/04/06/07 - DT12			
	● IND. MARINE ENGINE 4			
	★ D12 A/M			
	● 4 TRUCK			
	★ DSC12 01/02/03/05 - DC12 - D12 - DC11 01/02/03/04/06/07 - DT12			

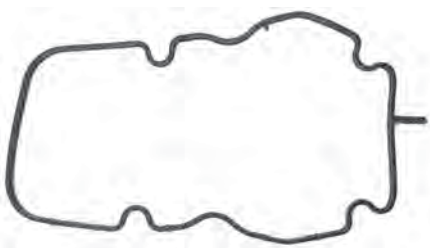
		63855	1414422	
GASKET	● 4 BUS			
	★ DSC12 01/02/03/05 - DC11 01/02/03/04/06/07 - DC12 - DT12			
	● IND. MARINE ENGINE 4			
	★ D12A - D12M - SGI12A - D12A/M			
	● IND. MARINE ENGINE 5			
	★ SG9 A280			
	● 4 TRUCK			
	★ DSC12 01/02/03/05 - DC11 01/02/03/04/06/07 - DC12 - DT12			

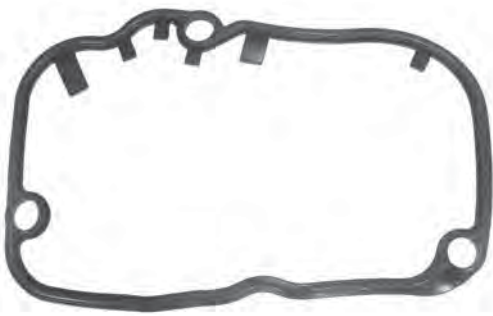
		65342	1505366	
GASKET	● 4 BUS			
	★ DC9 19/20/21			
	● F-K-N BUS			
	★ D9 PDE - D9 - D11 - D12 - D16			
	● IND. MARINE ENGINE 4			
	★ D16A - D16M - D12M EMS - DC12 50A/57A			
	● IND. MARINE ENGINE 5			
	★ DC9A EMS			
	● 4 TRUCK			
	★ DC16 ENG 1018725 - DC9 19/20/21			
	● P-G-R-T TRUCK			
★ D9 PDE - D9 - D11 - D12 - D16				

ALL THE COMPONENTS LISTED IN OUR CATALOGUE ARE NOT ORIGINAL, THOUGH PERFECTLY INTERCHANGEABLE. REFERENCE NUMBERS, EITHER ORIGINAL OR OF A DIFFERENT NATURE, ARE FOR INFORMATION PURPOSES ONLY WHEN PLACING AN ORDER, PLEASE, ALWAYS USE COSIBO REFERENCE NUMBERS AND DO NOT MENTION THE ORIGINAL REFERENCE NUMBERS OF THE TRUCK MANUFACTURERS IN THE INVOICE TO VEHICLE OWNERS OR TO ANYBODY ELSE. THE CUSTOMER TAKES HIS OWN RESPONSIBILITY IF HE DOES NOT COMPLY WITH WHAT ABOVE.

		Code	OEM new	OEM old
GASKET	● Model	65343	1449542	
	★ Application			
	● 4 BUS			
	★	DC9 19/20/21		
	● F-K-N BUS			
	★	D11 - D12 - D9 PDE - D9 - D16		
	● IND. MARINE ENGINE 4			
	★	D12M EMS - DC12 50A/57A - DC16A - D16M - DC16		
	● IND. MARINE ENGINE 5			
	★	DC9A EMS		
	● 4 TRUCK			
	★	DC16 - DC9 19/20/21		
	● P-G-R-T TRUCK			
★	D11 - D12 - D9 PDE - D9 - D16			



GASKET		65344	1542104	1476506
	● 4 BUS			
	★	DSC12 01/02/03/05 - DC12 - DT12 - DC11 01/02/03/04/05/06/07 - D12		
	● IND. MARINE ENGINE 4			
	★	D12A/M - D12A EMS - D12M EMS - SGI12A - DC16A - D16M - DI16 48A/53A		
	● IND. MARINE ENGINE 5			
	★	SG9 A280		
	● 4 TRUCK			
	★	DSC12 01/02/03/05 - DC12 - DT12 - DC11 01/02/03/04/05/06/07 - D12 - DC16		

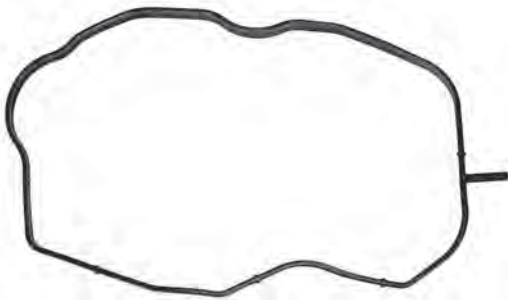

	Code	OEM new	OEM old
SEAL RING	63148	292811	
<ul style="list-style-type: none"> ● Model ★ Application 			
<ul style="list-style-type: none"> ● 3 BUS ★ 			
<ul style="list-style-type: none"> ● 4 BUS ★ DSC11 - SC11 G03 - DSC9 F94 - K/L/N94 DSC9 - DSC9 - DSI9 E01 N94 			
<ul style="list-style-type: none"> ● IND. MARINE ENGINE 4 ★ 			
<ul style="list-style-type: none"> ● 3 TRUCK ★ 			
<ul style="list-style-type: none"> ● 4 TRUCK ★ DSC11 - SC11 G03 - DSC9 			



	64087	1355703	
RUBBER SPACER			
<ul style="list-style-type: none"> ● 4 BUS ★ DC11 07 - DSC12 02 			
<ul style="list-style-type: none"> ● IND. MARINE ENGINE 4 ★ SGI 12A - DI12 41/42/43/44/45/57M - DSC12 40/42A - DC12 40/42A 			
<ul style="list-style-type: none"> ● IND. MARINE ENGINE 5 ★ SG9 A280 			
<ul style="list-style-type: none"> ● 4 TRUCK ★ DC11 07 - DSC12 01/02 			



		Code	OEM new	OEM old
GASKET	● Model	61842	1392932	170694
	★ Application			
	● IND. MARINE ENGINE 4			
	★	D14A/M 1100W-500/1500W		
	● 3 TRUCK			
	★	CR/CT143 - STEAMLINE - CR143 GRS900		
● 4 TRUCK				
★	DSC14 13/15 - 144 CR19 - GRSH900R GSR900R DC14			





		61844	1384551	371483
GASKET	● 3 BUS			
	★			
	● 4 BUS			
	★	DSC11 - OSC11 G03		
	● IND. MARINE ENGINE 4			
	★			
	● 3 TRUCK			
	★	DS11 34/ 73/ 75 - DSC11 08/ 10/ 12/ 13/ 16/ 17/ 18/ 21/ 22/ 23/ 30/ 35/ 36/ 39/ 70 - DN11 01 - OSC11 G03 - DTC11 01/ 02 - FOR/ PER ENG 5307760 - ENG 3075634 - ENG 4070104 - ENG 5307761 - ENG 4070105 - ENG 3075635		
	● 4 TRUCK			
	★	DSC11 - OSC11 G03 - DSC11 ENG 4122036 - ENG 4122013 - ENG 4122014 - ENG 3193582 - ENG 4122037 - ENG 4122015 - ENG 3193583		



ALL THE COMPONENTS LISTED IN OUR CATALOGUE ARE NOT ORIGINAL, THOUGH PERFECTLY INTERCHANGEABLE. REFERENCE NUMBERS, EITHER ORIGINAL OR OF A DIFFERENT NATURE, ARE FOR INFORMATION PURPOSES ONLY WHEN PLACING AN ORDER, PLEASE, ALWAYS USE COSIBO REFERENCE NUMBERS AND DO NOT MENTION THE ORIGINAL REFERENCE NUMBERS OF THE TRUCK MANUFACTURERS IN THE INVOICE TO VEHICLE OWNERS OR TO ANYBODY ELSE. THE CUSTOMER TAKES HIS OWN RESPONSIBILITY IF HE DOES NOT COMPLY WITH WHAT ABOVE.

		Code	OEM new	OEM old
GASKET	● Model	63114	1375383	
	★ Application			
	● 4 BUS			
	★ DC11 - D12			
	● F-K-N BUS			
	★ D11 - D12			
	● IND. MARINE ENGINE 4			
	★ DC16 - D12M EMS - DI12 68M - 69M - DC12 46A/47A/48A/50A/57A - D12A EMS - DC16 A/M - DI16 48A/53A			
	● 4 TRUCK			
	★ D16 - GRS900/920R DC16 - DC16 - D12 - DC11			
	● P-G-R-T TRUCK			
	★ D11 - D12 - D16			

		64022	1374326	
GASKET	● 4 BUS			
	★ DC11 - D12			
	● 4 TRUCK			
	★ DC11 - D12			

		65345	1392933	170696
GASKET	● IND. MARINE ENGINE 4			
	★ D14 - DSI14 69M - D114 82M			
	● 3 TRUCK			
	★			
	● 4 TRUCK			
	★ DSC14 13/15			

ALL THE COMPONENTS LISTED IN OUR CATALOGUE ARE NOT ORIGINAL, THOUGH PERFECTLY INTERCHANGEABLE. REFERENCE NUMBERS, EITHER ORIGINAL OR OF A DIFFERENT NATURE, ARE FOR INFORMATION PURPOSES ONLY WHEN PLACING AN ORDER, PLEASE, ALWAYS USE COSIBO REFERENCE NUMBERS AND DO NOT MENTION THE ORIGINAL REFERENCE NUMBERS OF THE TRUCK MANUFACTURERS IN THE INVOICE TO VEHICLE OWNERS OR TO ANYBODY ELSE. THE CUSTOMER TAKES HIS OWN RESPONSIBILITY IF HE DOES NOT COMPLY WITH WHAT ABOVE.

	Code	OEM new	OEM old
GASKET	65349	371497	
<ul style="list-style-type: none"> ● Model ★ Application 			
			
<ul style="list-style-type: none"> ● IND. MARINE ENGINE 4 ★ SAE B 			
<ul style="list-style-type: none"> ● 3 TRUCK ★ 			
<ul style="list-style-type: none"> ● 4 TRUCK ★ DSC14 13/15 			

ALL THE COMPONENTS LISTED IN OUR CATALOGUE ARE NOT ORIGINAL, THOUGH PERFECTLY INTERCHANGEABLE. REFERENCE NUMBERS, EITHER ORIGINAL OR OF A DIFFERENT NATURE, ARE FOR INFORMATION PURPOSES ONLY WHEN PLACING AN ORDER, PLEASE, ALWAYS USE COSIBO REFERENCE NUMBERS AND DO NOT MENTION THE ORIGINAL REFERENCE NUMBERS OF THE TRUCK MANUFACTURERS IN THE INVOICE TO VEHICLE OWNERS OR TO ANYBODY ELSE. THE CUSTOMER TAKES HIS OWN RESPONSIBILITY IF HE DOES NOT COMPLY WITH WHAT ABOVE.

		Code	OEM new	OEM old
GASKET	● Model	60567	1388682	371487
	★ Application			
	● 3 BUS			
	★			
	● 4 BUS			
	★ DSC11 - OSC11 G03			
	● IND. MARINE ENGINE 4			
	★ OK			
	● 3 TRUCK			
	★ DS/DSC11 - DTC11 - P113 D11 GA850/850R			
● 4 TRUCK				
★ DSC11 - OSC11 G03				



		61230	1392935	371499
GASKET	● IND. MARINE ENGINE 4			
	★			
	● 3 TRUCK			
	★			
	● 4 TRUCK			
	★ DSC14 13/15			



ALL THE COMPONENTS LISTED IN OUR CATALOGUE ARE NOT ORIGINAL, THOUGH PERFECTLY INTERCHANGEABLE. REFERENCE NUMBERS, EITHER ORIGINAL OR OF A DIFFERENT NATURE, ARE FOR INFORMATION PURPOSES ONLY WHEN PLACING AN ORDER, PLEASE, ALWAYS USE COSIBO REFERENCE NUMBERS AND DO NOT MENTION THE ORIGINAL REFERENCE NUMBERS OF THE TRUCK MANUFACTURERS IN THE INVOICE TO VEHICLE OWNERS OR TO ANYBODY ELSE. THE CUSTOMER TAKES HIS OWN RESPONSIBILITY IF HE DOES NOT COMPLY WITH WHAT ABOVE.

	Code	OEM new	OEM old
OIL SEAL 35x62x7	61023	1109870	310951
	● Model		
	★ Application		
	● 3 TRUCK		
	★ DS11 34/73/75 - DSC11 08/10/12/13/16/17/18/21/23/30/35/36/39/70 - DN11 01 - DTC11 01/02		
	● 4 TRUCK		
	★ OSC11 G03		
	● 3 BUS		
	★ DS11 34/74/75/78 - DSC11 04/08/17/18/21/22/23/24/27/35/36/70/71 - DSI11 - DSI11 E01 - OSC11 G01		
	● 4 BUS		
	★ OSC9 G01		

	Code	OEM new	OEM old
OIL SEAL 130x160x13	61219	369478	366303
	● 3 BUS		
	★		
	● 4 BUS		
	★ DSC9 - DS19 E01 - DC9 01/ 02/ 03/ 04/ 05/ 06 - OSC9 G01 - DSC11 - OSC11 G03 - OSC9 G91		
	● IND. MARINE ENGINE 4		
	★ SG9 A280 - DSC9 - DC9 A/ M		
	● 3 TRUCK		
	★ DS - DSC11 - DTC11 - P93 D9:GA750/ 850R - P113 D11:GA850/ 850R		
	● 4 TRUCK		
	★ DSC9 - DS19 E01 - DC9 01/ 02/ 03/ 04/ 05/ 06 - OSC9 G01 - DSC11 - OSC11 G03 - DSC14 13/ 15		

ALL THE COMPONENTS LISTED IN OUR CATALOGUE ARE NOT ORIGINAL, THOUGH PERFECTLY INTERCHANGEABLE. REFERENCE NUMBERS, EITHER ORIGINAL OR OF A DIFFERENT NATURE, ARE FOR INFORMATION PURPOSES ONLY WHEN PLACING AN ORDER, PLEASE, ALWAYS USE COSIBO REFERENCE NUMBERS AND DO NOT MENTION THE ORIGINAL REFERENCE NUMBERS OF THE TRUCK MANUFACTURERS IN THE INVOICE TO VEHICLE OWNERS OR TO ANYBODY ELSE. THE CUSTOMER TAKES HIS OWN RESPONSIBILITY IF HE DOES NOT COMPLY WITH WHAT ABOVE.

OIL SEAL 145x175x13



	Code	OEM new	OEM old
● Model	63767	1433183	1375002
★ Application			
● 4 BUS			
★ DC9 19/ 20/ 21 - DC11/ DSC12 03/ 05/ DC12 - DC11/ D12 - DSC12 02			
● F-K-N BUS			
★ D9/ D12 K/ N - F			
● IND. MARINE ENGINE 4			
★ DC16 - DI12 68M/D12A EMS - ENG 6516259 - ENG 6516260 - 6517506 - DI12 49A/DC12 54A/57A ENG 6516260 - 6517600 - D12M EMS ENG 6516259 - ENG 6516260 - 6517506 - DC12A/DI12M ENG 6516259 - ENG 6516260 - ENG 8710777 - DC16A ENG 6500001 - 6513503 - ENG 1051599 - 1060948 - ENG 1018690 - 1051598 - ENG 1061165 - ENG 1060949 - 1067699 - DI16 40/41A - DI16 48A/53A ENG 1060948 - ENG 1060949 - 1068481 - D16M ENG 6500001 - 6516259 - ENG 6516260 - 6513510 - ENG 1039758 - 1060948 - ENG 1061165 - ENG 1060949 - 1067699			
● IND. MARINE ENGINE 5			
★ DC9A EMS - SG9 A280			
● 4 TRUCK			
★ DC9 19/20/21 - DC11/DSC12 03/05/ DC12 ENG 6123709 - ENG 8005739 - ENG 6125027 - 6130334 - ENG 6123710 - 6125026 - ENG 8005740 - ENG 6130335 - DC11/D12 ENG 6119599 - ENG 8004779 - ENG 6119600 - ENG 8004780 - DC16 - DSC12 01/02 ENG 6123709 - ENG 8005739 - ENG 6125027 - 6130334 - ENG 6123710 - 6125026 - ENG 8005740 - ENG 6130335 - DT12			
● P-G-R-T TRUCK			
★ D9/ D11/ D12 - D16			

ALL THE COMPONENTS LISTED IN OUR CATALOGUE ARE NOT ORIGINAL, THOUGH PERFECTLY INTERCHANGEABLE. REFERENCE NUMBERS, EITHER ORIGINAL OR OF A DIFFERENT NATURE, ARE FOR INFORMATION PURPOSES ONLY WHEN PLACING AN ORDER, PLEASE, ALWAYS USE COSIBO REFERENCE NUMBERS AND DO NOT MENTION THE ORIGINAL REFERENCE NUMBERS OF THE TRUCK MANUFACTURERS IN THE INVOICE TO VEHICLE OWNERS OR TO ANYBODY ELSE. THE CUSTOMER TAKES HIS OWN RESPONSIBILITY IF HE DOES NOT COMPLY WITH WHAT ABOVE.

	Code	OEM new	OEM old
O-RING 114,5x3	60127	323790	362128
● Model			
★ Application			
● 3 BUS			
★			
● 4 BUS			
★ DC11 - D12 - DSC11 - OSC11 G03			
● F-K-N BUS			
★ D9 XPI - D9 - DC12 K/N			
● IND. MARINE ENGINE 4			
★ DC16 - DC16A - D16M - DSI14 68/69/73/74/75/78M - DC12A - DI12M - DI16 40/41/48/53A - SAE B RH/DX - SAE B - DSC9/DC9 A/M - D9M - D11M - D14A/M - DI14 82M - D12M EMS - DC9A EMS - D12A EMS			
● IND. MARINE ENGINE 5			
★ SG9 A280			
● 3 TRUCK			
★ CR/CT 143			
● 4 TRUCK			
★ DC16 - DC11 - D12 - DSC11 - OSC11 G03 - DSC14 13/15			
● P-G-R-T TRUCK			
★ D9 XPI - D13 XPI			

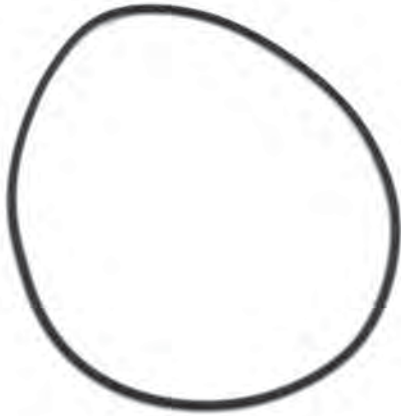

		Code	OEM new	OEM old
GASKET	● Model	60589	1388681	131180
	★ Application			287554
				374742
				385022
		● 3 BUS		
		★ DSC11 81		
		● 4 BUS		
		★ DSC11 - OSC11 G03		
		● IND. MARINE ENGINE 4		
		★		
		● 3 TRUCK		
		★ DS11 34/73/75 - DSC11 08/10/12/13/16/17/18/21/23/35/36 - DN11 01 - DS/ DSC/DTC11 - DS/DSC11		
		● 4 TRUCK		
		★ DSC11 - OSC11 G03		



		65001	1388680	1305341
GASKET	● 3 BUS			
	★ DSC11 81			
		● 4 BUS		
		★ DSC11 - OSC11 G03		
		● IND. MARINE ENGINE 4		
		★		
		● 3 TRUCK		
		★ DS11 75 - DSC11 21/23/35/36 - DS/DSC/DTC11 - DS/DSC11		
		● 4 TRUCK		
		★ DSC11 - OSC11 G03		

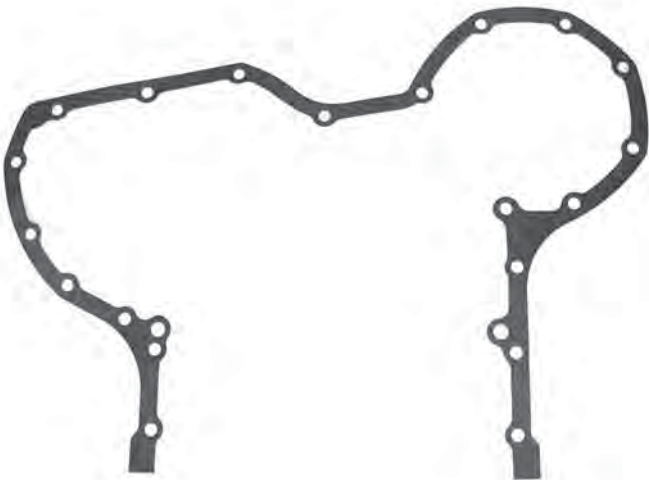

		Code	OEM new	OEM old
GASKET	● Model	65352	1896605	1403129
	★ Application			
	● 4 BUS			
	★ DC11 - D12 - K94 DC9 19/20/21			
	● F-K-N BUS			
	★ K/N			
	● IND. MARINE ENGINE 4			
	★ DC12 50A/57A			
	● IND. MARINE ENGINE 5			
	★ SG9 A280 - DC9A EMS			
● 4 TRUCK				
★ DC11 - D12 - DSC12 01/02/03/05 - DC9 19/20/21 - DC12 - DT12				
● P-G-R-T TRUCK				
★ D9 PDE - D11 - D12				

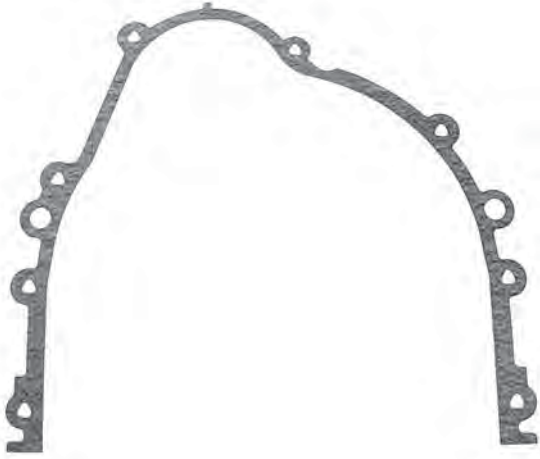

GASKET	65353	1374334	
	● 4 BUS		
	★ DC11 - D12		
	● 4 TRUCK		
	★ DC11 - D12 - DSC12 01/02		

ALL THE COMPONENTS LISTED IN OUR CATALOGUE ARE NOT ORIGINAL, THOUGH PERFECTLY INTERCHANGEABLE. REFERENCE NUMBERS, EITHER ORIGINAL OR OF A DIFFERENT NATURE, ARE FOR INFORMATION PURPOSES ONLY WHEN PLACING AN ORDER, PLEASE, ALWAYS USE COSIBO REFERENCE NUMBERS AND DO NOT MENTION THE ORIGINAL REFERENCE NUMBERS OF THE TRUCK MANUFACTURERS IN THE INVOICE TO VEHICLE OWNERS OR TO ANYBODY ELSE. THE CUSTOMER TAKES HIS OWN RESPONSIBILITY IF HE DOES NOT COMPLY WITH WHAT ABOVE.

OIL SEAL 80x100x12,75



	Code	OEM new	OEM old
● Model	63140	369477	372773
★ Application			
● 3 BUS			
★ DSC11 81			
● 4 BUS			
★ DSC9 - DC9 01/ 02/ 03/ 04/ 05/ 06 - DS19 E01 - OSC9 G01 - DSC11 - OSC11 G03			
● IND. MARINE ENGINE 4			
★ SG9 A280 - DSC9 - DC9 A/ M			
● 3 TRUCK			
★ FOR CH 5118341 - CH 4021349 - DS11 73/34 75 - DSC11 08/10/12/13/16/17/18/21/23/35/36 - DN11 01 - ENG 5324679 - DS/DSC/DTC11 ENG 5324679 - ENG 4085804 - DS/DSC11 CH 5324679 - CH 4085804 - FOR ENG 5118341 - ENG 4021349 - ENG 5307760 - ENG 3075634 - ENG 4070104 - ENG 5307761 - ENG 4070105 - ENG 3075635			
● 4 TRUCK			
★ DSC11 - OSC11 G03 - DSC9 - DC9 01/ 02/ 03/ 04/ 05/ 06 - DSC14 13/ 15 - DS19 E01 - OSC9 G01			

OIL SEAL 140x118x12



	64351	1392708	
● 4 BUS			
★ DC11/ D12			
● F-K-N BUS			
★ K/ N			
● IND. MARINE ENGINE 4			
★ DI12 68/ 69M - DC12 50A - DC12 57A - DC16A - DI16 40/ 41A 48A 53A - D16M - DC16			
● IND. MARINE ENGINE 5			
★ SG9 A280 - DC9A EMS			
● 4 TRUCK			
★ DC16 - DSC12 01/ 02 - DC9 19/ 20/ 21 - DC11 - DSC12 03/ 05 - DC12 - DT12 - DC11/ D12			
● P-G-R-T TRUCK			
★ D9 PDE - D11 - D12 - D16			

ALL THE COMPONENTS LISTED IN OUR CATALOGUE ARE NOT ORIGINAL, THOUGH PERFECTLY INTERCHANGEABLE. REFERENCE NUMBERS, EITHER ORIGINAL OR OF A DIFFERENT NATURE, ARE FOR INFORMATION PURPOSES ONLY WHEN PLACING AN ORDER, PLEASE, ALWAYS USE COSIBO REFERENCE NUMBERS AND DO NOT MENTION THE ORIGINAL REFERENCE NUMBERS OF THE TRUCK MANUFACTURERS IN THE INVOICE TO VEHICLE OWNERS OR TO ANYBODY ELSE. THE CUSTOMER TAKES HIS OWN RESPONSIBILITY IF HE DOES NOT COMPLY WITH WHAT ABOVE.

OIL SEAL 80x100x12



	Code	OEM new	OEM old
● Model	61026	338643	275591
★ Application			
● 3 BUS			
★	ENG 5324678 - ENG 5118340		
● 3 TRUCK			
★	DS11 34/73/75 - DSC11 08/10/12/13/16/17/18/21/23/35/36 - DN11 01 - DS/ DSC/DTC11		
● 4 TRUCK			
★	DSC14 13/15		

ENGINE FILTER KIT



	Code	OEM new	OEM old
	62382	1486634	
● IND. MARINE ENGINE 4			
★	D16A - DC16A		
● 4 TRUCK			
★	D16 - DC16		
● P-G-R-T TRUCK			
★	D16		

ALL THE COMPONENTS LISTED IN OUR CATALOGUE ARE NOT ORIGINAL, THOUGH PERFECTLY INTERCHANGEABLE. REFERENCE NUMBERS, EITHER ORIGINAL OR OF A DIFFERENT NATURE, ARE FOR INFORMATION PURPOSES ONLY WHEN PLACING AN ORDER, PLEASE, ALWAYS USE COSIBO REFERENCE NUMBERS AND DO NOT MENTION THE ORIGINAL REFERENCE NUMBERS OF THE TRUCK MANUFACTURERS IN THE INVOICE TO VEHICLE OWNERS OR TO ANYBODY ELSE. THE CUSTOMER TAKES HIS OWN RESPONSIBILITY IF HE DOES NOT COMPLY WITH WHAT ABOVE.

ENGINE BRAKE CYLINDER



	Code	OEM new	OEM old
● Model	61536	1332503	1348896
★ Application			
● 3 BUS			
★ N113 - DSC1108B			
● 3 TRUCK			
★ CP/CR/CT113 - CG/CP/CR/CT93 - CR/CT143 - DSC9 LHD CP/CR - DTC11 01(EDC) - DSC1122(EDC) - DSC11 - DTC11 LHD CP/CR 80dB(A) - DSC14 LHD CR - DSC14 LHD CR 80dB(A)			
● 4 TRUCK			
★ 80dB(A)144			

OIL TEMPERATURE SENSOR





	61346	374338	
● 3 BUS			
★ DS9 - DSC9			
● 4 BUS			
★ DSC9 - DC9 01/02/03/04/05/06 - DSI9 E01 - OSC9 G01 - D12			
● 3 TRUCK			
★ DN9 - DS/DSC9 - DS9 4X4			
● 4 TRUCK			
★ DSC9 - DC9 01/02/03/04/05/06 - DSC12 - DC12 01/02/09			

COOLANT LEVEL SENSOR



	62223	1304725	397929
● 3 BUS			
★ N113 - F113 - K113 - F93 - K113 DSC11 22/70 EDC - K113 DSC11 21 GR801 - K113 DSC11 22/70 EDC GR801 - K113 GR801R - K93/113 - L113			
● 4 BUS			
★ N - K/L - F94 - N94UD			
● IND. MARINE ENGINE 4			
★ SG9 A208 - D9/11/14			
● IND. MARINE ENGINE 5			
★ SG9 A208			
● 3 TRUCK			
★ D9/11/14 - CG/CP/CR/CT93 - CP/CR/CT113 - CR/CT143 - CR13/19 - D11 - CR13/19 - DSC11 21/22(EDC)/23 - DTC11 - CP/CR - DSC11 21/22/23 - DTC11			

ALL THE COMPONENTS LISTED IN OUR CATALOGUE ARE NOT ORIGINAL, THOUGH PERFECTLY INTERCHANGEABLE. REFERENCE NUMBERS, EITHER ORIGINAL OR OF A DIFFERENT NATURE, ARE FOR INFORMATION PURPOSES ONLY WHEN PLACING AN ORDER, PLEASE, ALWAYS USE COSIBO REFERENCE NUMBERS AND DO NOT MENTION THE ORIGINAL REFERENCE NUMBERS OF THE TRUCK MANUFACTURERS IN THE INVOICE TO VEHICLE OWNERS OR TO ANYBODY ELSE. THE CUSTOMER TAKES HIS OWN RESPONSIBILITY IF HE DOES NOT COMPLY WITH WHAT ABOVE.

	Code	OEM new	OEM old
OIL BULB	63152	1316331	1334704
 <ul style="list-style-type: none"> ● Model ★ Application 			
<ul style="list-style-type: none"> ● 3 BUS ★ 			
<ul style="list-style-type: none"> ● IND. MARINE ENGINE 4 ★ D12A/M - D9M 			
<ul style="list-style-type: none"> ● 3 TRUCK ★ 			
<ul style="list-style-type: none"> ● 4 TRUCK ★ DSC11 - DSC14 13/15 			
RELAY	63447	1431781	1391322 243460
 <ul style="list-style-type: none"> ● 3 BUS ★ 			
OIL SENSOR	63847	1452862	1393113 1488340
 <ul style="list-style-type: none"> ● 4 BUS ★ DC11 D12 - DSC9 DC9 01/02/03/04/05/06 - DSC9 DSI9 E01 DC9 OSC9 G01 			
<ul style="list-style-type: none"> ● IND. MARINE ENGINE 4 ★ SG9 A280 - D9M 			
<ul style="list-style-type: none"> ● 4 TRUCK ★ DC11 D12 - DSC9 DC9 01/02/03/04/05/06 - DSC12 DC12 01/02/09 - DSC14 13/15 - OSC11 G03 - 8X8 WLS/ZLS EXTRA 			

ALL THE COMPONENTS LISTED IN OUR CATALOGUE ARE NOT ORIGINAL, THOUGH PERFECTLY INTERCHANGEABLE. REFERENCE NUMBERS, EITHER ORIGINAL OR OF A DIFFERENT NATURE, ARE FOR INFORMATION PURPOSES ONLY WHEN PLACING AN ORDER, PLEASE, ALWAYS USE COSIBO REFERENCE NUMBERS AND DO NOT MENTION THE ORIGINAL REFERENCE NUMBERS OF THE TRUCK MANUFACTURERS IN THE INVOICE TO VEHICLE OWNERS OR TO ANYBODY ELSE. THE CUSTOMER TAKES HIS OWN RESPONSIBILITY IF HE DOES NOT COMPLY WITH WHAT ABOVE.

SOLENOID VALVE



- Model
- ★ Application

	Code	OEM new	OEM old
	65191	1536304	1340231 1421322

- **3 BUS**

- ★ N113 - DSC1108B

- **3 TRUCK**

- ★ CP/CR/CT 113 - CG/CP/CR/CT 93 - CR/CT 143 - CP/CR DSC9 LHD - DTC11 01 (EDC) - DSC11 22(EDC) - DSC11 DTC11 LHD CP/CR 80dB(A) - DSC14 LHD CR 80dB(A)

- **4 TRUCK**



- ★ 8X8 WLS/ZLS - 144

		Code	OEM new	OEM old
GASKET	● Model	60058	385998	235178 277273
	★ Application			
	● 3 BUS			
	★ OSC11 G01			
	● IND. MARINE ENGINE 4			
	★ DS/ DSC/ DSI 11A			
	● 3 TRUCK			
	★ DN11 01 - DS/ DSC11 - DS 73/ DSC11 12			
● 4 TRUCK				
★ DS11 73 - DSC11 12				

		61485	387775	303419
GASKET	● 3 TRUCK			
	★			
	● 3 TRUCK			
	★			

		60059	385997	235177 277272
GASKET	● 3 BUS			
	★ OSC11 G01			
	● IND. MARINE ENGINE 4			
	★ DS/DSC/DSI 11A			
	● 3 TRUCK			
	★ DN11 01 - DS/DSC11 - DS 73/DSC11 12			
	● 4 TRUCK			
	★ DS11 73 - DSC11 12			

ALL THE COMPONENTS LISTED IN OUR CATALOGUE ARE NOT ORIGINAL, THOUGH PERFECTLY INTERCHANGEABLE. REFERENCE NUMBERS, EITHER ORIGINAL OR OF A DIFFERENT NATURE, ARE FOR INFORMATION PURPOSES ONLY WHEN PLACING AN ORDER, PLEASE, ALWAYS USE COSIBO REFERENCE NUMBERS AND DO NOT MENTION THE ORIGINAL REFERENCE NUMBERS OF THE TRUCK MANUFACTURERS IN THE INVOICE TO VEHICLE OWNERS OR TO ANYBODY ELSE. THE CUSTOMER TAKES HIS OWN RESPONSIBILITY IF HE DOES NOT COMPLY WITH WHAT ABOVE.

		Code	OEM new	OEM old
GASKET	● Model	60566	139616	
	★ Application			
	● 3 BUS			
	★ OSC11 G01			
	● IND. MARINE ENGINE 4			
	★ DSC14			
	● 3 TRUCK			
	★ DS/DSC11 - DS11 73 - DSC11 12 - DSC14 03/04/06/08/09/10/16			
	● 3 BUS	61490	365863	
	★ DS11 74/78 - DSC11 08/21/71 - DSH11 E01 - OSC11 G01			
	● 3 TRUCK			
	★ DS/DSC11 - DS11 34/75 - DTC11			
	● IND. MARINE ENGINE 4			
	★ D16 M - DC9/DSC9 A/M - DI12 41/59/62/64/65/70M - DSC9 47A - DS/DSC11			
GASKET		61486	364792	
	● 3 BUS			
	★			
	● 3 TRUCK			
	★ DN9 - DS9 4X4			
GASKET		61490/1	222499	
	● 3 TRUCK			
	★ DS/DSC11 - DS11 73 - DSC11 12 - DSC14 03/04/06/08/09/10/16			
	● 4 TRUCK			
	★ OSC11 G03			
● IND. MARINE ENGINE 4				
★ DC16 46A				

ALL THE COMPONENTS LISTED IN OUR CATALOGUE ARE NOT ORIGINAL, THOUGH PERFECTLY INTERCHANGEABLE. REFERENCE NUMBERS, EITHER ORIGINAL OR OF A DIFFERENT NATURE, ARE FOR INFORMATION PURPOSES ONLY WHEN PLACING AN ORDER, PLEASE, ALWAYS USE COSIBO REFERENCE NUMBERS AND DO NOT MENTION THE ORIGINAL REFERENCE NUMBERS OF THE TRUCK MANUFACTURERS IN THE INVOICE TO VEHICLE OWNERS OR TO ANYBODY ELSE. THE CUSTOMER TAKES HIS OWN RESPONSIBILITY IF HE DOES NOT COMPLY WITH WHAT ABOVE.

		Code	OEM new	OEM old
GASKET	● Model	61487	364791	
	★ Application			
	● 3 BUS			
	★			
	● 3 TRUCK			
	★ DN9 - DS9 4X4 - DS/DSC9			
	● IND. MARINE ENGINE 4			
★ D9 M - DS19 - DI9 56A - DSI/DI9 - DSC9 - DC9 A/M				

		61484	369276	170363
GASKET	● IND. MARINE ENGINE 4			
	★ D14 A/M - DSI14 68/69/73/74/75/78 M			
	● 3 TRUCK			
	★ DSC14 03/04/06/08/09/10/16			
	● 4 TRUCK			
	★ DSC14 13/15			

		61553	1320292	371491
GASKET	● 3 BUS			
	★ D11 - DS11 - DSC11 08/17/18/21/22/23/35/36/70 - DSC11			
	● 4 BUS			
	★ DSC11 - OSC11 G03			
	● IND. MARINE ENGINE 4			
	★ D11 - DI12 68M/69M - D12 A/M - DC12 57A - D12 49A - D9 A/M - DS11 95 A46S - DSC9 A/M - D14 A/M - SG9 A280 - DSC9 - DC9 A/M			
	● 3 TRUCK			
★ LHD/RHD - STREAMLINE RHD				
	● 4 TRUCK			
	★ DSC14 13/15 - DSC11 - OSC11 G03 - DSC9 - DC9 01/02/03/04/05/06			

ALL THE COMPONENTS LISTED IN OUR CATALOGUE ARE NOT ORIGINAL, THOUGH PERFECTLY INTERCHANGEABLE. REFERENCE NUMBERS, EITHER ORIGINAL OR OF A DIFFERENT NATURE, ARE FOR INFORMATION PURPOSES ONLY WHEN PLACING AN ORDER, PLEASE, ALWAYS USE COSIBO REFERENCE NUMBERS AND DO NOT MENTION THE ORIGINAL REFERENCE NUMBERS OF THE TRUCK MANUFACTURERS IN THE INVOICE TO VEHICLE OWNERS OR TO ANYBODY ELSE. THE CUSTOMER TAKES HIS OWN RESPONSIBILITY IF HE DOES NOT COMPLY WITH WHAT ABOVE.

		Code	OEM new	OEM old
GASKET	● Model	61835	378264	
	★ Application			
	● 3 BUS			
	★	DS11 74/78 - DSC11 04/24/27/71 - DSI11 E01 - DS/DSC11		
	● 4 BUS			
	★	DSC11 - OSC11 G03		
	● IND. MARINE ENGINE 4			
	★	DS/DSI 11 - DS/DSC/DSI 11A		
	● 3 TRUCK			
	★	DS/DSC/DTC11 - DS11 34/75		
● 4 TRUCK				
★	DSC11 - OSC11 G03			



		61836	1109288	
GASKET	● 3 BUS			
	★	DS11 74/78 - DSC11 04/24/27/71 - DSI11 E01 - DS/DSC11		
	● 4 BUS			
	★	DSC11 - OSC11 G03		
	● IND. MARINE ENGINE 4			
	★	DS/DSI 11 - DS/DSC/DSI 11A		
	● 3 TRUCK			
	★	DS/DSC/DTC11 - DS11 34/75		
	● 4 TRUCK			
	★	DSC11 - OSC11 G03		



		Code	OEM new	OEM old
GASKET	● Model	61838	1801737	1323354 1393937
	★ Application			
	● 3 BUS			
	★	DS11 74/78 - DSC11 04/08/21/24/27/71 - DSH1 E01 - DS/DSC 11 - OSC11 G01		
	● 4 BUS			
	★	DSC9 - DSI9 E01 - DC9 01/02/03/04/05/06 - OSC9 G01 - DC 11 - D 12 - DSC11 - OSC11 G03 - DSC9 - OSC9 - DSI9 - L/N/K 94 - D9 F94		
	● F-K-N BUS			
	★	D 11/12 - D9 PDE EGR - D9 XPI		
	● IND. MARINE ENGINE 4			
	★	DC 11 - D 12 - DC9 51/53/54/55 A - SG9 A280 - D9 - DC9 - DSC9 A/M - DI16 40/41/48/53 A -		
	● 3 TRUCK			
	★	DN9 - DS9 4X4 - DS/DSC 9/11 - DS11 34/75 - DTC 11		
	● 4 TRUCK			
	★	DC - DSC 9/11/12 - DC9 01/02/03/04/05/06 - DC12 4X4/6X6/8X8 - DT 12 - DC11 4X4/6X6 - DSI9 E01 - OSC9 G01 - D 12 - OSC11 G03 - DSC9 - OSC9 - DSI9		
● P-G-R-T TRUCK				
★	D 11/12 - D9 PDE EGR - D9 XPI			

		63862	1746684	1392459
GASKET	● 3 TRUCK			
	★	DSC14		
	● 4 TRUCK			
	★	DSC14 13/15		
	● IND. MARINE ENGINE 4			
★	DS14 - DSC14 - D14 A/M			

		Code	OEM new	OEM old
GASKET	● Model	63547	1309051	
	★ Application			
	● 4 BUS			
	★	DC 11/12 - DC9 20/21 - DSC12 01/02/03/05 - DC11 01/02/03/04/06/07 - DT12 - D12		
	● F-K-N BUS			
	★	D 9/11/12/16 - D9 PDE EGR - D9 F		
	● IND. MARINE ENGINE 4			
	★	DSC/DC 12 A - DSI/DI 12 A - DI 12 M - D12A/M EMS - DI 12 68/69M - DC12 54A - DC16 A - DI16 40/41/48/53 A - D16 M - D12 A/M - DC16		
	● IND. MARINE ENGINE 5			
	★	SGNA280 - DC9A EMS - DC9 69A		
● 4 TRUCK				
★	DC 11/12/16 - DSC12 - DC12 4X4/6X6/8X8 - DC11 4X4/6X6 - DT12 - DC9 20/21 - DSC12 01/02/03/05 - DC11 01/02/03/04/06/07 - DT12			
● P-G-R-T TRUCK				
★	D 9/11/12/16 - D 9/16 - D9 PDE EGR			



		63863	390918	
GASKET	● IND. MARINE ENGINE 4			
	★	D14 A/M		
	● 4 TRUCK			
	★	DSC14 13/15		



		64278	1336138	1485685
GASKET	● 4 BUS			
	★	DSC9 - DSI9 E01 - DC9 01/02/03/04/05/06 - OSC9 G01 - OSC9 - DSI9 - L/N/K94 - D9 F94		
	● IND. MARINE ENGINE 4			
	★	DC9 51/53/54/55 A - SG9 A280 - D9A/M		
	● 4 TRUCK			
★	DSC9 - DSI9 E01 - DC9 01/02/03/04/05/06 - OSC9 G01 - OSC9 - DSI9			



	Code	OEM new	OEM old
OIL SUMP GASKET KIT	60570	551438	
<ul style="list-style-type: none"> ● Model ★ Application 			
<ul style="list-style-type: none"> ● 3 TRUCK ★ 			

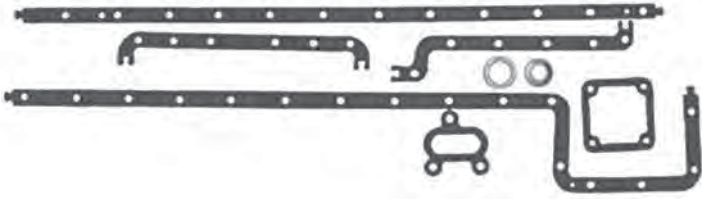

GASKET	61554	388402	
<ul style="list-style-type: none"> ● 3 TRUCK ★ 			



OIL SUMP GASKET	60568	371503	215242
<ul style="list-style-type: none"> ● 3 BUS ★ D11 ● 4 BUS ★ DSC11 - OSC11 G03 ● IND. MARINE ENGINE 4 ★ D11 ● 3 TRUCK ★ ● 4 TRUCK ★ DSC11 - OSC11 G03 			

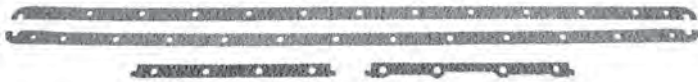

ALL THE COMPONENTS LISTED IN OUR CATALOGUE ARE NOT ORIGINAL, THOUGH PERFECTLY INTERCHANGEABLE. REFERENCE NUMBERS, EITHER ORIGINAL OR OF A DIFFERENT NATURE, ARE FOR INFORMATION PURPOSES ONLY WHEN PLACING AN ORDER, PLEASE, ALWAYS USE COSIBO REFERENCE NUMBERS AND DO NOT MENTION THE ORIGINAL REFERENCE NUMBERS OF THE TRUCK MANUFACTURERS IN THE INVOICE TO VEHICLE OWNERS OR TO ANYBODY ELSE. THE CUSTOMER TAKES HIS OWN RESPONSIBILITY IF HE DOES NOT COMPLY WITH WHAT ABOVE.

		Code	OEM new	OEM old
OIL SUMP GASKET	● Model	60569	1459004	371505
	★ Application			
	● IND. MARINE ENGINE 4			
	★ D14 A/M			
	● 3 TRUCK			
	★			
● 4 TRUCK				
★ DSC14 13/15				

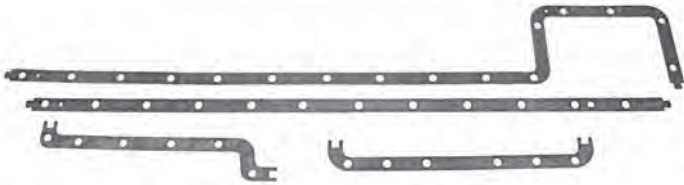

		61552	1412666	366539
OIL SUMP GASKET	● 3 BUS			
	★			
	● 4 BUS			
	★ DSC9 - DS19 E01 - DC9 01/02/03/04/05/06 - OSC9 G01 - DC9 - K94 DSC9 - K/L/ N94 DSC9-DS19 E01-DC9-OSC9 G01			
	● IND. MARINE ENGINE 4			
	★ DSC9 A/M - SG9 A280 - DSC9/DC9 A/M			
	● 3 TRUCK			
	★			
	● 4 TRUCK			
	★ DSC9 - DS19 E01 - DC9 01/02/03/04/05/06 - OSC9 G01			



		63120	1865675	1460362 1744775
OIL SUMP GASKET	● IND. MARINE ENGINE 4			
	★ DC16 - DC16A - DI16 40A/41A/48A/53A - D16M - D16 A/M			
	● 4 TRUCK			
	★ DC16			
	● P-G-R-T TRUCK			
	★ D16			

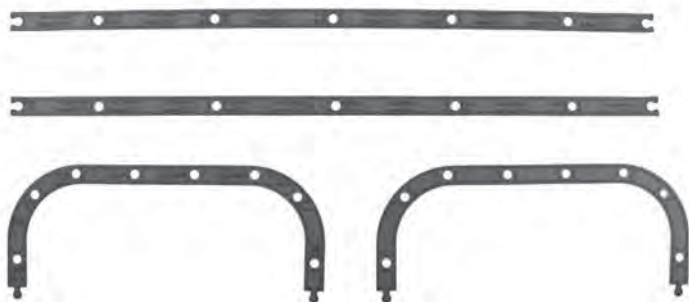

	Code	OEM new	OEM old
OIL SUMP GASKET KIT	60758	551365	
<ul style="list-style-type: none"> ● Model ★ Application 			
<ul style="list-style-type: none"> ● IND. MARINE ENGINE 4 ★ D14 A/M ● 4 TRUCK ★ DSC14 13/15 - CR/CT 144 DSC14 13/05 			

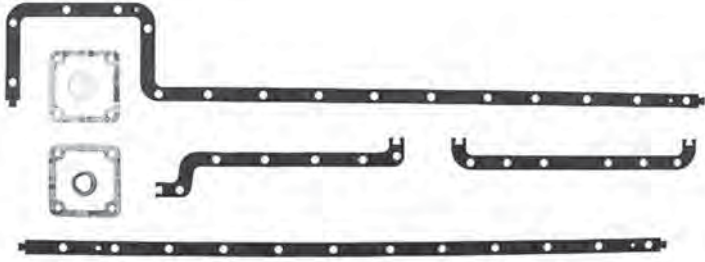

	61832	551450	550231
OIL SUMP GASKET KIT			
<ul style="list-style-type: none"> ● 3 BUS ★ ● 4 BUS ★ DSC9 - DS19 E01 - DC9 - OSC9 G01 ● IND. MARINE ENGINE 4 ★ D9 A/M - SG9 A280 - DSC9 A/M ● 3 TRUCK ★ ● 4 TRUCK ★ DSC9 - DC9 01/02/03/04/05/06 			

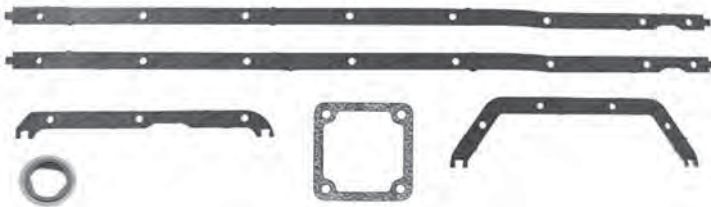

	61833	550343	551466
OIL SUMP GASKET KIT			
<ul style="list-style-type: none"> ● 3 BUS ★ D11 ● IND. MARINE ENGINE 4 ★ D11 ● 3 TRUCK ★ ● 4 TRUCK ★ DSC11 - OSC11 G03 - CP/CR DSC11/OSC11 - DSC11 CT 			

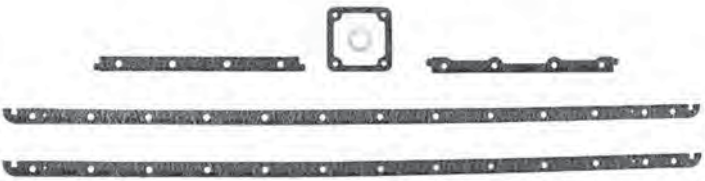

	Code	OEM new	OEM old
OIL SUMP GASKET KIT	63064	551351	
<ul style="list-style-type: none"> ● Model ★ Application 			
<ul style="list-style-type: none"> ● 4 BUS 			
<ul style="list-style-type: none"> ★ DC11 - D12 			
<ul style="list-style-type: none"> ● 4 TRUCK 			
<ul style="list-style-type: none"> ★ DC11 - D12 			



OIL SUMP GASKET	65370	1865674	1744774
<ul style="list-style-type: none"> ● 4 TRUCK 			
<ul style="list-style-type: none"> ★ DC11 - D12 			
<ul style="list-style-type: none"> ● P-G-R-T TRUCK 			
<ul style="list-style-type: none"> ★ D11 - D12 			
<ul style="list-style-type: none"> ● 4 BUS 			
<ul style="list-style-type: none"> ★ DC11 - D12 			
<ul style="list-style-type: none"> ● IND. MARINE ENGINE 4 			
<ul style="list-style-type: none"> ★ DC12.50A 			
<ul style="list-style-type: none"> ● F-K-N BUS 			
<ul style="list-style-type: none"> ★ D12 K 			

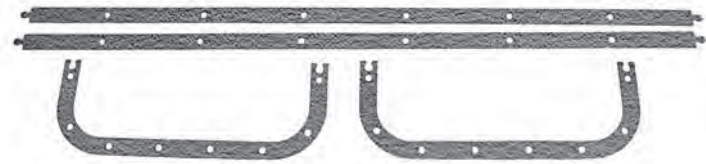

EXHAUST MANIFOLD KIT W/RINGS	62259/1	62259/1	
<ul style="list-style-type: none"> ● IND. MARINE ENGINE 4 			
<ul style="list-style-type: none"> ★ D14A 			
<ul style="list-style-type: none"> ● 3 TRUCK 			
<ul style="list-style-type: none"> ★ DSC14 08/09/10/16 			



ALL THE COMPONENTS LISTED IN OUR CATALOGUE ARE NOT ORIGINAL, THOUGH PERFECTLY INTERCHANGEABLE. REFERENCE NUMBERS, EITHER ORIGINAL OR OF A DIFFERENT NATURE, ARE FOR INFORMATION PURPOSES ONLY WHEN PLACING AN ORDER, PLEASE, ALWAYS USE COSIBO REFERENCE NUMBERS AND DO NOT MENTION THE ORIGINAL REFERENCE NUMBERS OF THE TRUCK MANUFACTURERS IN THE INVOICE TO VEHICLE OWNERS OR TO ANYBODY ELSE. THE CUSTOMER TAKES HIS OWN RESPONSIBILITY IF HE DOES NOT COMPLY WITH WHAT ABOVE.

	Code	OEM new	OEM old
EXHAUST MANIFOLD	65275	371211	
● Model			
★ Application			
● IND. MARINE ENGINE 4			
★ D14A			
● 3 TRUCK			
★ DSC14 08/09/10/16			



	Code	OEM new	OEM old
EXHAUST MANIFOLD	63408	1332967	
● IND. MARINE ENGINE 4			
★ D14A			
● 3 TRUCK			
★ DSC14 08/09/10/16			



	Code	OEM new	OEM old
EXHAUST MANIFOLD	63409	1332968	
● IND. MARINE ENGINE 4			
★ D14A			
● 3 TRUCK			
★ DSC14 08/09/10/16			



	Code	OEM new	OEM old
EXHAUST MANIFOLD	63410	1332969	
● IND. MARINE ENGINE 4			
★ D14A			
● 3 TRUCK			
★ DSC14 08/09/10/16			



ALL THE COMPONENTS LISTED IN OUR CATALOGUE ARE NOT ORIGINAL, THOUGH PERFECTLY INTERCHANGEABLE. REFERENCE NUMBERS, EITHER ORIGINAL OR OF A DIFFERENT NATURE, ARE FOR INFORMATION PURPOSES ONLY WHEN PLACING AN ORDER, PLEASE, ALWAYS USE COSIBO REFERENCE NUMBERS AND DO NOT MENTION THE ORIGINAL REFERENCE NUMBERS OF THE TRUCK MANUFACTURERS IN THE INVOICE TO VEHICLE OWNERS OR TO ANYBODY ELSE. THE CUSTOMER TAKES HIS OWN RESPONSIBILITY IF HE DOES NOT COMPLY WITH WHAT ABOVE.

RH EXHAUST MANIFOLD



- **Model**
- ★ **Application**
- **IND. MARINE ENGINE 4**
- ★ D14A
- **3 TRUCK**
- ★ DSC14 08/09/10/16

Code	OEM new	OEM old
63411	1332970	

LH EXHAUST MANIFOLD



- **IND. MARINE ENGINE 4**
- ★ D14A
- **3 TRUCK**
- ★ DSC14 08/09/10/16

63412	1332971	
--------------	---------	--

EXHAUST MANIFOLD KIT W/RINGS

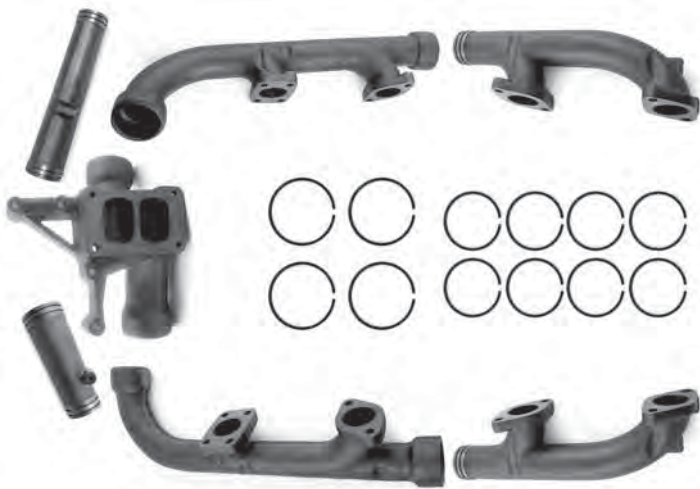

- **4 TRUCK**
- ★ DSC14 13/15

63777	63777	
--------------	-------	--

ALL THE COMPONENTS LISTED IN OUR CATALOGUE ARE NOT ORIGINAL, THOUGH PERFECTLY INTERCHANGEABLE. REFERENCE NUMBERS, EITHER ORIGINAL OR OF A DIFFERENT NATURE, ARE FOR INFORMATION PURPOSES ONLY WHEN PLACING AN ORDER, PLEASE, ALWAYS USE COSIBO REFERENCE NUMBERS AND DO NOT MENTION THE ORIGINAL REFERENCE NUMBERS OF THE TRUCK MANUFACTURERS IN THE INVOICE TO VEHICLE OWNERS OR TO ANYBODY ELSE. THE CUSTOMER TAKES HIS OWN RESPONSIBILITY IF HE DOES NOT COMPLY WITH WHAT ABOVE.

	Code	OEM new	OEM old
EXHAUST MANIFOLD	63780	1354420	



- Model
 - ★ Application
- | |
|------------------|
| ● 4 TRUCK |
| ★ DSC14 13/15 |

LH EXHAUST MANIFOLD	63781	1340899	
----------------------------	--------------	---------	--



- **4 TRUCK**
- ★ DSC14 13/15

RH EXHAUST MANIFOLD	63782	1354428	
----------------------------	--------------	---------	--



- **4 TRUCK**
- ★ DSC14 13/15

EXHAUST MANIFOLD	63784	1422198	1354423
-------------------------	--------------	---------	---------



- **4 TRUCK**
- ★ DSC14 13/15

EXHAUST MANIFOLD	63785	1422200	1354424
-------------------------	--------------	---------	---------



- **4 TRUCK**
- ★ DSC14 13/15

ALL THE COMPONENTS LISTED IN OUR CATALOGUE ARE NOT ORIGINAL, THOUGH PERFECTLY INTERCHANGEABLE. REFERENCE NUMBERS, EITHER ORIGINAL OR OF A DIFFERENT NATURE, ARE FOR INFORMATION PURPOSES ONLY WHEN PLACING AN ORDER, PLEASE, ALWAYS USE COSIBO REFERENCE NUMBERS AND DO NOT MENTION THE ORIGINAL REFERENCE NUMBERS OF THE TRUCK MANUFACTURERS IN THE INVOICE TO VEHICLE OWNERS OR TO ANYBODY ELSE. THE CUSTOMER TAKES HIS OWN RESPONSIBILITY IF HE DOES NOT COMPLY WITH WHAT ABOVE.

LH/RH EXHAUST MANIFOLD



- Model
- ★ Application

Code	OEM new	OEM old
63783	1355353	

- **4 TRUCK**
- ★ DSC14 13/15

EXHAUST MANIFOLD KIT W/RINGS

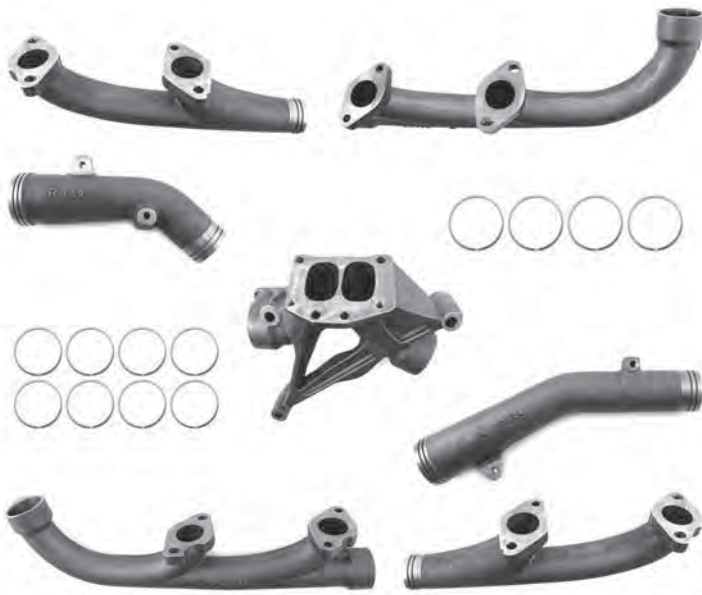

- **IND. MARINE ENGINE 4**

63925	63925	
--------------	-------	--

- ★ DC16A

- **4 TRUCK**

- ★ DC16

- **P-G-R-T TRUCK**

- ★ D16

EXHAUST MANIFOLD



- **IND. MARINE ENGINE 4**

63919	1863896	1520700 1793582
--------------	---------	--------------------

- ★ DC16A

- **4 TRUCK**

- ★ DC16

- **P-G-R-T TRUCK**

- ★ D16

ALL THE COMPONENTS LISTED IN OUR CATALOGUE ARE NOT ORIGINAL, THOUGH PERFECTLY INTERCHANGEABLE. REFERENCE NUMBERS, EITHER ORIGINAL OR OF A DIFFERENT NATURE, ARE FOR INFORMATION PURPOSES ONLY WHEN PLACING AN ORDER, PLEASE, ALWAYS USE COSIBO REFERENCE NUMBERS AND DO NOT MENTION THE ORIGINAL REFERENCE NUMBERS OF THE TRUCK MANUFACTURERS IN THE INVOICE TO VEHICLE OWNERS OR TO ANYBODY ELSE. THE CUSTOMER TAKES HIS OWN RESPONSIBILITY IF HE DOES NOT COMPLY WITH WHAT ABOVE.

	Code	OEM new	OEM old
EXHAUST MANIFOLD	63920	1541367	1381069
<ul style="list-style-type: none"> ● Model ★ Application 			
<ul style="list-style-type: none"> ● IND. MARINE ENGINE 4 ★ DC16A 			
<ul style="list-style-type: none"> ● 4 TRUCK ★ DC16 			
<ul style="list-style-type: none"> ● P-G-R-T TRUCK ★ D16 			



EXHAUST MANIFOLD	63921	1541368	1381070
<ul style="list-style-type: none"> ● IND. MARINE ENGINE 4 ★ DC16A 			
<ul style="list-style-type: none"> ● 4 TRUCK ★ DC16 			
<ul style="list-style-type: none"> ● P-G-R-T TRUCK ★ D16 			



EXHAUST MANIFOLD	63922	1850826	1503932
<ul style="list-style-type: none"> ● IND. MARINE ENGINE 4 ★ DC16A 			
<ul style="list-style-type: none"> ● 4 TRUCK ★ DC16 			
<ul style="list-style-type: none"> ● P-G-R-T TRUCK ★ D16 			



ALL THE COMPONENTS LISTED IN OUR CATALOGUE ARE NOT ORIGINAL, THOUGH PERFECTLY INTERCHANGEABLE. REFERENCE NUMBERS, EITHER ORIGINAL OR OF A DIFFERENT NATURE, ARE FOR INFORMATION PURPOSES ONLY WHEN PLACING AN ORDER, PLEASE, ALWAYS USE COSIBO REFERENCE NUMBERS AND DO NOT MENTION THE ORIGINAL REFERENCE NUMBERS OF THE TRUCK MANUFACTURERS IN THE INVOICE TO VEHICLE OWNERS OR TO ANYBODY ELSE. THE CUSTOMER TAKES HIS OWN RESPONSIBILITY IF HE DOES NOT COMPLY WITH WHAT ABOVE.

RH EXHAUST MANIFOLD



	Code	OEM new	OEM old
● Model	63923	1863897	1520701
★ Application			1793583
● IND. MARINE ENGINE 4			
★ DC16A			
● 4 TRUCK			
★ DC16			
● P-G-R-T TRUCK			
★ D16			

LH EXHAUST MANIFOLD



	Code	OEM new	OEM old
	63924	1863898	1520702
			1793584
● IND. MARINE ENGINE 4			
★ DC16A			
● 4 TRUCK			
★ DC16			
● P-G-R-T TRUCK			
★ D16			

EXHAUST MANIFOLD



	Code	OEM new	OEM old
	61908	1349045	
● IND. MARINE ENGINE 4			
★			
● 3 TRUCK			
★ DSC14 08/09/10/16			

EXHAUST MANIFOLD



	Code	OEM new	OEM old
	62047	326631	
● 3 TRUCK			
★ DS/DSC11 - DS11 73 - DSC11 12			

ALL THE COMPONENTS LISTED IN OUR CATALOGUE ARE NOT ORIGINAL, THOUGH PERFECTLY INTERCHANGEABLE. REFERENCE NUMBERS, EITHER ORIGINAL OR OF A DIFFERENT NATURE, ARE FOR INFORMATION PURPOSES ONLY WHEN PLACING AN ORDER, PLEASE, ALWAYS USE COSIBO REFERENCE NUMBERS AND DO NOT MENTION THE ORIGINAL REFERENCE NUMBERS OF THE TRUCK MANUFACTURERS IN THE INVOICE TO VEHICLE OWNERS OR TO ANYBODY ELSE. THE CUSTOMER TAKES HIS OWN RESPONSIBILITY IF HE DOES NOT COMPLY WITH WHAT ABOVE.

		Code	OEM new	OEM old
EXHAUST MANIFOLD	● Model	63607	1109281	
	★ Application			
	● 3 BUS			
	★ DS/DSC11			
● IND. MARINE ENGINE 4				
★ DS/DSI11				



		63376	1374700	354334
EXHAUST MANIFOLD	● 3 TRUCK			
	★ DS/DSC 11 - DS11 34/75			
	● 4 TRUCK			
	★ DSC 11			
	● 3 BUS			
	★ DS11 74/78 - DSC11 04/24/27/71 - DSI11 E01 - DS/DSC11			
● IND. MARINE ENGINE 4				
★ DS/DSI 11				



		63377	1380451	1109278
EXHAUST MANIFOLD	● 3 TRUCK			
	★ DS/DSC 11 - DS11 34/75			
	● 4 TRUCK			
	★ DSC 11			
	● 3 BUS			
	★ DS11 74/78 - DSC11 04/24/27/71 - DSI11 E01 - DS/DSC11			
● IND. MARINE ENGINE 4				
★ DS/DSI 11				



	Code	OEM new	OEM old
EXHAUST MANIFOLD	63378	1371209	1109279
● Model			
★ Application			
● 3 TRUCK			
★ DS/DSC11 - DS11 34/75			
● 3 BUS			
★ DS11 74/78 - DSC11 04/24/27/71 - DSI11 E01			
● IND. MARINE ENGINE 4			
★			



EXHAUST MANIFOLD	63468	270739	
● 3 TRUCK			
★ DS/DSC11 - DS11 73 6X4 - DSC11 12 6X4			



EXHAUST MANIFOLD	63469	270738	
● 3 TRUCK			
★ DS/DSC11 - CP RHD - DS11 73 - DSC11 12 6X4			



	Code	OEM new	OEM old
EXHAUST MANIFOLD	63470	293853	
<ul style="list-style-type: none"> ● Model ★ Application 			
<ul style="list-style-type: none"> ● 3 TRUCK ★ DS/DSC11 - DS11 73 6X4 - DSC11 12 6X4 			



EXHAUST MANIFOLD	63619	1395248	
<ul style="list-style-type: none"> ● 4 TRUCK ★ DSC11 			



EXHAUST MANIFOLD	63649	1671745	
<ul style="list-style-type: none"> ● 3 TRUCK ★ 			



EXHAUST MANIFOLD	65227	1866391	1374099 1792308
<ul style="list-style-type: none"> ● 4 BUS ★ DC11 - D12 ● IND. MARINE ENGINE 4 ★ DSI/DI 12 A - DSC/DC 12 A - DC12 54A 			



ALL THE COMPONENTS LISTED IN OUR CATALOGUE ARE NOT ORIGINAL, THOUGH PERFECTLY INTERCHANGEABLE. REFERENCE NUMBERS, EITHER ORIGINAL OR OF A DIFFERENT NATURE, ARE FOR INFORMATION PURPOSES ONLY WHEN PLACING AN ORDER, PLEASE, ALWAYS USE COSIBO REFERENCE NUMBERS AND DO NOT MENTION THE ORIGINAL REFERENCE NUMBERS OF THE TRUCK MANUFACTURERS IN THE INVOICE TO VEHICLE OWNERS OR TO ANYBODY ELSE. THE CUSTOMER TAKES HIS OWN RESPONSIBILITY IF HE DOES NOT COMPLY WITH WHAT ABOVE.

	Code	OEM new	OEM old
EXHAUST MANIFOLD	65279	1853773	1384089 1413894 1470305
● Model			
★ Application			
● 4 TRUCK			
★ DC/DSC12 - DC12 4X4/6X6/8X8 - DC11 4X4/6X6 - DC11 - DT12			
● P-G-R-T TRUCK			
★ D11 - D12			
● 4 BUS			
★ DC11 - D12			
● IND. MARINE ENGINE 4			
★ DC12 54A - DSI/DI 12 A - DSC/DC 12 A			
● F-K-N BUS			
★ D11 - D12			

**BIG JUNCTION SLEEVE**

	61491	170948	
● 3 TRUCK			
★ DSC14 03/04/06/08/09/10/16			
● IND. MARINE ENGINE 4			
★			

SEAL RING

	61492	170955	
● 3 TRUCK			
★ DSC14 03/04/06/08/09/10/16			
● IND. MARINE ENGINE 4			
★			

ALL THE COMPONENTS LISTED IN OUR CATALOGUE ARE NOT ORIGINAL, THOUGH PERFECTLY INTERCHANGEABLE. REFERENCE NUMBERS, EITHER ORIGINAL OR OF A DIFFERENT NATURE, ARE FOR INFORMATION PURPOSES ONLY WHEN PLACING AN ORDER, PLEASE, ALWAYS USE COSIBO REFERENCE NUMBERS AND DO NOT MENTION THE ORIGINAL REFERENCE NUMBERS OF THE TRUCK MANUFACTURERS IN THE INVOICE TO VEHICLE OWNERS OR TO ANYBODY ELSE. THE CUSTOMER TAKES HIS OWN RESPONSIBILITY IF HE DOES NOT COMPLY WITH WHAT ABOVE.

	Code	OEM new	OEM old
SMALL JUNCTION SLEEVE	61538	276087	
			
● Model			
★ Application			
● 3 BUS			
★ DS11 74/78 - DSC11 04/24/27/71 - DSI11 E01			
● 3 TRUCK			
★ DS/DSC11 - DS11 34/73/75 - DSC11 12			
● 4 TRUCK			
★ OSC11 G03			

	63375	1356677	355939
SEAL RING			
			
● 3 BUS			
★ DS11 74/78 - DSC11 04/24/27/71 - DSI11 E01 - DS/DSC 11			
● 4 BUS			
★ DSC11 - OSC11 G03 -			
● IND. MARINE ENGINE 4			
★ DS/DSI 11			
● 3 TRUCK			
★ DS/DSC 11 - DS11 34/75 - DTC 11			
● 4 TRUCK			
★ DSC11 - OSC11 G03			

	60073	250996	279052
SEAL RING			
			
● 3 BUS			
★ OSC11 G01			
● 3 TRUCK			
★ DS/DSC11 - DSC11 73 - DSC11 12 - DS11 73			
● 4 TRUCK			
★ OSC11 G03			

ALL THE COMPONENTS LISTED IN OUR CATALOGUE ARE NOT ORIGINAL, THOUGH PERFECTLY INTERCHANGEABLE. REFERENCE NUMBERS, EITHER ORIGINAL OR OF A DIFFERENT NATURE, ARE FOR INFORMATION PURPOSES ONLY WHEN PLACING AN ORDER, PLEASE, ALWAYS USE COSIBO REFERENCE NUMBERS AND DO NOT MENTION THE ORIGINAL REFERENCE NUMBERS OF THE TRUCK MANUFACTURERS IN THE INVOICE TO VEHICLE OWNERS OR TO ANYBODY ELSE. THE CUSTOMER TAKES HIS OWN RESPONSIBILITY IF HE DOES NOT COMPLY WITH WHAT ABOVE.

		Code	OEM new	OEM old
SEAL RING	● Model	61537	15323	
	★ Application			
	● 3 BUS			
	★	DS11 74/78 - DSC11 04/24/27/71 - DSI11 E01 - DS/DSC11		
	● 4 BUS			
	★	D9 F94		
	● IND. MARINE ENGINE 4			
	★	DSC9/DC9 A/M - DSC9 47A		
	● 3 TRUCK			
	★	DN9 - DS9 4X4 - DN11 01 - DS/DSC11 - DS11 34/73/75 - DSC11 12 - DS/DSC9 - DTC11		
● 4 TRUCK				
★	OSC11 G03			



		65313	1439814	1423610
SEAL RING	● 3 BUS			
	★	GR801R		
	● 4 BUS			
	★	DC11 - D12 - K94 - DC9 19/ 20/ 21 - DSC9 - DSI9 E01 - DC9 - F94 - K/ L/ N94 - OSC9 G01 - GR801R		
	● F-K-N BUS			
	★	D9 PDE - GR801R/ GR900R/ GRS890R/ GRS900R/ GRS920R/ GRSO900R - D12K - D9 K/ N		
	● IND. MARINE ENGINE 4			
	★	DI12 68M - SG9 A280 - DC12 50A - D12A/ M - DC16A - D16M - D16A/ M		
	● IND. MARINE ENGINE 5			
	★	SG9 A280 - DC9A EMS		
	● 3 TRUCK			
	★	AD85 RBP730 6X4 - 8X4 - AD85 RP730 6X4 - 8X4 - GR/ GRS900R		
	● 4 TRUCK			
★	DC11 - D12 - DSC14 13/ 15 - DSC11 - OSC11 G03 - DSC9 - DC9 01/ 02/ 03/ 04/ 05/ 06/ 19/ 20/ 21 - DC16 - GR/ GRS/ GRSH/ R/ GRSO/ R			
● P-G-R-T TRUCK				
★	D9 PDE - GR801R/ GR900R/ GRS890R/ GRS900R/ GRS920R/ GRSO900R - D11 - D12 - D16 - D9 - D13 XPI			



	Code	OEM new	OEM old
BIG SEAL RING	63414	1545479	394794
● Model			
★ Application			
● IND. MARINE ENGINE 4			
★ D14A			
● 3 TRUCK			
★ DSC14 08/09/10/16			
● 4 TRUCK			
★ DSC14 13/15			



	64690	1794745	
EXHAUST MANIFOLD RING SET			
● 3 TRUCK			
★ DSC14 08/09/10/16			
● 4 TRUCK			
★ DSC14 13/15			
● IND. MARINE ENGINE 4			
★ D14A			



	65312	1775965	
BIG RING			
● 4 BUS			
★ DC9 19/20/21 - DC11 - D12			
● F-K-N BUS			
★ D11 - D12 - D9 PDE EGR - D9 F			
● IND. MARINE ENGINE 4			
★ DC16 A			
● IND. MARINE ENGINE 5			
★ DC9A EMS - SG9 A280 - DC9 69A			
● 4 TRUCK			
★ DC9 19/20/21 - DC16			
● P-G-R-T TRUCK			
★ D9 - D11 - D12 - D16 - D9 PDE EGR			



	Code	OEM new	OEM old
SMALL SEAL RING	63413	1333116	
● Model			
★ Application			
● IND. MARINE ENGINE 4			
★ D14A			
● 3 TRUCK			
★ DSC14 08/09/10/16			
● 4 TRUCK			
★ DSC14 13/15			



	65311	1775964	
SMALL RING			
● 4 BUS			
★ DC9 19/20/21 - DC11 - D12			
● F-K-N BUS			
★ D11 - D12 - D9 PDE EGR - D9 F			
● IND. MARINE ENGINE 4			
★ DC16 A			
● IND. MARINE ENGINE 5			
★ DC9A EMS - SG9 A280 - DC9 69A			
● 4 TRUCK			
★ DC9 19/20/21 - DC16			
● P-G-R-T TRUCK			
★ D9 - D11 - D12 - D16 - D9 PDE EGR			



		Code	OEM new	OEM old
SEAL RING	● Model	61707	1545478	1408455 250995 278531
	★ Application			
	● 3 BUS			
	★ OSC11 G01			
	● 4 BUS			
	★ DC9 19/20/21 - DC11/D12			
	● F-K-N BUS			
	★ D11/D12 - D9 PDE EGR - DT12 - DC12 - D9 PDE			
	● IND. MARINE ENGINE 4			
	★ DSI/DI 12 A - DSC/DC 12 A - DC 12 54A - D9A - DI9 56A - DC16A - DI 16 40/41/48/53 A - DC16 - DSC9/DC9 A/M			
	● IND. MARINE ENGINE 5			
	★ SG9 A280 - DC9A EMS			
	● 3 TRUCK			
	★ DN9 - DS9 4X4 - DS/DSC9 -			
	● 4 TRUCK			
	★ DC16 - DC9 19/20/21 - DSC12/DC12 4X4/6X6/8X8 - DSC12 - DSC12/DC12 - DC11 4X4/6X6 - DC11 - DT12			
	● P-G-R-T TRUCK			
	★ D11/D12 - D9 - D9 PDE EGR - DT12 - DC12 - D9 PDE			

ALL THE COMPONENTS LISTED IN OUR CATALOGUE ARE NOT ORIGINAL, THOUGH PERFECTLY INTERCHANGEABLE. REFERENCE NUMBERS, EITHER ORIGINAL OR OF A DIFFERENT NATURE, ARE FOR INFORMATION PURPOSES ONLY WHEN PLACING AN ORDER, PLEASE, ALWAYS USE COSIBO REFERENCE NUMBERS AND DO NOT MENTION THE ORIGINAL REFERENCE NUMBERS OF THE TRUCK MANUFACTURERS IN THE INVOICE TO VEHICLE OWNERS OR TO ANYBODY ELSE. THE CUSTOMER TAKES HIS OWN RESPONSIBILITY IF HE DOES NOT COMPLY WITH WHAT ABOVE.

	Code	OEM new	OEM old
OIL PUMP REPAIR KIT	64379	64379	
● Model			
★ Application			
● 3 BUS			
★ GR801R			
● 4 BUS			
★ DC11 - D12 - K94 - DC9 19/ 20/ 21 - DSC9 - DSI9 E01 - DC9 - F94 - K/ L/ N94 - OSC9 G01 - GR801R			
● F-K-N BUS			
★ D9 PDE - GR801R/ GR900R/ GRS890R/ GRS900R/ GRS920R/ GRSO900R - D12K - D9 K/ N			
● IND. MARINE ENGINE 4			
★ DI12 68M - SG9 A280 - DC12 50A - D12A/ M - DC16A - D16M - D16A/ M			
● IND. MARINE ENGINE 5			
★ SG9 A280 - DC9A EMS			
● 3 TRUCK			
★ AD85 RBP730 6X4 - 8X4 - AD85 RP730 6X4 - 8X4 - GR/ GRS900R			
● 4 TRUCK			
★ DC11 - D12 - DSC14 13/ 15 - DSC11 - OSC11 G03 - DSC9 - DC9 01/ 02/ 03/ 04/ 05/ 06/ 19/ 20/ 21 - DC16 - GR/ GRS/ GRSH/ R/ GRSO/ R			
● P-G-R-T TRUCK			
★ D9 PDE - GR801R/ GR900R/ GRS890R/ GRS900R/ GRS920R/ GRSO900R - D11 - D12 - D16 - D9 - D13 XPI			



	Code	OEM new	OEM old
THREAD FITTING	61917	180435	
● Model			
★ Application			
● 3 BUS			
★ GR801R			
● 4 BUS			
★ DC11 - D12 - K94 - DC9 19/ 20/ 21 - DSC9 - DSI9 E01 - DC9 - F94 - K/ L/ N94 - OSC9 G01 - GR801R			
● F-K-N BUS			
★ D9 PDE - GR801R/ GR900R/ GRS890R/ GRS900R/ GRS920R/ GRSO900R - D12K - D9 K/ N			
● IND. MARINE ENGINE 4			
★ DI12 68M - SG9 A280 - DC12 50A - D12A/ M - DC16A - D16M - D16A/ M			
● IND. MARINE ENGINE 5			
★ SG9 A280 - DC9A EMS			
● 3 TRUCK			
★ AD85 RBP730 6X4 - 8X4 - AD85 RP730 6X4 - 8X4 - GR/ GRS900R			
● 4 TRUCK			
★ DC11 - D12 - DSC14 13/ 15 - DSC11 - OSC11 G03 - DSC9 - DC9 01/ 02/ 03/ 04/ 05/ 06/ 19/ 20/ 21 - DC16 - GR/ GRS/ GRSH/ R/ GRSO/ R			
● P-G-R-T TRUCK			
★ D9 PDE - GR801R/ GR900R/ GRS890R/ GRS900R/ GRS920R/ GRSO900R - D11 - D12 - D16 - D9 - D13 XPI			



	Code	OEM new	OEM old
DRAIN PLUG	61204	1433641	1423608 165282
● Model			
★ Application			
● 3 BUS			
★ GR801R			
● 4 BUS			
★ DC11 - D12 - K94 - DC9 19/ 20/ 21 - DSC9 - DSI9 E01 - DC9 - F94 - K/ L/ N94 - OSC9 G01 - GR801R			
● F-K-N BUS			
★ D9 PDE - GR801R/ GR900R/ GRS890R/ GRS900R/ GRS920R/ GRSO900R - D12K - D9 K/ N			
● IND. MARINE ENGINE 4			
★ DI12 68M - SG9 A280 - DC12 50A - D12A/ M - DC16A - D16M - D16A/ M			
● IND. MARINE ENGINE 5			
★ SG9 A280 - DC9A EMS			
● 3 TRUCK			
★ AD85 RBP730 6X4 - 8X4 - AD85 RP730 6X4 - 8X4 - GR/ GRS900R			
● 4 TRUCK			
★ DC11 - D12 - DSC14 13/ 15 - DSC11 - OSC11 G03 - DSC9 - DC9 01/ 02/ 03/ 04/ 05/ 06/ 19/ 20/ 21 - DC16 - GR/ GRS/ GRSH/ R/ GRSO/ R			
● P-G-R-T TRUCK			
★ D9 PDE - GR801R/ GR900R/ GRS890R/ GRS900R/ GRS920R/ GRSO900R - D11 - D12 - D16 - D9 - D13 XPI			



		Code	OEM new	OEM old
GASKET	● Model	61205	165286	
	★ Application			
	● 3 BUS			
	★	GR801R		
	● 3 TRUCK			
	★	AD85 RBP730 6X4 - 8X4 - AD85 RP730 6X4 - 8X4 - GR/GRS900R		
	● 4 BUS			
	★	DC11 - D12 - K94 - DC9 19/20/21 - DSC9 - DSI9 E01 - DC9 - F94 - K/L/N94 - OSC9 G01 - GR801R		
	● 4 TRUCK			
	★	DC11 - D12 - DSC14 13/15 - DSC11 - OSC11 G03 - DSC9 - DC9 01/02/03/04/05/06/19/20/21 - DC16 - GR/GRS/GRSH/R/GRSO/R		
	● F-K-N BUS			
	★	D9 PDE - GR801R/GR900R/GRS890R/GRS900R/GRS920R/GRS0900R - D12K - D9 K/N		
	● IND. MARINE ENGINE 4			
	★	DI12 68M - SG9 A280 - DC12 50A - D12A/M - DC16A - D16M - D16A/M		
	● IND. MARINE ENGINE 5			
★	SG9 A280 - DC9A EMS			
● P-G-R-T TRUCK				
★	D9 PDE - GR801R/GR900R/GRS890R/GRS900R/GRS920R/GRS0900R - D11 - D12 - D16 - D9 - D13 XPI			



		Code	OEM new	OEM old	
SCREW 	● Model	63303	1108053		
	★ Application				
	● 3 BUS				
	★	DS11 74/78 - DSC11 71 - DSI11 E01 - DS/DSC11 - DSC11 04/24/27			
	● 4 BUS				
	★	ARA 860			
	● F-K-N BUS				
	★	D11 - D12 - D9 PDE - D9 XPI - ARA 860			
	● IND. MARINE ENGINE 4				
	★	DSI/DI12 A - DSC/DC12 A - DC12 54A - DS/DSI 11 - DC16 A - DC16			
	● IND. MARINE ENGINE 5				
	★	SG9 A280 - DC9A EMS			
	● 3 TRUCK				
	★	DS/DSC11 - DS11 34/75 - DTC11			
	● 4 TRUCK				
	★	DC9 19/20/21 - DSC11 - CP/CR 14 - CP/CR 19 114/124 - D16 - DC16			
	● P-G-R-T TRUCK				
★	D11 - D12 - D9 PDE - D9 XPI - D16 - D13 XPI - D9				

ALL THE COMPONENTS LISTED IN OUR CATALOGUE ARE NOT ORIGINAL, THOUGH PERFECTLY INTERCHANGEABLE. REFERENCE NUMBERS, EITHER ORIGINAL OR OF A DIFFERENT NATURE, ARE FOR INFORMATION PURPOSES ONLY WHEN PLACING AN ORDER, PLEASE, ALWAYS USE COSIBO REFERENCE NUMBERS AND DO NOT MENTION THE ORIGINAL REFERENCE NUMBERS OF THE TRUCK MANUFACTURERS IN THE INVOICE TO VEHICLE OWNERS OR TO ANYBODY ELSE. THE CUSTOMER TAKES HIS OWN RESPONSIBILITY IF HE DOES NOT COMPLY WITH WHAT ABOVE.

		Code	OEM new	OEM old
GASKET	● Model	65119	1392929	371502
	★ Application			
	● 3 TRUCK			
	★			
	● IND.MARINE ENGINE 3			
★				
● IND. MARINE ENGINE 4				
★				
O-RING		61193	1769799	211818 372985
	● 3 BUS			
	★			
	● 4 BUS			
	★ L D9/DC11/D12/D14 12.2BAR - S D9/DC11/D12/D14 - DSC9 - DS19 E01 - DC9 01/02/03/04/05/06 - OSC9 G01 - DSC11 - OSC11 G03			
	● F-K-N BUS			
	★ D12 HPI - D9 - D11 - D12 PDE - D9 PDE - D9 XP			
	● IND. MARINE ENGINE 4			
	★ D/DC/DI 9/9A/11A/11M/14A/14M - D12A/M - D12A/M EMS - D16A/M - DI12 49A - DC12 57A - DI12 68M - D9M - DC9 51/53/54/55A - DI16 48A/53A - DC16 - DSC9/DC9 A/M			
	● IND. MARINE ENGINE 5			
	★ DC9A EMS - SG9 A280			
	● 3 TRUCK			
	★ L - M - DSC14 13/15			
	● 4 TRUCK			
	★ DC16 - S D16 - L D16 9.3BAR/12.2BAR - L D9/DC11/D12/D14 9.3BAR/12.2BAR - L D12 HPI 9.3BAR/12.2BAR - S D9/DC11/D12/D14 - S D12 HPI - S DSC11 - DSC12 - DC12 01/02/03/09 - DSC14 13/15 - DSC11 - OSC9 G01 - OSC11 G03 - DSC9 - DS19 E01 - DC9 01/02/03/04/05/06 - DT12			
● P-G-R-T TRUCK				
★ D16 - HPI - D9 - D11 - D12 PDE - D13 - D9 PDE - D9 XPI				

ALL THE COMPONENTS LISTED IN OUR CATALOGUE ARE NOT ORIGINAL, THOUGH PERFECTLY INTERCHANGEABLE. REFERENCE NUMBERS, EITHER ORIGINAL OR OF A DIFFERENT NATURE, ARE FOR INFORMATION PURPOSES ONLY WHEN PLACING AN ORDER, PLEASE, ALWAYS USE COSIBO REFERENCE NUMBERS AND DO NOT MENTION THE ORIGINAL REFERENCE NUMBERS OF THE TRUCK MANUFACTURERS IN THE INVOICE TO VEHICLE OWNERS OR TO ANYBODY ELSE. THE CUSTOMER TAKES HIS OWN RESPONSIBILITY IF HE DOES NOT COMPLY WITH WHAT ABOVE.

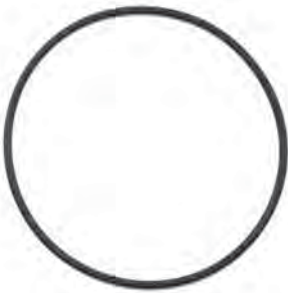
		Code	OEM new	OEM old	
O-RING	● Model	61194	1769798	290534	
	★ Application				372984
	● 3 BUS				
	★				
	● 4 BUS				
	★	L D9/DC11/D12/D14 12.2BAR - S D9/DC11/D12/D14 - DSC9 - DS19 E01 - DC9 01/02/03/04/05/06 - OSC9 G01 - DSC11 - OSC11 G03			
	● F-K-N BUS				
	★	D12 HPI - D9 - D11 - D12 PDE - D9 PDE - D9 XP			
	● IND. MARINE ENGINE 4				
	★	D/DC/DI 9/9A/11A/11M/14A/14M - D12A/M - D12A/M EMS - D16A/M - DI12 49A - DC12 57A - DI12 68M - D9M - DC9 51/53/54/55A - DI16 48A/53A - DC16 - DSC9/DC9 A/M			
	● IND. MARINE ENGINE 5				
	★	DC9A EMS - SG9 A280			
	● 3 TRUCK				
	★	L - M - DSC14 13/15			
	● 4 TRUCK				
	★	DC16 - S D16 - L D16 9.3BAR/12.2BAR - L D9/DC11/D12/D14 9.3BAR/12.2BAR - L D12 HPI 9.3BAR/12.2BAR - S D9/DC11/D12/D14 - S D12 HPI - S DSC11 - DSC12 - DC12 01/02/03/09 - DSC14 13/15 - DSC11 - OSC9 G01 - OSC11 G03 - DSC9 - DS19 E01 - DC9 01/02/03/04/05/06 - DT12			
	● P-G-R-T TRUCK				
★	D16 - HPI - D9 - D11 - D12 PDE - D13 - D9 PDE - D9 XPI				

	Code	OEM new	OEM old
O-RING	61902	1769800	1475433
● Model			
★ Application			
● 4 BUS			
★ L D9/DC11/D12/D14 12.2BAR - S D9/DC11/D12/D14 - DC9 19/20/21 - DC11 D12			
● F-K-N BUS			
★ D9 PDE/D11/D12 - D9 XPI - L/S D12 HPI - L/S D9/D11/D12 PDE			
● IND. MARINE ENGINE 4			
★ D12A/M - DI12 49A/68M - DC12 57A			
● IND. MARINE ENGINE 5			
★ DC9A EMS - SG9 A280			
● 4 TRUCK			
★ L D9/DC11/D12/D14 9.3BAR/12.2BAR - S D9/DC11/D12/D14 - DC9 19/20/21 - DC11 D12 - L D12 HPI 9.3BAR/12.2BAR - S D12 HPI			
● P-G-R-T TRUCK			
★ L/S HPI - L/S D9/D11/D12 PDE - D13 - D9 PDE/D11/D12 - D9 XPI			

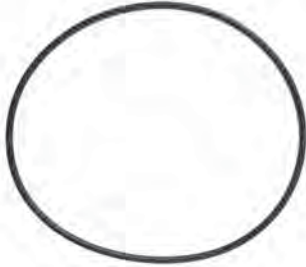

LUBE SYST.O-R DIAM.107,5X3,53	61233	211813	
● 4 TRUCK			
★ DC11 - DSC9 - DSC - OSC11 - DC - DSC - DT12 -			

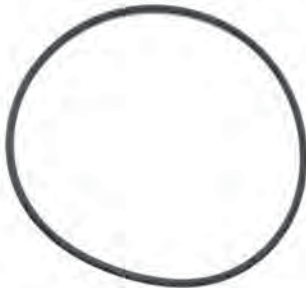

	Code	OEM new	OEM old
GASKET SET	64129	64129	
● Model			
★ Application			
● 3 BUS			
★ GR801R			
● 3 TRUCK			
★ AD85 RBP730 6X4 - 8X4 - AD85 RP730 6X4 - 8X4 - GR/GRS900R			
● 4 BUS			
★ DC11 - D12 - K94 - DC9 19/20/21 - DSC9 - DSi9 E01 - DC9 - F94 - K/L/N94 - OSC9 G01 - GR801R			
● 4 TRUCK			
★ DC11 - D12 - DSC14 13/15 - DSC11 - OSC11 G03 - DSC9 - DC9 01/02/03/04/05/06/19/20/21 - DC16 - GR/GRS/GRSH/R/GRSO/R			
● F-K-N BUS			
★ D9 PDE - GR801R/GR900R/GRS890R/GRS900R/GRS920R/GRSO900R - D12K - D9 K/N			
● IND. MARINE ENGINE 4			
★ D112 68M - SG9 A280 - DC12 50A - D12A/M - DC16A - D16M - D16A/M			
● IND. MARINE ENGINE 5			
★ SG9 A280 - DC9A EMS			
● P-G-R-T TRUCK			
★ D9 PDE - GR801R/GR900R/GRS890R/GRS900R/GRS920R/GRSO900R - D11 - D12 - D16 - D9 - D13 XPI			



	Code	OEM new	OEM old
GASKET SET	64130	64130	
● Model			
★ Application			
● 3 BUS			
★ GR801R			
● 3 TRUCK			
★ AD85 RBP730 6X4 - 8X4 - AD85 RP730 6X4 - 8X4 - GR/GRS900R			
● 4 BUS			
★ DC11 - D12 - K94 - DC9 19/20/21 - DSC9 - DSi9 E01 - DC9 - F94 - K/L/N94 - OSC9 G01 - GR801R			
● 4 TRUCK			
★ DC11 - D12 - DSC14 13/15 - DSC11 - OSC11 G03 - DSC9 - DC9 01/02/03/04/05/06/19/20/21 - DC16 - GR/GRS/GRSH/R/GRSO/R			
● F-K-N BUS			
★ D9 PDE - GR801R/GR900R/GRS890R/GRS900R/GRS920R/GRSO900R - D12K - D9 K/N			
● IND. MARINE ENGINE 4			
★ DI12 68M - SG9 A280 - DC12 50A - D12A/M - DC16A - D16M - D16A/M			
● IND. MARINE ENGINE 5			
★ SG9 A280 - DC9A EMS			
● P-G-R-T TRUCK			
★ D9 PDE - GR801R/GR900R/GRS890R/GRS900R/GRS920R/GRSO900R - D11 - D12 - D16 - D9 - D13 XPI			



	Code	OEM new	OEM old
GASKET SET	64131	64131	
● Model			
★ Application			
● 3 BUS			
★ GR801R			
● 3 TRUCK			
★ AD85 RBP730 6X4 - 8X4 - AD85 RP730 6X4 - 8X4 - GR/GRS900R			
● 4 BUS			
★ DC11 - D12 - K94 - DC9 19/20/21 - DSC9 - DSi9 E01 - DC9 - F94 - K/L/N94 - OSC9 G01 - GR801R			
● 4 TRUCK			
★ DC11 - D12 - DSC14 13/15 - DSC11 - OSC11 G03 - DSC9 - DC9 01/02/03/04/05/06/19/20/21 - DC16 - GR/GRS/GRSH/R/GRSO/R			
● F-K-N BUS			
★ D9 PDE - GR801R/GR900R/GRS890R/GRS900R/GRS920R/GRS0900R - D12K - D9 K/N			
● IND. MARINE ENGINE 4			
★ D112 68M - SG9 A280 - DC12 50A - D12A/M - DC16A - D16M - D16A/M			
● IND. MARINE ENGINE 5			
★ SG9 A280 - DC9A EMS			
● P-G-R-T TRUCK			
★ D9 PDE - GR801R/GR900R/GRS890R/GRS900R/GRS920R/GRS0900R - D11 - D12 - D16 - D9 - D13 XPI			



	Code	OEM new	OEM old
CENTRIFUGAL OIL FILTER SPINDLE	61206	362257	
● Model			
★ Application			
● 3 BUS			
★			
● 4 BUS			
★ D12 - K/L/N 94 DSC9 DS19 E01 DC9 OSC9 G01 - DSC9 DC9 01/02/03/04/05/06 - DC11			
● IND. MARINE ENGINE 4			
★			
● IND. MARINE ENGINE 4			
★ D12A - D12M - D9M - DC9 51/53/54/55A - DC16A - DI16 48A 53A - D16M			
● 3 TRUCK			
★			
● 4 TRUCK			
★ DSC9 DC9 01/02/03/04/05/06 - DC11 - DSC12 DC12 01/02/03/09 - DSC14 13/15 - DSC11 - OSC11 G03 - DT12 - DC16			
● P-G-R-T TRUCK			
★ D16			



	Code	OEM new	OEM old
SAFETY LOCK NUT	63151	372981	
● Model			
★ Application			
● 3 BUS			
★			
● 3 TRUCK			
★			
● 4 BUS			
★ D12 - K/L/N 94 DSC9 DS19 E01 DC9 OSC9 G01 - DSC9 DC9 01/02/03/04/05/06 - DC11			
● 4 TRUCK			
★ DSC9 DC9 01/02/03/04/05/06 - DC11 - DSC12 DC12 01/02/03/09 - DSC14 13/15 - DSC11 - OSC11 G03 - DT12 - DC16			
● F-K-N BUS			
★ D9 PDE - D11 - D12 - D9 XPI			
● IND.MARINE ENGINE 3			
★			
● IND. MARINE ENGINE 4			
★ D12A - D12M - D9M - DC9 51/53/54/55A - DC16A - DI16 48A 53A - D16M			
● IND. MARINE ENGINE 5			
★ DC9 EMS - SG9 A280			
● P-G-R-T TRUCK			
★ D16 - D9 XPI - D9 PDE - D11 - D12 - D13			



O-RING DIAM.=59,5X3 mm



	Code	OEM new	OEM old
● Model	60636	332119	392663
★ Application			
● 3 BUS			
★			
● 3 TRUCK			
★ CR/CT 143			
● 4 BUS			
★ DSC11 - OSC11 G03			
● 4 TRUCK			
★ DSC11 - OSC11 G03 - CR/CT144			
● IND. MARINE ENGINE 4			
★ DSC9/DC9 A/M - SG9 A280			
● IND. MARINE ENGINE 5			
★ SG9 A280			

ALL THE COMPONENTS LISTED IN OUR CATALOGUE ARE NOT ORIGINAL, THOUGH PERFECTLY INTERCHANGEABLE. REFERENCE NUMBERS, EITHER ORIGINAL OR OF A DIFFERENT NATURE, ARE FOR INFORMATION PURPOSES ONLY WHEN PLACING AN ORDER, PLEASE, ALWAYS USE COSIBO REFERENCE NUMBERS AND DO NOT MENTION THE ORIGINAL REFERENCE NUMBERS OF THE TRUCK MANUFACTURERS IN THE INVOICE TO VEHICLE OWNERS OR TO ANYBODY ELSE. THE CUSTOMER TAKES HIS OWN RESPONSIBILITY IF HE DOES NOT COMPLY WITH WHAT ABOVE.

		Code	OEM new	OEM old
O-RING	● Model	65036	372983	
	★ Application			
	● 3 BUS			
	★			
	● 3 TRUCK			
	★			
	● 4 BUS			
	★	D12 - DSC9 - DC9 01/02/03/04/05/06/19/20/21 - DSC9 - DS19 E01 - OSC9 G01 - DC11 - OSC11 G03 - K/L/N 94		
	● 4 TRUCK			
	★	DC16 - DSC12 - DC12 01/02/03/09 - DSC14 13/15 - DSC11 - OSC11 G03 - DSC9 - DSC9 - DC9 01/02/03/04/05/06/19/20/21 - DC11 - DT12 - D12 - DC16 - DS19 01 - OSC9 G01		
	● F-K-N BUS			
	★	D9 PDE - D11 - D12 - D9 XPI		
	● IND. MARINE ENGINE 4			
	★	D/DC/DI 9/11/14 A/M - D12 A/M - D12 A/M EMS - D16 A/M - DI12 49A - 68M - DC12 57A - D9 M - DC9 51/53/54/55A - DC16 A - DI16 48/53A - DC16 - DSC9/DC9 A/M		
● IND. MARINE ENGINE 5				
★	DC9 EMS - SG9 A280			
● P-G-R-T TRUCK				
★	D9 PDE - D11 - D12 - D9 XPI - D16 - D13			



OIL FILTER



	Code	OEM new	OEM old
● Model	60455	1117285	
★ Application			
● 4 BUS			
★ DC11/D12 - L D9/DC11/D12/D14 12,2 BAR - S D9/DC11/D12/D14 - DSC9 DC9 01/02/03/04/05/06/19/20/21 - DSi9 E01 - OSC9 G01 - K/L/N 94			
● F-K-N BUS			
★ D9 PDE - D11/D12 - L/S D12 HPI - L/S D9/D11/D12 PDE			
● IND. MARINE ENGINE 4			
★ D/DC/DI 9A/M - D12 A/M - D12A/M EMS - SG9 A280 - DI12 49A - DC12 57A - DI12 68M STD & LH/RH - DC9 51/53/54/55A - DSC14 - DC11/D12			
● IND. MARINE ENGINE 5			
★ DC9 EMS - SG9A 280			
● 4 TRUCK			
★ DSC14 13/15 - DC11/D12 - L D12 HPI 9,3/12,2 BAR - L D9/DC11/D12/D14 9,3/12,2 BAR - S D12 HPI - DSC12 - DC12 01/02/03/09 - DT12 - S D9/DC11/D12/D14 - DSC9 DC9 01/02/03/04/05/06/19/20/21 - DSi9 E01 - OSC9 G01			
● P-G-R-T TRUCK			
★ L/S HPI - L/S D9/D11/D12 PDE - D9 PDE - D11/D12			

OIL FILTER





	62402	1873014	1439036
● IND. MARINE ENGINE 4			
★ D16A - D16M - DC16A - DI16 48A/53A			
● 4 TRUCK			
★ D16 - DC16			
● P-G-R-T TRUCK			
★ D16			

ALL THE COMPONENTS LISTED IN OUR CATALOGUE ARE NOT ORIGINAL, THOUGH PERFECTLY INTERCHANGEABLE. REFERENCE NUMBERS, EITHER ORIGINAL OR OF A DIFFERENT NATURE, ARE FOR INFORMATION PURPOSES ONLY WHEN PLACING AN ORDER, PLEASE, ALWAYS USE COSIBO REFERENCE NUMBERS AND DO NOT MENTION THE ORIGINAL REFERENCE NUMBERS OF THE TRUCK MANUFACTURERS IN THE INVOICE TO VEHICLE OWNERS OR TO ANYBODY ELSE. THE CUSTOMER TAKES HIS OWN RESPONSIBILITY IF HE DOES NOT COMPLY WITH WHAT ABOVE.

		Code	OEM new	OEM old
RETARDER OIL FILTER	● Model	62361	1381235	1329876
	★ Application			
	● 4 BUS			
	★			
	● F-K-N BUS			
	★	GR/GRS/GRSO/875/895/905/R		
	● 4 TRUCK			
	★			
	● P-G-R-T TRUCK			
	★	GR/GRS/GRSO/875/895/905/R		



		Code	OEM new	OEM old
GASKET	● Model	60969	1392931	139472
	★ Application			
	● 3 TRUCK			
	★ DSC11 12/13/16			
	● IND. MARINE ENGINE 4			
	★ DS/DSC14 - DSI14 74/78 M40/41/46/47 - DSI14 72/77/79			
GASKET		60564	357363	
				
	● 3 BUS			
	★			
	● 3 TRUCK			
	★ DN11 01 - DS11 34/73			
	● IND. MARINE ENGINE 4			
	★ DS/DSC/DSI 11A			
GASKET		60565	1384552	393820
				
	● 3 BUS			
	★ DSI11			
	● 3 TRUCK			
	★ DN11 01 - DS11 34/73 - DSC11			
	● IND. MARINE ENGINE 4			
	★ DSI11 73/75/76/77/78/79/80/81 - DSI11 A46/47			

ALL THE COMPONENTS LISTED IN OUR CATALOGUE ARE NOT ORIGINAL, THOUGH PERFECTLY INTERCHANGEABLE. REFERENCE NUMBERS, EITHER ORIGINAL OR OF A DIFFERENT NATURE, ARE FOR INFORMATION PURPOSES ONLY WHEN PLACING AN ORDER, PLEASE, ALWAYS USE COSIBO REFERENCE NUMBERS AND DO NOT MENTION THE ORIGINAL REFERENCE NUMBERS OF THE TRUCK MANUFACTURERS IN THE INVOICE TO VEHICLE OWNERS OR TO ANYBODY ELSE. THE CUSTOMER TAKES HIS OWN RESPONSIBILITY IF HE DOES NOT COMPLY WITH WHAT ABOVE.

		Code	OEM new	OEM old
GASKET	● Model	61483	1746684	1308589
	★ Application			1392459
				277607
				353249
				371510
	● 3 TRUCK			
	★ DSC14			
	● 4 TRUCK			
	★ DSC14 13/15			
	● IND. MARINE ENGINE 4			
	★ DS14 - DSC14 - D14 A/M			



		61921	1384554	1301628
GASKET	● 3 TRUCK			
	★ DS11 34/75 - DSC11 - DSC/DTC11 - OSC11 G03			
	● 4 TRUCK			
	★ DSC11 - OSC11 G03			
	● 3 BUS			
	★ DS11 - DSC11			
	● 4 BUS			
	★ DSC11 - OSC11 G03			
	● IND. MARINE ENGINE 4			
	★ DS11 A45 - DS11 - DSC11 - DS/DSC/DSI 11A			



		60973	1392930	139471 371514
GASKET	● 3 TRUCK			
	★ DSC11 12/13/16			
	● 4 TRUCK			
	★ DC16 - DSC14 13/15			
	● IND. MARINE ENGINE 4			
	★ DC16 A - DS/DSC14 - DS14 70/72/77/79 - DS14 68/73/74/75/78 M46/47 - DC6			
	● P-G-R-T TRUCK			
	★ D16			



ALL THE COMPONENTS LISTED IN OUR CATALOGUE ARE NOT ORIGINAL, THOUGH PERFECTLY INTERCHANGEABLE. REFERENCE NUMBERS, EITHER ORIGINAL OR OF A DIFFERENT NATURE, ARE FOR INFORMATION PURPOSES ONLY WHEN PLACING AN ORDER, PLEASE, ALWAYS USE COSIBO REFERENCE NUMBERS AND DO NOT MENTION THE ORIGINAL REFERENCE NUMBERS OF THE TRUCK MANUFACTURERS IN THE INVOICE TO VEHICLE OWNERS OR TO ANYBODY ELSE. THE CUSTOMER TAKES HIS OWN RESPONSIBILITY IF HE DOES NOT COMPLY WITH WHAT ABOVE.

		Code	OEM new	OEM old
GASKET	● Model	61922	1384555	1301629
	★ Application			
	● 3 TRUCK			
	★	DS11 34/75 - DSC11 - DSC/DTC11 - OSC11 G03		
	● 4 TRUCK			
	★	DSC11 - ASC11 G03		
	● 3 BUS			
	★	DS11 - DSC11		
	● 4 BUS			
	★	DSC11 - OSC11 G03		
● IND. MARINE ENGINE 4				
★	DS11 34/75 - DSC11 - DSC/DTC11 - OSC11 G03			



GASKET		62542	1516474	1374338 1374340 1516145
	● 4 TRUCK			
	★	DC16 - DSC12 01/02/03/05 - DC12 - DT12 - DC9 19/20/21 - DC11 01/02/03/04/06/07 - D12		
	● P-G-R-T TRUCK			
	★	D9 - D11 - D12 - D16 - D11/D12 CG/CP/CR/CT EGR - D9PDE/DC12 EGR		
	● 4 BUS			
	★	DC11 01/02/03/04/06/07 - D12 - K94 DC9 19/20/21 - DSC12 01/02/03/05 - DC12 - DT12		
	● IND. MARINE ENGINE 4			
	★	DSC/DC12A - DSI/DI12A - DI12 59M/60M/62M/64M/65M/66M/68M/69M/70M - DC12A EMS - SGI12A - DC16A - DI16 40A/41A/48A/53A - D16M - DI16 50M - D12A/M - D12M EMS - D12A EMS - DC16		
	● IND. MARINE ENGINE 5			
★	DC9A EMS - SG9 A280			
● F-K-N BUS				
★	D9 - D11 - D12 - D16 - DC12K EGR - D9K EGR - D9N EGR - K D9/D11/D12 - D9NUD EGR			



	Code	OEM new	OEM old
GASKET OLD VERSION	61482	366547	
<ul style="list-style-type: none"> ● Model ★ Application 			
<ul style="list-style-type: none"> ● 3 BUS 			
<ul style="list-style-type: none"> ★ DS9 - DSC9 - K93 - F93 			
<ul style="list-style-type: none"> ● 3 TRUCK 			
<ul style="list-style-type: none"> ★ DS9 4X4/6X4/8X4 - DSC9 - DN9 - DS9 - CG/CP/CR/CT93 			
<ul style="list-style-type: none"> ● 4 BUS 			
<ul style="list-style-type: none"> ★ L/N94 DSI9 E01 - DSC9 - DC9 - OSC9 G01 - D9 - F94 - DC9 01/02/03/04/05/06 - DSI9 E01 - OSC9 - DSI9 			
<ul style="list-style-type: none"> ● 4 TRUCK 			
<ul style="list-style-type: none"> ★ D9 - DSC9 - DC9 01/02/03/04/05/06 - DSI9 E01 - OSC9 G01 - OSC9 - DSI9 			
<ul style="list-style-type: none"> ● IND. MARINE ENGINE 4 			
<ul style="list-style-type: none"> ★ SG9 A280 - DSC9/DC9 46 A03/A05 - DSC9/DC9 47/49/50 - DI9 A/M - DC9 M - DS9/D9 - DI9 56A - DC9 51A/53A/54A/55A - D9 A/M - DSC9/DC9 A/M - D9 - DC9 51 A05E 			



GASKET	64277	1437296	1349714 366557
<ul style="list-style-type: none"> ● 3 TRUCK 			
<ul style="list-style-type: none"> ★ DS9 4X4/6X4/8X4 - DSC9 - DN9 - DS9 - CG/CP/CR/CT93 			
<ul style="list-style-type: none"> ● 4 TRUCK 			
<ul style="list-style-type: none"> ★ D9 - DSC9 - DC9 01/02/03/04/05/06 - DSI9 E01 - OSC9 G01 - OSC9 - DSI9 			
<ul style="list-style-type: none"> ● 3 BUS 			
<ul style="list-style-type: none"> ★ DS9 - DSC9 - K93 - F93 			
<ul style="list-style-type: none"> ● 4 BUS 			
<ul style="list-style-type: none"> ★ L/N94 DSI9 E01 - DSC9 - DC9 - OSC9 G01 - D9 - F94 - DC9 01/02/03/04/05/06 - DSI9 E01 - OSC9 - DSI9 			
<ul style="list-style-type: none"> ● IND. MARINE ENGINE 4 			
<ul style="list-style-type: none"> ★ SG9 A280 - DSC9/DC9 46 A03/A05 - DSC9/DC9 47/49/50 - DI9 A/M - DC9 M - DS9/D9 - DI9 56A - DC9 51A/53A/54A/55A - D9 A/M - DSC9/DC9 A/M - D9 - DC9 51 A05E 			



	Code	OEM new	OEM old
AIR FILTER	60367	1869988	1387549 1526087 1801775
			
● Model			
★ Application			
● 4 BUS			
★ 94/114/124 - F94			
● 4 TRUCK			
★ 94/114/124			
● P-G-R-T TRUCK			
★ D9/D11/D12/D13			
AIR FILTER	60584	1869993	1421022
			
● 4 TRUCK			
★ 94/114/124 - 8X8 WLS ZLS			
● P-G-R-T TRUCK			
★ D9/D11/D12			
AIR FILTER	62403	1421021	1335678
			
● IND. MARINE ENGINE 4			
★ D12 41M/42M/43M/44M/45M - DSI14 68M/73M/74M/75M/78M - DS11 - DS11 73/74/75/76/77/78/79/80/81 - DS/DSC14 - DC16 A - D16M			
● IND. MARINE ENGINE 5			
★ DC9A EMS			
● 4 TRUCK			
★ 144 - 164			
● P-G-R-T TRUCK			
★ D9 - D13 - D16 - CG/CP14 EK PTO			

ALL THE COMPONENTS LISTED IN OUR CATALOGUE ARE NOT ORIGINAL, THOUGH PERFECTLY INTERCHANGEABLE. REFERENCE NUMBERS, EITHER ORIGINAL OR OF A DIFFERENT NATURE, ARE FOR INFORMATION PURPOSES ONLY WHEN PLACING AN ORDER, PLEASE, ALWAYS USE COSIBO REFERENCE NUMBERS AND DO NOT MENTION THE ORIGINAL REFERENCE NUMBERS OF THE TRUCK MANUFACTURERS IN THE INVOICE TO VEHICLE OWNERS OR TO ANYBODY ELSE. THE CUSTOMER TAKES HIS OWN RESPONSIBILITY IF HE DOES NOT COMPLY WITH WHAT ABOVE.

		Code	OEM new	OEM old
AIR FILTER	● Model	63618	1869987	1387548
	★ Application			
	● 4 TRUCK			
	★ 144/164			
	● P-G-R-T TRUCK			
	★ D16 - D9/13			

AIR FILTER	63766	1872152	1423414
	● 4 TRUCK		
	★ 144/164		
	● P-G-R-T TRUCK		
	★ D16 CH 2018048 - CH 5149841 - CH 9111175 - CH 3588940 - D9/13		

AIR FILTER ASSY W/O INTERNAL FILTER	64009	1335674	
	● 4 TRUCK		
	★ 94/114/124 - 8X8 WLS/ZLS		
	● P-G-R-T TRUCK		
	★ D9/D11/D12		

ALL THE COMPONENTS LISTED IN OUR CATALOGUE ARE NOT ORIGINAL, THOUGH PERFECTLY INTERCHANGEABLE. REFERENCE NUMBERS, EITHER ORIGINAL OR OF A DIFFERENT NATURE, ARE FOR INFORMATION PURPOSES ONLY WHEN PLACING AN ORDER, PLEASE, ALWAYS USE COSIBO REFERENCE NUMBERS AND DO NOT MENTION THE ORIGINAL REFERENCE NUMBERS OF THE TRUCK MANUFACTURERS IN THE INVOICE TO VEHICLE OWNERS OR TO ANYBODY ELSE. THE CUSTOMER TAKES HIS OWN RESPONSIBILITY IF HE DOES NOT COMPLY WITH WHAT ABOVE.

AIR FILTER ASSY W/O INTERNAL FILTER



	Code	OEM new	OEM old
● Model	64058	1870001	1387542 1801772
★ Application			
● 4 BUS			
★ F94			
● 4 TRUCK			
★ 94/114/124			
● P-G-R-T TRUCK			
★ D9/D11/D12/D13			

AIR FILTER ASSY W/O INTERNAL FILTER



	64315	1335673	
● P-G-R-T TRUCK			
★ D9/13 D16			

AIR FILTER COVER



	64375	1387547	
● 4 BUS			
★ F94			
● 4 TRUCK			
★ 94/114/124			
● P-G-R-T TRUCK			
★ D9/D11/D12/D13			

ALL THE COMPONENTS LISTED IN OUR CATALOGUE ARE NOT ORIGINAL, THOUGH PERFECTLY INTERCHANGEABLE. REFERENCE NUMBERS, EITHER ORIGINAL OR OF A DIFFERENT NATURE, ARE FOR INFORMATION PURPOSES ONLY WHEN PLACING AN ORDER, PLEASE, ALWAYS USE COSIBO REFERENCE NUMBERS AND DO NOT MENTION THE ORIGINAL REFERENCE NUMBERS OF THE TRUCK MANUFACTURERS IN THE INVOICE TO VEHICLE OWNERS OR TO ANYBODY ELSE. THE CUSTOMER TAKES HIS OWN RESPONSIBILITY IF HE DOES NOT COMPLY WITH WHAT ABOVE.

		Code	OEM new	OEM old
CLAMP	● Model	64016	1431701	
	★ Application			
	● 4 BUS			
	★ L94 ENG 5131571 - N94 ENG 6003287 ENG 5749530 - D9 F94 ENG 3131425 - D12 ENG 5749530			
	● IND. MARINE ENGINE 4			
	★ DSI/DI12 A - DSI11 ENG 5367779			
	● 4 TRUCK			
★ DSC9 ENG 5131571 - DC9 01/02/03/04/05/06 - DSC11/DSC12 ENG 5749530 - DSC12 - DC12 4X4/6X6/8X8 ENG 5749530 - DC11 4X4/6X6 ENG 5749530 -				

		64358	1433190	
CLAMP	● 4 BUS			
	★ L94 ENG 5131752 - DC11/D12 ENG 5749531			
	● IND. MARINE ENGINE 4			
	★ DSI/DI12 A ENG 5749531 - DC9 51A/53A/54A/55A - DSI11 ENG 5367780 - SG9 A280			
	● IND. MARINE ENGINE 5			
	★ DC9A EMS - SG9 A280			
	● 4 TRUCK			
★ DSC9 ENG 5131572 - DSC11 ENG 5749531 - DSC12 ENG 5749531 - DC12 4X4/6X6/8X8 ENG 5749531 - DC11 4X4/6X6 ENG 5749531				

ALL THE COMPONENTS LISTED IN OUR CATALOGUE ARE NOT ORIGINAL, THOUGH PERFECTLY INTERCHANGEABLE. REFERENCE NUMBERS, EITHER ORIGINAL OR OF A DIFFERENT NATURE, ARE FOR INFORMATION PURPOSES ONLY WHEN PLACING AN ORDER, PLEASE, ALWAYS USE COSIBO REFERENCE NUMBERS AND DO NOT MENTION THE ORIGINAL REFERENCE NUMBERS OF THE TRUCK MANUFACTURERS IN THE INVOICE TO VEHICLE OWNERS OR TO ANYBODY ELSE. THE CUSTOMER TAKES HIS OWN RESPONSIBILITY IF HE DOES NOT COMPLY WITH WHAT ABOVE.

	Code	OEM new	OEM old
TURBO REPAIR SET	60505	550195	
<ul style="list-style-type: none"> ● Model ★ Application 			
<ul style="list-style-type: none"> ● 3 TRUCK ★ DSC11 12/13 - ENG 3075634 - ENG 5307760 - ENG 4070104 			



TURBO REPAIR SET	60506	1382113	1382110 550196
<ul style="list-style-type: none"> ● 3 TRUCK ★ DS11 73 - DSC11 16 - ENG 5307760 - ENG 4070104 - ENG 3075634 			



ALL THE COMPONENTS LISTED IN OUR CATALOGUE ARE NOT ORIGINAL, THOUGH PERFECTLY INTERCHANGEABLE. REFERENCE NUMBERS, EITHER ORIGINAL OR OF A DIFFERENT NATURE, ARE FOR INFORMATION PURPOSES ONLY WHEN PLACING AN ORDER, PLEASE, ALWAYS USE COSIBO REFERENCE NUMBERS AND DO NOT MENTION THE ORIGINAL REFERENCE NUMBERS OF THE TRUCK MANUFACTURERS IN THE INVOICE TO VEHICLE OWNERS OR TO ANYBODY ELSE. THE CUSTOMER TAKES HIS OWN RESPONSIBILITY IF HE DOES NOT COMPLY WITH WHAT ABOVE.

ENGINE MOUNTING



	Code	OEM new	OEM old
● Model	60141	364833	364833
★ Application			
● 3 BUS			
★			
● IND. MARINE ENGINE 4			
★ D9 A/M - DSC9/DC9 47 A04S			
● 3 TRUCK			
★ DS/DSC11 - DTC11 - 6X4 8X4			

ENGINE MOUNTING



	60140	309885	138849 238999
● IND. MARINE ENGINE 4			
★ D9 A/M			

RUBBER MOUNTING



	60405	332738	137207
● 3 BUS			
★			
● IND. MARINE ENGINE 4			
★ SG9 A280 - D9 A/M			
● 3 TRUCK			
★ 4X4 6X4 6X6 8X4 - DS/DSC11 - DTC11			

ALL THE COMPONENTS LISTED IN OUR CATALOGUE ARE NOT ORIGINAL, THOUGH PERFECTLY INTERCHANGEABLE. REFERENCE NUMBERS, EITHER ORIGINAL OR OF A DIFFERENT NATURE, ARE FOR INFORMATION PURPOSES ONLY WHEN PLACING AN ORDER, PLEASE, ALWAYS USE COSIBO REFERENCE NUMBERS AND DO NOT MENTION THE ORIGINAL REFERENCE NUMBERS OF THE TRUCK MANUFACTURERS IN THE INVOICE TO VEHICLE OWNERS OR TO ANYBODY ELSE. THE CUSTOMER TAKES HIS OWN RESPONSIBILITY IF HE DOES NOT COMPLY WITH WHAT ABOVE.

ENGINE & GEARBOX MOUNTING

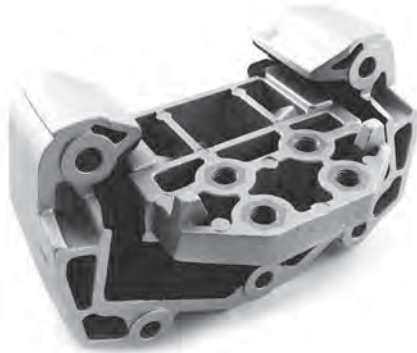

	Code	OEM new	OEM old
● Model	62040	1336882	
★ Application			
● 4 TRUCK			
★ 144			

FRONT ENGINE MOUNTING - GREEN



	60435	1496288	1423011
● 4 BUS			
★ P/ R94 - N94 - D9 F94 -			
● F-K-N BUS			
★ F			
● 4 TRUCK			
★ P/ R94 - D12 - DSC11 OSC11 G03 - DC9 19/ 20/ 21 - DC11 - DC11 D12 - 2 POINTS SUSP. CAB			
● P-G-R-T TRUCK			
★ D11 - D12 2 POINTS SUSP. CAB - D9 PDE			

FRONT ENGINE MOUNTING - YELLOW



	63139	1475868	1371729 1423012
● 4 BUS			
★ K94 - DC11 - D12 - L94			
● 4 TRUCK			
★ K94 - DSC14 13/ 15 - DC16			
● P-G-R-T TRUCK			
★ D16			

ALL THE COMPONENTS LISTED IN OUR CATALOGUE ARE NOT ORIGINAL, THOUGH PERFECTLY INTERCHANGEABLE. REFERENCE NUMBERS, EITHER ORIGINAL OR OF A DIFFERENT NATURE, ARE FOR INFORMATION PURPOSES ONLY WHEN PLACING AN ORDER, PLEASE, ALWAYS USE COSIBO REFERENCE NUMBERS AND DO NOT MENTION THE ORIGINAL REFERENCE NUMBERS OF THE TRUCK MANUFACTURERS IN THE INVOICE TO VEHICLE OWNERS OR TO ANYBODY ELSE. THE CUSTOMER TAKES HIS OWN RESPONSIBILITY IF HE DOES NOT COMPLY WITH WHAT ABOVE.

RADIATOR



- Model
- ★ Application

Code

OEM new

OEM old

62260

1764886

1327249
1397435
1408881
1442751
570491

- IND. MARINE ENGINE 4

- ★ D16

- 4 TRUCK

- ★ CR/CT

RADIATOR



62290

1764885

1384059
1477051
570490

- IND. MARINE ENGINE 4

- ★ DC12 46A - DC9 - D16 40A/41A

- IND. MARINE ENGINE 5

- ★

- 4 TRUCK

- ★ CR94 - CR/CT DSC11 - CR/CT 144 - CR/CT 124 - 164 - CR 4X4/6X6 - CR/CT DC11 01/02/03/04/06/07

ALL THE COMPONENTS LISTED IN OUR CATALOGUE ARE NOT ORIGINAL, THOUGH PERFECTLY INTERCHANGEABLE. REFERENCE NUMBERS, EITHER ORIGINAL OR OF A DIFFERENT NATURE, ARE FOR INFORMATION PURPOSES ONLY WHEN PLACING AN ORDER, PLEASE, ALWAYS USE COSIBO REFERENCE NUMBERS AND DO NOT MENTION THE ORIGINAL REFERENCE NUMBERS OF THE TRUCK MANUFACTURERS IN THE INVOICE TO VEHICLE OWNERS OR TO ANYBODY ELSE. THE CUSTOMER TAKES HIS OWN RESPONSIBILITY IF HE DOES NOT COMPLY WITH WHAT ABOVE.

EXPANSION TANK



	Code	OEM new	OEM old
● Model	65021	1320602	
★ Application			
● 3 BUS			
★ F93 CH 1822935			
● 3 TRUCK			
★ CR 143 CH 1173982 - CG/CP/CR 93 CH 1173982 - CP/CR 113 CH 1173982			

CAP



	61627	367761	
● 3 TRUCK			
★ CG/CP/CR/CT 93 - CP/CR/CT 113			

EXPANSION TANK FILLER CAP



	62299	367762	
● 3 BUS			
★ L/K/N 113			
● 3 TRUCK			
★ CG/CP/CR/CT 93 - CP/CR/CT 113 - CR/CT 143			
● IND. MARINE ENGINE 4			
★ DSI			

ALL THE COMPONENTS LISTED IN OUR CATALOGUE ARE NOT ORIGINAL, THOUGH PERFECTLY INTERCHANGEABLE. REFERENCE NUMBERS, EITHER ORIGINAL OR OF A DIFFERENT NATURE, ARE FOR INFORMATION PURPOSES ONLY WHEN PLACING AN ORDER, PLEASE, ALWAYS USE COSIBO REFERENCE NUMBERS AND DO NOT MENTION THE ORIGINAL REFERENCE NUMBERS OF THE TRUCK MANUFACTURERS IN THE INVOICE TO VEHICLE OWNERS OR TO ANYBODY ELSE. THE CUSTOMER TAKES HIS OWN RESPONSIBILITY IF HE DOES NOT COMPLY WITH WHAT ABOVE.

	Code	OEM new	OEM old
RUBBER BUSHING	63194	318362	
<ul style="list-style-type: none"> ● Model ★ Application 			
<ul style="list-style-type: none"> ● 3 BUS ★ F 93 CH 1822936 - F 113 			
<ul style="list-style-type: none"> ● 3 TRUCK ★ CT 93/113/143 			
<ul style="list-style-type: none"> ● 4 BUS ★ F 94 			
<ul style="list-style-type: none"> ● IND. MARINE ENGINE 4 ★ D16 - DS9A - DSC9A - DSC9 46/47A - DC9 51 A05E 			
<ul style="list-style-type: none"> ● IND. MARINE ENGINE 5 ★ DC9A EMS 			



	60479	1363634	
RADIATOR BRACKET			
<ul style="list-style-type: none"> ● 4 BUS ★ K/L/N - L DS19 E01 - N 94UD - F94 			
<ul style="list-style-type: none"> ● F-K-N BUS ★ CNUA - CNUB - K D12 - N D9 - CNUD 			
<ul style="list-style-type: none"> ● IND. MARINE ENGINE 4 ★ SG9 A280 - D16 40A/41A 			
<ul style="list-style-type: none"> ● IND. MARINE ENGINE 5 ★ SG9 A280 			
<ul style="list-style-type: none"> ● 4 TRUCK ★ 8X8 WLS/ZLS CR - CP/CR/CT 			



	61959	391555	
RADIATOR BRACKET			
<ul style="list-style-type: none"> ● 3 TRUCK ★ CR13 - CR19 - CP/CR113 - CR143 			



	Code	OEM new	OEM old
LH RADIATOR MOUNTING KIT	64632	64632	
<ul style="list-style-type: none"> ● Model ★ Application 			
<ul style="list-style-type: none"> ● 3 TRUCK ★ CR13 CR19 CP/CR113 CR143 			



RH RADIATOR MOUNTING KIT	64631	64631	
<ul style="list-style-type: none"> ● 3 TRUCK ★ CR13 CR19 CP/CR113 CR143 			



BUSHING	61077	393950	
<ul style="list-style-type: none"> ● 3 TRUCK ★ CR 13/19 - CP/CR 113 - CR 143 			



ALL THE COMPONENTS LISTED IN OUR CATALOGUE ARE NOT ORIGINAL, THOUGH PERFECTLY INTERCHANGEABLE. REFERENCE NUMBERS, EITHER ORIGINAL OR OF A DIFFERENT NATURE, ARE FOR INFORMATION PURPOSES ONLY WHEN PLACING AN ORDER, PLEASE, ALWAYS USE COSIBO REFERENCE NUMBERS AND DO NOT MENTION THE ORIGINAL REFERENCE NUMBERS OF THE TRUCK MANUFACTURERS IN THE INVOICE TO VEHICLE OWNERS OR TO ANYBODY ELSE. THE CUSTOMER TAKES HIS OWN RESPONSIBILITY IF HE DOES NOT COMPLY WITH WHAT ABOVE.

		Code	OEM new	OEM old
SENSOR	● Model	61232	309065	
	★ Application			
	● 3 BUS			
	★ F 93/113			
	● 3 TRUCK			
	★ D9/11/14 - DSC11 21/22/23 - DTC11 - CG/CP/CR/CT 93 - CP/CR/CT 113 - CR 13/19 - CR/CT 143			
	● 4 BUS			
★ F 94 - DSC9				
● IND. MARINE ENGINE 4				
★ D9/11/14				



BEARING		62011	393932	
	● 3 TRUCK			
	★ CR 13/19 - CP/CR 113 - CR 143			



RUBBER BUFFER		60653	308604	
	● 3 BUS			
	★ F 93/113			
	● 3 TRUCK			
	★ DN/DS - DSC - CG/CP/CR/CT 93 - CP/CR 113 - CR/CT 143 - CR 13/19			



ALL THE COMPONENTS LISTED IN OUR CATALOGUE ARE NOT ORIGINAL, THOUGH PERFECTLY INTERCHANGEABLE. REFERENCE NUMBERS, EITHER ORIGINAL OR OF A DIFFERENT NATURE, ARE FOR INFORMATION PURPOSES ONLY WHEN PLACING AN ORDER, PLEASE, ALWAYS USE COSIBO REFERENCE NUMBERS AND DO NOT MENTION THE ORIGINAL REFERENCE NUMBERS OF THE TRUCK MANUFACTURERS IN THE INVOICE TO VEHICLE OWNERS OR TO ANYBODY ELSE. THE CUSTOMER TAKES HIS OWN RESPONSIBILITY IF HE DOES NOT COMPLY WITH WHAT ABOVE.

	Code	OEM new	OEM old
RUBBER BUSHING	60654	273793	
<ul style="list-style-type: none"> ● Model ★ Application 			
<ul style="list-style-type: none"> ● 3 BUS ★ F 93/113 			
<ul style="list-style-type: none"> ● 3 TRUCK ★ DN/DS - DSC - CP/CR/CT 93 - CP/CR 113 - CR/CT 143 - CR 13/19 - CG 			
<ul style="list-style-type: none"> ● IND. MARINE ENGINE 4 ★ D9 - D12 - D14 			
<ul style="list-style-type: none"> ● IND. MARINE ENGINE 5 ★ DC9A EMS 			



	62529	1762623	1492746
LH RADIATOR BRACKET			



<ul style="list-style-type: none"> ● F-K-N BUS ★ F 			
<ul style="list-style-type: none"> ● P-G-R-T TRUCK ★ CG/CR/CT D9/D11/D12/D16 - CP D9/D11/D12 - D13 - F 			

	62528	1762624	1492747
RH RADIATOR BRACKET			



<ul style="list-style-type: none"> ● F-K-N BUS ★ F 			
<ul style="list-style-type: none"> ● P-G-R-T TRUCK ★ CG/CR/CT D9/D11/D12/D16 - CP D9/D11/D12 - D13 - F 			

ALL THE COMPONENTS LISTED IN OUR CATALOGUE ARE NOT ORIGINAL, THOUGH PERFECTLY INTERCHANGEABLE. REFERENCE NUMBERS, EITHER ORIGINAL OR OF A DIFFERENT NATURE, ARE FOR INFORMATION PURPOSES ONLY WHEN PLACING AN ORDER, PLEASE, ALWAYS USE COSIBO REFERENCE NUMBERS AND DO NOT MENTION THE ORIGINAL REFERENCE NUMBERS OF THE TRUCK MANUFACTURERS IN THE INVOICE TO VEHICLE OWNERS OR TO ANYBODY ELSE. THE CUSTOMER TAKES HIS OWN RESPONSIBILITY IF HE DOES NOT COMPLY WITH WHAT ABOVE.

	Code	OEM new	OEM old
RUBBER BUFFER	62274	1795583	397308
<ul style="list-style-type: none"> ● Model ★ Application 			
<ul style="list-style-type: none"> ● 3 BUS ★ F113 RH 			
<ul style="list-style-type: none"> ● IND. MARINE ENGINE 4 ★ DC9 - DI16 50M - D16M 			
<ul style="list-style-type: none"> ● 3 TRUCK ★ CR143 - DSC11 18 - CABIN CP/CR113 - CABIN CR13/19 D11 - CABIN CP/CR DSC11 21 - DSC11 21/22 (EDC/23) DTC11 - 			
<ul style="list-style-type: none"> ● 4 TRUCK ★ CABIN CP14/CR14 - R164 			
<ul style="list-style-type: none"> ● P-G-R-T TRUCK ★ CABIN CP/CG/CR 19M - CABIN CP/CG/CR 16/19 - CABIN CR16 D16 - CABIN CP/CG14 			



SCREW M12X50	61348	1344182	1117597 1328597 313228
<ul style="list-style-type: none"> ● 4 BUS ★ L 94 			
<ul style="list-style-type: none"> ● F-K-N BUS ★ 			
<ul style="list-style-type: none"> ● P-G-R-T TRUCK ★ D13 			



SCREW M12X50	64397	1757877	
<ul style="list-style-type: none"> ● 4 BUS ★ L 94 			
<ul style="list-style-type: none"> ● F-K-N BUS ★ 			
<ul style="list-style-type: none"> ● P-G-R-T TRUCK ★ D13 			



	Code	OEM new	OEM old
RUBBER BUFFER	63929	1388070	
	<ul style="list-style-type: none"> ● Model ★ Application 		
	<ul style="list-style-type: none"> ● F-K-N BUS ★ K - N XPI 		
	<ul style="list-style-type: none"> ● P-G-R-T TRUCK ★ 		
CLAMP	63321	1445398	
	<ul style="list-style-type: none"> ● 4 BUS ★ N 94 - F 94 RHD - F 94 LHD 1X65A - 2X65A 		
	<ul style="list-style-type: none"> ● F-K-N BUS ★ N - N XPI - F 		
	<ul style="list-style-type: none"> ● IND. MARINE ENGINE 4 ★ D16 40A/41A 		
	<ul style="list-style-type: none"> ● 4 TRUCK ★ CP OSC11 G03 - CP DC9 19/20/21 - CP DC11 01/02/03/04/06/07 - DC12 01/02/03/09/16 - CR94 - CR/CT DSC11 - CR 124 8X8 WLS/ZLS - CR/CT 144 - CR/CT 124 - CP DSC12 01/02/05 - CP D9 - CP DSC11 74/75/79 - 164 - CR 4X4 6X6 - CR/CT DC11 01/02/03/04/06/07 - CP 19F FRONTLINE 		
	<ul style="list-style-type: none"> ● P-G-R-T TRUCK ★ CG/CP/CR/CT D11/12 - D16 - D9 PDE - D9 XPI - D13 		

ALL THE COMPONENTS LISTED IN OUR CATALOGUE ARE NOT ORIGINAL, THOUGH PERFECTLY INTERCHANGEABLE. REFERENCE NUMBERS, EITHER ORIGINAL OR OF A DIFFERENT NATURE, ARE FOR INFORMATION PURPOSES ONLY WHEN PLACING AN ORDER, PLEASE, ALWAYS USE COSIBO REFERENCE NUMBERS AND DO NOT MENTION THE ORIGINAL REFERENCE NUMBERS OF THE TRUCK MANUFACTURERS IN THE INVOICE TO VEHICLE OWNERS OR TO ANYBODY ELSE. THE CUSTOMER TAKES HIS OWN RESPONSIBILITY IF HE DOES NOT COMPLY WITH WHAT ABOVE.

	Code	OEM new	OEM old
CLAMP	64017	1439822	
<ul style="list-style-type: none"> ● Model ★ Application 			
	<ul style="list-style-type: none"> ● 4 BUS 		
	<ul style="list-style-type: none"> ★ N 94 - F 94 RHD - F 94 LHD 1X65A-2X65A 		
	<ul style="list-style-type: none"> ● F-K-N BUS 		
	<ul style="list-style-type: none"> ★ N - N XPI - F 		
	<ul style="list-style-type: none"> ● IND. MARINE ENGINE 4 		
	<ul style="list-style-type: none"> ★ D16 40A/41A 		
	<ul style="list-style-type: none"> ● IND. MARINE ENGINE 5 		
	<ul style="list-style-type: none"> ★ DC9A EMS 		
	<ul style="list-style-type: none"> ● 4 TRUCK 		
	<ul style="list-style-type: none"> ★ CP OSC11 G03 - CP DC9 19/20/21 - CP DC11 01/02/03/04/06/07-DC12 01/02/03/09/16 - CR94 - CR/CT DSC11 - CR 124 8X8 WLS/ZLS - CR/CT 144 - CR/CT 124 - CP DSC12 01/02/05 - CP D9 - CP DSC11 74/75/79 - 164 - CR 4X4 6X6 - CR/CT DC11 01/02/03/04/06/07 - CP 19F FRONTLINE 		
	<ul style="list-style-type: none"> ● P-G-R-T TRUCK 		
	<ul style="list-style-type: none"> ★ CG/CP/CR/CT D11/12 - D16 - D9 PDE - D9 XPI - D13 		

**SILICONE HOSE**

	63229	412080	
<ul style="list-style-type: none"> ● 3 BUS 			
<ul style="list-style-type: none"> ★ N 113 			



EXPANSION TANK FILLER CAP



	Code	OEM new	OEM old
● Model	62313	1403954	1318911
★ Application			
● 3 BUS			
★ F/K 93 - L/N/K/F 113 - K 113 GR801R			
● 3 TRUCK			
★ CR/CT 143 - CG/CP/CR/CT 93 - CP/CR/CT 113			
● 4 BUS			
★ K/L/N - N 94 UD - F 94			
● F-K-N BUS			
★ F/K/N			
● IND. MARINE ENGINE 4			
★ DS9A - DSC9A - DSC9 46/47A - DC9 51 A05 - ESG9 A280 - D12 - D9 - D11 - D16 - D16 M			
● IND. MARINE ENGINE 5			
★ DC9A EMS - SG9 A280			

SILICONE HOSE



	61463	1381926	270142
● 3 BUS			
★ K 113 - K 93 - F 93 - K 113 DSC11 22 70 EDC-GR801 - K 113 DSC11 21 GR801 - K 113 GR801R - F 113 LHD/RHD			
● IND. MARINE ENGINE 4			
★			
● 3 TRUCK			
★ CG/CP/CR 93 - CP/CR/CT 113 - CR/CT 143 - CP/CR DSC11 21/22(EDC)/23-DTC11 - CP 93 GA850R ALLISON HD4060PR			

ALL THE COMPONENTS LISTED IN OUR CATALOGUE ARE NOT ORIGINAL, THOUGH PERFECTLY INTERCHANGEABLE. REFERENCE NUMBERS, EITHER ORIGINAL OR OF A DIFFERENT NATURE, ARE FOR INFORMATION PURPOSES ONLY WHEN PLACING AN ORDER, PLEASE, ALWAYS USE COSIBO REFERENCE NUMBERS AND DO NOT MENTION THE ORIGINAL REFERENCE NUMBERS OF THE TRUCK MANUFACTURERS IN THE INVOICE TO VEHICLE OWNERS OR TO ANYBODY ELSE. THE CUSTOMER TAKES HIS OWN RESPONSIBILITY IF HE DOES NOT COMPLY WITH WHAT ABOVE.

		Code	OEM new	OEM old
SILICONE HOSE	● Model	61704	312646	
	★ Application			
	● 3 BUS			
	★	DSC11 22/70 EDC - DSC11 04/08/08B/21/23/27/71 - K 113 - L 113 - DSC - OSC11 01		
	● IND. MARINE ENGINE 4			
	★	DSC14 - DSC11		
	● 3 TRUCK			
	★	CT 93 - CP/CR/CT 113 - CR/CT 143		
● 4 TRUCK				
★	DSC14 13/15 - CP OSC11 G03 - OSC11 G03			

		63154	1433110	1423508 397999
SILICONE HOSE	● 3 BUS			
	★	DS/DSC11 - DS11 - OSC11 G01 - DSC11		
	● 4 BUS			
	★	DC11 - D12 - L 94 DSC9 - DSI9 E01 - DC9 - OSC9 G01 - N 94 DSC9 - DSI9 E01 - DC9 - D9		
	● IND. MARINE ENGINE 4			
	★	D12A - DC9 51A/53A/54A/55A - DI9 56A - DI16 50M		
	● 3 TRUCK			
	★	DS11 75 - DSC11 12/13/16/17/18/21/23/30/35/36 - DSC11 - DS9 4X4 - DS/ DSC9 - DTC11		
● 4 TRUCK				
★	DC11 - D12 - DSC9 - DC9 01/02/03/04/05/06			

		63175	1375718	1315195 368559
SILICONE HOSE	● 3 BUS			
	★	F 93		
	● 3 TRUCK			
	★	CG/CP/CR/CT 93 - CP/CR/CT 113 - CR 143 - CR 143 GRH880 - CP 93 GA850R ALLISON HD4060PR		

ALL THE COMPONENTS LISTED IN OUR CATALOGUE ARE NOT ORIGINAL, THOUGH PERFECTLY INTERCHANGEABLE. REFERENCE NUMBERS, EITHER ORIGINAL OR OF A DIFFERENT NATURE, ARE FOR INFORMATION PURPOSES ONLY WHEN PLACING AN ORDER, PLEASE, ALWAYS USE COSIBO REFERENCE NUMBERS AND DO NOT MENTION THE ORIGINAL REFERENCE NUMBERS OF THE TRUCK MANUFACTURERS IN THE INVOICE TO VEHICLE OWNERS OR TO ANYBODY ELSE. THE CUSTOMER TAKES HIS OWN RESPONSIBILITY IF HE DOES NOT COMPLY WITH WHAT ABOVE.

		Code	OEM new	OEM old
SILICONE HOSE	● Model	63219	350572	
	★ Application			
	● IND. MARINE ENGINE 4			
	★ D14			
	● 3 TRUCK			
	★ CR/CT 143			

		63297	488368	390581
SILICONE HOSE	● 3 BUS			
	★ DSC11 22/70 EDC - DSC11 04/08/21/23/27/71 - L 113 - K 113 - DSC			
	● 4 BUS			
	★ K 94 - K 114/124 - L 94 - L 94 DC9 01/02/03/04/05/06 - L 94 DSC9 11/12/13/15 - N 94UD - L 94 OSC9 G01 - L 94 OC9 G02			
	● F-K-N BUS			
	★ K D9 OC9 - K D9 XPI - K D11/D12 OC11 OC12 - K DT12			
	● IND. MARINE ENGINE 4			
	★ SG9 A280 - DSC14 - DC12 - DSC11 OK			
	● IND. MARINE ENGINE 5			
	★ SG9 A280 - DC9A EMS			
	● 3 TRUCK			
	★ CG/CP/CR/CT 93 - CP/CR/CT 113 - CR/CT 143 - HK/MK - DSC11 18/22/30			

		63300	373210	
SILICONE HOSE	● 3 TRUCK			
	★ DS11 73 - CP/CR 113 - CR/CT 143			
				

ALL THE COMPONENTS LISTED IN OUR CATALOGUE ARE NOT ORIGINAL, THOUGH PERFECTLY INTERCHANGEABLE. REFERENCE NUMBERS, EITHER ORIGINAL OR OF A DIFFERENT NATURE, ARE FOR INFORMATION PURPOSES ONLY WHEN PLACING AN ORDER, PLEASE, ALWAYS USE COSIBO REFERENCE NUMBERS AND DO NOT MENTION THE ORIGINAL REFERENCE NUMBERS OF THE TRUCK MANUFACTURERS IN THE INVOICE TO VEHICLE OWNERS OR TO ANYBODY ELSE. THE CUSTOMER TAKES HIS OWN RESPONSIBILITY IF HE DOES NOT COMPLY WITH WHAT ABOVE.

		Code	OEM new	OEM old
SILICONE HOSE	● Model	63301	375527	
	★ Application			
	● 3 BUS			
	★	DSI11 - DSC11 04/27/71 - L 113		
	● 3 TRUCK			
★	CP/CR/CT 113 - CP/CR 113 4X4 6X6 - DSC11 18/22/30			



SILICONE HOSE		65002	1522011	1442579 1522010
	● 4 BUS			
	★	N 94 - F 94 RHD - F 94 LHD 1X65A-2X65A		
	● F-K-N BUS			
	★	N - N XPI - F		
● IND. MARINE ENGINE 4				
★	D16 40A/41A			
● 4 TRUCK				
★	CP OSC11 G03 - CP DC9 19/20/21 - CP DC11 01/02/03/04/06/07 - DC12 01/02/03/09/16 - CR94 - CR/CT DSC11 - CR 124 8X8 WLS/ZLS - CR/CT 144 - CR/CT 124 - CP DSC12 01/02/05 - CP D9 - CP DSC11 74/75/79 - 164 - CR 4X4 6X6 - CR/CT DC11 01/02/03/04/06/07 - CP 19F FRONTLINE			
● P-G-R-T TRUCK				
★	CG/CP/CR/CT D11/12 - D16 - D9 PDE - D9 XPI - D13			



		Code	OEM new	OEM old
SILICONE HOSE 	● Model	65092	1525145	
	★ Application			
	● 4 BUS			
	★ N 94 - F 94 RHD - F 94 LHD 1X65A - 2X65A			
	● F-K-N BUS			
	★ N - N XPI - F			
	● IND. MARINE ENGINE 4			
	★ D16 40A/41A			
	● 4 TRUCK			
	★ CP OSC11 G03 - CP DC9 19/20/21 - CP DC11 01/02/03/04/06/07 - DC12 01/02/03/09/16 - CR94 - CR/CT DSC11 - CR 124 8X8 WLS/ZLS - CR/CT 144 - CR/CT 124 - CP DSC12 01/02/05 - CP D9 - CP DSC11 74/75/79 - 164 - CR 4X4 6X6 - CR/CT DC11 01/02/03/04/06/07 - CP 19F FRONTLINE			
● P-G-R-T TRUCK				
★ CG/CP/CR/CT D11/12 - D16 - D9 PDE - D9 XPI - D13				

		65099	1794725	
SILICONE HOSE 	● 4 BUS			
	★ N 94 - F 94 RHD - F 94 LHD 1X65A - 2X65A			
	● F-K-N BUS			
	★ N - N XPI - F			
	● IND. MARINE ENGINE 4			
	★ D16 40A/41A			
	● 4 TRUCK			
	★ CP OSC11 G03 - CP DC9 19/20/21 - CP DC11 01/02/03/04/06/07 - DC12 01/02/03/09/16 - CR94 - CR/CT DSC11 - CR 124 8X8 WLS/ZLS - CR/CT 144 - CR/CT 124 - CP DSC12 01/02/05 - CP D9 - CP DSC11 74/75/79 - 164 - CR 4X4 6X6 - CR/CT DC11 01/02/03/04/06/07 - CP 19F FRONTLINE			
	● P-G-R-T TRUCK			
	★ CG/CP/CR/CT D11/12 - D16 - D9 PDE - D9 XPI - D13			

	Code	OEM new	OEM old
RUBBER HOSE	61703	297394	
<ul style="list-style-type: none"> ● Model ★ Application 			
<ul style="list-style-type: none"> ● 3 BUS 			
<ul style="list-style-type: none"> ★ K 113 - GR801 - GR801R - DS11 34 - DSC11 21/22/70 			
<ul style="list-style-type: none"> ● 3 TRUCK 			
<ul style="list-style-type: none"> ★ CR/CT 143 - GRH880 			
<ul style="list-style-type: none"> ● 4 BUS 			
<ul style="list-style-type: none"> ★ N 94 - N 94 UD - N/CN 			
<ul style="list-style-type: none"> ● IND. MARINE ENGINE 4 			
<ul style="list-style-type: none"> ★ D12 - D12A - D16 			
<ul style="list-style-type: none"> ● IND. MARINE ENGINE 5 			
<ul style="list-style-type: none"> ★ DC9 EMS 			



	64777	1373126	
O-RING			
<ul style="list-style-type: none"> ● 4 BUS 			
<ul style="list-style-type: none"> ★ F94 LHD/RHD 			
<ul style="list-style-type: none"> ● IND. MARINE ENGINE 4 			
<ul style="list-style-type: none"> ★ DC12 46A - DC9 - D16 40A/41A 			
<ul style="list-style-type: none"> ● IND. MARINE ENGINE 5 			
<ul style="list-style-type: none"> ★ DC9A EMS 			
<ul style="list-style-type: none"> ● 4 TRUCK 			
<ul style="list-style-type: none"> ★ CP OSC11 G03 - CP DC9 19/20/21 - CP DC11 01/02/03/04/06/07 - DC12 01/02/03/09/16 - CR94 - CR/CT DSC11 - 8X8 WLS/ZLS CR 124 - CR/CT 144 - CR/CT 124 - CP DSC12 01/02/05 - CP D9/DC12 03 - CP DSC11 74/75/79 - 164 - CR 4X4/6X6 - CR/CT DC11 01/02/03/04/06/07 - CP 19F FRONTLINE 			

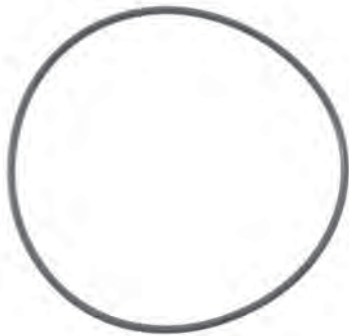

		Code	OEM new	OEM old
O-RING	● Model	64778	1331820	
	★ Application			
	● 4 BUS			
	★	DSC9 - DS19 E01 - DC9 01/02/03/04/05/06 - L94 OSC9 G01 - DSC11 - OSC11 G03 - L94/N94 DS19 E01 - K94/114/124 - L94 DC9 01/02/03/04/05/06 - F94 LHD - L94 DSC9 11/12/13/15 - N94UD - L94 OC9 G02 - L94UA - CL94		
	● F-K-N BUS			
	★	K D11/D12 OC11/OC12 - K D9 OC9 - N - F - CKUB - CNUD		
	● IND. MARINE ENGINE 4			
	★	SG9 A280 - DI16 40A/41A/48A/53A - DI16 50M - D16 M - DI12 49A - DC12A EMS - DC12 46A/54A/55A/57A/58A/59A/60A - SGI12A - DSI 12A - DC9 51/53 - DS14 69M - DI14 82M - DSC/DC 12A		
	● IND. MARINE ENGINE 5			
	★	SG9 A280 - DC9A EMS		
● 4 TRUCK				
★	DSC9 - DS19 E01 - DC9 01/02/03/04/05/06 - OSC9 G01 - DSC11 - OSC11 G03 - CP D9/DC9 19/20/21 - CP DC11 01/02/03/04/06/07 - DC12 01/02/03/09/16 - CR94 - CR/CT DSC11 - 8X8 WLS/ZLS CR 124 - CR/CT 124 - CP DSC12 01/02/05 - CP DSC11 74/75/79 - CR 4X4/6X6 - CP DC12 03 - CR/CT DC11 01/02/03/04/06			
● P-G-R-T TRUCK				
★	CG/CR/CT D11/12 - D9 PDE - CP D11/D12			

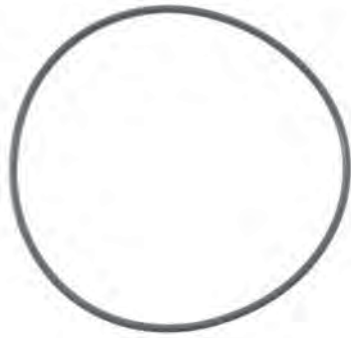

EXPANSION TANK		60359	1894478	1421090 1492421 1511775 1765735 1855164
	● 4 TRUCK			
★	CR D16 - CP/CR/CT			
● P-G-R-T TRUCK				
★	PDE - HPI			

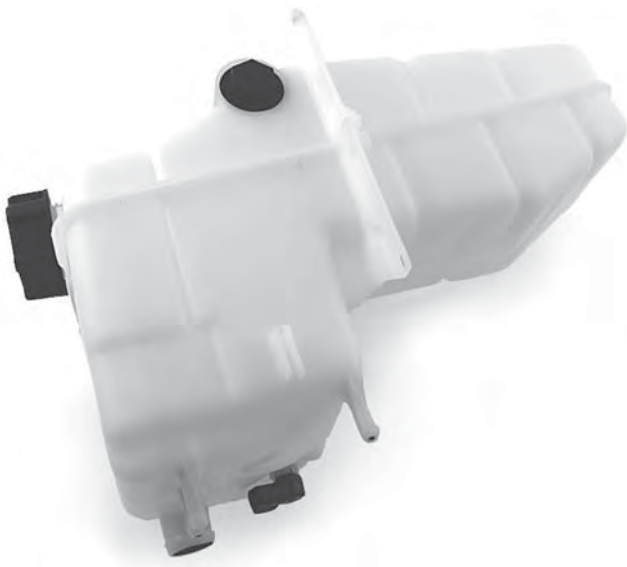

ALL THE COMPONENTS LISTED IN OUR CATALOGUE ARE NOT ORIGINAL, THOUGH PERFECTLY INTERCHANGEABLE. REFERENCE NUMBERS, EITHER ORIGINAL OR OF A DIFFERENT NATURE, ARE FOR INFORMATION PURPOSES ONLY WHEN PLACING AN ORDER, PLEASE, ALWAYS USE COSIBO REFERENCE NUMBERS AND DO NOT MENTION THE ORIGINAL REFERENCE NUMBERS OF THE TRUCK MANUFACTURERS IN THE INVOICE TO VEHICLE OWNERS OR TO ANYBODY ELSE. THE CUSTOMER TAKES HIS OWN RESPONSIBILITY IF HE DOES NOT COMPLY WITH WHAT ABOVE.

		Code	OEM new	OEM old
EXPANSION TANK PLUG W/VALVE	● Model	64054	1849428	1757490
	★ Application			
	● 4 TRUCK			
	★ CR D16 - CP/CR/CT			
	● P-G-R-T TRUCK			
	★ PDE - HPI			

		62397	308678	
CAP	● 3 BUS			
	★			
	● 3 TRUCK			
	★			
	● 4 TRUCK			
	★ DSC9 - DC9 - CP19 F - FRONTLINE - T 164			
	● IND. MARINE ENGINE 4			
	★ D12 A/M - D9 A/M - DC16 A			

		62512	1371839	295960
CAP	● P-G-R-T TRUCK			
	★			
				

ALL THE COMPONENTS LISTED IN OUR CATALOGUE ARE NOT ORIGINAL, THOUGH PERFECTLY INTERCHANGEABLE. REFERENCE NUMBERS, EITHER ORIGINAL OR OF A DIFFERENT NATURE, ARE FOR INFORMATION PURPOSES ONLY WHEN PLACING AN ORDER, PLEASE, ALWAYS USE COSIBO REFERENCE NUMBERS AND DO NOT MENTION THE ORIGINAL REFERENCE NUMBERS OF THE TRUCK MANUFACTURERS IN THE INVOICE TO VEHICLE OWNERS OR TO ANYBODY ELSE. THE CUSTOMER TAKES HIS OWN RESPONSIBILITY IF HE DOES NOT COMPLY WITH WHAT ABOVE.

	Code	OEM new	OEM old
VISCO FAN	63786	1412398	1402869
<ul style="list-style-type: none"> ● Model ★ Application 			
<ul style="list-style-type: none"> ● F-K-N BUS 			
<ul style="list-style-type: none"> ★ F 			
<ul style="list-style-type: none"> ● 4 TRUCK 			
<ul style="list-style-type: none"> ★ DC9 19/20/21 - CP/CR/CT114/124 - DC12 01/02/03/09 - DT12 02/08/10/16 - DC11 01/02/03/04/06/07 			
<ul style="list-style-type: none"> ● P-G-R-T TRUCK 			
<ul style="list-style-type: none"> ★ D9 PDE 			



VISCO FAN	63857	1354979	1354978 1459683
<ul style="list-style-type: none"> ● 4 TRUCK 			
<ul style="list-style-type: none"> ★ CR/CT124/144 - DSC12 01/02/05/06 			



FAN COVER	62553	1390706	
<ul style="list-style-type: none"> ● 4 TRUCK 			
<ul style="list-style-type: none"> ★ CR/CT D12 - DC11 03/04/06 CH 6221004 - CH 8030600 - CH 6187808 - 6221003 - CH 8024382 - 8030599 - CR/CT 144 - CR/CT 124 CH 6187807 			



FAN CONVEYOR



	Code	OEM new	OEM old
● Model	64648	1332193	
★ Application			
● IND. MARINE ENGINE 4			
★ SG9 A280			
● 4 TRUCK			
★ CP D12 - DC11 01/02/03/04/06/07 - CP D11/12 4X4/6X6 - CP DC9 19/20/21 - CP/CR/CT DSC11 74/75/79 - CP/CR/CT OSC11 G03 260 HP - CP94 - CP94 FRONTLINE			

FAN COVER



	65325	1390705	1349968
● 4 TRUCK			
★ CR/CT D12 - DC11 03/04/06 - CR/CT 144 - CR/CT 124			

ALL THE COMPONENTS LISTED IN OUR CATALOGUE ARE NOT ORIGINAL, THOUGH PERFECTLY INTERCHANGEABLE. REFERENCE NUMBERS, EITHER ORIGINAL OR OF A DIFFERENT NATURE, ARE FOR INFORMATION PURPOSES ONLY WHEN PLACING AN ORDER, PLEASE, ALWAYS USE COSIBO REFERENCE NUMBERS AND DO NOT MENTION THE ORIGINAL REFERENCE NUMBERS OF THE TRUCK MANUFACTURERS IN THE INVOICE TO VEHICLE OWNERS OR TO ANYBODY ELSE. THE CUSTOMER TAKES HIS OWN RESPONSIBILITY IF HE DOES NOT COMPLY WITH WHAT ABOVE.

FAN CONVER



● Model

★ Application

Code

OEM new

OEM old

65360

1769522

1444954

● P-G-R-T TRUCK

★ DC9 18 FOR CP CAB - D11/12 FOR CP CAB - D9 XPI

FAN RING



● 4 TRUCK

★ CP - CP/CR/CT DSC11 74/75/79 - CP/CR/CT OSC11 G03 260HP - CP/CR94 - CP94 FRONTLINE - CR/CT DC11 01/02/07

64647

1486148

1434106

		Code	OEM new	OEM old
FAN RING	● Model	65320	1511832	1440404
	★ Application			
	● 4 TRUCK			
	★ CR/CT 144 - CR/CT 124 - DC16			

		64374	1530783	
FAN RING	● 4 TRUCK			
	★ CP - D12 - DC11 01/02/03/04/06/07 - CR/CT DC11 01/02/07 - CP DC9 19/20/21			
	● F-K-N BUS			
	★ F			
	● P-G-R-T TRUCK			
	★ D9 PDE			

ALL THE COMPONENTS LISTED IN OUR CATALOGUE ARE NOT ORIGINAL, THOUGH PERFECTLY INTERCHANGEABLE. REFERENCE NUMBERS, EITHER ORIGINAL OR OF A DIFFERENT NATURE, ARE FOR INFORMATION PURPOSES ONLY WHEN PLACING AN ORDER, PLEASE, ALWAYS USE COSIBO REFERENCE NUMBERS AND DO NOT MENTION THE ORIGINAL REFERENCE NUMBERS OF THE TRUCK MANUFACTURERS IN THE INVOICE TO VEHICLE OWNERS OR TO ANYBODY ELSE. THE CUSTOMER TAKES HIS OWN RESPONSIBILITY IF HE DOES NOT COMPLY WITH WHAT ABOVE.

FAN RUBBER RING



- Model
- ★ Application

Code	OEM new	OEM old
66579/1	1373520	

- 4 BUS

- ★ F 94

FAN RUBBER RING



- | | 64649 | 1440406 | |
|--|-------|---------|--|
| ● F-K-N BUS | | | |
| ★ F | | | |
| ● 4 TRUCK | | | |
| ★ CP D12 - DC11 01/02/03/04/06/07 - CP D11/12 4X4/6X6 - CR 124 4X4/6X6 - CR/CT DC11 01/02/07 - CP DC9 19/20/21 - CP/CR/CT DSC11 74/75/79 - CP/CR/CT OSC11 G03 260HP - CP/CR 94 - CP 94 FRONTLINE | | | |
| ● P-G-R-T TRUCK | | | |
| ★ D9 PDE - CP/CR D11/12 AWD - D11/D12 | | | |

FAN RUBBER RING



	Code	OEM new	OEM old
● Model	65319	1440407	1371782 1397796
★ Application			
● F-K-N BUS			
★ D9 XPI			
● IND. MARINE ENGINE 4			
★ DC16 - DSI12 40 A01			
● 4 TRUCK			
★ CR/CT D12 - DC11 03/04/06 - 8X8 WLS/ZLS CR D12 - CR/CT 144 - CR/CT 124 - DC16			
● P-G-R-T TRUCK			
★ D11/12 - D16 - CP/CR D11/12 AWD - D13 - D9 XPI			

FAN FRAME BRACKET



	64034	1374500	
● 4 BUS			
★ F94			
● 4 TRUCK			
★ 144 CR/CT - 124 CR/CT - CP 94/CR94 - CP94 FRONTLINE - CR/CT/CP DSC11 74/75/79 - CR/CT/CP - OSC11 G03/260 - CR/CT - DC11 01/02/07			

OIL SEAL 42x72x8



	60998	1109871	170226 310953
● IND. MARINE ENGINE 4			
★ D14A/M			
● 3 TRUCK			
★ CR/CT 143 - DSC14 08 GR/GS900R - DSC14 08/09/10			

ALL THE COMPONENTS LISTED IN OUR CATALOGUE ARE NOT ORIGINAL, THOUGH PERFECTLY INTERCHANGEABLE. REFERENCE NUMBERS, EITHER ORIGINAL OR OF A DIFFERENT NATURE, ARE FOR INFORMATION PURPOSES ONLY WHEN PLACING AN ORDER, PLEASE, ALWAYS USE COSIBO REFERENCE NUMBERS AND DO NOT MENTION THE ORIGINAL REFERENCE NUMBERS OF THE TRUCK MANUFACTURERS IN THE INVOICE TO VEHICLE OWNERS OR TO ANYBODY ELSE. THE CUSTOMER TAKES HIS OWN RESPONSIBILITY IF HE DOES NOT COMPLY WITH WHAT ABOVE.

OIL SEAL 25x47x7



- Model
- ★ Application

Code

OEM new

OEM old

60999

170761

- A.22.5

- ★

- 3 TRUCK

- ★ D14 - DS14

ALL THE COMPONENTS LISTED IN OUR CATALOGUE ARE NOT ORIGINAL, THOUGH PERFECTLY INTERCHANGEABLE. REFERENCE NUMBERS, EITHER ORIGINAL OR OF A DIFFERENT NATURE, ARE FOR INFORMATION PURPOSES ONLY WHEN PLACING AN ORDER, PLEASE, ALWAYS USE COSIBO REFERENCE NUMBERS AND DO NOT MENTION THE ORIGINAL REFERENCE NUMBERS OF THE TRUCK MANUFACTURERS IN THE INVOICE TO VEHICLE OWNERS OR TO ANYBODY ELSE. THE CUSTOMER TAKES HIS OWN RESPONSIBILITY IF HE DOES NOT COMPLY WITH WHAT ABOVE.

		Code	OEM new	OEM old
BELT TENSIONER	● Model	63652	1859654	1493670
	★ Application			1503113 1545982 1774651
	● 4 BUS			
	★			K/R/L/N94 - K114/124
	● IND. MARINE ENGINE 4			
	★			SG9 A280 - D12A/M - DC12 57A - D9A/M
	● 4 TRUCK			
	★			DC11/DC12 - D11/D12/D14 - DSC11 74/75/79 - OSC11 G03/260HP - DC11 01/02/03/04

BELT TENSIONER		63858	1859655	1476395
				1503114 1545983 1774652
	● IND. MARINE ENGINE 4			
	★			D16A/M - DI16 45M/48A/53A
	● 4 TRUCK			
	★			D16
	● P-G-R-T TRUCK			
	★			D16

ALL THE COMPONENTS LISTED IN OUR CATALOGUE ARE NOT ORIGINAL, THOUGH PERFECTLY INTERCHANGEABLE. REFERENCE NUMBERS, EITHER ORIGINAL OR OF A DIFFERENT NATURE, ARE FOR INFORMATION PURPOSES ONLY WHEN PLACING AN ORDER, PLEASE, ALWAYS USE COSIBO REFERENCE NUMBERS AND DO NOT MENTION THE ORIGINAL REFERENCE NUMBERS OF THE TRUCK MANUFACTURERS IN THE INVOICE TO VEHICLE OWNERS OR TO ANYBODY ELSE. THE CUSTOMER TAKES HIS OWN RESPONSIBILITY IF HE DOES NOT COMPLY WITH WHAT ABOVE.

	Code	OEM new	OEM old
BELT TENSIONER	64185	1859657	1774654
● Model			
★ Application			
● 4 BUS			
★ DC9 19/20/21			
● F-K-N BUS			
★ 2X100A - 2X150A - F 1X100A			
● IND. MARINE ENGINE 4			
★ DC12 50A			
● IND. MARINE ENGINE 5			
★ DC9A EMS - SG9 A280			
● 3 TRUCK			
★ DC9 19/20/21 - D9			
● P-G-R-T TRUCK			
★ D9/D11/D12			



	Code	OEM new	OEM old
BELT TENSIONER	64998	1859656	1545984 1774653
● IND. MARINE ENGINE 4			
★			
● IND. MARINE ENGINE 5			
★ DC9A EMS			
● 4 TRUCK			
★ D16			
● P-G-R-T TRUCK			
★ D16			

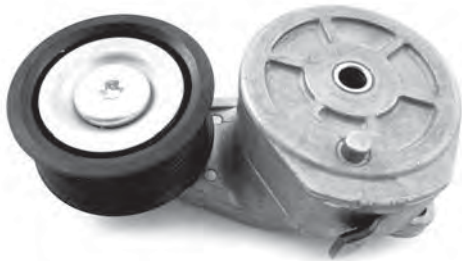

	Code	OEM new	OEM old
BELT TENSIONER ROLLER	63292	1514086	1428940
● Model			
★ Application			
● 4 BUS			
★ K/L/N94 65A/140A/2X140A - K114/124			
● IND. MARINE ENGINE 4			
★ D9/12/16 A/M - DC12 57A - DI16 45M			
● 4 TRUCK			
★ DC11/DC12 - D12/14/16 - DSC11 74/75/79 - OSC11 G03/260HP - DC11 01/02/03/04			
● P-G-R-T TRUCK			
★ D16			



BELT TENSIONER ROLLER	63384	1514087	1413609 1428941
● 4 BUS			
★ K/L/N94 65A/140A/2X140A			
● IND. MARINE ENGINE 4			
★ SG9 A280 - D9/12/16 A/M - DI16 45M			
● 4 TRUCK			
★ D11/D12/D16 - DC11			
● P-G-R-T TRUCK			
★ D16			



		Code	OEM new	OEM old
BELT TENSIONER ROLLER	● Model	64066	1858884	1510698 1795774
	★ Application			
	● 4 BUS			
	★ DC9 19/20/21			
	● F-K-N BUS			
	★ 2X100A - F 1X100A			
	● IND. MARINE ENGINE 4			
	★ DC12 50A			
	● IND. MARINE ENGINE 5			
	★ DC9A EMS - SG9 A280			
	● 4 TRUCK			
	★ DC9 19/20/21 - D9			
● P-G-R-T TRUCK				
★ D9/D11/D12				



BELT TENSIONER ROLLER		64251	1858885	1510697 1512749 1795775
	● 4 BUS			
	★ DC9 19/20/21			
	● F-K-N BUS			
	★ 2X100A - 2X150A - F 1X100A			
	● IND. MARINE ENGINE 4			
	★ D12A/M - DC12 50A			
	● IND. MARINE ENGINE 5			
	★ DC9A EMS - SG9 A280			
	● 4 TRUCK			
	★ DC9 19/20/21 - D9 - DC11/DC12			
	● P-G-R-T TRUCK			
★ D9/D11/D12/D13				



ALL THE COMPONENTS LISTED IN OUR CATALOGUE ARE NOT ORIGINAL, THOUGH PERFECTLY INTERCHANGEABLE. REFERENCE NUMBERS, EITHER ORIGINAL OR OF A DIFFERENT NATURE, ARE FOR INFORMATION PURPOSES ONLY WHEN PLACING AN ORDER, PLEASE, ALWAYS USE COSIBO REFERENCE NUMBERS AND DO NOT MENTION THE ORIGINAL REFERENCE NUMBERS OF THE TRUCK MANUFACTURERS IN THE INVOICE TO VEHICLE OWNERS OR TO ANYBODY ELSE. THE CUSTOMER TAKES HIS OWN RESPONSIBILITY IF HE DOES NOT COMPLY WITH WHAT ABOVE.

V-BELT L=2160



	Code	OEM new	OEM old
● Model ★ Application	60129	1800538	1389042 1530980
● 4 BUS			
★ DC9 19/20/21			
● F-K-N BUS			
★ 2X100A			
● 4 TRUCK			
★ DSC11 74/75/79 - OSC11 G03/260HP			

V-BELT L=1600



	60484	814210	
● 3 BUS			
★ DSC11			
● IND. MARINE ENGINE 4			
★			
● 3 TRUCK			
★ CT113			

V-BELT L=1575



	61322	814209	
● 3 BUS			
★ L113 - DSC11			
● IND. MARINE ENGINE 4			
★ ENG 5366480			

ALL THE COMPONENTS LISTED IN OUR CATALOGUE ARE NOT ORIGINAL, THOUGH PERFECTLY INTERCHANGEABLE. REFERENCE NUMBERS, EITHER ORIGINAL OR OF A DIFFERENT NATURE, ARE FOR INFORMATION PURPOSES ONLY WHEN PLACING AN ORDER, PLEASE, ALWAYS USE COSIBO REFERENCE NUMBERS AND DO NOT MENTION THE ORIGINAL REFERENCE NUMBERS OF THE TRUCK MANUFACTURERS IN THE INVOICE TO VEHICLE OWNERS OR TO ANYBODY ELSE. THE CUSTOMER TAKES HIS OWN RESPONSIBILITY IF HE DOES NOT COMPLY WITH WHAT ABOVE.

V-BELT L=1985



	Code	OEM new	OEM old
● Model	63639	1800521	1389028
★ Application			1454280
● IND. MARINE ENGINE 4			
★ D9A/M - D16M - DI16 45M			
● 4 TRUCK			
★ D12 - DC11 01/02/03/04 - WITH AIR CONDITIONING			

V-BELT L=2220



	Code	OEM new	OEM old
	63640	1803333	1389031 1530979
● 4 TRUCK			
★ D14 144 WITH AIR CONDITIONING			

V-BELT L=1535



	Code	OEM new	OEM old
	63966	1888464	1389029 1454281 1800522
● 4 TRUCK			
★ DC11 - D12 - WITHOUT AIR CONDITIONING			

ALL THE COMPONENTS LISTED IN OUR CATALOGUE ARE NOT ORIGINAL, THOUGH PERFECTLY INTERCHANGEABLE. REFERENCE NUMBERS, EITHER ORIGINAL OR OF A DIFFERENT NATURE, ARE FOR INFORMATION PURPOSES ONLY WHEN PLACING AN ORDER, PLEASE, ALWAYS USE COSIBO REFERENCE NUMBERS AND DO NOT MENTION THE ORIGINAL REFERENCE NUMBERS OF THE TRUCK MANUFACTURERS IN THE INVOICE TO VEHICLE OWNERS OR TO ANYBODY ELSE. THE CUSTOMER TAKES HIS OWN RESPONSIBILITY IF HE DOES NOT COMPLY WITH WHAT ABOVE.

V-BELT L=1580



	Code	OEM new	OEM old
● Model	63967	1800539	1530981
★ Application			
● 4 TRUCK			
★	DSC11 74/75/79 - OSC11 G03/260HP - WITHOUT AIR CONDITIONING		

V-BELT L=1795



	Code	OEM new	OEM old
	63969	1888465	1514865 1800533
● IND. MARINE ENGINE 4			
★	D16A		
● IND. MARINE ENGINE 5			
★	DC9A EMS		
● 4 TRUCK			
★	DC11/12 WITH AIR CONDITIONING - D16		
● P-G-R-T TRUCK			
★	D16		

V-BELT L=1520



	Code	OEM new	OEM old
	64121	1800535	1354390 1519788 1530973 1803332
● 4 BUS			
★	K114/124 - D11		
● 4 TRUCK			
★	D11/D12 - WITHOUT AIR CONDITIONING		

ALL THE COMPONENTS LISTED IN OUR CATALOGUE ARE NOT ORIGINAL, THOUGH PERFECTLY INTERCHANGEABLE. REFERENCE NUMBERS, EITHER ORIGINAL OR OF A DIFFERENT NATURE, ARE FOR INFORMATION PURPOSES ONLY WHEN PLACING AN ORDER, PLEASE, ALWAYS USE COSIBO REFERENCE NUMBERS AND DO NOT MENTION THE ORIGINAL REFERENCE NUMBERS OF THE TRUCK MANUFACTURERS IN THE INVOICE TO VEHICLE OWNERS OR TO ANYBODY ELSE. THE CUSTOMER TAKES HIS OWN RESPONSIBILITY IF HE DOES NOT COMPLY WITH WHAT ABOVE.

V-BELT L=2575 MM



	Code	OEM new	OEM old
● Model	62437	1803335	1534505
★ Application			
● 4 BUS			
★ K/L/N 94			

BELT L=1600 MM



	63968	1420911	
● 4 BUS			
★ F 94			
● 4 TRUCK			
★ D9			

V-BELT L=1900



	64346	1420908	1372545
● 4 TRUCK			
★ D9			
● 4 BUS			
★ F94			

ALL THE COMPONENTS LISTED IN OUR CATALOGUE ARE NOT ORIGINAL, THOUGH PERFECTLY INTERCHANGEABLE. REFERENCE NUMBERS, EITHER ORIGINAL OR OF A DIFFERENT NATURE, ARE FOR INFORMATION PURPOSES ONLY WHEN PLACING AN ORDER, PLEASE, ALWAYS USE COSIBO REFERENCE NUMBERS AND DO NOT MENTION THE ORIGINAL REFERENCE NUMBERS OF THE TRUCK MANUFACTURERS IN THE INVOICE TO VEHICLE OWNERS OR TO ANYBODY ELSE. THE CUSTOMER TAKES HIS OWN RESPONSIBILITY IF HE DOES NOT COMPLY WITH WHAT ABOVE.

V-BELT L=2430



	Code	OEM new	OEM old
● Model	63934	1800527	1490821
★ Application			
● 4 BUS			
★ K/L/N94			
● IND. MARINE ENGINE 4			
★			

V-BELT L=2085

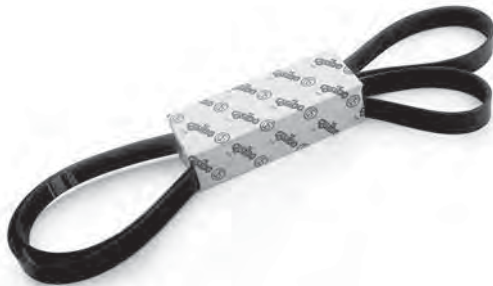

	65094	1888471	1530984 1800541
● 4 TRUCK			
★ D16			
● P-G-R-T TRUCK			
★ D16 WITH AIR CONDITIONING			
● IND. MARINE ENGINE 4			
★ D16A/M			

V-BELT L=1255



	65095	1800523	1454282
● 4 TRUCK			
★ D16			
● P-G-R-T TRUCK			
★ D16			
● IND. MARINE ENGINE 4			
★			

ALL THE COMPONENTS LISTED IN OUR CATALOGUE ARE NOT ORIGINAL, THOUGH PERFECTLY INTERCHANGEABLE. REFERENCE NUMBERS, EITHER ORIGINAL OR OF A DIFFERENT NATURE, ARE FOR INFORMATION PURPOSES ONLY WHEN PLACING AN ORDER, PLEASE, ALWAYS USE COSIBO REFERENCE NUMBERS AND DO NOT MENTION THE ORIGINAL REFERENCE NUMBERS OF THE TRUCK MANUFACTURERS IN THE INVOICE TO VEHICLE OWNERS OR TO ANYBODY ELSE. THE CUSTOMER TAKES HIS OWN RESPONSIBILITY IF HE DOES NOT COMPLY WITH WHAT ABOVE.

BELT L=2130 MM



	Code	OEM new	OEM old
● Model	64183	1888468	1389024 1389048 1490819
★ Application			
● IND. MARINE ENGINE 4			
★ DC12 50A			
● IND. MARINE ENGINE 5			
★ DC9A EMS			
● P-G-R-T TRUCK			
★ D9/11/12			

BELT L=1225 mm



	Code	OEM new	OEM old
	64187	814195	
● 3 BUS			
★ L113 G776 GA775/781R GS771/772 GR801 - K93			

ALTERNATOR REVISION KIT



	Code	OEM new	OEM old
	63794	63794	
● IND. MARINE ENGINE 4			
★ D9A/M - D16M - DI16 45M			
● 4 TRUCK			
★ D12 - DC11 01/02/03/04 - WITH AIR CONDITIONING			

ALL THE COMPONENTS LISTED IN OUR CATALOGUE ARE NOT ORIGINAL, THOUGH PERFECTLY INTERCHANGEABLE. REFERENCE NUMBERS, EITHER ORIGINAL OR OF A DIFFERENT NATURE, ARE FOR INFORMATION PURPOSES ONLY WHEN PLACING AN ORDER, PLEASE, ALWAYS USE COSIBO REFERENCE NUMBERS AND DO NOT MENTION THE ORIGINAL REFERENCE NUMBERS OF THE TRUCK MANUFACTURERS IN THE INVOICE TO VEHICLE OWNERS OR TO ANYBODY ELSE. THE CUSTOMER TAKES HIS OWN RESPONSIBILITY IF HE DOES NOT COMPLY WITH WHAT ABOVE.

ALTERNATOR REVISION KIT



- Model
 - ★ Application
- | | Code | OEM new | OEM old |
|--|--------------|---------|---------|
| | 63795 | 63795 | |
- 4 TRUCK
 - ★ D14 144 WITH AIR CONDITIONING

ALL THE COMPONENTS LISTED IN OUR CATALOGUE ARE NOT ORIGINAL, THOUGH PERFECTLY INTERCHANGEABLE. REFERENCE NUMBERS, EITHER ORIGINAL OR OF A DIFFERENT NATURE, ARE FOR INFORMATION PURPOSES ONLY WHEN PLACING AN ORDER, PLEASE, ALWAYS USE COSIBO REFERENCE NUMBERS AND DO NOT MENTION THE ORIGINAL REFERENCE NUMBERS OF THE TRUCK MANUFACTURERS IN THE INVOICE TO VEHICLE OWNERS OR TO ANYBODY ELSE. THE CUSTOMER TAKES HIS OWN RESPONSIBILITY IF HE DOES NOT COMPLY WITH WHAT ABOVE.

		Code	OEM new	OEM old
THERMOSTAT 80°C WITH RETARDER 	● Model	63171	1745449	1347594 1404925
	★ Application			
	● 3 BUS			
	★ GR801R			
	● 3 TRUCK			
	★ GR/GRS900R - P113 ML/HL 4X2/6X2 - P93 EXCEPT DSC9 09 GA850			
	● 4 BUS			
	★ F/L/N94 - K94/K114/K124 - N94UB			
	● 4 TRUCK			
	★ D9/D12/D14/D16 - DSC11 74/75/79 - DC11 01/02/03/04 - DC9 19/20/21			
	● F-K-N BUS			
	★ K - N			
	● IND. MARINE ENGINE 4			
	★ SG9 A280 - DC12 57A			
● IND. MARINE ENGINE 5				
★ SG9 A280 - DC9 60A/68A				
● P-G-R-T TRUCK				
★ D9/D11/D12/D13/D16				

THERMOSTAT 87°		65394	1849060	1423451 1799757 1800909
	● P-G-R-T TRUCK			
	★ D9/11/12/13/16 WITH RETARDER/CON RETARDER			

ALL THE COMPONENTS LISTED IN OUR CATALOGUE ARE NOT ORIGINAL, THOUGH PERFECTLY INTERCHANGEABLE. REFERENCE NUMBERS, EITHER ORIGINAL OR OF A DIFFERENT NATURE, ARE FOR INFORMATION PURPOSES ONLY WHEN PLACING AN ORDER, PLEASE, ALWAYS USE COSIBO REFERENCE NUMBERS AND DO NOT MENTION THE ORIGINAL REFERENCE NUMBERS OF THE TRUCK MANUFACTURERS IN THE INVOICE TO VEHICLE OWNERS OR TO ANYBODY ELSE. THE CUSTOMER TAKES HIS OWN RESPONSIBILITY IF HE DOES NOT COMPLY WITH WHAT ABOVE.

THERMOSTAT 83°C



	Code	OEM new	OEM old
● Model	63172	1404924-	1358995
★ Application		1916620	1404924
● 4 TRUCK			
★	DC9 19/20/21 - D12/D14 - DC11 01/02/03/04		
● F-K-N BUS			
★	F		
● IND. MARINE ENGINE 4			
★	D12/D12M ENG 5997349		
● IND. MARINE ENGINE 5			
★	DC9A EMS		
● P-G-R-T TRUCK			
★	D9 PDE - D11/D12		

THERMOSTAT 75°C



	63926	1431979	
● IND. MARINE ENGINE 4			
★	D12 49A - D12/D12M ENG 5997350 - D16M		
● IND. MARINE ENGINE 5			
★	DC9A EMS		

THERMOSTAT 79°C



	63174	283281	
● 3 BUS			
★	K93/113 - L113 - F93/113		
● 3 TRUCK			
★	CG/CP/CR/CT93 - CP/CR/CT113 - CR/CT143		

ALL THE COMPONENTS LISTED IN OUR CATALOGUE ARE NOT ORIGINAL, THOUGH PERFECTLY INTERCHANGEABLE. REFERENCE NUMBERS, EITHER ORIGINAL OR OF A DIFFERENT NATURE, ARE FOR INFORMATION PURPOSES ONLY WHEN PLACING AN ORDER, PLEASE, ALWAYS USE COSIBO REFERENCE NUMBERS AND DO NOT MENTION THE ORIGINAL REFERENCE NUMBERS OF THE TRUCK MANUFACTURERS IN THE INVOICE TO VEHICLE OWNERS OR TO ANYBODY ELSE. THE CUSTOMER TAKES HIS OWN RESPONSIBILITY IF HE DOES NOT COMPLY WITH WHAT ABOVE.

	Code	OEM new	OEM old
THERMOSTAT GASKET	61846	351197	278335
● Model			
★ Application			
● 3 BUS			
★ K93/113 - L113 - F93/113 - FOR OUR 63174			
● 3 TRUCK			
★ CG/CP/CR/CT93 - CP/CR/CT113 - CR/CT143 - FOR OUR 63174			



	62221	1755952	1351075
THERMOSTAT GASKET			
● 3 BUS			
★ GR801R - FOR OUR 63171			
● 3 TRUCK			
★ GR/GRS900R - P113 ML/HL 4X2/6X2 - P93 EXCEPT DSC9 09 GA850 - FOR OUR 63171			
● 4 BUS			
★ F/L/N94 - K94/K114/K124 - N94UB - FOR OUR 63171			
● 4 TRUCK			
★ D9/D12/D14/D16 - DSC11 74/75/79 - DC11 01/02/03/04 - DC9 19/20/21 - WITH RETARDER - FOR OUR 63171			
● F-K-N BUS			
★ K - N - FOR OUR 63171			
● IND. MARINE ENGINE 4			
★ SG9 A280 - DC12 57A - FOR OUR 63171			
● IND. MARINE ENGINE 5			
★ SG9 A280 - DC9 60A/68A - FOR OUR 63171			
● P-G-R-T TRUCK			
★ D9/D11/D12/D13/D16 - FOR OUR 63171			



	Code	OEM new	OEM old
THERMOSTAT GASKET	63193	1421825	1358996
● Model			
★ Application			
● 4 TRUCK			
★ DC9 19/20/21 - D12/D14 - DC11 01/02/03/04 - FOR OUR 63172 & 63926			
● F-K-N BUS			
★ F - FOR OUR 63172 & 63926			
● IND. MARINE ENGINE 4			
★ D12/D12M ENG 5997349 - FOR OUR 63172 & 63926			
● IND. MARINE ENGINE 5			
★ DC9A EMS - FOR OUR 63172 & 63926			
● P-G-R-T TRUCK			
★ D9 PDE - D11/D12 - FOR OUR 63172 & 63926			

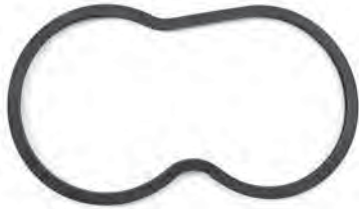

	63192	1375602	1305644
SILICONE HOSE			
● 3 TRUCK			
★ CR/CT 143 - CP93 GA850R ALLISON HD4060PR - GA850R ALLISON HD4060PR - GR900R/GRS900R			
● 4 TRUCK			
★ D14 - CP19F D9			
● IND. MARINE ENGINE 4			
★ D16M - D9 - DC9 51 A05E - D12A - D16 - D12 - D16 45M			
● IND. MARINE ENGINE 5			
★ DC9 A EMS			



COOLANT FILTER



	Code	OEM new	OEM old
● Model	60629	342988	378396
★ Application			
● 3 BUS			
★ F/K/L/N113 - F/K93 - K113 GR801R			
● 3 TRUCK			
★ CR/CT113/143 - CP/CR113 LHD/RHD - CR143 LHD/RHD - 113/143 LHD/RHD STREAMLINE - 113/143 RHD 6X2/4 - CG/CP/CR/CT93			
● 4 BUS			
★ D9/D11/D12/D14 - DSC9 - DSI9 E01 - DC9 01/02/03/04/05/06 - OSC9 G01 - K/L/N94			
● 4 TRUCK			
★ D9/D11/D12/D14 - DSC9 - DSI9 E01 - DC9 01/02/03/04/05/06 - OSC9 G01 - DSC11 74/75/79 - DC11 01/02/03/04			
● IND. MARINE ENGINE 4			
★ D14M			

ALL THE COMPONENTS LISTED IN OUR CATALOGUE ARE NOT ORIGINAL, THOUGH PERFECTLY INTERCHANGEABLE. REFERENCE NUMBERS, EITHER ORIGINAL OR OF A DIFFERENT NATURE, ARE FOR INFORMATION PURPOSES ONLY WHEN PLACING AN ORDER, PLEASE, ALWAYS USE COSIBO REFERENCE NUMBERS AND DO NOT MENTION THE ORIGINAL REFERENCE NUMBERS OF THE TRUCK MANUFACTURERS IN THE INVOICE TO VEHICLE OWNERS OR TO ANYBODY ELSE. THE CUSTOMER TAKES HIS OWN RESPONSIBILITY IF HE DOES NOT COMPLY WITH WHAT ABOVE.

	Code	OEM new	OEM old
WATER PUMP	60060	1510490	1486098 570957
<ul style="list-style-type: none"> ● Model ★ Application 			
<ul style="list-style-type: none"> ● 4 BUS ★ D9 - K/L/N94 			
<ul style="list-style-type: none"> ● 4 TRUCK ★ D9 			
<ul style="list-style-type: none"> ● IND. MARINE ENGINE 4 ★ SG9 A280 - SGI12A - D9A/M - DI9 53 A02S - DC9 51 A05E - DI9 56A 			



WATER PUMP	61005	1375837	261575
<ul style="list-style-type: none"> ● 1 TRUCK ★ 141 D14 DS14 			



WATER PUMP	60633	1508533	1353072 570955
<ul style="list-style-type: none"> ● 4 TRUCK ★ DC9 19/20/21 - D11/D12 - DSC11 74/75/79 			
<ul style="list-style-type: none"> ● P-G-R-T TRUCK ★ D9/D11/D12 			
<ul style="list-style-type: none"> ● 4 BUS ★ DC9 19/20/21 - D11/D12 			
<ul style="list-style-type: none"> ● IND. MARINE ENGINE 4 ★ DI12 49A - D12A/M 			

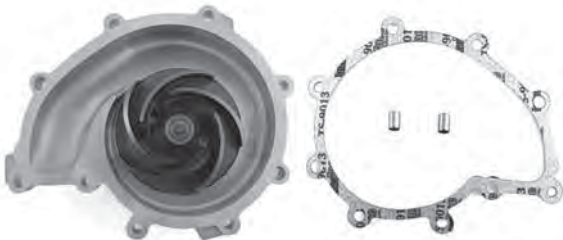

ALL THE COMPONENTS LISTED IN OUR CATALOGUE ARE NOT ORIGINAL, THOUGH PERFECTLY INTERCHANGEABLE. REFERENCE NUMBERS, EITHER ORIGINAL OR OF A DIFFERENT NATURE, ARE FOR INFORMATION PURPOSES ONLY WHEN PLACING AN ORDER, PLEASE, ALWAYS USE COSIBO REFERENCE NUMBERS AND DO NOT MENTION THE ORIGINAL REFERENCE NUMBERS OF THE TRUCK MANUFACTURERS IN THE INVOICE TO VEHICLE OWNERS OR TO ANYBODY ELSE. THE CUSTOMER TAKES HIS OWN RESPONSIBILITY IF HE DOES NOT COMPLY WITH WHAT ABOVE.

	Code	OEM new	OEM old
GASKET	64307	1403883	1353010
<ul style="list-style-type: none"> ● Model ★ Application 			
<ul style="list-style-type: none"> ● 4 BUS 			
<ul style="list-style-type: none"> ★ DC9 19/20/21 - D11/D12 			
<ul style="list-style-type: none"> ● 4 TRUCK 			
<ul style="list-style-type: none"> ★ DC9 19/20/21 - D11/D12 - DSC11 74/75/79 			
<ul style="list-style-type: none"> ● IND. MARINE ENGINE 4 			
<ul style="list-style-type: none"> ★ D112 49A - D12A/M 			
<ul style="list-style-type: none"> ● P-G-R-T TRUCK 			
<ul style="list-style-type: none"> ★ D9/D11/D12 			



WATER PUMP	60634	1508534	1365841 570956
<ul style="list-style-type: none"> ● 4 TRUCK 			
<ul style="list-style-type: none"> ★ D14 			

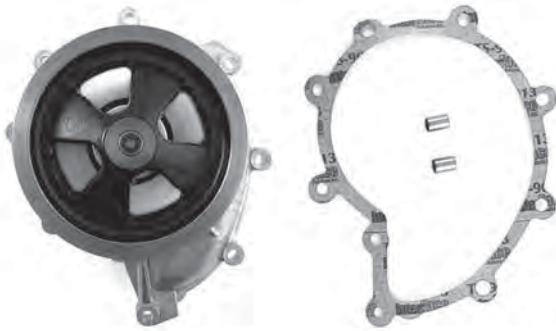

WATER PUMP	61000	259065	571055
<ul style="list-style-type: none"> ● 3 BUS 			
<ul style="list-style-type: none"> ★ N113 			



ALL THE COMPONENTS LISTED IN OUR CATALOGUE ARE NOT ORIGINAL, THOUGH PERFECTLY INTERCHANGEABLE. REFERENCE NUMBERS, EITHER ORIGINAL OR OF A DIFFERENT NATURE, ARE FOR INFORMATION PURPOSES ONLY WHEN PLACING AN ORDER, PLEASE, ALWAYS USE COSIBO REFERENCE NUMBERS AND DO NOT MENTION THE ORIGINAL REFERENCE NUMBERS OF THE TRUCK MANUFACTURERS IN THE INVOICE TO VEHICLE OWNERS OR TO ANYBODY ELSE. THE CUSTOMER TAKES HIS OWN RESPONSIBILITY IF HE DOES NOT COMPLY WITH WHAT ABOVE.

WATER PUMP



- Model
- ★ Application

Code	OEM new	OEM old
61002	1314406	292761 571059 575100

- **3 TRUCK**
- ★ CP/CR/CT113
- **IND. MARINE ENGINE 4**
- ★ D11A/M

WATER PUMP



61174	1377571	1338490 397957 571067
--------------	---------	-----------------------------

- **3 TRUCK**
- ★ CG/CP/CR/CT93
- **3 BUS**
- ★ F/K93

WATER PUMP



63856	1375839	571154
--------------	---------	--------

- **3 TRUCK**
- ★ CR/CT143 WITH RETARDER

ALL THE COMPONENTS LISTED IN OUR CATALOGUE ARE NOT ORIGINAL, THOUGH PERFECTLY INTERCHANGEABLE. REFERENCE NUMBERS, EITHER ORIGINAL OR OF A DIFFERENT NATURE, ARE FOR INFORMATION PURPOSES ONLY WHEN PLACING AN ORDER, PLEASE, ALWAYS USE COSIBO REFERENCE NUMBERS AND DO NOT MENTION THE ORIGINAL REFERENCE NUMBERS OF THE TRUCK MANUFACTURERS IN THE INVOICE TO VEHICLE OWNERS OR TO ANYBODY ELSE. THE CUSTOMER TAKES HIS OWN RESPONSIBILITY IF HE DOES NOT COMPLY WITH WHAT ABOVE.

		Code	OEM new	OEM old
WATER PUMP	● Model	64008	1549482	1433792
	★ Application			1510404 1549481 570958
	● 4 TRUCK			
	★	AD/ADA1501P - RBP/RP832 835 - 4X4 6X6 - AD/ADA1501P ADRE 6X4 8X4 - 8X8 AD1101P - AD1100P 4X4 - 6X4 - 8X4 - 6X6 ADRE - AS1300 - ASA1000 6X2 - 8X2 - 8X2/4 - AD/ADA1500P RP832 - ADRE 6X4 - 8X4 - 6X6 - 8X8 - AD/ADA1500P - 1501P ADFR 6X4 - 6X6 - 8X4 - AD/ADA1300 ADRE R660/ADFR RB660 6X4 - 8X4 - ASA80 6X2 - AD/ADA1100/1300/1500		
	● P-G-R-T TRUCK			
	★	D16		
	● IND. MARINE ENGINE 4			
	★	D16A/M		

WATER PUMP	64123	1789522	1546188 570964
	● 4 TRUCK		
	★	DC9 19/20/21 - D11/D12	
	● P-G-R-T TRUCK		
	★	D9 PDE - D11/D12	
	● 4 BUS		
	★	DC9 19/20/21 - D11/D12	
	● IND. MARINE ENGINE 4		
	★	D12 - DC12 57A	
	● IND. MARINE ENGINE 5		
	★	SG9 A280 - DC9A EMS	
	● F-K-N BUS		
	★		

ALL THE COMPONENTS LISTED IN OUR CATALOGUE ARE NOT ORIGINAL, THOUGH PERFECTLY INTERCHANGEABLE. REFERENCE NUMBERS, EITHER ORIGINAL OR OF A DIFFERENT NATURE, ARE FOR INFORMATION PURPOSES ONLY WHEN PLACING AN ORDER, PLEASE, ALWAYS USE COSIBO REFERENCE NUMBERS AND DO NOT MENTION THE ORIGINAL REFERENCE NUMBERS OF THE TRUCK MANUFACTURERS IN THE INVOICE TO VEHICLE OWNERS OR TO ANYBODY ELSE. THE CUSTOMER TAKES HIS OWN RESPONSIBILITY IF HE DOES NOT COMPLY WITH WHAT ABOVE.

WATER PUMP



	Code	OEM new	OEM old
● Model	64167	1354103	571150
★ Application			
● 3 TRUCK			
★	CP/CR/CT113 GR/GRS900R - CP113 GA850 ALLISON HD460P		
● 3 BUS			
★	K113 GR801R		

WATER PUMP



	64645	1375838	571153
● 3 TRUCK			
★	CR/CT143		

WATER PUMP REPAIR KIT

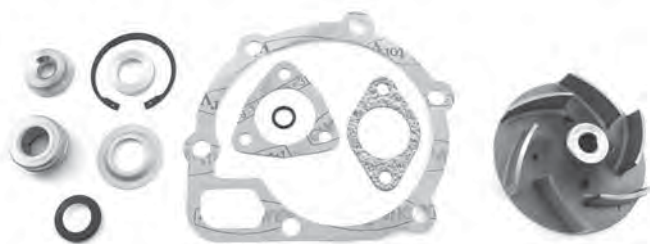

	61147	550044	
● 3 BUS			
★	F/K/L/N113 - 113 - FOR OUR 61000		
● IND. MARINE ENGINE 4			
★	D11 - FOR OUR 61000		
● 3 TRUCK			
★	F/L113 - 113 - CP/CR113 - FOR OUR 61000		

ALL THE COMPONENTS LISTED IN OUR CATALOGUE ARE NOT ORIGINAL, THOUGH PERFECTLY INTERCHANGEABLE. REFERENCE NUMBERS, EITHER ORIGINAL OR OF A DIFFERENT NATURE, ARE FOR INFORMATION PURPOSES ONLY WHEN PLACING AN ORDER, PLEASE, ALWAYS USE COSIBO REFERENCE NUMBERS AND DO NOT MENTION THE ORIGINAL REFERENCE NUMBERS OF THE TRUCK MANUFACTURERS IN THE INVOICE TO VEHICLE OWNERS OR TO ANYBODY ELSE. THE CUSTOMER TAKES HIS OWN RESPONSIBILITY IF HE DOES NOT COMPLY WITH WHAT ABOVE.

WATER PUMP REPAIR KIT

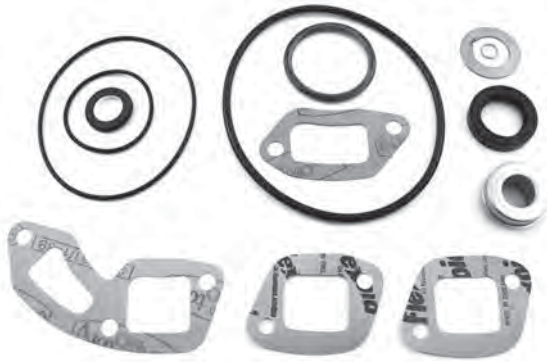

- Model
- ★ Application

Code

OEM new

OEM old

61180

551476

- 3 TRUCK

- ★ CR/CT143

WATER PUMP REPAIR KIT



- 3 BUS

- ★ CT113 - F/K113

- IND. MARINE ENGINE 4

- ★ D11

- 3 TRUCK

- ★ CP/CR/CT113 - F113

61183

550167

WATER PUMP REPAIR KIT



- IND. MARINE ENGINE 4

- ★ D14A/M

- 3 TRUCK

- ★ CR/CT143

61186

550206

ALL THE COMPONENTS LISTED IN OUR CATALOGUE ARE NOT ORIGINAL, THOUGH PERFECTLY INTERCHANGEABLE. REFERENCE NUMBERS, EITHER ORIGINAL OR OF A DIFFERENT NATURE, ARE FOR INFORMATION PURPOSES ONLY WHEN PLACING AN ORDER, PLEASE, ALWAYS USE COSIBO REFERENCE NUMBERS AND DO NOT MENTION THE ORIGINAL REFERENCE NUMBERS OF THE TRUCK MANUFACTURERS IN THE INVOICE TO VEHICLE OWNERS OR TO ANYBODY ELSE. THE CUSTOMER TAKES HIS OWN RESPONSIBILITY IF HE DOES NOT COMPLY WITH WHAT ABOVE.

WATER PUMP REPAIR KIT



	Code	OEM new	OEM old
● Model	63293	550269	
★ Application			
● 4 BUS			
★	94 D9 ENG 6174480 - ENG 8017697		
● IND. MARINE ENGINE 4			
★	94 D9 ENG 6174480 - ENG 8017697		
● 4 TRUCK			
★	94 D9 ENG 6174480 - ENG 8017697		

WATER PUMP REPAIR KIT

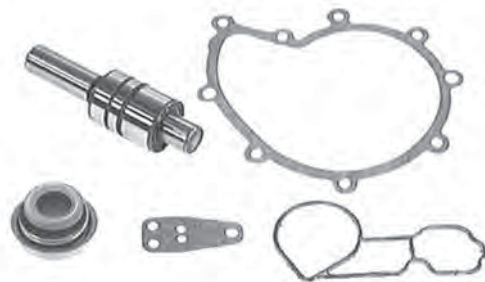

	Code	OEM new	OEM old
	63295	551355	
● 4 BUS			
★	D11/D12 114/124 ENG 6174480 - ENG 8017697		
● IND. MARINE ENGINE 4			
★	D11/D12 114/124 ENG 6174480 - ENG 8017697		
● 4 TRUCK			
★	D11/D12 114/124 ENG 6174480 - ENG 8017697 - DC11 01/02/03/04		

WATER PUMP REPAIR KIT

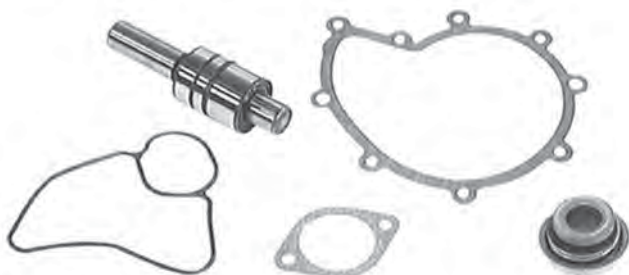

	Code	OEM new	OEM old
	63296	551369	
● 4 TRUCK			
★	144		

ALL THE COMPONENTS LISTED IN OUR CATALOGUE ARE NOT ORIGINAL, THOUGH PERFECTLY INTERCHANGEABLE. REFERENCE NUMBERS, EITHER ORIGINAL OR OF A DIFFERENT NATURE, ARE FOR INFORMATION PURPOSES ONLY WHEN PLACING AN ORDER, PLEASE, ALWAYS USE COSIBO REFERENCE NUMBERS AND DO NOT MENTION THE ORIGINAL REFERENCE NUMBERS OF THE TRUCK MANUFACTURERS IN THE INVOICE TO VEHICLE OWNERS OR TO ANYBODY ELSE. THE CUSTOMER TAKES HIS OWN RESPONSIBILITY IF HE DOES NOT COMPLY WITH WHAT ABOVE.

WATER PUMP REPAIR KIT



- Model
- ★ Application

Code

OEM new

OEM old

64188

551477

- IND. MARINE ENGINE 4

- ★ D14A/M

SEAL RING



64376

1804034

1522518

- 4 BUS

- ★ DC9 20/21 - D11/D12

- F-K-N BUS

- ★ D9 XPI

- IND. MARINE ENGINE 4

- ★ D116 48A/53A - D12 - DC12 57A - D112 49A - D16A/M - D116 45M - D112 68M/69M

- IND. MARINE ENGINE 5

- ★ SG9 A280 - DC9A EMS

- 4 TRUCK

- ★ D11/12/16 - OSC11 G03 - DC9 20/21

- P-G-R-T TRUCK

- ★ D9/D11/D12/D13/D16 - D9 PDE

	Code	OEM new	OEM old
RUBBER HOSE	61808	142729	
<ul style="list-style-type: none"> ● Model ★ Application 			
<ul style="list-style-type: none"> ● 3 TRUCK ★ GR900R/GRS900R 			



RUBBER HOSE	61798	303643	
<ul style="list-style-type: none"> ● 3 TRUCK ★ CR 143 			



RUBBER HOSE	61864	318350	
<ul style="list-style-type: none"> ● 3 TRUCK ★ CT 113 ENG 5307928 - ENG 4070104 - CP/CR 113 ENG 5307760 - ENG 4070104 			



RUBBER HOSE	61212	346627	
<ul style="list-style-type: none"> ● 3 TRUCK ★ CP/CR/CT113 - CR/CT143 			
<ul style="list-style-type: none"> ● IND. MARINE ENGINE 4 ★ DS14 69M - DI14 82M 			







ALL THE COMPONENTS LISTED IN OUR CATALOGUE ARE NOT ORIGINAL, THOUGH PERFECTLY INTERCHANGEABLE. REFERENCE NUMBERS, EITHER ORIGINAL OR OF A DIFFERENT NATURE, ARE FOR INFORMATION PURPOSES ONLY WHEN PLACING AN ORDER, PLEASE, ALWAYS USE COSIBO REFERENCE NUMBERS AND DO NOT MENTION THE ORIGINAL REFERENCE NUMBERS OF THE TRUCK MANUFACTURERS IN THE INVOICE TO VEHICLE OWNERS OR TO ANYBODY ELSE. THE CUSTOMER TAKES HIS OWN RESPONSIBILITY IF HE DOES NOT COMPLY WITH WHAT ABOVE.

	Code	OEM new	OEM old
RUBBER HOSE	61799	223315	
	<ul style="list-style-type: none"> ● Model ★ Application 		
	<ul style="list-style-type: none"> ● 3 TRUCK ★ CP/CR 113 - CP/CR DSC11 21/22/23 DTC11 		
	<ul style="list-style-type: none"> ● IND. MARINE ENGINE 4 ★ SG9 A280 - D9 - D14 - D11 		
	<ul style="list-style-type: none"> ● IND. MARINE ENGINE 5 ★ SG9 A280 		
RUBBER SLEEVE	61213	354967	
	<ul style="list-style-type: none"> ● 3 TRUCK ★ DSC14 03/04/06/08/09/10 		
RUBBER HOSE	61793	298823	
	<ul style="list-style-type: none"> ● 3 BUS ★ F113 RH 		
	<ul style="list-style-type: none"> ● 3 TRUCK ★ CP/CR/CT113 GR/GRS900R - CT143 - CR13/19 D11 - CP/CR DSC11 21/22(EDC)/23 - DTC11 - CR13/19 DSC11 21/22(EDC)/23 - DTC11 - CP113 ML/HL 4X2 6X2 GA850 		
RUBBER HOSE	61869	1340201	
	<ul style="list-style-type: none"> ● 3 BUS ★ F 113 RH 		
	<ul style="list-style-type: none"> ● 3 TRUCK ★ CP/CR/CT 113 - CR13/19 D11 - CP/CR DSC11 21/22(EDC)/23 - DTC11 - CR13/19 DSC11 21/22(EDC)/23 - DTC11 - CP/CR DSC11 21/22/23 - DTC11 		

ALL THE COMPONENTS LISTED IN OUR CATALOGUE ARE NOT ORIGINAL, THOUGH PERFECTLY INTERCHANGEABLE. REFERENCE NUMBERS, EITHER ORIGINAL OR OF A DIFFERENT NATURE, ARE FOR INFORMATION PURPOSES ONLY WHEN PLACING AN ORDER, PLEASE, ALWAYS USE COSIBO REFERENCE NUMBERS AND DO NOT MENTION THE ORIGINAL REFERENCE NUMBERS OF THE TRUCK MANUFACTURERS IN THE INVOICE TO VEHICLE OWNERS OR TO ANYBODY ELSE. THE CUSTOMER TAKES HIS OWN RESPONSIBILITY IF HE DOES NOT COMPLY WITH WHAT ABOVE.

	Code	OEM new	OEM old
RUBBER HOSE 	63176	318364	
<ul style="list-style-type: none"> ● Model ★ Application 			
<ul style="list-style-type: none"> ● 3 TRUCK ★ CP 113 - CT143 			
RUBBER HOSE 	63178	301789	
<ul style="list-style-type: none"> ● 3 TRUCK ★ CT 113 - CT 143 			
RUBBER HOSE 	63179	382985	
<ul style="list-style-type: none"> ● 3 BUS ★ F 113 			
<ul style="list-style-type: none"> ● 3 TRUCK ★ CP/CR/CT 113 - CP/CR/CT 113 79° - 			
RUBBER HOSE 	63601	1377231	
<ul style="list-style-type: none"> ● 4 BUS ★ F 94 			
<ul style="list-style-type: none"> ● 4 TRUCK ★ CP DC9 19/20/21 - CP/CR 114/124 - CR/CT 164 - CP/CR/CT DSC11 74/75/79 - CR/CT 144 - CT 124 - CP/CR 94 - CR/CT 144 GR/GRS900R - CT 124 GR/GRS900R - CP 19F D9 - CP/CR 124 4X4 6X6 - CR 124 4X4 6X6 GR/GRS900R - CP/CR/CT DC11 01/02/03/04/06/07 - CP/CR/CT DC11 01/02/03/04/06/07 GR900R/GRS890R 			

ALL THE COMPONENTS LISTED IN OUR CATALOGUE ARE NOT ORIGINAL, THOUGH PERFECTLY INTERCHANGEABLE. REFERENCE NUMBERS, EITHER ORIGINAL OR OF A DIFFERENT NATURE, ARE FOR INFORMATION PURPOSES ONLY WHEN PLACING AN ORDER, PLEASE, ALWAYS USE COSIBO REFERENCE NUMBERS AND DO NOT MENTION THE ORIGINAL REFERENCE NUMBERS OF THE TRUCK MANUFACTURERS IN THE INVOICE TO VEHICLE OWNERS OR TO ANYBODY ELSE. THE CUSTOMER TAKES HIS OWN RESPONSIBILITY IF HE DOES NOT COMPLY WITH WHAT ABOVE.

	Code	OEM new	OEM old
RUBBER HOSE	63602	1341729	
	<ul style="list-style-type: none"> ● Model ★ Application 		
	<ul style="list-style-type: none"> ● 4 TRUCK ★ CP 124 - CP DC11 01/02/03/04/06/07 		
RUBBER HOSE	65125	1373919	
	<ul style="list-style-type: none"> ● 4 BUS ★ F 94 		
	<ul style="list-style-type: none"> ● 4 TRUCK ★ CP 19F D9 - CP/CR 94 		
RUBBER HOSE	65128	1376226	
	<ul style="list-style-type: none"> ● IND. MARINE ENGINE 4 ★ D12A - DC12 50A - SG9 A280 		
	<ul style="list-style-type: none"> ● IND. MARINE ENGINE 5 ★ DC9A EMS 		
	<ul style="list-style-type: none"> ● 4 TRUCK ★ CP 19F D9 - CP/CR/CT DSC11 74/75/79 - CP/CR 94 		
RUBBER HOSE	65129	1374040	
	<ul style="list-style-type: none"> ● 4 TRUCK ★ CP/CR 14 - CP/CR19 114/124 - CP/CR 114/124 - CP DC9 19/20/21 - CP DSC11 74/75/79 - CR/CP94 - CP 19F D9 - CP/CR DC11 01/02/03/04/06/07 GR900R GRS890R - CP/CR 124 GR/GRS900R 		

ALL THE COMPONENTS LISTED IN OUR CATALOGUE ARE NOT ORIGINAL, THOUGH PERFECTLY INTERCHANGEABLE. REFERENCE NUMBERS, EITHER ORIGINAL OR OF A DIFFERENT NATURE, ARE FOR INFORMATION PURPOSES ONLY WHEN PLACING AN ORDER, PLEASE, ALWAYS USE COSIBO REFERENCE NUMBERS AND DO NOT MENTION THE ORIGINAL REFERENCE NUMBERS OF THE TRUCK MANUFACTURERS IN THE INVOICE TO VEHICLE OWNERS OR TO ANYBODY ELSE. THE CUSTOMER TAKES HIS OWN RESPONSIBILITY IF HE DOES NOT COMPLY WITH WHAT ABOVE.

	Code	OEM new	OEM old
RUBBER HOSE	65130	1449431	1376293
			
<ul style="list-style-type: none"> ● Model ★ Application 			
<ul style="list-style-type: none"> ● 4 TRUCK 			
<ul style="list-style-type: none"> ★ CR 164 - CR/CT DSC11 74/75/79 - CP/CR 94 - CR/CT 144 GR/GRS900R - CP/CR/CT 124 GR/GRS900R - CR 124 4X4 6X6 GR/GRS900R - CP/CR/CT DC11 01/02/03/04/06/07 - GR900R GRS890R 			
RUBBER HOSE	65131	1376895	
			
<ul style="list-style-type: none"> ● 4 TRUCK 			
<ul style="list-style-type: none"> ★ CP DC9 19/20/21 - CP/CR 114/124 - CR 164 - CP/CR DSC11 74/75/79 - CR 144 - CR 144 GR/GRS900R - CP/CR 94 - CP 19F D9 - CP/CR 124 4X4 6X6 - CR 124 4X4 6X6 GR/GRS900R - CP/CR DC11 01/02/03/04/06/07 - CP/CR DC11 01/02/03/04/06/07 GR900R/GRS890R - CP/CR 124 GR/GRS900R - CR 124 8X8 WLS/ZLS GRS890R 			
RUBBER HOSE	65132	1545116	1380621 1448384 1531776
			
<ul style="list-style-type: none"> ● 4 TRUCK 			
<ul style="list-style-type: none"> ★ CP DC9 19/20/21 - CP/CR 114/124 - CR 164 - CR DSC11 74/75/79 - CP/CR 94 - CR 144 GR/GRS900 - CP 19F D9 - CP/CR 124 4X4 6X6 - CR 124 4X4 6X6 GR/GRS900R - CP/CR DC11 01/02/03/04/06/07 - CP/CR DC11 01/02/03/04/06/07 GR900R/GRS890R - CP/CR 124 GR/GRS900R - CR 124 8X8 WLS/ZLS GRS890R 			

ALL THE COMPONENTS LISTED IN OUR CATALOGUE ARE NOT ORIGINAL, THOUGH PERFECTLY INTERCHANGEABLE. REFERENCE NUMBERS, EITHER ORIGINAL OR OF A DIFFERENT NATURE, ARE FOR INFORMATION PURPOSES ONLY WHEN PLACING AN ORDER, PLEASE, ALWAYS USE COSIBO REFERENCE NUMBERS AND DO NOT MENTION THE ORIGINAL REFERENCE NUMBERS OF THE TRUCK MANUFACTURERS IN THE INVOICE TO VEHICLE OWNERS OR TO ANYBODY ELSE. THE CUSTOMER TAKES HIS OWN RESPONSIBILITY IF HE DOES NOT COMPLY WITH WHAT ABOVE.

	Code	OEM new	OEM old
RUBBER HOSE	65133	1376896	
	<ul style="list-style-type: none"> ● Model ★ Application 		
	<ul style="list-style-type: none"> ● 4 TRUCK ★ CP DC9 19/20/21 - CP/CR 114/124 - CR 164 - CP/CR DSC11 74/75/79 - CR 144 - CP/CR 94 - CR 144 GR/GRS900R - CP 19F D9 - CP/CR 124 4X4 6X6 - CR 124 4X4 6X6 GR/GRS900R - CP/CR DC11 01/02/03/04/06/07 - CP/CR DC11 01/02/03/04/06/07 GR900R/GRS890R - CP/CR 124 GR/GRS900R - CR 124 8X8 WLS/ZLS GRS890R 		
RUBBER HOSE	65134	1383873	
	<ul style="list-style-type: none"> ● 4 TRUCK ★ CP DC9 19/20/21 - CP/CR 114/124 - CR 164 - CP/CR DSC11 74/75/79 - CR 144 - CP/CR 94 - CR 144 GR/GRS900R - CP 19F D9 - CP/CR 124 4X4 6X6 - CR 124 4X4 6X6 GR/GRS900R - CP/CR DC11 01/02/03/04/06/07 - CP/CR DC11 01/02/03/04/06/07 GR900R/GRS890R - CP/CR 124 GR/GRS900R - CR 124 8X8 WLS/ZLS GRS890R 		
RUBBER HOSE	65135	1383990	
	<ul style="list-style-type: none"> ● 4 TRUCK ★ CP/CR/CT DSC11 74/75/79 		

ALL THE COMPONENTS LISTED IN OUR CATALOGUE ARE NOT ORIGINAL, THOUGH PERFECTLY INTERCHANGEABLE. REFERENCE NUMBERS, EITHER ORIGINAL OR OF A DIFFERENT NATURE, ARE FOR INFORMATION PURPOSES ONLY WHEN PLACING AN ORDER, PLEASE, ALWAYS USE COSIBO REFERENCE NUMBERS AND DO NOT MENTION THE ORIGINAL REFERENCE NUMBERS OF THE TRUCK MANUFACTURERS IN THE INVOICE TO VEHICLE OWNERS OR TO ANYBODY ELSE. THE CUSTOMER TAKES HIS OWN RESPONSIBILITY IF HE DOES NOT COMPLY WITH WHAT ABOVE.

	Code	OEM new	OEM old
RUBBER HOSE	65136	1426194	1375874
● Model			
★ Application			
● F-K-N BUS			
★ F			
● 4 TRUCK			
★ CP/CR 14 - CP/CR 19 114/124 - CP/CR 114/124 - CP DC9 19/20/21 - CR/CT 164 - CP/CR/CT DSC11 74/75/79 - CR/CT 144 GR/GRS900R - CP/CR/CT 124 GR/GRS900R - CR 124 4X4 6X6 GR/GRS900R - CP/CR/CT DC11 01/02/03/04/06/07 GR900R/GRS890R			
● P-G-R-T TRUCK			
★ CG/CR D9/11/12 - CR D9/11/12 EGR - CR/CT D16 - CP D9 PDE - D11/12 - CG/CP/CR D11/12 4X4 6X6 - CT D11/D12 - CT D12 EGR - CG/CR D9/12 EGR			





RUBBER HOSE	65137	1395066	1384464
● 4 TRUCK			
★ CP/CR/CT DSC11 74/75/79			



RUBBER HOSE	65142	1385086	
● 4 TRUCK			
★ CP/CR/CT DSC11 74/75/79			



	Code	OEM new	OEM old
RUBBER HOSE	65143	1529007	1377332 1447198
	<ul style="list-style-type: none"> ● Model ★ Application 		
	<ul style="list-style-type: none"> ● 4 TRUCK ★ CP/CR 114/124 - CP/CR/CT 124 - CT 124 GR/GRS900R - CP/CR 124 4X4 6X6 - CR 124 4X4 6X6 GR/GRS900R - CP/CR/CT DC11 01/02/03/04/06/07 - CP/CR/CT DC11 01/02/03/04/06/07 GR900R/GRS890R - CP/CR 124 GR/GRS900R - CR 124 8X8 WLS/ZLS GRS890R 		
RUBBER HOSE	65144	1377331	
	<ul style="list-style-type: none"> ● 4 TRUCK ★ CR/CT 124 - CR 124 4X4 6X6 - CR/CT DC11 01/02/03/04/06/07 		
RUBBER HOSE	65145	1376949	1358296
	<ul style="list-style-type: none"> ● 4 TRUCK ★ CP DSC11 74/75/79 - CR 144 CH 1213498 - CP/CR 124 - CR 144 GR/GRS900R - CP/CR 124 4X4 6X6 - CR 124 4X4 6X6 GR/GRS900R - CP/CR 124 GR/GRS900R 		
RUBBER HOSE	65150	1375603	1357341
	<ul style="list-style-type: none"> ● 4 TRUCK ★ D14 		

ALL THE COMPONENTS LISTED IN OUR CATALOGUE ARE NOT ORIGINAL, THOUGH PERFECTLY INTERCHANGEABLE. REFERENCE NUMBERS, EITHER ORIGINAL OR OF A DIFFERENT NATURE, ARE FOR INFORMATION PURPOSES ONLY WHEN PLACING AN ORDER, PLEASE, ALWAYS USE COSIBO REFERENCE NUMBERS AND DO NOT MENTION THE ORIGINAL REFERENCE NUMBERS OF THE TRUCK MANUFACTURERS IN THE INVOICE TO VEHICLE OWNERS OR TO ANYBODY ELSE. THE CUSTOMER TAKES HIS OWN RESPONSIBILITY IF HE DOES NOT COMPLY WITH WHAT ABOVE.

	Code	OEM new	OEM old
RUBBER HOSE	63180	382983	
<ul style="list-style-type: none"> ● Model ★ Application 			
<ul style="list-style-type: none"> ● 3 BUS ★ F 113 LHD/RHD 			



RUBBER HOSE	64355	1733735	
<ul style="list-style-type: none"> ● P-G-R-T TRUCK ★ CR D16 			



RUBBER HOSE	63180	382983	
<ul style="list-style-type: none"> ● 3 TRUCK ★ CP/CR/CT 113 - CR 13/19 D11 - DSC11 21/22(EDC)/23 DTC11 - CP/CR DSC11 21/22(EDC)/23 DTC11 			



RUBBER HOSE	64356	1790071	
<ul style="list-style-type: none"> ● P-G-R-T TRUCK ★ D13 - CG/CP/CR 			



ALL THE COMPONENTS LISTED IN OUR CATALOGUE ARE NOT ORIGINAL, THOUGH PERFECTLY INTERCHANGEABLE. REFERENCE NUMBERS, EITHER ORIGINAL OR OF A DIFFERENT NATURE, ARE FOR INFORMATION PURPOSES ONLY WHEN PLACING AN ORDER, PLEASE, ALWAYS USE COSIBO REFERENCE NUMBERS AND DO NOT MENTION THE ORIGINAL REFERENCE NUMBERS OF THE TRUCK MANUFACTURERS IN THE INVOICE TO VEHICLE OWNERS OR TO ANYBODY ELSE. THE CUSTOMER TAKES HIS OWN RESPONSIBILITY IF HE DOES NOT COMPLY WITH WHAT ABOVE.

	Code	OEM new	OEM old
RUBBER PLUG	64081	1350394	
● Model			
★ Application			
● 4 BUS			
★ K/L DSC9 DS19 DC9 - CN 94 - F94 LHD - L94 OSC9 - CL94 DSC9 DS19 DC9			
● F-K-N BUS			
★ K			
● IND. MARINE ENGINE 5			
★ DC9A EMS			
● 3 TRUCK			
★ CP 93 - GA850R CHIUSO			
● 4 TRUCK			
★ DSC14 13/15 - DC11/D12 - CP/CR 14 - CP/CR 19 - CP DC9 19/20/21 - CP DSC 74/75/79 - CP DSC11 74/75/79 - CT DSC11 74/75/79 - CR/CT 144 - CR/CP/CT 124 - CR/CP 124 4X4 6X6 - CR/CP/CT DC11 01/02/03/04/06/07			
● P-G-R-T TRUCK			
★ CR D9/11/12 EGR - CG/CR D9/12 EGR - CR D9 PDE - CR D16 - CP/CT D9 PDE - D11/D12 - D9 XPI			



FUEL PUMP



- Model
- ★ Application

Code

OEM new

OEM old

65154

269342

- 2 TRUCK

- ★ DS14 01

FEED PUMP



- 3 TRUCK

- ★ DN11 01

61120

211005

FUEL PUMP. ALUMINIUM TANK



- 3 BUS

- ★ DS9 05B - DSC11 08B/C - DSC11 18B

- 3 TRUCK

- ★ DS9 05 - DSC9 02/07/08/10 - DSC11 08/10/13/18/30 - DSC11 08/10 L03

65151

371780

ALL THE COMPONENTS LISTED IN OUR CATALOGUE ARE NOT ORIGINAL, THOUGH PERFECTLY INTERCHANGEABLE. REFERENCE NUMBERS, EITHER ORIGINAL OR OF A DIFFERENT NATURE, ARE FOR INFORMATION PURPOSES ONLY WHEN PLACING AN ORDER, PLEASE, ALWAYS USE COSIBO REFERENCE NUMBERS AND DO NOT MENTION THE ORIGINAL REFERENCE NUMBERS OF THE TRUCK MANUFACTURERS IN THE INVOICE TO VEHICLE OWNERS OR TO ANYBODY ELSE. THE CUSTOMER TAKES HIS OWN RESPONSIBILITY IF HE DOES NOT COMPLY WITH WHAT ABOVE.

FUEL PUMP, GLASS TANK



	Code	OEM new	OEM old
● Model	65151/1	371780/1	
★ Application			
● 3 BUS			
★	DS9 05B - DSC11 08B/C - DSC11 18B		
● 3 TRUCK			
★	DS9 05 - DSC9 02/07/08/10 - DSC11 08/10/13/18/30 - DSC11 08/10 L03		

FUEL PUMP



	65152	319792	
● 3 TRUCK			
★	DSC14 06		

FUEL PUMP



	65153	367624	
● 3 TRUCK			
★	DSC14 03/04/08/09/10/16 - GRH880		
● IND. MARINE ENGINE 4			
★	DI14 81A RE30(EDC)		

ALL THE COMPONENTS LISTED IN OUR CATALOGUE ARE NOT ORIGINAL, THOUGH PERFECTLY INTERCHANGEABLE. REFERENCE NUMBERS, EITHER ORIGINAL OR OF A DIFFERENT NATURE, ARE FOR INFORMATION PURPOSES ONLY WHEN PLACING AN ORDER, PLEASE, ALWAYS USE COSIBO REFERENCE NUMBERS AND DO NOT MENTION THE ORIGINAL REFERENCE NUMBERS OF THE TRUCK MANUFACTURERS IN THE INVOICE TO VEHICLE OWNERS OR TO ANYBODY ELSE. THE CUSTOMER TAKES HIS OWN RESPONSIBILITY IF HE DOES NOT COMPLY WITH WHAT ABOVE.

	Code	OEM new	OEM old
FUEL PUMP	60718	371781	319789
<ul style="list-style-type: none"> ● Model ★ Application 			
<ul style="list-style-type: none"> ● 3 BUS 			
<ul style="list-style-type: none"> ★ DS11 34/74 C/B - DSC11 21 B/C - DS9 08B 			
<ul style="list-style-type: none"> ● 3 TRUCK 			
<ul style="list-style-type: none"> ★ DN9 01 - DS11 34/73 - DSC11 12/16/17 - DS9 06/08 			



FEED PUMP	61936	1375493	
<ul style="list-style-type: none"> ● 4 BUS 			
<ul style="list-style-type: none"> ★ DSC9 11/12/13/15 - DC9 01/02/03/04/05/06 			
<ul style="list-style-type: none"> ● 4 TRUCK 			
<ul style="list-style-type: none"> ★ DSC9 11/12/13/15 - DC9 01/02/03/04/05/06 			



FEED PUMP	65155	1307770	
<ul style="list-style-type: none"> ● 3 BUS 			
<ul style="list-style-type: none"> ★ DS9 05B - DSC11 21B/22B/23B/24B/35B/36B/71B - DS11 75B/77B/78B - DS11 77C/78C - DSC11 04C/24C/27C/71C - DSC9 08B - DS11 75 - DSC11 23/70 			
<ul style="list-style-type: none"> ● 4 BUS 			
<ul style="list-style-type: none"> ★ DC11 07 - DSC12 01/02 			
<ul style="list-style-type: none"> ● IND. MARINE ENGINE 4 			
<ul style="list-style-type: none"> ★ DSC11 58A - DI12 41M/42M/43M/44M/45M/57M - DC/DSC12 40A/42/A - DS19 47M - DSC12 41 - DSI12 40 - DSI11 74M/75M 			
<ul style="list-style-type: none"> ● 3 TRUCK 			
<ul style="list-style-type: none"> ★ DSC9 07/08/09 - DS11 75 - DSC11 21/22/23/35/36/39/70 - DTC11 01/02 			
<ul style="list-style-type: none"> ● 4 TRUCK 			
<ul style="list-style-type: none"> ★ DC11 07 - DSC12 01/02 - DSC11 74/75/79 			



ALL THE COMPONENTS LISTED IN OUR CATALOGUE ARE NOT ORIGINAL, THOUGH PERFECTLY INTERCHANGEABLE. REFERENCE NUMBERS, EITHER ORIGINAL OR OF A DIFFERENT NATURE, ARE FOR INFORMATION PURPOSES ONLY WHEN PLACING AN ORDER, PLEASE, ALWAYS USE COSIBO REFERENCE NUMBERS AND DO NOT MENTION THE ORIGINAL REFERENCE NUMBERS OF THE TRUCK MANUFACTURERS IN THE INVOICE TO VEHICLE OWNERS OR TO ANYBODY ELSE. THE CUSTOMER TAKES HIS OWN RESPONSIBILITY IF HE DOES NOT COMPLY WITH WHAT ABOVE.

HAND PUMP-ALUMINIUM VERSION



	Code	OEM new	OEM old
● Model	61121	192882	
★ Application			
● SUITABLE/ADATTABILE			
★	BOSCH: 2 441 222 003 - 2 441 222 016 - 2 441 222 020 - 2 441 222 023 - 2 441 222 025 - 2 447 010 025		
● 3 BUS			
★			
● 4 BUS			
★	DC9 01/02/03/04/05/06/19/20/21 - DSC9 13/15 - DC11 07 - DSC12 01/02 - DC11/D12 PDE - DSC9 11/12/13/15		
● IND. MARINE ENGINE 4			
★	D12A/M EMS - D16A/M - DSC12 41 - DSI12 40		
● IND. MARINE ENGINE 5			
★	DC9A EMS		
● 3 TRUCK			
★			
● 4 TRUCK			
★	DC9 01/02/03/04/05/06/19/20/21 - DSC9 11/12/13/15 - DC11 07 - DSC12 01/02 - DC11/D12 PDE - DC16 01/02 - DSC14 13/15 - DSC11 74/75/79		
● P-G-R-T TRUCK			
★	D9/11/12/16		

ALL THE COMPONENTS LISTED IN OUR CATALOGUE ARE NOT ORIGINAL, THOUGH PERFECTLY INTERCHANGEABLE. REFERENCE NUMBERS, EITHER ORIGINAL OR OF A DIFFERENT NATURE, ARE FOR INFORMATION PURPOSES ONLY WHEN PLACING AN ORDER, PLEASE, ALWAYS USE COSIBO REFERENCE NUMBERS AND DO NOT MENTION THE ORIGINAL REFERENCE NUMBERS OF THE TRUCK MANUFACTURERS IN THE INVOICE TO VEHICLE OWNERS OR TO ANYBODY ELSE. THE CUSTOMER TAKES HIS OWN RESPONSIBILITY IF HE DOES NOT COMPLY WITH WHAT ABOVE.

		Code	OEM new	OEM old
HAND PUMP	● Model	61955	1427670	1384501 393620
	★ Application			
	● 3 BUS			
	★			
	● 4 BUS			
	★	DC9 01/02/03/04/05/06/19/20/21 - DSC9 13/15 - DC11 07 - DSC12 01/02 - DC11/D12 PDE - DSC9 11/12/13/15		
	● IND. MARINE ENGINE 4			
	★	D12A/M EMS - D16A/M - DSC12 41 - DSI12 40		
	● IND. MARINE ENGINE 5			
	★	DC9A EMS		
	● 3 TRUCK			
	★			
	● 4 TRUCK			
	★	DC9 01/02/03/04/05/06/19/20/21 - DSC9 11/12/13/15 - DC11 07 - DSC12 01/02 - DC11/D12 PDE - DC16 01/02 - DSC14 13/15 - DSC11 74/75/79		
● P-G-R-T TRUCK				
★	D9/11/12/16			

		64790	804670	
O-RING	● 4 BUS			
	★	DC11 - D12 - DC9 19/20/21 - DC11/D12 PDE		
	● F-K-N BUS			
	★	D9 N XPI - D12 HPI - D9/D11/D12 PDE - D9		
	● IND. MARINE ENGINE 4			
	★	DI16 40A/41A/48A/53A - D16A - D16M - DSI14 69M - DI14 82M - D14 - D12M EMS - D12A EMS		
	● IND. MARINE ENGINE 5			
	★	DC9A EMS		
	● 4 TRUCK			
	★	DC11 - D12 - DC9 19/20/21 - DC11/D12 PDE - DSC12 01/02 - DC16 01/02 - DT12 02/08/10 - DC12 03 HPI		
● P-G-R-T TRUCK				
★	D16 - D9/D11/D12 PDE - D12 HPI			

ALL THE COMPONENTS LISTED IN OUR CATALOGUE ARE NOT ORIGINAL, THOUGH PERFECTLY INTERCHANGEABLE. REFERENCE NUMBERS, EITHER ORIGINAL OR OF A DIFFERENT NATURE, ARE FOR INFORMATION PURPOSES ONLY WHEN PLACING AN ORDER, PLEASE, ALWAYS USE COSIBO REFERENCE NUMBERS AND DO NOT MENTION THE ORIGINAL REFERENCE NUMBERS OF THE TRUCK MANUFACTURERS IN THE INVOICE TO VEHICLE OWNERS OR TO ANYBODY ELSE. THE CUSTOMER TAKES HIS OWN RESPONSIBILITY IF HE DOES NOT COMPLY WITH WHAT ABOVE.

FUEL FILTER (6 BAR)







	Code	OEM new	OEM old
● Model	60632	1763776	1411894
★ Application			
● 4 BUS			
★ L D9/DC11/D12/D14 12.2 BAR - S D9/DC11/D12/D14 - DSC12 03/05 - DC12 01/02 - D11/D12 PDE - D12A EMS - D16M			
● IND. MARINE ENGINE 4			
★ D12A/M EMS - D16M - DI16 40/41/48/53A			
● 4 TRUCK			
★ L D9/DC11/D12/D14 9.3/12.2 BAR - S D9/DC11/D12/D14 - DSC12 03/05 - DC12 01/02 - D11/D12 PDE - D12A EMS - D16M - DC11 01/02/03/04/06			

O-RING KIT







	63322	1422564	
● 4 BUS			
★ DC9 19/20/21 - DSC12 03 PDE - DC12 01/02/05/09/16 PDE - DC11 03/04/06 PDE - DSC12 05 PDE			
● F-K-N BUS			
★ D9 PDE - DC12 06/17 - D11			
● IND. MARINE ENGINE 4			
★ DC16 - D12A EMS - D12A/M EMS - DI16 40A/41A/48A/53A			
● IND. MARINE ENGINE 5			
★ DC9A EMS			
● 4 TRUCK			
★ DC16 - DC9 19/20/21 - DSC12 03/05 PDE - DC12 01/02/09 PDE - DC16 01/02 PDE - DC11 01/02/03/04/06 PDE			
● P-G-R-T TRUCK			
★ D9 PDE - DC12 06/17 - D16 - D11			





ALL THE COMPONENTS LISTED IN OUR CATALOGUE ARE NOT ORIGINAL, THOUGH PERFECTLY INTERCHANGEABLE. REFERENCE NUMBERS, EITHER ORIGINAL OR OF A DIFFERENT NATURE, ARE FOR INFORMATION PURPOSES ONLY WHEN PLACING AN ORDER, PLEASE, ALWAYS USE COSIBO REFERENCE NUMBERS AND DO NOT MENTION THE ORIGINAL REFERENCE NUMBERS OF THE TRUCK MANUFACTURERS IN THE INVOICE TO VEHICLE OWNERS OR TO ANYBODY ELSE. THE CUSTOMER TAKES HIS OWN RESPONSIBILITY IF HE DOES NOT COMPLY WITH WHAT ABOVE.

	Code	OEM new	OEM old
INJECTION PIPE 1ST	60319	258410	
	<ul style="list-style-type: none"> ● Model ★ Application 		
	<ul style="list-style-type: none"> ● 2 TRUCK ★ G/P/R/T 112 		
	<ul style="list-style-type: none"> ● 1 TRUCK ★ L/LS/LT 111 - LB/LBS/LBT 111 		
INJECTION PIPE 2ST	60322	168778	
	<ul style="list-style-type: none"> ● 2 TRUCK ★ G/P/R/T 112 		
	<ul style="list-style-type: none"> ● 1 TRUCK ★ L/LS/LT 111 - LB/LBS/LBT 111 		
INJECTION PIPE 3RD	60320	258411	
	<ul style="list-style-type: none"> ● 2 TRUCK ★ G/P/R/T 112 		
	<ul style="list-style-type: none"> ● 1 TRUCK ★ L/LS/LT 111 - LB/LBS/LBT 111 		
INJECTON PIPE 4TH	60321	258412	
	<ul style="list-style-type: none"> ● 2 TRUCK ★ G/P/R/T 112 		
	<ul style="list-style-type: none"> ● 1 TRUCK ★ L/LS/LT 111 - LB/LBS/LBT 111 		

ALL THE COMPONENTS LISTED IN OUR CATALOGUE ARE NOT ORIGINAL, THOUGH PERFECTLY INTERCHANGEABLE. REFERENCE NUMBERS, EITHER ORIGINAL OR OF A DIFFERENT NATURE, ARE FOR INFORMATION PURPOSES ONLY WHEN PLACING AN ORDER, PLEASE, ALWAYS USE COSIBO REFERENCE NUMBERS AND DO NOT MENTION THE ORIGINAL REFERENCE NUMBERS OF THE TRUCK MANUFACTURERS IN THE INVOICE TO VEHICLE OWNERS OR TO ANYBODY ELSE. THE CUSTOMER TAKES HIS OWN RESPONSIBILITY IF HE DOES NOT COMPLY WITH WHAT ABOVE.

	Code	OEM new	OEM old
INJECTION PIPE 5TH 	60323	168781	
<ul style="list-style-type: none"> ● Model ★ Application 			
<ul style="list-style-type: none"> ● 2 TRUCK ★ G/P/R/T 112 			
<ul style="list-style-type: none"> ● 1 TRUCK ★ L/LS/LT 111 - LB/LBS/LBT 111 			
INJECTION PIPE 6TH 	60324	168782	
<ul style="list-style-type: none"> ● 2 TRUCK ★ G/P/R/T 112 			
<ul style="list-style-type: none"> ● 1 TRUCK ★ L/LS/LT 111 - LB/LBS/LBT 111 			
INJECTION PIPE 1ST 	60331	169316	
<ul style="list-style-type: none"> ● 2 TRUCK ★ T112 			
<ul style="list-style-type: none"> ● 1 TRUCK ★ L/LS/LT110 - LB/LBS/LBT110 - L/LS/LT111 - LB/LBS/LBT111 			
INJECTION PIPE 2ND 	60332	169317	
<ul style="list-style-type: none"> ● 2 TRUCK ★ T112 			
<ul style="list-style-type: none"> ● 1 TRUCK ★ L/LS/LT110 - LB/LBS/LBT110 - L/LS/LT111 - LB/LBS/LBT111 			
INJECTION PIPE 3RD 	60333	169318	
<ul style="list-style-type: none"> ● 2 TRUCK ★ T112 			
<ul style="list-style-type: none"> ● 1 TRUCK ★ L/LS/LT110 - LB/LBS/LBT110 - L/LS/LT111 - LB/LBS/LBT111 			

ALL THE COMPONENTS LISTED IN OUR CATALOGUE ARE NOT ORIGINAL, THOUGH PERFECTLY INTERCHANGEABLE. REFERENCE NUMBERS, EITHER ORIGINAL OR OF A DIFFERENT NATURE, ARE FOR INFORMATION PURPOSES ONLY WHEN PLACING AN ORDER, PLEASE, ALWAYS USE COSIBO REFERENCE NUMBERS AND DO NOT MENTION THE ORIGINAL REFERENCE NUMBERS OF THE TRUCK MANUFACTURERS IN THE INVOICE TO VEHICLE OWNERS OR TO ANYBODY ELSE. THE CUSTOMER TAKES HIS OWN RESPONSIBILITY IF HE DOES NOT COMPLY WITH WHAT ABOVE.

	Code	OEM new	OEM old
INJECTION PIPE 4TH 	60334	169319	
<ul style="list-style-type: none"> ● Model ★ Application 			
<ul style="list-style-type: none"> ● 2 TRUCK ★ T112 			
<ul style="list-style-type: none"> ● 1 TRUCK ★ L/LS/LT110 - LB/LBS/LBT110 - L/LS/LT111 - LB/LBS/LBT111 			
INJECTION PIPE 5TH 	60335	169320	
<ul style="list-style-type: none"> ● 2 TRUCK ★ T112 			
<ul style="list-style-type: none"> ● 1 TRUCK ★ L/LS/LT110 - LB/LBS/LBT110 - L/LS/LT111 - LB/LBS/LBT111 			
INJECTION PIPE 6TH 	60336	169321	
<ul style="list-style-type: none"> ● 2 TRUCK ★ T112 			
<ul style="list-style-type: none"> ● 1 TRUCK ★ L/LS/LT110 - LB/LBS/LBT110 - L/LS/LT111 - LB/LBS/LBT111 			
INJECTION PIPE 1ST 	60325	258686	
<ul style="list-style-type: none"> ● 1 TRUCK ★ L/LS/LT111 - LB/LBS/LBT111/111H 			
<ul style="list-style-type: none"> ● 1 TRUCK ★ L/LS/LT111 - LB/LBS/LBT111/111H 			

ALL THE COMPONENTS LISTED IN OUR CATALOGUE ARE NOT ORIGINAL, THOUGH PERFECTLY INTERCHANGEABLE. REFERENCE NUMBERS, EITHER ORIGINAL OR OF A DIFFERENT NATURE, ARE FOR INFORMATION PURPOSES ONLY WHEN PLACING AN ORDER, PLEASE, ALWAYS USE COSIBO REFERENCE NUMBERS AND DO NOT MENTION THE ORIGINAL REFERENCE NUMBERS OF THE TRUCK MANUFACTURERS IN THE INVOICE TO VEHICLE OWNERS OR TO ANYBODY ELSE. THE CUSTOMER TAKES HIS OWN RESPONSIBILITY IF HE DOES NOT COMPLY WITH WHAT ABOVE.

	Code	OEM new	OEM old
INJECTION PIPE 2ND	60326	258687	



- Model
 - ★ Application
- | |
|-----------------------------------|
| ● 1 TRUCK |
| ★ L/LS/LT111 - LB/LBS/LBT111/111H |

INJECTION PIPE 3RD	60327	258688	
---------------------------	--------------	--------	--



- 1 TRUCK
- ★ L/LS/LT111 - LB/LBS/LBT111/111H

INJECTION PIPE 4TH	60328	258689	
---------------------------	--------------	--------	--







- 1 TRUCK
- ★ L/LS/LT111 - LB/LBS/LBT111/111H

INJECTION PIPE 5TH	60329	258690	
---------------------------	--------------	--------	--







- 1 TRUCK
- ★ L/LS/LT111 - LB/LBS/LBT111/111H





ALL THE COMPONENTS LISTED IN OUR CATALOGUE ARE NOT ORIGINAL, THOUGH PERFECTLY INTERCHANGEABLE. REFERENCE NUMBERS, EITHER ORIGINAL OR OF A DIFFERENT NATURE, ARE FOR INFORMATION PURPOSES ONLY WHEN PLACING AN ORDER, PLEASE, ALWAYS USE COSIBO REFERENCE NUMBERS AND DO NOT MENTION THE ORIGINAL REFERENCE NUMBERS OF THE TRUCK MANUFACTURERS IN THE INVOICE TO VEHICLE OWNERS OR TO ANYBODY ELSE. THE CUSTOMER TAKES HIS OWN RESPONSIBILITY IF HE DOES NOT COMPLY WITH WHAT ABOVE.

	Code	OEM new	OEM old
INJECTION PIPE 6TH 	60330	258691	
<ul style="list-style-type: none"> ● Model ★ Application 			
<ul style="list-style-type: none"> ● 1 TRUCK ★ L/LS/LT111 - LB/LBS/LBT111/111H 			
INJECTION PIPE 1ST 	60683	305286	
<ul style="list-style-type: none"> ● 2 TRUCK ★ R - T142 			
INJECTION PIPE 2ND 	60684	305287	
<ul style="list-style-type: none"> ● 2 TRUCK ★ R - T142 			
INJECTION PIPE 3RD 	60685	305288	
<ul style="list-style-type: none"> ● 2 TRUCK ★ R - T142 			
INJECTION PIPE 4TH 	60686	305289	
<ul style="list-style-type: none"> ● 2 TRUCK ★ R - T142 			





ALL THE COMPONENTS LISTED IN OUR CATALOGUE ARE NOT ORIGINAL, THOUGH PERFECTLY INTERCHANGEABLE. REFERENCE NUMBERS, EITHER ORIGINAL OR OF A DIFFERENT NATURE, ARE FOR INFORMATION PURPOSES ONLY WHEN PLACING AN ORDER, PLEASE, ALWAYS USE COSIBO REFERENCE NUMBERS AND DO NOT MENTION THE ORIGINAL REFERENCE NUMBERS OF THE TRUCK MANUFACTURERS IN THE INVOICE TO VEHICLE OWNERS OR TO ANYBODY ELSE. THE CUSTOMER TAKES HIS OWN RESPONSIBILITY IF HE DOES NOT COMPLY WITH WHAT ABOVE.

	Code	OEM new	OEM old
<p>INJECTION PIPE 5TH</p> 	60687	320813	
<ul style="list-style-type: none"> ● Model ★ Application 			
<ul style="list-style-type: none"> ● 2 TRUCK ★ R - T142 			
<p>INJECTION PIPE 6TH</p> 	60688	320814	
<ul style="list-style-type: none"> ● 2 TRUCK ★ R - T142 			
<p>INJECTION PIPE 7TH</p> 	60689	348293	
<ul style="list-style-type: none"> ● 2 TRUCK ★ R - T142 			
<p>INJECTION PIPE 8TH</p> 	60690	348294	
<ul style="list-style-type: none"> ● 2 TRUCK ★ R - T142 			
<p>INJECTION PIPE 1ST</p> 	60692	263911	
<ul style="list-style-type: none"> ● 2 TRUCK ★ T142 ● 1 TRUCK ★ LB/LBS/LBT141 			





ALL THE COMPONENTS LISTED IN OUR CATALOGUE ARE NOT ORIGINAL, THOUGH PERFECTLY INTERCHANGEABLE. REFERENCE NUMBERS, EITHER ORIGINAL OR OF A DIFFERENT NATURE, ARE FOR INFORMATION PURPOSES ONLY WHEN PLACING AN ORDER, PLEASE, ALWAYS USE COSIBO REFERENCE NUMBERS AND DO NOT MENTION THE ORIGINAL REFERENCE NUMBERS OF THE TRUCK MANUFACTURERS IN THE INVOICE TO VEHICLE OWNERS OR TO ANYBODY ELSE. THE CUSTOMER TAKES HIS OWN RESPONSIBILITY IF HE DOES NOT COMPLY WITH WHAT ABOVE.

	Code	OEM new	OEM old
INJECTION PIPE 2ND 	60693	263912	
<ul style="list-style-type: none"> ● Model ★ Application 			
<ul style="list-style-type: none"> ● 2 TRUCK ★ T142 			
<ul style="list-style-type: none"> ● 1 TRUCK ★ LB/LBS/LBT141 			
INJECTION PIPE 3RD 	60694	271147	
<ul style="list-style-type: none"> ● 2 TRUCK ★ T142 			
<ul style="list-style-type: none"> ● 1 TRUCK ★ LB/LBS/LBT141 			
INJECTION PIPE 4TH 	60695	271148	
<ul style="list-style-type: none"> ● 2 TRUCK ★ T142 			
<ul style="list-style-type: none"> ● 1 TRUCK ★ LB/LBS/LBT141 			
INJECTION PIPE 5TH 	60696	308385	263915
<ul style="list-style-type: none"> ● 2 TRUCK ★ T142 			
<ul style="list-style-type: none"> ● 1 TRUCK ★ LB/LBS/LBT141 			
INJECTION PIPE 6TH 	60697	308386	263916
<ul style="list-style-type: none"> ● 2 TRUCK ★ T142 			
<ul style="list-style-type: none"> ● 1 TRUCK ★ LB/LBS/LBT141 			

ALL THE COMPONENTS LISTED IN OUR CATALOGUE ARE NOT ORIGINAL, THOUGH PERFECTLY INTERCHANGEABLE. REFERENCE NUMBERS, EITHER ORIGINAL OR OF A DIFFERENT NATURE, ARE FOR INFORMATION PURPOSES ONLY WHEN PLACING AN ORDER, PLEASE, ALWAYS USE COSIBO REFERENCE NUMBERS AND DO NOT MENTION THE ORIGINAL REFERENCE NUMBERS OF THE TRUCK MANUFACTURERS IN THE INVOICE TO VEHICLE OWNERS OR TO ANYBODY ELSE. THE CUSTOMER TAKES HIS OWN RESPONSIBILITY IF HE DOES NOT COMPLY WITH WHAT ABOVE.

	Code	OEM new	OEM old
INJECTION PIPE 7TH	60698	263917	
	<ul style="list-style-type: none"> ● Model ★ Application 		
	<ul style="list-style-type: none"> ● 2 TRUCK ★ T142 		
	<ul style="list-style-type: none"> ● 1 TRUCK ★ LB/LBS/LBT141 		
INJECTION PIPE 8TH	60699	263918	
	<ul style="list-style-type: none"> ● 2 TRUCK ★ T142 		
	<ul style="list-style-type: none"> ● 1 TRUCK ★ LB/LBS/LBT141 		
INJECTION PIPE 1ST	60712	322693	
	<ul style="list-style-type: none"> ● 3 TRUCK ★ DN11 01 ENG 5307928 - ENG 4070104 		
	<ul style="list-style-type: none"> ● 2 TRUCK ★ G/P/R/T112 		
INJECTION PIPE 2ND	60713	322694	
	<ul style="list-style-type: none"> ● 3 TRUCK ★ DN11 01 ENG 5307928 - ENG 4070104 		
	<ul style="list-style-type: none"> ● 2 TRUCK ★ G/P/R/T112 		
INJECTION PIPE 3RD	60714	322695	
	<ul style="list-style-type: none"> ● 3 TRUCK ★ DN11 01 ENG 5307928 - ENG 4070104 		
	<ul style="list-style-type: none"> ● 2 TRUCK ★ G/P/R/T112 		

ALL THE COMPONENTS LISTED IN OUR CATALOGUE ARE NOT ORIGINAL, THOUGH PERFECTLY INTERCHANGEABLE. REFERENCE NUMBERS, EITHER ORIGINAL OR OF A DIFFERENT NATURE, ARE FOR INFORMATION PURPOSES ONLY WHEN PLACING AN ORDER, PLEASE, ALWAYS USE COSIBO REFERENCE NUMBERS AND DO NOT MENTION THE ORIGINAL REFERENCE NUMBERS OF THE TRUCK MANUFACTURERS IN THE INVOICE TO VEHICLE OWNERS OR TO ANYBODY ELSE. THE CUSTOMER TAKES HIS OWN RESPONSIBILITY IF HE DOES NOT COMPLY WITH WHAT ABOVE.

	Code	OEM new	OEM old
INJECTION PIPE 4TH	60715	322697	
	<ul style="list-style-type: none"> ● Model ★ Application 		
	<ul style="list-style-type: none"> ● 3 TRUCK ★ DN11 01 ENG 5307928 - ENG 4070104 		
	<ul style="list-style-type: none"> ● 2 TRUCK ★ G/P/R/T112 		
INJECTION PIPE 5TH	60716	322698	
	<ul style="list-style-type: none"> ● 3 TRUCK ★ DN11 01 ENG 5307928 - ENG 4070104 		
	<ul style="list-style-type: none"> ● 2 TRUCK ★ G/P/R/T112 		
INJECTION PIPE 6TH	60717	322699	
	<ul style="list-style-type: none"> ● 3 TRUCK ★ DN11 01 ENG 5307928 - ENG 4070104 		
	<ul style="list-style-type: none"> ● 2 TRUCK ★ G/P/R/T112 		
INJECTION PIPE 1ST	60706	312217	
	<ul style="list-style-type: none"> ● 3 TRUCK ★ DS11 73 - DS11 73 ENG 5307928 - ENG 4070104 		
	<ul style="list-style-type: none"> ● 2 TRUCK ★ G/P/R/T112 		
INJECTION PIPE 2ND	60707	312218	
	<ul style="list-style-type: none"> ● 3 TRUCK ★ DS11 73 - DS11 73 ENG 5307928 - ENG 4070104 		
	<ul style="list-style-type: none"> ● 2 TRUCK ★ G/P/R/T112 		

ALL THE COMPONENTS LISTED IN OUR CATALOGUE ARE NOT ORIGINAL, THOUGH PERFECTLY INTERCHANGEABLE. REFERENCE NUMBERS, EITHER ORIGINAL OR OF A DIFFERENT NATURE, ARE FOR INFORMATION PURPOSES ONLY WHEN PLACING AN ORDER, PLEASE, ALWAYS USE COSIBO REFERENCE NUMBERS AND DO NOT MENTION THE ORIGINAL REFERENCE NUMBERS OF THE TRUCK MANUFACTURERS IN THE INVOICE TO VEHICLE OWNERS OR TO ANYBODY ELSE. THE CUSTOMER TAKES HIS OWN RESPONSIBILITY IF HE DOES NOT COMPLY WITH WHAT ABOVE.

INJECTION PIPE 3RD



	Code	OEM new	OEM old
● Model	60708	312219	
★ Application			
● 3 TRUCK			
★ DS11 73 - DS11 73 ENG 5307928 - ENG 4070104			
● 2 TRUCK			
★ G/P/R/T112			

INJECTION PIPE 4TH



	Code	OEM new	OEM old
	60709	312221	
● 3 TRUCK			
★ DS11 73 - DS11 73 ENG 5307928 - ENG 4070104			
● 2 TRUCK			
★ G/P/R/T112			

INJECTION PIPE 5TH



	Code	OEM new	OEM old
	60710	312222	
● 3 TRUCK			
★ DS11 73 - DS11 73 ENG 5307928 - ENG 4070104			
● 2 TRUCK			
★ G/P/R/T112			

INJECTION PIPE 6TH



	Code	OEM new	OEM old
	60711	312223	
● 3 TRUCK			
★ DS11 73 - DS11 73 ENG 5307928 - ENG 4070104			
● 2 TRUCK			
★ G/P/R/T112			

ALL THE COMPONENTS LISTED IN OUR CATALOGUE ARE NOT ORIGINAL, THOUGH PERFECTLY INTERCHANGEABLE. REFERENCE NUMBERS, EITHER ORIGINAL OR OF A DIFFERENT NATURE, ARE FOR INFORMATION PURPOSES ONLY WHEN PLACING AN ORDER, PLEASE, ALWAYS USE COSIBO REFERENCE NUMBERS AND DO NOT MENTION THE ORIGINAL REFERENCE NUMBERS OF THE TRUCK MANUFACTURERS IN THE INVOICE TO VEHICLE OWNERS OR TO ANYBODY ELSE. THE CUSTOMER TAKES HIS OWN RESPONSIBILITY IF HE DOES NOT COMPLY WITH WHAT ABOVE.

INJECTION PIPE 1ST



	Code	OEM new	OEM old
● Model ★ Application	60700	369291	
● 3 TRUCK			
★ DSC11 12/13/16 ENG 5307928 - ENG 4070104			

INJECTION PIPE 2ND



	Code	OEM new	OEM old
	60701	369292	
● A.29.1 ★ DOPO 60700			
● 3 TRUCK			
★ DSC11 12/13/16 ENG 5307928 - ENG 4070104			

INJECTION PIPE 3RD







	Code	OEM new	OEM old
	60702	369293	
● 3 TRUCK			
★ DSC11 12/13/16 ENG 5307928 - ENG 4070104			

INJECTION PIPE 4TH



	Code	OEM new	OEM old
	60703	369295	
● 3 TRUCK			
★ DSC11 12/13/16 ENG 5307928 - ENG 4070104			

ALL THE COMPONENTS LISTED IN OUR CATALOGUE ARE NOT ORIGINAL, THOUGH PERFECTLY INTERCHANGEABLE. REFERENCE NUMBERS, EITHER ORIGINAL OR OF A DIFFERENT NATURE, ARE FOR INFORMATION PURPOSES ONLY WHEN PLACING AN ORDER, PLEASE, ALWAYS USE COSIBO REFERENCE NUMBERS AND DO NOT MENTION THE ORIGINAL REFERENCE NUMBERS OF THE TRUCK MANUFACTURERS IN THE INVOICE TO VEHICLE OWNERS OR TO ANYBODY ELSE. THE CUSTOMER TAKES HIS OWN RESPONSIBILITY IF HE DOES NOT COMPLY WITH WHAT ABOVE.

	Code	OEM new	OEM old
INJECTION PIPE 5TH 	60704	369296	
<ul style="list-style-type: none"> ● Model ★ Application 			
<ul style="list-style-type: none"> ● 3 TRUCK 			
<ul style="list-style-type: none"> ★ DSC11 12/13/16 ENG 5307928 - ENG 4070104 			
INJECTION PIPE 6TH 	60705	369297	
<ul style="list-style-type: none"> ● 3 TRUCK 			
<ul style="list-style-type: none"> ★ DSC11 12/13/16 ENG 5307928 - ENG 4070104 			
INJECTION PIPE 1ST 	60677	365485	
<ul style="list-style-type: none"> ● 3 TRUCK 			
<ul style="list-style-type: none"> ★ DS11 34 ENG 5307929 - 5335712 - ENG 4070105 - 4092818 - DS11 75 ENG 5331613 - ENG 4090481 - DSC11 18 ENG 5307929 - 5329484 - ENG 4070105 - 4089032 - ENG 5314171 - 5329484 - ENG 5314171 - DSC11 17 ENG 5307929 - 5329484 - ENG 4070105 - 4089033 - DSC11 30 ENG 5320489 - 5331740 - ENG 4082306 - 4090198 - ENG 5310453 - 5331740 - ENG 4072204 - 4090198 - DSC11 08 ENG 5308341 - 5342128 - ENG 4088739 - DSC11 08/10 L03 ENG 5322490 - ENG 4011502 - DSC11 10 ENG 5308341 - 5342127 - ENG 4088739 			
<ul style="list-style-type: none"> ● 3 BUS 			
<ul style="list-style-type: none"> ★ DS11 34B/C - DSC11 74C - DS11 74C/B - DS11 77C ENG 5326645 - DSC11 04 ENG 5327909 - DSC11 08/18B - DSC11 08C ENG 5335712 - DS11 E01 ENG 5331740 - ENG 5332619 			
INJECTION PIPE 2ND 	60678	365486	
<ul style="list-style-type: none"> ● 3 TRUCK 			
<ul style="list-style-type: none"> ★ DS11 34 ENG 5307929 - 5335712 - ENG 4070105 - 4092818 - DS11 75 ENG 5331613 - ENG 4090481 - DSC11 18 ENG 5307929 - 5329484 - ENG 4070105 - 4089032 - ENG 5314171 - 5329484 - ENG 5314171 - DSC11 17 ENG 5307929 - 5329484 - ENG 4070105 - 4089033 - DSC11 30 ENG 5320489 - 5331740 - ENG 4082306 - 4090198 - ENG 5310453 - 5331740 - ENG 4072204 - 4090198 - DSC11 08 ENG 5308341 - 5342128 - ENG 4088739 - DSC11 08/10 L03 ENG 5322490 - ENG 4011502 - DSC11 10 ENG 5308341 - 5342127 - ENG 4088739 			
<ul style="list-style-type: none"> ● 3 BUS 			
<ul style="list-style-type: none"> ★ DS11 34B/C - DSC11 74C - DS11 74C/B - DS11 77C ENG 5326645 - DSC11 04 ENG 5327909 - DSC11 08/18B - DSC11 08C ENG 5335712 - DS11 E01 ENG 5331740 - ENG 5332619 			

ALL THE COMPONENTS LISTED IN OUR CATALOGUE ARE NOT ORIGINAL, THOUGH PERFECTLY INTERCHANGEABLE. REFERENCE NUMBERS, EITHER ORIGINAL OR OF A DIFFERENT NATURE, ARE FOR INFORMATION PURPOSES ONLY WHEN PLACING AN ORDER, PLEASE, ALWAYS USE COSIBO REFERENCE NUMBERS AND DO NOT MENTION THE ORIGINAL REFERENCE NUMBERS OF THE TRUCK MANUFACTURERS IN THE INVOICE TO VEHICLE OWNERS OR TO ANYBODY ELSE. THE CUSTOMER TAKES HIS OWN RESPONSIBILITY IF HE DOES NOT COMPLY WITH WHAT ABOVE.

INJECTION PIPE 3RD



	Code	OEM new	OEM old
● Model	60679	365487	
★ Application			
● 3 TRUCK			
★	DS11 34 ENG 5307929 - 5335712 - ENG 4070105 - 4092818 - DS11 75 ENG 5331613 - ENG 4090481 - DSC11 18 ENG 5307929 - 5329484 - ENG 4070105 - 4089032 - ENG 5314171 - 5329484 - ENG 5314171 - DSC11 17 ENG 5307929 - 5329484 - ENG 4070105 - 4089033 - DSC11 30 ENG 5320489 - 5331740 - ENG 4082306 - 4090198 - ENG 5310453 - 5331740 - ENG 4072204 - 4090198 - DSC11 08 ENG 5308341 - 5342128 - ENG 4088739 - DSC11 08/10 L03 ENG 5322490 - ENG 4011502 - DSC11 10 ENG 5308341 - 5342127 - ENG 4088739		
● 3 BUS			
★	DS11 34B/C - DSC11 74C - DS11 74C/B - DS11 77C ENG 5326645 - DSC11 04 ENG 5327909 - DSC11 08/18B - DSC11 08C ENG 5335712 - DS11 E01 ENG 5331740 - ENG 5332619		

INJECTION PIPE 4TH



	Code	OEM new	OEM old
	60680	365489	
● 3 TRUCK			
★	DS11 34 ENG 5307929 - 5335712 - ENG 4070105 - 4092818 - DS11 75 ENG 5331613 - ENG 4090481 - DSC11 18 ENG 5307929 - 5329484 - ENG 4070105 - 4089032 - ENG 5314171 - 5329484 - ENG 5314171 - DSC11 17 ENG 5307929 - 5329484 - ENG 4070105 - 4089033 - DSC11 30 ENG 5320489 - 5331740 - ENG 4082306 - 4090198 - ENG 5310453 - 5331740 - ENG 4072204 - 4090198 - DSC11 08 ENG 5308341 - 5342128 - ENG 4088739 - DSC11 08/10 L03 ENG 5322490 - ENG 4011502 - DSC11 10 ENG 5308341 - 5342127 - ENG 4088739		
● 3 BUS			
★	DS11 34B/C - DSC11 74C - DS11 74C/B - DS11 77C ENG 5326645 - DSC11 04 ENG 5327909 - DSC11 08/18B - DSC11 08C ENG 5335712 - DS11 E01 ENG 5331740 - ENG 5332619		

INJECTION PIPE 5TH



	Code	OEM new	OEM old
	60681	365490	
● 3 TRUCK			
★	DS11 34 ENG 5307929 - 5335712 - ENG 4070105 - 4092818 - DS11 75 ENG 5331613 - ENG 4090481 - DSC11 18 ENG 5307929 - 5329484 - ENG 4070105 - 4089032 - ENG 5314171 - 5329484 - ENG 5314171 - DSC11 17 ENG 5307929 - 5329484 - ENG 4070105 - 4089033 - DSC11 30 ENG 5320489 - 5331740 - ENG 4082306 - 4090198 - ENG 5310453 - 5331740 - ENG 4072204 - 4090198 - DSC11 08 ENG 5308341 - 5342128 - ENG 4088739 - DSC11 08/10 L03 ENG 5322490 - ENG 4011502 - DSC11 10 ENG 5308341 - 5342127 - ENG 4088739		
● 3 BUS			
★	DS11 34B/C - DSC11 74C - DS11 74C/B - DS11 77C ENG 5326645 - DSC11 04 ENG 5327909 - DSC11 08/18B - DSC11 08C ENG 5335712 - DS11 E01 ENG 5331740 - ENG 5332619		

ALL THE COMPONENTS LISTED IN OUR CATALOGUE ARE NOT ORIGINAL, THOUGH PERFECTLY INTERCHANGEABLE. REFERENCE NUMBERS, EITHER ORIGINAL OR OF A DIFFERENT NATURE, ARE FOR INFORMATION PURPOSES ONLY WHEN PLACING AN ORDER, PLEASE, ALWAYS USE COSIBO REFERENCE NUMBERS AND DO NOT MENTION THE ORIGINAL REFERENCE NUMBERS OF THE TRUCK MANUFACTURERS IN THE INVOICE TO VEHICLE OWNERS OR TO ANYBODY ELSE. THE CUSTOMER TAKES HIS OWN RESPONSIBILITY IF HE DOES NOT COMPLY WITH WHAT ABOVE.

INJECTION PIPE 6TH



	Code	OEM new	OEM old
● Model	60682	365491	
★ Application			
● 3 TRUCK			
★	DS11 34 ENG 5307929 - 5335712 - ENG 4070105 - 4092818 - DS11 75 ENG 5331613 - ENG 4090481 - DSC11 18 ENG 5307929 - 5329484 - ENG 4070105 - 4089032 - ENG 5314171 - 5329484 - ENG 5314171 - DSC11 17 ENG 5307929 - 5329484 - ENG 4070105 - 4089033 - DSC11 30 ENG 5320489 - 5331740 - ENG 4082306 - 4090198 - ENG 5310453 - 5331740 - ENG 4072204 - 4090198 - DSC11 08 ENG 5308341 - 5342128 - ENG 4088739 - DSC11 08/10 L03 ENG 5322490 - ENG 4011502 - DSC11 10 ENG 5308341 - 5342127 - ENG 4088739		
● 4 BUS			
★	DS11 34B/C - DSC11 74C - DS11 74C/B - DS11 77C ENG 5326645 - DSC11 04 ENG 5327909 - DSC11 08/18B - DSC11 08C ENG 5335712 - DS11 E01 ENG 5331740 - ENG 5332619		

INJECTION PIPE 1ST



	60657	1105079	351301
● 3 TRUCK			
★	DS9 05 - DSC9 02 ENG 5108502 - ENG 4012891 - DSC9 07/08 ENG 5105298 - ENG 4306729 - DSC9 09 ENG 5110567 - ENG 4014926		
● 3 BUS			
★	DS9 05B - DSC9 08B ENG 5111501		

INJECTION PIPE 2ND



	60658	1105080	351302
● 3 TRUCK			
★	DS9 05 - DSC9 02 ENG 5108502 - ENG 4012891 - DSC9 07/08 ENG 5105298 - ENG 4306729 - DSC9 09 ENG 5110567 - ENG 4014926		
● 3 BUS			
★	DS9 05B - DSC9 08B ENG 5111501		

ALL THE COMPONENTS LISTED IN OUR CATALOGUE ARE NOT ORIGINAL, THOUGH PERFECTLY INTERCHANGEABLE. REFERENCE NUMBERS, EITHER ORIGINAL OR OF A DIFFERENT NATURE, ARE FOR INFORMATION PURPOSES ONLY WHEN PLACING AN ORDER, PLEASE, ALWAYS USE COSIBO REFERENCE NUMBERS AND DO NOT MENTION THE ORIGINAL REFERENCE NUMBERS OF THE TRUCK MANUFACTURERS IN THE INVOICE TO VEHICLE OWNERS OR TO ANYBODY ELSE. THE CUSTOMER TAKES HIS OWN RESPONSIBILITY IF HE DOES NOT COMPLY WITH WHAT ABOVE.

INJECTION PIPE 3RD



	Code	OEM new	OEM old
● Model ★ Application	60659	1105081	351303
● 3 TRUCK			
★ DS9 05 - DSC9 02 ENG 5108502 - ENG 4012891 - DSC9 07/08 ENG 5105298 - ENG 4306729 - DSC9 09 ENG 5110567 - ENG 4014926			
● 3 BUS			
★ DS9 05B - DSC9 08B ENG 5111501			

INJECTION PIPE 4TH



	Code	OEM new	OEM old
	60660	1105082	351305
● 3 TRUCK			
★ DS9 05 - DSC9 02 ENG 5108502 - ENG 4012891 - DSC9 07/08 ENG 5105298 - ENG 4306729 - DSC9 09 ENG 5110567 - ENG 4014926			
● 3 BUS			
★ DS9 05B - DSC9 08B ENG 5111501			

INJECTION PIPE 5TH



	Code	OEM new	OEM old
	60661	1105083	351306
● 3 TRUCK			
★ DS9 05 - DSC9 02 ENG 5108502 - ENG 4012891 - DSC9 07/08 ENG 5105298 - ENG 4306729 - DSC9 09 ENG 5110567 - ENG 4014926			
● 3 BUS			
★ DS9 05B - DSC9 08B ENG 5111501			

INJECTION PIPE 6TH



	Code	OEM new	OEM old
	60662	1105084	351307
● 3 TRUCK			
★ DS9 05 - DSC9 02 ENG 5108502 - ENG 4012891 - DSC9 07/08 ENG 5105298 - ENG 4306729 - DSC9 09 ENG 5110567 - ENG 4014926			
● 3 BUS			
★ DS9 05B - DSC9 08B ENG 5111501			

ALL THE COMPONENTS LISTED IN OUR CATALOGUE ARE NOT ORIGINAL, THOUGH PERFECTLY INTERCHANGEABLE. REFERENCE NUMBERS, EITHER ORIGINAL OR OF A DIFFERENT NATURE, ARE FOR INFORMATION PURPOSES ONLY WHEN PLACING AN ORDER, PLEASE, ALWAYS USE COSIBO REFERENCE NUMBERS AND DO NOT MENTION THE ORIGINAL REFERENCE NUMBERS OF THE TRUCK MANUFACTURERS IN THE INVOICE TO VEHICLE OWNERS OR TO ANYBODY ELSE. THE CUSTOMER TAKES HIS OWN RESPONSIBILITY IF HE DOES NOT COMPLY WITH WHAT ABOVE.

	Code	OEM new	OEM old
INJECTION PIPE 1ST	60663	1105073	351309
<ul style="list-style-type: none"> ● Model ★ Application 			
<ul style="list-style-type: none"> ● 3 TRUCK 			
<ul style="list-style-type: none"> ★ DN9 01 ENG 5108502 - ENG 4012891 - DS9 06 ENG 5108502 - ENG 4012891 - DS9 08 - DSC9 10 ENG 5105298 - ENG 4306729 			
<ul style="list-style-type: none"> ● 3 BUS 			
<ul style="list-style-type: none"> ★ DS9 08B 			



INJECTION PIPE 2ND	60664	1105074	351310
<ul style="list-style-type: none"> ● 3 TRUCK 			
<ul style="list-style-type: none"> ★ DN9 01 ENG 5108502 - ENG 4012891 - DS9 06 ENG 5108502 - ENG 4012891 - DS9 08 - DSC9 10 ENG 5105298 - ENG 4306729 			
<ul style="list-style-type: none"> ● 3 BUS 			
<ul style="list-style-type: none"> ★ DS9 08B 			







INJECTION PIPE 3RD	60665	1105075	351311
<ul style="list-style-type: none"> ● 3 TRUCK 			
<ul style="list-style-type: none"> ★ DN9 01 ENG 5108502 - ENG 4012891 - DS9 06 ENG 5108502 - ENG 4012891 - DS9 08 - DSC9 10 ENG 5105298 - ENG 4306729 			
<ul style="list-style-type: none"> ● 3 BUS 			
<ul style="list-style-type: none"> ★ DS9 08B 			







INJECTION PIPE 4TH	60666	1105076	351313
<ul style="list-style-type: none"> ● 3 TRUCK 			
<ul style="list-style-type: none"> ★ DN9 01 ENG 5108502 - ENG 4012891 - DS9 06 ENG 5108502 - ENG 4012891 - DS9 08 - DSC9 10 ENG 5105298 - ENG 4306729 			
<ul style="list-style-type: none"> ● 3 BUS 			
<ul style="list-style-type: none"> ★ DS9 08B 			







ALL THE COMPONENTS LISTED IN OUR CATALOGUE ARE NOT ORIGINAL, THOUGH PERFECTLY INTERCHANGEABLE. REFERENCE NUMBERS, EITHER ORIGINAL OR OF A DIFFERENT NATURE, ARE FOR INFORMATION PURPOSES ONLY WHEN PLACING AN ORDER, PLEASE, ALWAYS USE COSIBO REFERENCE NUMBERS AND DO NOT MENTION THE ORIGINAL REFERENCE NUMBERS OF THE TRUCK MANUFACTURERS IN THE INVOICE TO VEHICLE OWNERS OR TO ANYBODY ELSE. THE CUSTOMER TAKES HIS OWN RESPONSIBILITY IF HE DOES NOT COMPLY WITH WHAT ABOVE.

	Code	OEM new	OEM old
INJECTION PIPE 5TH 	60667	1105077	351314
<ul style="list-style-type: none"> ● Model ★ Application 			
<ul style="list-style-type: none"> ● 3 TRUCK ★ DN9 01 ENG 5108502 - ENG 4012891 - DS9 06 ENG 5108502 - ENG 4012891 - DS9 08 - DSC9 10 ENG 5105298 - ENG 4306729 			
<ul style="list-style-type: none"> ● 3 BUS ★ DS9 08B 			
INJECTION PIPE 6TH 	60668	1105078	351315
<ul style="list-style-type: none"> ● 3 TRUCK ★ DN9 01 ENG 5108502 - ENG 4012891 - DS9 06 ENG 5108502 - ENG 4012891 - DS9 08 - DSC9 10 ENG 5105298 - ENG 4306729 			
<ul style="list-style-type: none"> ● 3 BUS ★ DS9 08B 			
INJECTION PIPE 1ST 	60669	381918	
<ul style="list-style-type: none"> ● 3 TRUCK ★ DSC14 03 ENG 5550629 - ENG 4190967 - GRH880 - DSC14 06 ENG 5550629 - ENG 4191153 - DSC14 04 (EDC) - 			
INJECTION PIPE 2ND 	60670	381919	
<ul style="list-style-type: none"> ● 3 TRUCK ★ DSC14 03 ENG 5550629 - ENG 4190967 - GRH880 - DSC14 06 ENG 5550629 - ENG 4191153 - DSC14 04 (EDC) - 			
INJECTION PIPE 3RD 	60671	381920	
<ul style="list-style-type: none"> ● 3 TRUCK ★ DSC14 03 ENG 5550629 - ENG 4190967 - GRH880 - DSC14 06 ENG 5550629 - ENG 4191153 - DSC14 04 (EDC) - 			

ALL THE COMPONENTS LISTED IN OUR CATALOGUE ARE NOT ORIGINAL, THOUGH PERFECTLY INTERCHANGEABLE. REFERENCE NUMBERS, EITHER ORIGINAL OR OF A DIFFERENT NATURE, ARE FOR INFORMATION PURPOSES ONLY WHEN PLACING AN ORDER, PLEASE, ALWAYS USE COSIBO REFERENCE NUMBERS AND DO NOT MENTION THE ORIGINAL REFERENCE NUMBERS OF THE TRUCK MANUFACTURERS IN THE INVOICE TO VEHICLE OWNERS OR TO ANYBODY ELSE. THE CUSTOMER TAKES HIS OWN RESPONSIBILITY IF HE DOES NOT COMPLY WITH WHAT ABOVE.

	Code	OEM new	OEM old
<p>INJECTION PIPE 4TH</p> 	60672	381921	
<ul style="list-style-type: none"> ● Model ★ Application 			
<ul style="list-style-type: none"> ● 3 TRUCK ★ DSC14 03 ENG 5550629 - ENG 4190967 - GRH880 - DSC14 06 ENG 5550629 - ENG 4191153 - DSC14 04 (EDC) - 			
<p>INJECTION PIPE 5TH</p> 	60673	381922	
<ul style="list-style-type: none"> ● 3 TRUCK ★ DSC14 03 ENG 5550629 - ENG 4190967 - GRH880 - DSC14 06 ENG 5550629 - ENG 4191153 - DSC14 04 (EDC) - 			
<p>INJECTION PIPE 6TH</p> 	60674	381923	
<ul style="list-style-type: none"> ● 3 TRUCK ★ DSC14 03 ENG 5550629 - ENG 4190967 - GRH880 - DSC14 06 ENG 5550629 - ENG 4191153 - DSC14 04 (EDC) - 			
<p>INJECTION PIPE 7TH</p> 	60675	381924	
<ul style="list-style-type: none"> ● 3 TRUCK ★ DSC14 03 ENG 5550629 - ENG 4190967 - GRH880 - DSC14 06 ENG 5550629 - ENG 4191153 - DSC14 04 (EDC) - 			
<p>INJECTION PIPE 8TH</p> 	60676	381925	
<ul style="list-style-type: none"> ● 3 TRUCK ★ DSC14 03 ENG 5550629 - ENG 4190967 - GRH880 - DSC14 06 ENG 5550629 - ENG 4191153 - DSC14 04 (EDC) - 			

ALL THE COMPONENTS LISTED IN OUR CATALOGUE ARE NOT ORIGINAL, THOUGH PERFECTLY INTERCHANGEABLE. REFERENCE NUMBERS, EITHER ORIGINAL OR OF A DIFFERENT NATURE, ARE FOR INFORMATION PURPOSES ONLY WHEN PLACING AN ORDER, PLEASE, ALWAYS USE COSIBO REFERENCE NUMBERS AND DO NOT MENTION THE ORIGINAL REFERENCE NUMBERS OF THE TRUCK MANUFACTURERS IN THE INVOICE TO VEHICLE OWNERS OR TO ANYBODY ELSE. THE CUSTOMER TAKES HIS OWN RESPONSIBILITY IF HE DOES NOT COMPLY WITH WHAT ABOVE.

	Code	OEM new	OEM old
INJECTION PIPE 1ST 	61746	1303951	
<ul style="list-style-type: none"> ● Model ★ Application 			
<ul style="list-style-type: none"> ● 3 TRUCK ★ DSC14 09 (EDC) ENG 5547245 - ENG 4186607 - DSC14 08/10 - DSC14 16 (EDC) - 			
<ul style="list-style-type: none"> ● IND. MARINE ENGINE 4 ★ DS/DSC14 A 			
INJECTION PIPE 2ND 	61747	1303952	
<ul style="list-style-type: none"> ● 3 TRUCK ★ DSC14 09 (EDC) ENG 5547245 - ENG 4186607 - DSC14 08/10 - DSC14 16 (EDC) - 			
<ul style="list-style-type: none"> ● IND. MARINE ENGINE 4 ★ DS/DSC14 A 			
INJECTION PIPE 3RD 	61748	1303953	
<ul style="list-style-type: none"> ● 3 TRUCK ★ DSC14 09 (EDC) ENG 5547245 - ENG 4186607 - DSC14 08/10 - DSC14 16 (EDC) - 			
<ul style="list-style-type: none"> ● IND. MARINE ENGINE 4 ★ DS/DSC14 A 			
INJECTION PIPE 4TH 	61749	1303954	
<ul style="list-style-type: none"> ● 3 TRUCK ★ DSC14 09 (EDC) ENG 5547245 - ENG 4186607 - DSC14 08/10 - DSC14 16 (EDC) - 			
<ul style="list-style-type: none"> ● IND. MARINE ENGINE 4 ★ DS/DSC14 A 			
INJECTION PIPE 5TH 	61750	1303955	
<ul style="list-style-type: none"> ● 3 TRUCK ★ DSC14 09 (EDC) ENG 5547245 - ENG 4186607 - DSC14 08/10 - DSC14 16 (EDC) - 			
<ul style="list-style-type: none"> ● IND. MARINE ENGINE 4 ★ DS/DSC14 A 			

ALL THE COMPONENTS LISTED IN OUR CATALOGUE ARE NOT ORIGINAL, THOUGH PERFECTLY INTERCHANGEABLE. REFERENCE NUMBERS, EITHER ORIGINAL OR OF A DIFFERENT NATURE, ARE FOR INFORMATION PURPOSES ONLY WHEN PLACING AN ORDER, PLEASE, ALWAYS USE COSIBO REFERENCE NUMBERS AND DO NOT MENTION THE ORIGINAL REFERENCE NUMBERS OF THE TRUCK MANUFACTURERS IN THE INVOICE TO VEHICLE OWNERS OR TO ANYBODY ELSE. THE CUSTOMER TAKES HIS OWN RESPONSIBILITY IF HE DOES NOT COMPLY WITH WHAT ABOVE.

	Code	OEM new	OEM old
INJECTION PIPE 6TH	61751	1303956	
<ul style="list-style-type: none"> ● Model ★ Application 			
<ul style="list-style-type: none"> ● 3 TRUCK ★ DSC14 09 (EDC) ENG 5547245 - ENG 4186607 - DSC14 08/10 - DSC14 16 (EDC) - 			
<ul style="list-style-type: none"> ● IND. MARINE ENGINE 4 ★ DS/DSC14 A 			



	Code	OEM new	OEM old
INJECTION PIPE 7TH	61752	1303957	
<ul style="list-style-type: none"> ● 3 TRUCK ★ DSC14 09 (EDC) ENG 5547245 - ENG 4186607 - DSC14 08/10 - DSC14 16 (EDC) - 			
<ul style="list-style-type: none"> ● IND. MARINE ENGINE 4 ★ DS/DSC14 A 			



	Code	OEM new	OEM old
INJECTION PIPE 8TH	61753	1303958	
<ul style="list-style-type: none"> ● 3 TRUCK ★ DSC14 09 (EDC) ENG 5547245 - ENG 4186607 - DSC14 08/10 - DSC14 16 (EDC) - 			
<ul style="list-style-type: none"> ● IND. MARINE ENGINE 4 ★ DS/DSC14 A 			



	Code	OEM new	OEM old
INJECTION PIPE SET (FROM 1ST TO 4TH)	63676	1341702	
<ul style="list-style-type: none"> ● 3 TRUCK ★ DSC14 09 (EDC) ENG 5547245 - ENG 4186607 - DSC14 08/10 - DSC14 16 (EDC) - 			
<ul style="list-style-type: none"> ● IND. MARINE ENGINE 4 ★ DS/DSC14 A 			



ALL THE COMPONENTS LISTED IN OUR CATALOGUE ARE NOT ORIGINAL, THOUGH PERFECTLY INTERCHANGEABLE. REFERENCE NUMBERS, EITHER ORIGINAL OR OF A DIFFERENT NATURE, ARE FOR INFORMATION PURPOSES ONLY WHEN PLACING AN ORDER, PLEASE, ALWAYS USE COSIBO REFERENCE NUMBERS AND DO NOT MENTION THE ORIGINAL REFERENCE NUMBERS OF THE TRUCK MANUFACTURERS IN THE INVOICE TO VEHICLE OWNERS OR TO ANYBODY ELSE. THE CUSTOMER TAKES HIS OWN RESPONSIBILITY IF HE DOES NOT COMPLY WITH WHAT ABOVE.

	Code	OEM new	OEM old
INJECTION PIPE SET (FROM 5TH TO 8TH)	63675	1341701	
● Model			
★ Application			
● 3 TRUCK			
★ DSC14 09 (EDC) ENG 5547245 - ENG 4186607 - DSC14 08/10 - DSC14 16 (EDC) -			
● IND. MARINE ENGINE 4			
★ DS/DSC14 A			

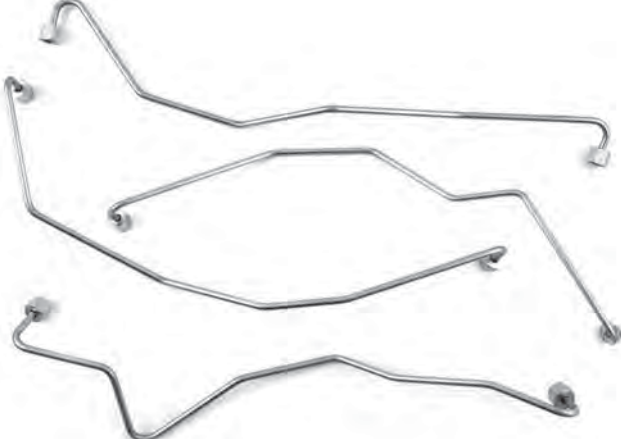

	63954	1382072	1313678
INJECTION PIPE 1ST			
● 3 TRUCK			
★ DS11 75 ENG 5352582 - ENG 4103049 - DSC11 21 ENG 4103049			
● 3 BUS			
★ DSC11 21B/21C/71B/71C ENG 5352582 - ENG 4103049 - DS11 75B/77B/77C/78B/78C ENG 5352582 - ENG 4103049 - DSC11 24B/24C/27C (EDC) ENG 5352582 - ENG 4103049 -			



	63955	1382073	1313679
INJECTION PIPE 2ND			
● 3 TRUCK			
★ DS11 75 ENG 5352582 - ENG 4103049 - DSC11 21 ENG 4103049			
● 3 BUS			
★ DSC11 21B/21C/71B/71C ENG 5352582 - ENG 4103049 - DS11 75B/77B/77C/78B/78C ENG 5352582 - ENG 4103049 - DSC11 24B/24C/27C (EDC) ENG 5352582 - ENG 4103049 -			



ALL THE COMPONENTS LISTED IN OUR CATALOGUE ARE NOT ORIGINAL, THOUGH PERFECTLY INTERCHANGEABLE. REFERENCE NUMBERS, EITHER ORIGINAL OR OF A DIFFERENT NATURE, ARE FOR INFORMATION PURPOSES ONLY WHEN PLACING AN ORDER, PLEASE, ALWAYS USE COSIBO REFERENCE NUMBERS AND DO NOT MENTION THE ORIGINAL REFERENCE NUMBERS OF THE TRUCK MANUFACTURERS IN THE INVOICE TO VEHICLE OWNERS OR TO ANYBODY ELSE. THE CUSTOMER TAKES HIS OWN RESPONSIBILITY IF HE DOES NOT COMPLY WITH WHAT ABOVE.

INJECTION PIPE 3RD



	Code	OEM new	OEM old
● Model	63956	1382074	1313680
★ Application			

● 3 TRUCK			
★ DS11 75 ENG 5352582 - ENG 4103049 - DSC11 21 ENG 4103049			
● 3 BUS			
★ DSC11 21B/21C/71B/71C ENG 5352582 - ENG 4103049 - DS11 75B/77B/77C/78B/78C ENG 5352582 - ENG 4103049 - DSC11 24B/24C/27C (EDC) ENG 5352582 - ENG 4103049 -			

INJECTION PIPE 4TH



	Code	OEM new	OEM old
	63957	1313681	

● 3 TRUCK			
★ DS11 75 ENG 5352582 - ENG 4103049 - DSC11 21 ENG 4103049			
● 3 BUS			
★ DSC11 21B/21C/71B/71C ENG 5352582 - ENG 4103049 - DS11 75B/77B/77C/78B/78C ENG 5352582 - ENG 4103049 - DSC11 24B/24C/27C (EDC) ENG 5352582 - ENG 4103049 -			

INJECTION PIPE 5TH



	Code	OEM new	OEM old
	63958	1313682	

● 3 TRUCK			
★ DS11 75 ENG 5352582 - ENG 4103049 - DSC11 21 ENG 4103049			
● 3 BUS			
★ DSC11 21B/21C/71B/71C ENG 5352582 - ENG 4103049 - DS11 75B/77B/77C/78B/78C ENG 5352582 - ENG 4103049 - DSC11 24B/24C/27C (EDC) ENG 5352582 - ENG 4103049 -			

INJECTION PIPE 6TH



	Code	OEM new	OEM old
	63959	1313683	

● 3 TRUCK			
★ DS11 75 ENG 5352582 - ENG 4103049 - DSC11 21 ENG 4103049			
● 3 BUS			
★ DSC11 21B/21C/71B/71C ENG 5352582 - ENG 4103049 - DS11 75B/77B/77C/78B/78C ENG 5352582 - ENG 4103049 - DSC11 24B/24C/27C (EDC) ENG 5352582 - ENG 4103049 -			

ALL THE COMPONENTS LISTED IN OUR CATALOGUE ARE NOT ORIGINAL, THOUGH PERFECTLY INTERCHANGEABLE. REFERENCE NUMBERS, EITHER ORIGINAL OR OF A DIFFERENT NATURE, ARE FOR INFORMATION PURPOSES ONLY WHEN PLACING AN ORDER, PLEASE, ALWAYS USE COSIBO REFERENCE NUMBERS AND DO NOT MENTION THE ORIGINAL REFERENCE NUMBERS OF THE TRUCK MANUFACTURERS IN THE INVOICE TO VEHICLE OWNERS OR TO ANYBODY ELSE. THE CUSTOMER TAKES HIS OWN RESPONSIBILITY IF HE DOES NOT COMPLY WITH WHAT ABOVE.

INJECTION PIPE SET (FROM 1ST TO 3RD)



	Code	OEM new	OEM old
● Model ★ Application	63374/S	1382071	1313676
● 3 TRUCK			
★ DS11 75 ENG 5352582 - ENG 4103049 - DSC11 21 ENG 4103049			
● 3 BUS			
★ DSC11 21B/21C/71B/71C ENG 5352582 - ENG 4103049 - DS11 75B/77B/77C/78B/78C ENG 5352582 - ENG 4103049 - DSC11 24B/24C/27C (EDC) ENG 5352582 - ENG 4103049 -			

INJECTION PIPE SET (FROM 4TH TO 6TH)



	Code	OEM new	OEM old
	63373/S	1313677	
● 3 TRUCK			
★ DS11 75 ENG 5352582 - ENG 4103049 - DSC11 21 ENG 4103049 - ALSO ENG 5333534 -			
● 3 BUS			
★ DSC11 21B/21C/71B/71C ENG 5352582 - ENG 4103049 - DS11 75B/77B/77C/78B/78C ENG 5352582 - ENG 4103049 - DSC11 24B/24C/27C (EDC) ENG 5352582 - ENG 4103049 - ALSO ENG 5333534 -			

INJECTION PIPE SET (FROM 1ST TO 3RD)



	Code	OEM new	OEM old
	63991	1382075	1302530
● 3 TRUCK			
★ DSC11 22 (EDC) ENG 5345021 - ENG 5345022 - ENG 4098746 - ENG 4098747 - DSC11 23 ENG 5320785 - DSC11 21 ENG 5333533 - DSC11 39 ENG 5531900 - ENG 4090569 - DSC11 35/36 ENG 5331693 - DSC11 22 (EDC) - DTC11 01 (EDC) ENG 5317578 - 5345021 - ENG 5345022 - ENG 4080150 - 4098746 - ENG 4098747 - DSC11 70 (EDC) - DTC11 02 (EDC) ENG 5345021 - ENG 5345022 - ENG 4098746 - ENG 4098747 -			
● 3 BUS			
★ DSC11 21B/21C ENG 5333533 - DSC11 22B/24C/27C (EDC) - DSC11 23B/35B/36B - DSC11 24C (EDC) ENG 5333881 - DSC11 70 (EDC) ENG 5345022 - ENG 4098747 -			

ALL THE COMPONENTS LISTED IN OUR CATALOGUE ARE NOT ORIGINAL, THOUGH PERFECTLY INTERCHANGEABLE. REFERENCE NUMBERS, EITHER ORIGINAL OR OF A DIFFERENT NATURE, ARE FOR INFORMATION PURPOSES ONLY WHEN PLACING AN ORDER, PLEASE, ALWAYS USE COSIBO REFERENCE NUMBERS AND DO NOT MENTION THE ORIGINAL REFERENCE NUMBERS OF THE TRUCK MANUFACTURERS IN THE INVOICE TO VEHICLE OWNERS OR TO ANYBODY ELSE. THE CUSTOMER TAKES HIS OWN RESPONSIBILITY IF HE DOES NOT COMPLY WITH WHAT ABOVE.

INJECTION PIPE SET (FROM 4TH TO 6TH)



	Code	OEM new	OEM old
● Model	63992	1302531	
★ Application			
● 3 TRUCK			
★	DSC11 22 (EDC) ENG 5345021 - ENG 5345022 - ENG 4098746 - ENG 4098747 - DSC11 23 ENG 5320785 - DSC11 21 ENG 5333533 - DSC11 39 ENG 5531900 - ENG 4090569 - DSC11 35/36 ENG 5331693 - DSC11 22 (EDC) - DTC11 01 (EDC) ENG 5317578 - 5345021 - ENG 5345022 - ENG 4080150 - 4098746 - ENG 4098747 - DSC11 70 (EDC) - DTC11 02 (EDC) ENG 5345021 - ENG 5345022 - ENG 4098746 - ENG 4098747 -		
● 3 BUS			
★	DSC11 21B/21C ENG 5333533 - DSC11 22B/24C/27C (EDC) - DSC11 23B/35B/36B - DSC11 24C (EDC) ENG 5333881 - DSC11 70 (EDC) ENG 5345022 - ENG 4098747 -		

INJECTION PIPE SET (FROM 1ST TO 3RD)



	61771/S	365484	
● 3 TRUCK			
★	DS11 34 ENG 5307929 - 5335712 - ENG 4070105 - 4092818 - DS11 75 ENG 5331613 - ENG 4090481 - DSC11 18 ENG 5307929 - 5329484 - ENG 4070105 - 4089032 - ENG 5314171 - 5329484 - ENG 5314171 - DSC11 17 ENG 5307929 - 5329484 - ENG 4070105 - 4089033 - DSC11 30 ENG 5320489 - 5331740 - ENG 4082306 - 4090198 - ENG 5310453 - 5331740 - ENG 4072204 - 4090198 - DSC11 08 ENG 5308341 - 5342128 - ENG 4088739 - DSC11 08/10 L03 ENG 5322490 - ENG 4011502 - DSC11 10 ENG 5308341 - 5342127 - ENG 4088739		
● 3 BUS			
★	DS11 34B/C - DSC11 74C - DS11 74C/B - DS11 77C ENG 5326645 - DSC11 04 ENG 5327909 - DSC11 08/18B - DSC11 08C ENG 5335712 - DS11 E01 ENG 5331740 - ENG 5332619		

INJECTION PIPE SET (FROM 4TH TO 6TH)

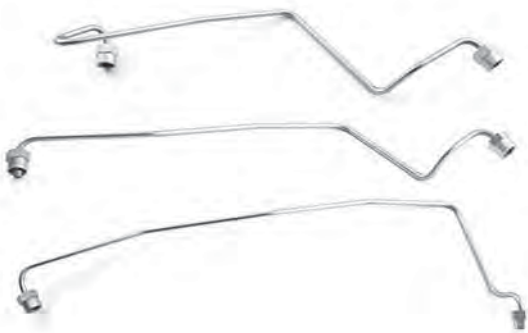

	61770/S	365488	
● 3 TRUCK			
★	DS11 34 ENG 5307929 - 5335712 - ENG 4070105 - 4092818 - DS11 75 ENG 5331613 - ENG 4090481 - DSC11 18 ENG 5307929 - 5329484 - ENG 4070105 - 4089032 - ENG 5314171 - 5329484 - ENG 5314171 - DSC11 17 ENG 5307929 - 5329484 - ENG 4070105 - 4089033 - DSC11 30 ENG 5320489 - 5331740 - ENG 4082306 - 4090198 - ENG 5310453 - 5331740 - ENG 4072204 - 4090198 - DSC11 08 ENG 5308341 - 5342128 - ENG 4088739 - DSC11 08/10 L03 ENG 5322490 - ENG 4011502 - DSC11 10 ENG 5308341 - 5342127 - ENG 4088739		
● 3 BUS			
★	DS11 34B/C - DSC11 74C - DS11 74C/B - DS11 77C ENG 5326645 - DSC11 04 ENG 5327909 - DSC11 08/18B - DSC11 08C ENG 5335712 - DS11 E01 ENG 5331740 - ENG 5332619		

ALL THE COMPONENTS LISTED IN OUR CATALOGUE ARE NOT ORIGINAL, THOUGH PERFECTLY INTERCHANGEABLE. REFERENCE NUMBERS, EITHER ORIGINAL OR OF A DIFFERENT NATURE, ARE FOR INFORMATION PURPOSES ONLY WHEN PLACING AN ORDER, PLEASE, ALWAYS USE COSIBO REFERENCE NUMBERS AND DO NOT MENTION THE ORIGINAL REFERENCE NUMBERS OF THE TRUCK MANUFACTURERS IN THE INVOICE TO VEHICLE OWNERS OR TO ANYBODY ELSE. THE CUSTOMER TAKES HIS OWN RESPONSIBILITY IF HE DOES NOT COMPLY WITH WHAT ABOVE.

	Code	OEM new	OEM old
INJECTION PIPE 1ST	63571	1375369	
<ul style="list-style-type: none"> ● Model ★ Application 			
<ul style="list-style-type: none"> ● 4 TRUCK 			
<ul style="list-style-type: none"> ★ DSC12 01/02 - DC11 07 			
<ul style="list-style-type: none"> ● 4 BUS 			
<ul style="list-style-type: none"> ★ DC11 07 - DSC12 02 			
<ul style="list-style-type: none"> ● IND. MARINE ENGINE 4 			
<ul style="list-style-type: none"> ★ DSC/DC12 41/46/47/48 			



INJECTION PIPE 2ND	63572	1375370	
<ul style="list-style-type: none"> ● 4 TRUCK 			
<ul style="list-style-type: none"> ★ DSC12 01/02 - DC11 07 			
<ul style="list-style-type: none"> ● 4 BUS 			
<ul style="list-style-type: none"> ★ DC11 07 - DSC12 02 			
<ul style="list-style-type: none"> ● IND. MARINE ENGINE 4 			
<ul style="list-style-type: none"> ★ DSC/DC12 41/46/47/48 			



INJECTION PIPE 3RD	63573	1375371	
<ul style="list-style-type: none"> ● 4 TRUCK 			
<ul style="list-style-type: none"> ★ DSC12 01/02 - DC11 07 			
<ul style="list-style-type: none"> ● 4 BUS 			
<ul style="list-style-type: none"> ★ DC11 07 - DSC12 02 			
<ul style="list-style-type: none"> ● IND. MARINE ENGINE 4 			
<ul style="list-style-type: none"> ★ DSC/DC12 41/46/47/48 			



ALL THE COMPONENTS LISTED IN OUR CATALOGUE ARE NOT ORIGINAL, THOUGH PERFECTLY INTERCHANGEABLE. REFERENCE NUMBERS, EITHER ORIGINAL OR OF A DIFFERENT NATURE, ARE FOR INFORMATION PURPOSES ONLY WHEN PLACING AN ORDER, PLEASE, ALWAYS USE COSIBO REFERENCE NUMBERS AND DO NOT MENTION THE ORIGINAL REFERENCE NUMBERS OF THE TRUCK MANUFACTURERS IN THE INVOICE TO VEHICLE OWNERS OR TO ANYBODY ELSE. THE CUSTOMER TAKES HIS OWN RESPONSIBILITY IF HE DOES NOT COMPLY WITH WHAT ABOVE.

INJECTION PIPE 4TH



● Model
★ Application

Code

OEM new

OEM old

63574

1375372

● 4 TRUCK

★ DSC12 01/02 - DC11 07

● 4 BUS

★ DC11 07 - DSC12 02

● IND. MARINE ENGINE 4

★ DSC/DC12 41/46/47/48

INJECTION PIPE 5TH



63575

1375373

● 4 TRUCK

★ DSC12 01/02 - DC11 07

● 4 BUS

★ DC11 07 - DSC12 02

● IND. MARINE ENGINE 4

★ DSC/DC12 41/46/47/48

INJECTION PIPE 6TH



63576

1375374

● 4 TRUCK

★ DSC12 01/02 - DC11 07

● 4 BUS

★ DC11 07 - DSC12 02

● IND. MARINE ENGINE 4

★ DSC/DC12 41/46/47/48

ALL THE COMPONENTS LISTED IN OUR CATALOGUE ARE NOT ORIGINAL, THOUGH PERFECTLY INTERCHANGEABLE. REFERENCE NUMBERS, EITHER ORIGINAL OR OF A DIFFERENT NATURE, ARE FOR INFORMATION PURPOSES ONLY WHEN PLACING AN ORDER, PLEASE, ALWAYS USE COSIBO REFERENCE NUMBERS AND DO NOT MENTION THE ORIGINAL REFERENCE NUMBERS OF THE TRUCK MANUFACTURERS IN THE INVOICE TO VEHICLE OWNERS OR TO ANYBODY ELSE. THE CUSTOMER TAKES HIS OWN RESPONSIBILITY IF HE DOES NOT COMPLY WITH WHAT ABOVE.

INJECTION PIPE SET (FROM 1ST TO 8TH)

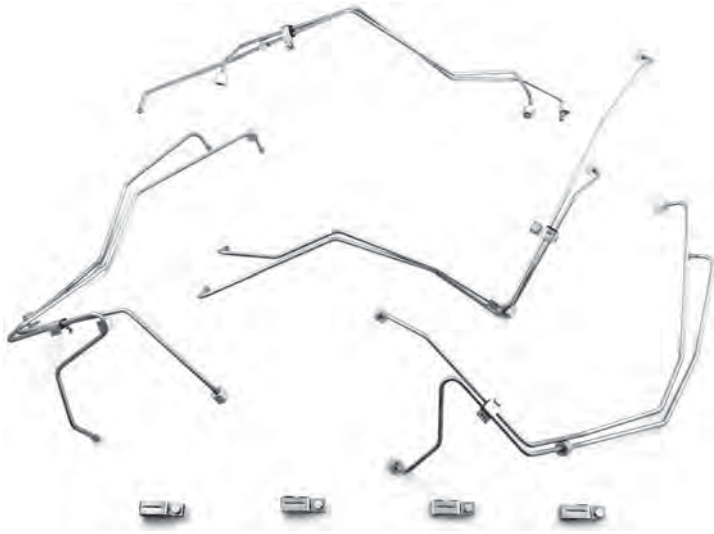

- Model
- ★ Application

Code

OEM new

OEM old

640001357628+
1357633

- **4 TRUCK**

- ★ DSC14

ALL THE COMPONENTS LISTED IN OUR CATALOGUE ARE NOT ORIGINAL, THOUGH PERFECTLY INTERCHANGEABLE. REFERENCE NUMBERS, EITHER ORIGINAL OR OF A DIFFERENT NATURE, ARE FOR INFORMATION PURPOSES ONLY WHEN PLACING AN ORDER, PLEASE, ALWAYS USE COSIBO REFERENCE NUMBERS AND DO NOT MENTION THE ORIGINAL REFERENCE NUMBERS OF THE TRUCK MANUFACTURERS IN THE INVOICE TO VEHICLE OWNERS OR TO ANYBODY ELSE. THE CUSTOMER TAKES HIS OWN RESPONSIBILITY IF HE DOES NOT COMPLY WITH WHAT ABOVE.

FUEL FILTER (2 BAR)



	Code	OEM new	OEM old
● Model	60630	1372444	
★ Application			
● 4 BUS			
★	DC11 07 - DSC12 01/02 - K94 DC9 01/02/03/04/05/06 - K/L/N94 DSC9 - N94 DC9 01		
● IND. MARINE ENGINE 4			
★	D/DC/DI9 A/M - D12 A/M - D/DC/DI11 A - DS9/DSC9/DSI9 - DS11A/DSC11A/DSI11A - DI12 41/42/43/44/45/M		
● 4 TRUCK			
★	DC11 07 - DSC12 01/02 - DSC11 74/75/79 - DSC14 13/15 - DSC9L - DC9L		

FUEL FILTER



	62401	1873018	1446432
● 4 BUS			
★	DC9 19/20/21		
● F-K-N BUS			
★	L/S D9/D11/D12 PDE		
● IND. MARINE ENGINE 4			
★	D16A		
● IND. MARINE ENGINE 5			
★	DC9A EMS		
● 4 TRUCK			
★	S D16 - L D16 9.3/12.2 BAR - DC19 19/20/21 - DC16 01/02		
● P-G-R-T TRUCK			
★	L/S D16 - L/S D9/D11/D12 PDE - DC16 03/04/05/06/08/09/17/18/19		

ALL THE COMPONENTS LISTED IN OUR CATALOGUE ARE NOT ORIGINAL, THOUGH PERFECTLY INTERCHANGEABLE. REFERENCE NUMBERS, EITHER ORIGINAL OR OF A DIFFERENT NATURE, ARE FOR INFORMATION PURPOSES ONLY WHEN PLACING AN ORDER, PLEASE, ALWAYS USE COSIBO REFERENCE NUMBERS AND DO NOT MENTION THE ORIGINAL REFERENCE NUMBERS OF THE TRUCK MANUFACTURERS IN THE INVOICE TO VEHICLE OWNERS OR TO ANYBODY ELSE. THE CUSTOMER TAKES HIS OWN RESPONSIBILITY IF HE DOES NOT COMPLY WITH WHAT ABOVE.

FUEL FILTER



- Model
- ★ Application

Code

OEM new

OEM old

63886

1873016

1459762

- F-K-N BUS

- ★ D12 HPI - L/S D12 HPI -

- 4 TRUCK

- ★ L D12 HPI 9.3/12.2 BAR - S D12 HPI - DT12 - DC12 03 HPI

- P-G-R-T TRUCK

- ★ L/S HPI - D12 HPI

ALL THE COMPONENTS LISTED IN OUR CATALOGUE ARE NOT ORIGINAL, THOUGH PERFECTLY INTERCHANGEABLE. REFERENCE NUMBERS, EITHER ORIGINAL OR OF A DIFFERENT NATURE, ARE FOR INFORMATION PURPOSES ONLY WHEN PLACING AN ORDER, PLEASE, ALWAYS USE COSIBO REFERENCE NUMBERS AND DO NOT MENTION THE ORIGINAL REFERENCE NUMBERS OF THE TRUCK MANUFACTURERS IN THE INVOICE TO VEHICLE OWNERS OR TO ANYBODY ELSE. THE CUSTOMER TAKES HIS OWN RESPONSIBILITY IF HE DOES NOT COMPLY WITH WHAT ABOVE.

	Code	OEM new	OEM old
FLANGE	64347	1549330	1376871
<ul style="list-style-type: none"> ● Model ★ Application 			
<ul style="list-style-type: none"> ● 4 BUS 			
<ul style="list-style-type: none"> ★ DC11 07 - DSC12 02 			
<ul style="list-style-type: none"> ● 4 TRUCK 			
<ul style="list-style-type: none"> ★ DC11 07 - DSC12 01/02 			
<ul style="list-style-type: none"> ● IND. MARINE ENGINE 4 			
<ul style="list-style-type: none"> ★ DI12 41/42/43/44/45/57M - DSC12 40/42A - DC12 40/42A 			



INJECTION PUMP PLATE	60720	392204	280862
<ul style="list-style-type: none"> ● 3 TRUCK ★ 			



INJECTION PUMP PLATE	60721	318523	
<ul style="list-style-type: none"> ● 3 BUS ★ 			
<ul style="list-style-type: none"> ● 3 TRUCK ★ 			



ALL THE COMPONENTS LISTED IN OUR CATALOGUE ARE NOT ORIGINAL, THOUGH PERFECTLY INTERCHANGEABLE. REFERENCE NUMBERS, EITHER ORIGINAL OR OF A DIFFERENT NATURE, ARE FOR INFORMATION PURPOSES ONLY WHEN PLACING AN ORDER, PLEASE, ALWAYS USE COSIBO REFERENCE NUMBERS AND DO NOT MENTION THE ORIGINAL REFERENCE NUMBERS OF THE TRUCK MANUFACTURERS IN THE INVOICE TO VEHICLE OWNERS OR TO ANYBODY ELSE. THE CUSTOMER TAKES HIS OWN RESPONSIBILITY IF HE DOES NOT COMPLY WITH WHAT ABOVE.

INJECTION PUMP PLATE



● Model
★ Application

	Code	OEM new	OEM old
	63084	1111494	
● 3 BUS ★			
● 3 TRUCK ★			
● IND. MARINE ENGINE 4 ★			

ALL THE COMPONENTS LISTED IN OUR CATALOGUE ARE NOT ORIGINAL, THOUGH PERFECTLY INTERCHANGEABLE. REFERENCE NUMBERS, EITHER ORIGINAL OR OF A DIFFERENT NATURE, ARE FOR INFORMATION PURPOSES ONLY WHEN PLACING AN ORDER, PLEASE, ALWAYS USE COSIBO REFERENCE NUMBERS AND DO NOT MENTION THE ORIGINAL REFERENCE NUMBERS OF THE TRUCK MANUFACTURERS IN THE INVOICE TO VEHICLE OWNERS OR TO ANYBODY ELSE. THE CUSTOMER TAKES HIS OWN RESPONSIBILITY IF HE DOES NOT COMPLY WITH WHAT ABOVE.

	Code	OEM new	OEM old
FUEL TANK CAP	61548	1122696	361692
● Model			
★ Application			
● 3 BUS			
★			
● 3 TRUCK			
★			



	Code	OEM new	OEM old
FUELL TANK CAP W/O KEY	61745	1478450	1369848 1432186
● 4 TRUCK			
★	CH 2022159 - CH 2022160 - CH 5161834 - CH 5161835 - CH 9115701 - CH 9115702 - CH 3598108 - CH 3598109 - DT12 02/08/10 CH 2009304 - CH 2009305 - CH 5126028 - CH 5126029 - CH 9100952 - CH 9100953 - CH 3574738 - CH 3574739 - DC12 03HPI CH 2009304 - CH 2009305 - CH 5126028 - CH 5126029 - CH 9100952 - CH 9100953 - CH 3574738 - CH 3574739 - D16 CH 2022159 - CH 5161834 - CH 9115701 - CH 3598108		
● P-G-R-T TRUCK			
★	PDE CH 2022159 - CH 2024649 - CH 5161834 - CH 5169578 - CH 9115701 - CH 9118385 - CH 3598108 - CH 3602569 - CH 2022160 - 2024648 - CH 5161835 - 5169577 - CH 9115702 - 9118384 - CH 3598109 - 3602568 - HPI CH 2009304 - CH 2009305 - CH 5126028 - CH 5126029 - CH 9100952 - CH 9100953 - CH 3574738 - CH 3574739 - XPI		



	Code	OEM new	OEM old
FUELL TANK CAP W/ KEY	63864	1481301	
● 4 TRUCK			
★	D16 CH 2022159 - CH 2022160 - CH 5161834 - CH 5161835 - CH 9115701 - CH 9115702 - CH 3598108 - CH 3598109 - DT12 02/08/10 DC12 03 HPI CH 2009304 - CH 2009305 - CH 5126028 - CH 5126029 - CH 9100952 - CH 9100953 - CH 3574738 - CH 3574739		
● P-G-R-T TRUCK			
★	PDE CH 2022159 - CH 2022160 - 2024648 - CH 2024649 - CH 5161834 - CH 5161835 - 5169577 - CH 5169578 - CH 9115701 - CH 9115702 - 9118384 - CH 9118385 - CH 3598108 - CH 3598109 - 3602568 - CH 3602569 - HPI CH 2009304 - CH 2009305 - CH 5126028 - CH 5126029 - CH 9100952 - CH 9100953 - CH 3574738 - CH 3574739 - XPI		
● 4 BUS			
★			



ALL THE COMPONENTS LISTED IN OUR CATALOGUE ARE NOT ORIGINAL, THOUGH PERFECTLY INTERCHANGEABLE. REFERENCE NUMBERS, EITHER ORIGINAL OR OF A DIFFERENT NATURE, ARE FOR INFORMATION PURPOSES ONLY WHEN PLACING AN ORDER, PLEASE, ALWAYS USE COSIBO REFERENCE NUMBERS AND DO NOT MENTION THE ORIGINAL REFERENCE NUMBERS OF THE TRUCK MANUFACTURERS IN THE INVOICE TO VEHICLE OWNERS OR TO ANYBODY ELSE. THE CUSTOMER TAKES HIS OWN RESPONSIBILITY IF HE DOES NOT COMPLY WITH WHAT ABOVE.

	Code	OEM new	OEM old
FUEL TANK FILLER CAP (OLD VERSION)	62225		
<ul style="list-style-type: none"> ● Model ★ Application 			
<ul style="list-style-type: none"> ● 4 TRUCK 			
<ul style="list-style-type: none"> ★ D16 CH 2022159 - CH 2022160 - CH 5161834 - CH 5161835 - CH 9115701 - CH 9115702 - CH 3598108 - CH 3598109 - DT12 02/08/10 DC12 03 HPI CH 2009304 - CH 2009305 - CH 5126028 - CH 5126029 - CH 9100952 - CH 9100953 - CH 3574738 - CH 3574739 			
<ul style="list-style-type: none"> ● P - G - R - T TRUCK 			
<ul style="list-style-type: none"> ★ PDE CH 2022159 - CH 2022160 - 2024648 - CH 2024649 - CH 5161834 - CH 5161835 - 5169577 - CH 5169578 - CH 9115701 - CH 9115702 - 9118384 - CH 9118385 - CH 3598108 - CH 3598109 - 3602568 - CH 3602569 - HPI CH 2009304 - CH 2009305 - CH 5126028 - CH 5126029 - CH 9100952 - CH 9100953 - CH 3574738 - CH 3574739 - XPI 			
<ul style="list-style-type: none"> ● 4 BUS 			
<ul style="list-style-type: none"> ★ 			



O-RING	66573/1	242857	
<ul style="list-style-type: none"> ● 3 BUS 			
<ul style="list-style-type: none"> ★ 			
<ul style="list-style-type: none"> ● 3 TRUCK 			
<ul style="list-style-type: none"> ★ 			
<ul style="list-style-type: none"> ● 4 BUS 			
<ul style="list-style-type: none"> ★ 			
<ul style="list-style-type: none"> ● 4 TRUCK 			
<ul style="list-style-type: none"> ★ D16 - DT12 02/08/10 - DC12 03 HPI 			
<ul style="list-style-type: none"> ● P-G-R-T TRUCK 			
<ul style="list-style-type: none"> ★ PDE - HPI - XPI 			



TENSIONING BAND + RUBBER CUSHION L=683 mm	62534	1401839+ 1398636	1387191 1398636 1401839
<ul style="list-style-type: none"> ● 4 BUS 			
<ul style="list-style-type: none"> ★ 			
<ul style="list-style-type: none"> ● 4 TRUCK 			
<ul style="list-style-type: none"> ★ 			
<ul style="list-style-type: none"> ● P-G-R-T TRUCK 			
<ul style="list-style-type: none"> ★ 			



	Code	OEM new	OEM old
TENSIONING BAND + RUBBER CUSHION L=710 mm	62535	1401840+ 1482500	1387193 1401840 1482500
<ul style="list-style-type: none"> ● Model ★ Application 			
<ul style="list-style-type: none"> ● 4 TRUCK ★ 			
<ul style="list-style-type: none"> ● P-G-R-T TRUCK ★ 			



FUEL LEVEL GAUGE	65163	361481	
<ul style="list-style-type: none"> ● 3 TRUCK ★ 			



FUEL LEVEL GAUGE	64028	1424074	1373479
<ul style="list-style-type: none"> ● 4 TRUCK ★ D16 ● P-G-R-T TRUCK ★ PDE 			



ALL THE COMPONENTS LISTED IN OUR CATALOGUE ARE NOT ORIGINAL, THOUGH PERFECTLY INTERCHANGEABLE. REFERENCE NUMBERS, EITHER ORIGINAL OR OF A DIFFERENT NATURE, ARE FOR INFORMATION PURPOSES ONLY WHEN PLACING AN ORDER, PLEASE, ALWAYS USE COSIBO REFERENCE NUMBERS AND DO NOT MENTION THE ORIGINAL REFERENCE NUMBERS OF THE TRUCK MANUFACTURERS IN THE INVOICE TO VEHICLE OWNERS OR TO ANYBODY ELSE. THE CUSTOMER TAKES HIS OWN RESPONSIBILITY IF HE DOES NOT COMPLY WITH WHAT ABOVE.

	Code	OEM new	OEM old
SILENCER	60343	1338128	1338071
<ul style="list-style-type: none"> ● Model ★ Application 			
<ul style="list-style-type: none"> ● 3 TRUCK 			
<ul style="list-style-type: none"> ★ DS9/DSC9 6X4 84dB(A) - HK 4X4/6X4/6X6 - EK 6X4 84dB(A) - GR900/GR900R/GRS900/GRS900R 84dB(A) - DN9 84dB(A) - 4X2 6X2 6X4 6X2/4 GR880/GR880T 84dB(A) - P/R93 4X2 6X2 6X2/4 6X4 GA/GAE770 - GR/GRE871T - GR801/GR900 - 4X2 6X2 6X4 GR/GRE871T - GR801/GR900 84dB(A) - 4X2 6X2 6X2/4 6X4 G770 - GS771/772 - GR/GRE871 - GR/GRS900R 84dB - 4X2 6X2 6X4 GRH880 - GRH900 84dB(A) - 4X2 6X2 6X4 GRH880 84dB - 8X2 8X4 GR900/GRS900 84dB - 8X4 84dB(A) - DSC9 07/08 84dB(A) - 8X2 8X4 GRH880/GR900/GRS900 84dB(A) - G93 4X2 G770 - GA/GAE770 - GA/GAE774 - GR/GRE871T - GR801/GR900 - 4X2 6X2 G770 - GS771/772 - GR/GRE871T - GR/GRS900R 84dB(A) - P/R93 8X2 8X4 GR801 84dB(A) - 8X2 8X4 GR900/GR900R/GRS900/GRS900R 84dB(A) - P/R93 ad38 - ad42/62 84dB(A) - P93 ML4X2 - ML6X2 - ML6X4 - HL4X2 - HL6X2 GA776 84dB(A) - P93 ML/MV/HL 4X2/6X2 GA750 84dB(A) - DTC11 GRS900 - P93 4X2/6X2 GA850 ad38 - ad42/62 84dB(A) - P113 ML/HL 4X2/6X2 GA850/GA850R ad38 - ad42/62 84dB(A) 			



SLIDING BUSHING	65088	1335618	
<ul style="list-style-type: none"> ● 3 TRUCK 			
<ul style="list-style-type: none"> ★ DN9 - DS9 - DSC9 - DSC9 07 - DTC11 - G/P/R 93 - P 113 			



SILENCER	62336	1497013	1387823
<ul style="list-style-type: none"> ● 4 TRUCK 			
<ul style="list-style-type: none"> ★ D16 CH 2002333 - CH 5106746 - CH 9092530 - CH 3560649 			
<ul style="list-style-type: none"> ● P-G-R-T TRUCK 			
<ul style="list-style-type: none"> ★ D16 CH 2002333 - CH 5106746 - CH 9092530 			



		Code	OEM new	OEM old
SILENCER	● Model	63093	1500455	1420278
	★ Application			
	● 4 TRUCK			
	★	4X4 6X6 - CR GRSH900 - GRSH900R		
	● P-G-R-T TRUCK			
	★	D9/D11/D12/D13 CH 2028960 - CH 5181645 - CH 9123036 - CH 3611301		
	● 3 BUS			
	★	CH 1828105		
	● 4 BUS			
	★	K/L 94		
● F-K-N BUS				
★	K			



		64740	1800871	1484094
SILENCER	● 4 TRUCK			
	★	D9/D11/D12 CH 1290985 - CH 4499486 - CH 9082897 - CH 3542832 - D12 8X8 WLS/ZLS - D16 CH 2002334 - CH 5106747 - CH 9092531 - CH 3560650		
	● P-G-R-T TRUCK			
	★	D9/D11/D12/D13 CH 2028960 - CH 5181645 - CH 9123036 - CH 3611301 - D16 CH 2002334 - CH 5106747 - CH 9092531 - D9/D11/D12 CH 2028959 - CH 5181644 - CH 9123035 - CH 3611300		







		Code	OEM new	OEM old
EXHAUST PIPE	● Model	60346	1361983	
	★ Application			
	● 3 BUS			
	★ CH 1827459 - DSC11 22/23/74 CH 1825186			
	● IND. MARINE ENGINE 4			
	★			
	● IND. MARINE ENGINE 5			
	★			
	● 3 TRUCK			
	★ DS9 DSC9 CH 1183014 6X4 GR900 - GRS900 84dB(A) - CH 1167918 4X4/6X6 ad38 46 84dB(A) - 8X4 84dB(A) - HK 4X4 - HK 6X6 84dB(A) CH 1167918 - 1183183 - GR/GRE871T 84dB(A) - 4X2 6X2 6X4 8X2 8X4 MA6X2A 84dB - GR801 84dB(A) CH 1192433 - CH 9000673 - P93H GR900/GRS900 84dB(A) CH 1183014 - 4X2 6X2 6X2/4 6X4 8X4 GR900/GRS900 84dB CH 1183014 - CP13/CP19 4X4 6X6 84dB(A) CH 1209040 - CH 1209041 - CH 4344437 - CH 4344438 - 4X2 6X2 6X4 8X2 8X4 GRH900/GRS900 84dB(A) - ad36/38 MA4X2 84dB(A) CH 1193611 - CH 1199484 - CH 4334055 - CH 9002352 - P/R 93 4X2 6X2 6X4 8X2 8X4 MA6X2A 84dB(A) - ad36/38 MA/MW/HA GR/GRS900 - GR/GRS900R 84dB(A) - P/R 93 GR801 84dB - CH 1192433 - CH 9000673 - ad36/38 MA4X2/MW4X2 84dB CH 1193611 - CH 1199484 - CH 4334055 - CH 9002352 - ad36/38 MA4X2/MW4X2 DTC11 84dB - ad36/38 MA/MW/HA GR/GRS900R 84dB CH 1193612 - P/R 113 MW 4X2 A/B - R143 MW 4X2 A/B ad36/38 MEGA - TRAILER			
● 4 TRUCK				
★ CP/CR 14 - CP/CR 19 8X2/8X4/8X8				



		60347	357402	
EXHAUST PIPE	● 3 BUS			
	★ CH 1823425 - CH 1823072 - CH 1823419 - CH 1827458 - CH 1823426 - CH 1823420 - DS/DSC			
	● 3 TRUCK			
	★ DN9 01 CH 1166898 - ad31 - 34 38 - 62 MA ad36 GA770/GAE770 CH 1166898 - ad31 - 34 G770/GS771/772 - GR871/GRE871T CH 1166898 - ad31 - 34 6X4 CH 1167917 - GR880 - GRH880 CH 1166898 - CR19 84dB(A) CH 1166898 - ad38 - 62 MA ad36 GS771/772 - GR/GRE871T CH 1166898 - CG13 GA/GAE770 GS771/772 GR/GRE871T CH 1166898 - ad36 - 62 GS771/772 GR871 GRE871T CH 1166898 - ad28 6X2/4 LHD/RHD CH 1166898 - ad38 - 62 GRH880 CH 1166898 - ad38 - 62 8X2 8X4 GR871 GRH880 - ad46 - 62 8X2 8X4 - ad34 GRH880 CH 1166898 - ad42 8X4 GR871 GRE871T - G93 ad38 42 - 62 GA - GAE774 CH 1166898 - P93 ad31/34/36/38 42 - 62 GA/GAE774 CH 1166898 - ad28 6X2/4 ad31 - 62 6X2 MA ad36 CH 1157366 - CH 4287118			



	Code	OEM new	OEM old
EXHAUST PIPE	63094	1397273	
	<ul style="list-style-type: none"> ● Model ★ Application 		
	<ul style="list-style-type: none"> ● 4 TRUCK ★ 94 - 114 - 124 - 144 UP TO CH 1235758 - CH 4385404 - CH 9028647 		
EXHAUST PIPE	64665	1483281	1445925
	<ul style="list-style-type: none"> ● 4 TRUCK ★ R164 ● P-G-R-T TRUCK ★ D16 CH 2010136 CH 5128409 CH 9102002 		
EXHAUST PIPE	64742	1505748	1497653
	<ul style="list-style-type: none"> ● 4 TRUCK ★ D9/D11/D12 - DT12 CH 1290794 - CH 4497414 - CH 9081938 - CH 3543198 - CH 1277993 - 1290793 - CH 4466325 - 4497413 - CH 9067728 - 9081937 - CH 3532779 - 3543197 ● P-G-R-T TRUCK ★ DT12 		
EXHAUST PIPE	65098	1510575	
	<ul style="list-style-type: none"> ● 4 TRUCK ★ DC9 19/20/21 ● P-G-R-T TRUCK ★ CH 2010137 - 2014271 - CH 5128410 - 5139835 - CH 9102003 - 9106792 		

ALL THE COMPONENTS LISTED IN OUR CATALOGUE ARE NOT ORIGINAL, THOUGH PERFECTLY INTERCHANGEABLE. REFERENCE NUMBERS, EITHER ORIGINAL OR OF A DIFFERENT NATURE, ARE FOR INFORMATION PURPOSES ONLY WHEN PLACING AN ORDER, PLEASE, ALWAYS USE COSIBO REFERENCE NUMBERS AND DO NOT MENTION THE ORIGINAL REFERENCE NUMBERS OF THE TRUCK MANUFACTURERS IN THE INVOICE TO VEHICLE OWNERS OR TO ANYBODY ELSE. THE CUSTOMER TAKES HIS OWN RESPONSIBILITY IF HE DOES NOT COMPLY WITH WHAT ABOVE.

	Code	OEM new	OEM old
EXHAUST PIPE	65361	1505749	
<ul style="list-style-type: none"> ● Model ★ Application 			
<ul style="list-style-type: none"> ● 4 TRUCK 			
<ul style="list-style-type: none"> ★ D9/D11/D12 CH 1290794 - CH 4497414 - CH 9081938 - CH/TL 3543198 - CH 1290104 - 1290793 - CH 4495472 - 4497413 - CH 9081076 - 9081937 - CH 3541894 - 3543197 			
<ul style="list-style-type: none"> ● P-G-R-T TRUCK 			
<ul style="list-style-type: none"> ★ D9/D11/D12 			



	60432	1428892	1364355
EXHAUST BELLOW			
<ul style="list-style-type: none"> ● 4 BUS 			
<ul style="list-style-type: none"> ★ OSC9 G01 - L/N/K 94 - K94 REAR/POT 4X2 6X2 - F94 LHD/RHD 			
<ul style="list-style-type: none"> ● IND. MARINE ENGINE 4 			
<ul style="list-style-type: none"> ★ DSI/DI12A - DC9 51/53/54/55A 			
<ul style="list-style-type: none"> ● IND. MARINE ENGINE 5 			
<ul style="list-style-type: none"> ★ DC9A EMS 			
<ul style="list-style-type: none"> ● 4 TRUCK 			
<ul style="list-style-type: none"> ★ 94 - 114 - 124 - 144 - D12 CP/CR14 CP/CR19 8X2 8X4 8X8 - DSC11 74/75/79 - DC11 01/02/03/04/06 - OSC11 G03 			



	60556	1387983	
EXHAUST BELLOW			
<ul style="list-style-type: none"> ● 4 TRUCK 			
<ul style="list-style-type: none"> ★ 164 - D16 			



SLIDING JOINT





	Code	OEM new	OEM old
● Model	63778	1364290	
★ Application			
● 4 BUS			
★ OSC9 G01 - L/N/K 94 - K94 REAR 4X2/6X2 - F94 LHD/RHD			
● IND. MARINE ENGINE 4			
★ DSI/DI 12 A - DC9 51/53/54/55 A			
● IND. MARINE ENGINE 5			
★ DC9A EMS			
● 4 TRUCK			
★ D12 - CP14 - CR14 - CP19 - CR19 8X2/8X4/8X8 - D12 - DSC11 74/75/79 - DC11 01/02/03/04/06 - OSC11 G03			

ALL THE COMPONENTS LISTED IN OUR CATALOGUE ARE NOT ORIGINAL, THOUGH PERFECTLY INTERCHANGEABLE. REFERENCE NUMBERS, EITHER ORIGINAL OR OF A DIFFERENT NATURE, ARE FOR INFORMATION PURPOSES ONLY WHEN PLACING AN ORDER, PLEASE, ALWAYS USE COSIBO REFERENCE NUMBERS AND DO NOT MENTION THE ORIGINAL REFERENCE NUMBERS OF THE TRUCK MANUFACTURERS IN THE INVOICE TO VEHICLE OWNERS OR TO ANYBODY ELSE. THE CUSTOMER TAKES HIS OWN RESPONSIBILITY IF HE DOES NOT COMPLY WITH WHAT ABOVE.

		Code	OEM new	OEM old
CLAMP	● Model	63097	1300367	
	★ Application			
	● 3 BUS			
	★	DSC11 22/23/70 CH 1825186		
	● IND. MARINE ENGINE 4			
	★			
	● IND. MARINE ENGINE 5			
	★			
	● 3 TRUCK			
	★	4X4 6X6 ad38 - 46 84dB(A) - 4X4 6X6 GT800 84dB(A) - DS9/DSC9 6X4 84dB(A) - HK 6X4 - EK 6X4 84dB(A) - 8X2 8X4 GR900/GR900R/GRS900/GRS900R 84dB(A) - DS9/DSC9 6X4 GR900/GRS900 84dB(A) - DN9 84dB(A) - 4X2 6X2 6X4 6X2/4 GR880/GR880T 84dB(A) - P/R93 4X2 6X2 6X2/4 6X4 GA - GAE770/GR - GRE871T/GR801/GR900 84dB(A) - 4X4 8X4 84dB(A) - 4X2 6X2 6X2/4 6X4 G770/GS771 - 772 GR/GRE871 GR/GRS900R 84dB - HK 4X4 6X6 84dB(A) - 4X2 6X2 6X4 GRH880/GRH900 84dB(A) - 4X2 6X2 6X4 GRH880 84dB - 4X2 6X2 6X2/4 6X4 8X2 8X4 GR900/GRS900 84dB - 4X2 6X2 6X4 8X2 8X4 MA6X2A 84dB - P93H GR900/GRS900 84dB(A) - DSC9 07/08 84dB(A) - CP13/19 4X4 6X6 84dB(A) - 8X2 8X4 GRH880 GRS900 84dB(A) - G93 4X2 G770 - GA/GAE770 - GA/GAE774 - GR/GRE871T - GR801/GR900 - 4X2 6X2 6X4 8X2 8X4 GRH900/GRS900 84dB(A) - 4X2 6X2 G770 - GS771/772 - GR/GRE871T GR/GRS900R 84dB - P/R93 8X2 8X4 GR801 84dB(A) - ad36/38 MA4X2 84dB(A) - P/R93 4X2 6X2 6X4 8X2 8X4 MA6X2A 84dB(A) - P/R93 ad38 ad42 - 62 84dB(A) - 8X2 8X4 GRH880 GR900/GRS900 84dB - ad36 - 38 MA/MW/HA GR/GRS900 GR/GRS900R 84dB(A) - P93 ML4X2/ML6X2/ML6X4/HL4X2/HL6X2 GA776 84dB(A) - P93 ML/MV/HL 4X2 6X2 GA750 84dB(A) - DTC11 GRS900 - P/R93 GR801 84dB - ad36 - 38 MA4X2/MW4X2 DTC11 84dB - ad36 - 38 MA/MW/HA GR/GRS900R 84dB - DSC11 22/23/70 - P93 4X2 6X2 GA850 ad38 - ad42/62 - P113 ML/HL 4X2 6X2 GA850/GA850R ad38 ad42/62 - R143 4X2 A/B LHD ad36/38 MEGA - TRAILER - P113 MW 4X2 A/B - R113 MW 4X2 A/B ad36/38 MEGA - TRAILER - ad34/38/42/62 84dB(A) - T113 MA/HA 4X2A - T143 MA/HA 4X2A ad38/42/46 84dB(A) - ad31/36 6X4 84dB(A) - CP/CR 8X2 8X4 84dB(A) - ad31/34/38MA 84dB(A) - 6X2/4 LHD - MA6X2A LHD 84dB(A) - 6X2/4 RHD - MA6X2A ad29 84dB(A) - CP/CR ML4X2 - ML6X2 84dB(A) - CP/CR MA4X2 Z ad36 84dB(A) - CP/CR MA4X2 Z HA4X2 Z ad36/38 84dB(A) - CP/CR MA4X2 MW4X2 ad36/38 84dB(A) - CP/CR GR/GRS900R ad36/ad36Z ad38 MA/MW/HA 84dB(A)		
	● 4 TRUCK			
	★	D12 CP/CR14 CP/CR19 8X2 8X4 8X8		

ALL THE COMPONENTS LISTED IN OUR CATALOGUE ARE NOT ORIGINAL, THOUGH PERFECTLY INTERCHANGEABLE. REFERENCE NUMBERS, EITHER ORIGINAL OR OF A DIFFERENT NATURE, ARE FOR INFORMATION PURPOSES ONLY WHEN PLACING AN ORDER, PLEASE, ALWAYS USE COSIBO REFERENCE NUMBERS AND DO NOT MENTION THE ORIGINAL REFERENCE NUMBERS OF THE TRUCK MANUFACTURERS IN THE INVOICE TO VEHICLE OWNERS OR TO ANYBODY ELSE. THE CUSTOMER TAKES HIS OWN RESPONSIBILITY IF HE DOES NOT COMPLY WITH WHAT ABOVE.

		Code	OEM new	OEM old
CLAMP	<ul style="list-style-type: none"> ● Model ★ Application 	63323	1422474	1387136
	<ul style="list-style-type: none"> ● 3 BUS ★ ● 4 BUS ★ F94 LHD/RHD - L94 - N94 - K94 - K94 REAR/POST 4X2 6X2 - OSC9 G01 - OSC09 G01 ● F-K-N BUS ★ DT12 - K DC9 11/12/13/16/17/18/29/30 - DC11 08 - DC12 06/10/13/17 - DT12 03/12/17 - N - F - K UD - K D9 ● IND. MARINE ENGINE 4 ★ DC12 54A - D16A - D16M - D12 42/43/44/45/57/60/66/68/69M - DC9 51/53/54/55A OK ● IND. MARINE ENGINE 5 ★ DC9A EMS ● 4 TRUCK ★ 94 - 114 - 124 - 144 - 164 - DT12 - D9/D11/D12 - D9/D11/D12 CP/CR14 PDE - DC16 - D12 CP/CR14 CP/CR19 8X2 8X4 8X8 - DSC11 74/75/79 - DC11 01/02/03/04/06 - OSC11 G03 - DC9 19/20/21 - CT14/19 - CR19/CT19/CT14 GRSH900R - CT14/CT19 DC16 - DC11/DC12 PDE/HPI - HAI - D9/D11/DC12 AWD - D9/D11/D12 CP/CR14 AWD ● P-G-R-T TRUCK ★ D9/D11/DC12 AWD - D9/D11/D12 CP/CR14 AWD - DT12 - D13 - DC12 14 - D16 - D11/D12/D16 80/82 dBA - CP/CR/CT19 - CG/CP/CT14 - CP/CR16 			

		63107	1315559	
CLAMP				
	<ul style="list-style-type: none"> ● 3 TRUCK ★ DTC11 ● IND. MARINE ENGINE 4 ★ ● IND. MARINE ENGINE 5 ★ 			

ALL THE COMPONENTS LISTED IN OUR CATALOGUE ARE NOT ORIGINAL, THOUGH PERFECTLY INTERCHANGEABLE. REFERENCE NUMBERS, EITHER ORIGINAL OR OF A DIFFERENT NATURE, ARE FOR INFORMATION PURPOSES ONLY WHEN PLACING AN ORDER, PLEASE, ALWAYS USE COSIBO REFERENCE NUMBERS AND DO NOT MENTION THE ORIGINAL REFERENCE NUMBERS OF THE TRUCK MANUFACTURERS IN THE INVOICE TO VEHICLE OWNERS OR TO ANYBODY ELSE. THE CUSTOMER TAKES HIS OWN RESPONSIBILITY IF HE DOES NOT COMPLY WITH WHAT ABOVE.

	Code	OEM new	OEM old
RUBBER MOUNTING	60398	40607	
● Model			
★ Application			
● 3 BUS			
★			
● 4 BUS			
★ F94 LH/RHD			
● F-K-N-BUS			
★ F			
● IND. MARINE ENGINE 5			
★ SG9 A280			
● 3 TRUCK			
★			



	64006	1545149	1421621
PROTECTION COVER			
● 4 TRUCK			
★ D9/11/12 CH 1290985 - CH 4499486 - CH 9082897 - CH 3542832 - DC9 04/05/06 - DSC9 11/12/13 CH 1240717 - CH 4393474 - CH 9033049 - CH 3504513 - OSC11 G03 - D16 CH 2002333CH 2002334 - CH 5106746 - CH 5106747 - CH 9092530 - CH 9092531 - CH 3560649 - CH 3560650 - AND ALSO CH 1240717 - 1290984 - CH 4393474 - 4499485 - CH 9033049 - 9082896 - CH 3504513 - 3542831			
● P-G-R-T TRUCK			
★ D9 - D11 - D12 - D13 CH 2028960 - CH 5181645 - CH 9123036 - CH 3611301 - D16 - D9 - D11 - D12 CH 2028959 - CH 5181644 - CH 9123035 - CH 3611300			

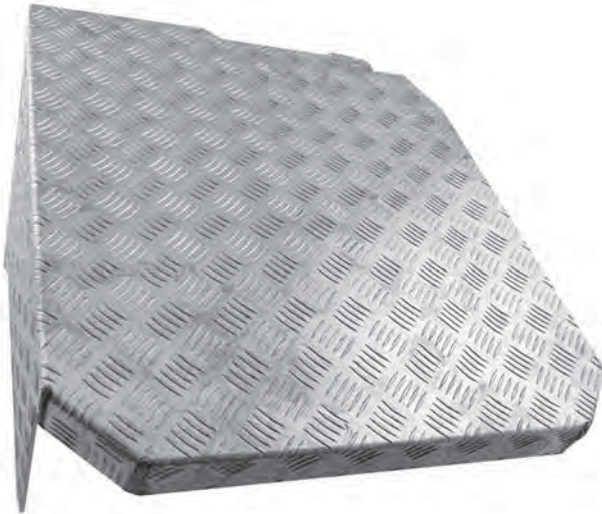

ALL THE COMPONENTS LISTED IN OUR CATALOGUE ARE NOT ORIGINAL, THOUGH PERFECTLY INTERCHANGEABLE. REFERENCE NUMBERS, EITHER ORIGINAL OR OF A DIFFERENT NATURE, ARE FOR INFORMATION PURPOSES ONLY WHEN PLACING AN ORDER, PLEASE, ALWAYS USE COSIBO REFERENCE NUMBERS AND DO NOT MENTION THE ORIGINAL REFERENCE NUMBERS OF THE TRUCK MANUFACTURERS IN THE INVOICE TO VEHICLE OWNERS OR TO ANYBODY ELSE. THE CUSTOMER TAKES HIS OWN RESPONSIBILITY IF HE DOES NOT COMPLY WITH WHAT ABOVE.

PROTECTION COVER

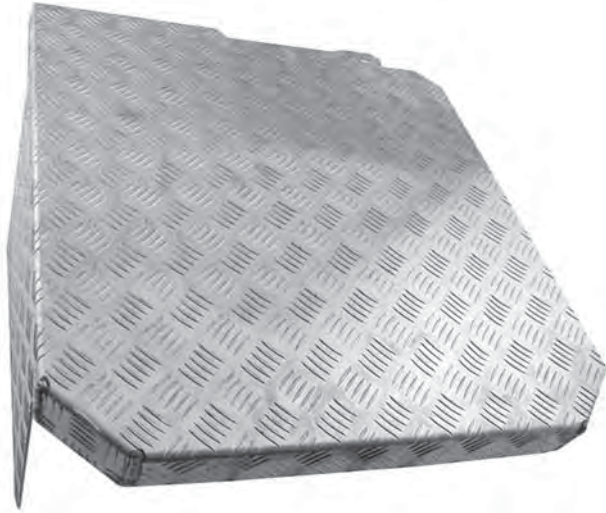

- Model
- ★ Application

	Code	OEM new	OEM old
	64007	1722828	

- 4 TRUCK

- ★ D9/ 11/ 12 CH 1290985 - CH 4499486 - CH 9082897 - CH 3542832 - CR GRSH900/ GRSH900R CH 1240717 - CH 4393474 - CH 9033049 - D16 CH 2002334 - CH 5106747 - CH 9092531 - CH 3560650

ALL THE COMPONENTS LISTED IN OUR CATALOGUE ARE NOT ORIGINAL, THOUGH PERFECTLY INTERCHANGEABLE. REFERENCE NUMBERS, EITHER ORIGINAL OR OF A DIFFERENT NATURE, ARE FOR INFORMATION PURPOSES ONLY WHEN PLACING AN ORDER, PLEASE, ALWAYS USE COSIBO REFERENCE NUMBERS AND DO NOT MENTION THE ORIGINAL REFERENCE NUMBERS OF THE TRUCK MANUFACTURERS IN THE INVOICE TO VEHICLE OWNERS OR TO ANYBODY ELSE. THE CUSTOMER TAKES HIS OWN RESPONSIBILITY IF HE DOES NOT COMPLY WITH WHAT ABOVE.

	Code	OEM new	OEM old
CLAMP D.6	64082	813933	
● Model			
★ Application			
● 3 BUS			
★			
● 4 BUS			
★			
● F-K-N BUS			
★			
● IND. MARINE ENGINE 4			
★			
● 3 TRUCK			
★			
● 4 TRUCK			
★			
● P-G-R-T TRUCK			
★			



CLAMP D.10	64083	813935	
● 3 BUS			
★			
● F-K-N BUS			
★			
● IND. MARINE ENGINE 4			
★			
● 3 TRUCK			
★			
● P-G-R-T TRUCK			
★			



ALL THE COMPONENTS LISTED IN OUR CATALOGUE ARE NOT ORIGINAL, THOUGH PERFECTLY INTERCHANGEABLE. REFERENCE NUMBERS, EITHER ORIGINAL OR OF A DIFFERENT NATURE, ARE FOR INFORMATION PURPOSES ONLY WHEN PLACING AN ORDER, PLEASE, ALWAYS USE COSIBO REFERENCE NUMBERS AND DO NOT MENTION THE ORIGINAL REFERENCE NUMBERS OF THE TRUCK MANUFACTURERS IN THE INVOICE TO VEHICLE OWNERS OR TO ANYBODY ELSE. THE CUSTOMER TAKES HIS OWN RESPONSIBILITY IF HE DOES NOT COMPLY WITH WHAT ABOVE.

	Code	OEM new	OEM old
CLAMP D. 16	64084	813937	
● Model			
★ Application			
● 3 BUS			
★			
● 4 BUS			
★			
● F-K-N BUS			
★			
● IND. MARINE ENGINE 4			
★			
● IND. MARINE ENGINE 5			
★			
● 3 TRUCK			
★			
● 4 TRUCK			
★			
● P-G-R-T TRUCK			
★			



	64085	813939	
CLAMP D.20			
● 3 BUS			
★			
● 4 BUS			
★			
● F-K-N BUS			
★			
● IND. MARINE ENGINE 4			
★			
● IND. MARINE ENGINE 5			
★			
● 3 TRUCK			
★			
● 4 TRUCK			
★			



ALL THE COMPONENTS LISTED IN OUR CATALOGUE ARE NOT ORIGINAL, THOUGH PERFECTLY INTERCHANGEABLE. REFERENCE NUMBERS, EITHER ORIGINAL OR OF A DIFFERENT NATURE, ARE FOR INFORMATION PURPOSES ONLY WHEN PLACING AN ORDER, PLEASE, ALWAYS USE COSIBO REFERENCE NUMBERS AND DO NOT MENTION THE ORIGINAL REFERENCE NUMBERS OF THE TRUCK MANUFACTURERS IN THE INVOICE TO VEHICLE OWNERS OR TO ANYBODY ELSE. THE CUSTOMER TAKES HIS OWN RESPONSIBILITY IF HE DOES NOT COMPLY WITH WHAT ABOVE.

		Code	OEM new	OEM old
CLAMP D.25	● Model	64086	813941	
	★ Application			
	● 3 BUS			
	★			
	● 4 BUS			
	★			
	● F-K-N BUS			
	★			
	● IND. MARINE ENGINE 4			
	★			
● IND. MARINE ENGINE 5				
★				



CLAMP D.5		64089	813932	
	● 3 BUS			
	★			
	● IND. MARINE ENGINE 4			
	★			
	● 3 TRUCK			
	★			
	● 4 TRUCK			
	★			



ALL THE COMPONENTS LISTED IN OUR CATALOGUE ARE NOT ORIGINAL, THOUGH PERFECTLY INTERCHANGEABLE. REFERENCE NUMBERS, EITHER ORIGINAL OR OF A DIFFERENT NATURE, ARE FOR INFORMATION PURPOSES ONLY WHEN PLACING AN ORDER, PLEASE, ALWAYS USE COSIBO REFERENCE NUMBERS AND DO NOT MENTION THE ORIGINAL REFERENCE NUMBERS OF THE TRUCK MANUFACTURERS IN THE INVOICE TO VEHICLE OWNERS OR TO ANYBODY ELSE. THE CUSTOMER TAKES HIS OWN RESPONSIBILITY IF HE DOES NOT COMPLY WITH WHAT ABOVE.

	Code	OEM new	OEM old
CLAMP D.8	64090	813934	
● Model			
★ Application			
● 3 BUS			
★			
● 4 BUS			
★			
● F-K-N BUS			
★			
● IND. MARINE ENGINE 4			
★			
● 3 TRUCK			
★			
● 4 TRUCK			
★			
● P-G-R-T TRUCK			
★			



	Code	OEM new	OEM old
CLAMP D.13	64091	813936	
● 3 BUS			
★			
● 4 BUS			
★			
● F-K-N BUS			
★			
● IND. MARINE ENGINE 4			
★			
● IND. MARINE ENGINE 5			
★			
● 3 TRUCK			
★			
● 4 TRUCK			
★			
● P-G-R-T TRUCK			
★			



ALL THE COMPONENTS LISTED IN OUR CATALOGUE ARE NOT ORIGINAL, THOUGH PERFECTLY INTERCHANGEABLE. REFERENCE NUMBERS, EITHER ORIGINAL OR OF A DIFFERENT NATURE, ARE FOR INFORMATION PURPOSES ONLY WHEN PLACING AN ORDER, PLEASE, ALWAYS USE COSIBO REFERENCE NUMBERS AND DO NOT MENTION THE ORIGINAL REFERENCE NUMBERS OF THE TRUCK MANUFACTURERS IN THE INVOICE TO VEHICLE OWNERS OR TO ANYBODY ELSE. THE CUSTOMER TAKES HIS OWN RESPONSIBILITY IF HE DOES NOT COMPLY WITH WHAT ABOVE.

	Code	OEM new	OEM old
CLAMP D.18	64092	813938	
● Model			
★ Application			
● 3 BUS			
★			
● F-K-N BUS			
★			
● IND. MARINE ENGINE 4			
★			
● 3 TRUCK			
★			
● 4 TRUCK			
★			





CLAMP D.22	64093	813940	
● 3 BUS			
★			
● IND. MARINE ENGINE 4			
★			
● 3 TRUCK			
★			



CLAMP D. 45	64094	813942	
● 3 BUS			
★			
● 4 BUS			
★			
● F-K-N BUS			
★			
● IND. MARINE ENGINE 5			
★			
● 3 TRUCK			
★			



ALL THE COMPONENTS LISTED IN OUR CATALOGUE ARE NOT ORIGINAL, THOUGH PERFECTLY INTERCHANGEABLE. REFERENCE NUMBERS, EITHER ORIGINAL OR OF A DIFFERENT NATURE, ARE FOR INFORMATION PURPOSES ONLY WHEN PLACING AN ORDER, PLEASE, ALWAYS USE COSIBO REFERENCE NUMBERS AND DO NOT MENTION THE ORIGINAL REFERENCE NUMBERS OF THE TRUCK MANUFACTURERS IN THE INVOICE TO VEHICLE OWNERS OR TO ANYBODY ELSE. THE CUSTOMER TAKES HIS OWN RESPONSIBILITY IF HE DOES NOT COMPLY WITH WHAT ABOVE.

	Code	OEM new	OEM old
CLAMP D.28 	64095	804578	
<ul style="list-style-type: none"> ● Model ★ Application 			
<ul style="list-style-type: none"> ● 3 BUS ★ 			
<ul style="list-style-type: none"> ● 4 BUS ★ 			
CLAMP D.35 	64096	804589	
<ul style="list-style-type: none"> ● 3 BUS ★ 			
<ul style="list-style-type: none"> ● IND. MARINE ENGINE 4 ★ 			
<ul style="list-style-type: none"> ● 3 TRUCK ★ 			
<ul style="list-style-type: none"> ● 4 TRUCK ★ 			
CLAMP D.32 	64100	804583	
<ul style="list-style-type: none"> ● 3 BUS ★ 			
<ul style="list-style-type: none"> ● 4 BUS ★ 			
<ul style="list-style-type: none"> ● F-K-N BUS ★ 			
<ul style="list-style-type: none"> ● IND. MARINE ENGINE 4 ★ 			
<ul style="list-style-type: none"> ● 3 TRUCK ★ 			
<ul style="list-style-type: none"> ● 4 TRUCK ★ 			
<ul style="list-style-type: none"> ● P-G-R-T TRUCK ★ 			

ALL THE COMPONENTS LISTED IN OUR CATALOGUE ARE NOT ORIGINAL, THOUGH PERFECTLY INTERCHANGEABLE. REFERENCE NUMBERS, EITHER ORIGINAL OR OF A DIFFERENT NATURE, ARE FOR INFORMATION PURPOSES ONLY WHEN PLACING AN ORDER, PLEASE, ALWAYS USE COSIBO REFERENCE NUMBERS AND DO NOT MENTION THE ORIGINAL REFERENCE NUMBERS OF THE TRUCK MANUFACTURERS IN THE INVOICE TO VEHICLE OWNERS OR TO ANYBODY ELSE. THE CUSTOMER TAKES HIS OWN RESPONSIBILITY IF HE DOES NOT COMPLY WITH WHAT ABOVE.

	Code	OEM new	OEM old
CLAMP D.38	64101	804591	
● Model			
★ Application			
● 3 BUS			
★			
● 4 BUS			
★			
● F-K-N BUS			
★			
● IND. MARINE ENGINE 4			
★			
● 3 TRUCK			
★			
● 4 TRUCK			
★			



ALL THE COMPONENTS LISTED IN OUR CATALOGUE ARE NOT ORIGINAL, THOUGH PERFECTLY INTERCHANGEABLE. REFERENCE NUMBERS, EITHER ORIGINAL OR OF A DIFFERENT NATURE, ARE FOR INFORMATION PURPOSES ONLY WHEN PLACING AN ORDER, PLEASE, ALWAYS USE COSIBO REFERENCE NUMBERS AND DO NOT MENTION THE ORIGINAL REFERENCE NUMBERS OF THE TRUCK MANUFACTURERS IN THE INVOICE TO VEHICLE OWNERS OR TO ANYBODY ELSE. THE CUSTOMER TAKES HIS OWN RESPONSIBILITY IF HE DOES NOT COMPLY WITH WHAT ABOVE.

HYDRAULIC RELEASE BEARING



- Model
- ★ Application

Code	OEM new	OEM old
60155	1522377	1393332 1434649 1455730

- **4 BUS**
- ★ K432 15/ 16/ 17 CH 1835919 - CH 3511088 - CH 1843282 - K432 18 CH 3511088 - CH 3511089 - K432 16 CH 1835920 - CH 3511089 - CH 1843283 - K432 15/ 17 CH 1835920 - CH 3511089 - CH 1843283
- **4 TRUCK**
- ★ K432 15/17 CH 1251352 - CH 4414948 - CH 9043609 - CH 3510913 - K402 5 - K432 16 - K442 3 CH 1251352 - CH 4414948 - CH 9043610 - K442 3 K432 15/17 LHD CH 1251353 - 1274125 - CH 4414949 - 4459238 - CH 9043610 - 9064687 - CH 3510914 - K432 19 LHD CH 1274125 - CH 4459238 - CH 9064687 - K432 15/17/19 RHD - K442 3 RHD CH 1265045 - CH 4440645 - CH 9056589 - K432 19 RHD CH 1265044 - CH 4440644 - CH 9056588 - K432 15/17 RHD - K442 3 RHD CH 1251353 - 1265044 - CH 4414949 - 4440644 - CH 9043610 - 9056588 - CH 3510914 - K432 15/17 LHD - K432 19 LHD - K442 3 LHD CH 1274126 - CH 4459239 - CH 9064688

CLUTCH SERVO



60807	360719	
--------------	--------	--

- **2 TRUCK**
- ★

CLUTCH SERVO





60808	1747895	1331770 371612
--------------	---------	-------------------

- **3 BUS**
- ★
- **3 TRUCK**
- ★ CG/CP/CR/CT 93/113 - CP/CR 113 GR/GRS/GRH900 - 93

ALL THE COMPONENTS LISTED IN OUR CATALOGUE ARE NOT ORIGINAL, THOUGH PERFECTLY INTERCHANGEABLE. REFERENCE NUMBERS, EITHER ORIGINAL OR OF A DIFFERENT NATURE, ARE FOR INFORMATION PURPOSES ONLY WHEN PLACING AN ORDER, PLEASE, ALWAYS USE COSIBO REFERENCE NUMBERS AND DO NOT MENTION THE ORIGINAL REFERENCE NUMBERS OF THE TRUCK MANUFACTURERS IN THE INVOICE TO VEHICLE OWNERS OR TO ANYBODY ELSE. THE CUSTOMER TAKES HIS OWN RESPONSIBILITY IF HE DOES NOT COMPLY WITH WHAT ABOVE.

		Code	OEM new	OEM old
CLUTCH SERVO	● Model	62089	1747894	298953 338923 360717
	★ Application			
	● 2 TRUCK			
	★			
	● 3 TRUCK			
	★			

CLUTCH SERVOMASTER		62012	1513717	1367453 1421186 1454590 1469161
	● 4 BUS			
	★ K402 5 - K432 15/16/17/18/30/31/32/34 - F94			
	● F-K-N BUS			
	★			
	● 4 TRUCK			
	★ K432 30/31/32/33 - CH 1291370 - CH 4499183 - CH 9082800 - CH 3543610 - CP/CR/CT CH 1251352 - CH 4414948 - CH 9043609 - CH 3512914 - K432 15/16/17/19 - K442 3 CH 1251353 - 1291369 - CH 4414949 - 4499182 - CH 9043610 - 9082799 - CH 3512915 - 3543609 - K432 13 CH 1251353 - 1277406 - CH 1277407 - CH 4414949 - 4465078 - CH 4465079 - CH 9043610 - 9067200 - CH 9067201 - CH 3512915 - 3531785 - CH 3531786			
	● P-G-R-T TRUCK			
	★			

TWO WAY CONTROL VALVE REPAIR SET		60799	550446	
	● 1 TRUCK			
	★ 110 - 111 - 140 - 141			
	● 2 TRUCK			
	★ 112 - 142			

ALL THE COMPONENTS LISTED IN OUR CATALOGUE ARE NOT ORIGINAL, THOUGH PERFECTLY INTERCHANGEABLE. REFERENCE NUMBERS, EITHER ORIGINAL OR OF A DIFFERENT NATURE, ARE FOR INFORMATION PURPOSES ONLY WHEN PLACING AN ORDER, PLEASE, ALWAYS USE COSIBO REFERENCE NUMBERS AND DO NOT MENTION THE ORIGINAL REFERENCE NUMBERS OF THE TRUCK MANUFACTURERS IN THE INVOICE TO VEHICLE OWNERS OR TO ANYBODY ELSE. THE CUSTOMER TAKES HIS OWN RESPONSIBILITY IF HE DOES NOT COMPLY WITH WHAT ABOVE.

		Code	OEM new	OEM old
CLUTCH CYLINDER	● Model	61961	1361136	1105332
	★ Application			
	● 3 BUS			
	★ 93/113/143 - F93/113			
	● 3 TRUCK			
	★ 93/113/143 - F93/113 - GR801R - GRS890R - GR/GRS900R			

		63885	1754943	1545626
CLUTCH CYLINDER	● 4 BUS			
	★ K432 30/31/32/33 CH 1847532 - CH 1847533 - CH 3548918 - CH 3548919 - K432 34			
	● F-K-N BUS			
	★ K432 37/38			
	● 4 TRUCK			
	★ K432 34 - K432 30/31/32/33 CH 1294477 - CH 1294478 - CH 4509371 - CH 4509372 - CH 9087193 - CH 9087194 - CH 3548918 - CH 3548919			
	● P-G-R-T TRUCK			
	★ K432 20/26/27/33/35/36/37/38/39/54/55			

		64122	1756460	1355979 1532517
ALUMINIUM CLUTCH CYLINDER	● 4 BUS			
	★ K432 8			
	● 3 TRUCK			
	★ K432 13 - EK330/340/630/640 CH 1217686 - CH 1294476 - CH 1294477 - CH 4357445 - 4509371 - CH 4509372 - CH 9087192 - CH 9087193 - CH 3548818 - CH 3548819 - K402 4 - EK330/340/630/640 CH 1217686 - CH 4357445			
	● 4 TRUCK			
	★ K432 13 - EK330/340/630/640 CH 1217686 - CH 1294476 - CH 1294477 - CH 4357445 - 4509371 - CH 4509372 - CH 9087192 - CH 9087193 - CH 3548818 - CH 3548819 - K402 4 - EK330/340/630/640 CH 1217686 - CH 4357445 - K432 13 - EK300/310 CH 1294476 - CH 1294477 - CH 4509371 - CH 4509372 - CH 9087192 - CH 9087193 - CH 3548818 - CH 3548819 - K432 43 - EK330/340/630/640 - K402 4 - EK300/310			
	● P-G-R-T TRUCK			
	★ K432 25/46 - EK630/640			

ALL THE COMPONENTS LISTED IN OUR CATALOGUE ARE NOT ORIGINAL, THOUGH PERFECTLY INTERCHANGEABLE. REFERENCE NUMBERS, EITHER ORIGINAL OR OF A DIFFERENT NATURE, ARE FOR INFORMATION PURPOSES ONLY WHEN PLACING AN ORDER, PLEASE, ALWAYS USE COSIBO REFERENCE NUMBERS AND DO NOT MENTION THE ORIGINAL REFERENCE NUMBERS OF THE TRUCK MANUFACTURERS IN THE INVOICE TO VEHICLE OWNERS OR TO ANYBODY ELSE. THE CUSTOMER TAKES HIS OWN RESPONSIBILITY IF HE DOES NOT COMPLY WITH WHAT ABOVE.

	Code	OEM new	OEM old
CLUTCH SERVO REPAIR KIT	60426	550453	550421 550422 550437
<ul style="list-style-type: none"> ● Model ★ Application 			
<ul style="list-style-type: none"> ● 2 TRUCK ★ FOR OUR 62089 			
<ul style="list-style-type: none"> ● 3 TRUCK ★ FOR OUR 62089 			

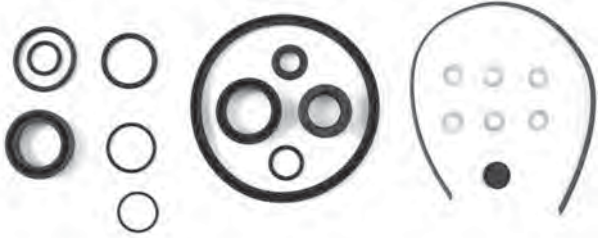

CLUTCH SERVO REPAIR KIT	60810	1336159	550455 550465
<ul style="list-style-type: none"> ● 3 BUS ★ FOR OUR 60808 			
<ul style="list-style-type: none"> ● 3 TRUCK ★ FOR OUR 60808 			



CLUTCH CYLINDER REPAIR KIT	62013	550464	550458 550562
<ul style="list-style-type: none"> ● 3 BUS ★ FOR OUR 61961 			
<ul style="list-style-type: none"> ● 3 TRUCK ★ FOR OUR 61961 			



ALL THE COMPONENTS LISTED IN OUR CATALOGUE ARE NOT ORIGINAL, THOUGH PERFECTLY INTERCHANGEABLE. REFERENCE NUMBERS, EITHER ORIGINAL OR OF A DIFFERENT NATURE, ARE FOR INFORMATION PURPOSES ONLY WHEN PLACING AN ORDER, PLEASE, ALWAYS USE COSIBO REFERENCE NUMBERS AND DO NOT MENTION THE ORIGINAL REFERENCE NUMBERS OF THE TRUCK MANUFACTURERS IN THE INVOICE TO VEHICLE OWNERS OR TO ANYBODY ELSE. THE CUSTOMER TAKES HIS OWN RESPONSIBILITY IF HE DOES NOT COMPLY WITH WHAT ABOVE.

	Code	OEM new	OEM old
PEDAL RUBBER COVER	65177	389035	293152
● Model			
★ Application			
● 3 BUS			
★ CAG/CS - F93/113 - K93/113 - L113			
● 4 BUS			
★ K IM - K94/114/124 - L94 - F94			
● 3 TRUCK			
★ CG/CP 93/113 - CR/CT 93/113/143 - CP/CR 113			
● 4 TRUCK			
★ CP/CR/CT GR/GRS			



	65178	1409551	1391676
SPRING			
● 3 BUS			
★ F 93/113			
● 4 BUS			
★ K94 IB - K94/114/124 - F/L94			
● 3 TRUCK			
★ CG/CP/CR 93/113 - CR/CT 93/113/143			
● 4 TRUCK			
★ CR/GRS			



	61344	1120884	338692
SERVO CLUTCH FORK L=95 mm WITH NUT			
● 2 TRUCK			
★ 112 - 142			
● 3 TRUCK			
★ 113 - 143			



ALL THE COMPONENTS LISTED IN OUR CATALOGUE ARE NOT ORIGINAL, THOUGH PERFECTLY INTERCHANGEABLE. REFERENCE NUMBERS, EITHER ORIGINAL OR OF A DIFFERENT NATURE, ARE FOR INFORMATION PURPOSES ONLY WHEN PLACING AN ORDER, PLEASE, ALWAYS USE COSIBO REFERENCE NUMBERS AND DO NOT MENTION THE ORIGINAL REFERENCE NUMBERS OF THE TRUCK MANUFACTURERS IN THE INVOICE TO VEHICLE OWNERS OR TO ANYBODY ELSE. THE CUSTOMER TAKES HIS OWN RESPONSIBILITY IF HE DOES NOT COMPLY WITH WHAT ABOVE.

SERVO CLUTCH FORK L= 110 WITH NUT



- Model
- ★ Application

Code

OEM new

OEM old

61493

1120880

- 2 TRUCK

- ★ 112 - 142

SERVO CLUTCH FORK L= 220 mm WITH NUT



- 3 BUS

- ★ F/K 93/113 - L 113

- 3 TRUCK

- ★ CG/CP/CR/CT 93/113

61350

1120881

345360

PIN



- 2 TRUCK

- ★ 142

- 3 BUS

- ★ F/K 93/113 - L 113

- 3 TRUCK

- ★ CG/CP/CR/CT 93/113 - CR/CT 143

61352

808214

BUSHING



- 3 BUS

- ★ F/K 93/113 - L113

- 3 TRUCK

- ★ CG/CP/CR/CT 93/113 - CR/CT 143

65179

283650

ALL THE COMPONENTS LISTED IN OUR CATALOGUE ARE NOT ORIGINAL, THOUGH PERFECTLY INTERCHANGEABLE. REFERENCE NUMBERS, EITHER ORIGINAL OR OF A DIFFERENT NATURE, ARE FOR INFORMATION PURPOSES ONLY WHEN PLACING AN ORDER, PLEASE, ALWAYS USE COSIBO REFERENCE NUMBERS AND DO NOT MENTION THE ORIGINAL REFERENCE NUMBERS OF THE TRUCK MANUFACTURERS IN THE INVOICE TO VEHICLE OWNERS OR TO ANYBODY ELSE. THE CUSTOMER TAKES HIS OWN RESPONSIBILITY IF HE DOES NOT COMPLY WITH WHAT ABOVE.

	Code	OEM new	OEM old
FLEXIBLE HOSE	60597	306278	
<ul style="list-style-type: none"> ● Model ★ Application 			
<ul style="list-style-type: none"> ● 3 BUS 			
<ul style="list-style-type: none"> ★ K 93/113 GS771/772 GR801 - L 113 			
<ul style="list-style-type: none"> ● 3 TRUCK 			
<ul style="list-style-type: none"> ★ CG/CP/CR/CT 93/113/143 - AMA56/61 - CP/CR 113/143 GRH880/900 			



FLEXIBLE HOSE	63567	1340408	
<ul style="list-style-type: none"> ● 3 TRUCK 			
<ul style="list-style-type: none"> ★ CG/CP/CR/CT 93/113/143 			



ALL THE COMPONENTS LISTED IN OUR CATALOGUE ARE NOT ORIGINAL, THOUGH PERFECTLY INTERCHANGEABLE. REFERENCE NUMBERS, EITHER ORIGINAL OR OF A DIFFERENT NATURE, ARE FOR INFORMATION PURPOSES ONLY WHEN PLACING AN ORDER, PLEASE, ALWAYS USE COSIBO REFERENCE NUMBERS AND DO NOT MENTION THE ORIGINAL REFERENCE NUMBERS OF THE TRUCK MANUFACTURERS IN THE INVOICE TO VEHICLE OWNERS OR TO ANYBODY ELSE. THE CUSTOMER TAKES HIS OWN RESPONSIBILITY IF HE DOES NOT COMPLY WITH WHAT ABOVE.

GEARBOX OIL PUMP



	Code	OEM new	OEM old
● Model	61341	194838	
★ Application			
● 3 BUS			
★ K432 3 - K422 9 - GS771			
● 3 TRUCK			
★ K432 3/5/6/9 - K422 8/9 - EK422 - K442 1			

SLEEVE



	61764	1103619	
● 3 BUS			
★ K432 3 - K422 9 - GS771			
● 3 TRUCK			
★ K432 5/6 - K442 1			

SLEEVE



	62461	1103934	
● 3 BUS			
★ K402 3 GR801 - K432 14 GR801			
● 4 BUS			
★ K432 8			
● 3 TRUCK			
★ K402 3 GR801 - GR/GRS900 - K432 7/8/10/14 GR/GRS900 - K432 8 DTC11 GR/GRS900 - K442 2 GRH900			

ALL THE COMPONENTS LISTED IN OUR CATALOGUE ARE NOT ORIGINAL, THOUGH PERFECTLY INTERCHANGEABLE. REFERENCE NUMBERS, EITHER ORIGINAL OR OF A DIFFERENT NATURE, ARE FOR INFORMATION PURPOSES ONLY WHEN PLACING AN ORDER, PLEASE, ALWAYS USE COSIBO REFERENCE NUMBERS AND DO NOT MENTION THE ORIGINAL REFERENCE NUMBERS OF THE TRUCK MANUFACTURERS IN THE INVOICE TO VEHICLE OWNERS OR TO ANYBODY ELSE. THE CUSTOMER TAKES HIS OWN RESPONSIBILITY IF HE DOES NOT COMPLY WITH WHAT ABOVE.

CLUTCH RELEASE BEARING INT. DIAM. = 45 mm



	Code	OEM new	OEM old
● Model	60794	342832	294999
★ Application			
● 2 TRUCK			
★ 112/142 1st series			

CLUTCH RELEASE BEARING INT. DIAM. = 45 mm



	Code	OEM new	OEM old
	60795	342833	304305
● 2 TRUCK			
★ 112 G770 VLX 6020030/6020031 - GS770 VLX 6120939 - GS771/772 VLX 6800460/6800461 - GR870 VLX 6296900 - GR871			

CLUTCH RELEASE BEARING INT. DIAM = 60 mm



	Code	OEM new	OEM old
	60798	397956	352745
● 2 TRUCK			
★ 112/142 2nd series			

ALL THE COMPONENTS LISTED IN OUR CATALOGUE ARE NOT ORIGINAL, THOUGH PERFECTLY INTERCHANGEABLE. REFERENCE NUMBERS, EITHER ORIGINAL OR OF A DIFFERENT NATURE, ARE FOR INFORMATION PURPOSES ONLY WHEN PLACING AN ORDER, PLEASE, ALWAYS USE COSIBO REFERENCE NUMBERS AND DO NOT MENTION THE ORIGINAL REFERENCE NUMBERS OF THE TRUCK MANUFACTURERS IN THE INVOICE TO VEHICLE OWNERS OR TO ANYBODY ELSE. THE CUSTOMER TAKES HIS OWN RESPONSIBILITY IF HE DOES NOT COMPLY WITH WHAT ABOVE.

CLUTCH RELEASE BEARING INT. DIAM. = 70 mm



	Code	OEM new	OEM old
● Model	60789	1367604	352750
★ Application			
● 3 BUS			
★ K422 12 GR801			
● 3 TRUCK			
★ K422 9 - K422 12 GR801 - K422 9 CAG - K432 3/9			

CLUTCH RELEASE BEARING PRESSURE PLATE



	60974	304309	
● 2 TRUCK			
★ 112/142 1st series FOR OUR 60974			

CLUTCH RELEASE BEARING PRESSURE PLATE



	60975	362778	352722
● 2 TRUCK			
★ 112 G770 VLX 6020030/6020031 - GS770 VLX 6120939 - GS771/772 VLX 6800460/6800461 - GR870 VLX 6296900 - GR871 - FOR OUR 60789 & 60795			
● 3 TRUCK			
★ K422 12 GR801 - K422 9 CAG - GE 6806706 - K432 3/9 - K422 9 - FOR OUR 60789 & 60795			
● 3 BUS			
★ K422 12 GR801 - K432 3 - K422 9 - GS771 - FOR OUR 60789 & 60795			

ALL THE COMPONENTS LISTED IN OUR CATALOGUE ARE NOT ORIGINAL, THOUGH PERFECTLY INTERCHANGEABLE. REFERENCE NUMBERS, EITHER ORIGINAL OR OF A DIFFERENT NATURE, ARE FOR INFORMATION PURPOSES ONLY WHEN PLACING AN ORDER, PLEASE, ALWAYS USE COSIBO REFERENCE NUMBERS AND DO NOT MENTION THE ORIGINAL REFERENCE NUMBERS OF THE TRUCK MANUFACTURERS IN THE INVOICE TO VEHICLE OWNERS OR TO ANYBODY ELSE. THE CUSTOMER TAKES HIS OWN RESPONSIBILITY IF HE DOES NOT COMPLY WITH WHAT ABOVE.

CLUTCH RELEASER BEARING



- Model
- ★ Application

Code	OEM new	OEM old
60790	1797431	1321260 1393163 382413 388053

- **3 TRUCK**
- ★ K432 6

CLUTCH RELEASE BEARING



- **3 BUS**
- ★ K402 1 - K402 3 GR801

63117	1545062	1393161
--------------	---------	---------

- **3 TRUCK**
- ★ K402 1 - K402 3 GR801 - GR/GRS900 - K432 7/8/10 GR/GRS900 - K432 8 DTC11 GR/GRS900 - K432 6/7/8
- **4 BUS**
- ★ K432 8

ALL THE COMPONENTS LISTED IN OUR CATALOGUE ARE NOT ORIGINAL, THOUGH PERFECTLY INTERCHANGEABLE. REFERENCE NUMBERS, EITHER ORIGINAL OR OF A DIFFERENT NATURE, ARE FOR INFORMATION PURPOSES ONLY WHEN PLACING AN ORDER, PLEASE, ALWAYS USE COSIBO REFERENCE NUMBERS AND DO NOT MENTION THE ORIGINAL REFERENCE NUMBERS OF THE TRUCK MANUFACTURERS IN THE INVOICE TO VEHICLE OWNERS OR TO ANYBODY ELSE. THE CUSTOMER TAKES HIS OWN RESPONSIBILITY IF HE DOES NOT COMPLY WITH WHAT ABOVE.

CLUTCH RELEASE BEARING



	Code	OEM new	OEM old
● Model	65331	1851631	1479576
★ Application			1499770
			1728165
			1749125

● P-G-R-T TRUCK
★ K432 20/26/27/33/35/36/37/38/39/48/54/55
● F-K-N BUS
★ K432 20/27/37/38
● 4 TRUCK
★ K432 30/31/32/33/34
● 4 BUS
★ K432 30/31/32/33/34

BEARING



	61856	1386452	
--	-------	---------	--

● 3 BUS
★ K402 1 - K402 3 GR801 - K432 14 GR801
● 3 TRUCK
★ K402 3 GR801 - GR/GRS900 - K432 7/8/10/14 GR/GRS900 - K432 8 DTC11 GR/GRS900 - K432 10
● 4 BUS
★ K432 8

BELL HOUSING REPAIR KIT



	64331	64331	
--	-------	-------	--

● 3 BUS
★ K402 1 - K402 3 GR801 - K432 14 GR801 - COMPOSED BY: 1 PC 63307 - 2 PCS 63308 - 1 PC 61856
● 3 TRUCK
★ K402 3 GR801 - GR/GRS900 - K432 7/8/10/14 GR/GRS900 - K432 8 DTC11 GR/GRS900 - K432 10 - COMPOSED BY: 1 PC 63307 - 2 PCS 63308 - 1 PC 61856
● 4 BUS
★ K432 8 - COMPOSED BY: 1 PC 63307 - 2 PCS 63308 - 1 PC 61856

ALL THE COMPONENTS LISTED IN OUR CATALOGUE ARE NOT ORIGINAL, THOUGH PERFECTLY INTERCHANGEABLE. REFERENCE NUMBERS, EITHER ORIGINAL OR OF A DIFFERENT NATURE, ARE FOR INFORMATION PURPOSES ONLY WHEN PLACING AN ORDER, PLEASE, ALWAYS USE COSIBO REFERENCE NUMBERS AND DO NOT MENTION THE ORIGINAL REFERENCE NUMBERS OF THE TRUCK MANUFACTURERS IN THE INVOICE TO VEHICLE OWNERS OR TO ANYBODY ELSE. THE CUSTOMER TAKES HIS OWN RESPONSIBILITY IF HE DOES NOT COMPLY WITH WHAT ABOVE.

		Code	OEM new	OEM old
GASKET	● Model	61366	1535698	224915
	★ Application			
	● 3 BUS			
	★	K432 3 - K422 9 - GS771		
● 3 TRUCK				
★	K432 3/5/6/9 - K422 8 EK422 - K422 9 - K442 1			



BOOT		62226	1308969	
	● 4 TRUCK			
	★	K432 13 EK300/310/330/340/630/640 - K402 4 EK300/310/330/340/630/640 - K432 43 EK330/340/630/640		
	● 3 TRUCK			
★	K432 13 EK330/340/630/640 - K402 4 EK330/340/630/640 - K402 4 - K422 13 - K432 13 EK330/340/630/640 - GR/GRS900 - K402 4 - K422 13 - K432 13 EK300/310 - GR/GRS900			
● P-G-R-T TRUCK				
★	K432 25/46 EK630/640			



BOOT		62227	1307793	
	● 3 BUS			
	★	K402 1 - K432 14 GR801		
	● 4 TRUCK			
★	K432 13 EK300/310/330/340/630/640 - K402 4 EK300/310/330/340/630/640 - K432 43 EK330/340/630/640			
● 3 TRUCK				
★	K432 13 EK330/340/630/640 - K402 4 EK330/340/630/640 - K402 1 - K432 5/6/10 - K422 8 EK422 - K432 7/8/10/14 GR/GRS900 - K402 4 - K422 13 - K432 13 EK300/310/330/340/630/640 - GR/GRS900 - K442 1 - K442 2 GRH900			
● P-G-R-T TRUCK				
★	K432 25/46 EK630/640			
● 4 BUS				
★	K432 8			



ALL THE COMPONENTS LISTED IN OUR CATALOGUE ARE NOT ORIGINAL, THOUGH PERFECTLY INTERCHANGEABLE. REFERENCE NUMBERS, EITHER ORIGINAL OR OF A DIFFERENT NATURE, ARE FOR INFORMATION PURPOSES ONLY WHEN PLACING AN ORDER, PLEASE, ALWAYS USE COSIBO REFERENCE NUMBERS AND DO NOT MENTION THE ORIGINAL REFERENCE NUMBERS OF THE TRUCK MANUFACTURERS IN THE INVOICE TO VEHICLE OWNERS OR TO ANYBODY ELSE. THE CUSTOMER TAKES HIS OWN RESPONSIBILITY IF HE DOES NOT COMPLY WITH WHAT ABOVE.

		Code	OEM new	OEM old
BUSHING	● Model	63307	1386453	
	★ Application			
	● 3 BUS			
	★ K402 1 - K402 3 GR801 - K432 14 GR801			
	● 3 TRUCK			
★ K402 3 GR801 - GR/GRS900 - K432 7/8/10/14 GR/GRS900 - K432 8 DTC11 GR/GRS900 - K432 10				
● 4 BUS				
★ K432 8				



		63308	1386454	
SEAL RING	● 3 BUS			
	★ K402 1 - K402 3 GR801 - K432 14 GR801			
	● 3 TRUCK			
	★ K402 3 GR801 - GR/GRS900 - K432 7/8/10/14 GR/GRS900 - K432 8 DTC11 GR/GRS900 - K432 10			
	● 4 BUS			
★ K432 8				



		65332	1749123	1444110
CLUTCH DISC	● 3 BUS			
	★ K432 14 - K432 10			
	● 4 BUS			
	★ K432 30 - K432 31 - K432 32 - K432 15 - K432 16 - K432 17 - K432 8			
	● 3 TRUCK			
	★ K432 7/ 8 - K432 10 - K432 13 - EK300/ 310/ 330/ 340/ 630/ 640 CH 1217685 - CH 4357444 - K432 14 - K432 13 - EK330/ 340/ 630/ 640 CH 1217686 - CH 4357445			
	● 4 TRUCK			
★ K432 30 - K432 31 - K432 32 - K432 15 - K432 16 - K432 17 - K432 13				



ALL THE COMPONENTS LISTED IN OUR CATALOGUE ARE NOT ORIGINAL, THOUGH PERFECTLY INTERCHANGEABLE. REFERENCE NUMBERS, EITHER ORIGINAL OR OF A DIFFERENT NATURE, ARE FOR INFORMATION PURPOSES ONLY WHEN PLACING AN ORDER, PLEASE, ALWAYS USE COSIBO REFERENCE NUMBERS AND DO NOT MENTION THE ORIGINAL REFERENCE NUMBERS OF THE TRUCK MANUFACTURERS IN THE INVOICE TO VEHICLE OWNERS OR TO ANYBODY ELSE. THE CUSTOMER TAKES HIS OWN RESPONSIBILITY IF HE DOES NOT COMPLY WITH WHAT ABOVE.

CLUTCH COVER



	Code	OEM new	OEM old
● Model	65368	1513719	1513720
★ Application			
● 4 BUS			
★ K432 30/31/32/34			
● F-K-N BUS			
★ K432 35			
● 4 TRUCK			
★ K432 30/31/32/34			

CLUTCH DISK+COVER



	65379	1929397+ 1382331	
● 4 BUS			
★ K432 16/18			
● 4 TRUCK			
★ K432 16			

ALL THE COMPONENTS LISTED IN OUR CATALOGUE ARE NOT ORIGINAL, THOUGH PERFECTLY INTERCHANGEABLE. REFERENCE NUMBERS, EITHER ORIGINAL OR OF A DIFFERENT NATURE, ARE FOR INFORMATION PURPOSES ONLY WHEN PLACING AN ORDER, PLEASE, ALWAYS USE COSIBO REFERENCE NUMBERS AND DO NOT MENTION THE ORIGINAL REFERENCE NUMBERS OF THE TRUCK MANUFACTURERS IN THE INVOICE TO VEHICLE OWNERS OR TO ANYBODY ELSE. THE CUSTOMER TAKES HIS OWN RESPONSIBILITY IF HE DOES NOT COMPLY WITH WHAT ABOVE.

CLUTCH COVER



	Code	OEM new	OEM old
● Model	61866	1321259	
★ Application			
● 3 TRUCK			
★ K432 6/7/8			
● 4 BUS			
★ K432 8/15/17			
● 4 TRUCK			
★ K432 15/17			

CLUTCH MOUNTING KIT



	63846	1341683	
● 3 BUS			
★ K402 1/3 - K432 18			
● 4 BUS			
★ K402 5 - K432 8/15/16/17/18			
● 3 TRUCK			
★ K402 1/3 - K432 6/7/8			
● 4 TRUCK			
★ K402 5 - K432 15/16/17/19 - K442 3			

ALL THE COMPONENTS LISTED IN OUR CATALOGUE ARE NOT ORIGINAL, THOUGH PERFECTLY INTERCHANGEABLE. REFERENCE NUMBERS, EITHER ORIGINAL OR OF A DIFFERENT NATURE, ARE FOR INFORMATION PURPOSES ONLY WHEN PLACING AN ORDER, PLEASE, ALWAYS USE COSIBO REFERENCE NUMBERS AND DO NOT MENTION THE ORIGINAL REFERENCE NUMBERS OF THE TRUCK MANUFACTURERS IN THE INVOICE TO VEHICLE OWNERS OR TO ANYBODY ELSE. THE CUSTOMER TAKES HIS OWN RESPONSIBILITY IF HE DOES NOT COMPLY WITH WHAT ABOVE.

GEARBOX LEVER



	Code	OEM new	OEM old
● Model	64246	1737306	1545625
★ Application			
● 4 BUS			
★ K432 30/31/32/33/34			
● F-K-N BUS			
★ K432 37/38			
● 4 TRUCK			
★ K432 30/31/32/33/34			
● P-G-R-T TRUCK			
★ K432 20/26/27/33/35/36/37/38/39/54/55			

RELEASE LEVER REPAIR KIT



	64340	64340	
● 4 BUS			
★ K432 30/31/32/33/34 FOR OUR 64246			
● F-K-N BUS			
★ K432 37/38 FOR OUR 64246			
● 4 TRUCK			
★ K432 30/31/32/33/34 FOR OUR 64246			
● P-G-R-T TRUCK			
★ K432 20/26/27/33/35/36/37/38/39/54/55 FOR OUR 64246			

RELEASE ROLLER BEARING



	62014	355708	
● 3 BUS			
★ K402 3 GR801 - K432 14 GR801 - K432 10			
● 3 TRUCK			
★ K432 5/13 - EK330/340/422/630/640 - K402 4 - K422 8 - K402 4 - K422 13 - K432 13 - EK300/310/330/340/630/640 GR/GRS900			
● 4 TRUCK			
★ K432 13/43 - EK300/310/330/340/630/640 - K402 4			
● P-G-R-T TRUCK			
★ K432 25/46 - EK630/640			

ALL THE COMPONENTS LISTED IN OUR CATALOGUE ARE NOT ORIGINAL, THOUGH PERFECTLY INTERCHANGEABLE. REFERENCE NUMBERS, EITHER ORIGINAL OR OF A DIFFERENT NATURE, ARE FOR INFORMATION PURPOSES ONLY WHEN PLACING AN ORDER, PLEASE, ALWAYS USE COSIBO REFERENCE NUMBERS AND DO NOT MENTION THE ORIGINAL REFERENCE NUMBERS OF THE TRUCK MANUFACTURERS IN THE INVOICE TO VEHICLE OWNERS OR TO ANYBODY ELSE. THE CUSTOMER TAKES HIS OWN RESPONSIBILITY IF HE DOES NOT COMPLY WITH WHAT ABOVE.

RELEASE ROLLER BEARING



	Code	OEM new	OEM old
● Model	63569	1753479	1335485
★ Application			
● 3 BUS			
★	K402 1 - K402 3 GR801 - K432 14 GR801		
● 4 BUS			
★	K432 8/30/31/32/33/34		
● F-K-N BUS			
★	K432 20/27/37/38/50		
● 3 TRUCK			
★	K402 1 - K432 5/6/10/14 - K402 3 GR801 - GR/GRS900 - K432 7/8/10/14 GR/GRS900 - K442 1 - K432 8 DTC11 GR/GRS900 - K442 2 GRH900		
● 4 TRUCK			
★	K402 1 - K432 30/31/32/33/34		
● P-G-R-T TRUCK			
★	K432 20/26/27/33/35/36/37/38/39/48/54/55 - K392 1 - K432 40/41/42/49 PTO EK		

O-RING

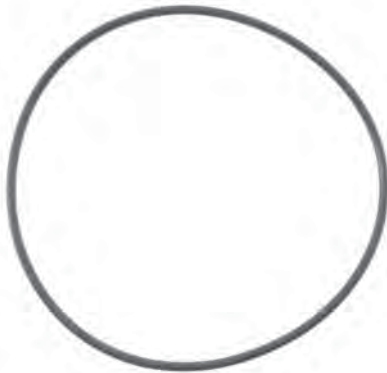

	61632	1312934	323641
● 3 BUS			
★	K113 - GA775/781R		

ALL THE COMPONENTS LISTED IN OUR CATALOGUE ARE NOT ORIGINAL, THOUGH PERFECTLY INTERCHANGEABLE. REFERENCE NUMBERS, EITHER ORIGINAL OR OF A DIFFERENT NATURE, ARE FOR INFORMATION PURPOSES ONLY WHEN PLACING AN ORDER, PLEASE, ALWAYS USE COSIBO REFERENCE NUMBERS AND DO NOT MENTION THE ORIGINAL REFERENCE NUMBERS OF THE TRUCK MANUFACTURERS IN THE INVOICE TO VEHICLE OWNERS OR TO ANYBODY ELSE. THE CUSTOMER TAKES HIS OWN RESPONSIBILITY IF HE DOES NOT COMPLY WITH WHAT ABOVE.

OIL SEAL 55x75x9



	Code	OEM new	OEM old
● Model	63128	1318388	
★ Application			
● 4 BUS			
★ K432 30/31/32/33/34			
● F-K-N BUS			
★ K432 37/38			
● 4 TRUCK			
★ K432 30/31/32/33/34			
● P-G-R-T TRUCK			
★ K432 20/26/27/33/35/36/37/38/39/54/55			

RUBBER COVER



	64097	1379922	
● 3 BUS			
★ K422 12 - GR801 - K402 1/3 - K432 3/10/14 - K422 9 - F93/113 - GS771			
● 4 BUS			
★ K432 8/15/16/17/18/30/31/32/33/34			
● F-K-N BUS			
★ K432 37/38			
● 3 TRUCK			
★ K401 1 - K421 - K422 8/9/12 - EK422 - K432 3/6/9 - K402 3 GR801 GR/GRS900 - K432 7/8/10/14 GR/GRS900 - K442 1 - K442 2 GRH900 - K432 8 DTC11 GR/GRS900 - K402 4 - K422 13 - K432 13 - EK300/310 GR/GRS900 - K432 10			
● 4 TRUCK			
★ K402 4/5 - K300/301 - K432 13 - EK300/301 - K432 15/16/17/30/31/32/33/34 - K442 3 - K442 3 LHD/RHD - K432 15/17/19 LHD/RHD			
● P-G-R-T TRUCK			
★ K432 20/26/27/33/35/36/37/38/39/54/55			

ALL THE COMPONENTS LISTED IN OUR CATALOGUE ARE NOT ORIGINAL, THOUGH PERFECTLY INTERCHANGEABLE. REFERENCE NUMBERS, EITHER ORIGINAL OR OF A DIFFERENT NATURE, ARE FOR INFORMATION PURPOSES ONLY WHEN PLACING AN ORDER, PLEASE, ALWAYS USE COSIBO REFERENCE NUMBERS AND DO NOT MENTION THE ORIGINAL REFERENCE NUMBERS OF THE TRUCK MANUFACTURERS IN THE INVOICE TO VEHICLE OWNERS OR TO ANYBODY ELSE. THE CUSTOMER TAKES HIS OWN RESPONSIBILITY IF HE DOES NOT COMPLY WITH WHAT ABOVE.

RUBBER COVER



● Model
★ Application

Code

OEM new

OEM old

64098

1302914

● 4 BUS

★ K432 15/16/17

● 3 TRUCK

★ K432 3/9 - K422 9

● 4 TRUCK

★ K402 5 - K432 15/17/19 LHD/RHD - K432 16 LHD - K442 3 LHD/RHD

ALL THE COMPONENTS LISTED IN OUR CATALOGUE ARE NOT ORIGINAL, THOUGH PERFECTLY INTERCHANGEABLE. REFERENCE NUMBERS, EITHER ORIGINAL OR OF A DIFFERENT NATURE, ARE FOR INFORMATION PURPOSES ONLY WHEN PLACING AN ORDER, PLEASE, ALWAYS USE COSIBO REFERENCE NUMBERS AND DO NOT MENTION THE ORIGINAL REFERENCE NUMBERS OF THE TRUCK MANUFACTURERS IN THE INVOICE TO VEHICLE OWNERS OR TO ANYBODY ELSE. THE CUSTOMER TAKES HIS OWN RESPONSIBILITY IF HE DOES NOT COMPLY WITH WHAT ABOVE.

RUBBER BUFFER



● Model

★ Application

Code

OEM new

OEM old

63929

1388070

● F-K-N BUS

★ DC9/11/12 GR875R - GRS895R - GR/GRS/GRSO905R - K GR875 - K UD

● 4 TRUCK

★ DC14 GRS/GRSH/900R - DC11 01/04/06/07 - DC12 GRS890R - GR/GRS/GRSO/900R - DC11 74/75 - OSC11 G03 GRS890R - GR/GRS/GRSO900R - DC9 GRS890R - GR/GRS/GRSO900R - GA851/852R - DC16 GRS/GRSO/900/920R

● P-G-R-T TRUCK

★ DC9/11/12/13/16 - GA750/760/850/860 - GA750/850/760/860R - GRS0H901R - DC9/11/12 GR875R - GRS895R - GR/GRS/GRSO905R - DC16 GRS895/905R - GRSO905R

ALL THE COMPONENTS LISTED IN OUR CATALOGUE ARE NOT ORIGINAL, THOUGH PERFECTLY INTERCHANGEABLE. REFERENCE NUMBERS, EITHER ORIGINAL OR OF A DIFFERENT NATURE, ARE FOR INFORMATION PURPOSES ONLY WHEN PLACING AN ORDER, PLEASE, ALWAYS USE COSIBO REFERENCE NUMBERS AND DO NOT MENTION THE ORIGINAL REFERENCE NUMBERS OF THE TRUCK MANUFACTURERS IN THE INVOICE TO VEHICLE OWNERS OR TO ANYBODY ELSE. THE CUSTOMER TAKES HIS OWN RESPONSIBILITY IF HE DOES NOT COMPLY WITH WHAT ABOVE.

	Code	OEM new	OEM old
CLAMP D.8	64090	813934	
<ul style="list-style-type: none"> ● Model ★ Application 			
<ul style="list-style-type: none"> ● 3 BUS ★ 			
<ul style="list-style-type: none"> ● 4 BUS ★ 			
<ul style="list-style-type: none"> ● F-K-N BUS ★ 			
<ul style="list-style-type: none"> ● 3 TRUCK ★ 			
<ul style="list-style-type: none"> ● 4 TRUCK ★ 			



CLAMP D.13	64091	813936	
<ul style="list-style-type: none"> ● 3 TRUCK ★ 			



CLAMP D. 16	64084	813937	
<ul style="list-style-type: none"> ● 3 BUS ★ 			
<ul style="list-style-type: none"> ● 3 TRUCK ★ 			



ALL THE COMPONENTS LISTED IN OUR CATALOGUE ARE NOT ORIGINAL, THOUGH PERFECTLY INTERCHANGEABLE. REFERENCE NUMBERS, EITHER ORIGINAL OR OF A DIFFERENT NATURE, ARE FOR INFORMATION PURPOSES ONLY WHEN PLACING AN ORDER, PLEASE, ALWAYS USE COSIBO REFERENCE NUMBERS AND DO NOT MENTION THE ORIGINAL REFERENCE NUMBERS OF THE TRUCK MANUFACTURERS IN THE INVOICE TO VEHICLE OWNERS OR TO ANYBODY ELSE. THE CUSTOMER TAKES HIS OWN RESPONSIBILITY IF HE DOES NOT COMPLY WITH WHAT ABOVE.

	Code	OEM new	OEM old
CLAMP D.18	64092	813938	
	● Model		
	★ Application		
	● 3 BUS		
	★		
	● 3 TRUCK		
	★		
	● 4 TRUCK		
	★		

CLAMP D.22	64093	813940	
	● 3 TRUCK		
	★		

CLAMP D.28	64095	804578	
	● 3 TRUCK		
	★		
	● 4 TRUCK		
	★		

ALL THE COMPONENTS LISTED IN OUR CATALOGUE ARE NOT ORIGINAL, THOUGH PERFECTLY INTERCHANGEABLE. REFERENCE NUMBERS, EITHER ORIGINAL OR OF A DIFFERENT NATURE, ARE FOR INFORMATION PURPOSES ONLY WHEN PLACING AN ORDER, PLEASE, ALWAYS USE COSIBO REFERENCE NUMBERS AND DO NOT MENTION THE ORIGINAL REFERENCE NUMBERS OF THE TRUCK MANUFACTURERS IN THE INVOICE TO VEHICLE OWNERS OR TO ANYBODY ELSE. THE CUSTOMER TAKES HIS OWN RESPONSIBILITY IF HE DOES NOT COMPLY WITH WHAT ABOVE.

		Code	OEM new	OEM old
OIL FILTER	● Model	60434	1768402	1768402
	★ Application			
	● 3 BUS			
	★	GR801R		
	● 4 BUS			
	★	GR801R		
	● F-K-N BUS			
	★	GR801R - GR875R - GRS/GRS0895R - GR/GRS/GRS0905R		
	● 3 TRUCK			
	★	GR801R - GR/GRS900R - GRH900 - GR/GRS900 - GRS900 CAG		
	● 4 TRUCK			
	★	GR801R - GRSH/GRS0900R - GRS890R - GR/GRS/GRS920R - GRS890 - GR/GRS900 DSC11 - GRS/GRSH900R DC14 - GRS920R AIR DC16 6X2/4 8X2/4		
● P-G-R-T TRUCK				
★	GR801R - GRS890R - GRS900/920R - GR900R - GRS0900R - GR875R - GRS895R - GR/GRS/GRS0905R - GRS920R - GRS0900R AIR DC16 - GRS/GRS0905R AIR DC13/16			

		61341	194838	
GEARBOX OIL PUMP	● 3 TRUCK			
	★	EK330/340/421/422/423		
	● 4 TRUCK			
	★	EK330/340/630/640		
	● P-G-R-T TRUCK			
	★	EK630/640		

ALL THE COMPONENTS LISTED IN OUR CATALOGUE ARE NOT ORIGINAL, THOUGH PERFECTLY INTERCHANGEABLE. REFERENCE NUMBERS, EITHER ORIGINAL OR OF A DIFFERENT NATURE, ARE FOR INFORMATION PURPOSES ONLY WHEN PLACING AN ORDER, PLEASE, ALWAYS USE COSIBO REFERENCE NUMBERS AND DO NOT MENTION THE ORIGINAL REFERENCE NUMBERS OF THE TRUCK MANUFACTURERS IN THE INVOICE TO VEHICLE OWNERS OR TO ANYBODY ELSE. THE CUSTOMER TAKES HIS OWN RESPONSIBILITY IF HE DOES NOT COMPLY WITH WHAT ABOVE.

	Code	OEM new	OEM old
GEARBOX OIL PUMP	65192	1426449	1120646
● Model			
★ Application			
● 3 BUS			
★ GR801R			
● 4 BUS			
★ GR801R			
● F-K-N BUS			
★			
● 3 TRUCK			
★ GR801R - GR/GRS900R - GRH900			
● 4 TRUCK			
★ GR/GRS/GRSH/GRSO			
● P-G-R-T TRUCK			
★			



	63123	1527743	1329585
GASKET			
● 4 BUS			
★ GRS890 - GR/GRS920R - GRSH900R			
● F-K-N BUS			
★ GRS890 - GR/GRS920R - GRSH900R			
● 3 TRUCK			
★ GR/GRS900R - GRH900 - GRS900 - GRS900CAG - GR900			
● 4 TRUCK			
★ GRS890 - GR/GRS920R - GRSH900R - GRS0900R - GRS890R - GR/GRS900R			
● P-G-R-T TRUCK			
★ GRS890 - GR/GRS920R - GRSH900R - GRS890R - GRS900/920R - GR900R			

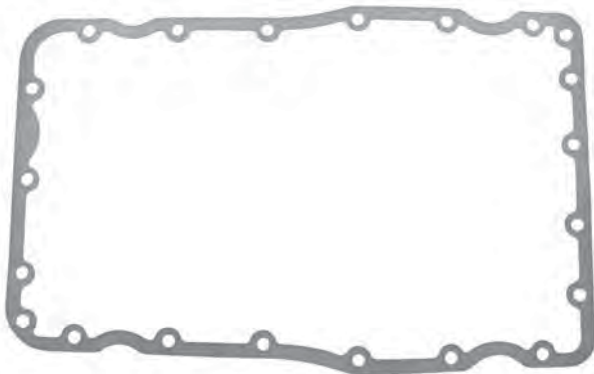

ALL THE COMPONENTS LISTED IN OUR CATALOGUE ARE NOT ORIGINAL, THOUGH PERFECTLY INTERCHANGEABLE. REFERENCE NUMBERS, EITHER ORIGINAL OR OF A DIFFERENT NATURE, ARE FOR INFORMATION PURPOSES ONLY WHEN PLACING AN ORDER, PLEASE, ALWAYS USE COSIBO REFERENCE NUMBERS AND DO NOT MENTION THE ORIGINAL REFERENCE NUMBERS OF THE TRUCK MANUFACTURERS IN THE INVOICE TO VEHICLE OWNERS OR TO ANYBODY ELSE. THE CUSTOMER TAKES HIS OWN RESPONSIBILITY IF HE DOES NOT COMPLY WITH WHAT ABOVE.

		Code	OEM new	OEM old
GASKET	● Model	64312	1549495	1329586
	★ Application			
	● 3 BUS			
	★ GR801R			
	● 4 BUS			
	★ GR801R			
	● F-K-N BUS			
	★ GR801R			
	● 3 TRUCK			
	★ GR801R - GR801			
● 4 TRUCK				
★ GR801R				
● P-G-R-T TRUCK				
★ GR801R				



GASKET SET	60897	550520	
	● 3 TRUCK		
	★ GS771/772 - GR871 GR/GRE871T		

GASKET SET	64314	550533	
	● 3 BUS		
	★ GS771/772 - G776/777 - GR801		

ALL THE COMPONENTS LISTED IN OUR CATALOGUE ARE NOT ORIGINAL, THOUGH PERFECTLY INTERCHANGEABLE. REFERENCE NUMBERS, EITHER ORIGINAL OR OF A DIFFERENT NATURE, ARE FOR INFORMATION PURPOSES ONLY WHEN PLACING AN ORDER, PLEASE, ALWAYS USE COSIBO REFERENCE NUMBERS AND DO NOT MENTION THE ORIGINAL REFERENCE NUMBERS OF THE TRUCK MANUFACTURERS IN THE INVOICE TO VEHICLE OWNERS OR TO ANYBODY ELSE. THE CUSTOMER TAKES HIS OWN RESPONSIBILITY IF HE DOES NOT COMPLY WITH WHAT ABOVE.

GASKET SET

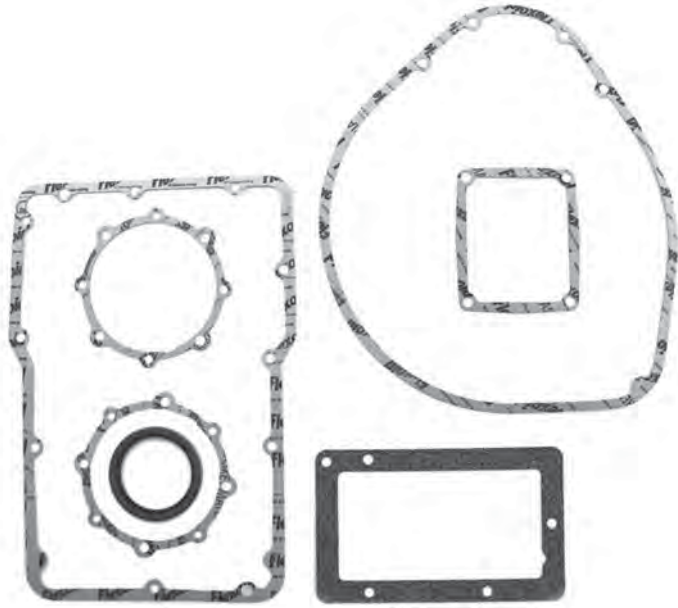

- Model
- ★ Application

Code

OEM new

OEM old

60900

550527

550521

- 3 TRUCK

- ★ GS771/772 - GR871 GR/GRE871T

GASKET SET

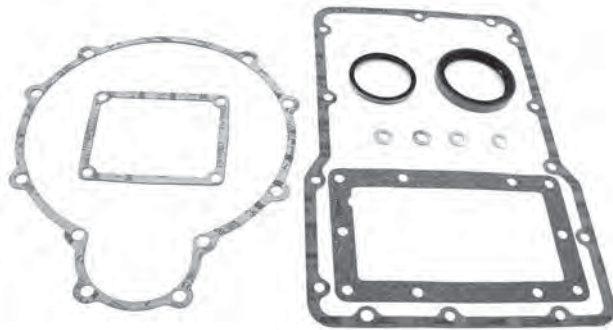

- 3 TRUCK

- ★ GS771/772

64314

550533

ALL THE COMPONENTS LISTED IN OUR CATALOGUE ARE NOT ORIGINAL, THOUGH PERFECTLY INTERCHANGEABLE. REFERENCE NUMBERS, EITHER ORIGINAL OR OF A DIFFERENT NATURE, ARE FOR INFORMATION PURPOSES ONLY WHEN PLACING AN ORDER, PLEASE, ALWAYS USE COSIBO REFERENCE NUMBERS AND DO NOT MENTION THE ORIGINAL REFERENCE NUMBERS OF THE TRUCK MANUFACTURERS IN THE INVOICE TO VEHICLE OWNERS OR TO ANYBODY ELSE. THE CUSTOMER TAKES HIS OWN RESPONSIBILITY IF HE DOES NOT COMPLY WITH WHAT ABOVE.

GASKET SET



- Model
- ★ Application

Code
63678OEM new
550537

OEM old

- **3 BUS**

- ★ G770

- **3 TRUCK**

- ★ G770 - GS771/772 - GR871 - GR/GRE871T

GASKET SET

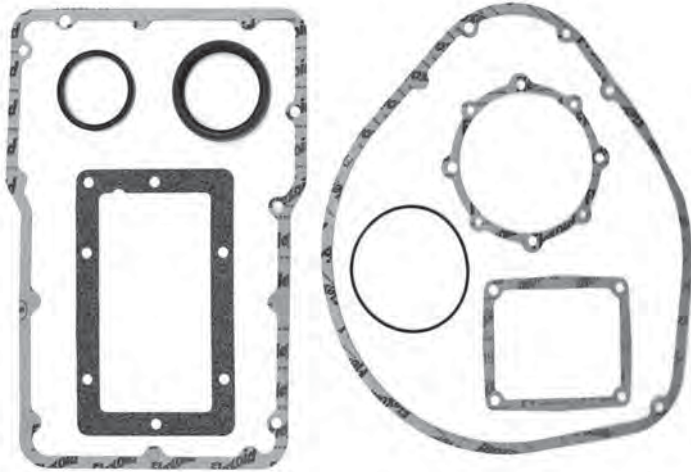
Code
61498OEM new
550534

- **3 TRUCK**

- ★ GR871 - GR/GRE871T

ALL THE COMPONENTS LISTED IN OUR CATALOGUE ARE NOT ORIGINAL, THOUGH PERFECTLY INTERCHANGEABLE. REFERENCE NUMBERS, EITHER ORIGINAL OR OF A DIFFERENT NATURE, ARE FOR INFORMATION PURPOSES ONLY WHEN PLACING AN ORDER, PLEASE, ALWAYS USE COSIBO REFERENCE NUMBERS AND DO NOT MENTION THE ORIGINAL REFERENCE NUMBERS OF THE TRUCK MANUFACTURERS IN THE INVOICE TO VEHICLE OWNERS OR TO ANYBODY ELSE. THE CUSTOMER TAKES HIS OWN RESPONSIBILITY IF HE DOES NOT COMPLY WITH WHAT ABOVE.

	Code	OEM new	OEM old
GEARBOX GASKET SET	60895	550539	
<ul style="list-style-type: none"> ● Model ★ Application 			
<ul style="list-style-type: none"> ● 4 BUS 			
<ul style="list-style-type: none"> ★ GRS890 - GR/GRS900R - GRSH900R 			
<ul style="list-style-type: none"> ● F-K-N BUS 			
<ul style="list-style-type: none"> ★ GRS890 - GR/GRS900R - GRSH900R - GR/GRS/GRSH900 - GR801 			
<ul style="list-style-type: none"> ● 3 TRUCK 			
<ul style="list-style-type: none"> ★ GRS900 - GR900 - GRH900 			
<ul style="list-style-type: none"> ● 4 TRUCK 			
<ul style="list-style-type: none"> ★ GRS890 - GR/GRS900R - GRSH900R - GR/GRS890R 			
<ul style="list-style-type: none"> ● P-G-R-T TRUCK 			
<ul style="list-style-type: none"> ★ GRS890 - GR/GRS900R - GRSH900R - GR/GRS/GRSH900 - GR801 			

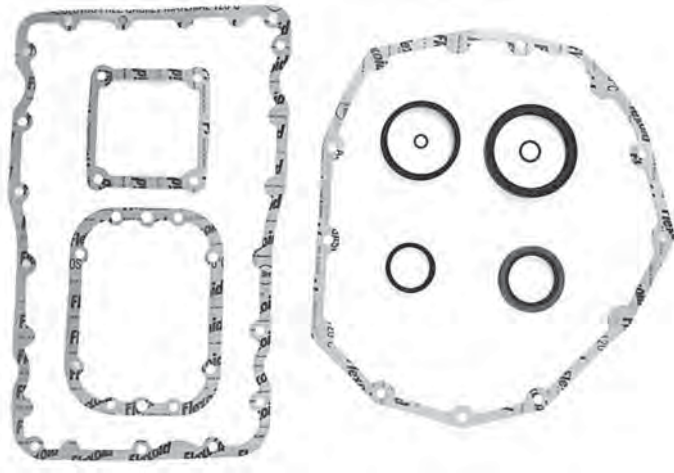

	64175	550578	550540
GASKET SET			
<ul style="list-style-type: none"> ● 3 BUS 			
<ul style="list-style-type: none"> ★ GR801 - GR801R - K113 			
<ul style="list-style-type: none"> ● 4 BUS 			
<ul style="list-style-type: none"> ★ GR801 - GR801R 			
<ul style="list-style-type: none"> ● F-K-N BUS 			
<ul style="list-style-type: none"> ★ GR801 - GR801R - GR890 - GR/GRS/GRSH900 			
<ul style="list-style-type: none"> ● 3 TRUCK 			
<ul style="list-style-type: none"> ★ GR801 - GR801R 			
<ul style="list-style-type: none"> ● 4 TRUCK 			
<ul style="list-style-type: none"> ★ GR801 - GR801R 			
<ul style="list-style-type: none"> ● P-G-R-T TRUCK 			
<ul style="list-style-type: none"> ★ GR801 - GR801R - GR/GRS/GRSH900 			

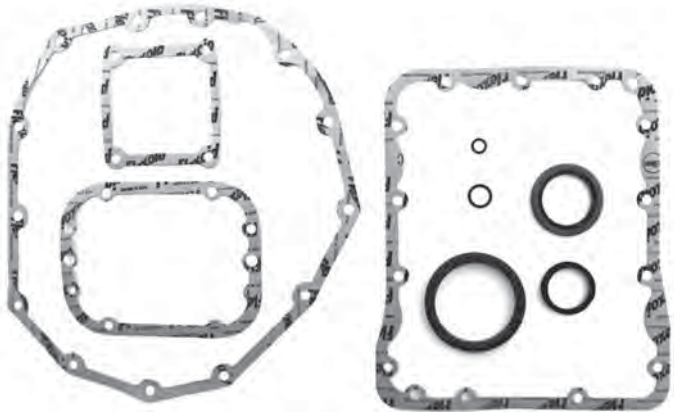

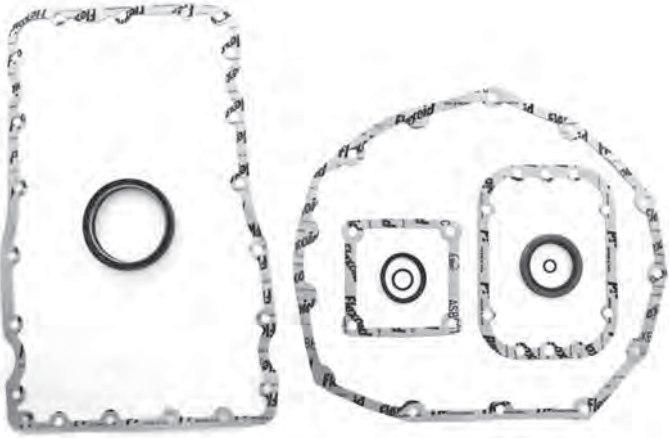
		Code	OEM new	OEM old
GASKET SET	<ul style="list-style-type: none"> ● Model ★ Application 	64311	550577	
		<ul style="list-style-type: none"> ● 4 BUS ★ GRS890 - GR/GRS900R - GRSH900R ● F-K-N BUS ★ GRS890 - GR/GRS900R - GRSH900R - GR/GRS/GRSH900 - GR801 ● 3 TRUCK ★ GRS900 - GR900 - GRH900 ● 4 TRUCK ★ GRS890 - GR/GRS900R - GRSH900R - GR/GRS890R ● P-G-R-T TRUCK ★ GRS890 - GR/GRS900R - GRSH900R - GR/GRS/GRSH900 - GR801 		

O-RING		63388	323451	
		<ul style="list-style-type: none"> ● 3 TRUCK ★ GA/GAE 770/774 		

O-RING		63554	1484765	1352885
		<ul style="list-style-type: none"> ● 4 BUS ★ K114/124 GR801R ● F-K-N BUS ★ DC11/12 GR875R - GRS/GRSO895R ● 4 TRUCK ★ DC11 GRS890R - GR/GRS900R - DC16 GRS900/920R - GRS/GRSO900/920R - DC12 GR/GRS900R - DC11/12 GRS890R - GR/GRS/GRSO900R ● P-G-R-T TRUCK ★ GRS/GRSO900R - GRS920R - DC16 - DC11/12 - DC11/12/13 GR875R - GRS895R - GR/GRS/GRSO905R - DC16 GRS895/905R - GRS0905R 		

ALL THE COMPONENTS LISTED IN OUR CATALOGUE ARE NOT ORIGINAL, THOUGH PERFECTLY INTERCHANGEABLE. REFERENCE NUMBERS, EITHER ORIGINAL OR OF A DIFFERENT NATURE, ARE FOR INFORMATION PURPOSES ONLY WHEN PLACING AN ORDER, PLEASE, ALWAYS USE COSIBO REFERENCE NUMBERS AND DO NOT MENTION THE ORIGINAL REFERENCE NUMBERS OF THE TRUCK MANUFACTURERS IN THE INVOICE TO VEHICLE OWNERS OR TO ANYBODY ELSE. THE CUSTOMER TAKES HIS OWN RESPONSIBILITY IF HE DOES NOT COMPLY WITH WHAT ABOVE.

		Code	OEM new	OEM old
O-RING	● Model	63555	1484766	1352866
	★ Application			
	● 4 BUS			
	★	K114/124 GR801R		
	● F-K-N BUS			
	★	DC11/12 GR875R - GR/GRSO895R		
	● 4 TRUCK			
	★	DC11 GRS890R - GR/GRS900R - DC16 GRS900/920R - GRS/GRSO900/920R - DC12 GR/GRS900R - DC11/12 GRS890R - GR/GRS/GRSO900R		
	● P-G-R-T TRUCK			
	★	DC16 GRS/GRSO900/R - GRS920/R - GRS895R/905R - GRSO905R - DC11/12/13 GR875R - GRSO895R - GR/GRS/GRSO905R		

		64778	1331820	
O-RING	● 4 BUS			
	★	GR801R K114/124		
	● F-K-N BUS			
	★	GR801/875R - GRS/GRSO895R - GR/GRS/GRSO905R - DC11/DC12		
	● 3 TRUCK			
	★	GR/GRS/GRH900		
	● 4 TRUCK			
	★	DSC9 - DSi9 E01 - DC9 01/02/03/04/05/06 - OSC9 G01 - DSC11 - OSC11 G03 - CP D9/DC9 19/20/21 - CP DC11 01/02/03/04/06/07 - DC12 01/02/03/09/16 - CR94 - CR/CT DSC11 - 8X8 WLS/ZLS CR 124 - CR/CT 124 - CP DSC12 01/02/05 - CP DSC11 74/75/79 - CR 4X4/6X6 - CP DC12 03 - CR/CT DC11 01/02/03/04/06/07 - CP19F FRONTLINE		
	● P-G-R-T TRUCK			
	★	GR801/875/900R - GRS890/895R - GRS895/900/905/920R - GRS/GRSO900/905R - DC11/DC12/DC13/DC16 - GR/GRS/GRSO905R -		

ALL THE COMPONENTS LISTED IN OUR CATALOGUE ARE NOT ORIGINAL, THOUGH PERFECTLY INTERCHANGEABLE. REFERENCE NUMBERS, EITHER ORIGINAL OR OF A DIFFERENT NATURE, ARE FOR INFORMATION PURPOSES ONLY WHEN PLACING AN ORDER, PLEASE, ALWAYS USE COSIBO REFERENCE NUMBERS AND DO NOT MENTION THE ORIGINAL REFERENCE NUMBERS OF THE TRUCK MANUFACTURERS IN THE INVOICE TO VEHICLE OWNERS OR TO ANYBODY ELSE. THE CUSTOMER TAKES HIS OWN RESPONSIBILITY IF HE DOES NOT COMPLY WITH WHAT ABOVE.

SOLENOID VALVE



	Code	OEM new	OEM old
● Model	60304	1488083	1334037
★ Application			1423566

● 3 BUS			
★	GR801R		
● 4 BUS			
★	GR801R CS/OPTICRUISE - GR/GRS/R		
● 3 TRUCK			
★	GRS900CAG - GRS900R - GR/GRS900R - GRH900		
● 4 TRUCK			
★	GRS890R - GRS920R - GRS0900R - GR/GRSH900R - GR/GRS900R - GR801R & OPTICRUISE - GR/GRS900 - GRS920 - GRSH900 - GR/GRS/GRSH/GRSO/R - GRS/GRSH/GRSO900R - GRS890		
● P-G-R-T TRUCK			
★	GRS890R - GRS920R - GRS900R - GRS0900R		

REPAIR KIT FOR OUR 60304

63754

63754



● 3 BUS			
★	GR801R		
● 4 BUS			
★	GR801R CS/OPTICRUISE - GR/GRS/R		
● 3 TRUCK			
★	GRS900CAG - GRS900R - GR/GRS900R - GRH900		
● 4 TRUCK			
★	GRS890R - GRS920R - GRS0900R - GR/GRSH900R - GR/GRS900R - GR801R & OPTICRUISE - GR/GRS900 - GRS920 - GRSH900 - GR/GRS/GRSH/GRSO/R - GRS/GRSH/GRSO900R - GRS890		
● P-G-R-T TRUCK			
★	GRS890R - GRS920R - GRS900R - GRS0900R		

ALL THE COMPONENTS LISTED IN OUR CATALOGUE ARE NOT ORIGINAL, THOUGH PERFECTLY INTERCHANGEABLE. REFERENCE NUMBERS, EITHER ORIGINAL OR OF A DIFFERENT NATURE, ARE FOR INFORMATION PURPOSES ONLY WHEN PLACING AN ORDER, PLEASE, ALWAYS USE COSIBO REFERENCE NUMBERS AND DO NOT MENTION THE ORIGINAL REFERENCE NUMBERS OF THE TRUCK MANUFACTURERS IN THE INVOICE TO VEHICLE OWNERS OR TO ANYBODY ELSE. THE CUSTOMER TAKES HIS OWN RESPONSIBILITY IF HE DOES NOT COMPLY WITH WHAT ABOVE.

REPAIR KIT FOR OUR 60304



	Code	OEM new	OEM old
● Model	63755	1364636	
★ Application			
● 3 BUS			
★ GR801R			
● 4 BUS			
★ GR801R CS/OPTICRUISE - GR/GRS/R			
● 3 TRUCK			
★ GRS900CAG - GRS900R - GR/GRS900R - GRH900			
● 4 TRUCK			
★ GRS890R - GRS920R - GRS0900R - GR/GRSH900R - GR/GRS900R - GR801R & OPTICRUISE - GR/GRS900 - GRS920 - GRSH900 - GR/GRS/GRSH/GRSO/R - GRS/GRSH/GRSO900R - GRS890			
● P-G-R-T TRUCK			
★ GRS890R - GRS920R - GRS900R - GRS0900R			

VALVE

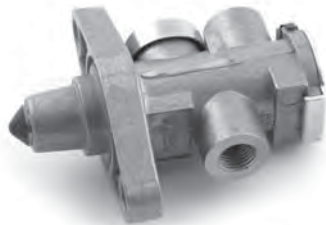

	63276	1319557	
● 3 BUS			
★ GR801 - GR801R			
● 4 BUS			
★ GR801R			
● F-K-N BUS			
★ GR/GRS - GR801R			
● 3 TRUCK			
★ GR801/900 - GRH900 - CP/CR 93/113/143 - CT93 - CP/CR/CT 113/143 - CT143 LHD/RHD GR/GRH900 - CR143 LHD/RDH GR900 - GRS900 - CR/CT 113/143 RHD GRS900 - CG/CP/CR RHD GR/GRH900			
● 4 TRUCK			
★ GR900 - CT LHD GR/GRS/GRSH/GRSO900R - GRS920R - CP/CR GR801/900R - GRS890R - CR GRS/GRSH900R - CT RHD GR/GRS900R - GRS890			
● P-G-R-T TRUCK			
★ GR/GRS - CT LHD/RHD			

ALL THE COMPONENTS LISTED IN OUR CATALOGUE ARE NOT ORIGINAL, THOUGH PERFECTLY INTERCHANGEABLE. REFERENCE NUMBERS, EITHER ORIGINAL OR OF A DIFFERENT NATURE, ARE FOR INFORMATION PURPOSES ONLY WHEN PLACING AN ORDER, PLEASE, ALWAYS USE COSIBO REFERENCE NUMBERS AND DO NOT MENTION THE ORIGINAL REFERENCE NUMBERS OF THE TRUCK MANUFACTURERS IN THE INVOICE TO VEHICLE OWNERS OR TO ANYBODY ELSE. THE CUSTOMER TAKES HIS OWN RESPONSIBILITY IF HE DOES NOT COMPLY WITH WHAT ABOVE.

SOLENOID VALVE



	Code	OEM new	OEM old
● Model	65191	1536304	1340231 1421322
★ Application			
● 3 BUS			
★	GS771/772 - GR801		
● 4 BUS			
★	OPTICRUISE CS		
● F-K-N BUS			
★	OPTICRUISE CS		
● 3 TRUCK			
★	GS771/772 - GR871 - GR/GRE871 - GR880/T GRH880 - GRS900 - GT800 - CP/CR 93/113 - CT 113 - CR/CT 143		
● 4 TRUCK			
★	OPTICRUISE - GRS/GRSH/GRS0900/R - GRS920/R - GRS890		

SOLENOID VALVE







	60375	1413047	303470
● 3 BUS			
★	GS771 CAG/CS		
● 3 TRUCK			
★	GS771 CAG - GR871/880 CAG - GR/GRE871 TE70 CAG - GRS900 CAG - GR900 EK330/340 CAG - GR801 CAG - G770 CAG		

IMPULSE SENSOR



	62530	1852113	1742947
● F-K-N BUS			
★	GR875 GRS/GRS0895 - GR875R		
● 4 TRUCK			
★	GR801/R & OPTICRUISE		
● P-G-R-T TRUCK			
★	GR875 GRS895 GR/GRS/GRS0905 - GR875R GRS895R GR/GRS/GRS0905R		

ALL THE COMPONENTS LISTED IN OUR CATALOGUE ARE NOT ORIGINAL, THOUGH PERFECTLY INTERCHANGEABLE. REFERENCE NUMBERS, EITHER ORIGINAL OR OF A DIFFERENT NATURE, ARE FOR INFORMATION PURPOSES ONLY WHEN PLACING AN ORDER, PLEASE, ALWAYS USE COSIBO REFERENCE NUMBERS AND DO NOT MENTION THE ORIGINAL REFERENCE NUMBERS OF THE TRUCK MANUFACTURERS IN THE INVOICE TO VEHICLE OWNERS OR TO ANYBODY ELSE. THE CUSTOMER TAKES HIS OWN RESPONSIBILITY IF HE DOES NOT COMPLY WITH WHAT ABOVE.

	Code	OEM new	OEM old
SPEED SENSOR	65186	1853436	1111459
	<ul style="list-style-type: none"> ● Model ★ Application 		
	<ul style="list-style-type: none"> ● 3 BUS ★ K113 - GR801R - GR801 		
	<ul style="list-style-type: none"> ● 4 BUS ★ 		
	<ul style="list-style-type: none"> ● F-K-N BUS ★ 		
	<ul style="list-style-type: none"> ● 3 TRUCK ★ GT811 - GR801 GR/GRS/GRH900 - GR/GRS900R - GR880 GR880/T GRH880 - GR871 		
	<ul style="list-style-type: none"> ● P-G-R-T TRUCK ★ GR801 		
GEARBOX KNOB SWITCH	61624	234387	
	<ul style="list-style-type: none"> ● 3 BUS ★ K113 - GS771/772 		
	<ul style="list-style-type: none"> ● 3 TRUCK ★ CT 93/113 GR871/880 - CG/CP RHD GS771/772 - GR871 - CG/CP LHD GS771/772 - GR871/880 - CP/CR 93 LHD/RHD GR871 - CP 113 LHD GRS771/772 - GR871/880 - CP/CR 113 RHD - CP/CR 113 LHD/RHD 4X4/6X6 GR871 - CR/CT 143 - CR 93 GS771/772 - GR871 - CR 113 LHD GS771/772 - GR871 - CP/CR 113 RHD GS771/772 - GR871 - CR143 GR880 - CT143 GR880T/GRH880 		
SWITCH	61953	1303472	375734
	<ul style="list-style-type: none"> ● 3 TRUCK ★ GR871 - GR/GRE871T CAG - GR880T - GRH880 		
SWITCH	64304	1472738	
	<ul style="list-style-type: none"> ● F-K-N BUS ★ G701 		

ALL THE COMPONENTS LISTED IN OUR CATALOGUE ARE NOT ORIGINAL, THOUGH PERFECTLY INTERCHANGEABLE. REFERENCE NUMBERS, EITHER ORIGINAL OR OF A DIFFERENT NATURE, ARE FOR INFORMATION PURPOSES ONLY WHEN PLACING AN ORDER, PLEASE, ALWAYS USE COSIBO REFERENCE NUMBERS AND DO NOT MENTION THE ORIGINAL REFERENCE NUMBERS OF THE TRUCK MANUFACTURERS IN THE INVOICE TO VEHICLE OWNERS OR TO ANYBODY ELSE. THE CUSTOMER TAKES HIS OWN RESPONSIBILITY IF HE DOES NOT COMPLY WITH WHAT ABOVE.

		Code	OEM new	OEM old
SWITCH	● Model	63677	1472739	1420005
	★ Application			
	● 4 BUS			
	★	GR801R WITH OPTICRUISE		
	● F-K-N BUS			
	★	GR801R WITH OPTICRUISE		
	● 4 TRUCK			
	★	GRS890R - GRS/GRSH/GRS0900R - GRS920R - GT/GTD 800/900/901		
	● P-G-R-T TRUCK			
	★	GRS890R - GRS/GRSH/GRS0900R - GRS920R - GT/GTD 800/900/901		



		63055	1303471	370710
SWITCH	● 3 BUS			
	★	G776 CAG - G776/777 - GS771 CAG - GS771/772 - G770 - K113 - GR801 - GR801R - GR801 CAG - GR/GRS900 CAG		
	● 4 BUS			
	★	GR801R WITH OPTICRUISE		
	● 3 TRUCK			
	★	G770 - G770 CAG - GS771 CAG - GR801 - GR801 CAG - GR871 - GR/GRE871T CAG - GR880 - GR880T - GRH880 - GR900 - GRH900 - GR/GRS900 - GRS900 CAG - GRS900 R - GS771/772 - GT811 - GR801/900 - CP/CR 93/113/143 LHD GR/GRH900 - CT93 - CP/CR/CT 113/143 RHD GR900 - CT RHD GR/GRS900R - CT 143 LHD/RHD GR/GRH900 - CR 143 LHD/RHD GR900 - CP 113 CR/CT 113/143 RHD GRS900 - CG/CP/CR RHD GR/GRH900 - EK300/EK310/EK330/EK340/EK422/EK423		
	● 4 TRUCK			
	★	GRS890R - GRS920R - GRS/GRSH900R - GR/GRS/R WITH OPTICRUISE		
	● P-G-R-T TRUCK			
	★	GRS890R - GRS920R - GRS/GRSH900R		



		63447	1431781	1391322 243460
RELAY	● 4 TRUCK			
	★	ALLISON GA750 - 750/R - GA751 751/R - GA851 851/R - GA852 852/R LHD/RHD		



ALL THE COMPONENTS LISTED IN OUR CATALOGUE ARE NOT ORIGINAL, THOUGH PERFECTLY INTERCHANGEABLE. REFERENCE NUMBERS, EITHER ORIGINAL OR OF A DIFFERENT NATURE, ARE FOR INFORMATION PURPOSES ONLY WHEN PLACING AN ORDER, PLEASE, ALWAYS USE COSIBO REFERENCE NUMBERS AND DO NOT MENTION THE ORIGINAL REFERENCE NUMBERS OF THE TRUCK MANUFACTURERS IN THE INVOICE TO VEHICLE OWNERS OR TO ANYBODY ELSE. THE CUSTOMER TAKES HIS OWN RESPONSIBILITY IF HE DOES NOT COMPLY WITH WHAT ABOVE.

OPTICRUISE REPAIR SET

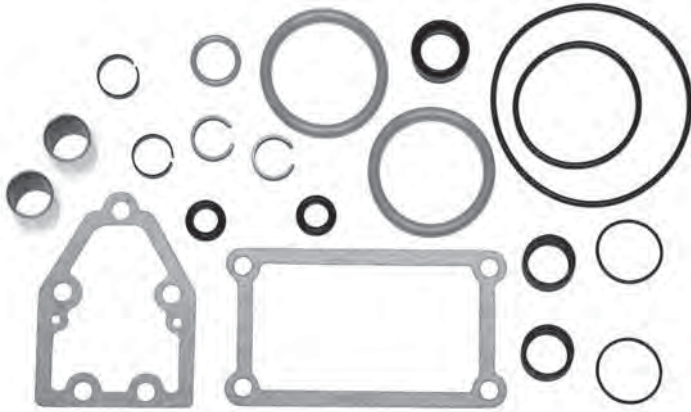

- Model
- ★ Application

Code

OEM new

OEM old

63793

63793

- 4 BUS

★

- 4 TRUCK

★ 94 - 114 - 124 - 144 - 164

- F-K-N BUS

★

- P-G-R-T TRUCK

★

SEAL 25x35x7



63570

329638

- 3 BUS

★ GR801 CAG - GR/GRS900 CAG - G770 - K113 - GS771/772 - G776/777 - GR801 - GR801R - GS771 CAG

- 4 BUS

★ GR801R

- F-K-N BUS

★ GR801R

- 3 TRUCK

★ GR801 CAG - GR801/900 - GRH900 - GR/GRS900 CAG - GRS900 - CT93/113 - CG/CP/CR 93 LHD/RHD - CG/CP 113 LHD - CP/CR 113 RHD 4X4/6X6 - CP/CR 113 LHD 4X4/6X4/6X6 - CR 143 LHD/RHD GR/GRH880 - CP/CR 93/113/143 LHD GR/GRH900 - CT93 - CP/CR/CT 113/143 RHD GR900 - CT143 LHD/RHD GR/GRH900 - CP/CR93 RHD - CP113 - CR/CT 113/143 RHD GRS900 - CG/CP/CR RHD GR/GRH900 - CR143 RHD GR900 - CT143 GR880T/GRH880

- 4 TRUCK

★ CP/CR GR801/900R GRS890R - CR GRS/GRSH900R GRS920R - CT LHD GR/GRS/GRSH/GRSO900R - CT RHD GR/GRS900R

- P-G-R-T TRUCK

★ CT LHD/RHD

ALL THE COMPONENTS LISTED IN OUR CATALOGUE ARE NOT ORIGINAL, THOUGH PERFECTLY INTERCHANGEABLE. REFERENCE NUMBERS, EITHER ORIGINAL OR OF A DIFFERENT NATURE, ARE FOR INFORMATION PURPOSES ONLY WHEN PLACING AN ORDER, PLEASE, ALWAYS USE COSIBO REFERENCE NUMBERS AND DO NOT MENTION THE ORIGINAL REFERENCE NUMBERS OF THE TRUCK MANUFACTURERS IN THE INVOICE TO VEHICLE OWNERS OR TO ANYBODY ELSE. THE CUSTOMER TAKES HIS OWN RESPONSIBILITY IF HE DOES NOT COMPLY WITH WHAT ABOVE.

		Code	OEM new	OEM old
BUSHING	● Model	61496	244780	
	★ Application			
	● 3 BUS			
	★	GR801 CAG - GR/GRS900 CAG - K113 - GS771/772 - G776/777 - GS771 CAG		
	● 4 BUS			
	★	OPTICRUISE		
	● F-K-N BUS			
	★	GR875R GRS895R GR/GRS/GRS0905R WITH OPTICRUISE - G670		
	● 3 TRUCK			
	★	GR801 CAG - GR/GRS900 CAG - GR871 - GR871/880 CAG - GR/GRE871 - GR880T - GRH880		
	● 4 TRUCK			
	★	CP/CR GR801/900R GRS890R - CR GRS/GRH900R GRS920R - CT LHD GR/GRS/GRSH/GRS0900R - OPTICRUISE		
● P-G-R-T TRUCK				
★	GR875R GRS895R GR/GRS/GRS0905R WITH OPTICRUISE - G670 - CT LHD			



		65179	283650	
BUSHING	● 3 BUS			
	★	K 113		
	● 3 TRUCK			
	★	GR/GRS900		
	● 4 BUS			
	★			
	● 4 TRUCK			
	★			
	● F-K-N BUS			
	★	G670 - GR875R - GRS/GRS0895R		
	● P-G-R-T TRUCK			
	★	GR875R - GRS895R - GR/GRS/GRS0905R - G670		



	Code	OEM new	OEM old
RUBBER BOOT	62228	1345492	
<ul style="list-style-type: none"> ● Model ★ Application 			
<ul style="list-style-type: none"> ● 3 BUS 			
<ul style="list-style-type: none"> ★ GR801R 			
<ul style="list-style-type: none"> ● 4 BUS 			
<ul style="list-style-type: none"> ★ GR801R 			
<ul style="list-style-type: none"> ● F-K-N BUS 			
<ul style="list-style-type: none"> ★ GR801R 			
<ul style="list-style-type: none"> ● 3 TRUCK 			
<ul style="list-style-type: none"> ★ GR801/900 - GRH900 - GRS900 - CP/CR 93/113/143 LHD GR/GRH900 - CP113 - CR/CT 113/143 RHD GRS900 - CG/CP/CR RHD GR/GRH900 - CR143 RHD GR900 			
<ul style="list-style-type: none"> ● 4 TRUCK 			
<ul style="list-style-type: none"> ★ CP/CR GR801/900R GRS890R - CR GRS/GRSH900R GRS920R - CT LHD GR/GRS/GRSH/GRSO900R 			
<ul style="list-style-type: none"> ● P-G-R-T TRUCK 			
<ul style="list-style-type: none"> ★ CT LHD 			



CYLINDER HOUSING	62526	284015	
<ul style="list-style-type: none"> ● 3 TRUCK 			
<ul style="list-style-type: none"> ★ GR871 - GR871/880 - CAG - GR/GRE871 - GR880/T - GRH880 			



	Code	OEM new	OEM old
GEAR	63262	1114838	244536



- **Model**
 - ★ **Application**
- | | |
|--|--|
| ● 3 TRUCK | |
| ★ GR871 - GR/GRE871T - GRH880 - GR880T | |

INPUT SHAFT	63005	294904	294903
--------------------	--------------	--------	--------

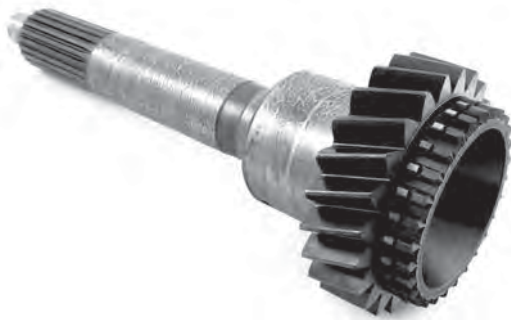

- **3 TRUCK**
- ★ GR871

SYNCHRONIZING RING	63241	184490	
---------------------------	--------------	--------	--



- **3 TRUCK**
- ★ GR871 - GR/GRE871T - GR880T - GR/GRH880

ALL THE COMPONENTS LISTED IN OUR CATALOGUE ARE NOT ORIGINAL, THOUGH PERFECTLY INTERCHANGEABLE. REFERENCE NUMBERS, EITHER ORIGINAL OR OF A DIFFERENT NATURE, ARE FOR INFORMATION PURPOSES ONLY WHEN PLACING AN ORDER, PLEASE, ALWAYS USE COSIBO REFERENCE NUMBERS AND DO NOT MENTION THE ORIGINAL REFERENCE NUMBERS OF THE TRUCK MANUFACTURERS IN THE INVOICE TO VEHICLE OWNERS OR TO ANYBODY ELSE. THE CUSTOMER TAKES HIS OWN RESPONSIBILITY IF HE DOES NOT COMPLY WITH WHAT ABOVE.

RING



- Model
- ★ Application

Code

OEM new

OEM old

63253

254333

- 3 TRUCK

- ★ GR871 - GR/GRE871T - GR880T - GR/GRH880

SLEEVE



- 3 TRUCK

- ★ G770 - G770 CAG - GS771 CAG - GS771/772 - GR871 - GR871 - GR/GRE871T CAG - GR871 - GR/GRE871T - GR880 - GR880T - GRH880

- 3 BUS

- ★ G770 - G776 CAG - G776/777 - GS771 CAG - GS771/772

SLEEVE



- 3 TRUCK

- ★ GR801R - GR801

- 4 TRUCK

- ★ GR801R

- 3 BUS

- ★ GR801R - GR801 - K113

- 4 BUS

- ★ GR801R

ALL THE COMPONENTS LISTED IN OUR CATALOGUE ARE NOT ORIGINAL, THOUGH PERFECTLY INTERCHANGEABLE. REFERENCE NUMBERS, EITHER ORIGINAL OR OF A DIFFERENT NATURE, ARE FOR INFORMATION PURPOSES ONLY WHEN PLACING AN ORDER, PLEASE, ALWAYS USE COSIBO REFERENCE NUMBERS AND DO NOT MENTION THE ORIGINAL REFERENCE NUMBERS OF THE TRUCK MANUFACTURERS IN THE INVOICE TO VEHICLE OWNERS OR TO ANYBODY ELSE. THE CUSTOMER TAKES HIS OWN RESPONSIBILITY IF HE DOES NOT COMPLY WITH WHAT ABOVE.

	Code	OEM new	OEM old
OIL TUBE	60015	315060	
<ul style="list-style-type: none"> ● Model ★ Application 			
<ul style="list-style-type: none"> ● 3 TRUCK 			
<ul style="list-style-type: none"> ★ GR801R - G770 - G770 CAG - GS771 CAG - GS771/772 - GR871R - GR871 - GR/GRE871T - GR880T - GRH880 - GR880 - GR/GRS900R 			
<ul style="list-style-type: none"> ● 4 TRUCK 			
<ul style="list-style-type: none"> ★ GR801R - GR900R - GSRO900R - GRS/GRSH900R - GRS920R - GRS890R 			
<ul style="list-style-type: none"> ● P-G-R-T TRUCK 			
<ul style="list-style-type: none"> ★ GR801R - GR/GRS900R - GRS890R - GRS920R - GRSO900R 			
<ul style="list-style-type: none"> ● 3 BUS 			
<ul style="list-style-type: none"> ★ G770/776/777 - G776 CAG - GS771 CAG - GS771/772 - GR801R 			
<ul style="list-style-type: none"> ● 4 BUS 			
<ul style="list-style-type: none"> ★ GR801R 			
<ul style="list-style-type: none"> ● F-K-N BUS 			
<ul style="list-style-type: none"> ★ GR801R 			

**OIL SEAL 55X75X9**

	63128	1318388	
<ul style="list-style-type: none"> ● 3 TRUCK 			
<ul style="list-style-type: none"> ★ GR801 - GR801R - GR900 - GR900R - GRS900 - GRS900R - GR/GRS/GRH900 			
<ul style="list-style-type: none"> ● 4 TRUCK 			
<ul style="list-style-type: none"> ★ GR801R - GRS890 - GR/GRS900R - GRSH900R - GR900R - GRSO900R - GRS/GRSH900R - GRS920R - GRS890R 			
<ul style="list-style-type: none"> ● P-G-R-T TRUCK 			
<ul style="list-style-type: none"> ★ GR801R - GRS890 - GR/GRS900R - GRSH900R - GR900R - GRS890R - GRS920R - GRSO900R 			
<ul style="list-style-type: none"> ● 3 BUS 			
<ul style="list-style-type: none"> ★ GR801R 			
<ul style="list-style-type: none"> ● 4 BUS 			
<ul style="list-style-type: none"> ★ GR801R - GRS890 - GR/GRS900R - GRSH900R 			
<ul style="list-style-type: none"> ● F-K-N BUS 			
<ul style="list-style-type: none"> ★ GR801R - GRS890 - GR/GRS900R - GRSH900R 			



	Code	OEM new	OEM old
OIL SEAL 45X65X10	61025	388528	314063
	<ul style="list-style-type: none"> ● Model Application ★ 3 TRUCK ★ G770 - GS771 CAG - GS771/772 - GR871 - GR/GRE871T - GR871 - GR/GRE871T CAG - GR880T - GRH880 - ● 3 BUS ★ G770/776/777 - G776 CAG - GS771 CAG - GS771/772 		
OIL SEAL 80x100x12	61026	338643	275591
	<ul style="list-style-type: none"> ● 3 TRUCK ★ GR871 - GR/GRE871T - GR871 - GR/GRE871T CAG - GR871 		
MAGNETIC PLUG	61371	235434	153682
	<ul style="list-style-type: none"> ● 3 BUS ★ G770/776/777 - GS771/772 ● 3 TRUCK ★ G770 - GS771/772 - GR871 GR/GRE871T - GR880T - GR/GRH880 		
V4 OIL SEAL 73X85X6.6	64074	358404	
	<ul style="list-style-type: none"> ● 3 TRUCK ★ GR880T - GRH880 - GR880 - GR900R - GR801 - GR801R ● 4 TRUCK ★ GR900R ● 3 BUS ★ GR801R 		

ALL THE COMPONENTS LISTED IN OUR CATALOGUE ARE NOT ORIGINAL, THOUGH PERFECTLY INTERCHANGEABLE. REFERENCE NUMBERS, EITHER ORIGINAL OR OF A DIFFERENT NATURE, ARE FOR INFORMATION PURPOSES ONLY WHEN PLACING AN ORDER, PLEASE, ALWAYS USE COSIBO REFERENCE NUMBERS AND DO NOT MENTION THE ORIGINAL REFERENCE NUMBERS OF THE TRUCK MANUFACTURERS IN THE INVOICE TO VEHICLE OWNERS OR TO ANYBODY ELSE. THE CUSTOMER TAKES HIS OWN RESPONSIBILITY IF HE DOES NOT COMPLY WITH WHAT ABOVE.

	Code	OEM new	OEM old
GEARBOX V RING	64080	378613	
● Model			
★ Application			
● 3 TRUCK			
★ GR801 - GR801/R - GR900 - GR900/R - GRS900 - GRS900/R - GR/GRS/GRH900			
● 4 TRUCK			
★ GR801/GRS890 - GR/GRS900/R - GRS/GRSH900/R - GRS920/R - GRS890/R			
● P-G-R-T TRUCK			
★ GRS890 - GR/GRS900/R - GRSH900/R			
● 3 BUS			
★ - GR801 - GR801/R - K 113			
● 4 BUS			
★ GR801/RGRS890 - GR/GRS900/R - GRSH900/R			
● F-K-N BUS			
★ GR801/R - GRS890 - GR/GRS900/R - GRSH900/R			



	62361	1381235	1329876
RETARDER OIL FILTER			
● P-G-R-T TRUCK			
★ GR875R - GRS895R - GR/GRS/GRS0905R			
● F-K-N BUS			
★ GR875R - GRS/GRS0895R			



	Code	OEM new	OEM old
RING NUT	64071	1461414	1114622
<ul style="list-style-type: none"> ● Model ★ Application 			
<ul style="list-style-type: none"> ● 3 BUS 			
<ul style="list-style-type: none"> ★ GR801 - GR801/R 			
<ul style="list-style-type: none"> ● 4 BUS 			
<ul style="list-style-type: none"> ★ GR801/R - GR801 			
<ul style="list-style-type: none"> ● F-K-N BUS 			
<ul style="list-style-type: none"> ★ GR801/R - GRS/GRS0895/R 			
<ul style="list-style-type: none"> ● 3 TRUCK 			
<ul style="list-style-type: none"> ★ GRS900/R - GRH900 - GR900/R - GR801 - GR801/R 			
<ul style="list-style-type: none"> ● 4 TRUCK 			
<ul style="list-style-type: none"> ★ GRS900/R - GRSO900/R - RGS/GRSH900/R - GRS920/R - GRS890/R - GR801/R - GRS890/R 			
<ul style="list-style-type: none"> ● P-G-R-T TRUCK 			
<ul style="list-style-type: none"> ★ GR801/R - GRS890R - GR900/R - GRS900/920/R - GRSO900/R - GRS895/R - GRS/GRSO905/R 			



LOCK NUT	65091	315085	
<ul style="list-style-type: none"> ● 3 BUS 			
<ul style="list-style-type: none"> ★ G770 G776 G777 - G776 CAG - GA775/781R - GS771 CAG - GS771/772 - GA-V771R GAV773R GAV781R GAV783R 			
<ul style="list-style-type: none"> ● 3 TRUCK 			
<ul style="list-style-type: none"> ★ G770 - G770 CAG - GS771/772 - GR871 			



	Code	OEM new	OEM old
LOCK NUT	60836	1525988	387877
● Model			
★ Application			
● 3 BUS			
★ K 113 GR801 - K 93/113 L 113 P40/400/50/500 GR801R -			
● 3 TRUCK			
★ P300/400/500/600 93/143 - GR871 GR/GRE871T - GRH880 - GR771 - GR880/880T - GA/GAE770/774			
● 4 BUS			
★ P300/400 GR801R			
● 4 TRUCK			
★			
● F-K-N BUS			
★ P602			
● P-G-R-T TRUCK			
★ P602			



	60047	284843	
BEARING			
● 3 BUS			
★ G770 - G776 - G776 CAG - G777 - GS771 CAG - GS771/772			
● 3 TRUCK			
★ G770 - G770 CAG - GS771 CAG - GS771/772 - GR871 - GR/GRE871T			



	60249	338706	
SYNCHRO ASSY			
● 3 TRUCK			
★ GR871 - GR/GRE871T CAG - GR/GRE871T			



ALL THE COMPONENTS LISTED IN OUR CATALOGUE ARE NOT ORIGINAL, THOUGH PERFECTLY INTERCHANGEABLE. REFERENCE NUMBERS, EITHER ORIGINAL OR OF A DIFFERENT NATURE, ARE FOR INFORMATION PURPOSES ONLY WHEN PLACING AN ORDER, PLEASE, ALWAYS USE COSIBO REFERENCE NUMBERS AND DO NOT MENTION THE ORIGINAL REFERENCE NUMBERS OF THE TRUCK MANUFACTURERS IN THE INVOICE TO VEHICLE OWNERS OR TO ANYBODY ELSE. THE CUSTOMER TAKES HIS OWN RESPONSIBILITY IF HE DOES NOT COMPLY WITH WHAT ABOVE.

	Code	OEM new	OEM old
OIL SEAL 68X80X8	61198	315022	
<ul style="list-style-type: none"> ● Model ★ Application 			
<ul style="list-style-type: none"> ● 3 BUS 			
<ul style="list-style-type: none"> ★ G770/776/777 - GS771/772 			
<ul style="list-style-type: none"> ● 3 TRUCK 			
<ul style="list-style-type: none"> ★ G770 - GS771/772 - GR871 - GR/GRE871T 			



OIL SEAL 50X40X8	61214	315270	
<ul style="list-style-type: none"> ● 3 BUS 			
<ul style="list-style-type: none"> ★ G770/776/777 - GS771/772 			
<ul style="list-style-type: none"> ● 3 TRUCK 			
<ul style="list-style-type: none"> ★ G770 - GS771/772 - GR871 - GR/GRE871T - GR880T - GRH880 - GR880 			



O-RING 200X3	61215	194414	
<ul style="list-style-type: none"> ● 3 BUS 			
<ul style="list-style-type: none"> ★ G770/776/777 - GS771/772 			
<ul style="list-style-type: none"> ● 3 TRUCK 			
<ul style="list-style-type: none"> ★ G770 - GS771/772 - GR871 - GR/GRE871T - GR880T - GRH880 - GR880 			

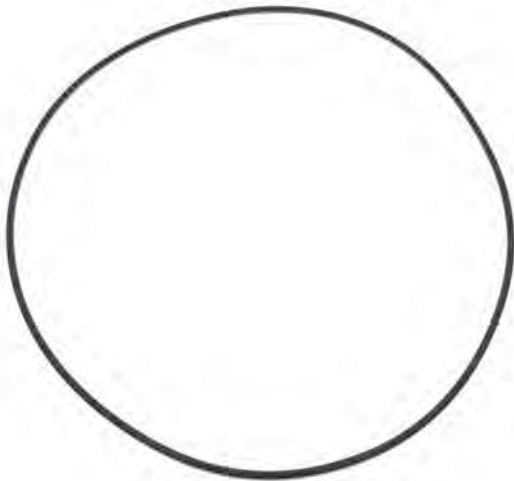

REPAIR SET



● Model

★ Application

Code

OEM new

OEM old

63621

63621

● 3 BUS

★

G770/776/777 - GS771/772 COMPOSED BY: N.1 PC 61214 - N.1 PC 61215 - N.1 PC 61025

● 3 TRUCK

★

G770 - GS771/772 - GR871 - GR/GRE871T - GR880T - GRH880 - GR880 COMPOSED BY: N.1 PC 61214 - N.1 PC 61215 - N.1 PC 61025

OIL SEAL 85x105x13/18 (FOR SHAFT WITH CLOCKWISE ROTATION)

63330

1502384

1300974
1380160
1393331

● 3 TRUCK

★

93/143 P300/400/500/600

● 4 TRUCK

★

GR801R - GRS890 - GR/GRS900/R - GRSH900/R

● P-G-R-T TRUCK

★

GR801R - GRS890 - GR/GRS900/R - GRSH900/R - P602 - GR875 - GRS895 - GR/GRS/GRS0905 - GR875 - GRS895 - GR/GRS/GRS0905 - GR875R - GRS895R - GR/GRS/GRS0905R

● 3 BUS

★

K113 GR801 - K93/113 L113 - P40/400/50/500 GR801R

● 4 BUS

★

GR801R - GRS890 - GR/GRS900/R - GRSH900/R - GR801R P300/400

● F-K-N BUS

★

GR801R - GRS890 - GR/GRS900/R - GRSH900/R - P602 - GR875 - GRS895 - GR/GRS/GRS0905 - GR875 - GRS/GRS0895 - GR875R - GRS/GRS0895R



		Code	OEM new	OEM old
CONTROL CYLINDER	● Model	62469	1484808	1321420
	★ Application			
	● 3 TRUCK			
	★	GR801 - GR/GRS900 - GRH900 - GR/GRS900/R		
	● 4 TRUCK			
	★	GR900 - GRS - GRSH - GRS0900/R - GRS920/R - GRS890		
	● 3 BUS			
	★	GR801/R		
	● 4 BUS			
	★	GR/GRS/R		

		62470	1484809	1345151
CONTROL CYLINDER	● 3 TRUCK			
	★	GR801 - GR/GRS900 - TE70 - GRH900 - GR/GRS900R		
	● 4 TRUCK			
	★	GR900 - GR - GRSH - GRS0900/R - GRS920/R - GRS890 - OPTICRUISE		
	● P-G-R-T TRUCK			
	★	ALSO FOR		
	● 3 BUS			
	★	GR801/R - GR801 - K113		
	● 4 BUS			
	★	GR - GRS/R - OPTICRUISE CH 1843282 - CH 1843283 - CH 1830944		
● F-K-N BUS				
★				

		61333	244090	
SLIDING	● 3 BUS			
	★	G770/776/777 - GS771/772		
	● 3 TRUCK			
	★	G770 - GS771/772 - GR871 - GR/GRE871T		

ALL THE COMPONENTS LISTED IN OUR CATALOGUE ARE NOT ORIGINAL, THOUGH PERFECTLY INTERCHANGEABLE. REFERENCE NUMBERS, EITHER ORIGINAL OR OF A DIFFERENT NATURE, ARE FOR INFORMATION PURPOSES ONLY WHEN PLACING AN ORDER, PLEASE, ALWAYS USE COSIBO REFERENCE NUMBERS AND DO NOT MENTION THE ORIGINAL REFERENCE NUMBERS OF THE TRUCK MANUFACTURERS IN THE INVOICE TO VEHICLE OWNERS OR TO ANYBODY ELSE. THE CUSTOMER TAKES HIS OWN RESPONSIBILITY IF HE DOES NOT COMPLY WITH WHAT ABOVE.

	Code	OEM new	OEM old
SLIDER	63389	1305676	
● Model			
★ Application			
● 3 BUS			
★ K113 - GR801R			
● 3 TRUCK			
★ GR801 - GR/GRH/GRS900			
● 4 BUS			
★ GR801R			
● 4 TRUCK			
★ GR/GRS/GRSO/R - GRS890R - GR801R - GR/GRS900/R - GR/GRS920/R - GRSH900/R			
● F-K-N BUS			
★			
● P-G-R-T TRUCK			
★			



O-RING	63331	1472144	804666
● 3 TRUCK			
★ GRS900 - GRS900/R - GR801 - GR/GRS900R - GRH900 - GR801/900 - GRH900 - CP/CR93/113/143 - LHD - GR/GRH900 - CT93 - CP/CR/CT 113/143 - RHD - GR900 - GRS900 - CT 143 - LHD - GR/GRH900 - CT 143 - RHD - GR/GRH900 - CR 143 - LHD - GR900 - CG/CP/CR - RHD - GR/GRH900			
● 4 TRUCK			
★ GRS890/R - GRS920/R - GRS/GRSH900/R - OPTICRUISE - CT - RHD - GR/GRS900/R			
● P-G-R-T TRUCK			
★ GRS895/905/R - GRS0905/R - OPTICRUISE - GRS890/R - GRS920/R - GRS900/R - GRS0900/R - CT - RHD - GR875/R - GRS895/R - GR/GRS/GRSO905/R - OPTICRUISE			
● 3 BUS			
★ GR801/R - GR801 - K113			
● 4 BUS			
★ GR801/R - GR/GRS/R - OPTICRUISE			
● F-K-N BUS			
★ GRS895/905/R - GRS0905/R - OPTICRUISE - XPI - K D11/D12 - GR875/R - GRS/GRSO895/R - OPTICRUISE - GR801/R - K UD6X2			



	Code	OEM new	OEM old
O-RING	63332	1474732	804674
● Model			
★ Application			
● 3 TRUCK			
★	GS771/772 - GR801 - GR/GRS900/R - GRH900 - POWER TAKEOFF EK300 - EK310		
● 4 TRUCK			
★	OPTICRUISE - POWER TAKEOFF EK300 - EK310		
● P-G-R-T TRUCK			
★	OPTICRUISE		
● 3 BUS			
★	GS771/772 - GR801/R - K113		
● 4 BUS			
★	GR801/R - GR/GRS/R - OPTICRUISE		
● F-K-N BUS			
★	OPTICRUISE - GR801/R		



	63333	1472142	804713
O-RING			
● 3 TRUCK			
★	GR801 - GR/GRS900/R - GRH900		
● 4 TRUCK			
★	OPTICRUISE		
● P-G-R-T TRUCK			
★	OPTICRUISE		
● 3 BUS			
★	GR801/R - K113		
● 4 BUS			
★	GR801 - GR/GRS/R - OPTICRUISE		
● F-K-N BUS			
★	OPTICRUISE - GR801/R		



O-RING 200X5

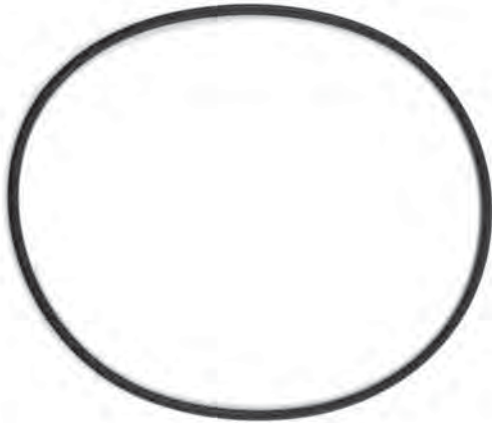

	Code	OEM new	OEM old
● Model	61643	1309563	
★ Application			
● 3 BUS			
★ G770			
● 3 TRUCK			
★ G770 - GR871 - GR/GRE871T - GR880T - GRH880 - GS771/772			

OIL SCRAPER RING



	63334	1515869	1315437
● 3 TRUCK			
★ GR801 - GR/GRS900/R - GRH900			
● 4 TRUCK			
★ OPTICRUISE			
● P-G-R-T TRUCK			
★ OPTICRUISE			
● 3 BUS			
★ GR801/R - K113			
● 4 BUS			
★ GR801/R - GR/GRS/R - OPTICRUISE			
● F-K-N BUS			
★ GR801/R - OPTICRUISE			

ALL THE COMPONENTS LISTED IN OUR CATALOGUE ARE NOT ORIGINAL, THOUGH PERFECTLY INTERCHANGEABLE. REFERENCE NUMBERS, EITHER ORIGINAL OR OF A DIFFERENT NATURE, ARE FOR INFORMATION PURPOSES ONLY WHEN PLACING AN ORDER, PLEASE, ALWAYS USE COSIBO REFERENCE NUMBERS AND DO NOT MENTION THE ORIGINAL REFERENCE NUMBERS OF THE TRUCK MANUFACTURERS IN THE INVOICE TO VEHICLE OWNERS OR TO ANYBODY ELSE. THE CUSTOMER TAKES HIS OWN RESPONSIBILITY IF HE DOES NOT COMPLY WITH WHAT ABOVE.



		Code	OEM new	OEM old
O-RING	● Model	63335	1472145	1303798
	★ Application			
	● 3 TRUCK			
	★	GR801 - GR/GRS900/R - GRH900		
	● 4 TRUCK			
	★	OPTICRUISE		
	● P-G-R-T TRUCK			
	★	OPTICRUISE		
	● 3 BUS			
	★	GR801/R - K113		
● 4 BUS				
★	GR801/R - GR/GRS/R - OPTICRUISE			
● F-K-N BUS				
★	OPTICRUISE - GR801/R			



REPAIR KIT (VITON BLACK O-RINGS)		63625	63625	
	● 4 TRUCK			
	★	OPTICRUISE		
	● P-G-R-T TRUCK			
	★	OPTICRUISE		

REPAIR KIT (VITON GREEN O-RINGS)		64363	1903797	
	● 4 TRUCK			
	★	OPTICRUISE		
	● P-G-R-T TRUCK			
	★	OPTICRUISE		

ALL THE COMPONENTS LISTED IN OUR CATALOGUE ARE NOT ORIGINAL, THOUGH PERFECTLY INTERCHANGEABLE. REFERENCE NUMBERS, EITHER ORIGINAL OR OF A DIFFERENT NATURE, ARE FOR INFORMATION PURPOSES ONLY WHEN PLACING AN ORDER, PLEASE, ALWAYS USE COSIBO REFERENCE NUMBERS AND DO NOT MENTION THE ORIGINAL REFERENCE NUMBERS OF THE TRUCK MANUFACTURERS IN THE INVOICE TO VEHICLE OWNERS OR TO ANYBODY ELSE. THE CUSTOMER TAKES HIS OWN RESPONSIBILITY IF HE DOES NOT COMPLY WITH WHAT ABOVE.

	Code	OEM new	OEM old
KIT O-RING (VITON)	65003	65003	
	<ul style="list-style-type: none"> ● Model ★ Application 		
	<ul style="list-style-type: none"> ● P-G-R-T TRUCK ★ GRS890R - GRS920R - GRS900R - GRS0900R 		
	<ul style="list-style-type: none"> ● 3 TRUCK ★ GRS900 CAG - GRS900R 		
	<ul style="list-style-type: none"> ● 4 TRUCK ★ GRS0900R - GRS/GRSH900R - GRS890R - GRS920R 		
SEAL RING	63344	1515870	1318762
	<ul style="list-style-type: none"> ● P-G-R-T TRUCK ★ GRS890R - GRS920R - GRS900R - GRS0900R 		
	<ul style="list-style-type: none"> ● 3 TRUCK ★ GRS900 CAG - GRS900R 		
	<ul style="list-style-type: none"> ● 4 TRUCK ★ GRS0900R - GRS/GRSH900R - GRS890R - GRS920R 		
O-RING	63339	1472718	804710
	<ul style="list-style-type: none"> ● F-K-N BUS ★ G670 - GR875R GRS/GRS0895R OPTICRUISE 		
	<ul style="list-style-type: none"> ● P-G-R-T TRUCK ★ GRS890R - GRS920R - GRS900R - GRS0900R - GR875R - GRS895R - GR/GRS/GRS0905R OPTICRUISE - G670 		
	<ul style="list-style-type: none"> ● 4 TRUCK ★ GRS890R - GRS920R - GRS0900R - GRS/GRSH900R 		

ALL THE COMPONENTS LISTED IN OUR CATALOGUE ARE NOT ORIGINAL, THOUGH PERFECTLY INTERCHANGEABLE. REFERENCE NUMBERS, EITHER ORIGINAL OR OF A DIFFERENT NATURE, ARE FOR INFORMATION PURPOSES ONLY WHEN PLACING AN ORDER, PLEASE, ALWAYS USE COSIBO REFERENCE NUMBERS AND DO NOT MENTION THE ORIGINAL REFERENCE NUMBERS OF THE TRUCK MANUFACTURERS IN THE INVOICE TO VEHICLE OWNERS OR TO ANYBODY ELSE. THE CUSTOMER TAKES HIS OWN RESPONSIBILITY IF HE DOES NOT COMPLY WITH WHAT ABOVE.

	Code	OEM new	OEM old
O-RING 15.3x2,4	63338	804658	397920
<ul style="list-style-type: none"> ● Model ★ Application 			
<ul style="list-style-type: none"> ● 3 TRUCK ★ 			
<ul style="list-style-type: none"> ● 4 TRUCK ★ 			
<ul style="list-style-type: none"> ● P-G-R-T TRUCK ★ 			
<ul style="list-style-type: none"> ● 3 BUS ★ 			
<ul style="list-style-type: none"> ● 4 BUS ★ 			
<ul style="list-style-type: none"> ● F-K-N BUS ★ 			



O-RING	63337	804672	390546
<ul style="list-style-type: none"> ● 3 TRUCK ★ GRS900 CAG - GRS900R - GRS900 			



O-RING SET (VITON)	65327	65327	
<ul style="list-style-type: none"> ● P-G-R-T TRUCK ★ GRS890R - GRS920R - GRS900R - GRS0900R NO.1 PC 63344 - NO.1 PC 63331 - NO.1 PC 63337 - NO.1 PC 63338 - NO.1 PC 63339 			
<ul style="list-style-type: none"> ● 4 TRUCK ★ GRS0900R - GRS/GRSH900R - GRS890R - GRS920R COMPOSED BY:NO.1 PC 63344 - NO.1 PC 63331 - NO.1 PC 63337 - NO.1 PC 63338 - NO.1 PC 63339 			

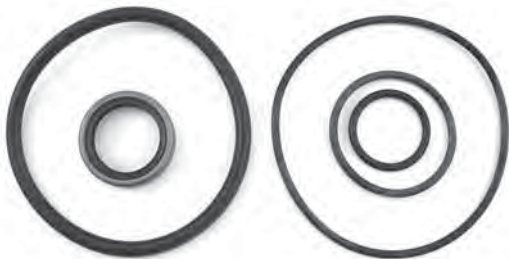

GEAR BOX BALL JOINT KIT



- Model
- ★ Application

Code

OEM new

OEM old

65315

550268

- 4 TRUCK



- P-G-R-T TRUCK



GEAR BOX BALL JOINT



- 4 TRUCK

- ★ CT LHD/RHD - CP/CR LHD - CT RHD GR/GRS900R - CT GRSH900

- P-G-R-T TRUCK

- ★ CT LHD/RHD - CH AWD

60754

1384624

1356022

GEARBOX BALL JOINT



- 3 BUS

- ★ GS771/772 - G770/776 - GR801

- 3 TRUCK

- ★ CR/CT 143 - CG/CP/CR/CT 93/113

61209

350270

ALL THE COMPONENTS LISTED IN OUR CATALOGUE ARE NOT ORIGINAL, THOUGH PERFECTLY INTERCHANGEABLE. REFERENCE NUMBERS, EITHER ORIGINAL OR OF A DIFFERENT NATURE, ARE FOR INFORMATION PURPOSES ONLY WHEN PLACING AN ORDER, PLEASE, ALWAYS USE COSIBO REFERENCE NUMBERS AND DO NOT MENTION THE ORIGINAL REFERENCE NUMBERS OF THE TRUCK MANUFACTURERS IN THE INVOICE TO VEHICLE OWNERS OR TO ANYBODY ELSE. THE CUSTOMER TAKES HIS OWN RESPONSIBILITY IF HE DOES NOT COMPLY WITH WHAT ABOVE.

GEARBOX BALL JOINT



● Model

★ Application

Code

OEM new

OEM old

63329

307443

● 3 BUS

★ G770/776 - GS771/772 - GR801

● 3 TRUCK

★ CG/CP - CP/CR/CT 93/113 - CR/CT 143 - GR801 - GR/GRS/GRH900 - GR880T - GRH880

LH GEARBOX BALL JOINT



60907

1384897

305319
371451

● 3 BUS

★ G770/776/777 - GS776 - GS771/772 - GR801 - K93/113 - L113 - G776/777 CS/CAG

● 3 TRUCK

★ CT93 LHD GR801/GR900 - CT113 LHD GR/GRS900 - CT143 LHD GR/GRS/GRH900 - CT143 GR880T/GRH880 - CG/CP/CR93 LHD/RHD GR801/900 - CG/CP113 LHD GR/GRS900 - CP/CR113 RHD - CP/CR113 LHD 4X4 6X4 6X6 - CP/CR113 RHD 4X4 6X6 - CP/CR113 LHD/RHD GR/GRS900 - CR143 LHD/RHD GR/GRH880 - CG/CP/CR93 RHD - CR113 LHD - CR143 LHD/RHD GR/GRS900R - CR143 EK330/340 - CR143 LHD GRH900 - CR113 RHD GRS900 DTC

● 4 TRUCK

★ CT LHD/RHD - CT RHD GR/GRS900R - CT GRSH900

● P-G-R-T TRUCK

★ CT LHD/RHD

ALL THE COMPONENTS LISTED IN OUR CATALOGUE ARE NOT ORIGINAL, THOUGH PERFECTLY INTERCHANGEABLE. REFERENCE NUMBERS, EITHER ORIGINAL OR OF A DIFFERENT NATURE, ARE FOR INFORMATION PURPOSES ONLY WHEN PLACING AN ORDER, PLEASE, ALWAYS USE COSIBO REFERENCE NUMBERS AND DO NOT MENTION THE ORIGINAL REFERENCE NUMBERS OF THE TRUCK MANUFACTURERS IN THE INVOICE TO VEHICLE OWNERS OR TO ANYBODY ELSE. THE CUSTOMER TAKES HIS OWN RESPONSIBILITY IF HE DOES NOT COMPLY WITH WHAT ABOVE.

		Code	OEM new	OEM old
LH GEARBOX BALL JOINT	● Model	60908	1384898	305320
	★ Application			
	● 3 BUS			
	★ G770/776/777 - GS776 - GS771/772 - GR801 - K93/113 - L113 - G776/777 CS/CAG			
	● 3 TRUCK			
	★ CT93 LHD GR801/GR900 - CT113 LHD GR/GRS900 - CT143 LHD GR/GRS/GRH900 - CT143 GR880T/GRH880 - CG/CP/CR93 LHD/RHD GR801/900 - CG/CP113 LHD GR/GRS900 - CP/CR113 RHD - CP/CR113 LHD 4X4 6X4 6X6 - CP/CR113 RHD 4X4 6X6 - CP/CR113 LHD/RHD GR/GRS900 - CR143 LHD/RHD GR/GRH880 - CG/CP/CR93 RHD - CR113 LHD - CR143 LHD/RHD GR/GRS900R - CR143 EK330/340 - CR143 LHD GRH900 - CR113 RHD GRS900 DTC			
	● 4 TRUCK			
	★ CT LHD/RHD - CT RHD GR/GRS900R - CT GRSH900			
	● P-G-R-T TRUCK			
	★ CT LHD/RHD			

TIE ROD WITH BALL JOINTS	61207	371453	
	● 3 BUS		
	★ G776/777 - GS771/772 - G776 RHD - GR801 LHD/RHD		

TIE ROD WITH BALL JOINTS	61208	1437727	1384896 371448
	● 3 BUS		
	★ G770		
	● 3 TRUCK		
	★ CT93 LHD GR801/900 - CP/CR/CT113 LHD GR/GRS900 - CP/CR113 RHD GR/GRS900 - CT143 LHD GRH900 - GR/GRS900 - CT143 GR880T/GRH880 - CG/CP/CR93 LHD/RHD GR801/900 - CG/CP/CR113 LHD - CG/CP113 GR/GRS900 - CP/CR113 RHD 4X4 6X6 - CP/CR113 LHD 4X4 6X4 - CR143 LHD/RHD - CR143 RHD GR/GRS900R - GR/GRH880 - CR143 LHD GRH900 - GR/GRS900R - CR143 EK330/340 - CR113 RHD GRS900 DTC		
	● 4 TRUCK		
	★ CP AWD - CP/CR - CP/CR LHD 4X4 6X6 - CP/CR LHD		
	● P-G-R-T TRUCK		
	★ CG/CP/CR - CP/CR AWD		

ALL THE COMPONENTS LISTED IN OUR CATALOGUE ARE NOT ORIGINAL, THOUGH PERFECTLY INTERCHANGEABLE. REFERENCE NUMBERS, EITHER ORIGINAL OR OF A DIFFERENT NATURE, ARE FOR INFORMATION PURPOSES ONLY WHEN PLACING AN ORDER, PLEASE, ALWAYS USE COSIBO REFERENCE NUMBERS AND DO NOT MENTION THE ORIGINAL REFERENCE NUMBERS OF THE TRUCK MANUFACTURERS IN THE INVOICE TO VEHICLE OWNERS OR TO ANYBODY ELSE. THE CUSTOMER TAKES HIS OWN RESPONSIBILITY IF HE DOES NOT COMPLY WITH WHAT ABOVE.

	Code	OEM new	OEM old
UNIVERSAL JOINT	64498	339129	
<ul style="list-style-type: none"> ● Model ★ Application 			
<ul style="list-style-type: none"> ● 3 BUS 			
★ G770			
<ul style="list-style-type: none"> ● 3 TRUCK 			
★ CG/CP/CR 93/113			
<ul style="list-style-type: none"> ● P-G-R-T TRUCK 			
★ CG - CP/CR GR875R GRS895R GR/GRS/GRS0905R			



	64498/2	64498/2	
UNIVERSAL JOINT ASSY			
<ul style="list-style-type: none"> ● 3 BUS 			
★ G770			
<ul style="list-style-type: none"> ● 3 TRUCK 			
★ CG/CP/CR 93/113			
<ul style="list-style-type: none"> ● P-G-R-T TRUCK 			
★ CG - CP/CR GR875R GRS895R GR/GRS/GRS0905R			



	62522	1441235	
GEAR SHIFT LEVER KNOB			
<ul style="list-style-type: none"> ● 4 TRUCK 			
★ CP/CR LHD - RHD 4X4 6X6 CH 1287575 - CH 4489426 - CH 9078306 - CP/CR LHD - RHD CH 1287575 - CH 4489426 - CH 9078306 - CP LHD DC12 03 4X4 6X6 CH 1287575 - CH 4489426 - CH 9078306 - CT LHD CH 3548836 - CT LHD - RHD CH 1294873 - CH 4510832 - CH 9087797 - CH 3546890			
<ul style="list-style-type: none"> ● P-G-R-T TRUCK 			
★ CR LHD - RHD - CP LHD - RHD CH 2018247 - CH 2018248 - CH 5150365 - CH 5150366 - CH 9111399 - CH 9111400 - CH 3589353 - CH 3589354 - CT LHD - RHD - CR/CP LHD - RHD GR875/R GR895/R GR/GRS/GRSO 905/R - CG LHD - RHD			



GEAR SHIFT LEVER KNOB



	Code	OEM new	OEM old
● Model	62527	1919065	1727377
★ Application			1438702

- **4 TRUCK**
- ★ CP/CR LHD/RHD GRS900/920 - CP LHD DC12 03 4X4 6X6 GRS900/920 - CT LHD GRS900/R - CT LHD/RHD GRS900/R
- **P-G-R-T TRUCK**
- ★ CT LHD GRS900/R GRS900/920/R GRS0900/R - CR LHD/RHD GR875/R GRS895/R GR/GRS/GRS0905/R - GRS900/920 GRS0900 - CP LHD/RHD GR875/R GRS895/R GR/GRS/GRS0905/R - GRS900/920 GRS0900 - CG LHD/RHD

GEAR SHIFT LEVER KNOB

**63057**

384970

- **3 TRUCK**
- ★ CT93/113/143 - CT93 GR871 - CT93 LHD GR801 - CG/CP LHD/RHD - CP/CR93/113 - CT93 LHD GR900 - CP/CR113 LHD 6X4 - CT113 LHD GR/GRS900 - CP113 GR/GRS900 - CP/CR113 LHD/RHD 4X4 6X6 - CT143 LHD GR/GRS900 - GRH900 - CP/CR93/113 RHD - CP/CR113 LHD/RHD G770 - GR871 - GR/GRS900 - CR143 GR880 - GR/GRS900

GEAR SHIFT LEVER KNOB

**63326**

1485717

1369555

- **3 TRUCK**
- ★ CP/CR/CT113 LHD GRS900 - CR/CT143 LHD GRS900 - CP/CR113 RHD GRS900
- **4 TRUCK**
- ★ CT RHD GR/GRS900R

ALL THE COMPONENTS LISTED IN OUR CATALOGUE ARE NOT ORIGINAL, THOUGH PERFECTLY INTERCHANGEABLE. REFERENCE NUMBERS, EITHER ORIGINAL OR OF A DIFFERENT NATURE, ARE FOR INFORMATION PURPOSES ONLY WHEN PLACING AN ORDER, PLEASE, ALWAYS USE COSIBO REFERENCE NUMBERS AND DO NOT MENTION THE ORIGINAL REFERENCE NUMBERS OF THE TRUCK MANUFACTURERS IN THE INVOICE TO VEHICLE OWNERS OR TO ANYBODY ELSE. THE CUSTOMER TAKES HIS OWN RESPONSIBILITY IF HE DOES NOT COMPLY WITH WHAT ABOVE.

GEAR SHIFT LEVER KNOB



● Model

★ Application

Code

OEM new

OEM old

63327

1482997

1362071

● 4 TRUCK

- ★ CP/CR RHD - CT GRSH900 - CT LHD GRS/GRSH900R - CP/CR LHD GRS900/920 - GRSH900 - RHD GRS900/920

GEAR SHIFT LEVER KNOB



64244

1369975

● 4 TRUCK

- ★ CT LHD GR900R - CP/CR LHD GR900 - RHD GR900

GEAR SHIFT LEVER KNOB SWITCH



63759

1377386

1317885

● 4 BUS

- ★ GR801R

● F-K-N BUS

- ★ GR801R

● 3 TRUCK

- ★ CP/CR113 LHD GR/GRS900 - CR143 GR/GRS900

● 4 TRUCK

- ★ CP/CR LHD/RHD - CT LHD GR/GRS - CT RHD GR/GRS900R - CT GRSH900 - GR/GRS890 - GRS920

ALL THE COMPONENTS LISTED IN OUR CATALOGUE ARE NOT ORIGINAL, THOUGH PERFECTLY INTERCHANGEABLE. REFERENCE NUMBERS, EITHER ORIGINAL OR OF A DIFFERENT NATURE, ARE FOR INFORMATION PURPOSES ONLY WHEN PLACING AN ORDER, PLEASE, ALWAYS USE COSIBO REFERENCE NUMBERS AND DO NOT MENTION THE ORIGINAL REFERENCE NUMBERS OF THE TRUCK MANUFACTURERS IN THE INVOICE TO VEHICLE OWNERS OR TO ANYBODY ELSE. THE CUSTOMER TAKES HIS OWN RESPONSIBILITY IF HE DOES NOT COMPLY WITH WHAT ABOVE.

	Code	OEM new	OEM old
GEAR SHIFT ROD	63110	1515117	1428073
● Model			
★ Application			
● 4 TRUCK			
★ CR - DC9 14			



	63112	1515118	1426263
GEAR SHIFT ROD			
● 4 TRUCK			
★ CP			



	63328	339130	
BEARING			
● 3 BUS			
★ G770			
● 3 TRUCK			
★ CG/CP - CP/CR/CT 93/113 - CT 143 - GR801 - GR/GRH/GRS900			
● 4 TRUCK			
★ CP/CR/CT - DC12 03			
● P-G-R-T TRUCK			
★ CG/CP/CR/CT - GR875R - GRS895R - GR/GRS/GRS0905R - G670			



ALL THE COMPONENTS LISTED IN OUR CATALOGUE ARE NOT ORIGINAL, THOUGH PERFECTLY INTERCHANGEABLE. REFERENCE NUMBERS, EITHER ORIGINAL OR OF A DIFFERENT NATURE, ARE FOR INFORMATION PURPOSES ONLY WHEN PLACING AN ORDER, PLEASE, ALWAYS USE COSIBO REFERENCE NUMBERS AND DO NOT MENTION THE ORIGINAL REFERENCE NUMBERS OF THE TRUCK MANUFACTURERS IN THE INVOICE TO VEHICLE OWNERS OR TO ANYBODY ELSE. THE CUSTOMER TAKES HIS OWN RESPONSIBILITY IF HE DOES NOT COMPLY WITH WHAT ABOVE.

	Code	OEM new	OEM old
BEARING	64357	1325383	
<ul style="list-style-type: none"> ● Model ★ Application 			
<ul style="list-style-type: none"> ● 4 TRUCK ★ CP/CR/CT - DC12 03 			
<ul style="list-style-type: none"> ● P-G-R-T TRUCK ★ CP/CR/CT 			



BRACKET	64686	1548318	1412052
<ul style="list-style-type: none"> ● 4 TRUCK ★ CP AWD - CP/ CR - CP/ CR LHD 4X4 - 6X6 CH 1287575 - CH 4489426 - CH 9078306 - CP/ CR LHD CH 1287574 - CH 9078305 - CH 4489425 			
<ul style="list-style-type: none"> ● P-G-R-T TRUCK ★ CP/ CR/ CG AWD - CR - CP CH 2018247 - CH 2018248 - CH 5150365 - CH 5150366 - CH 9111399 - CH 9111400 - CH 3589353 - CH 3589354 - CP GR50H901R 			



REPAIR KIT FOR OUR REF 64686	64332	64332	
<ul style="list-style-type: none"> ● 4 TRUCK ★ CP AWD - CP/CR - CP/CR LHD 4X4 - 6X6 CH 1287575 - CH 4489426 - CH 9078306 - CP/CR LHD CH 1287574 - CH 9078305 - CH 4489425 			
<ul style="list-style-type: none"> ● P-G-R-T TRUCK ★ CP/CR/CG AWD - CR - CP CH 2018247 - CH 2018248 - CH 5150365 - CH 5150366 - CH 9111399 - CH 9111400 - CH 3589353 - CH 3589354 - CP GR50H901R 			



RUBBER SPACER	64687	1391831	
<ul style="list-style-type: none"> ● 4 TRUCK ★ CP/CR 			
<ul style="list-style-type: none"> ● P-G-R-T TRUCK ★ CP/CR 			



ALL THE COMPONENTS LISTED IN OUR CATALOGUE ARE NOT ORIGINAL, THOUGH PERFECTLY INTERCHANGEABLE. REFERENCE NUMBERS, EITHER ORIGINAL OR OF A DIFFERENT NATURE, ARE FOR INFORMATION PURPOSES ONLY WHEN PLACING AN ORDER, PLEASE, ALWAYS USE COSIBO REFERENCE NUMBERS AND DO NOT MENTION THE ORIGINAL REFERENCE NUMBERS OF THE TRUCK MANUFACTURERS IN THE INVOICE TO VEHICLE OWNERS OR TO ANYBODY ELSE. THE CUSTOMER TAKES HIS OWN RESPONSIBILITY IF HE DOES NOT COMPLY WITH WHAT ABOVE.

	Code	OEM new	OEM old
BUSHING	64688	1391830	
<ul style="list-style-type: none"> ● Model ★ Application 			
<ul style="list-style-type: none"> ● 4 TRUCK ★ CP/CR 			
<ul style="list-style-type: none"> ● P-G-R-T TRUCK ★ CP/CR 			



BOOT	61628	393107	321297
<ul style="list-style-type: none"> ● 3 TRUCK ★ CR 93 - CP/CR 113 - CR 143 - GR/GRS900 - GR880 - G770 - GR871 			



BOOT	61629	393108	310243
<ul style="list-style-type: none"> ● 3 TRUCK ★ CR 93 - CP/CR 113 - CR 143 - GR/GRS900 - GR880 - G770 - GR871 			



BOOT	62229	395634	
<ul style="list-style-type: none"> ● 3 TRUCK ★ CT 93/113/143 - GR871 - GR801 - GR/GRH/GRS900 			



ALL THE COMPONENTS LISTED IN OUR CATALOGUE ARE NOT ORIGINAL, THOUGH PERFECTLY INTERCHANGEABLE. REFERENCE NUMBERS, EITHER ORIGINAL OR OF A DIFFERENT NATURE, ARE FOR INFORMATION PURPOSES ONLY WHEN PLACING AN ORDER, PLEASE, ALWAYS USE COSIBO REFERENCE NUMBERS AND DO NOT MENTION THE ORIGINAL REFERENCE NUMBERS OF THE TRUCK MANUFACTURERS IN THE INVOICE TO VEHICLE OWNERS OR TO ANYBODY ELSE. THE CUSTOMER TAKES HIS OWN RESPONSIBILITY IF HE DOES NOT COMPLY WITH WHAT ABOVE.

	Code	OEM new	OEM old
BOOT	62230	395635	
<ul style="list-style-type: none"> ● Model ★ Application 			
<ul style="list-style-type: none"> ● 3 TRUCK ★ CT 93/113/143 - GR871 - GR801 - GR/GRH/GRS900 			





BOOT	62231	1102585	
<ul style="list-style-type: none"> ● 3 TRUCK ★ CR 93 - CP/CR 113 - CR 143 - GR/GRS900 - GR880 - G770 - GR871 			



BOOT	65180	287379	
<ul style="list-style-type: none"> ● 3 TRUCK ★ CT 143 GR880T GRH880 			



	Code	OEM new	OEM old
BOOT	65181	287380	
	<ul style="list-style-type: none"> ● Model ★ Application 		
	<ul style="list-style-type: none"> ● 3 TRUCK ★ CT 143 GR880T GRH880 		
BOOT	65182	339141	248326 302948
	<ul style="list-style-type: none"> ● 3 BUS ★ G770 		
	<ul style="list-style-type: none"> ● 3 TRUCK ★ CG/CP - CP/CR 93/113 - CT 93 - GR/GRS900 - GR801 		
BOOT	65183	1300097	248325 339140
	<ul style="list-style-type: none"> ● 3 BUS ★ G770 		
	<ul style="list-style-type: none"> ● 3 TRUCK ★ CG/CP - CP/CR 93/113 - CT 93 - GR/GRS900 - GR801 		
BOOT	65184	349034	
	<ul style="list-style-type: none"> ● 3 BUS ★ GR801 - GR/GRS900 - G770 - GS771 - K 113 		
	<ul style="list-style-type: none"> ● 3 TRUCK ★ CG/CP/CR/CT 93 - CG/CP/CR/CT 113 - CP/CR/CT 143 - GR/GRH880 - GR880T - GR801 - GR/GRH/GRS900 - 		

ALL THE COMPONENTS LISTED IN OUR CATALOGUE ARE NOT ORIGINAL, THOUGH PERFECTLY INTERCHANGEABLE. REFERENCE NUMBERS, EITHER ORIGINAL OR OF A DIFFERENT NATURE, ARE FOR INFORMATION PURPOSES ONLY WHEN PLACING AN ORDER, PLEASE, ALWAYS USE COSIBO REFERENCE NUMBERS AND DO NOT MENTION THE ORIGINAL REFERENCE NUMBERS OF THE TRUCK MANUFACTURERS IN THE INVOICE TO VEHICLE OWNERS OR TO ANYBODY ELSE. THE CUSTOMER TAKES HIS OWN RESPONSIBILITY IF HE DOES NOT COMPLY WITH WHAT ABOVE.

	Code	OEM new	OEM old
BOOT	62232	1356372	
<ul style="list-style-type: none"> ● Model ★ Application 			
<ul style="list-style-type: none"> ● 4 TRUCK 			
<ul style="list-style-type: none"> ★ CP/CR - DC12 03 			
<ul style="list-style-type: none"> ● P-G-R-T TRUCK 			
<ul style="list-style-type: none"> ★ CG/CP/CR - GR875R - GRS895R - GR/GRS/GRS0905R - CP G670 			



BOOT	66585	1346608	
<ul style="list-style-type: none"> ● 4 TRUCK 			
<ul style="list-style-type: none"> ★ CP/CR LHD 4X4 6X6 - CP LHD DC12 03 4X4 6X6 			



BOOT	66583	1346606	
<ul style="list-style-type: none"> ● 4 TRUCK 			
<ul style="list-style-type: none"> ★ CP/CR LHD 4X4 6X6 - CP LHD DC12 03 4X4 6X6 			



	Code	OEM new	OEM old
BOOT	66578/1	1346612	
<ul style="list-style-type: none"> ● Model ★ Application 			
<ul style="list-style-type: none"> ● 4 TRUCK ★ CT - GR/GRS900R - GRH900 			
<ul style="list-style-type: none"> ● P-G-R-T TRUCK ★ CT 			



RUBBER BUFFER	66580/1	1514089	1427926
<ul style="list-style-type: none"> ● 4 TRUCK ★ CT - GR/GRS900R 			
<ul style="list-style-type: none"> ● P-G-R-T TRUCK ★ CT 			



GEARBOX ROD	63844	1379621	
<ul style="list-style-type: none"> ● 4 TRUCK ★ CP/CR LHD CH 1273918 - CH 4457600 - CH 9063964 			



ALL THE COMPONENTS LISTED IN OUR CATALOGUE ARE NOT ORIGINAL, THOUGH PERFECTLY INTERCHANGEABLE. REFERENCE NUMBERS, EITHER ORIGINAL OR OF A DIFFERENT NATURE, ARE FOR INFORMATION PURPOSES ONLY WHEN PLACING AN ORDER, PLEASE, ALWAYS USE COSIBO REFERENCE NUMBERS AND DO NOT MENTION THE ORIGINAL REFERENCE NUMBERS OF THE TRUCK MANUFACTURERS IN THE INVOICE TO VEHICLE OWNERS OR TO ANYBODY ELSE. THE CUSTOMER TAKES HIS OWN RESPONSIBILITY IF HE DOES NOT COMPLY WITH WHAT ABOVE.

	Code	OEM new	OEM old
GEARBOX ROD	63845	1472771	1472879



- **Model**

- ★ **Application**

- **4 TRUCK**

- ★ CP/CR CH 1273919 - CP/CR LHD CH 9063964 - CH 4457601 - CH 9063965

O-RING	64790	804670	
---------------	--------------	--------	--

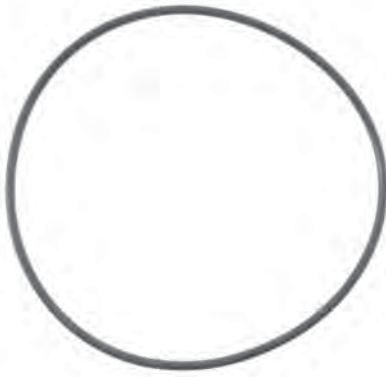

- **3 BUS**

- ★ GR801 WITH OPTICRUISE - GS771 WITH OPTICRUISE NEOPLAN - K93/113 - L113

- **4 BUS**

- ★ GR801 WITH OPTICRUISE

- **F-K-N BUS**

- ★ GR801 WITH OPTICRUISE

	Code	OEM new	OEM old
RUBBER HOSE	61212	346627	
	<ul style="list-style-type: none"> ● Model ★ Application 		
	<ul style="list-style-type: none"> ● 3 TRUCK ★ GR/GRS900 - GR/GRS/GRH900 - GRE871 - CR/CT143 GRH880 - CT113 		
SILICONE HOSE	63229	412080	
	<ul style="list-style-type: none"> ● 3 BUS ★ GA781R ● 3 TRUCK ★ GR/GRS900R - GA850R 		
RUBBER HOSE	61793	298823	
	<ul style="list-style-type: none"> ● 3 TRUCK ★ CP/CR/CT 113 		
RUBBER HOSE	63176	318364	
	<ul style="list-style-type: none"> ● P-G-R-T TRUCK ★ GRSOH 901R 		

ALL THE COMPONENTS LISTED IN OUR CATALOGUE ARE NOT ORIGINAL, THOUGH PERFECTLY INTERCHANGEABLE. REFERENCE NUMBERS, EITHER ORIGINAL OR OF A DIFFERENT NATURE, ARE FOR INFORMATION PURPOSES ONLY WHEN PLACING AN ORDER, PLEASE, ALWAYS USE COSIBO REFERENCE NUMBERS AND DO NOT MENTION THE ORIGINAL REFERENCE NUMBERS OF THE TRUCK MANUFACTURERS IN THE INVOICE TO VEHICLE OWNERS OR TO ANYBODY ELSE. THE CUSTOMER TAKES HIS OWN RESPONSIBILITY IF HE DOES NOT COMPLY WITH WHAT ABOVE.

	Code	OEM new	OEM old
RETARDER RUBBER HOSE	65122	1541549	1377997 1512422
	<ul style="list-style-type: none"> ● Model ★ Application 		
	<ul style="list-style-type: none"> ● 4 TRUCK ★ DC14 GRS/GRSH900R - DC11 01/04/06/07 - DC12 GRS890R - GR/GRS/GRSO900R - DC11 74/75 - OSC11 G03 GRS890R - GR/GRS/GRSO900R - DC9 GRS890R - GR/GRS/GRSO900R - GA750/751R - GA851/852R - DC16 GRS/GRSO900/920R 		
	<ul style="list-style-type: none"> ● P-G-R-T TRUCK ★ DC9/11/12/16 - FOR CH 2034902 - CH 5196997 - CH 9129358 - CH 3621168 		
RUBBER HOSE	63601	1377231	
	<ul style="list-style-type: none"> ● 4 BUS ★ F 94 		
RUBBER HOSE	65129	1374040	
	<ul style="list-style-type: none"> ● 4 TRUCK ★ GA750/751R 		
RUBBER HOSE	61703	297394	
	<ul style="list-style-type: none"> ● 3 BUS ★ K 113 ● 3 TRUCK ★ GRH880 ● 4 BUS ★ CN - N 94 		

ALL THE COMPONENTS LISTED IN OUR CATALOGUE ARE NOT ORIGINAL, THOUGH PERFECTLY INTERCHANGEABLE. REFERENCE NUMBERS, EITHER ORIGINAL OR OF A DIFFERENT NATURE, ARE FOR INFORMATION PURPOSES ONLY WHEN PLACING AN ORDER, PLEASE, ALWAYS USE COSIBO REFERENCE NUMBERS AND DO NOT MENTION THE ORIGINAL REFERENCE NUMBERS OF THE TRUCK MANUFACTURERS IN THE INVOICE TO VEHICLE OWNERS OR TO ANYBODY ELSE. THE CUSTOMER TAKES HIS OWN RESPONSIBILITY IF HE DOES NOT COMPLY WITH WHAT ABOVE.

		Code	OEM new	OEM old
GASKET	● Model	61366	1535698	224915
	★ Application			
	● 3 BUS			
	★ G770			
	● 3 TRUCK			
	★ G770 - GS771/772 - GR871 - GR/GRE871T - GR880T - GRH880 - EK330/340/421/422/423			
	● 4 TRUCK			
★ EK330/340/630/640				
● P-G-R-T TRUCK				
★ EK630/640				



		60635	197800	392661
O-RING DIAM.26,2X3	● 3 TRUCK			
	★ EGR882			



		62453	1854058	1380106
RETARDER RUBBER HOSE	● 4 TRUCK			
	★ GA750/751R - GA851/852R - GRS890R - GR/GRS900/920R - GRS0920R - DC11 01/04/06/07 - DC12 GRS890R - GR/GRS/GRS0900R - DC14 GRSH900R			
	● P-G-R-T TRUCK			
★ GA750/760R - GA850/860R - DT12				



		62478	1377566	
RETARDER RUBBER HOSE	● 4 TRUCK			
	★ DC11 01/04/06/07 - DC12 GRS890R - GR/GRS/GRS0900R - DC14 GRSH900R			
	● P-G-R-T TRUCK			
★ DC9/11/12				



ALL THE COMPONENTS LISTED IN OUR CATALOGUE ARE NOT ORIGINAL, THOUGH PERFECTLY INTERCHANGEABLE. REFERENCE NUMBERS, EITHER ORIGINAL OR OF A DIFFERENT NATURE, ARE FOR INFORMATION PURPOSES ONLY WHEN PLACING AN ORDER, PLEASE, ALWAYS USE COSIBO REFERENCE NUMBERS AND DO NOT MENTION THE ORIGINAL REFERENCE NUMBERS OF THE TRUCK MANUFACTURERS IN THE INVOICE TO VEHICLE OWNERS OR TO ANYBODY ELSE. THE CUSTOMER TAKES HIS OWN RESPONSIBILITY IF HE DOES NOT COMPLY WITH WHAT ABOVE.

RETARDER RUBBER HOSE



● Model

★ Application

Code

OEM new

OEM old

62479

1377567

● 4 TRUCK

- ★ DC11 01/04/06/07 - DC12 GRS890R - GR/GRS/GRSO/900R - DC9 GRS890R - GR/GRS/GRSO900R - DC14 GRSH/900/900R - GA750/751R - DC16 GRS900/920R

RETARDER RUBBER HOSE



63867

1797845

1370488

● 4 TRUCK

- ★ 114/124 CP/CR14 - CPCR19 - GRS890R - GR/GRS/GRSO/900/920R - GA750/751R - GA851/852R - DC14 GRSH900/900R

● P-G-R-T TRUCK

- ★ GA750/760R - GA850/860R - GRSO901R - GR875/905R - GRS895/905R - GRSO905R

TEMPERATURE SENSOR



65187

1300043

● 3 TRUCK

- ★ GR871 - GR/GRE871T - GR880T

● 4 TRUCK

- ★ GR/GRS/GRSO/R - GRS920R AIR DC16 - 6X2/4 8X2/4

● P-G-R-T TRUCK

- ★ GRS920R - GRSO920R AIR DC16

ALL THE COMPONENTS LISTED IN OUR CATALOGUE ARE NOT ORIGINAL, THOUGH PERFECTLY INTERCHANGEABLE. REFERENCE NUMBERS, EITHER ORIGINAL OR OF A DIFFERENT NATURE, ARE FOR INFORMATION PURPOSES ONLY WHEN PLACING AN ORDER, PLEASE, ALWAYS USE COSIBO REFERENCE NUMBERS AND DO NOT MENTION THE ORIGINAL REFERENCE NUMBERS OF THE TRUCK MANUFACTURERS IN THE INVOICE TO VEHICLE OWNERS OR TO ANYBODY ELSE. THE CUSTOMER TAKES HIS OWN RESPONSIBILITY IF HE DOES NOT COMPLY WITH WHAT ABOVE.

	Code	OEM new	OEM old
RUBBER MOUNTING	60142	146526	
<ul style="list-style-type: none"> ● Model ★ Application 			
<ul style="list-style-type: none"> ● 3 TRUCK 			
<ul style="list-style-type: none"> ★ GR871 - GR871/880T - GRE871T - GRH880 - G770 - GS771/772 - GA/GAE770 - GR801/900 - GR/GRS900 - GR900 4X4 6X6 			
<ul style="list-style-type: none"> ● 4 TRUCK 			
<ul style="list-style-type: none"> ★ GRSH900R 			
<ul style="list-style-type: none"> ● P-G-R-T TRUCK 			
<ul style="list-style-type: none"> ★ GRSOH901R 			



RUBBER MOUNTING	60405	332738	137207
<ul style="list-style-type: none"> ● 3 BUS 			
<ul style="list-style-type: none"> ★ G776/777 - GS771/772 - GA773/775/781R - GR801R - GR801 			
<ul style="list-style-type: none"> ● 3 TRUCK 			
<ul style="list-style-type: none"> ★ GRH880/900 - GR880T TE70 - GR/GRS/GRH900 TE70 			



ENGINE & GEARBOX MOUNTING	62040	1336882	
<ul style="list-style-type: none"> ● 4 BUS 			
<ul style="list-style-type: none"> ★ L/K 			
<ul style="list-style-type: none"> ● 4 TRUCK 			
<ul style="list-style-type: none"> ★ GR/GRS/GRS0900R 			

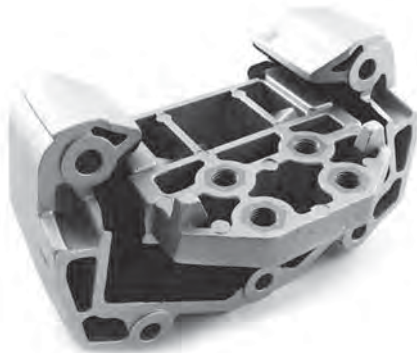





GEARBOX MOUNTING







	Code	OEM new	OEM old
● Model	62439	1921972	1469287
★ Application			1782203
● 4 BUS			
★	GR801R		
● F-K-N BUS			
★	GR875R - GRS/GRS0985R - GR/GRS/GRS0905 - GR801R - G701 - N -		
● 4 TRUCK			
★	GRS890R 8X8 WLS - GR/GRS 6X2 ad2900 - GRSH900R - GR/GRS 4X4 6X6 - GR/GRS/GRS0		
● P-G-R-T TRUCK			
★	4X4 6X6 - GRS0H901R - G670 - GR801R - GRS890R - GR/GRS/GRS0900R - GRS920R - GR875R - GRS/GRS0985R - GR/GRS/GRS0905R		





ALL THE COMPONENTS LISTED IN OUR CATALOGUE ARE NOT ORIGINAL, THOUGH PERFECTLY INTERCHANGEABLE. REFERENCE NUMBERS, EITHER ORIGINAL OR OF A DIFFERENT NATURE, ARE FOR INFORMATION PURPOSES ONLY WHEN PLACING AN ORDER, PLEASE, ALWAYS USE COSIBO REFERENCE NUMBERS AND DO NOT MENTION THE ORIGINAL REFERENCE NUMBERS OF THE TRUCK MANUFACTURERS IN THE INVOICE TO VEHICLE OWNERS OR TO ANYBODY ELSE. THE CUSTOMER TAKES HIS OWN RESPONSIBILITY IF HE DOES NOT COMPLY WITH WHAT ABOVE.

	Code	OEM new	OEM old
<p>CLAMP D.6</p> 	64082	813933	
<ul style="list-style-type: none"> ● Model ★ Application 			
<ul style="list-style-type: none"> ● 3 BUS ★ 			
<ul style="list-style-type: none"> ● 3 TRUCK ★ 			
<p>CLAMP D.10</p> 	64083	813935	
<ul style="list-style-type: none"> ● 4 BUS ★ 			
<ul style="list-style-type: none"> ● 3 TRUCK ★ 			
<p>CLAMP D. 16</p> 	64084	813937	
<ul style="list-style-type: none"> ● 4 BUS ★ 			
<ul style="list-style-type: none"> ● F-K-N BUS ★ 			
<ul style="list-style-type: none"> ● 3 TRUCK ★ 			
<p>CLAMP D.20</p> 	64085	813939	
<ul style="list-style-type: none"> ● 3 BUS ★ 			
<ul style="list-style-type: none"> ● 3 TRUCK ★ 			

ALL THE COMPONENTS LISTED IN OUR CATALOGUE ARE NOT ORIGINAL, THOUGH PERFECTLY INTERCHANGEABLE. REFERENCE NUMBERS, EITHER ORIGINAL OR OF A DIFFERENT NATURE, ARE FOR INFORMATION PURPOSES ONLY WHEN PLACING AN ORDER, PLEASE, ALWAYS USE COSIBO REFERENCE NUMBERS AND DO NOT MENTION THE ORIGINAL REFERENCE NUMBERS OF THE TRUCK MANUFACTURERS IN THE INVOICE TO VEHICLE OWNERS OR TO ANYBODY ELSE. THE CUSTOMER TAKES HIS OWN RESPONSIBILITY IF HE DOES NOT COMPLY WITH WHAT ABOVE.

	Code	OEM new	OEM old
<p>CLAMP D.25</p> 	64086	813941	
<ul style="list-style-type: none"> ● Model ★ Application 			
<ul style="list-style-type: none"> ● 3 BUS ★ 			
<ul style="list-style-type: none"> ● 4 BUS ★ 			
<ul style="list-style-type: none"> ● 3 TRUCK ★ 			
<p>CLAMP D.8</p> 	64090	813934	
<ul style="list-style-type: none"> ● F-K-N BUS ★ 			
<ul style="list-style-type: none"> ● 3 TRUCK ★ 			
<p>CLAMP D.13</p> 	64091	813936	
<ul style="list-style-type: none"> ● 3 TRUCK ★ 			
<ul style="list-style-type: none"> ● P-G-R-T TRUCK ★ 			
<p>CLAMP D.18</p> 	64092	813938	
<ul style="list-style-type: none"> ● F-K-N BUS ★ 			
<ul style="list-style-type: none"> ● IND. MARINE ENGINE 4 ★ 			
<ul style="list-style-type: none"> ● 3 TRUCK ★ 			
<ul style="list-style-type: none"> ● 4 TRUCK ★ 			

ALL THE COMPONENTS LISTED IN OUR CATALOGUE ARE NOT ORIGINAL, THOUGH PERFECTLY INTERCHANGEABLE. REFERENCE NUMBERS, EITHER ORIGINAL OR OF A DIFFERENT NATURE, ARE FOR INFORMATION PURPOSES ONLY WHEN PLACING AN ORDER, PLEASE, ALWAYS USE COSIBO REFERENCE NUMBERS AND DO NOT MENTION THE ORIGINAL REFERENCE NUMBERS OF THE TRUCK MANUFACTURERS IN THE INVOICE TO VEHICLE OWNERS OR TO ANYBODY ELSE. THE CUSTOMER TAKES HIS OWN RESPONSIBILITY IF HE DOES NOT COMPLY WITH WHAT ABOVE.

	Code	OEM new	OEM old
<p>CLAMP D.22</p> 	64093	813940	
<ul style="list-style-type: none"> ● Model ★ Application 			
<ul style="list-style-type: none"> ● 3 BUS ★ 			
<ul style="list-style-type: none"> ● 3 TRUCK ★ 			
<p>CLAMP D. 45</p> 	64094	813942	
<ul style="list-style-type: none"> ● 3 TRUCK ★ 			
<p>CLAMP D.28</p> 	64095	804578	
<ul style="list-style-type: none"> ● 3 TRUCK ★ 			
<p>CLAMP D.32</p> 	64100	804583	
<ul style="list-style-type: none"> ● 3 BUS ★ 			
<ul style="list-style-type: none"> ● 4 BUS ★ 			
<ul style="list-style-type: none"> ● 3 TRUCK ★ 			

ALL THE COMPONENTS LISTED IN OUR CATALOGUE ARE NOT ORIGINAL, THOUGH PERFECTLY INTERCHANGEABLE. REFERENCE NUMBERS, EITHER ORIGINAL OR OF A DIFFERENT NATURE, ARE FOR INFORMATION PURPOSES ONLY WHEN PLACING AN ORDER, PLEASE, ALWAYS USE COSIBO REFERENCE NUMBERS AND DO NOT MENTION THE ORIGINAL REFERENCE NUMBERS OF THE TRUCK MANUFACTURERS IN THE INVOICE TO VEHICLE OWNERS OR TO ANYBODY ELSE. THE CUSTOMER TAKES HIS OWN RESPONSIBILITY IF HE DOES NOT COMPLY WITH WHAT ABOVE.

CENTER BEARING



	Code	OEM new	OEM old
● Model	64522	294271	
★ Application			
● 3 BUS			
★ PF40/P410			
● 3 TRUCK			
★ PF30/P310 - PF40/P410 - PF50/P510 - PF60/P610 - P510			

CENTER BEARING



	64522/1	294270	
● 3 BUS			
★ PF40/P410			
● 3 TRUCK			
★ PF30/P310 - PF40/P410 - PF50/P510 - PF60/P610 - P510			

CENTER BEARING



	62041	1113033	
● 3 TRUCK			
★ PF30/P310 - PF40/P410 - PF50/P510 - PF60/P610 - PF60/P610 6X2 6X4 8X2 8X4 - P410 - P410 GA750 4X2/Z 6X2B/Z R641/642 93ML/HL - P410 GA750 4X2B R641/642 93MV - P410 GA750 6X2/4B R641/642 93ML - P410 GA850R 4X2B/Z 6X2B/Z R660 93/113 ML/HL			
● 4 TRUCK			
★ P610 4X4 6X6 - P610 124CB6X6NZ ad 6300 GRS890/900R RBP730/832 - P310/410/510 - P510 124CB6X6HZ ad 6300 GRS890/900R RBP730/832			
● P-G-R-T TRUCK			
★ P610 4X4 6X6			
● 3 BUS			
★ PF40/P410 - P410			
● 4 BUS			
★ P310/410			

ALL THE COMPONENTS LISTED IN OUR CATALOGUE ARE NOT ORIGINAL, THOUGH PERFECTLY INTERCHANGEABLE. REFERENCE NUMBERS, EITHER ORIGINAL OR OF A DIFFERENT NATURE, ARE FOR INFORMATION PURPOSES ONLY WHEN PLACING AN ORDER, PLEASE, ALWAYS USE COSIBO REFERENCE NUMBERS AND DO NOT MENTION THE ORIGINAL REFERENCE NUMBERS OF THE TRUCK MANUFACTURERS IN THE INVOICE TO VEHICLE OWNERS OR TO ANYBODY ELSE. THE CUSTOMER TAKES HIS OWN RESPONSIBILITY IF HE DOES NOT COMPLY WITH WHAT ABOVE.

CENTER BEARING



	Code	OEM new	OEM old
● Model	64524	1113031	
★ Application			
● 3 TRUCK			
★	PF30/P310 - PF40/P410 - PF50/P510 - PF60/P610 - PF60/P610 6X2 6X4 8X2 8X4 - P410 - P410 GA750 4X2/Z 6X2B/Z R641/642 93ML/HL - P410 GA750 4X2B R641/642 93MV - P410 GA750 6X2/4B R641/642 93ML - P410 GA850R 4X2B/Z 6X2B/Z R660 93/113 ML/HL		
● 4 TRUCK			
★	P610 4X4 6X6 - P610 124CB6X6NZ ad 6300 GRS890/900R RBP730/832 - P310/410/510 - P510 124CB6X6HZ ad 6300 GRS890/900R RBP730/832		
● P-G-R-T TRUCK			
★	P610 4X4 6X6		
● 3 BUS			
★	PF40/P410 - P410		
● 4 BUS			
★	P310/410		

CENTER BEARING



	64633	1387764	
● 4 TRUCK			
★	P310/410/510/610/612		
● P-G-R-T TRUCK			
★	P310/410/510/610/612		
● 4 BUS			
★	P310/410		

CENTER BEARING



	64634	1387794	
● 4 TRUCK			
★	P310/410/510/610/612		
● P-G-R-T TRUCK			
★	P310/410/510/610/612		
● 4 BUS			
★	P310/410		

ALL THE COMPONENTS LISTED IN OUR CATALOGUE ARE NOT ORIGINAL, THOUGH PERFECTLY INTERCHANGEABLE. REFERENCE NUMBERS, EITHER ORIGINAL OR OF A DIFFERENT NATURE, ARE FOR INFORMATION PURPOSES ONLY WHEN PLACING AN ORDER, PLEASE, ALWAYS USE COSIBO REFERENCE NUMBERS AND DO NOT MENTION THE ORIGINAL REFERENCE NUMBERS OF THE TRUCK MANUFACTURERS IN THE INVOICE TO VEHICLE OWNERS OR TO ANYBODY ELSE. THE CUSTOMER TAKES HIS OWN RESPONSIBILITY IF HE DOES NOT COMPLY WITH WHAT ABOVE.

	Code	OEM new	OEM old
LOCK NUT	65091	315085	
<ul style="list-style-type: none"> ● Model ★ Application 			
<ul style="list-style-type: none"> ● 3 TRUCK ★ PF30/310 - PF40/P410 - PF50/P510 - PF40 4X2 6X2 TELMA - PF50 GR880T 4X2 6X2 6X4 TELMA - PF50 4X2 6X2 6X4 TELMA - P510 6X4 TELMA 			
<ul style="list-style-type: none"> ● 3 BUS ★ PF40/P410 			



PROPELLER SHAFT BEARING SLEEVE	63749	304332	
<ul style="list-style-type: none"> ● 3 BUS ★ PF40/P410 CH 1816293 			



LOCK NUT	60836	1525988	387877
<ul style="list-style-type: none"> ● 3 BUS ★ PF40/P410 - PF50/P510 - PF60/P610 			
<ul style="list-style-type: none"> ● 3 TRUCK ★ PF30/P310 - PF40/P410 			
<ul style="list-style-type: none"> ● 4 BUS ★ P310/410 			
<ul style="list-style-type: none"> ● 4 TRUCK ★ P310/410/510/610/612 - R560/660/780 - RB660/662 - RBP730/735/832/835 - RP730/731/735/832/835 			
<ul style="list-style-type: none"> ● P-G-R-T TRUCK ★ P310/410/510/610/612 			



ALL THE COMPONENTS LISTED IN OUR CATALOGUE ARE NOT ORIGINAL, THOUGH PERFECTLY INTERCHANGEABLE. REFERENCE NUMBERS, EITHER ORIGINAL OR OF A DIFFERENT NATURE, ARE FOR INFORMATION PURPOSES ONLY WHEN PLACING AN ORDER, PLEASE, ALWAYS USE COSIBO REFERENCE NUMBERS AND DO NOT MENTION THE ORIGINAL REFERENCE NUMBERS OF THE TRUCK MANUFACTURERS IN THE INVOICE TO VEHICLE OWNERS OR TO ANYBODY ELSE. THE CUSTOMER TAKES HIS OWN RESPONSIBILITY IF HE DOES NOT COMPLY WITH WHAT ABOVE.

UNIVERSAL JOINT DIAM.=38 mm



	Code	OEM new	OEM old
● Model	60237	1879537	1111745
★ Application			1422433
			1765828
			337058
● 4 BUS			
★			P300/310
● 3 TRUCK			
★			P30 - PF30/P310 - P300
● 4 TRUCK			
★			P300/310
● P-G-R-T TRUCK			
★			P300/310

UNIVERSAL JOINT DIAM.=48 mm



	Code	OEM new	OEM old
	60238	1797424	1541070
			1766466
			337059
			365901
● 3 BUS			
★			P40 GA775/781/781R R642 - P400/410 - PF40/P410
● 4 BUS			
★			P400/410
● 3 TRUCK			
★			P40 - P400/410 - P400 MK/HK/EK - P420 BETWEEN REAR AXLES 6X4/6X6/8X4 - PF40/P410 - P410 GA750 4X2B/4X2Z/6X2B/6X2Z R641/642 93ML/HL - P410 GA750 4X2B/6X2B R641/642 93MV - P410 GA750 6X2/4B R641/642 93ML - P410 GA850R 4X2B/4X2Z/6X2B/6X2Z R660 93/113 ML/HL - PF40 4X2 - 6X2
● 4 TRUCK			
★			P400/460 4X4 6X6 8X6/4 8X8
● P-G-R-T TRUCK			
★			P420 RB600/700/800 - P400/460 4X4 6X6 8X6/4 8X8 - RBP735/835 ad1350/1355/1445 mm

ALL THE COMPONENTS LISTED IN OUR CATALOGUE ARE NOT ORIGINAL, THOUGH PERFECTLY INTERCHANGEABLE. REFERENCE NUMBERS, EITHER ORIGINAL OR OF A DIFFERENT NATURE, ARE FOR INFORMATION PURPOSES ONLY WHEN PLACING AN ORDER, PLEASE, ALWAYS USE COSIBO REFERENCE NUMBERS AND DO NOT MENTION THE ORIGINAL REFERENCE NUMBERS OF THE TRUCK MANUFACTURERS IN THE INVOICE TO VEHICLE OWNERS OR TO ANYBODY ELSE. THE CUSTOMER TAKES HIS OWN RESPONSIBILITY IF HE DOES NOT COMPLY WITH WHAT ABOVE.

UNIVERSAL JOINT DIA.=57 MM



	Code	OEM new	OEM old
● Model	60239	1797425	1541071
★ Application			1750308 1766467 337060 366437 390225
● 3 TRUCK			
★ P50 - P50 TELMA - P500/540 - P520 6X4 6X6 8X4 - P50 GR880T TELMA - P500 TELMA - PF50/P510 - PF50 GR880T 4X2 6X2 6X4 TELMA - P510 6X4 TELMA			
● 4 TRUCK			
★ P500 4X4 6X6 8X8 - P510 124 CB6X6 HZ ad6300 GRS890/900R RBP730/832 - P520 RB660/662 RBP 832/835 -			
● P-G-R-T TRUCK			
★ P500 4X4 6X6 8X8 - P420 RB600/660/800 - P420/520 RB600/800 - RBP835			

UNIVERSAL JOINT DIAM.=65 mm



	Code	OEM new	OEM old
	61652	1879541	1422442 1541072 386073
● 3 TRUCK			
★ P60/600/610 - PF60			
● 4 TRUCK			
★ P600/602/610/612/640			
● P-G-R-T TRUCK			
★ P600/602/610/612			

ALL THE COMPONENTS LISTED IN OUR CATALOGUE ARE NOT ORIGINAL, THOUGH PERFECTLY INTERCHANGEABLE. REFERENCE NUMBERS, EITHER ORIGINAL OR OF A DIFFERENT NATURE, ARE FOR INFORMATION PURPOSES ONLY WHEN PLACING AN ORDER, PLEASE, ALWAYS USE COSIBO REFERENCE NUMBERS AND DO NOT MENTION THE ORIGINAL REFERENCE NUMBERS OF THE TRUCK MANUFACTURERS IN THE INVOICE TO VEHICLE OWNERS OR TO ANYBODY ELSE. THE CUSTOMER TAKES HIS OWN RESPONSIBILITY IF HE DOES NOT COMPLY WITH WHAT ABOVE.

		Code	OEM new	OEM old
SCREW M12X50	● Model	61348	1757877	1117597
	★ Application			1328597 1344182 313228
	● 3 BUS			
	★	P40 GA775R GA781 GA781R R642 - P400 - PF40/P410 - P410		
	● 3 TRUCK			
	★	P30/40/50 - P300/410/420/500/540 - P50 GR880T - PF30/P310 - PF40/P410 - PF50/P510 - P410 GA750 GA850R		
	● 4 BUS			
	★	P300/310/400/410		
	● 4 TRUCK			
	★	P300/310/400/410/460/500/510 - P420/520 RB660 - P520 RB662 - P540 RBP735		
	● F-K-N BUS			
	★	P400/500		
	● P-G-R-T TRUCK			
	★	P300/310/400/410/420/460/500/510/520		

ALL THE COMPONENTS LISTED IN OUR CATALOGUE ARE NOT ORIGINAL, THOUGH PERFECTLY INTERCHANGEABLE. REFERENCE NUMBERS, EITHER ORIGINAL OR OF A DIFFERENT NATURE, ARE FOR INFORMATION PURPOSES ONLY WHEN PLACING AN ORDER, PLEASE, ALWAYS USE COSIBO REFERENCE NUMBERS AND DO NOT MENTION THE ORIGINAL REFERENCE NUMBERS OF THE TRUCK MANUFACTURERS IN THE INVOICE TO VEHICLE OWNERS OR TO ANYBODY ELSE. THE CUSTOMER TAKES HIS OWN RESPONSIBILITY IF HE DOES NOT COMPLY WITH WHAT ABOVE.

	Code	OEM new	OEM old
KING PIN SET	60305	550732	550713 550714
<ul style="list-style-type: none"> ● Model ★ Application 			
<ul style="list-style-type: none"> ● 4 BUS ★ AMA60 			



KING PIN SET	60845	550722	
<ul style="list-style-type: none"> ● 3 TRUCK ★ AM70 UP TO CH 1161721 - CH 4292924 			



KING PIN SET	60849	550731	
<ul style="list-style-type: none"> ● 3 TRUCK ★ AM70 FROM CH 1161722 - CH 4292925 			



ALL THE COMPONENTS LISTED IN OUR CATALOGUE ARE NOT ORIGINAL, THOUGH PERFECTLY INTERCHANGEABLE. REFERENCE NUMBERS, EITHER ORIGINAL OR OF A DIFFERENT NATURE, ARE FOR INFORMATION PURPOSES ONLY WHEN PLACING AN ORDER, PLEASE, ALWAYS USE COSIBO REFERENCE NUMBERS AND DO NOT MENTION THE ORIGINAL REFERENCE NUMBERS OF THE TRUCK MANUFACTURERS IN THE INVOICE TO VEHICLE OWNERS OR TO ANYBODY ELSE. THE CUSTOMER TAKES HIS OWN RESPONSIBILITY IF HE DOES NOT COMPLY WITH WHAT ABOVE.

KING PIN SET



	Code	OEM new	OEM old
● Model	60838	550730	550729
★ Application			
● 3 TRUCK			
★ AM/AMA56 - 61/AMI61			
● 3 BUS			
★ N113CLB - AM/AMA56 - 61/AMI61			

KING PIN SET



	65193	550284	
● 4 BUS			
★ AM/AMA CH 1219063 - CH 1827102 - CH 4359880 - CH 9014420 - CH 3500760 - AMA860D CH 1223049 - CH 4365790 - CH 9017349 - AMA860 CH 1223050 - CH 4365791 - CH 9017350 - AM860 - ARA860D 6X2/4			
● F-K-N BUS			
★ AM/AMA CH 1219063 - CH 1827102 - CH 4359880 - CH 9014420 - CH 3500760 - ARA860			
● 4 TRUCK			
★ AM/AMA CH 1219063 - CH 1827102 - CH 4359880 - CH 9014420 - CH 3500760 - AMA860D CH 1223049 - CH 4365790 - CH 9017349 - AMA860 CH 1223050 - CH 4365791 - CH 9017350 - ARA760/820/900			
● P-G-R-T TRUCK			
★ AM/AMA CH 1219063 - CH 1827102 - CH 4359880 - CH 9014420 - CH 3500760 - ARA760/820/900			

ALL THE COMPONENTS LISTED IN OUR CATALOGUE ARE NOT ORIGINAL, THOUGH PERFECTLY INTERCHANGEABLE. REFERENCE NUMBERS, EITHER ORIGINAL OR OF A DIFFERENT NATURE, ARE FOR INFORMATION PURPOSES ONLY WHEN PLACING AN ORDER, PLEASE, ALWAYS USE COSIBO REFERENCE NUMBERS AND DO NOT MENTION THE ORIGINAL REFERENCE NUMBERS OF THE TRUCK MANUFACTURERS IN THE INVOICE TO VEHICLE OWNERS OR TO ANYBODY ELSE. THE CUSTOMER TAKES HIS OWN RESPONSIBILITY IF HE DOES NOT COMPLY WITH WHAT ABOVE.

KING PIN SET



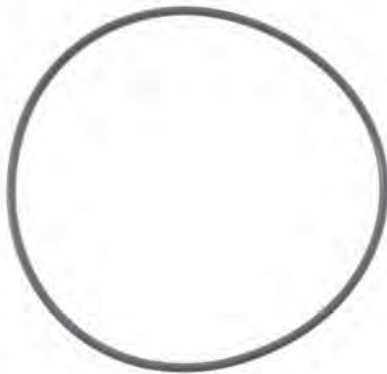

	Code	OEM new	OEM old
● Model	65194	550257	
★ Application			
● 4 BUS			
★ AM/AMA CH 1219062 - CH 1827401 - CH 4359879 - CH 9014419 - CH 3500759			
● F-K-N BUS			
★ AM/AMA CH 1219062 - CH 1827401 - CH 4359879 - CH 9014419 - CH 3500759			
● 3 TRUCK			
★ AM800/820 -			
● 4 TRUCK			
★ AM/AMA CH 1219062 - CH 1827401 - CH 4359879 - CH 9014419 - CH 3500759			
● P-G-R-T TRUCK			
★ AM/AMA CH 1219062 - CH 1827401 - CH 4359879 - CH 9014419 - CH 3500759			

O-RING



	64790	804670	
● 3 TRUCK			
★ AM800/820			

ALL THE COMPONENTS LISTED IN OUR CATALOGUE ARE NOT ORIGINAL, THOUGH PERFECTLY INTERCHANGEABLE. REFERENCE NUMBERS, EITHER ORIGINAL OR OF A DIFFERENT NATURE, ARE FOR INFORMATION PURPOSES ONLY WHEN PLACING AN ORDER, PLEASE, ALWAYS USE COSIBO REFERENCE NUMBERS AND DO NOT MENTION THE ORIGINAL REFERENCE NUMBERS OF THE TRUCK MANUFACTURERS IN THE INVOICE TO VEHICLE OWNERS OR TO ANYBODY ELSE. THE CUSTOMER TAKES HIS OWN RESPONSIBILITY IF HE DOES NOT COMPLY WITH WHAT ABOVE.

	Code	OEM new	OEM old
TIE ROD	60985	1897335	1369411 1379168 1385521 1409918 1501030 1723895 1737683
<ul style="list-style-type: none"> ● Model ★ Application 			
			
<ul style="list-style-type: none"> ● 4 TRUCK ★ AM/AMA740 - AM/AMA740D - AMA740 8X2 8X2/6 8X4 			
<ul style="list-style-type: none"> ● P-G-R-T TRUCK ★ AM740 - AM740D 			
LH BALL JOINT	60521	1738380	1358792 283783 395009
<ul style="list-style-type: none"> ● 3 BUS ★ AM56 - AM61 - AMA56 - AMA61 			
<ul style="list-style-type: none"> ● 4 BUS ★ AM920 			
<ul style="list-style-type: none"> ● F-K-N BUS ★ AM920 			
<ul style="list-style-type: none"> ● 3 TRUCK ★ AM56 CP/CR 4X2 6X2 6X2/4 6X4 8X4 - AM61 4X2 6X2 6X2/4 6X4 8X2 8X4 - AM800 EK 6X4 8X4 - AM820 4X2 6X2 6X4 8X2 8X4 - AM61 EK/HK 8X4 			
<ul style="list-style-type: none"> ● 4 TRUCK ★ AM620 8X2 8X2/6 8X4 - AM621 - AM820D - AM900 8X4 - AM920 8X2 8X2/6 8X4 - AM920D 			
<ul style="list-style-type: none"> ● P-G-R-T TRUCK ★ AM620 - AM620D - AM621 - AM820 - AM900 - AM920 - AM920D 			
			

ALL THE COMPONENTS LISTED IN OUR CATALOGUE ARE NOT ORIGINAL, THOUGH PERFECTLY INTERCHANGEABLE. REFERENCE NUMBERS, EITHER ORIGINAL OR OF A DIFFERENT NATURE, ARE FOR INFORMATION PURPOSES ONLY WHEN PLACING AN ORDER, PLEASE, ALWAYS USE COSIBO REFERENCE NUMBERS AND DO NOT MENTION THE ORIGINAL REFERENCE NUMBERS OF THE TRUCK MANUFACTURERS IN THE INVOICE TO VEHICLE OWNERS OR TO ANYBODY ELSE. THE CUSTOMER TAKES HIS OWN RESPONSIBILITY IF HE DOES NOT COMPLY WITH WHAT ABOVE.

RH BALL JOINT



	Code	OEM new	OEM old
● Model	60522	1358793	283784 395010
★ Application			
● 3 BUS			
★ AM56 - AM61 - AMA56 - AMA61			
● 4 BUS			
★ AM920			
● F-K-N BUS			
★ AM920			
● 3 TRUCK			
★ AM56 CP/CR 4X2 6X2 6X2/4 6X4 8X4 - AM61 4X2 6X2 6X2/4 6X4 8X2 8X4 - AM800 EK 6X4 8X4 - AM820 4X2 6X2 6X4 8X2 8X4 - AM61 EK/HK 8X4			
● 4 TRUCK			
★ AM620 8X2 8X2/6 8X4 - AM621 - AM820D - AM900 8X4 - AM920 8X2 8X2/6 8X4 - AM920D			
● P-G-R-T TRUCK			
★ AM620 - AM620D - AM621 - AM820 - AM900 - AM920 - AM920D			

BALL JOINT



	64343	1738379	1357674
● 4 BUS			
★ AMA780 - AMA780D - AM860 - AMA860 - AMA860D			
● F-K-N BUS			
★ AMA780D - AMA860 - AMA860D			
● 4 TRUCK			
★ AM860 - AMA860 8X2 8X2/6 8X4 - AMA860D			
● P-G-R-T TRUCK			
★ AM860 - AM860D - AMA860 - AMA860D			

ALL THE COMPONENTS LISTED IN OUR CATALOGUE ARE NOT ORIGINAL, THOUGH PERFECTLY INTERCHANGEABLE. REFERENCE NUMBERS, EITHER ORIGINAL OR OF A DIFFERENT NATURE, ARE FOR INFORMATION PURPOSES ONLY WHEN PLACING AN ORDER, PLEASE, ALWAYS USE COSIBO REFERENCE NUMBERS AND DO NOT MENTION THE ORIGINAL REFERENCE NUMBERS OF THE TRUCK MANUFACTURERS IN THE INVOICE TO VEHICLE OWNERS OR TO ANYBODY ELSE. THE CUSTOMER TAKES HIS OWN RESPONSIBILITY IF HE DOES NOT COMPLY WITH WHAT ABOVE.

LH BALL JOINT



- Model
- ★ Application

Code

OEM new

OEM old

60861

1337366

352645

- 3 TRUCK

- ★ AM70 4X2 6X2 6X4 8X2 8X4

RH BALL JOINT



- 3 TRUCK

- ★ AM70 4X2 6X2 6X4 8X2 8X4

60862

1337367

352646

ALL THE COMPONENTS LISTED IN OUR CATALOGUE ARE NOT ORIGINAL, THOUGH PERFECTLY INTERCHANGEABLE. REFERENCE NUMBERS, EITHER ORIGINAL OR OF A DIFFERENT NATURE, ARE FOR INFORMATION PURPOSES ONLY WHEN PLACING AN ORDER, PLEASE, ALWAYS USE COSIBO REFERENCE NUMBERS AND DO NOT MENTION THE ORIGINAL REFERENCE NUMBERS OF THE TRUCK MANUFACTURERS IN THE INVOICE TO VEHICLE OWNERS OR TO ANYBODY ELSE. THE CUSTOMER TAKES HIS OWN RESPONSIBILITY IF HE DOES NOT COMPLY WITH WHAT ABOVE.

LH BALL JOINT



	Code	OEM new	OEM old
● Model	60859	310979	
★ Application			
● 3 BUS			
★ AM61 - AMA56/61			
● 3 TRUCK			
★ AM56 G93 4X2 - CG13 - AM56/61 R113/143 4X2A - AM56/61 P93 4X2A R93 4X2A - AMA56/61 4X2 6X2 6X4			
● 4 BUS			
★ AMA60			

RH BALL JOINT



	Code	OEM new	OEM old
	60860	310980	
● 3 BUS			
★ AM61 - AMA56/61			
● 3 TRUCK			
★ AM56 G93 4X2 - CG13 - AM56/61 R113/143 4X2A - AM56/61 P93 4X2A R93 4X2A - AMA56/61 4X2 6X2 6X4			
● 4 BUS			
★ AMA60			

ALL THE COMPONENTS LISTED IN OUR CATALOGUE ARE NOT ORIGINAL, THOUGH PERFECTLY INTERCHANGEABLE. REFERENCE NUMBERS, EITHER ORIGINAL OR OF A DIFFERENT NATURE, ARE FOR INFORMATION PURPOSES ONLY WHEN PLACING AN ORDER, PLEASE, ALWAYS USE COSIBO REFERENCE NUMBERS AND DO NOT MENTION THE ORIGINAL REFERENCE NUMBERS OF THE TRUCK MANUFACTURERS IN THE INVOICE TO VEHICLE OWNERS OR TO ANYBODY ELSE. THE CUSTOMER TAKES HIS OWN RESPONSIBILITY IF HE DOES NOT COMPLY WITH WHAT ABOVE.

	Code	OEM new	OEM old
MAGNETIC PLUG	63109	1460812	
<ul style="list-style-type: none"> ● Model ★ Application 			
	<ul style="list-style-type: none"> ● 4 TRUCK ★ ADA1500P RP832 4X2 6X2 6X4 6X6 8X2 8X4 6X6 CA 4X4 - ADA1300 ELC 1 R780 - AD1300 R560 R660 R780 R782 - ADA1300 R560 R660 RB660/662 R780/782 - AD1300 RB660 RB662 6X4 8X4 - AD1100P RBP730 6X4 6X4 8X4 - RP730 6X4 6X6 8X4 - AD1500P RBP832 6X4 6X6 8X4 BT300 - AD1500P RP832(REAR) 6X4 6X6 8X4 BT300 - AD1500P RP832 CB4X4 - ADA1100 R560 R660/662 RB660 R780/782 - AD1101P RBP735 - AD1101P RP735 (REAR) - ADA1501P RP835 4X2 6X2 8X2 8X2/4 - AD501P RP835 4X2 6X2 8X2 A4X4 - AD1501P RP/RBP835 B4X4 6X6(REAR) - AD1501P RP835 RBP835 6X4 8X4 BT300 - AD1300 R660(REAR) 6X4 8X4 		
	<ul style="list-style-type: none"> ● P-G-R-T TRUCK ★ AD1300 RB600/662 BT201B/I - R560 R660 - R660(REAR) BT201B/I - R780/782 - AD1100 RB660 - AD1300 R660(REAR) 6X4 8X4 - AD1300 RB660 RB662 6X4 8X4 - ADA1300 RB660/662 R560 R660 - R660(REAR) - R780/782 - ADA1100 R560 R660/662 R660(REAR) R780/782 RB660/662 - AD1101P RBP735 RP735(REAR) - ADA1501P RP835 - AD1501P RP835 - RP835(REAR) RBP835 BT300B - ADA1302 R560 R660 R780/782 - ADA1502P RP835 		



LOCK NUT	60836	1525988	387877
	<ul style="list-style-type: none"> ● 4 TRUCK ★ RP/731/736 		
	<ul style="list-style-type: none"> ● P-G-R-T TRUCK ★ RP731/736 		



SOLENOID VALVE



- Model
- ★ Application

Code

OEM new

OEM old

65191

1536304

1340231
1421322

- **3 TRUCK**

- ★ RP630 AMD 105

- **4 TRUCK**

- ★ RP731 RP736

SWITCH

**64304**

1472738

- **4 TRUCK**

- ★ RP736

ALL THE COMPONENTS LISTED IN OUR CATALOGUE ARE NOT ORIGINAL, THOUGH PERFECTLY INTERCHANGEABLE. REFERENCE NUMBERS, EITHER ORIGINAL OR OF A DIFFERENT NATURE, ARE FOR INFORMATION PURPOSES ONLY WHEN PLACING AN ORDER, PLEASE, ALWAYS USE COSIBO REFERENCE NUMBERS AND DO NOT MENTION THE ORIGINAL REFERENCE NUMBERS OF THE TRUCK MANUFACTURERS IN THE INVOICE TO VEHICLE OWNERS OR TO ANYBODY ELSE. THE CUSTOMER TAKES HIS OWN RESPONSIBILITY IF HE DOES NOT COMPLY WITH WHAT ABOVE.

TUBE L=568



	Code	OEM new	OEM old
● Model	61946	390533	
★ Application			
● 3 BUS			
★ AD90 - ADA90			
● 4 BUS			
★ ADA1300 4X2 6X2 IB/UBI - AD1300 R660 - F94 AD1300 R780 - ADA1300 4X2 6X2 6X2/4 EB/IB - ASA1300 6X2/2			
● F-K-N BUS			
★ ADA1300 4X2 6X2 6X2/4 EB/IB - ADA1300 4X2 6X2 UBI - ASA1300 6X2/2			
● 3 TRUCK			
★ AD90 R642/R660/R770/R780 - ADA90 R642/R660/R770/R780			
● 4 TRUCK			
★ AD1300 R560/R660/R780/782 - AD1300 R660 6X4 8X4 - AD1300 RB660/662 6X4 8X4 - ADA1100 R560/R660/RB660/662/R780/782 - ADA1300 R560/R660/R780/782 - ADA1300 RB660/662			
● P-G-R-T TRUCK			
★ AD1300 R560/R660/R780/782 - AD1300 R660 6X4 8X4 - AD1300 RB660/662 6X4 8X4 - ADA1100 R560/R660/RB660/662/R780/782 - ADA1300 R560/R660/R780/782 - ADA1300 RB660/662			

MAGNETIC PLUG



	63109	1460812	
● 3 BUS			
★ AD90 - ADA90			
● 4 BUS			
★ ASA1300 6X2/2 - ADA1500P RP832 RP835 - ADA1300 4X2 6X2 IB(8X2) - ADA1300 4X2 6X2 UB - AD1300 R660 - F94 AD1300 R780			
● F-K-N BUS			
★ ASA1300 6X2/2 - AD1300 R660 R780 - ADA1300D EB/IB/UB - ADA1300 4X2 6X2 UB - ADA1300 4X2 6X2*4 EB/IB(6X2/2 8X2)			
● 3 TRUCK			
★ AD80 R641 - AD90 R642 R660 - ADA90 RB652 R642 R652 R660			
● 4 TRUCK			
★ ADA1500P RP832 4X2 6X2 6X4 6X6 8X2 8X4 6X6 CA 4X4 - ADA1300 ELC 1 R780 - AD1300 R560 R660 R780 R782 - ADA1300 R560 R660 RB660/662 R780/782 - AD1300 RB660 RB662 6X4 8X4 - AD1100P RBP730 6X4 6X4 8X4 - RP730 6X4 6X6 8X4 - AD1500P RBP832 6X4 6X6 8X4 BT300 - AD1500P RP832(RE)			
● P-G-R-T TRUCK			
★ AD1300 RB600/662 BT201B/I - R560 R660 - R660(REAR) BT201B/I - R780/782 - AD1100 RB660 - AD1300 R660(REAR) 6X4 8X4 - AD1300 RB660 RB662 6X4 8X4 - ADA1300 RB660/662 R560 R660 - R660(REAR) - R780/782 - ADA1100 R560 R660/662 R660(REAR) R780/782 RB660/662 - AD1101P RPB735 RP735(RE)			

ALL THE COMPONENTS LISTED IN OUR CATALOGUE ARE NOT ORIGINAL, THOUGH PERFECTLY INTERCHANGEABLE. REFERENCE NUMBERS, EITHER ORIGINAL OR OF A DIFFERENT NATURE, ARE FOR INFORMATION PURPOSES ONLY WHEN PLACING AN ORDER, PLEASE, ALWAYS USE COSIBO REFERENCE NUMBERS AND DO NOT MENTION THE ORIGINAL REFERENCE NUMBERS OF THE TRUCK MANUFACTURERS IN THE INVOICE TO VEHICLE OWNERS OR TO ANYBODY ELSE. THE CUSTOMER TAKES HIS OWN RESPONSIBILITY IF HE DOES NOT COMPLY WITH WHAT ABOVE.

	Code	OEM new	OEM old
MAGNETIC PLUG	61371	235434	153682
● Model			
★ Application			
● 3 BUS			
★ AD/ADA90			
● 3 TRUCK			
★ AD80 R641 R653 RB652 - AD/ADA90 R642 R653 R770 R780 RB652 - AD100 RP831 RP832 RBP831 RBP832 - AD85 RP730 RBP730 - R770			
● 4 TRUCK			
★ ADA1100/1300 R780/782 - AD1500P RP832 RBP832			
● P-G-R-T TRUCK			
★ ADA1100/1300 R780/782			



ALL THE COMPONENTS LISTED IN OUR CATALOGUE ARE NOT ORIGINAL, THOUGH PERFECTLY INTERCHANGEABLE. REFERENCE NUMBERS, EITHER ORIGINAL OR OF A DIFFERENT NATURE, ARE FOR INFORMATION PURPOSES ONLY WHEN PLACING AN ORDER, PLEASE, ALWAYS USE COSIBO REFERENCE NUMBERS AND DO NOT MENTION THE ORIGINAL REFERENCE NUMBERS OF THE TRUCK MANUFACTURERS IN THE INVOICE TO VEHICLE OWNERS OR TO ANYBODY ELSE. THE CUSTOMER TAKES HIS OWN RESPONSIBILITY IF HE DOES NOT COMPLY WITH WHAT ABOVE.

		Code	OEM new	OEM old
OIL FILTER	● Model	60434	1301696	1768402
	★ Application			
	● 4 BUS			
	★ R660 K/L94/114/124 - R660 F94 - RP835			
	● F-K-N BUS			
	★ R660/680			
	● 3 TRUCK			
	★ RBP730			
	● 4 TRUCK			
	★ RB660 6X4 8X4 8X4/4 - RB662 - RBP730/735/835 - R560/660/780/782 - RP735/835			
	● P-G-R-T TRUCK			
	★ RB660/662 - R650/660/780/782 - RP735/835 - RBP735/835			

OIL SEAL 85x105x13/18 (FOR SHAFT WITH COUNTERCLOCKWISE ROTATION)		63330	1502384	1300974 1380160 1393331
	● 4 TRUCK			
	★ RP731 - RP736			
	● P-G-R-T TRUCK			
	★ RP731 - RP736			

OIL SEAL 85x105x13/18 (FOR SHAFT WITH CLOCKWISE ROTATION)		63345	1502385	1383129 1386594
	● 4 BUS			
	★ RP832 - RP835 - R660 K/L 94/114/124-F 94 - R780 F 94			
	● F-K-N BUS			
	★ R660 - R680 - R780			
	● 4 TRUCK			
	★ RB660 - RB660 6X4 8X4 8X4/4 - RB662 - RP832 - R780 - R782 - R660/662(REAR) 6X4 8X4 8X4/4 - R660 - RBP832 - RP832(REAR) 6X4 8X4 6X6 8X6/4 - R560 - RBP730 - RBP735 - RP730(REAR) - RP735(REAR) - RP835(REAR) - RBP835 - RP835(REAR) FOR SHAFT WITH CLOCKWISE ROTATION			
	● P-G-R-T TRUCK			
	★ RB662 - R660 - RB660(REAR) - RB660 - R780 - RP735(REAR) - RP835(REAR) - RBP735 - RBP835 - R560 - R782			

ALL THE COMPONENTS LISTED IN OUR CATALOGUE ARE NOT ORIGINAL, THOUGH PERFECTLY INTERCHANGEABLE. REFERENCE NUMBERS, EITHER ORIGINAL OR OF A DIFFERENT NATURE, ARE FOR INFORMATION PURPOSES ONLY WHEN PLACING AN ORDER, PLEASE, ALWAYS USE COSIBO REFERENCE NUMBERS AND DO NOT MENTION THE ORIGINAL REFERENCE NUMBERS OF THE TRUCK MANUFACTURERS IN THE INVOICE TO VEHICLE OWNERS OR TO ANYBODY ELSE. THE CUSTOMER TAKES HIS OWN RESPONSIBILITY IF HE DOES NOT COMPLY WITH WHAT ABOVE.

OIL SEAL 80X100X10



	Code	OEM new	OEM old
● Model	62460	1528991	1680726 388728
★ Application			
● 3 TRUCK			
★ RBP730			
● 4 TRUCK			
★ RP731 - RB660 6X4 8X4 8X4/4 - RBP730/735/835 - RB662			
● P-G-R-T TRUCK			
★ RB660/662 - RBP735/835			

BEARING KIT



	62465	550813	
● 4 BUS			
★ F94 R780			
● F-K-N BUS			
★ R780			
● 3 TRUCK			
★ R780			
● 4 TRUCK			
★ R780			
● P-G-R-T TRUCK			
★ R780			

DIFFERENTIAL SPIDER



	65501	1444822	1325066 264906
● 4 BUS			
★ RP832			
● 3 TRUCK			
★ RP831 4X2 4X4 6X2 8X2 - RBP831/832 - RP832 4X2 4X4 6X2 8X2			
● 4 TRUCK			
★ RP832 6X4 8X4 6X6 8X6/4 - RB832 - RBP832			

ALL THE COMPONENTS LISTED IN OUR CATALOGUE ARE NOT ORIGINAL, THOUGH PERFECTLY INTERCHANGEABLE. REFERENCE NUMBERS, EITHER ORIGINAL OR OF A DIFFERENT NATURE, ARE FOR INFORMATION PURPOSES ONLY WHEN PLACING AN ORDER, PLEASE, ALWAYS USE COSIBO REFERENCE NUMBERS AND DO NOT MENTION THE ORIGINAL REFERENCE NUMBERS OF THE TRUCK MANUFACTURERS IN THE INVOICE TO VEHICLE OWNERS OR TO ANYBODY ELSE. THE CUSTOMER TAKES HIS OWN RESPONSIBILITY IF HE DOES NOT COMPLY WITH WHAT ABOVE.

DIFFERENTIAL SIDE GEAR



	Code	OEM new	OEM old
● Model	65008	164433	
★ Application			
● 4 BUS			
★ RP832			
● 3 TRUCK			
★ RP831 4X2 4X4 6X2 8X2 - RBP831/832 - RP832 4X2 4X4 6X2 8X2			
● 4 TRUCK			
★ RP832 6X4 8X4 6X6 8X6/4 - RB832 - RBP832			

LOCK NUT



	60836	1525988	387877
● 3 BUS			
★ R642/660 - RV654/760/761			
● 3 TRUCK			
★ R641/642/660/770/780 - RP/RBP730/831/832 - RB652/653 AD80 - RB652/653 AD/ADA90			
● 4 BUS			
★ RP832/835 - R660/780 - K/L 94/114/124 - F 94			
● 4 TRUCK			
★ R560/660/662/780/782 - RB660/662 - RP/RBP730/735/832/835			
● F-K-N BUS			
★ R660/680/780			
● P-G-R-T TRUCK			
★ RB660/662 - R560/660/780/782 - RP/RBP735/835			

ALL THE COMPONENTS LISTED IN OUR CATALOGUE ARE NOT ORIGINAL, THOUGH PERFECTLY INTERCHANGEABLE. REFERENCE NUMBERS, EITHER ORIGINAL OR OF A DIFFERENT NATURE, ARE FOR INFORMATION PURPOSES ONLY WHEN PLACING AN ORDER, PLEASE, ALWAYS USE COSIBO REFERENCE NUMBERS AND DO NOT MENTION THE ORIGINAL REFERENCE NUMBERS OF THE TRUCK MANUFACTURERS IN THE INVOICE TO VEHICLE OWNERS OR TO ANYBODY ELSE. THE CUSTOMER TAKES HIS OWN RESPONSIBILITY IF HE DOES NOT COMPLY WITH WHAT ABOVE.

DIFFERENTIAL HALF HOUSING



- Model
- ★ Application

Code	OEM new	OEM old
61640	1116847	

- 3 TRUCK
- ★ R770

CROWN GEAR



- 3 TRUCK

65075	184808	
-------	--------	--

- ★ AD80 RB652 - AD/ADA90 RB652

OIL SEAL 90X110X13/9.5



- 3 TRUCK

61010	214008	
-------	--------	--

- ★ AD80 RB652 - AD/ADA90 RB652

ALL THE COMPONENTS LISTED IN OUR CATALOGUE ARE NOT ORIGINAL, THOUGH PERFECTLY INTERCHANGEABLE. REFERENCE NUMBERS, EITHER ORIGINAL OR OF A DIFFERENT NATURE, ARE FOR INFORMATION PURPOSES ONLY WHEN PLACING AN ORDER, PLEASE, ALWAYS USE COSIBO REFERENCE NUMBERS AND DO NOT MENTION THE ORIGINAL REFERENCE NUMBERS OF THE TRUCK MANUFACTURERS IN THE INVOICE TO VEHICLE OWNERS OR TO ANYBODY ELSE. THE CUSTOMER TAKES HIS OWN RESPONSIBILITY IF HE DOES NOT COMPLY WITH WHAT ABOVE.

	Code	OEM new	OEM old
OIL SEAL 70X85X8	63275	378480	
<ul style="list-style-type: none"> ● Model ★ Application 			
<ul style="list-style-type: none"> ● 3 TRUCK ★ RBP831 MK HK EK - RBP832 			
<ul style="list-style-type: none"> ● 4 TRUCK ★ RBP832 			



	60635	197800	392661
O-RING DIAM.26,2X3			
<ul style="list-style-type: none"> ● 3 TRUCK ★ RBP730 			
<ul style="list-style-type: none"> ● 4 TRUCK ★ RB660/662 - RBP730/735/835 			
<ul style="list-style-type: none"> ● P-G-R-T TRUCK ★ RBP735/835 - RB660/662 			



	64778	1331820	
O-RING			
<ul style="list-style-type: none"> ● 3 TRUCK ★ RB652 AD80/AD90/ADA90 			

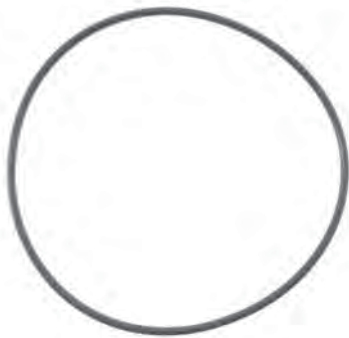

ALL THE COMPONENTS LISTED IN OUR CATALOGUE ARE NOT ORIGINAL, THOUGH PERFECTLY INTERCHANGEABLE. REFERENCE NUMBERS, EITHER ORIGINAL OR OF A DIFFERENT NATURE, ARE FOR INFORMATION PURPOSES ONLY WHEN PLACING AN ORDER, PLEASE, ALWAYS USE COSIBO REFERENCE NUMBERS AND DO NOT MENTION THE ORIGINAL REFERENCE NUMBERS OF THE TRUCK MANUFACTURERS IN THE INVOICE TO VEHICLE OWNERS OR TO ANYBODY ELSE. THE CUSTOMER TAKES HIS OWN RESPONSIBILITY IF HE DOES NOT COMPLY WITH WHAT ABOVE.

		Code	OEM new	OEM old
SCREW M12X50	● Model	61348	1757877	1117597
	★ Application			1328597
	● 3 TRUCK			1344182
	★ RBP730			313228
	● 4 TRUCK			
	★ RB660 - RBP730			
	● P-G-R-T TRUCK			
	★ RB660			

		61586	1116848	
WASHER	● 3 BUS			
	★ RV761			
	● 4 BUS			
	★ F94 R780			
	● F-K-N BUS			
	★ R780			
	● 3 TRUCK			
	★ R770/780			
	● 4 TRUCK			
	★ R780/782			
	● P-G-R-T TRUCK			
	★ R780/782			

ALL THE COMPONENTS LISTED IN OUR CATALOGUE ARE NOT ORIGINAL, THOUGH PERFECTLY INTERCHANGEABLE. REFERENCE NUMBERS, EITHER ORIGINAL OR OF A DIFFERENT NATURE, ARE FOR INFORMATION PURPOSES ONLY WHEN PLACING AN ORDER, PLEASE, ALWAYS USE COSIBO REFERENCE NUMBERS AND DO NOT MENTION THE ORIGINAL REFERENCE NUMBERS OF THE TRUCK MANUFACTURERS IN THE INVOICE TO VEHICLE OWNERS OR TO ANYBODY ELSE. THE CUSTOMER TAKES HIS OWN RESPONSIBILITY IF HE DOES NOT COMPLY WITH WHAT ABOVE.

	Code	OEM new	OEM old
WASHER	61585	1116698	
● Model			
★ Application			
● 3 BUS			
★ RV761			
● 4 BUS			
★ F94 R780			
● F-K-N BUS			
★ R780			
● 3 TRUCK			
★ R770/780			
● 4 TRUCK			
★ R780/782			
● P-G-R-T TRUCK			
★ R780/782			



	61587	1116699	
WASHER			
● 3 BUS			
★ RV761			
● 4 BUS			
★ F94 R780			
● F-K-N BUS			
★ R780			
● 3 TRUCK			
★ R770/780			
● 4 TRUCK			
★ R780/782			
● P-G-R-T TRUCK			
★ R780/782			



ALL THE COMPONENTS LISTED IN OUR CATALOGUE ARE NOT ORIGINAL, THOUGH PERFECTLY INTERCHANGEABLE. REFERENCE NUMBERS, EITHER ORIGINAL OR OF A DIFFERENT NATURE, ARE FOR INFORMATION PURPOSES ONLY WHEN PLACING AN ORDER, PLEASE, ALWAYS USE COSIBO REFERENCE NUMBERS AND DO NOT MENTION THE ORIGINAL REFERENCE NUMBERS OF THE TRUCK MANUFACTURERS IN THE INVOICE TO VEHICLE OWNERS OR TO ANYBODY ELSE. THE CUSTOMER TAKES HIS OWN RESPONSIBILITY IF HE DOES NOT COMPLY WITH WHAT ABOVE.

		Code	OEM new	OEM old
SWITCH	● Model	61953	1303472	375734
	★ Application			
	● 3 BUS			
	★	R642/660 - RV760/761		
	● 3 TRUCK			
	★	R641/642/660/770/780 - RP831 4X2 4X4 6X2 8X2 - RBP730/831/832 - RP832 4X2 4X4 6X2 8X2		
● 4 BUS				
★	F94 R780			
● F-K-N BUS				
★	R780			





SWITCH		64304	1472738	
	● 4 BUS			
	★	F94 R780		
	● 4 TRUCK			
	★	R660/780/782 - RB660/662 - RP735/835 - RBP735/835		
	● F-K-N BUS			
★	R780			
● P-G-R-T TRUCK				
★	R660/780/782 - RB660/662 - RP735/835 - RBP735/835			



SWITCH		63055	1303471	370710
	● 3 TRUCK			
	★	G770 - G770 CAG - GS771 CAG - GR801 - GR801 CAG - GR871 - GR/GRE871T CAG - GR880 - GR880T - GRH880 - GR900 - GRH900 - GR/GRS900 - GRS900 CAG - GRS900 R - GS771/772 - GT811 - GR801/900 - CP/CR 93/113/143 LHD GR/GRH900 - CT93 - CP/CR/CT 113/143 RHD GR900 - CT RHD GR/GRS900R - CT 143 LHD/RHD GR/GRH900 - CR 143 LHD/RHD GR900 - CP 113 CR/CT 113/143 RHD GRS900 - CG/CP/CR RHD GR/GRH900 - EK300/EK310/EK330/EK340/EK422/EK423		
	● 4 TRUCK			
	★	RP731		
	● P-G-R-T TRUCK			
★	RP731			



ALL THE COMPONENTS LISTED IN OUR CATALOGUE ARE NOT ORIGINAL, THOUGH PERFECTLY INTERCHANGEABLE. REFERENCE NUMBERS, EITHER ORIGINAL OR OF A DIFFERENT NATURE, ARE FOR INFORMATION PURPOSES ONLY WHEN PLACING AN ORDER, PLEASE, ALWAYS USE COSIBO REFERENCE NUMBERS AND DO NOT MENTION THE ORIGINAL REFERENCE NUMBERS OF THE TRUCK MANUFACTURERS IN THE INVOICE TO VEHICLE OWNERS OR TO ANYBODY ELSE. THE CUSTOMER TAKES HIS OWN RESPONSIBILITY IF HE DOES NOT COMPLY WITH WHAT ABOVE.

	Code	OEM new	OEM old
LH BALL JOINT	60521	1738380	1358792 283783 395009
	<ul style="list-style-type: none"> ● Model ★ Application 		
	<ul style="list-style-type: none"> ● 3 TRUCK ★ ARA56 - ARA61 - AM61 		
	<ul style="list-style-type: none"> ● 4 TRUCK ★ ARA820 - ARA820D6X2/4 8X2/4 		
	<ul style="list-style-type: none"> ● P-G-R-T TRUCK ★ ARA820 		
RH BALL JOINT	60522	1358793	283784 395010
	<ul style="list-style-type: none"> ● 3 TRUCK ★ ARA56 - ARA61 - AM61 		
	<ul style="list-style-type: none"> ● 4 TRUCK ★ ARA820 - ARA820D6X2/4 8X2/4 		
	<ul style="list-style-type: none"> ● P-G-R-T TRUCK ★ ARA820 		
BALL JOINT	64343	1738379	1357674
	<ul style="list-style-type: none"> ● 4 BUS ★ ARA860D 6X2/4 		
	<ul style="list-style-type: none"> ● F-K-N BUS ★ ARA860D 6X2/4 		
	<ul style="list-style-type: none"> ● 4 TRUCK ★ ARA760 - ARA760D 6X2/4 - ARA900 - ARA900D 6X2/4 8X2/6 		
	<ul style="list-style-type: none"> ● P-G-R-T TRUCK ★ ARA760 - ARA900 		

ALL THE COMPONENTS LISTED IN OUR CATALOGUE ARE NOT ORIGINAL, THOUGH PERFECTLY INTERCHANGEABLE. REFERENCE NUMBERS, EITHER ORIGINAL OR OF A DIFFERENT NATURE, ARE FOR INFORMATION PURPOSES ONLY WHEN PLACING AN ORDER, PLEASE, ALWAYS USE COSIBO REFERENCE NUMBERS AND DO NOT MENTION THE ORIGINAL REFERENCE NUMBERS OF THE TRUCK MANUFACTURERS IN THE INVOICE TO VEHICLE OWNERS OR TO ANYBODY ELSE. THE CUSTOMER TAKES HIS OWN RESPONSIBILITY IF HE DOES NOT COMPLY WITH WHAT ABOVE.

REPAIR SET



● Model
★ Application

Code

OEM new

OEM old

63898

552004

● 3 TRUCK

★ AS60/90

● 4 TRUCK

★ AS900

● P-G-R-T TRUCK

★ AS900

ALL THE COMPONENTS LISTED IN OUR CATALOGUE ARE NOT ORIGINAL, THOUGH PERFECTLY INTERCHANGEABLE. REFERENCE NUMBERS, EITHER ORIGINAL OR OF A DIFFERENT NATURE, ARE FOR INFORMATION PURPOSES ONLY WHEN PLACING AN ORDER, PLEASE, ALWAYS USE COSIBO REFERENCE NUMBERS AND DO NOT MENTION THE ORIGINAL REFERENCE NUMBERS OF THE TRUCK MANUFACTURERS IN THE INVOICE TO VEHICLE OWNERS OR TO ANYBODY ELSE. THE CUSTOMER TAKES HIS OWN RESPONSIBILITY IF HE DOES NOT COMPLY WITH WHAT ABOVE.

SOLENOID VALVE



● Model

★ Application

Code

OEM new

OEM old

65191

1536304

1340231
1421322

● 3 BUS

★

● 4 BUS

★ R660

● F-K-N BUS

★ OK

● 3 TRUCK

★ R641 R642 R660 R770 R780 - RBP831+RP831 - RB652+R653 - RP831/2 - 4X4 R642 R660 RP831 RP832 - 6X6 RBP831/RP831 - RBP832/RP832 - MK6X4 8X4 - ML6X4 2XAD80 - HK EK 6X4 8X4 RBP831+RP831 - RBP832+RP832 - HK 6X4 8X4 RBP730+RP730

● 4 TRUCK

★ RBP/RP832 6X4 6X6 8X4 - RP832 4X4 - RBP/RP730 6X4 6X6 8X4 - RB660/662 6X4 8X4 8X4/4 - RBP/RP735 RBP/RP835 6X4 6X6 8X4 - RP835 4X2 4X4 6X2 8X2 8X2/4

	Code	OEM new	OEM old
CLAMP D.6	64082	813933	
	<ul style="list-style-type: none"> ● Model ★ Application 		
	<ul style="list-style-type: none"> ● 4 BUS ★ 		
	<ul style="list-style-type: none"> ● F-K-N BUS ★ 		
	<ul style="list-style-type: none"> ● 3 TRUCK ★ 		

CLAMP D.8	64090	813934	
	<ul style="list-style-type: none"> ● 3 TRUCK ★ 		
	<ul style="list-style-type: none"> ● 4 TRUCK ★ 		

CLAMP D.13	64091	813936	
	<ul style="list-style-type: none"> ● 3 TRUCK ★ 		
	<ul style="list-style-type: none"> ● 4 TRUCK ★ 		
	<ul style="list-style-type: none"> ● P-G-R-T TRUCK ★ 		

ALL THE COMPONENTS LISTED IN OUR CATALOGUE ARE NOT ORIGINAL, THOUGH PERFECTLY INTERCHANGEABLE. REFERENCE NUMBERS, EITHER ORIGINAL OR OF A DIFFERENT NATURE, ARE FOR INFORMATION PURPOSES ONLY WHEN PLACING AN ORDER, PLEASE, ALWAYS USE COSIBO REFERENCE NUMBERS AND DO NOT MENTION THE ORIGINAL REFERENCE NUMBERS OF THE TRUCK MANUFACTURERS IN THE INVOICE TO VEHICLE OWNERS OR TO ANYBODY ELSE. THE CUSTOMER TAKES HIS OWN RESPONSIBILITY IF HE DOES NOT COMPLY WITH WHAT ABOVE.





	Code	OEM new	OEM old
NUT	64033	1873183	1403618
● Model			
★ Application			
● 4 BUS			
★ AM820/AM920 - AMA - ABS - AMA/AMI - D - ASA701 - ARA860D			
● F-K-N BUS			
★ AMA/AMI - D - AMA/ASA - ABS - AM920 - ARA860 - ARA860D - ASA760			
● 3 TRUCK			
★ AM800/AM820			
● 4 TRUCK			
★ AM/AMA - EBS - ABS - ARA760/820/900/900D - ASA700D - ASA700			
● P-G-R-T TRUCK			
★ AM/AMA - ABS - EBS - ASA700 - ASA700D - ABS/EBS - ARA760/820/900/900D			



	Code	OEM new	OEM old
WHEEL FLANGE	60279	1539231	1374305 1414072 273020
● 3 BUS			
★ AD/ADA90 - AD90 20"			
● 4 BUS			
★ ADA1300/1300D AND ABS - ASA1300D ABS			
● F-K-N BUS			
★ AD1300 - AD/ADA/ASA1300 ABS			
● 3 TRUCK			
★ AD/ADA90 - AD/ADA90 20" 22,5" - AD/ADA90 24"			
● 4 TRUCK			
★ AD/ADA1300 4X2 6X2 6X2/4 6X4 8X4 AND ABS - ADA DISC BRAKE EBS - AD/ADA1300 20" 22,5" 4X2 6X2 6X2/4 6X4 8X4 AND ABS - AD/ADA1300 24" 4X2 6X2 6X2/4 6X4 8X4 AND ABS - ADA1100 4X2 6X2 6X2/4 6X4 8X4 AND ABS - ADA1100 20" 22,5" 4X2 6X2 6X2/4 6X4 8X4 AND ABS - ADA1100 24" 4X2 6X2 6X2/4 6X4 8X4 AND ABS			
● P-G-R-T TRUCK			
★ ADA1100 AD/ADA1300 ADA1302 ABS/EBS - AD/ADA1300 20" 22,5" 4X2 6X2 6X2/4 6X4 AND ABS - AD/ADA1300 24" 4X2 6X2 6X2/4 6X4 AND ABS - ADA1100 4X2 6X2 6X2/4 6X4 AND ABS - ADA1100 20" 22,5" 4X2 6X2 6X2/4 6X4 AND ABS - ADA1100 24" 4X2 6X2 6X2/4 6X4 AND ABS - AD/ADA1300 ADA1302 4X2 6X2 6X2/4 6X4 AND ABS - ADA1100 ADA1300 ASA1000			



ALL THE COMPONENTS LISTED IN OUR CATALOGUE ARE NOT ORIGINAL, THOUGH PERFECTLY INTERCHANGEABLE. REFERENCE NUMBERS, EITHER ORIGINAL OR OF A DIFFERENT NATURE, ARE FOR INFORMATION PURPOSES ONLY WHEN PLACING AN ORDER, PLEASE, ALWAYS USE COSIBO REFERENCE NUMBERS AND DO NOT MENTION THE ORIGINAL REFERENCE NUMBERS OF THE TRUCK MANUFACTURERS IN THE INVOICE TO VEHICLE OWNERS OR TO ANYBODY ELSE. THE CUSTOMER TAKES HIS OWN RESPONSIBILITY IF HE DOES NOT COMPLY WITH WHAT ABOVE.

	Code	OEM new	OEM old
AXLE SHAFT L=1070 MM (3 TEETH)	60299	193136	193137
	<ul style="list-style-type: none"> ● Model ★ Application 		
	<ul style="list-style-type: none"> ● 1 TRUCK ★ 111 - 141 		
	<ul style="list-style-type: none"> ● 2 TRUCK ★ 112 - 142 		
AXLE SHAFT L=1084 MM (2 TEETH)	60301	264310	209152
	<ul style="list-style-type: none"> ● 3 BUS ★ AD/ADA90 - AD90 20" 		
	<ul style="list-style-type: none"> ● 3 TRUCK ★ AD/ADA90 - LH/RH R770 - R642 4X2 6X2 - RB652 R653 6X4 - AD/ADA90 R652/653 6X4 - AD90 R642 - ADA90 20" 22,5" LH/RH R770 R642 4X2 6X2 - RB652 R653 6X4 - AD/ADA90 24" LH/RH R770 R642 4X2 6X2 - RB652 R653 6X4 		
AXLE SHAFT L=1084 MM (3 TEETH)	60302	264311	209153
	<ul style="list-style-type: none"> ● 3 TRUCK ★ AD/ADA90 RB652 R653 6X4 - AD/ADA90 20" 22,5" RB652 R653 6X4 - AD/ADA90 24" RB652 R653 6X4 		
AXLE SHAFT L=1093 MM (2 TEETH)	62552	1761195	1315681
	<ul style="list-style-type: none"> ● 4 BUS ★ F94 R780 		
	<ul style="list-style-type: none"> ● F-K-N BUS ★ R660 R680 AUTOMATIC GEARBOX - R780 		
	<ul style="list-style-type: none"> ● 3 TRUCK ★ AD/ADA90 LH/RH R780 4X2 6X2 - AD/ADA90 20" 22,5" LH/RH R780 4X2 6X2 - AD/ADA90 24" LH/RH R780 4X2 6X2 		
	<ul style="list-style-type: none"> ● 4 TRUCK ★ R780 - R782 		
	<ul style="list-style-type: none"> ● P-G-R-T TRUCK ★ R780 - R782 		

ALL THE COMPONENTS LISTED IN OUR CATALOGUE ARE NOT ORIGINAL, THOUGH PERFECTLY INTERCHANGEABLE. REFERENCE NUMBERS, EITHER ORIGINAL OR OF A DIFFERENT NATURE, ARE FOR INFORMATION PURPOSES ONLY WHEN PLACING AN ORDER, PLEASE, ALWAYS USE COSIBO REFERENCE NUMBERS AND DO NOT MENTION THE ORIGINAL REFERENCE NUMBERS OF THE TRUCK MANUFACTURERS IN THE INVOICE TO VEHICLE OWNERS OR TO ANYBODY ELSE. THE CUSTOMER TAKES HIS OWN RESPONSIBILITY IF HE DOES NOT COMPLY WITH WHAT ABOVE.

		Code	OEM new	OEM old
WHEEL BEARING	● Model	64497	1868087	1439070 1476945 1724482
	★ Application			
	● 3 TRUCK			
	★ AM800/820			
	● 4 BUS			
	★ AM860/920 - ARA860D - ASA701 - AMA/AMI			
	● 4 TRUCK			
	★ AM/AMA - ARA760/820/900/900D - ASA700/700D			
	● F-K-N BUS			
	★ AMA/AMI D - AM/AMA/ASA - AM920 - ARA860/860D - ASA760			
	● P-G-R-T TRUCK			
	★ AM/AMA - ASA700/700D - ARA760/820/900/900D			

		61651	1327413	287449
WASHER	● 3 BUS			
	★ AM/AMA56/61 - AMI61 - ASA60			
	● 3 TRUCK			
	★ AM/AMA56/61 - AM70 - ARA56/61 - AS60 - ASA70 - AM70			
	● 4 TRUCK			
★ ASA70				

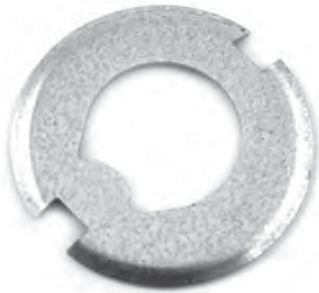

	Code	OEM new	OEM old
NUT	65213	273024	
<ul style="list-style-type: none"> ● Model ★ Application 			
<ul style="list-style-type: none"> ● 3 BUS ★ AD/ADA90 - ATA90 			
<ul style="list-style-type: none"> ● 3 TRUCK ★ AD/ADA90 - AS90 			
<ul style="list-style-type: none"> ● 4 BUS ★ ADA1300/1300D - AD1300 - ASA1300D - ASA1000 			
<ul style="list-style-type: none"> ● 4 TRUCK ★ AD/ADA1300 - ADA1100 - ASA1000/1000D - AS1300 - AS900 			
<ul style="list-style-type: none"> ● F-K-N BUS ★ ADA1300 			
<ul style="list-style-type: none"> ● P-G-R-T TRUCK ★ ADA1100 - AD/ADA1300 - ADA1302 - ASA1000/1000D - AS900 			



OIL SEAL 50x70x9	65214	1104500	
<ul style="list-style-type: none"> ● 3 TRUCK ★ AD100 RP/RBP831/832 			
<ul style="list-style-type: none"> ● 4 TRUCK ★ AD/ADA1500P RP/RBP832 			



	Code	OEM new	OEM old
WASHER	61650	273023	
● Model			
★ Application			
● 3 BUS			
★ AD/ADA/ATA90			
● 3 TRUCK			
★ AD/ADA/AS90			
● 4 BUS			
★ AD/ADA/ASA1300/1300D - ASA1000 - ADA1100			
● 4 TRUCK			
★ AD/ADA/AS1300 - ADA/ASA1000/1000D - AS900 - ADA1100			
● F-K-N BUS			
★ AD/ADA/ASA1300			
● P-G-R-T TRUCK			
★ ADA1100 - AD/ADA1300 - ADA1302 - ASA1000/1000D - AS900			



	Code	OEM new	OEM old
WASHER	61761	273022	
● 3 BUS			
★ AD/ADA/ATA90			
● 3 TRUCK			
★ AD/ADA/AS90			
● 4 BUS			
★ AD/ADA/ASA1300/1300D - ASA1000 - ADA1100			
● 4 TRUCK			
★ AD/ADA/AS1300 - ADA/ASA1000/1000D - AS900 - ADA1100			
● F-K-N BUS			
★ AD/ADA/ASA1300			
● P-G-R-T TRUCK			
★ ADA1100 - AD/ADA1300 - ADA1302 - ASA1000/1000D - AS900			



ALL THE COMPONENTS LISTED IN OUR CATALOGUE ARE NOT ORIGINAL, THOUGH PERFECTLY INTERCHANGEABLE. REFERENCE NUMBERS, EITHER ORIGINAL OR OF A DIFFERENT NATURE, ARE FOR INFORMATION PURPOSES ONLY WHEN PLACING AN ORDER, PLEASE, ALWAYS USE COSIBO REFERENCE NUMBERS AND DO NOT MENTION THE ORIGINAL REFERENCE NUMBERS OF THE TRUCK MANUFACTURERS IN THE INVOICE TO VEHICLE OWNERS OR TO ANYBODY ELSE. THE CUSTOMER TAKES HIS OWN RESPONSIBILITY IF HE DOES NOT COMPLY WITH WHAT ABOVE.

OIL SEAL 150,81x177,80x12,7



● Model

★ Application

Code

OEM new

OEM old

60005

159496

● 3 TRUCK

★ AD/ADA90 24" - 4X2 6X2 6X4 FOR BRAKE SHOES 203 mm

OIL SEAL 142x170x15/19



61297

1740992

1409889
1534012
370076

● 3 BUS

★ AD90 - ADA90 - AD90 20" - ATA90

● 4 BUS

★ ADA1300/1300 ABS - ADA1300 D ABS - AD1300 - ASA1300 D ABS - ASA1000 - AD/ADA1300 ADA1100 DISC BRAKE

● F-K-N BUS

★ AD/ADA1300 - AD/ADA/ASA1300 ABS

● 3 TRUCK

★ ADA90 - AD90 - AD/ADA90 20" 22,5" - AD90 ABS - AD/ADA90 24" - AS90

● 4 TRUCK

★ AS900 - AD/ADA1300/1300 ABS 4X2 6X2 6X2/4 6X4 8X4 - AD/ADA1300/1300 ABS 20" 22,5" - AD/ADA1300/1300 ABS 24" 4X2 6X2 6X2/4 6X4 8X4 - ADA1100/1100 ABS 4X2 6X2 6X2/4 6X4 8X4 - ADA1100 20" 22,5" 4X2 6X2 6X2/4 6X4 8X4 - ADA1100/1100 ABS 24" 4X2 6X2 6X2/4 6X4 8X4 - ASA1000 A

● P-G-R-T TRUCK

★ ADA1100 AD/ADA1300 ADA1302 ABS/EBS - AD/ADA1300 20" 22,5" AND ABS 4X2 6X2 6X2/4 6X4 - AD/ADA1300 24" 4X2 6X2 6X2/4 6X4 AND ABS - ADA1100 4X2 6X2 6X2/4 6X4 AND ABS - ADA1100 20" 22,5" 4X2 6X2 6X2/4 6X4 - ADA1100 24" 4X2 6X2 6X2/4 6X4 AND ABS

ALL THE COMPONENTS LISTED IN OUR CATALOGUE ARE NOT ORIGINAL, THOUGH PERFECTLY INTERCHANGEABLE. REFERENCE NUMBERS, EITHER ORIGINAL OR OF A DIFFERENT NATURE, ARE FOR INFORMATION PURPOSES ONLY WHEN PLACING AN ORDER, PLEASE, ALWAYS USE COSIBO REFERENCE NUMBERS AND DO NOT MENTION THE ORIGINAL REFERENCE NUMBERS OF THE TRUCK MANUFACTURERS IN THE INVOICE TO VEHICLE OWNERS OR TO ANYBODY ELSE. THE CUSTOMER TAKES HIS OWN RESPONSIBILITY IF HE DOES NOT COMPLY WITH WHAT ABOVE.

OIL SEAL 137x161,92x15/20



	Code	OEM new	OEM old
● Model	61020	370074	
★ Application			
● 3 TRUCK			
★ AD/O - ASA80			
● 4 TRUCK			
★ ASA80			

OIL SEAL 125x160x15



	Code	OEM new	OEM old
	61196	375086	
● 3 BUS			
★ AM56 - AM/AMA61 - AMI61			
● 3 TRUCK			
★ AM/AMA56 - AM/AMA61 6X4 8X4 - AM70 8X2 8X4 - ARA61 - ASA70			
● 4 TRUCK			
★ ASA70			

ALL THE COMPONENTS LISTED IN OUR CATALOGUE ARE NOT ORIGINAL, THOUGH PERFECTLY INTERCHANGEABLE. REFERENCE NUMBERS, EITHER ORIGINAL OR OF A DIFFERENT NATURE, ARE FOR INFORMATION PURPOSES ONLY WHEN PLACING AN ORDER, PLEASE, ALWAYS USE COSIBO REFERENCE NUMBERS AND DO NOT MENTION THE ORIGINAL REFERENCE NUMBERS OF THE TRUCK MANUFACTURERS IN THE INVOICE TO VEHICLE OWNERS OR TO ANYBODY ELSE. THE CUSTOMER TAKES HIS OWN RESPONSIBILITY IF HE DOES NOT COMPLY WITH WHAT ABOVE.

OIL SEAL 75x100x17



	Code	OEM new	OEM old
● Model	60993	1409890	1313719 33352
★ Application			
● 3 BUS			
★ AD/ADA90 - AD90 20"			
● 4 BUS			
★ AD/ADA1300 ABS - ADA1300D ABS - ASA1300D ABS			
● F-K-N BUS			
★ AD/ADA/ASA1300 ABS			
● 3 TRUCK			
★ AD/ADA90 4X2 6X2 6X4 - AD/ADA90 20"/22.5"/24" 4X2 6X2 6X4			
● 4 TRUCK			
★ AD/ADA1300 AND ABS 4X2 6X2 6X2/4 - AD/ADA1300 AND ABS 20" 22,5" 4X2 6X2 6X2/4 - AD/ADA1300 24" AND ABS 4X2 6X2 6X2/4 - ADA1100 4X2 6X2 6X2/4 - ADA1100 ABS 4X2 6X2 6X2/4 6X4 8X4 - ADA1100 20" 22,5" AND ABS 4X2 6X2 6X2/4 - ADA1100 24" AND ABS 4X2 6X2 6X2/4			
● P-G-R-T TRUCK			
★ AD/ADA1300 20"/22.5"/24" - ADA1100 20"/22.5"24" - ADA1302 - ASA1000			

	Code	OEM new	OEM old
SEAL RING	60994	1765061	120310
<ul style="list-style-type: none"> ● Model ★ Application 			
<ul style="list-style-type: none"> ● 3 BUS 			
<ul style="list-style-type: none"> ★ AD/ADA90 - AD90 20" - ATA90 ABS 			
<ul style="list-style-type: none"> ● 4 BUS 			
<ul style="list-style-type: none"> ★ AD/ADA1300 ADA1100 DISC BRAKE - ADA1300 ABS - ADA1300D ABS - AD1300 - ASA1000 			
<ul style="list-style-type: none"> ● F-K-N BUS 			
<ul style="list-style-type: none"> ★ AD/ADA1300 - AD/ADA/ASA1300 ABS 			
<ul style="list-style-type: none"> ● 3 TRUCK 			
<ul style="list-style-type: none"> ★ AD/ADA90 4X2 6X2 6X4 - AD/ADA90 20" 22,5" 4X2 6X2 6X4 - AD/ADA90 24" 4X2 6X2 6X4 - AS90 			
<ul style="list-style-type: none"> ● 4 TRUCK 			
<ul style="list-style-type: none"> ★ AD/ADA1300 ADA1100 DISC BRAKE - AD/ADA1300 4X2 6X2 6X2/4 6X4 8X4 - AD/ADA1300 20"22,2" AND ABS 4X2 6X2 6X2/4 6X4 8X4 - AD/ADA1300 24" AND ABS 4X2 6X2 6X2/4 6X4 8X4 - ADA1100 ANCHE/ANCHE ABS 4X2 6X2 6X2/4 6X4 8X4 - ADA1100 20"22,65" AND ABS 4X2 6X2 6X2/4 6X4 8X4 - ADA1100 24" AND/ANCEH ABS 4X2 6X2 6X2/4 6X4 8X4 - ASA1000 ABS - ASA1000D - AS1300 ABS - AS900 			
<ul style="list-style-type: none"> ● P-G-R-T TRUCK 			
<ul style="list-style-type: none"> ★ ADA1100 AD/ADA1300 ADA1302 ABS/EBS - AD/ADA1300 20"22,5" AND ABS 4X2 6X2 6X2/4 6X4 - AD/ADA1300 24" AND ABS 4X2 6X2 6X2/4 6X4 - AD1100 AND ABS 4X2 6X2 6X2/4 6X4 - ADA1100 20" 22,5" AND ABS 4X2 6X2 6X2/4 6X4 - ADA1100 24" AND ABS 4X2X6X2 6X2/4 6X4 - AD/ADA1300 ADA1302 AND ABS 4X2 6X2 6X2/4 6X4 - ADA1100 ADA1300 ASA1000 - ASA1000D ABS/EBS - ASA1000 ABS - AS900 - AD/ADA1300 ADA1100 DISC BRAKE 			



O-RING (NBR BLACK)	61007	392309	298021
<ul style="list-style-type: none"> ● 4 BUS 			
<ul style="list-style-type: none"> ★ ADA1501P RP835 			
<ul style="list-style-type: none"> ● 3 TRUCK 			
<ul style="list-style-type: none"> ★ AD100 20"22,5" RP/RBP831 6X2 6X4 - AD100 RP/RBP832 4X2 6X2 6X4 8X4 - AD100 20"22,5" RP/RBP832 4X2 6X2 6X4 8X4 - AD100 24" RP/RBP832 4X2 6X2 6X4 8X4 			
<ul style="list-style-type: none"> ● 4 TRUCK 			
<ul style="list-style-type: none"> ★ AD1101P RP/RBP735 - AD/ADA1500P RP/RBP832 AND ABS 4X2 6X2 6X4 6X6 8X4 - AD/ADA1500P RP/RBP832 20" 22,5" 24" 4X2 6X2 6X4 6X6 8X4 - AD/ADA1501P RP/RBP835 			
<ul style="list-style-type: none"> ● P-G-R-T TRUCK 			
<ul style="list-style-type: none"> ★ AD/AD1501P RP/RBP835 - AD1101P RP/RBP735 - ADA1502P RP/RBP835 			

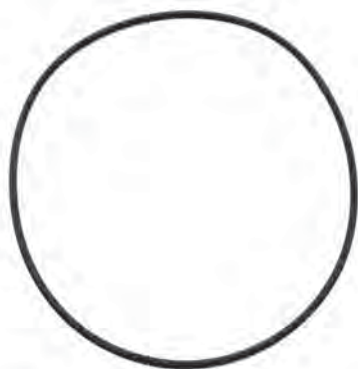

	Code	OEM new	OEM old
O-RING (VITON GREEN)	61007/1	392309	298021
<ul style="list-style-type: none"> ● Model ★ Application 			
<ul style="list-style-type: none"> ● 4 BUS ★ ADA1501P RP835 			
<ul style="list-style-type: none"> ● 3 TRUCK ★ AD100 20"22,5" RP/RBP831 6X2 6X4 - AD100 RP/RBP832 4X2 6X2 6X4 8X4 - AD100 20"22,5" RP/RBP832 4X2 6X2 6X4 8X4 - AD100 24" RP/RBP832 4X2 6X2 6X4 8X4 			
<ul style="list-style-type: none"> ● 4 TRUCK ★ AD1101P RP/RBP735 - AD/ADA1500P RP/RBP832 AND ABS 4X2 6X2 6X4 6X6 8X4 - AD/ADA1500P RP/RBP832 20" 22,5" 24" 4X2 6X2 6X4 6X6 8X4 - AD/ADA1501P RP/RBP835 			
<ul style="list-style-type: none"> ● P-G-R-T TRUCK ★ AD/AD1501P RP/RBP835 - AD1101P RP/RBP735 - ADA1502P RP/RBP835 			



	61851	1907845	1363674 1528043 1786639
OIL SEAL 158x188x14,5/19			
<ul style="list-style-type: none"> ● 4 BUS ★ ADA1501P RP835 			
<ul style="list-style-type: none"> ● 3 TRUCK ★ AD100 RP/RBP831 4X2 6X2 6X4 - AD100 24" RP/RBP831 - AD100 RP/RBP832 4X2 6X2 6X4 8X4 - AD100 24" RP/RBP832 4X2 6X2 6X4 8X4 			
<ul style="list-style-type: none"> ● 4 TRUCK ★ AD1101P RP/RBP735 - AD/ADA1500P RP/RBP832 AND ABS 4X2 6X2 6X4 6X6 8X4 - AD/ADA1500P RP/RBP832 20" 22,5" 24" 4X2 6X2 6X4 6X6 8X4 - AD/ADA1501P RP/RBP835 			
<ul style="list-style-type: none"> ● P-G-R-T TRUCK ★ AD/ADA1501P RP/RBP835 - AD1101P RP/RBP735 - ADA1502P RP/RBP835 			



	64301	1342708	
OIL SEAL 149,9X176X16			
<ul style="list-style-type: none"> ● 4 TRUCK ★ AMD900 ALSO ABS - AMD901 ALSO ABS - 			
<ul style="list-style-type: none"> ● P-G-R-T TRUCK ★ AMD900A ABS - AMD901 ALSO ABS 			



ALL THE COMPONENTS LISTED IN OUR CATALOGUE ARE NOT ORIGINAL, THOUGH PERFECTLY INTERCHANGEABLE. REFERENCE NUMBERS, EITHER ORIGINAL OR OF A DIFFERENT NATURE, ARE FOR INFORMATION PURPOSES ONLY WHEN PLACING AN ORDER, PLEASE, ALWAYS USE COSIBO REFERENCE NUMBERS AND DO NOT MENTION THE ORIGINAL REFERENCE NUMBERS OF THE TRUCK MANUFACTURERS IN THE INVOICE TO VEHICLE OWNERS OR TO ANYBODY ELSE. THE CUSTOMER TAKES HIS OWN RESPONSIBILITY IF HE DOES NOT COMPLY WITH WHAT ABOVE.

		Code	OEM new	OEM old
O-RING	● Model	64163	233275	
	★ Application			
	● 3 TRUCK			
	★ 2XAD85 6X4 8X4 - 2XAD85 20" 6X4 8X4			
● 4 TRUCK				
★ AD1100P RP/RBP730 ALSO ABS 6X4 6X6 8X4 - AD1100P RP/RBP730 20" 22,5" 6X4 6X6 8X4				



		64164	1120873	
O-RING	● 3 TRUCK			
	★ 2XAD85 6X4 8X4 - 2XAD85 20" 6X4 8X4			
	● 4 TRUCK			
	★ AMD900/901 RH731 - AD1100P RP/RBP730 ALSO ABS 6X4 6X6 8X4 - AD1100P RP/RBP730 20" 22,5" 6X4 6X6 8X4			
	● P-G-R-T TRUCK			
★ AMD900 RH731 - AMS901 RH731 RBP736				

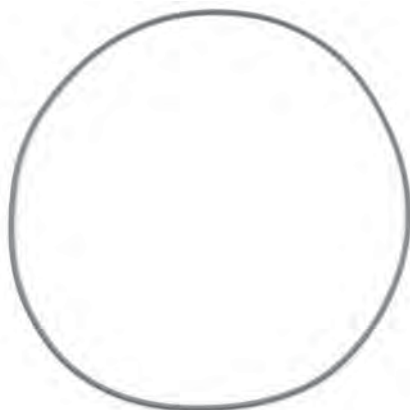

		64165	1336380	
GASKET	● 3 TRUCK			
	★ 2XAD85 6X4 8X4 - 2XAD85 20" 6X4 8X4			
	● 4 TRUCK			
	★ AMD900/901 RH731 - AD1100P RP/RBP730 ALSO ABS 6X4 6X6 8X4 - AD1100P RP/RBP730 20" 22,5" 6X4 6X6 8X4			
	● P-G-R-T TRUCK			
★ AMD900 RH731 - AMS901 RH731 RBP736				



OIL SEAL 145X170X14,5/18



	Code	OEM new	OEM old
● Model	64166	1736562	1363673
★ Application			
● 3 TRUCK			
★	2XAD85 6X4 8X4 - 2XAD85 20" 6X4 8X4		
● 4 TRUCK			
★	AD1100P RP/RBP730 ALSO ABS 6X4 6X6 8X4 - AD1100P RP/RBP730 20" 22,5" 6X 6X6 8X4		

OIL SEAL 110X140X15



	61197	375087	
● 3 BUS			
★	AM/AMA56		
● 3 TRUCK			
★	AM/AMA56 - ARA56		

OIL SEAL 155X180X24/29



	61017	370075	
● 3 TRUCK			
★	AD100 RP/RBP831 4X2 6X2 6X4 - AD100 20" 22,5" RP/RBP831 6X2 6X4 - AD100 24" RP/RBP831 - AD100 20" 22,5" RP/RBP832 4X2 6X2 6X4 8X4		

ALL THE COMPONENTS LISTED IN OUR CATALOGUE ARE NOT ORIGINAL, THOUGH PERFECTLY INTERCHANGEABLE. REFERENCE NUMBERS, EITHER ORIGINAL OR OF A DIFFERENT NATURE, ARE FOR INFORMATION PURPOSES ONLY WHEN PLACING AN ORDER, PLEASE, ALWAYS USE COSIBO REFERENCE NUMBERS AND DO NOT MENTION THE ORIGINAL REFERENCE NUMBERS OF THE TRUCK MANUFACTURERS IN THE INVOICE TO VEHICLE OWNERS OR TO ANYBODY ELSE. THE CUSTOMER TAKES HIS OWN RESPONSIBILITY IF HE DOES NOT COMPLY WITH WHAT ABOVE.

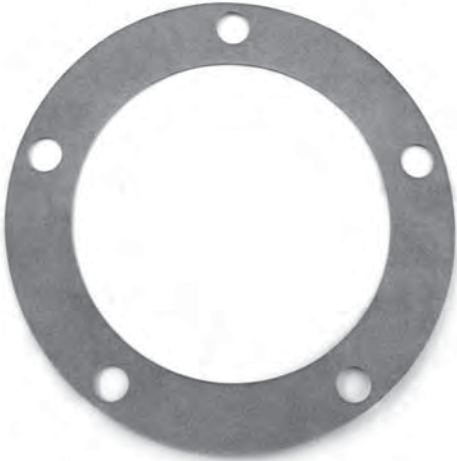
		Code	OEM new	OEM old
GASKET	● Model	61849	156938	1112702
	★ Application			
	● 3 BUS			
	★	AM/AMA56/61 - AMI61 - ASA60		
	● 3 TRUCK			
	★	AM/AMA/ARA56/61 - AM70 - AS60 - ASA70		
	● 4 TRUCK			
	★	ASA70		

WHEEL NUT H=27 MM		60986	1749034	1365510 243956 318690
	● 3 BUS			
	★	AM/AMA56/61 - AMI61 - AD/ADA90 - ASA60 - ATA90		
	● 3 TRUCK			
	★	AM/AMA/ARA56/61 - AM70 - AM800/820 - AMD105 - AD80 - AD/ADA90 - AD100 RP/RBP831/832 - 2XAD85 - AS60/90 - ASA70/80		
	● 4 BUS			
	★	AM860/920 - AMA/AMI/D - AM/AMA60 - ADA1250D/1300/1300D/1350D - AD1300 - ADA1501P RP835 - ASA701 - ASA1000/1150/1300D - ARA860D		
	● 4 TRUCK			
	★	ADA - AM/AMA - AD1100/1101P - ADA1100 - AD/ADA1300/1500/1501P - AMD900 - ARA760/820/900/D - AS900/1300 - ASA70/80/700/700D/1000/1000D		
	● F-K-N BUS			
	★	ADA1250D/1350D - ASA760/1150 - AMA/AMI/D - AM/AMA/ASA - AM920 - ARA860 - AD/ADA/ASA1300 - ARA860D		
● P-G-R-T TRUCK				
★	AM/AMA - AMD900/901 - ADA1100 - AD/ADA1300 - ADA1302 - AD/ADA1501P RP/RBP835 - ADA1502P RP/RBP835 - AD1101P RP/RBP735 - ASA700/1000 - ASA700/1000D - ARA760/820/900/D - AS900			

ALL THE COMPONENTS LISTED IN OUR CATALOGUE ARE NOT ORIGINAL, THOUGH PERFECTLY INTERCHANGEABLE. REFERENCE NUMBERS, EITHER ORIGINAL OR OF A DIFFERENT NATURE, ARE FOR INFORMATION PURPOSES ONLY WHEN PLACING AN ORDER, PLEASE, ALWAYS USE COSIBO REFERENCE NUMBERS AND DO NOT MENTION THE ORIGINAL REFERENCE NUMBERS OF THE TRUCK MANUFACTURERS IN THE INVOICE TO VEHICLE OWNERS OR TO ANYBODY ELSE. THE CUSTOMER TAKES HIS OWN RESPONSIBILITY IF HE DOES NOT COMPLY WITH WHAT ABOVE.

	Code	OEM new	OEM old
RING GEAR	64723	1375382	1339680
● Model			
★ Application			
● 3 TRUCK			
★ AM800/820			
● 4 BUS			
★ AMA - AMA/AMI/D - ASA701 - ARA860D			
● 4 TRUCK			
★ AM/AMA - ARA760/820/900 - ARA760/820/900D - ASA700/700D			
● F-K-N BUS			
★ ARA860D			
● P-G-R-T TRUCK			
★ ASA700			



ALL THE COMPONENTS LISTED IN OUR CATALOGUE ARE NOT ORIGINAL, THOUGH PERFECTLY INTERCHANGEABLE. REFERENCE NUMBERS, EITHER ORIGINAL OR OF A DIFFERENT NATURE, ARE FOR INFORMATION PURPOSES ONLY WHEN PLACING AN ORDER, PLEASE, ALWAYS USE COSIBO REFERENCE NUMBERS AND DO NOT MENTION THE ORIGINAL REFERENCE NUMBERS OF THE TRUCK MANUFACTURERS IN THE INVOICE TO VEHICLE OWNERS OR TO ANYBODY ELSE. THE CUSTOMER TAKES HIS OWN RESPONSIBILITY IF HE DOES NOT COMPLY WITH WHAT ABOVE.

	Code	OEM new	OEM old
EXHAUST MANIFOLD	61908	1349045	
<ul style="list-style-type: none"> ● Model ★ Application 			
<ul style="list-style-type: none"> ● IND. MARINE ENGINE 4 			
<ul style="list-style-type: none"> ★ D14 81A 40E 			
<ul style="list-style-type: none"> ● 3 TRUCK 			
<ul style="list-style-type: none"> ★ DSC14 			



EXHAUST MANIFOLD	63753	1411774	
<ul style="list-style-type: none"> ● 4 TRUCK 			
<ul style="list-style-type: none"> ★ D11L 			



ENGINE EXHAUST BRAKE	63779	1374413	1360069
<ul style="list-style-type: none"> ● 4 TRUCK 			
<ul style="list-style-type: none"> ★ 144 			



ALL THE COMPONENTS LISTED IN OUR CATALOGUE ARE NOT ORIGINAL, THOUGH PERFECTLY INTERCHANGEABLE. REFERENCE NUMBERS, EITHER ORIGINAL OR OF A DIFFERENT NATURE, ARE FOR INFORMATION PURPOSES ONLY WHEN PLACING AN ORDER, PLEASE, ALWAYS USE COSIBO REFERENCE NUMBERS AND DO NOT MENTION THE ORIGINAL REFERENCE NUMBERS OF THE TRUCK MANUFACTURERS IN THE INVOICE TO VEHICLE OWNERS OR TO ANYBODY ELSE. THE CUSTOMER TAKES HIS OWN RESPONSIBILITY IF HE DOES NOT COMPLY WITH WHAT ABOVE.

ENGINE EXHAUST BRAKE



- Model
- ★ Application

Code	OEM new	OEM old
65283	1805603	1383863 1412695 1427514

- **4 BUS**

- ★ DC/DSC12 01/02/05 ENG 6195782 - ENG 8023977 - DC11 DC12 ENG 6195783 - ENG 8023978 -

- **IND. MARINE ENGINE 4**

- ★ D12A EMS ENG 6519002 - ENG 6519003 - D12A ENG 6195783 - ENG 8023978

- **4 TRUCK**

- ★ DC/DSC12 01/02/05 ENG 6195782 - ENG 8023977 - DC11 DC12 ENG 6195783 - ENG 8023978 - DC11 01/02 ENG 6195782 - ENG 8023977 - DC12 03 ENG 6195782 - ENG 8023977

ALL THE COMPONENTS LISTED IN OUR CATALOGUE ARE NOT ORIGINAL, THOUGH PERFECTLY INTERCHANGEABLE. REFERENCE NUMBERS, EITHER ORIGINAL OR OF A DIFFERENT NATURE, ARE FOR INFORMATION PURPOSES ONLY WHEN PLACING AN ORDER, PLEASE, ALWAYS USE COSIBO REFERENCE NUMBERS AND DO NOT MENTION THE ORIGINAL REFERENCE NUMBERS OF THE TRUCK MANUFACTURERS IN THE INVOICE TO VEHICLE OWNERS OR TO ANYBODY ELSE. THE CUSTOMER TAKES HIS OWN RESPONSIBILITY IF HE DOES NOT COMPLY WITH WHAT ABOVE.

ENGINE BRAKE THROTTLE VALVE SET



- Model
- ★ Application

Code	OEM new	OEM old
60893	1313326	301760 377253

- 3 TRUCK

- ★ DS11 DSC11 ENG 5307760 - ENG 3075634 - ENG 4070104

ENGINE BRAKE THROTTLE VALVE SET



- 3 TRUCK

- ★ DS11 DSC11 ENG 5307760 - ENG 3075634 - ENG 4070104

60894	1313325	377254
-------	---------	--------

ENGINE BRAKE THROTTLE VALVE SET



- IND. MARINE ENGINE 4

- ★ DI14 81A 40E

- 3 TRUCK

- ★ DSC14 CH 1193600 - CH 1193601 - CH 4327370 - CH 4327371 - CH 9000981 - CH 9000982

61530	1342121	1117705 385647
-------	---------	-------------------

ALL THE COMPONENTS LISTED IN OUR CATALOGUE ARE NOT ORIGINAL, THOUGH PERFECTLY INTERCHANGEABLE. REFERENCE NUMBERS, EITHER ORIGINAL OR OF A DIFFERENT NATURE, ARE FOR INFORMATION PURPOSES ONLY WHEN PLACING AN ORDER, PLEASE, ALWAYS USE COSIBO REFERENCE NUMBERS AND DO NOT MENTION THE ORIGINAL REFERENCE NUMBERS OF THE TRUCK MANUFACTURERS IN THE INVOICE TO VEHICLE OWNERS OR TO ANYBODY ELSE. THE CUSTOMER TAKES HIS OWN RESPONSIBILITY IF HE DOES NOT COMPLY WITH WHAT ABOVE.

ENGINE BRAKE THROTTLE VALVE SET



	Code	OEM new	OEM old
● Model	61531	1103635	1309571
★ Application			
● 3 BUS			
★ DSC 1124 CH 1823420			
● IND. MARINE ENGINE 4			
★ DSC9 47A			
● 3 TRUCK			
★ DS11 DSC11 ENG 5307761 - 5310452 - ENG 3075635 - ENG 4070105 - 4072203 - ENG 5310453 - ENG 4072204 - CH 1193600 - CH 1193601 - CH 4327370 - CH 4327371 - CH 9000981 - CH 9000982 - D11 84dB(A)			

ENGINE BRAKE THROTTLE VALVE SET



	66600	242573	
● 3 TRUCK			
★ DN11 DN9			

ALL THE COMPONENTS LISTED IN OUR CATALOGUE ARE NOT ORIGINAL, THOUGH PERFECTLY INTERCHANGEABLE. REFERENCE NUMBERS, EITHER ORIGINAL OR OF A DIFFERENT NATURE, ARE FOR INFORMATION PURPOSES ONLY WHEN PLACING AN ORDER, PLEASE, ALWAYS USE COSIBO REFERENCE NUMBERS AND DO NOT MENTION THE ORIGINAL REFERENCE NUMBERS OF THE TRUCK MANUFACTURERS IN THE INVOICE TO VEHICLE OWNERS OR TO ANYBODY ELSE. THE CUSTOMER TAKES HIS OWN RESPONSIBILITY IF HE DOES NOT COMPLY WITH WHAT ABOVE.

		Code	OEM new	OEM old
ENGINE BRAKE METAL BUSHING	● Model	66606	1403609	1337777
	★ Application			1340548 1345729 207517 231936
	● 3 BUS			
	★			ADA 90 CH 1824259 - DS11 DSC11 DS1134 DS1174 CH 1823419 - DSC1124 CH 1823420 - DSC1104 1124 - DSC1108 - DSC1127
	● IND. MARINE ENGINE 4			
	★			DSC9
	● 3 TRUCK			
	★			DN9 - DN11 - DSC14 CH 1193600 - CH 1193601 - CH 4327370 - CH 4327371 - CH 9000981 - CH 9000982 - D9/D11 - DS9 DS9 4X4 DSC9 ENG 5100362 - DS11 DSC11 ENG 5307760 - ENG 3075634 - ENG 3075635 - ENG 4070104 - ENG 4070105 - 4072203 - ENG 5307761 - 5310452 - DS11 DSC11 ENG 5310453 - ENG 4072204 - CH 1193600 - CH 1193601 - CH 4327370 - CH 4327371 - CH 9000981 - CH 9000982 - DS9 DS9 4X4 DSC9 DSC9 6X4 ENG 5100363 - CH 1193600 - CH 1193601 - CH 4327370 - CH 4327371 - CH 9000981 - CH 9000982 - DTC11 CH 1193600 - CH 1193601 - CH 4327370 - CH 4327371 - CH 9000981 - CH 9000982 - D11 84dB(A) - D14 84dB(A)

ALL THE COMPONENTS LISTED IN OUR CATALOGUE ARE NOT ORIGINAL, THOUGH PERFECTLY INTERCHANGEABLE. REFERENCE NUMBERS, EITHER ORIGINAL OR OF A DIFFERENT NATURE, ARE FOR INFORMATION PURPOSES ONLY WHEN PLACING AN ORDER, PLEASE, ALWAYS USE COSIBO REFERENCE NUMBERS AND DO NOT MENTION THE ORIGINAL REFERENCE NUMBERS OF THE TRUCK MANUFACTURERS IN THE INVOICE TO VEHICLE OWNERS OR TO ANYBODY ELSE. THE CUSTOMER TAKES HIS OWN RESPONSIBILITY IF HE DOES NOT COMPLY WITH WHAT ABOVE.

	Code	OEM new	OEM old
EXHAUST BRAKE CYLINDER	60436	1438902	
<ul style="list-style-type: none"> ● Model ★ Application 			
<ul style="list-style-type: none"> ● IND. MARINE ENGINE 4 ★ ENG 1018664 - ENG 1018665 			
<ul style="list-style-type: none"> ● 4 TRUCK ★ DC16 01/02 ENG 1018664 - ENG 1018665 			
<ul style="list-style-type: none"> ● P-G-R-T TRUCK ★ D16 			



BRAKE CYLINDER	60413	1112542	363808
<ul style="list-style-type: none"> ● IND. MARINE ENGINE 4 ★ DI14 81A 40E 			
<ul style="list-style-type: none"> ● 3 TRUCK ★ DN11 - DSC14 - DS11 - DSC11 - D14 84dB(A) 			



ENGINE BRAKE CYLINDER	61536	1332503	1348896
<ul style="list-style-type: none"> ● 3 BUS ★ DS11 - DSC11 - DS1134 - DS1174 - DSC1124 - DSC1104/1108/1127 			
<ul style="list-style-type: none"> ● IND. MARINE ENGINE 4 ★ DSC9 - DSC9 47A 			
<ul style="list-style-type: none"> ● 3 TRUCK ★ DS9 - DSC9 - DS9 4X4 - DS9 - DSC9 6X4 - DN9 - DS11 - DSC11 - DTC11 - DSC14 LHD CR - D11 84dB(A) 			



ALL THE COMPONENTS LISTED IN OUR CATALOGUE ARE NOT ORIGINAL, THOUGH PERFECTLY INTERCHANGEABLE. REFERENCE NUMBERS, EITHER ORIGINAL OR OF A DIFFERENT NATURE, ARE FOR INFORMATION PURPOSES ONLY WHEN PLACING AN ORDER, PLEASE, ALWAYS USE COSIBO REFERENCE NUMBERS AND DO NOT MENTION THE ORIGINAL REFERENCE NUMBERS OF THE TRUCK MANUFACTURERS IN THE INVOICE TO VEHICLE OWNERS OR TO ANYBODY ELSE. THE CUSTOMER TAKES HIS OWN RESPONSIBILITY IF HE DOES NOT COMPLY WITH WHAT ABOVE.

		Code	OEM new	OEM old
EXHAUST BRAKE CYLINDER	● Model	65233	1400769	1376474
	★ Application			
	● 4 BUS			
	★	DC/DSC12 01/02/05 4X4 - 6X6 - 8X8 ENG 6195782 - ENG 8023977 - DC11/DC12 4X4 - 6X6 - 8X8 ENG 6195783 - ENG 8023978 - DSC9 11/15 LHD - RHD - D9L		
	● F-K-N BUS			
	★	DC9 EEV&EURO 5		
	● IND. MARINE ENGINE 4			
	★	D12A EMS ENG 6519002 - D12A ENG 6195783 - ENG 8023978 - DC9 51A		
	● 4 TRUCK			
	★	DC/DSC12 01/02/05 4X4 - 6X6 - 8X8 ENG 6195782 - ENG 8023977 - DC11/DC12 4X4 - 6X6 - 8X8 ENG 6195783 - ENG 8023978 - DT12 02/08 ENG 6195782 - ENG 8023977 - DTC 01 - DC11 01/02 ENG 6195782 - ENG 8023977 - DC12 03 ENG 6195782 - ENG 8023977 - D11L CH 1236756 - CH 1236757 - CH 9029576 - CH 9029577 - CH 4387094 - CH 4387095 - CH 3500183 - CH 3500184 - D9L - DT12 ENG 6195783 - ENG 8023978		
● P-G-R-T TRUCK				
★	DC9 EEV&EURO 5 - D11/D12 - D13			



		62398	1353142	
SWITCH	● 4 TRUCK			
	★	94 - 114 - 124 - 144 - 164		
	● P-G-R-T TRUCK			
	★			



ALL THE COMPONENTS LISTED IN OUR CATALOGUE ARE NOT ORIGINAL, THOUGH PERFECTLY INTERCHANGEABLE. REFERENCE NUMBERS, EITHER ORIGINAL OR OF A DIFFERENT NATURE, ARE FOR INFORMATION PURPOSES ONLY WHEN PLACING AN ORDER, PLEASE, ALWAYS USE COSIBO REFERENCE NUMBERS AND DO NOT MENTION THE ORIGINAL REFERENCE NUMBERS OF THE TRUCK MANUFACTURERS IN THE INVOICE TO VEHICLE OWNERS OR TO ANYBODY ELSE. THE CUSTOMER TAKES HIS OWN RESPONSIBILITY IF HE DOES NOT COMPLY WITH WHAT ABOVE.

		Code	OEM new	OEM old
EXH.BRAKE BALL JOINT	● Model	61529	1112539+ 1112540	
	★ Application			
	● 3 BUS			
	★	DS11 DSC11 DS1134 DS1174 CH 1823419 - DSC1124 CH 1823420 - DSC1104 DSC1108 DSC1127 - OSC 11G01 CH 1825273 - K113TLP DSC 1181 CH 1827276		
	● 4 BUS			
	★	DC/DSC12 01/02/05 ENG 6195782 - ENG 8023977 4X4 6X6 8X8 - DC11/DC12 ENG 6195783 - ENG 8023978 - DC11/DC12 PDE HPI ENG 6195783 - ENG 8023978 - DSC9 11/15 LHD - RHD - DL9 - DC9 PDE/HPI ENG 6195783 - ENG 8023978		
	● F-K-N BUS			
	★	F/K/N		
	● IND. MARINE ENGINE 4			
	★	D12A EMS ENG 6519002 - D12A ENG 6195783 - ENG 8023978 - DC9A 51A -		
	● IND. MARINE ENGINE 5			
	★	DC9A EMS ENG 6347185		
	● 3 TRUCK			
★	DSC9 LHD CABIN P/R - DSC11 DTC11 LHD CABIN P/R 80dB(A) - DSC14 LHD CABIN R 80dB(A) - DSC14 - DS9 4X4 ENG 5100362 - DS11 DSC11 ENG 5307760 - ENG 3075634 - ENG 4070104 - DN9 - DS11 DSC11 ENG 5310453 - ENG 4072204 - DTC11 - DSC14 LHD CABIN R - D11 84dB(A) - D14 84dB(A)			
● 4 TRUCK				
★	DC/DSC12 01/02/05 ENG 6195782 - ENG 8023977 4X4 6X6 8X8 - DC11/DC12 ENG 6195783 - ENG 8023978 4X4 6X6 8X8 - 80dB(A) 144 - DC11/DC12 PDE/HPI HAI - DT12 02/08 ENG 6195782 - ENG 8023977 - DTC12 01 - DC11 01/02 ENG 6195782 - ENG 8023977 - DC12 03 ENG 6195782 - ENG 8023977 - D11L CH 1236756 - CH 1236757 - CH 9029576 - CH 9029577 - CH 4387094 - CH 4387095 - CH 3500183 - CH 3500184 - DL9 - DC9 PDE ENG 6195783 - ENG 8023978			
● P-G-R-T TRUCK				
★	K/N - D11/12			



CLAMP		64016	1431701	
	● 4 TRUCK			
★	D11L CH 1236756 - CH 1236757 - CH 9029576 - CH 9029577 - CH 4387094 - CH 4387095 - CH 3500183 - CH 3500184 -			



ALL THE COMPONENTS LISTED IN OUR CATALOGUE ARE NOT ORIGINAL, THOUGH PERFECTLY INTERCHANGEABLE. REFERENCE NUMBERS, EITHER ORIGINAL OR OF A DIFFERENT NATURE, ARE FOR INFORMATION PURPOSES ONLY WHEN PLACING AN ORDER, PLEASE, ALWAYS USE COSIBO REFERENCE NUMBERS AND DO NOT MENTION THE ORIGINAL REFERENCE NUMBERS OF THE TRUCK MANUFACTURERS IN THE INVOICE TO VEHICLE OWNERS OR TO ANYBODY ELSE. THE CUSTOMER TAKES HIS OWN RESPONSIBILITY IF HE DOES NOT COMPLY WITH WHAT ABOVE.

	Code	OEM new	OEM old
CLAMP	64358	1433190	
<ul style="list-style-type: none"> ● Model ★ Application 			
<ul style="list-style-type: none"> ● 4 BUS 			
<ul style="list-style-type: none"> ★ DC9/DC11/DC12 PDE HPI ENG 6195783 ENG 8023978 - D9L 			
<ul style="list-style-type: none"> ● F-K-N BUS 			
<ul style="list-style-type: none"> ★ DC9 EEV & EURO 5 F/K/N 			
<ul style="list-style-type: none"> ● IND. MARINE ENGINE 5 			
<ul style="list-style-type: none"> ★ DC9A EMS ENG 6347185 ENG 6347186 			
<ul style="list-style-type: none"> ● 4 TRUCK 			
<ul style="list-style-type: none"> ★ DT12 02/08 ENG 6195782 ENG 8023977 - DC9 PDE ENG 6195783 ENG 8023978 			
<ul style="list-style-type: none"> ● P-G-R-T TRUCK 			
<ul style="list-style-type: none"> ★ DC9 EEV & EURO 5 K/N - D11/12 			



	65177	389035	293152
PEDAL RUBBER COVER			
<ul style="list-style-type: none"> ● 3 BUS 			
<ul style="list-style-type: none"> ★ 			
<ul style="list-style-type: none"> ● 4 BUS 			
<ul style="list-style-type: none"> ★ LHD/RHD - K IM 			
<ul style="list-style-type: none"> ● 3 TRUCK 			
<ul style="list-style-type: none"> ★ 			
<ul style="list-style-type: none"> ● 4 TRUCK 			
<ul style="list-style-type: none"> ★ 94 - 114 - 124 - 144 - 164 			



	65178	1409551	1391676
SPRING			
<ul style="list-style-type: none"> ● 3 BUS 			
<ul style="list-style-type: none"> ★ 			
<ul style="list-style-type: none"> ● 4 BUS 			
<ul style="list-style-type: none"> ★ LHD/RHD - K IB 			
<ul style="list-style-type: none"> ● 3 TRUCK 			
<ul style="list-style-type: none"> ★ 			
<ul style="list-style-type: none"> ● 4 TRUCK 			
<ul style="list-style-type: none"> ★ 94 - 114 - 124 - 144 - 164 			



ALL THE COMPONENTS LISTED IN OUR CATALOGUE ARE NOT ORIGINAL, THOUGH PERFECTLY INTERCHANGEABLE. REFERENCE NUMBERS, EITHER ORIGINAL OR OF A DIFFERENT NATURE, ARE FOR INFORMATION PURPOSES ONLY WHEN PLACING AN ORDER, PLEASE, ALWAYS USE COSIBO REFERENCE NUMBERS AND DO NOT MENTION THE ORIGINAL REFERENCE NUMBERS OF THE TRUCK MANUFACTURERS IN THE INVOICE TO VEHICLE OWNERS OR TO ANYBODY ELSE. THE CUSTOMER TAKES HIS OWN RESPONSIBILITY IF HE DOES NOT COMPLY WITH WHAT ABOVE.

O-RING 114,5X3



	Code	OEM new	OEM old
● Model	60127	323790	362128
★ Application			
● 3 BUS			
★ DS11 74 - D9 - D11 - TE70 - GAV771/773/781/783R - GA773/775/781R			
● 4 BUS			
★ D9L - DSC12 02/05 - F/K/L/N94 - D11/12 - TE91 (TELMA F2400)			
● F-K-N BUS			
★ D9 720 - D9L - F			
● IND. MARINE ENGINE 4			
★ D12A - D12A EMS - SG9 A280 - D16A/M 720 CR - D16M			
● 3 TRUCK			
★ DN/DS/DSC - GR/GRS900 TE70			
● 4 TRUCK			
★ DSC12 01/02/03/05 - D11/D12/D14 - DC11/12 - DC11 01/02 - D11/D12 HPI/PDE - D9L			
● P-G-R-T TRUCK			
★ D11/12 - DC11/12 - DC16 600 - DC16 720CR			

SEAL RING

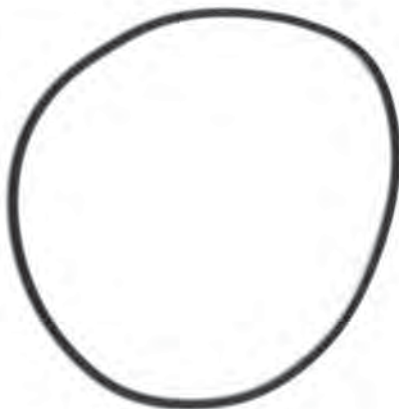

	64210	345083	
● 4 BUS			
★ D9L - DSC12 02/05 - L/N94 720 -			
● IND. MARINE ENGINE 4			
★ D12A			
● 4 TRUCK			
★ D9L			
● P-G-R-T TRUCK			
★ D11/12			

ALL THE COMPONENTS LISTED IN OUR CATALOGUE ARE NOT ORIGINAL, THOUGH PERFECTLY INTERCHANGEABLE. REFERENCE NUMBERS, EITHER ORIGINAL OR OF A DIFFERENT NATURE, ARE FOR INFORMATION PURPOSES ONLY WHEN PLACING AN ORDER, PLEASE, ALWAYS USE COSIBO REFERENCE NUMBERS AND DO NOT MENTION THE ORIGINAL REFERENCE NUMBERS OF THE TRUCK MANUFACTURERS IN THE INVOICE TO VEHICLE OWNERS OR TO ANYBODY ELSE. THE CUSTOMER TAKES HIS OWN RESPONSIBILITY IF HE DOES NOT COMPLY WITH WHAT ABOVE.

COMPRESSOR REPAIR SET

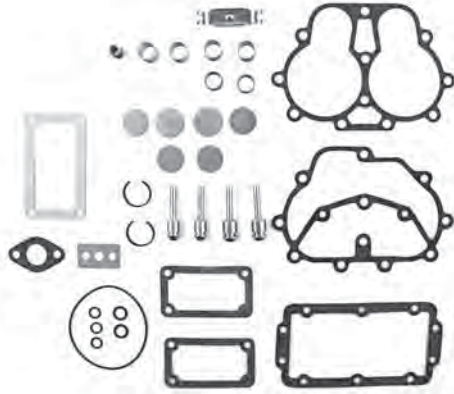

- Model
- ★ Application

Code	OEM new	OEM old
61878	1374083	1108223 1108227 1327886 319747 551435 551436

- 3 BUS



- 3 TRUCK



COMPRESSOR REPAIR SET

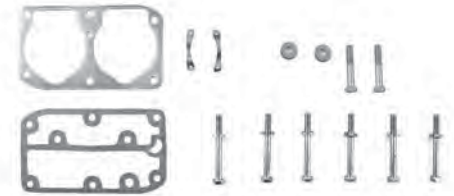

63160	1315376	
--------------	---------	--

- 3 BUS



- 3 TRUCK



- 4 BUS



- 4 TRUCK



- IND. MARINE ENGINE 4



ALL THE COMPONENTS LISTED IN OUR CATALOGUE ARE NOT ORIGINAL, THOUGH PERFECTLY INTERCHANGEABLE. REFERENCE NUMBERS, EITHER ORIGINAL OR OF A DIFFERENT NATURE, ARE FOR INFORMATION PURPOSES ONLY WHEN PLACING AN ORDER, PLEASE, ALWAYS USE COSIBO REFERENCE NUMBERS AND DO NOT MENTION THE ORIGINAL REFERENCE NUMBERS OF THE TRUCK MANUFACTURERS IN THE INVOICE TO VEHICLE OWNERS OR TO ANYBODY ELSE. THE CUSTOMER TAKES HIS OWN RESPONSIBILITY IF HE DOES NOT COMPLY WITH WHAT ABOVE.

	Code	OEM new	OEM old
COMPRESSOR REPAIR SET	63161	1315377	
<ul style="list-style-type: none"> ● Model ★ Application 			
<ul style="list-style-type: none"> ● 3 BUS ★ 			
<ul style="list-style-type: none"> ● 3 TRUCK ★ 			
<ul style="list-style-type: none"> ● 4 BUS ★ 			
<ul style="list-style-type: none"> ● 4 TRUCK ★ 			
<ul style="list-style-type: none"> ● IND. MARINE ENGINE 4 ★ 			



COMPRESSOR REPAIR SET	61790	1542159	1376281
<ul style="list-style-type: none"> ● 4 BUS ★ 			
<ul style="list-style-type: none"> ● 4 TRUCK ★ 			
<ul style="list-style-type: none"> ● F-K-N BUS ★ 			
<ul style="list-style-type: none"> ● IND. MARINE ENGINE 4 ★ D16M 			
<ul style="list-style-type: none"> ● IND. MARINE ENGINE 5 ★ DC9A EMS - SG9 A280 			
<ul style="list-style-type: none"> ● P-G-R-T TRUCK ★ 			



ALL THE COMPONENTS LISTED IN OUR CATALOGUE ARE NOT ORIGINAL, THOUGH PERFECTLY INTERCHANGEABLE. REFERENCE NUMBERS, EITHER ORIGINAL OR OF A DIFFERENT NATURE, ARE FOR INFORMATION PURPOSES ONLY WHEN PLACING AN ORDER, PLEASE, ALWAYS USE COSIBO REFERENCE NUMBERS AND DO NOT MENTION THE ORIGINAL REFERENCE NUMBERS OF THE TRUCK MANUFACTURERS IN THE INVOICE TO VEHICLE OWNERS OR TO ANYBODY ELSE. THE CUSTOMER TAKES HIS OWN RESPONSIBILITY IF HE DOES NOT COMPLY WITH WHAT ABOVE.

COMPRESSOR REPAIR SET



● Model
★ Application

Code	OEM new	OEM old
61852	1391386	

● 4 BUS

★

● 4 TRUCK

★

COMPRESSOR REPAIR SET



Code	OEM new	OEM old
61830	1376280	

● 4 BUS

★

● 4 TRUCK

★

● F-K-N BUS

★

● IND. MARINE ENGINE 4

★ D16M

● IND. MARINE ENGINE 5

★ DC9A EMS - SG9 A280

● P-G-R-T TRUCK

★

ALL THE COMPONENTS LISTED IN OUR CATALOGUE ARE NOT ORIGINAL, THOUGH PERFECTLY INTERCHANGEABLE. REFERENCE NUMBERS, EITHER ORIGINAL OR OF A DIFFERENT NATURE, ARE FOR INFORMATION PURPOSES ONLY WHEN PLACING AN ORDER, PLEASE, ALWAYS USE COSIBO REFERENCE NUMBERS AND DO NOT MENTION THE ORIGINAL REFERENCE NUMBERS OF THE TRUCK MANUFACTURERS IN THE INVOICE TO VEHICLE OWNERS OR TO ANYBODY ELSE. THE CUSTOMER TAKES HIS OWN RESPONSIBILITY IF HE DOES NOT COMPLY WITH WHAT ABOVE.

	Code	OEM new	OEM old
COMPRESSOR REPAIR SET	61831	1376279	
<ul style="list-style-type: none"> ● Model ★ Application 			
<ul style="list-style-type: none"> ● 4 BUS ★ 			
<ul style="list-style-type: none"> ● 4 TRUCK ★ 			
<ul style="list-style-type: none"> ● F-K-N BUS ★ 			
<ul style="list-style-type: none"> ● IND. MARINE ENGINE 4 ★ D16M 			
<ul style="list-style-type: none"> ● IND. MARINE ENGINE 5 ★ DC9A EMS - SG9 A280 			
<ul style="list-style-type: none"> ● P-G-R-T TRUCK ★ 			



	63068	815454	814346
COMPRESSOR HOSE			
<ul style="list-style-type: none"> ● 3 BUS ★ 			
<ul style="list-style-type: none"> ● 3 TRUCK ★ 			
<ul style="list-style-type: none"> ● 4 BUS ★ 			
<ul style="list-style-type: none"> ● 4 TRUCK ★ 			



ALL THE COMPONENTS LISTED IN OUR CATALOGUE ARE NOT ORIGINAL, THOUGH PERFECTLY INTERCHANGEABLE. REFERENCE NUMBERS, EITHER ORIGINAL OR OF A DIFFERENT NATURE, ARE FOR INFORMATION PURPOSES ONLY WHEN PLACING AN ORDER, PLEASE, ALWAYS USE COSIBO REFERENCE NUMBERS AND DO NOT MENTION THE ORIGINAL REFERENCE NUMBERS OF THE TRUCK MANUFACTURERS IN THE INVOICE TO VEHICLE OWNERS OR TO ANYBODY ELSE. THE CUSTOMER TAKES HIS OWN RESPONSIBILITY IF HE DOES NOT COMPLY WITH WHAT ABOVE.

COMPRESSOR HOSE L= 450 MM



	Code	OEM new	OEM old
● Model	63071	815457	814349
★ Application			
● 3 BUS			
★			
● 3 TRUCK			
★			
● 4 BUS			
★ D9L			
● 4 TRUCK			
★ D9 - D9L - D11 - D12 - D14 - DSC11			

COMPRESSOR HOSE L=500 MM



	63073	815458	814350
● 3 BUS			
★			
● 3 TRUCK			
★			
● 4 BUS			
★			
● 4 TRUCK			
★			

COMPRESSOR HOSE L=560 MM



	63074	815459	
● 3 BUS			
★			
● 3 TRUCK			
★			
● 4 BUS			
★ K/L			
● 4 TRUCK			
★ DSC12 01/05 - DT12 02 - DC11 01/02 - D9 - D11 - D12			

ALL THE COMPONENTS LISTED IN OUR CATALOGUE ARE NOT ORIGINAL, THOUGH PERFECTLY INTERCHANGEABLE. REFERENCE NUMBERS, EITHER ORIGINAL OR OF A DIFFERENT NATURE, ARE FOR INFORMATION PURPOSES ONLY WHEN PLACING AN ORDER, PLEASE, ALWAYS USE COSIBO REFERENCE NUMBERS AND DO NOT MENTION THE ORIGINAL REFERENCE NUMBERS OF THE TRUCK MANUFACTURERS IN THE INVOICE TO VEHICLE OWNERS OR TO ANYBODY ELSE. THE CUSTOMER TAKES HIS OWN RESPONSIBILITY IF HE DOES NOT COMPLY WITH WHAT ABOVE.

COMPRESSOR REPAIR SET



● Model
★ Application

Code

OEM new

OEM old

61852

1391386

● F-K-N BUS

★

● IND. MARINE ENGINE 4

★ D16M

● IND. MARINE ENGINE 5

★ DC9A EMS - SG9 A280

● P-G-R-T TRUCK

★

ALL THE COMPONENTS LISTED IN OUR CATALOGUE ARE NOT ORIGINAL, THOUGH PERFECTLY INTERCHANGEABLE. REFERENCE NUMBERS, EITHER ORIGINAL OR OF A DIFFERENT NATURE, ARE FOR INFORMATION PURPOSES ONLY WHEN PLACING AN ORDER, PLEASE, ALWAYS USE COSIBO REFERENCE NUMBERS AND DO NOT MENTION THE ORIGINAL REFERENCE NUMBERS OF THE TRUCK MANUFACTURERS IN THE INVOICE TO VEHICLE OWNERS OR TO ANYBODY ELSE. THE CUSTOMER TAKES HIS OWN RESPONSIBILITY IF HE DOES NOT COMPLY WITH WHAT ABOVE.

SOLENOID VALVE

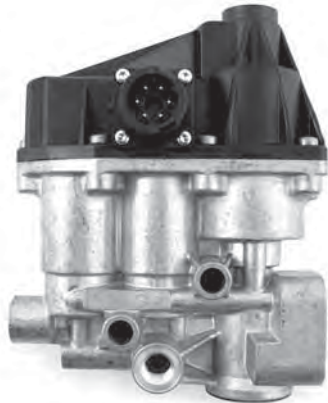

	Code	OEM new	OEM old
● Model	62383	1850567	1736364
★ Application			

● **4 BUS**

★ BR801R K/L94 - 124 - CN94

● **F-K-N BUS**

★

● **4 TRUCK**

★ GRSH900R - GR/GRS/GRSO R

● **P-G-R-T TRUCK**

★

SOLENOID VALVE



	65296	1421599	1364851 1382490
● 3 BUS			
★ GR801R K113			
● 4 BUS			
★ GR801R K/L94 - 124 CN94			
● 3 TRUCK			
★ GR/GRS900R 113/143			
● 4 TRUCK			
★ GRS890R - GR/GRS900R - GRSH900R			

● **3 BUS**

★ GR801R K113

● **4 BUS**

★ GR801R K/L94 - 124 CN94

● **3 TRUCK**

★ GR/GRS900R 113/143

● **4 TRUCK**

★ GRS890R - GR/GRS900R - GRSH900R

ALL THE COMPONENTS LISTED IN OUR CATALOGUE ARE NOT ORIGINAL, THOUGH PERFECTLY INTERCHANGEABLE. REFERENCE NUMBERS, EITHER ORIGINAL OR OF A DIFFERENT NATURE, ARE FOR INFORMATION PURPOSES ONLY WHEN PLACING AN ORDER, PLEASE, ALWAYS USE COSIBO REFERENCE NUMBERS AND DO NOT MENTION THE ORIGINAL REFERENCE NUMBERS OF THE TRUCK MANUFACTURERS IN THE INVOICE TO VEHICLE OWNERS OR TO ANYBODY ELSE. THE CUSTOMER TAKES HIS OWN RESPONSIBILITY IF HE DOES NOT COMPLY WITH WHAT ABOVE.

RETARDER VALVE REPAIR SET



	Code	OEM new	OEM old
● Model	63865	550553	
★ Application			
● 3 BUS			
★ GR/GRS/GRSH.R - GR801R			
● 4 BUS			
★ GR801R CH 1840166 - CH 1840167 - CH 3527416 - CH 3527417 - 3545640 - CH 3545641 - CH 1843282 - CH 1843283 - 1846593 - CH 1846594 -			
● F-K-N BUS			
★ GR801R/GR900R/GRS890R/GRS900R/GRS920R/GRS0900R			
● 3 TRUCK			
★ GR/GRS/GRSH.R - GR/GRS900R			
● 4 TRUCK			
★ GR/GRS/GRSH.R -			
● P-G-R-T TRUCK			
★ GR/GRS/GRSH.R - GR801R/GR900R/GRS890R/GRS900R/GRS920R/GRS0900R			

PISTON REPAIR KIT



	63683	550550	
● 4 BUS			
★ GR/GRS/GRSH/GRSO R			
● F-K-N BUS			
★			
● 4 TRUCK			
★ GR/GRS/GRSH/GRSO R			
● P-G-R-T TRUCK			
★			

ALL THE COMPONENTS LISTED IN OUR CATALOGUE ARE NOT ORIGINAL, THOUGH PERFECTLY INTERCHANGEABLE. REFERENCE NUMBERS, EITHER ORIGINAL OR OF A DIFFERENT NATURE, ARE FOR INFORMATION PURPOSES ONLY WHEN PLACING AN ORDER, PLEASE, ALWAYS USE COSIBO REFERENCE NUMBERS AND DO NOT MENTION THE ORIGINAL REFERENCE NUMBERS OF THE TRUCK MANUFACTURERS IN THE INVOICE TO VEHICLE OWNERS OR TO ANYBODY ELSE. THE CUSTOMER TAKES HIS OWN RESPONSIBILITY IF HE DOES NOT COMPLY WITH WHAT ABOVE.

PISTON RING KIT

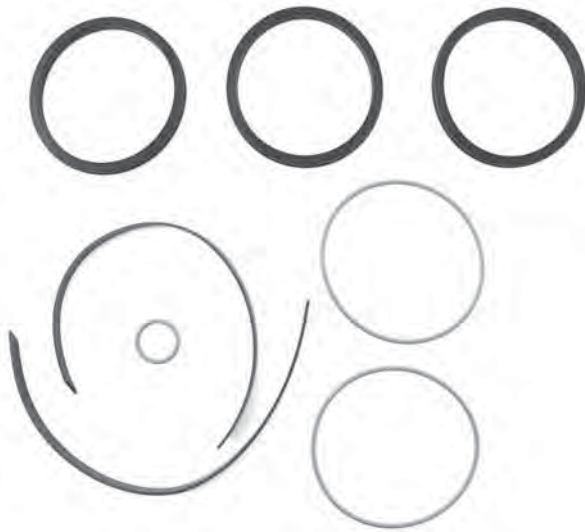

- Model
- ★ Application

Code
63684

OEM new
63684

OEM old

- **4 BUS**

- ★ GR/GRS/GRSH/GRSO R FOR OUR 63683

- **F-K-N BUS**

- ★ FOR OUR 63683

- **4 TRUCK**

- ★ GR/GRS/GRSH/GRSO R FOR OUR 63683

- **P-G-R-T TRUCK**

- ★ FOR OUR 63683

FULL RETARDER REPAIR KIT

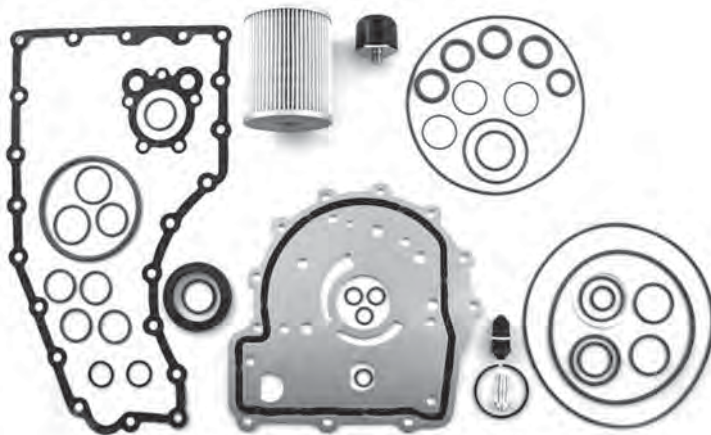

65089

550567

- **3 BUS**

- ★ GR/GRS/GRSH.R

- **4 BUS**

- ★ GR801R

- **3 TRUCK**

- ★ GR/GRS/GRSH.R

- **4 TRUCK**

- ★ GR/GRS/GRSH.R

- **P-G-R-T TRUCK**

- ★ GR/GRS/GRSH.R

ALL THE COMPONENTS LISTED IN OUR CATALOGUE ARE NOT ORIGINAL, THOUGH PERFECTLY INTERCHANGEABLE. REFERENCE NUMBERS, EITHER ORIGINAL OR OF A DIFFERENT NATURE, ARE FOR INFORMATION PURPOSES ONLY WHEN PLACING AN ORDER, PLEASE, ALWAYS USE COSIBO REFERENCE NUMBERS AND DO NOT MENTION THE ORIGINAL REFERENCE NUMBERS OF THE TRUCK MANUFACTURERS IN THE INVOICE TO VEHICLE OWNERS OR TO ANYBODY ELSE. THE CUSTOMER TAKES HIS OWN RESPONSIBILITY IF HE DOES NOT COMPLY WITH WHAT ABOVE.

FULL RETARDER REPAIR KIT W/O FILTER

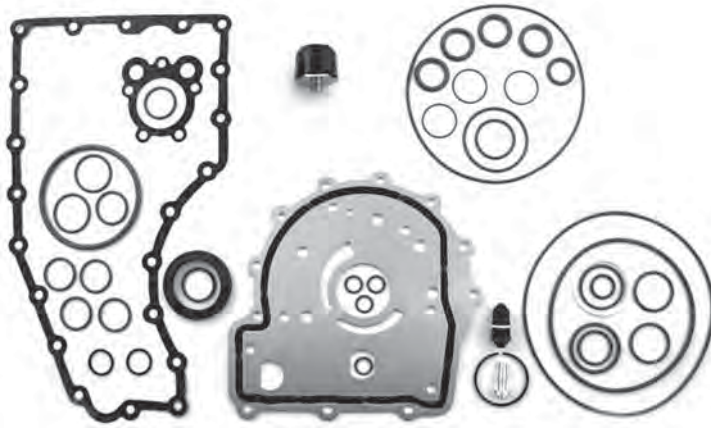

● Model
★ Application

Code	OEM new	OEM old
65089/2	550567/2	

- **3 BUS**
- ★ GR/GRS/GRSH.R
- **4 BUS**
- ★ GR801R
- **3 TRUCK**
- ★ GR/GRS/GRSH.R
- **4 TRUCK**
- ★ GR/GRS/GRSH.R
- **P-G-R-T TRUCK**
- ★ GR/GRS/GRSH.R

RETARDER OIL FILTER



62361	1381235	1329876
-------	---------	---------

- **3 BUS**
- ★ GR/GRS/GRSH R - GR801R
- **4 BUS**
- ★ GR801R
- **F-K-N BUS**
- ★ GR801R/GR900R/GRS890R/GRS900R/GRS920R/GRS0900R - GR875R - GRS/GR-S0895R - GR/GRS/GRS0905R
- **3 TRUCK**
- ★ GR/GRS/GRSH R - GR/GRS900R
- **4 TRUCK**
- ★ GR/GRS/GRSH R - GR/GRS/GRSH/GRS0/R
- **P-G-R-T TRUCK**
- ★ GR/GRS/GRSH R - GR801R/GR900R/GRS890R/GRS900R/GRS920R/GRS0900R - GR875R - GRS895R - GR/GRS/GRS0905R -

ALL THE COMPONENTS LISTED IN OUR CATALOGUE ARE NOT ORIGINAL, THOUGH PERFECTLY INTERCHANGEABLE. REFERENCE NUMBERS, EITHER ORIGINAL OR OF A DIFFERENT NATURE, ARE FOR INFORMATION PURPOSES ONLY WHEN PLACING AN ORDER, PLEASE, ALWAYS USE COSIBO REFERENCE NUMBERS AND DO NOT MENTION THE ORIGINAL REFERENCE NUMBERS OF THE TRUCK MANUFACTURERS IN THE INVOICE TO VEHICLE OWNERS OR TO ANYBODY ELSE. THE CUSTOMER TAKES HIS OWN RESPONSIBILITY IF HE DOES NOT COMPLY WITH WHAT ABOVE.

	Code	OEM new	OEM old
FILTER KIT	63407	550154	
<ul style="list-style-type: none"> ● Model ★ Application 			
<ul style="list-style-type: none"> ● 4 BUS ★ 			
<ul style="list-style-type: none"> ● F-K-N BUS ★ 			
<ul style="list-style-type: none"> ● 4 TRUCK ★ 			
<ul style="list-style-type: none"> ● P-G-R-T TRUCK ★ 			



	61632	1312934	323641
O-RING			
<ul style="list-style-type: none"> ● 3 BUS ★ GR/GRS/GRSH R - GR801R 			
<ul style="list-style-type: none"> ● 4 BUS ★ GR801R - GR801R CN94 			
<ul style="list-style-type: none"> ● F-K-N BUS ★ GR801R/GR900R/GRS890R/GRS900R/GRS920R/GRSO900R 			
<ul style="list-style-type: none"> ● 3 TRUCK ★ GR/GRS/GRSH R - GR/GRS900R 			
<ul style="list-style-type: none"> ● 4 TRUCK ★ GR/GRS/GRSH/GRSO R 			
<ul style="list-style-type: none"> ● P-G-R-T TRUCK ★ GR/GRS/GRSH R - GR801R/GR900R/GRS890R/GRS900R/GRS920R/GRSO900R 			

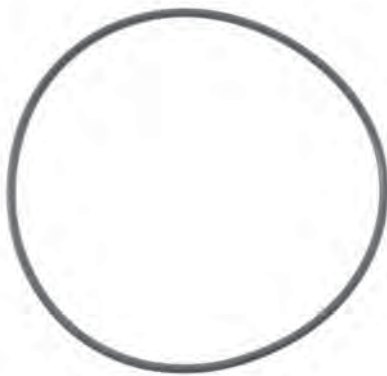



	62512	1371839	295960
CAP			
<ul style="list-style-type: none"> ● 3 TRUCK ★ 			



ALL THE COMPONENTS LISTED IN OUR CATALOGUE ARE NOT ORIGINAL, THOUGH PERFECTLY INTERCHANGEABLE. REFERENCE NUMBERS, EITHER ORIGINAL OR OF A DIFFERENT NATURE, ARE FOR INFORMATION PURPOSES ONLY WHEN PLACING AN ORDER, PLEASE, ALWAYS USE COSIBO REFERENCE NUMBERS AND DO NOT MENTION THE ORIGINAL REFERENCE NUMBERS OF THE TRUCK MANUFACTURERS IN THE INVOICE TO VEHICLE OWNERS OR TO ANYBODY ELSE. THE CUSTOMER TAKES HIS OWN RESPONSIBILITY IF HE DOES NOT COMPLY WITH WHAT ABOVE.

		Code	OEM new	OEM old
CAP	● Model	62397	308678	
	★ Application			
	● 3 BUS			
	★			

		63963	1411129	1384116
AIR PLUG	● 3 BUS			
	★ GR/GRS/GRSH R - GR801R			
	● 4 BUS			
	★ GR801R			
	● F-K-N BUS			
	★ GR801R/GR900R/GRS890R/GRS900R/GRS920R/GRS0900R			
	● 3 TRUCK			
	★ GR/GRS/GRSH R - GR/GRS900R			
	● 4 TRUCK			
	★ GR/GRS/GRSH/GRSO R			
	● P-G-R-T TRUCK			
	★ GR/GRS/GRSH R - GR801R/GR900R/GRS890R/GRS900R/GRS920R/GRS0900R			

		63929	1388070	
RUBBER BUFFER	● F-K-N BUS			
	★ N APS - K UD - APS - ADA1300 - K UD 6X2			
	● P-G-R-T TRUCK			
	★ GA750/850/760/860R			

ALL THE COMPONENTS LISTED IN OUR CATALOGUE ARE NOT ORIGINAL, THOUGH PERFECTLY INTERCHANGEABLE. REFERENCE NUMBERS, EITHER ORIGINAL OR OF A DIFFERENT NATURE, ARE FOR INFORMATION PURPOSES ONLY WHEN PLACING AN ORDER, PLEASE, ALWAYS USE COSIBO REFERENCE NUMBERS AND DO NOT MENTION THE ORIGINAL REFERENCE NUMBERS OF THE TRUCK MANUFACTURERS IN THE INVOICE TO VEHICLE OWNERS OR TO ANYBODY ELSE. THE CUSTOMER TAKES HIS OWN RESPONSIBILITY IF HE DOES NOT COMPLY WITH WHAT ABOVE.

LOCK NUT



● Model
★ Application

Code

OEM new

OEM old

60836

1525988

387877

● 3 BUS

★ TE70

● 3 TRUCK

★ GR/GRE871/871T - GR/GRS900 TE70

● 4 BUS

★ TE91

ALL THE COMPONENTS LISTED IN OUR CATALOGUE ARE NOT ORIGINAL, THOUGH PERFECTLY INTERCHANGEABLE. REFERENCE NUMBERS, EITHER ORIGINAL OR OF A DIFFERENT NATURE, ARE FOR INFORMATION PURPOSES ONLY WHEN PLACING AN ORDER, PLEASE, ALWAYS USE COSIBO REFERENCE NUMBERS AND DO NOT MENTION THE ORIGINAL REFERENCE NUMBERS OF THE TRUCK MANUFACTURERS IN THE INVOICE TO VEHICLE OWNERS OR TO ANYBODY ELSE. THE CUSTOMER TAKES HIS OWN RESPONSIBILITY IF HE DOES NOT COMPLY WITH WHAT ABOVE.

	Code	OEM new	OEM old
SEAL RING	64103	1871043	1376911
<ul style="list-style-type: none"> ● Model ★ Application 			
<ul style="list-style-type: none"> ● 4 BUS 			
<ul style="list-style-type: none"> ★ D9L - DSC12 02/05 - F94 - K94 - D11/D12 			
<ul style="list-style-type: none"> ● F-K-N BUS 			
<ul style="list-style-type: none"> ★ D9L - D9 - D12 - DC12 - K D9 720CR - F - N D9 720CR 			
<ul style="list-style-type: none"> ● IND. MARINE ENGINE 4 			
<ul style="list-style-type: none"> ★ D16M - SG9 A280 			
<ul style="list-style-type: none"> ● IND. MARINE ENGINE 5 			
<ul style="list-style-type: none"> ★ DC9A EMS 			
<ul style="list-style-type: none"> ● 4 TRUCK 			
<ul style="list-style-type: none"> ★ DSC12 01/02/03/05 - DC11 01/02 - D11/D12 HPI/PDE - D9L 			
<ul style="list-style-type: none"> ● P-G-R-T TRUCK 			
<ul style="list-style-type: none"> ★ D11/D12 - D9 - D13 720CR - DC11/12 - DC16 			



ALL THE COMPONENTS LISTED IN OUR CATALOGUE ARE NOT ORIGINAL, THOUGH PERFECTLY INTERCHANGEABLE. REFERENCE NUMBERS, EITHER ORIGINAL OR OF A DIFFERENT NATURE, ARE FOR INFORMATION PURPOSES ONLY WHEN PLACING AN ORDER, PLEASE, ALWAYS USE COSIBO REFERENCE NUMBERS AND DO NOT MENTION THE ORIGINAL REFERENCE NUMBERS OF THE TRUCK MANUFACTURERS IN THE INVOICE TO VEHICLE OWNERS OR TO ANYBODY ELSE. THE CUSTOMER TAKES HIS OWN RESPONSIBILITY IF HE DOES NOT COMPLY WITH WHAT ABOVE.

	Code	OEM new	OEM old
SAFETY VALVE	65096	303496	
<ul style="list-style-type: none"> ● Model ★ Application 			
<ul style="list-style-type: none"> ● 2 TRUCK ★ 			
<ul style="list-style-type: none"> ● 3 TRUCK ★ 			



SOLENOID VALVE	65191	1536304	1340231 1421322
<ul style="list-style-type: none"> ● 3 BUS ★ DS11 DSC11 - DSC1104 1127 - GR801R K113 			
<ul style="list-style-type: none"> ● 4 BUS ★ ADA1350 ABS&TC&BSB - GR801R K/L94 - 124 CN94 			
<ul style="list-style-type: none"> ● 3 TRUCK ★ DN9 - DN11 - DSC14 - DSC14 LHD CR - DS9 DSC9 - DS9 4X4 - DS11 DSC11 - DS9 DSC9 6X4 - DTC11 - GR/GRS900R 			
<ul style="list-style-type: none"> ● 4 TRUCK ★ 8X8 WLS/ZLS - EBS 8X2 8X4 8X2/6 A/B - ABS 4X2 6X2 8X2 6X4 8X4 6X2/4 8X2/4 8X4/4 - 6X2 AD FR ABS 			



SWITCH	61708	288649	
<ul style="list-style-type: none"> ● 3 BUS ★ MANUAL AND AUTOMATIC GEARBOX 			
<ul style="list-style-type: none"> ● 3 TRUCK ★ 			



ALL THE COMPONENTS LISTED IN OUR CATALOGUE ARE NOT ORIGINAL, THOUGH PERFECTLY INTERCHANGEABLE. REFERENCE NUMBERS, EITHER ORIGINAL OR OF A DIFFERENT NATURE, ARE FOR INFORMATION PURPOSES ONLY WHEN PLACING AN ORDER, PLEASE, ALWAYS USE COSIBO REFERENCE NUMBERS AND DO NOT MENTION THE ORIGINAL REFERENCE NUMBERS OF THE TRUCK MANUFACTURERS IN THE INVOICE TO VEHICLE OWNERS OR TO ANYBODY ELSE. THE CUSTOMER TAKES HIS OWN RESPONSIBILITY IF HE DOES NOT COMPLY WITH WHAT ABOVE.

BRAKE VALVE



	Code	OEM new	OEM old
● Model	62459	1324663	1324664
★ Application			
● 4 TRUCK			
★ 94 - 114 - 124 - 144 - 164 WITHOUT RETARDER			
● P-G-R-T TRUCK			
★ WITHOUT RETARDER			

BUSHING



	65179	283650	
● 3 BUS			
★			
● 3 TRUCK			
★			

RELAY



	63447	1431781	1391322 243460
● 3 BUS			
★ DSC1108 - DSC1108B			

SWITCH



	65237	397946	368851
● 3 BUS			
★			
● 3 TRUCK			
★			
● 4 TRUCK			
★			

ALL THE COMPONENTS LISTED IN OUR CATALOGUE ARE NOT ORIGINAL, THOUGH PERFECTLY INTERCHANGEABLE. REFERENCE NUMBERS, EITHER ORIGINAL OR OF A DIFFERENT NATURE, ARE FOR INFORMATION PURPOSES ONLY WHEN PLACING AN ORDER, PLEASE, ALWAYS USE COSIBO REFERENCE NUMBERS AND DO NOT MENTION THE ORIGINAL REFERENCE NUMBERS OF THE TRUCK MANUFACTURERS IN THE INVOICE TO VEHICLE OWNERS OR TO ANYBODY ELSE. THE CUSTOMER TAKES HIS OWN RESPONSIBILITY IF HE DOES NOT COMPLY WITH WHAT ABOVE.

	Code	OEM new	OEM old
<p>SWITCH</p> 	61195	159656	
<ul style="list-style-type: none"> ● Model ★ Application 			
<ul style="list-style-type: none"> ● 3 BUS ★ 			
<ul style="list-style-type: none"> ● 3 TRUCK ★ DTC11 - DN11 - DSC14 - DS9 - DSC9 - DS11 - DSC11 - DN9 			
<p>SENSOR BULB</p> 	64070	1361131	
<ul style="list-style-type: none"> ● 4 BUS ★ 94E/124E - 94U - ASA1000 			
<ul style="list-style-type: none"> ● 4 TRUCK ★ 8X8 WLS/ZLS 			

ALL THE COMPONENTS LISTED IN OUR CATALOGUE ARE NOT ORIGINAL, THOUGH PERFECTLY INTERCHANGEABLE. REFERENCE NUMBERS, EITHER ORIGINAL OR OF A DIFFERENT NATURE, ARE FOR INFORMATION PURPOSES ONLY WHEN PLACING AN ORDER, PLEASE, ALWAYS USE COSIBO REFERENCE NUMBERS AND DO NOT MENTION THE ORIGINAL REFERENCE NUMBERS OF THE TRUCK MANUFACTURERS IN THE INVOICE TO VEHICLE OWNERS OR TO ANYBODY ELSE. THE CUSTOMER TAKES HIS OWN RESPONSIBILITY IF HE DOES NOT COMPLY WITH WHAT ABOVE.

LH BRAKE CAMSHAFT



	Code	OEM new	OEM old
● Model	64065	1340859	
★ Application			
● 4 BUS			
★ AM860 - AM920 - AMA780 - K124 8X2(AMA60X2) - AMA860 - ASA701			
● F-K-N BUS			
★ AM920 - ASA701 - AMA860 - AMA780 6X2*4 - ARA860 6X2*4 - AMA860/780			
● 3 TRUCK			
★ AM800/AM820			
● 4 TRUCK			
★ AM620 - AM621AM900/920 - AM/AMA740/760/780 - AMA860 - AMFR/AMRE - AM/AMA 8X2 8X4 - ASA700 - ARA900			
● P-G-R-T TRUCK			
★ AM621 - ARA760/820/900 - ASA700			

RH BRAKE CAMSHAFT



	64064	1340860	
● 4 BUS			
★ AM860 - AM920 - AMA780 - K124 8X2(AMA60X2) - AMA860 - ASA701			
● F-K-N BUS			
★ AM920 - ASA701 - AMA860 - AMA780 6X2*4 - ARA860 6X2*4 - AMA860/780			
● 3 TRUCK			
★ AM800/AM820			
● 4 TRUCK			
★ AM620 - AM621AM900/920 - AM/AMA740/760/780 - AMA860 - AMFR/AMRE - AM/AMA 8X2 8X4 - ASA700 - ARA900			
● P-G-R-T TRUCK			
★ AM621 - ARA760/820/900 - ASA700			

ALL THE COMPONENTS LISTED IN OUR CATALOGUE ARE NOT ORIGINAL, THOUGH PERFECTLY INTERCHANGEABLE. REFERENCE NUMBERS, EITHER ORIGINAL OR OF A DIFFERENT NATURE, ARE FOR INFORMATION PURPOSES ONLY WHEN PLACING AN ORDER, PLEASE, ALWAYS USE COSIBO REFERENCE NUMBERS AND DO NOT MENTION THE ORIGINAL REFERENCE NUMBERS OF THE TRUCK MANUFACTURERS IN THE INVOICE TO VEHICLE OWNERS OR TO ANYBODY ELSE. THE CUSTOMER TAKES HIS OWN RESPONSIBILITY IF HE DOES NOT COMPLY WITH WHAT ABOVE.

LH BRAKE CAMSHAFT



	Code	OEM new	OEM old
● Model	64260	1342745	
★ Application			
● 3 BUS			
★ K 113 CLP/TLP - AD/ADA90 - ATA90			
● 3 TRUCK			
★ AD80 R641/653 - RB652 - AD90 R642 4X4 - R770/780 - AD/ADA90 R642/660/770 - RB652 - 6X4 8X4 - AD100 RP831 4X4 6X4 - RP831/832 6X4 6X6 8X4 - AD100 RBP831/832 6X4 6X6 8X4 - ASA80			
● 4 BUS			
★ AD1300 - ASA1300			
● 4 TRUCK			
★ AD/ADA1100/1300/1500 - AD/ADA1500P RP832 - AD/ADA1501P - AD/ADA1300 R660 - AS1300			
● F-K-N BUS			
★ ADA1300 4X2 6X2 6X2/4 - AD1300			
● P-G-R-T TRUCK			
★ 4X4 6X4 6X6 8X4 8X4/4 - ADA1100/1300 - AD1300 - AD/1501P - ASA1000			

RH BRAKE CAMSHAFT



	64261	1342746	
● 3 BUS			
★ K 113 CLP/TLP - AD/ADA90 - ATA90			
● 3 TRUCK			
★ AD80 R641/653 - RB652 - AD90 R642 4X4 - R770/780 - AD/ADA90 R642/660/770 - RB652 - 6X4 8X4 - AD100 RP831 4X4 6X4 - RP831/832 6X4 6X6 8X4 - AD100 RBP831/832 6X4 6X6 8X4 - ASA80			
● 4 BUS			
★ AD1300 - ASA1300			
● 4 TRUCK			
★ AD/ADA1100/1300/1500 - AD/ADA1500P RP832 - AD/ADA1501P - AD/ADA1300 R660 - AS1300			
● F-K-N BUS			
★ ADA1300 4X2 6X2 6X2/4 - AD1300			
● P-G-R-T TRUCK			
★ 4X4 6X4 6X6 8X4 8X4/4 - ADA1100/1300 - AD1300 - AD/1501P - ASA1000			

ALL THE COMPONENTS LISTED IN OUR CATALOGUE ARE NOT ORIGINAL, THOUGH PERFECTLY INTERCHANGEABLE. REFERENCE NUMBERS, EITHER ORIGINAL OR OF A DIFFERENT NATURE, ARE FOR INFORMATION PURPOSES ONLY WHEN PLACING AN ORDER, PLEASE, ALWAYS USE COSIBO REFERENCE NUMBERS AND DO NOT MENTION THE ORIGINAL REFERENCE NUMBERS OF THE TRUCK MANUFACTURERS IN THE INVOICE TO VEHICLE OWNERS OR TO ANYBODY ELSE. THE CUSTOMER TAKES HIS OWN RESPONSIBILITY IF HE DOES NOT COMPLY WITH WHAT ABOVE.

OIL SEAL 38,1X50X6,80



	Code	OEM new	OEM old
● Model	64800	1349089	
★ Application			
● 3 BUS			
★ AMA56/61 - AMI61 - AM56/61			
● 3 TRUCK			
★ AM800/820			
● 4 BUS			
★ AM780/860/920 - K124 8X2 AMA60X2 - AMA860 - ASA701			
● 4 TRUCK			
★ AM/AMA740/760/780 - AM620/621 - AM900/920 - ASA70/700/900 - ARA900 - AMD900			
● F-K-N BUS			
★ AM920 - ASA701 - AMA780 - AMA860 - AM780 6X2/4 - ARA860 6X2/4 - KIB			
● P-G-R-T TRUCK			
★ AM621 - AMD900 - ARA760/820/900 - ASA700 - AS900			

BRONZE BUSHING



	60547	289336	
● 3 BUS			
★ AM56 - AM61 - AMA56 - AMA61 - AMI61			
● 4 BUS			
★ AM860 - AM920 - AMA780 - AMA860 - K124 8X2(MA60X2) - ASA701			
● F-K-N BUS			
★ AM920 - ASA701 - AMA860 - AM780 6X2*4 - ARA860 6X2*4 - AMA860/780			
● 3 TRUCK			
★ AM56 - AM56 MK8X4 - AM56 HK/MK8X4 - AM61 - AM70 - AM/AMA61 - AM61 MK8X4 - AM61 HK/MK/EK8X4 - AMD105 - AM800/AM820 - AS60 (6X2) - ASA70 (6X2) - AS90 (6X2 8X2) - ARA56 - ARA61			
● 4 TRUCK			
★ AM620 - AM621 - AM900/920 - AM/AMA740/760/780 - AMA860 - ASA 700 - ASA70 (6X2) - AMFR/AMRE AM/AMA 8X2 8X4 - ARA900 - AS900 - AMD900			
● P-G-R-T TRUCK			
★ AM621 - AMD900 - ARA760/820/900 - ASA700 - AS900			

ALL THE COMPONENTS LISTED IN OUR CATALOGUE ARE NOT ORIGINAL, THOUGH PERFECTLY INTERCHANGEABLE. REFERENCE NUMBERS, EITHER ORIGINAL OR OF A DIFFERENT NATURE, ARE FOR INFORMATION PURPOSES ONLY WHEN PLACING AN ORDER, PLEASE, ALWAYS USE COSIBO REFERENCE NUMBERS AND DO NOT MENTION THE ORIGINAL REFERENCE NUMBERS OF THE TRUCK MANUFACTURERS IN THE INVOICE TO VEHICLE OWNERS OR TO ANYBODY ELSE. THE CUSTOMER TAKES HIS OWN RESPONSIBILITY IF HE DOES NOT COMPLY WITH WHAT ABOVE.

	Code	OEM new	OEM old
METAL BUSHING (OLD TYPE)	60547/1	134494	
<ul style="list-style-type: none"> ● Model ★ Application 			
<ul style="list-style-type: none"> ● 3 BUS 			
<ul style="list-style-type: none"> ★ AM56 - AM61 - AMA56 - AMA61 - AMI61 			
<ul style="list-style-type: none"> ● 4 BUS 			
<ul style="list-style-type: none"> ★ AM860 - AM920 - AMA780 - AMA860 - K124 8X2(MA60X2) - ASA701 			
<ul style="list-style-type: none"> ● F-K-N BUS 			
<ul style="list-style-type: none"> ★ AM920 - ASA701 - AMA860 - AM780 6X2*4 - ARA860 6X2*4 - AMA860/780 			
<ul style="list-style-type: none"> ● 3 TRUCK 			
<ul style="list-style-type: none"> ★ AM56 - AM56 MK8X4 - AM56 HK/MK8X4 - AM61 - AM70 - AM/AMA61 - AM61 MK8X4 - AM61 HK/MK/EK8X4 - AMD105 - AM800/AM820 - AS60 (6X2) - ASA70 (6X2) - AS90 (6X2 8X2) - ARA56 - ARA61 			
<ul style="list-style-type: none"> ● 4 TRUCK 			
<ul style="list-style-type: none"> ★ AM620 - AM621 - AM900/920 - AM/AMA740/760/780 - AMA860 - ASA 700 - ASA70 (6X2) - AMFR/AMRE AM/AMA 8X2 8X4 - ARA900 - AS900 - AMD900 			
<ul style="list-style-type: none"> ● P-G-R-T TRUCK 			
<ul style="list-style-type: none"> ★ AM621 - AMD900 - ARA760/820/900 - ASA700 - AS900 			



ALL THE COMPONENTS LISTED IN OUR CATALOGUE ARE NOT ORIGINAL, THOUGH PERFECTLY INTERCHANGEABLE. REFERENCE NUMBERS, EITHER ORIGINAL OR OF A DIFFERENT NATURE, ARE FOR INFORMATION PURPOSES ONLY WHEN PLACING AN ORDER, PLEASE, ALWAYS USE COSIBO REFERENCE NUMBERS AND DO NOT MENTION THE ORIGINAL REFERENCE NUMBERS OF THE TRUCK MANUFACTURERS IN THE INVOICE TO VEHICLE OWNERS OR TO ANYBODY ELSE. THE CUSTOMER TAKES HIS OWN RESPONSIBILITY IF HE DOES NOT COMPLY WITH WHAT ABOVE.

	Code	OEM new	OEM old
SEAL RING	64088	1321727	
<ul style="list-style-type: none"> ● Model ★ Application 			
<ul style="list-style-type: none"> ● 3 BUS 			
<ul style="list-style-type: none"> ★ ATA90 			
<ul style="list-style-type: none"> ● 4 BUS 			
<ul style="list-style-type: none"> ★ ADA1300 R660 - R780 - AD1300 - ASA1300 			
<ul style="list-style-type: none"> ● F-K-N BUS 			
<ul style="list-style-type: none"> ★ ADA1300 4X2 6X2 6X2*4 - F AD1300 			
<ul style="list-style-type: none"> ● 3 TRUCK 			
<ul style="list-style-type: none"> ★ AD85 RBP730 6X4HK 8X4HK ADFR ADRE - AD85 RP730 6X4HK 8X4HK ADRE 			
<ul style="list-style-type: none"> ● 4 TRUCK 			
<ul style="list-style-type: none"> ★ AD/ADA1501P - RBP/RP832 835 - 4X4 6X6 - AD/ADA1501P ADRE 6X4 8X4 - 8X8 AD1101P - AD1100P 4X4 - 6X4 - 8X4 - 6X6 ADRE - AS1300 - ASA1000 6X2 - 8X2 - 8X2/4 - AD/ADA1500P RP832 - ADRE 6X4 - 8X4 - 6X6 - 8X8 - AD/ADA1500P - 1501P ADFR 6X4 - 6X6 - 8X4 - AD/ADA1300 ADRE R660/ADFR RB660 6X4 - 8X4 - ASA80 6X2 - AD/ADA1100/1300/1500 			
<ul style="list-style-type: none"> ● P-G-R-T TRUCK 			
<ul style="list-style-type: none"> ★ 6X4 8X4 8X4*4 - 4X4 6X6 AMRE - 6X6 AD FR - ADA1100/1300 - ADA1501P - AD1501P - ASA1000 			



SEAL RING DIAM.45x60x7 (NBR)	60958	120828	
<ul style="list-style-type: none"> ● 3 TRUCK 			
<ul style="list-style-type: none"> ★ AD90 R642 4X2 - AD100 RP831 4X4 - AD80 R641 - AD90 R770/R780 - AD100 RBP831 6X4 AD FR - AD100 RBP831/832 6X4 6X6 8X4 AD FR - AD RE - AD100 RP831 6X4 8X4 E6X4 EL8X4 AD RE - AD/ADA90 R642/660/770 - AD80 RB652 AD FR M6X4fb MK8X4 - AD80 R653 AD RE M6X4fb MK6X4 MK8X4 - AD90 RB652 AD FR 6X4 8X4 - AD90 R653 AD RE 6X4 8X4 - ASA80 MV6X2LB ML6X2A/B MA6X2A 			



ALL THE COMPONENTS LISTED IN OUR CATALOGUE ARE NOT ORIGINAL, THOUGH PERFECTLY INTERCHANGEABLE. REFERENCE NUMBERS, EITHER ORIGINAL OR OF A DIFFERENT NATURE, ARE FOR INFORMATION PURPOSES ONLY WHEN PLACING AN ORDER, PLEASE, ALWAYS USE COSIBO REFERENCE NUMBERS AND DO NOT MENTION THE ORIGINAL REFERENCE NUMBERS OF THE TRUCK MANUFACTURERS IN THE INVOICE TO VEHICLE OWNERS OR TO ANYBODY ELSE. THE CUSTOMER TAKES HIS OWN RESPONSIBILITY IF HE DOES NOT COMPLY WITH WHAT ABOVE.

	Code	OEM new	OEM old
BRAKE FORK	61325	280651	
● Model			
★ Application			
● 3 BUS			
★			
● 3 TRUCK			
★			
● 4 BUS			
★			
● 4 TRUCK			
★			
● F-K-N BUS			
★			
● P-G-R-T TRUCK			
★			



	61335	280652	
BRAKE PIN			
● 3 BUS			
★			
● 3 TRUCK			
★			
● 4 BUS			
★			
● 4 TRUCK			
★			



ALL THE COMPONENTS LISTED IN OUR CATALOGUE ARE NOT ORIGINAL, THOUGH PERFECTLY INTERCHANGEABLE. REFERENCE NUMBERS, EITHER ORIGINAL OR OF A DIFFERENT NATURE, ARE FOR INFORMATION PURPOSES ONLY WHEN PLACING AN ORDER, PLEASE, ALWAYS USE COSIBO REFERENCE NUMBERS AND DO NOT MENTION THE ORIGINAL REFERENCE NUMBERS OF THE TRUCK MANUFACTURERS IN THE INVOICE TO VEHICLE OWNERS OR TO ANYBODY ELSE. THE CUSTOMER TAKES HIS OWN RESPONSIBILITY IF HE DOES NOT COMPLY WITH WHAT ABOVE.

BRAKE DISK



	Code	OEM new	OEM old
● Model	61622	1852817	1402272
★ Application			
● 4 BUS			
★	AM/AMA/AMI - ASA1300 - ARA860 - AMA780/860 - AMI700 - ADA1300		
● 4 TRUCK			
★	ASA700/752/1000/1052 - AM/AMA - AD/ADA - ARA760/820/900		
● F-K-N BUS			
★	ARA860 - AM/AMA860 - AMA780 - AMI700 - ASA760/1300		
● P-G-R-T TRUCK			
★	AMA860 - ADA1300 - ASA700/720/752/760/1000/1052		

BRAKE PIN



	61335	280652	
● F-K-N BUS			
★			
● P-G-R-T TRUCK			
★			

REPAIR SET



	63757	1104213	
● 3 BUS			
★	COMPOSED BY: N.1 PC 61325 - N.1 PC 61335 - N.1 PC 61336		
● 3 TRUCK			
★	COMPOSED BY: N.1 PC 61325 - N.1 PC 61335 - N.1 PC 61336		
● 4 BUS			
★	COMPOSED BY: N.1 PC 61325 - N.1 PC 61335 - N.1 PC 61336		
● 4 TRUCK			
★	COMPOSED BY: N.1 PC 61325 - N.1 PC 61335 - N.1 PC 61336		
● F-K-N BUS			
★	COMPOSED BY: N.1 PC 61325 - N.1 PC 61335 - N.1 PC 61336		
● P-G-R-T TRUCK			
★	COMPOSED BY: N.1 PC 61325 - N.1 PC 61335 - N.1 PC 61336		

ALL THE COMPONENTS LISTED IN OUR CATALOGUE ARE NOT ORIGINAL, THOUGH PERFECTLY INTERCHANGEABLE. REFERENCE NUMBERS, EITHER ORIGINAL OR OF A DIFFERENT NATURE, ARE FOR INFORMATION PURPOSES ONLY WHEN PLACING AN ORDER, PLEASE, ALWAYS USE COSIBO REFERENCE NUMBERS AND DO NOT MENTION THE ORIGINAL REFERENCE NUMBERS OF THE TRUCK MANUFACTURERS IN THE INVOICE TO VEHICLE OWNERS OR TO ANYBODY ELSE. THE CUSTOMER TAKES HIS OWN RESPONSIBILITY IF HE DOES NOT COMPLY WITH WHAT ABOVE.

	Code	OEM new	OEM old
<p>BRAKE PAD SET</p> 	61906	1856108	1390428 1527633 1734529 1890861
<ul style="list-style-type: none"> ● Model ★ Application 			
<ul style="list-style-type: none"> ● 4 TRUCK ★ AM/AMA - AD/ADA - ARA - ASA 			

	Code	OEM new	OEM old
<p>BRAKE PAD WIRE SENSOR</p> 	64801	1794440	1731309
<ul style="list-style-type: none"> ● 4 BUS ★ 			
<ul style="list-style-type: none"> ● 4 TRUCK ★ 			
<ul style="list-style-type: none"> ● F-K-N BUS ★ 			

	Code	OEM new	OEM old
<p>MANUAL SLACK ADJUSTER</p> 	61163	1448110	218684
<ul style="list-style-type: none"> ● 3 TRUCK ★ AMD105 - AD90 R653 6X4 8X4 			

ALL THE COMPONENTS LISTED IN OUR CATALOGUE ARE NOT ORIGINAL, THOUGH PERFECTLY INTERCHANGEABLE. REFERENCE NUMBERS, EITHER ORIGINAL OR OF A DIFFERENT NATURE, ARE FOR INFORMATION PURPOSES ONLY WHEN PLACING AN ORDER, PLEASE, ALWAYS USE COSIBO REFERENCE NUMBERS AND DO NOT MENTION THE ORIGINAL REFERENCE NUMBERS OF THE TRUCK MANUFACTURERS IN THE INVOICE TO VEHICLE OWNERS OR TO ANYBODY ELSE. THE CUSTOMER TAKES HIS OWN RESPONSIBILITY IF HE DOES NOT COMPLY WITH WHAT ABOVE.

LH MANUAL SLACK ADJUSTER



	Code	OEM new	OEM old
● Model	61166	1448111	276517
★ Application			
● 3 BUS			
★			
● 3 TRUCK			
★ AM56/61/70 - AMA61			

RH MANUAL SLACK ADJUSTER



	61167	1448112	276518
● 3 BUS			
★			
● 3 TRUCK			
★ AM56/61/70 - AMA61			

LH MANUAL SLACK ADJUSTER



	61169	1448115	278736
● 3 BUS			
★			
● 3 TRUCK			
★			
● 4 BUS			
★ ADA1300 R660/780 - AD1300 - ASA1300			
● 4 TRUCK			
★ AD/ADA1100 - AD/ADA1300 - AD/ADA1500 - AD/ADA1501 - ASA1000 - AS1300			
● F-K-N BUS			
★ ADA1300 4X2 6X2 6X2/4 - AD1300			
● P-G-R-T TRUCK			
★ ADA1100/1300 - AD1300 - AD/ADA1501P - ASA1000			

ALL THE COMPONENTS LISTED IN OUR CATALOGUE ARE NOT ORIGINAL, THOUGH PERFECTLY INTERCHANGEABLE. REFERENCE NUMBERS, EITHER ORIGINAL OR OF A DIFFERENT NATURE, ARE FOR INFORMATION PURPOSES ONLY WHEN PLACING AN ORDER, PLEASE, ALWAYS USE COSIBO REFERENCE NUMBERS AND DO NOT MENTION THE ORIGINAL REFERENCE NUMBERS OF THE TRUCK MANUFACTURERS IN THE INVOICE TO VEHICLE OWNERS OR TO ANYBODY ELSE. THE CUSTOMER TAKES HIS OWN RESPONSIBILITY IF HE DOES NOT COMPLY WITH WHAT ABOVE.

RH MANUAL SLACK ADJUSTER



	Code	OEM new	OEM old
● Model	61257	1448114	278735
★ Application			
● 3 BUS			
★			
● 3 TRUCK			
★			
● 4 BUS			
★ ADA1300 R660/780 - AD1300 - ASA1300			
● 4 TRUCK			
★ AD/ADA1100 - AD/ADA1300 - AD/ADA1500 - AD/ADA1501 - ASA1000 - AS1300			
● F-K-N BUS			
★ ADA1300 4X2 6X2 6X2/4 - AD1300			
● P-G-R-T TRUCK			
★ ADA1100/1300 - AD1300 - AD/ADA1501P - ASA1000			

LH MANUAL SLACK ADJUSTER



	61260	218831	
● 3 BUS			
★			

RH MANUAL SLACK ADJUSTER



	61259	218832	
● 3 BUS			
★			

ALL THE COMPONENTS LISTED IN OUR CATALOGUE ARE NOT ORIGINAL, THOUGH PERFECTLY INTERCHANGEABLE. REFERENCE NUMBERS, EITHER ORIGINAL OR OF A DIFFERENT NATURE, ARE FOR INFORMATION PURPOSES ONLY WHEN PLACING AN ORDER, PLEASE, ALWAYS USE COSIBO REFERENCE NUMBERS AND DO NOT MENTION THE ORIGINAL REFERENCE NUMBERS OF THE TRUCK MANUFACTURERS IN THE INVOICE TO VEHICLE OWNERS OR TO ANYBODY ELSE. THE CUSTOMER TAKES HIS OWN RESPONSIBILITY IF HE DOES NOT COMPLY WITH WHAT ABOVE.

LH MANUAL SLACK ADJUSTER



- Model
- ★ Application

Code	OEM new	OEM old
61266	309421	

- 3 TRUCK
- ★ AS60 6X2 - ASA70 6X2
- 4 TRUCK
- ★ ASA70 6X2

RH MANUAL SLACK ADJUSTER



- 3 TRUCK
- ★ AS60 6X2 - ASA70 6X2
- 4 TRUCK
- ★ ASA70 6X2

61265	309422	
-------	--------	--

LH MANUAL SLACK ADJUSTER



- 3 BUS
- ★
- 3 TRUCK
- ★ AS90 6X2 8X2
- 4 TRUCK
- ★ AS900
- P-G-R-T TRUCK
- ★ AS900

63791	1865749	1448116 362044
-------	---------	-------------------

ALL THE COMPONENTS LISTED IN OUR CATALOGUE ARE NOT ORIGINAL, THOUGH PERFECTLY INTERCHANGEABLE. REFERENCE NUMBERS, EITHER ORIGINAL OR OF A DIFFERENT NATURE, ARE FOR INFORMATION PURPOSES ONLY WHEN PLACING AN ORDER, PLEASE, ALWAYS USE COSIBO REFERENCE NUMBERS AND DO NOT MENTION THE ORIGINAL REFERENCE NUMBERS OF THE TRUCK MANUFACTURERS IN THE INVOICE TO VEHICLE OWNERS OR TO ANYBODY ELSE. THE CUSTOMER TAKES HIS OWN RESPONSIBILITY IF HE DOES NOT COMPLY WITH WHAT ABOVE.

RH MANUAL SLACK ADJUSTER



	Code	OEM new	OEM old
● Model	63792	1448117	362045
★ Application			
● 3 TRUCK			
★ AS90 6X2 8X2			
● 4 TRUCK			
★ AS900			
● P-G-R-T TRUCK			
★ AS900			
● 3 BUS			
★			

MANUAL SLACK ADJUSTER



	61168	1448113	278734
● 3 BUS			
★			
● 3 TRUCK			
★ AD80 R641/653 RB652 - AD90 R770/780 RB652 6X4 8X4 - AD/ADA90 R642/660/770 - AD100 RP831 -			
● 4 BUS			
★			
● 4 TRUCK			
★ AD/ADA1100/1300/1500			

LH AUTOMATIC SLACK ADJUSTER



	63346	1112829	
● 3 BUS			
★			
● 3 TRUCK			
★ AM56/61/70 - AM56 HK/MK8X4 - AM61 EK/HK/MK8X4 - AM/AMA61			

ALL THE COMPONENTS LISTED IN OUR CATALOGUE ARE NOT ORIGINAL, THOUGH PERFECTLY INTERCHANGEABLE. REFERENCE NUMBERS, EITHER ORIGINAL OR OF A DIFFERENT NATURE, ARE FOR INFORMATION PURPOSES ONLY WHEN PLACING AN ORDER, PLEASE, ALWAYS USE COSIBO REFERENCE NUMBERS AND DO NOT MENTION THE ORIGINAL REFERENCE NUMBERS OF THE TRUCK MANUFACTURERS IN THE INVOICE TO VEHICLE OWNERS OR TO ANYBODY ELSE. THE CUSTOMER TAKES HIS OWN RESPONSIBILITY IF HE DOES NOT COMPLY WITH WHAT ABOVE.

RH AUTOMATIC SLACK ADJUSTER



	Code	OEM new	OEM old
● Model	63347	1112830	
★ Application			
● 3 BUS			
★			
● 3 TRUCK			
★	AM56/61/70 - AM56 HK/MK8X4 - AM61 EK/HK/MK8X4 - AM/AMA61		

AUTOMATIC SLACK ADJUSTER



	Code	OEM new	OEM old
	63348	1789560	1112831
● 3 BUS			
★			
● 3 TRUCK			
★	AD80 R641 RB652/653 6X4 - AD90 R770/780 RB652 6X4 8X4 - AD/ADA90 R642/660/770 - AD100 RP831		
● 4 TRUCK			
★	AD/ADA1100/1300/1500		

LH REAR AUTOMATIC SLACK ADJUSTER



	Code	OEM new	OEM old
	63349	1789561	1112833
● 3 BUS			
★			
● 3 TRUCK			
★	AD90 R770/780 - AD/ADA90 R642/660/770 - AD100 RP/RBP831 6X4 8X4 - AD80 RB652 MK 8X4 - AD80 RB653 MK 6X4/8X4 - AD100 RP831 EL6X4/8X4 - ASA80 MV6X2LB ML6X2A/B MA6X2A		
● 4 BUS			
★	ADA1300 R660/780 - AD1300 - ASA1300		
● 4 TRUCK			
★	AD/ADA1100/1300/1500 - AD/ADA1500P RP832 6X4 6X6 8X4 8X8 - ASA80 6X2 - AD/ADA1500/1501P 6X4 6X6 8X4 - AD/ADA1300 R660 6X4/8X4 RB660 - ASA1000 6X2 8X2 8X2/4 - AS1300 - AD/ADA1501P RP/RBP832/835 4X4 6X6		
● F-K-N BUS			
★	ADA1300 4X2 6X2 6X2/4 - F AD1300		
● P-G-R-T TRUCK			
★	6X4 8X4 8X4/4 - 6X6 AD FR - 4X4 6X6 AM RE - ADA1100/1300 - AD1300 - ADA1501P - ASA1000		

ALL THE COMPONENTS LISTED IN OUR CATALOGUE ARE NOT ORIGINAL, THOUGH PERFECTLY INTERCHANGEABLE. REFERENCE NUMBERS, EITHER ORIGINAL OR OF A DIFFERENT NATURE, ARE FOR INFORMATION PURPOSES ONLY WHEN PLACING AN ORDER, PLEASE, ALWAYS USE COSIBO REFERENCE NUMBERS AND DO NOT MENTION THE ORIGINAL REFERENCE NUMBERS OF THE TRUCK MANUFACTURERS IN THE INVOICE TO VEHICLE OWNERS OR TO ANYBODY ELSE. THE CUSTOMER TAKES HIS OWN RESPONSIBILITY IF HE DOES NOT COMPLY WITH WHAT ABOVE.

RH REAR AUTOMATIC SLACK ADJUSTER



	Code	OEM new	OEM old
● Model	63350	1789562	1112834
★ Application			
● 3 BUS			
★			
● 3 TRUCK			
★	AD90 R770/780 - AD/ADA90 R642/660/770 - AD100 RP/RBP831 6X4 8X4 - AD80 RB652 MK 8X4 - AD80 RB653 MK 6X4/8X4 - AD100 RP831 EL6X4/8X4 - ASA80 MV6X2LB ML6X2A/B MA6X2A		
● 4 BUS			
★	ADA1300 R660/780 - AD1300 - ASA1300		
● 4 TRUCK			
★	AD/ADA1100/1300/1500 - AD/ADA1500P RP832 6X4 6X6 8X4 8X8 - ASA80 6X2 - AD/ADA1500/1501P 6X4 6X6 8X4 - AD/ADA1300 R660 6X4/8X4 RB660 - ASA1000 6X2 8X2 8X2/4 - AS1300 - AD/ADA1501P RP/RBP832/835 4X4 6X6		
● F-K-N BUS			
★	ADA1300 4X2 6X2 6X2/4 - F AD1300		
● P-G-R-T TRUCK			
★	6X4 8X4 8X4/4 - 6X6 AD FR - 4X4 6X6 AM RE - ADA1100/1300 - AD1300 - ADA1501P - ASA1000		

LH FRONT AUTOMATIC SLACK ADJUSTER



	Code	OEM new	OEM old
	63894	1789567	1358634
● 3 TRUCK			
★	AM800/820		
● 4 BUS			
★	AMA780/860 - K124 8X2 AMA60X2 - AM860/920 - ASA701		
● 4 TRUCK			
★	AM/AMA740/760/780 - AMA860 - AM620/621/900/920 - AMFR - AMRE AM/AMA 8X2 8X4 - ASA700 - ARA900		
● F-K-N BUS			
★	AM920 - ASA701 - AMA780/860 6X2/4 - ARA860 6X2/4		
● P-G-R-T TRUCK			
★	AM621 - ARA760/820/900 - ASA700		

ALL THE COMPONENTS LISTED IN OUR CATALOGUE ARE NOT ORIGINAL, THOUGH PERFECTLY INTERCHANGEABLE. REFERENCE NUMBERS, EITHER ORIGINAL OR OF A DIFFERENT NATURE, ARE FOR INFORMATION PURPOSES ONLY WHEN PLACING AN ORDER, PLEASE, ALWAYS USE COSIBO REFERENCE NUMBERS AND DO NOT MENTION THE ORIGINAL REFERENCE NUMBERS OF THE TRUCK MANUFACTURERS IN THE INVOICE TO VEHICLE OWNERS OR TO ANYBODY ELSE. THE CUSTOMER TAKES HIS OWN RESPONSIBILITY IF HE DOES NOT COMPLY WITH WHAT ABOVE.

RH FRONT AUTOMATIC SLACK ADJUSTER



	Code	OEM new	OEM old
● Model	63893	1789568	1358635
★ Application			
● 4 BUS			
★	AMA780/860 - K124 8X2 AMA60X2 - AM860/920 - ASA701		
● F-K-N BUS			
★	AM920 - ASA701 - AMA780/860 6X2/4 - ARA860 6X2/4		
● 3 TRUCK			
★	AM800/820		
● 4 TRUCK			
★	AM/AMA740/760/780 - AMA860 - AM620/621/900/920 - AMFR - AMRE AM/AMA 8X2 8X4 - ASA700 - ARA900		
● P-G-R-T TRUCK			
★	AM621 - ARA760/820/900 - ASA700		

AUTOMATIC SLACK ADJUSTER REPAIR SET



	61879	1350817	324728
● 3 BUS			
★			
● 3 TRUCK			
★			
● 4 BUS			
★			
● 4 TRUCK			
★			
● F-K-N BUS			
★			
● P-G-R-T TRUCK			
★			

ALL THE COMPONENTS LISTED IN OUR CATALOGUE ARE NOT ORIGINAL, THOUGH PERFECTLY INTERCHANGEABLE. REFERENCE NUMBERS, EITHER ORIGINAL OR OF A DIFFERENT NATURE, ARE FOR INFORMATION PURPOSES ONLY WHEN PLACING AN ORDER, PLEASE, ALWAYS USE COSIBO REFERENCE NUMBERS AND DO NOT MENTION THE ORIGINAL REFERENCE NUMBERS OF THE TRUCK MANUFACTURERS IN THE INVOICE TO VEHICLE OWNERS OR TO ANYBODY ELSE. THE CUSTOMER TAKES HIS OWN RESPONSIBILITY IF HE DOES NOT COMPLY WITH WHAT ABOVE.

		Code	OEM new	OEM old
BUSHING	● Model	61323	142575	
	★ Application			
	● 3 BUS			
	★			
	● 3 TRUCK			
	★			
● 4 TRUCK				
★				



		60957	1302857	141168 287620
BUSHING	● 3 BUS			
	★	K 113 CLP/TLP - AD/ADA90 - ATA90		
	● 3 TRUCK			
	★	AD80/85/90/100 - ADA90 - ASA80		
	● 4 BUS			
	★	AD/ADA1300 - ASA1300		
	● 4 TRUCK			
	★	ADA1100/1300/1500 - AD/ADA1500P - AD/ADA1501P - AD/ADA1300 - ASA1000 - AS1300 - AD1100P - AD1101P		
	● F-K-N BUS			
	★	AD/ADA1300		
	● P-G-R-T TRUCK			
	★	4X4 6X4 6X6 8X4 8X4/4 - ADA1100/1300 - AD1300 - AD/ADA1501P - ASA1000		



ALL THE COMPONENTS LISTED IN OUR CATALOGUE ARE NOT ORIGINAL, THOUGH PERFECTLY INTERCHANGEABLE. REFERENCE NUMBERS, EITHER ORIGINAL OR OF A DIFFERENT NATURE, ARE FOR INFORMATION PURPOSES ONLY WHEN PLACING AN ORDER, PLEASE, ALWAYS USE COSIBO REFERENCE NUMBERS AND DO NOT MENTION THE ORIGINAL REFERENCE NUMBERS OF THE TRUCK MANUFACTURERS IN THE INVOICE TO VEHICLE OWNERS OR TO ANYBODY ELSE. THE CUSTOMER TAKES HIS OWN RESPONSIBILITY IF HE DOES NOT COMPLY WITH WHAT ABOVE.

		Code	OEM new	OEM old
PIN 	● Model	61152	1362721	1342340
	★ Application			
	● 3 BUS			
	★	AM/AMA56/61 - AMI61 - AD/ADA90 - ATA90		
	● 3 TRUCK			
	★	AM800/820 - AD85		
	● 4 BUS			
	★	AM920 - AMA780/860 - K124 8X2 AMA60X2 - AM860 - AD/ADA1300 - ASA701 - ASA1300		
	● 4 TRUCK			
	★	AM620/621/900/920 - AM/AMA740/760/780 - AMA860 - AD/ADA1100/1300/1500 - ASA70/80 - AD/ADA1500P - AD/ADA1501P - AS/ASA700 - ARA900 - ASA1000 - ASA1300 - AD1100P - AD1101P		
	● F-K-N BUS			
	★	AM920 - AMA780/860 - ADA1300 - ASA701 - ARA860		
● P-G-R-T TRUCK				
★	4X4 6X4 6X6 8X4 8X4/4 - ADA1100/1300 - AD1300 - AD/ADA1501P - ARA760/820/900 - ASA700/1000 - AS900 - AM621			

		61153	1338019	381962
O-RING 	● 3 BUS			
	★	AM/AMA56/61 - AMI61 - AD/ADA90 - ATA90		
	● 3 TRUCK			
	★	AM800/820 - AD85		
	● 4 BUS			
	★	AM920 - AMA780/860 - K124 8X2 AMA60X2 - AM860 - AD/ADA1300 - ASA701 - ASA1300		
	● 4 TRUCK			
	★	AM620/621/900/920 - AM/AMA740/760/780 - AMA860 - AD/ADA1100/1300/1500 - ASA70/80 - AD/ADA1500P - AD/ADA1501P - AS/ASA700 - ARA900 - ASA1000 - ASA1300 - AD1100P - AD1101P		
	● F-K-N BUS			
	★	AM920 - AMA780/860 - ADA1300 - ASA701 - ARA860		
	● P-G-R-T TRUCK			
	★	4X4 6X4 6X6 8X4 8X4/4 - ADA1100/1300 - AD1300 - AD/ADA1501P - ARA760/820/900 - ASA700/1000 - AS900 - AM621		

ALL THE COMPONENTS LISTED IN OUR CATALOGUE ARE NOT ORIGINAL, THOUGH PERFECTLY INTERCHANGEABLE. REFERENCE NUMBERS, EITHER ORIGINAL OR OF A DIFFERENT NATURE, ARE FOR INFORMATION PURPOSES ONLY WHEN PLACING AN ORDER, PLEASE, ALWAYS USE COSIBO REFERENCE NUMBERS AND DO NOT MENTION THE ORIGINAL REFERENCE NUMBERS OF THE TRUCK MANUFACTURERS IN THE INVOICE TO VEHICLE OWNERS OR TO ANYBODY ELSE. THE CUSTOMER TAKES HIS OWN RESPONSIBILITY IF HE DOES NOT COMPLY WITH WHAT ABOVE.

O-RING DIAM.=59,5X3 mm



	Code	OEM new	OEM old
● Model	60636	332119	392663
★ Application			
● 3 BUS			
★ GR801R - GR801R			
● 3 TRUCK			
★ GRSH/R - GR/GRS900R			
● 4 BUS			
★ GR801R CN94 - GRS/GRSH/R			
● 4 TRUCK			
★ GR/GRS/GRSH/GRSO/R			
● F-K-N BUS			
★ GR801R/GR900R/GRS890R/GRS900R/GRS920R/GRSO900R			
● P-G-R-T TRUCK			
★ GRSH/R - GR801R/GR900R/GRS890R/GRS900R/GRS920R/GRSO900R			

RETARDER FLEXIBLE HOSE







	61608	1422701	
● 4 TRUCK			
★ GR/GRS/GRH/GRSO/R - GRS890R - GR/GRS900R			
● P-G-R-T TRUCK			
★			

RETARDER HOSE



	62518	1521553	1364902
● 3 BUS			
★ GR801R			
● 4 BUS			
★ GR801R CH 1843282 - CH 1843283 - CH 1838734 - CH 1838735 - CH 3523977 - CH 3523978			

ALL THE COMPONENTS LISTED IN OUR CATALOGUE ARE NOT ORIGINAL, THOUGH PERFECTLY INTERCHANGEABLE. REFERENCE NUMBERS, EITHER ORIGINAL OR OF A DIFFERENT NATURE, ARE FOR INFORMATION PURPOSES ONLY WHEN PLACING AN ORDER, PLEASE, ALWAYS USE COSIBO REFERENCE NUMBERS AND DO NOT MENTION THE ORIGINAL REFERENCE NUMBERS OF THE TRUCK MANUFACTURERS IN THE INVOICE TO VEHICLE OWNERS OR TO ANYBODY ELSE. THE CUSTOMER TAKES HIS OWN RESPONSIBILITY IF HE DOES NOT COMPLY WITH WHAT ABOVE.

	Code	OEM new	OEM old
<p>RETARDER FLEXIBLE HOSE</p> 	63764	1372154	1333735
<ul style="list-style-type: none"> ● Model ★ Application 			
<ul style="list-style-type: none"> ● 3 TRUCK ★ GR/GRS900R 			
<ul style="list-style-type: none"> ● 4 TRUCK ★ GRS890R - GR/GRS900R - GRSH900R - GR/GRS/GRSH/GRSO/R - 			
<p>RETARDER FLEXIBLE HOSE</p> 	63765	1372155	1341069
<ul style="list-style-type: none"> ● 3 TRUCK ★ GR/GRS900R 			
<ul style="list-style-type: none"> ● 4 TRUCK ★ GRS890R GR/GRS900R - GRSH900R 			
<p>RETARDER FLEXIBLE HOSE</p> 	64354	1452542	
<ul style="list-style-type: none"> ● P-G-R-T TRUCK ★ 			
<p>RETARDER FLEXIBLE HOSE</p> 	65026	1380880	
<ul style="list-style-type: none"> ● 4 TRUCK ★ GRS890R GR/GRS900R - GRSH900R - 4X4 6X6 - GR/GRS/GRSH/GRSO/R 			
<ul style="list-style-type: none"> ● P-G-R-T TRUCK ★ 			
<p>OIL COOLER FLEXIBLE HOSE</p> 	65328	1521554	1360368
<ul style="list-style-type: none"> ● 3 BUS ★ GR801R 			
<ul style="list-style-type: none"> ● 4 BUS ★ GR801R 			

ALL THE COMPONENTS LISTED IN OUR CATALOGUE ARE NOT ORIGINAL, THOUGH PERFECTLY INTERCHANGEABLE. REFERENCE NUMBERS, EITHER ORIGINAL OR OF A DIFFERENT NATURE, ARE FOR INFORMATION PURPOSES ONLY WHEN PLACING AN ORDER, PLEASE, ALWAYS USE COSIBO REFERENCE NUMBERS AND DO NOT MENTION THE ORIGINAL REFERENCE NUMBERS OF THE TRUCK MANUFACTURERS IN THE INVOICE TO VEHICLE OWNERS OR TO ANYBODY ELSE. THE CUSTOMER TAKES HIS OWN RESPONSIBILITY IF HE DOES NOT COMPLY WITH WHAT ABOVE.

		Code	OEM new	OEM old
PIN	● Model	60536	154262	
	★ Application			
	● 3 BUS			
	★			
	● 3 TRUCK			
	★ AMD105			
	● 4 BUS			
	★			
	● 4 TRUCK			
	★ AM/AMA/AMD - AS/ASA/ARA - AD/ADA			
● F-K-N BUS				
★				
● P-G-R-T TRUCK				
★				



		60540	141163	
BUSHING	● 3 BUS			
	★			
	● 3 TRUCK			
	★ AMD105			
	● 4 BUS			
	★			
	● 4 TRUCK			
	★ AM/AMA/AMD - AS/ASA/ARA - AD/ADA			
	● F-K-N BUS			
	★			
● P-G-R-T TRUCK				
★				



ALL THE COMPONENTS LISTED IN OUR CATALOGUE ARE NOT ORIGINAL, THOUGH PERFECTLY INTERCHANGEABLE. REFERENCE NUMBERS, EITHER ORIGINAL OR OF A DIFFERENT NATURE, ARE FOR INFORMATION PURPOSES ONLY WHEN PLACING AN ORDER, PLEASE, ALWAYS USE COSIBO REFERENCE NUMBERS AND DO NOT MENTION THE ORIGINAL REFERENCE NUMBERS OF THE TRUCK MANUFACTURERS IN THE INVOICE TO VEHICLE OWNERS OR TO ANYBODY ELSE. THE CUSTOMER TAKES HIS OWN RESPONSIBILITY IF HE DOES NOT COMPLY WITH WHAT ABOVE.

	Code	OEM new	OEM old
ROLLER	60955	154259	
● Model			
★ Application			
● 3 BUS			
★			
● 3 TRUCK			
★ AMD105			
● 4 BUS			
★			
● 4 TRUCK			
★ AM/AMA/AMD - AS/ASA/ARA - AD/ADA			
● F-K-N BUS			
★			
● P-G-R-T TRUCK			
★			



	60535	154261	
BUSHING			
● 3 BUS			
★			
● 3 TRUCK			
★ AMD105			
● 4 BUS			
★			
● 4 TRUCK			
★ AM/AMA/AMD - AS/ASA/ARA - AD/ADA			
● F-K-N BUS			
★			
● P-G-R-T TRUCK			
★			



ALL THE COMPONENTS LISTED IN OUR CATALOGUE ARE NOT ORIGINAL, THOUGH PERFECTLY INTERCHANGEABLE. REFERENCE NUMBERS, EITHER ORIGINAL OR OF A DIFFERENT NATURE, ARE FOR INFORMATION PURPOSES ONLY WHEN PLACING AN ORDER, PLEASE, ALWAYS USE COSIBO REFERENCE NUMBERS AND DO NOT MENTION THE ORIGINAL REFERENCE NUMBERS OF THE TRUCK MANUFACTURERS IN THE INVOICE TO VEHICLE OWNERS OR TO ANYBODY ELSE. THE CUSTOMER TAKES HIS OWN RESPONSIBILITY IF HE DOES NOT COMPLY WITH WHAT ABOVE.

		Code	OEM new	OEM old
O-RING	● Model	65226	1338018	1307340
	★ Application			
	● 3 BUS			
	★			
	● 3 TRUCK			
	★ AMD105			
	● 4 BUS			
	★			
	● 4 TRUCK			
	★ AM/AMA/AMD - AS/ASA/ARA - AD/ADA			
● F-K-N BUS				
★				
● P-G-R-T TRUCK				
★				



SPRING		61519	1309465	1100816 1305055
	● 3 BUS			
	★			
	● 3 TRUCK			
	★ AMD105			
	● 4 BUS			
	★			
	● 4 TRUCK			
	★ AM/AMA/AMD - AS/ASA/ARA - AD/ADA			
	● F-K-N BUS			
★				
● P-G-R-T TRUCK				
★				



ALL THE COMPONENTS LISTED IN OUR CATALOGUE ARE NOT ORIGINAL, THOUGH PERFECTLY INTERCHANGEABLE. REFERENCE NUMBERS, EITHER ORIGINAL OR OF A DIFFERENT NATURE, ARE FOR INFORMATION PURPOSES ONLY WHEN PLACING AN ORDER, PLEASE, ALWAYS USE COSIBO REFERENCE NUMBERS AND DO NOT MENTION THE ORIGINAL REFERENCE NUMBERS OF THE TRUCK MANUFACTURERS IN THE INVOICE TO VEHICLE OWNERS OR TO ANYBODY ELSE. THE CUSTOMER TAKES HIS OWN RESPONSIBILITY IF HE DOES NOT COMPLY WITH WHAT ABOVE.

	Code	OEM new	OEM old
BUSHING 	60539	141164	
<ul style="list-style-type: none"> ● Model ★ Application 			
<ul style="list-style-type: none"> ● 3 BUS ★ 			
<ul style="list-style-type: none"> ● 3 TRUCK ★ AMD105 - AS60/90 - ASA70 - ARA56/61 			
SPRING 	66520	120824	
<ul style="list-style-type: none"> ● 3 BUS ★ 			
<ul style="list-style-type: none"> ● 3 TRUCK ★ AMD105 - AS60/90 - ASA70 - ARA56/61 			
O-RING 	60538	182930	
<ul style="list-style-type: none"> ● 3 TRUCK ★ AMD105 - AD90 R770/780 - AD/ADA90 R642/660/770 - AD100 RP831 			
SNAP RING 	60543	804782	
<ul style="list-style-type: none"> ● 3 BUS ★ 			
<ul style="list-style-type: none"> ● 3 TRUCK ★ AM56/61/70 - AD80/85/90/100 			
<ul style="list-style-type: none"> ● 4 BUS ★ AM920 - AMA780/860 - K 124 8X2 AMA60X2 - AM860 - AD/ADA1300 			
<ul style="list-style-type: none"> ● 4 TRUCK ★ AM/AMA740/760/780 - AMA860 - AD/ADA1100/1300/1500 			
<ul style="list-style-type: none"> ● F-K-N BUS ★ AM920 - AD/ADA1300 - AMA780/860 - ASA701 - ARA860 			
<ul style="list-style-type: none"> ● P-G-R-T TRUCK ★ ADA1100/1300 - AMD900 - AD1300 - AD/ADA1501P - ARA760/820/900 - ASA700/1000 - AS900 			

ALL THE COMPONENTS LISTED IN OUR CATALOGUE ARE NOT ORIGINAL, THOUGH PERFECTLY INTERCHANGEABLE. REFERENCE NUMBERS, EITHER ORIGINAL OR OF A DIFFERENT NATURE, ARE FOR INFORMATION PURPOSES ONLY WHEN PLACING AN ORDER, PLEASE, ALWAYS USE COSIBO REFERENCE NUMBERS AND DO NOT MENTION THE ORIGINAL REFERENCE NUMBERS OF THE TRUCK MANUFACTURERS IN THE INVOICE TO VEHICLE OWNERS OR TO ANYBODY ELSE. THE CUSTOMER TAKES HIS OWN RESPONSIBILITY IF HE DOES NOT COMPLY WITH WHAT ABOVE.

	Code	OEM new	OEM old
SEAL RING 38x50x7	60546	123102	
<ul style="list-style-type: none"> ● Model ★ Application 			
<ul style="list-style-type: none"> ● 3 BUS ★ 			
<ul style="list-style-type: none"> ● 3 TRUCK ★ AMD105 - AM56/70 - AM/AMA61 - AS60/90 - ASA70 - ARA56/61 			





PIN	60549	180064	
<ul style="list-style-type: none"> ● 3 BUS ★ 			
<ul style="list-style-type: none"> ● 3 TRUCK ★ AMD105 - AM56/70 - AM/AMA61 - AS60/90 - ASA70 - ARA56/61 			





REPAIR SET	63336	63336	
<ul style="list-style-type: none"> ● 3 BUS ★ 			
<ul style="list-style-type: none"> ● 3 TRUCK ★ AMD105 			
<ul style="list-style-type: none"> ● 4 BUS ★ 			
<ul style="list-style-type: none"> ● 4 TRUCK ★ AM/AMA/AMD - AS/ASA/ARA - AD/ADA 			
<ul style="list-style-type: none"> ● F-K-N BUS ★ 			
<ul style="list-style-type: none"> ● P-G-R-T TRUCK ★ 			



ALL THE COMPONENTS LISTED IN OUR CATALOGUE ARE NOT ORIGINAL, THOUGH PERFECTLY INTERCHANGEABLE. REFERENCE NUMBERS, EITHER ORIGINAL OR OF A DIFFERENT NATURE, ARE FOR INFORMATION PURPOSES ONLY WHEN PLACING AN ORDER, PLEASE, ALWAYS USE COSIBO REFERENCE NUMBERS AND DO NOT MENTION THE ORIGINAL REFERENCE NUMBERS OF THE TRUCK MANUFACTURERS IN THE INVOICE TO VEHICLE OWNERS OR TO ANYBODY ELSE. THE CUSTOMER TAKES HIS OWN RESPONSIBILITY IF HE DOES NOT COMPLY WITH WHAT ABOVE.

	Code	OEM new	OEM old
<p>CLAMP D.10</p> 	64083	813935	
<ul style="list-style-type: none"> ● Model ★ Application 			
<ul style="list-style-type: none"> ● 3 BUS ★ 			
<hr/>			
<p>CLAMP D. 16</p> 	64084	813937	
<ul style="list-style-type: none"> ● 3 BUS ★ ● 4 BUS ★ ● F-K-N BUS ★ ● IND. MARINE ENGINE 4 ★ ● 3 TRUCK ★ ● 4 TRUCK ★ 			
<hr/>			
<p>CLAMP D.20</p> 	64085	813939	
<ul style="list-style-type: none"> ● 3 BUS ★ ● 4 BUS ★ ● 3 TRUCK ★ ● 4 TRUCK ★ 			

ALL THE COMPONENTS LISTED IN OUR CATALOGUE ARE NOT ORIGINAL, THOUGH PERFECTLY INTERCHANGEABLE. REFERENCE NUMBERS, EITHER ORIGINAL OR OF A DIFFERENT NATURE, ARE FOR INFORMATION PURPOSES ONLY WHEN PLACING AN ORDER, PLEASE, ALWAYS USE COSIBO REFERENCE NUMBERS AND DO NOT MENTION THE ORIGINAL REFERENCE NUMBERS OF THE TRUCK MANUFACTURERS IN THE INVOICE TO VEHICLE OWNERS OR TO ANYBODY ELSE. THE CUSTOMER TAKES HIS OWN RESPONSIBILITY IF HE DOES NOT COMPLY WITH WHAT ABOVE.

	Code	OEM new	OEM old
<p>CLAMP D.25</p> 	64086	813941	
<ul style="list-style-type: none"> ● Model ★ Application 			
<ul style="list-style-type: none"> ● 3 BUS ★ 			
<p>CLAMP D.5</p> 	64089	813932	
<ul style="list-style-type: none"> ● 3 BUS ★ 			
<p>CLAMP D.8</p> 	64090	813934	
<ul style="list-style-type: none"> ● 3 BUS ★ ● F-K-N BUS ★ ● 3 TRUCK ★ ● P-G-R-T TRUCK ★ 			

ALL THE COMPONENTS LISTED IN OUR CATALOGUE ARE NOT ORIGINAL, THOUGH PERFECTLY INTERCHANGEABLE. REFERENCE NUMBERS, EITHER ORIGINAL OR OF A DIFFERENT NATURE, ARE FOR INFORMATION PURPOSES ONLY WHEN PLACING AN ORDER, PLEASE, ALWAYS USE COSIBO REFERENCE NUMBERS AND DO NOT MENTION THE ORIGINAL REFERENCE NUMBERS OF THE TRUCK MANUFACTURERS IN THE INVOICE TO VEHICLE OWNERS OR TO ANYBODY ELSE. THE CUSTOMER TAKES HIS OWN RESPONSIBILITY IF HE DOES NOT COMPLY WITH WHAT ABOVE.

	Code	OEM new	OEM old
CLAMP D.13	64091	813936	
<ul style="list-style-type: none"> ● Model ★ Application 			
<ul style="list-style-type: none"> ● 3 BUS ★ 			
<ul style="list-style-type: none"> ● 4 BUS ★ 			
<ul style="list-style-type: none"> ● F-K-N BUS ★ 			
<ul style="list-style-type: none"> ● IND. MARINE ENGINE 4 ★ 			
<ul style="list-style-type: none"> ● 3 TRUCK ★ 			





CLAMP D.18	64092	813938	
<ul style="list-style-type: none"> ● 3 BUS ★ 			
<ul style="list-style-type: none"> ● 4 BUS ★ 			
<ul style="list-style-type: none"> ● 3 TRUCK ★ 			
<ul style="list-style-type: none"> ● 4 TRUCK ★ 			



CLAMP D.22	64093	813940	
<ul style="list-style-type: none"> ● 3 BUS ★ 			
<ul style="list-style-type: none"> ● 4 BUS ★ 			
<ul style="list-style-type: none"> ● 3 TRUCK ★ 			
<ul style="list-style-type: none"> ● 4 TRUCK ★ 			



ALL THE COMPONENTS LISTED IN OUR CATALOGUE ARE NOT ORIGINAL, THOUGH PERFECTLY INTERCHANGEABLE. REFERENCE NUMBERS, EITHER ORIGINAL OR OF A DIFFERENT NATURE, ARE FOR INFORMATION PURPOSES ONLY WHEN PLACING AN ORDER, PLEASE, ALWAYS USE COSIBO REFERENCE NUMBERS AND DO NOT MENTION THE ORIGINAL REFERENCE NUMBERS OF THE TRUCK MANUFACTURERS IN THE INVOICE TO VEHICLE OWNERS OR TO ANYBODY ELSE. THE CUSTOMER TAKES HIS OWN RESPONSIBILITY IF HE DOES NOT COMPLY WITH WHAT ABOVE.

	Code	OEM new	OEM old
<p>CLAMP D.35</p> 	64096	804589	
<ul style="list-style-type: none"> ● Model ★ Application 			
<ul style="list-style-type: none"> ● 3 BUS ★ 			
<ul style="list-style-type: none"> ● 3 TRUCK ★ 			
<p>CLAMP D.32</p> 	64100	804583	
<ul style="list-style-type: none"> ● 3 TRUCK ★ 			
<p>CLAMP D.38</p> 	64101	804591	
<ul style="list-style-type: none"> ● F-K-N BUS ★ 			
<ul style="list-style-type: none"> ● 3 TRUCK ★ 			

ALL THE COMPONENTS LISTED IN OUR CATALOGUE ARE NOT ORIGINAL, THOUGH PERFECTLY INTERCHANGEABLE. REFERENCE NUMBERS, EITHER ORIGINAL OR OF A DIFFERENT NATURE, ARE FOR INFORMATION PURPOSES ONLY WHEN PLACING AN ORDER, PLEASE, ALWAYS USE COSIBO REFERENCE NUMBERS AND DO NOT MENTION THE ORIGINAL REFERENCE NUMBERS OF THE TRUCK MANUFACTURERS IN THE INVOICE TO VEHICLE OWNERS OR TO ANYBODY ELSE. THE CUSTOMER TAKES HIS OWN RESPONSIBILITY IF HE DOES NOT COMPLY WITH WHAT ABOVE.

CLAMP D.6



● Model
★ Application

Code

OEM new

OEM old

64082

813933

● 3 BUS

★

● 4 BUS

★

● 4 TRUCK

★

ALL THE COMPONENTS LISTED IN OUR CATALOGUE ARE NOT ORIGINAL, THOUGH PERFECTLY INTERCHANGEABLE. REFERENCE NUMBERS, EITHER ORIGINAL OR OF A DIFFERENT NATURE, ARE FOR INFORMATION PURPOSES ONLY WHEN PLACING AN ORDER, PLEASE, ALWAYS USE COSIBO REFERENCE NUMBERS AND DO NOT MENTION THE ORIGINAL REFERENCE NUMBERS OF THE TRUCK MANUFACTURERS IN THE INVOICE TO VEHICLE OWNERS OR TO ANYBODY ELSE. THE CUSTOMER TAKES HIS OWN RESPONSIBILITY IF HE DOES NOT COMPLY WITH WHAT ABOVE.

WIDE ANGLE MIRROR WITH BRACKET



- Model
- ★ Application

Code

OEM new

OEM old

62136

316920

- 3 TRUCK

★

- 4 TRUCK

★

MIRROR GLASS



62133

316918

- 3 TRUCK

★

- 4 TRUCK

★

UNHEATED COMPLETE MIRROR



61657

1106953

396851

- 3 TRUCK

★

- 4 TRUCK

★

ALL THE COMPONENTS LISTED IN OUR CATALOGUE ARE NOT ORIGINAL, THOUGH PERFECTLY INTERCHANGEABLE. REFERENCE NUMBERS, EITHER ORIGINAL OR OF A DIFFERENT NATURE, ARE FOR INFORMATION PURPOSES ONLY WHEN PLACING AN ORDER, PLEASE, ALWAYS USE COSIBO REFERENCE NUMBERS AND DO NOT MENTION THE ORIGINAL REFERENCE NUMBERS OF THE TRUCK MANUFACTURERS IN THE INVOICE TO VEHICLE OWNERS OR TO ANYBODY ELSE. THE CUSTOMER TAKES HIS OWN RESPONSIBILITY IF HE DOES NOT COMPLY WITH WHAT ABOVE.

HEATED MIRROR COMPLETE



	Code	OEM new	OEM old
● Model	61658	1106955	396853
★ Application			
● 3 TRUCK			
★			

UNHEATED MIRROR GLASS



	61659	296538	
● 3 TRUCK			
★			

HEATED MIRROR GLASS



	61660	296538/A	
● 3 TRUCK			
★			

ALL THE COMPONENTS LISTED IN OUR CATALOGUE ARE NOT ORIGINAL, THOUGH PERFECTLY INTERCHANGEABLE. REFERENCE NUMBERS, EITHER ORIGINAL OR OF A DIFFERENT NATURE, ARE FOR INFORMATION PURPOSES ONLY WHEN PLACING AN ORDER, PLEASE, ALWAYS USE COSIBO REFERENCE NUMBERS AND DO NOT MENTION THE ORIGINAL REFERENCE NUMBERS OF THE TRUCK MANUFACTURERS IN THE INVOICE TO VEHICLE OWNERS OR TO ANYBODY ELSE. THE CUSTOMER TAKES HIS OWN RESPONSIBILITY IF HE DOES NOT COMPLY WITH WHAT ABOVE.

MIRROR HEATING ELEMENT

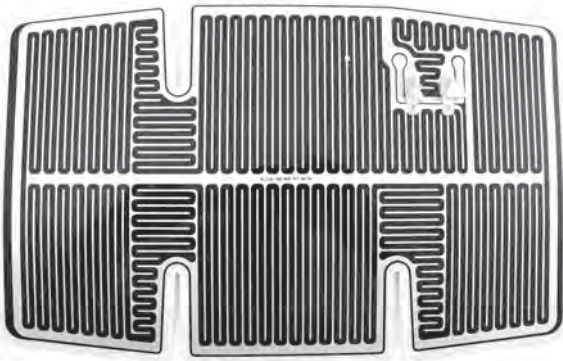

- Model
- ★ Application

Code	OEM new	OEM old
62067	376243	

- 3 TRUCK

- ★

MIRROR GLASS



- 4 TRUCK

- ★

- P-G-R-T TRUCK

- ★

63712	1442706	1346377
-------	---------	---------

MIRROR BRACKET



- 3 TRUCK

- ★

61706	316640	
-------	--------	--

ALL THE COMPONENTS LISTED IN OUR CATALOGUE ARE NOT ORIGINAL, THOUGH PERFECTLY INTERCHANGEABLE. REFERENCE NUMBERS, EITHER ORIGINAL OR OF A DIFFERENT NATURE, ARE FOR INFORMATION PURPOSES ONLY WHEN PLACING AN ORDER, PLEASE, ALWAYS USE COSIBO REFERENCE NUMBERS AND DO NOT MENTION THE ORIGINAL REFERENCE NUMBERS OF THE TRUCK MANUFACTURERS IN THE INVOICE TO VEHICLE OWNERS OR TO ANYBODY ELSE. THE CUSTOMER TAKES HIS OWN RESPONSIBILITY IF HE DOES NOT COMPLY WITH WHAT ABOVE.

HEATED MIRROR GLASS



	Code	OEM new	OEM old
● Model	63369	1732776	1442705
★ Application			
● P-G-R-T TRUCK			
★			
● 4 TRUCK			
★ CP/CR 94 - 114 - 124 - 144 - 164			

HEATED WIDE ANGLE MIRROR GLASS



	63370	1732778	1346579
● P-G-R-T TRUCK			
★			
● 4 TRUCK			
★ CP/CR 94 - 114 - 124 - 144 - 164			

LH MIRROR BRACKET



	62399	1396529	
● P-G-R-T TRUCK			
★			
● 4 TRUCK			
★ CP/CR 94 - 114 - 124 - 144 - 164			

ALL THE COMPONENTS LISTED IN OUR CATALOGUE ARE NOT ORIGINAL, THOUGH PERFECTLY INTERCHANGEABLE. REFERENCE NUMBERS, EITHER ORIGINAL OR OF A DIFFERENT NATURE, ARE FOR INFORMATION PURPOSES ONLY WHEN PLACING AN ORDER, PLEASE, ALWAYS USE COSIBO REFERENCE NUMBERS AND DO NOT MENTION THE ORIGINAL REFERENCE NUMBERS OF THE TRUCK MANUFACTURERS IN THE INVOICE TO VEHICLE OWNERS OR TO ANYBODY ELSE. THE CUSTOMER TAKES HIS OWN RESPONSIBILITY IF HE DOES NOT COMPLY WITH WHAT ABOVE.

RH MIRROR BRACKET



● Model

★ Application

Code

OEM new

OEM old

62400

1396530

● P-G-R-T TRUCK

★

● 4 TRUCK

★ CP/CR 94 - 114 - 124 - 144 - 164

LH ELECTRICAL HEATED TWIN MIRROR



64245

1723518+
1732782

● 4 TRUCK

★ CP/CR/CT FOR CH 2600 mm

ALL THE COMPONENTS LISTED IN OUR CATALOGUE ARE NOT ORIGINAL, THOUGH PERFECTLY INTERCHANGEABLE. REFERENCE NUMBERS, EITHER ORIGINAL OR OF A DIFFERENT NATURE, ARE FOR INFORMATION PURPOSES ONLY WHEN PLACING AN ORDER, PLEASE, ALWAYS USE COSIBO REFERENCE NUMBERS AND DO NOT MENTION THE ORIGINAL REFERENCE NUMBERS OF THE TRUCK MANUFACTURERS IN THE INVOICE TO VEHICLE OWNERS OR TO ANYBODY ELSE. THE CUSTOMER TAKES HIS OWN RESPONSIBILITY IF HE DOES NOT COMPLY WITH WHAT ABOVE.

RH ELECTRICAL HEATED TWIN MIRROR



- Model
- ★ Application

Code

OEM new

OEM old

64169

1723519

- 4 TRUCK

- ★ CP/CR/CT FOR CH 2600 mm

LH ELECTRICAL HEATED TWIN MIRROR



- 4 TRUCK

- ★ CP/CR/CT FOR CH 2600 mm

64245

1723518+
1732782

ALL THE COMPONENTS LISTED IN OUR CATALOGUE ARE NOT ORIGINAL, THOUGH PERFECTLY INTERCHANGEABLE. REFERENCE NUMBERS, EITHER ORIGINAL OR OF A DIFFERENT NATURE, ARE FOR INFORMATION PURPOSES ONLY WHEN PLACING AN ORDER, PLEASE, ALWAYS USE COSIBO REFERENCE NUMBERS AND DO NOT MENTION THE ORIGINAL REFERENCE NUMBERS OF THE TRUCK MANUFACTURERS IN THE INVOICE TO VEHICLE OWNERS OR TO ANYBODY ELSE. THE CUSTOMER TAKES HIS OWN RESPONSIBILITY IF HE DOES NOT COMPLY WITH WHAT ABOVE.

LH ELECTRICAL HEATED SINGLE MIRROR



- Model
 - ★ Application
- | | Code | OEM new | OEM old |
|--|--------------|---------|---------|
| | 64170 | 1723518 | |
- 4 TRUCK
 - ★ CP/CR/CT FOR CH 2600 mm

LH ELECTRICAL HEATED TWIN MIRROR



- | | | | |
|--|--------------|-------|--|
| | 65324 | 65324 | |
|--|--------------|-------|--|
- 4 TRUCK
 - ★ CP/CR 94 - 114 - 124 - 144 - 164 FOR CH 2500/2550 mm
 - P-G-R-T TRUCK
 - ★ FOR CH 2500/2550 mm

ALL THE COMPONENTS LISTED IN OUR CATALOGUE ARE NOT ORIGINAL, THOUGH PERFECTLY INTERCHANGEABLE. REFERENCE NUMBERS, EITHER ORIGINAL OR OF A DIFFERENT NATURE, ARE FOR INFORMATION PURPOSES ONLY WHEN PLACING AN ORDER, PLEASE, ALWAYS USE COSIBO REFERENCE NUMBERS AND DO NOT MENTION THE ORIGINAL REFERENCE NUMBERS OF THE TRUCK MANUFACTURERS IN THE INVOICE TO VEHICLE OWNERS OR TO ANYBODY ELSE. THE CUSTOMER TAKES HIS OWN RESPONSIBILITY IF HE DOES NOT COMPLY WITH WHAT ABOVE.

RH ELECTRICAL HEATED TWIN MIRROR



- Model
- ★ Application

Code

OEM new

OEM old

65321

65321

- 4 TRUCK

- ★ CP/CR 94 - 114 - 124 - 144 - 164 FOR CH 2500/2550 mm

- P-G-R-T TRUCK

- ★ FOR CH 2500/2550 mm

LH ELECTRICAL HEATED SINGLE MIRROR



65322

65322

- 4 TRUCK

- ★ CP/CR 94 - 114 - 124 - 144 - 164 FOR CH 2500/2550 mm

- P-G-R-T TRUCK

- ★ FOR CH 2500/2550 mm

ALL THE COMPONENTS LISTED IN OUR CATALOGUE ARE NOT ORIGINAL, THOUGH PERFECTLY INTERCHANGEABLE. REFERENCE NUMBERS, EITHER ORIGINAL OR OF A DIFFERENT NATURE, ARE FOR INFORMATION PURPOSES ONLY WHEN PLACING AN ORDER, PLEASE, ALWAYS USE COSIBO REFERENCE NUMBERS AND DO NOT MENTION THE ORIGINAL REFERENCE NUMBERS OF THE TRUCK MANUFACTURERS IN THE INVOICE TO VEHICLE OWNERS OR TO ANYBODY ELSE. THE CUSTOMER TAKES HIS OWN RESPONSIBILITY IF HE DOES NOT COMPLY WITH WHAT ABOVE.

RHD,RH ELECTRICAL HEATED MIRROR



	Code	OEM new	OEM old
● Model	65323	65323	
★ Application			
● 4 TRUCK			
★ CP/CR 94 - 114 - 124 - 144 - 164 FOR CH 2500/2550 mm			
● P-G-R-T TRUCK			
★ FOR CH 2500/2550 mm			

LH WIDE ANGLE MIRROR ASSY



	63797	1732782	1346381
● 4 TRUCK			
★ CP/CR 94 - 114 - 124 - 144 - 164			
● P-G-R-T TRUCK			
★			

ALL THE COMPONENTS LISTED IN OUR CATALOGUE ARE NOT ORIGINAL, THOUGH PERFECTLY INTERCHANGEABLE. REFERENCE NUMBERS, EITHER ORIGINAL OR OF A DIFFERENT NATURE, ARE FOR INFORMATION PURPOSES ONLY WHEN PLACING AN ORDER, PLEASE, ALWAYS USE COSIBO REFERENCE NUMBERS AND DO NOT MENTION THE ORIGINAL REFERENCE NUMBERS OF THE TRUCK MANUFACTURERS IN THE INVOICE TO VEHICLE OWNERS OR TO ANYBODY ELSE. THE CUSTOMER TAKES HIS OWN RESPONSIBILITY IF HE DOES NOT COMPLY WITH WHAT ABOVE.

RH WIDE ANGLE MIRROR ASSY



	Code	OEM new	OEM old
● Model	63860	1732783	1346382
★ Application			
● 4 TRUCK			
★ CP/CR 94 - 114 - 124 - 144 - 164			
● P-G-R-T TRUCK			
★			

LH MIRROR CAP



	63800	1366141	
● 4 TRUCK			
★ CP/CR 94 - 114 - 124 - 144 - 164			
● P-G-R-T TRUCK			
★			

ALL THE COMPONENTS LISTED IN OUR CATALOGUE ARE NOT ORIGINAL, THOUGH PERFECTLY INTERCHANGEABLE. REFERENCE NUMBERS, EITHER ORIGINAL OR OF A DIFFERENT NATURE, ARE FOR INFORMATION PURPOSES ONLY WHEN PLACING AN ORDER, PLEASE, ALWAYS USE COSIBO REFERENCE NUMBERS AND DO NOT MENTION THE ORIGINAL REFERENCE NUMBERS OF THE TRUCK MANUFACTURERS IN THE INVOICE TO VEHICLE OWNERS OR TO ANYBODY ELSE. THE CUSTOMER TAKES HIS OWN RESPONSIBILITY IF HE DOES NOT COMPLY WITH WHAT ABOVE.

RH MIRROR CAP



	Code	OEM new	OEM old
● Model	62379	1396542	
★ Application			
● 4 TRUCK			
★ CP/CR 94 - 114 - 124 - 144 - 164			
● P-G-R-T TRUCK			
★			

LH MIRROR CAP ORIGINAL (RHD)



	Code	OEM new	OEM old
	63801	1396541	
● 4 TRUCK			
★ CP/CR 94 - 114 - 124 - 144 - 164			
● P-G-R-T TRUCK			
★			

MIRROR REPAIR SET



	Code	OEM new	OEM old
	63739	581201	
● 4 TRUCK			
★			

ALL THE COMPONENTS LISTED IN OUR CATALOGUE ARE NOT ORIGINAL, THOUGH PERFECTLY INTERCHANGEABLE. REFERENCE NUMBERS, EITHER ORIGINAL OR OF A DIFFERENT NATURE, ARE FOR INFORMATION PURPOSES ONLY WHEN PLACING AN ORDER, PLEASE, ALWAYS USE COSIBO REFERENCE NUMBERS AND DO NOT MENTION THE ORIGINAL REFERENCE NUMBERS OF THE TRUCK MANUFACTURERS IN THE INVOICE TO VEHICLE OWNERS OR TO ANYBODY ELSE. THE CUSTOMER TAKES HIS OWN RESPONSIBILITY IF HE DOES NOT COMPLY WITH WHAT ABOVE.

	Code	OEM new	OEM old
MIRROR ASSY	64173	1916864	1484076
<ul style="list-style-type: none"> ● Model ★ Application 			
<ul style="list-style-type: none"> ● 4 TRUCK ★ 8X8 WLS/ZLS 			
<ul style="list-style-type: none"> ● P-G-R-T TRUCK ★ 8X8 WLS/ZLS 			



MIRROR BRACKET	64174	1484081	
<ul style="list-style-type: none"> ● P-G-R-T TRUCK ★ 			



MIRROR ASSY WITH BRACKET (FRONT VIEW)	64171	1484076+ 1484078	
<ul style="list-style-type: none"> ● 4 TRUCK ★ LOW/STD/HIGH CABIN 			
<ul style="list-style-type: none"> ● P-G-R-T TRUCK ★ LOW/STD/HIGH CABIN 			



ALL THE COMPONENTS LISTED IN OUR CATALOGUE ARE NOT ORIGINAL, THOUGH PERFECTLY INTERCHANGEABLE. REFERENCE NUMBERS, EITHER ORIGINAL OR OF A DIFFERENT NATURE, ARE FOR INFORMATION PURPOSES ONLY WHEN PLACING AN ORDER, PLEASE, ALWAYS USE COSIBO REFERENCE NUMBERS AND DO NOT MENTION THE ORIGINAL REFERENCE NUMBERS OF THE TRUCK MANUFACTURERS IN THE INVOICE TO VEHICLE OWNERS OR TO ANYBODY ELSE. THE CUSTOMER TAKES HIS OWN RESPONSIBILITY IF HE DOES NOT COMPLY WITH WHAT ABOVE.

MIRROR ASSY WITH BRACKET (FRONT VIEW)



- Model
- ★ Application

Code

OEM new

OEM old

641721484076+
1484079

- **4 TRUCK**
- ★ CABIN TOPLINE
- **P-G-R-T TRUCK**
- ★ CABIN TOPLINE

LH UPPER STEP COVER



- Model
- ★ Application

Code	OEM new	OEM old
62327	1390075	

- 4 TRUCK
- ★ CP/CR

RH UPPER STEP COVER



- 4 TRUCK
- ★ CP/CR

62339	1390074	
-------	---------	--

LH MIDDLE STEP COVER



- 4 TRUCK
- ★ CP/CR

62328	1354593	
-------	---------	--

RH MIDDLE STEP COVER



- 4 TRUCK
- ★ CP/CR

62338	1354594	
-------	---------	--

ALL THE COMPONENTS LISTED IN OUR CATALOGUE ARE NOT ORIGINAL, THOUGH PERFECTLY INTERCHANGEABLE. REFERENCE NUMBERS, EITHER ORIGINAL OR OF A DIFFERENT NATURE, ARE FOR INFORMATION PURPOSES ONLY WHEN PLACING AN ORDER, PLEASE, ALWAYS USE COSIBO REFERENCE NUMBERS AND DO NOT MENTION THE ORIGINAL REFERENCE NUMBERS OF THE TRUCK MANUFACTURERS IN THE INVOICE TO VEHICLE OWNERS OR TO ANYBODY ELSE. THE CUSTOMER TAKES HIS OWN RESPONSIBILITY IF HE DOES NOT COMPLY WITH WHAT ABOVE.

	Code	OEM new	OEM old
LH STEP COVER	64700	1512423	
<ul style="list-style-type: none"> ● Model ★ Application 			
<ul style="list-style-type: none"> ● P-G-R-T TRUCK ★ CP/CG/CR/CT 			



RH STEP COVER	64701	1512424	
<ul style="list-style-type: none"> ● P-G-R-T TRUCK ★ CP/CG/CR 230V - CT 			



LH UPPER SPEP COVER	64702	1442653	
<ul style="list-style-type: none"> ● P-G-R-T TRUCK ★ CR/CT 			



RH UPPER SPEP COVER



- Model
 - ★ Application
-
- P-G-R-T TRUCK
 - ★ CR/CT

Code	OEM new	OEM old
64703	1442654	

LH LOWER STEP COVER



- P-G-R-T TRUCK
- ★ CP/CG/CR/CT

64708	1779120	1486647
-------	---------	---------

RH LOWER STEP COVER



- P-G-R-T TRUCK
- ★ CP/CG/CR/CT

64709	1779121	1486648
-------	---------	---------

ALL THE COMPONENTS LISTED IN OUR CATALOGUE ARE NOT ORIGINAL, THOUGH PERFECTLY INTERCHANGEABLE. REFERENCE NUMBERS, EITHER ORIGINAL OR OF A DIFFERENT NATURE, ARE FOR INFORMATION PURPOSES ONLY WHEN PLACING AN ORDER, PLEASE, ALWAYS USE COSIBO REFERENCE NUMBERS AND DO NOT MENTION THE ORIGINAL REFERENCE NUMBERS OF THE TRUCK MANUFACTURERS IN THE INVOICE TO VEHICLE OWNERS OR TO ANYBODY ELSE. THE CUSTOMER TAKES HIS OWN RESPONSIBILITY IF HE DOES NOT COMPLY WITH WHAT ABOVE.

SIDE MARKER LAMP ASSY



	Code	OEM new	OEM old
● Model	62524	1770301	1722531
★ Application			
● P-G-R-T TRUCK			
★ CT LH/RH - CP/CG/CR LH/RH			

LH STEP



	Code	OEM new	OEM old
	62335	361993	
● 3 TRUCK			
★			

RH STEP



	Code	OEM new	OEM old
	62340	361994	
● 3 TRUCK			
★			

ALL THE COMPONENTS LISTED IN OUR CATALOGUE ARE NOT ORIGINAL, THOUGH PERFECTLY INTERCHANGEABLE. REFERENCE NUMBERS, EITHER ORIGINAL OR OF A DIFFERENT NATURE, ARE FOR INFORMATION PURPOSES ONLY WHEN PLACING AN ORDER, PLEASE, ALWAYS USE COSIBO REFERENCE NUMBERS AND DO NOT MENTION THE ORIGINAL REFERENCE NUMBERS OF THE TRUCK MANUFACTURERS IN THE INVOICE TO VEHICLE OWNERS OR TO ANYBODY ELSE. THE CUSTOMER TAKES HIS OWN RESPONSIBILITY IF HE DOES NOT COMPLY WITH WHAT ABOVE.

LH FOOTSTEP PANEL



- Model
- ★ Application

Code

OEM new

OEM old

62414

1515195

1351193

- 4 TRUCK

- ★ CP/CR/CT

RH FOOTSTEP PANEL



- 4 TRUCK





- ★ CP/CR/CT

62415

1515194

1351194

ALL THE COMPONENTS LISTED IN OUR CATALOGUE ARE NOT ORIGINAL, THOUGH PERFECTLY INTERCHANGEABLE. REFERENCE NUMBERS, EITHER ORIGINAL OR OF A DIFFERENT NATURE, ARE FOR INFORMATION PURPOSES ONLY WHEN PLACING AN ORDER, PLEASE, ALWAYS USE COSIBO REFERENCE NUMBERS AND DO NOT MENTION THE ORIGINAL REFERENCE NUMBERS OF THE TRUCK MANUFACTURERS IN THE INVOICE TO VEHICLE OWNERS OR TO ANYBODY ELSE. THE CUSTOMER TAKES HIS OWN RESPONSIBILITY IF HE DOES NOT COMPLY WITH WHAT ABOVE.

	Code	OEM new	OEM old
LH UPPER STEP COVER	64344	1732322	1529885
			
● Model ★ Application			
● P-G-R-T TRUCK ★ CR			
RH UPPER STEP COVER	64345	1529886	
			
● P-G-R-T TRUCK ★ CR			
LOWER LH & RH STEP	68888	1535049	1390076
			
● 4 TRUCK ★ CP/CR			
FOOT STEP LIGHT	61604	369375	
			
● 3 TRUCK ★			

ALL THE COMPONENTS LISTED IN OUR CATALOGUE ARE NOT ORIGINAL, THOUGH PERFECTLY INTERCHANGEABLE. REFERENCE NUMBERS, EITHER ORIGINAL OR OF A DIFFERENT NATURE, ARE FOR INFORMATION PURPOSES ONLY WHEN PLACING AN ORDER, PLEASE, ALWAYS USE COSIBO REFERENCE NUMBERS AND DO NOT MENTION THE ORIGINAL REFERENCE NUMBERS OF THE TRUCK MANUFACTURERS IN THE INVOICE TO VEHICLE OWNERS OR TO ANYBODY ELSE. THE CUSTOMER TAKES HIS OWN RESPONSIBILITY IF HE DOES NOT COMPLY WITH WHAT ABOVE.

	Code	OEM new	OEM old
MARKING LAMP	62300	1471599	
● Model			
★ Application			
● 3 TRUCK			
★			
● 4 TRUCK			
★			
● F-K-N BUS			
★ CK/CN - CNUD			
● 4 BUS			
★ CL/CN94			



MARKING LAMP	62463	2000390	1737413
● P-G-R-T TRUCK			
★			



CENTRAL LH & RH STEP	62353	1535045	1351203
● 4 TRUCK			
★ CP/CR			



LOWER LH & RH STEP



- Model
- ★ Application

Code

OEM new

OEM old

64104

1535052

- P-G-R-T TRUCK

- ★ CG/CP/CR

MIDDLE LH & RH STEP



- P-G-R-T TRUCK

- ★ CP/CR/CT

64105

1805447

1535048

SILENCER LATERAL COVER



● Model

★ Application

Code

OEM new

OEM old

63962

1496659

1387870

● 4 TRUCK

★ 114 - 124 - 144 - 164

● P-G-R-T TRUCK

★ CG/CP/CR

LH DOOR LOCK

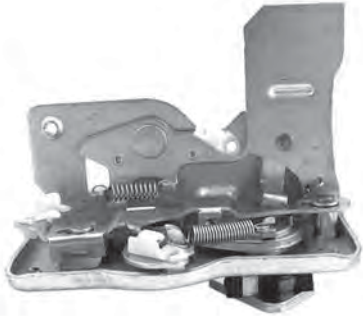

- Model
- ★ Application

Code	OEM new	OEM old
64050	376283	

- 3 TRUCK
- ★

RH DOOR LOCK

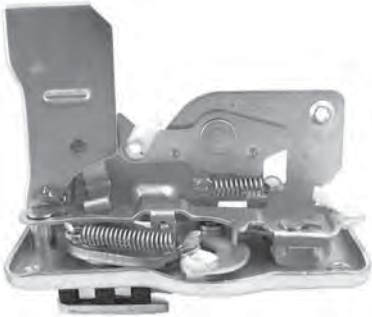

- 3 TRUCK
- ★

64051	376284	
-------	--------	--

LH INTERNAL DOOR LOCK



- 4 TRUCK
- ★ CP/CR/CT

64001	1789305	1406223
-------	---------	---------

RH INTERNAL DOOR LOCK



- 3 TRUCK
- ★ CP/CR/CT

64002	1789306	1406224
-------	---------	---------

ALL THE COMPONENTS LISTED IN OUR CATALOGUE ARE NOT ORIGINAL, THOUGH PERFECTLY INTERCHANGEABLE. REFERENCE NUMBERS, EITHER ORIGINAL OR OF A DIFFERENT NATURE, ARE FOR INFORMATION PURPOSES ONLY WHEN PLACING AN ORDER, PLEASE, ALWAYS USE COSIBO REFERENCE NUMBERS AND DO NOT MENTION THE ORIGINAL REFERENCE NUMBERS OF THE TRUCK MANUFACTURERS IN THE INVOICE TO VEHICLE OWNERS OR TO ANYBODY ELSE. THE CUSTOMER TAKES HIS OWN RESPONSIBILITY IF HE DOES NOT COMPLY WITH WHAT ABOVE.

	Code	OEM new	OEM old
WINDOW HANDLE 	62208	376116	
<ul style="list-style-type: none"> ● Model ★ Application 			
<ul style="list-style-type: none"> ● 3 TRUCK ★ 			
WINDOW HANDLE 	64368	1346181	
<ul style="list-style-type: none"> ● 4 TRUCK ★ CP/CR/CT 			
WINDOW HANDLE 	64369	1425659	
<ul style="list-style-type: none"> ● P-G-R-T TRUCK ★ CG/CP/CR/CT 			
LH DOOR HANDLER LEVER 	64023	1346177	
<ul style="list-style-type: none"> ● 4 TRUCK ★ 			

ALL THE COMPONENTS LISTED IN OUR CATALOGUE ARE NOT ORIGINAL, THOUGH PERFECTLY INTERCHANGEABLE. REFERENCE NUMBERS, EITHER ORIGINAL OR OF A DIFFERENT NATURE, ARE FOR INFORMATION PURPOSES ONLY WHEN PLACING AN ORDER, PLEASE, ALWAYS USE COSIBO REFERENCE NUMBERS AND DO NOT MENTION THE ORIGINAL REFERENCE NUMBERS OF THE TRUCK MANUFACTURERS IN THE INVOICE TO VEHICLE OWNERS OR TO ANYBODY ELSE. THE CUSTOMER TAKES HIS OWN RESPONSIBILITY IF HE DOES NOT COMPLY WITH WHAT ABOVE.

	Code	OEM new	OEM old
RH DOOR HANDLER LEVER	64024	1346178	



- Model
- ★ Application

● 4 TRUCK

★

LH HANDLE LEVER TIEROD	63540	1346905	
-------------------------------	--------------	---------	--



● 4 TRUCK

★

RH HANDLE LEVER TIEROD	63541	1346906	
-------------------------------	--------------	---------	--



● 4 TRUCK

★

ALL THE COMPONENTS LISTED IN OUR CATALOGUE ARE NOT ORIGINAL, THOUGH PERFECTLY INTERCHANGEABLE. REFERENCE NUMBERS, EITHER ORIGINAL OR OF A DIFFERENT NATURE, ARE FOR INFORMATION PURPOSES ONLY WHEN PLACING AN ORDER, PLEASE, ALWAYS USE COSIBO REFERENCE NUMBERS AND DO NOT MENTION THE ORIGINAL REFERENCE NUMBERS OF THE TRUCK MANUFACTURERS IN THE INVOICE TO VEHICLE OWNERS OR TO ANYBODY ELSE. THE CUSTOMER TAKES HIS OWN RESPONSIBILITY IF HE DOES NOT COMPLY WITH WHAT ABOVE.

LH DOOR HANDLE



- Model
- ★ Application

Code	OEM new	OEM old
62347	1544330	1423017 1488409

- 4 TRUCK
- ★ CP/CR/CT
- P-G-R-T TRUCK
- ★

RH DOOR HANDLE



- 4 TRUCK
- ★ CP/CR/CT
- P-G-R-T TRUCK
- ★

62348	1544331	1423018 1488410
-------	---------	--------------------

LOCK CYLINDER SET



- 4 TRUCK
- ★ 94 - 114 - 124 - 144 - 164
- 4 BUS
- ★ F94H

62354	581025	
-------	--------	--

ALL THE COMPONENTS LISTED IN OUR CATALOGUE ARE NOT ORIGINAL, THOUGH PERFECTLY INTERCHANGEABLE. REFERENCE NUMBERS, EITHER ORIGINAL OR OF A DIFFERENT NATURE, ARE FOR INFORMATION PURPOSES ONLY WHEN PLACING AN ORDER, PLEASE, ALWAYS USE COSIBO REFERENCE NUMBERS AND DO NOT MENTION THE ORIGINAL REFERENCE NUMBERS OF THE TRUCK MANUFACTURERS IN THE INVOICE TO VEHICLE OWNERS OR TO ANYBODY ELSE. THE CUSTOMER TAKES HIS OWN RESPONSIBILITY IF HE DOES NOT COMPLY WITH WHAT ABOVE.

	Code	OEM new	OEM old
DOOR CYLINDER LOCK SET	62421	62421	
<ul style="list-style-type: none"> ● Model ★ Application 			
<ul style="list-style-type: none"> ● 4 TRUCK ★ 94 - 114 - 124 - 144 - 164 			
<ul style="list-style-type: none"> ● 4 BUS ★ F94H 			



LH WINDOW REGULATOR	61363	336979	
<ul style="list-style-type: none"> ● 3 TRUCK ★ 93 - 113 - 143 			
<ul style="list-style-type: none"> ● 2 TRUCK ★ 82 - 92 - 112 - 142 			



RH WINDOW REGULATOR	61644	336980	
<ul style="list-style-type: none"> ● 3 TRUCK ★ 93 - 113 - 143 			
<ul style="list-style-type: none"> ● 2 TRUCK ★ 82 - 92 - 112 - 142 			



LH ELECTRIC WINDOW REGULATOR WITH MOTOR	61606	1406613	376673
<ul style="list-style-type: none"> ● 3 TRUCK ★ 93 - 113 - 143 			



ALL THE COMPONENTS LISTED IN OUR CATALOGUE ARE NOT ORIGINAL, THOUGH PERFECTLY INTERCHANGEABLE. REFERENCE NUMBERS, EITHER ORIGINAL OR OF A DIFFERENT NATURE, ARE FOR INFORMATION PURPOSES ONLY WHEN PLACING AN ORDER, PLEASE, ALWAYS USE COSIBO REFERENCE NUMBERS AND DO NOT MENTION THE ORIGINAL REFERENCE NUMBERS OF THE TRUCK MANUFACTURERS IN THE INVOICE TO VEHICLE OWNERS OR TO ANYBODY ELSE. THE CUSTOMER TAKES HIS OWN RESPONSIBILITY IF HE DOES NOT COMPLY WITH WHAT ABOVE.

RH ELECTRIC WINDOW REGULATOR WITH MOTOR

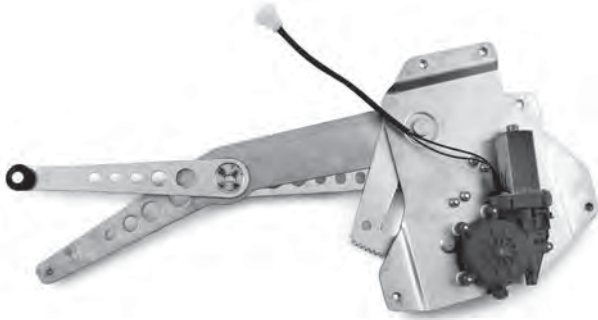

- Model
- ★ Application

Code	OEM new	OEM old
62195	1406614	376674

- 3 TRUCK
- ★ 93 - 113 - 143

LH DOOR HANDLE



- 3 TRUCK
- ★

61728	1306975	356085
--------------	---------	--------

RH DOOR HANDLE



- 3 TRUCK
- ★

61729	1306976	356086
--------------	---------	--------

ALL THE COMPONENTS LISTED IN OUR CATALOGUE ARE NOT ORIGINAL, THOUGH PERFECTLY INTERCHANGEABLE. REFERENCE NUMBERS, EITHER ORIGINAL OR OF A DIFFERENT NATURE, ARE FOR INFORMATION PURPOSES ONLY WHEN PLACING AN ORDER, PLEASE, ALWAYS USE COSIBO REFERENCE NUMBERS AND DO NOT MENTION THE ORIGINAL REFERENCE NUMBERS OF THE TRUCK MANUFACTURERS IN THE INVOICE TO VEHICLE OWNERS OR TO ANYBODY ELSE. THE CUSTOMER TAKES HIS OWN RESPONSIBILITY IF HE DOES NOT COMPLY WITH WHAT ABOVE.

RH/LH DOOR STOP TIEROD



- Model
- ★ Application

Code	OEM new	OEM old
62321	356942	356942

- 3 TRUCK
- ★ 93 - 113 - 143

LH ELECTRIC WINDOW REGULATOR WITH MOTOR

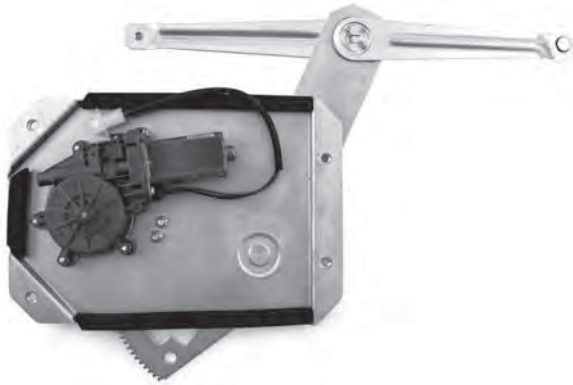

61607	1366849	
-------	---------	--

- 4 TRUCK
- ★
- P-G-R-T TRUCK
- ★

RH ELECTRIC WINDOW REGULATOR WITH MOTOR

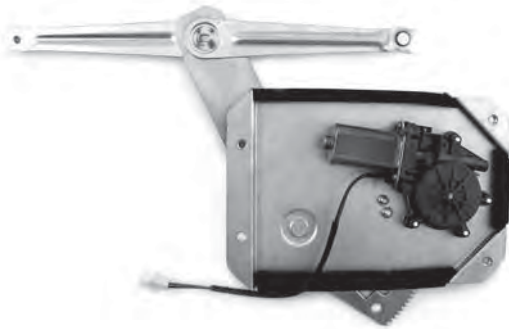

62343	1366850	1366850
-------	---------	---------

- 4 TRUCK
- ★
- P-G-R-T TRUCK
- ★

ALL THE COMPONENTS LISTED IN OUR CATALOGUE ARE NOT ORIGINAL, THOUGH PERFECTLY INTERCHANGEABLE. REFERENCE NUMBERS, EITHER ORIGINAL OR OF A DIFFERENT NATURE, ARE FOR INFORMATION PURPOSES ONLY WHEN PLACING AN ORDER, PLEASE, ALWAYS USE COSIBO REFERENCE NUMBERS AND DO NOT MENTION THE ORIGINAL REFERENCE NUMBERS OF THE TRUCK MANUFACTURERS IN THE INVOICE TO VEHICLE OWNERS OR TO ANYBODY ELSE. THE CUSTOMER TAKES HIS OWN RESPONSIBILITY IF HE DOES NOT COMPLY WITH WHAT ABOVE.

LH ELECTRIC WINDOW REGULATOR WITH MOTOR

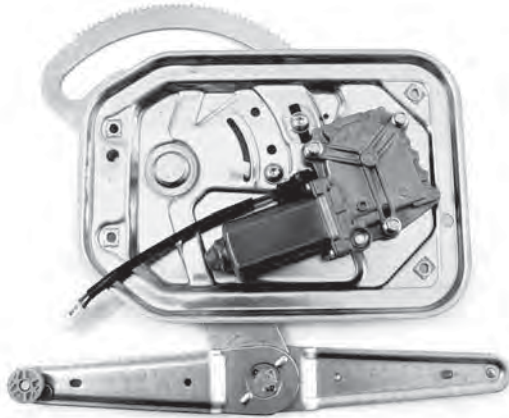

- Model
- ★ Application

Code	OEM new	OEM old
65365	1442294	

- 4 TRUCK
- ★
- P-G-R-T TRUCK
- ★

RH ELECTRIC WINDOW REGULATOR WITH MOTOR

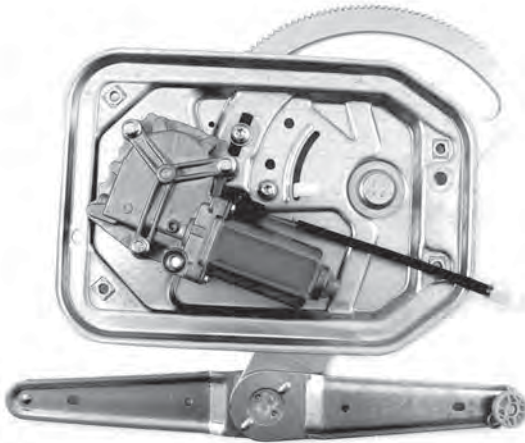

- 4 TRUCK
- ★
- P-G-R-T TRUCK
- ★

65366	1442295	
-------	---------	--

LH WINDOW REGULATOR MOTOR

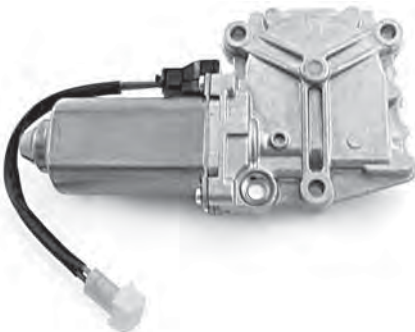

- 4 TRUCK
- ★
- P-G-R-T TRUCK
- ★

63913	1442292	
-------	---------	--

ALL THE COMPONENTS LISTED IN OUR CATALOGUE ARE NOT ORIGINAL, THOUGH PERFECTLY INTERCHANGEABLE. REFERENCE NUMBERS, EITHER ORIGINAL OR OF A DIFFERENT NATURE, ARE FOR INFORMATION PURPOSES ONLY WHEN PLACING AN ORDER, PLEASE, ALWAYS USE COSIBO REFERENCE NUMBERS AND DO NOT MENTION THE ORIGINAL REFERENCE NUMBERS OF THE TRUCK MANUFACTURERS IN THE INVOICE TO VEHICLE OWNERS OR TO ANYBODY ELSE. THE CUSTOMER TAKES HIS OWN RESPONSIBILITY IF HE DOES NOT COMPLY WITH WHAT ABOVE.

RH WINDOW REGULATOR MOTOR



- Model
- ★ Application

Code

OEM new

OEM old

63914

1442293

- 4 TRUCK

★

- P-G-R-T TRUCK

★

SWITCH



- 4 TRUCK

★

62389

1413146

SLIDING GUIDE



- 4 TRUCK

★

- P-G-R-T TRUCK

★

64025

1346119

SLIDING GUIDE



- 4 TRUCK

★





- P-G-R-T TRUCK

★



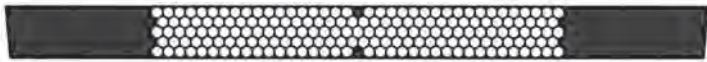
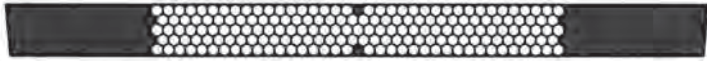

64026

1366764



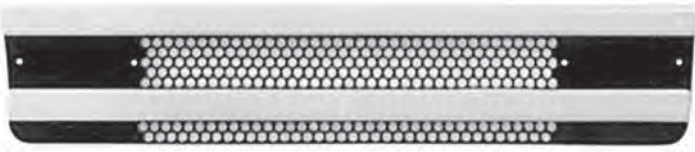

ALL THE COMPONENTS LISTED IN OUR CATALOGUE ARE NOT ORIGINAL, THOUGH PERFECTLY INTERCHANGEABLE. REFERENCE NUMBERS, EITHER ORIGINAL OR OF A DIFFERENT NATURE, ARE FOR INFORMATION PURPOSES ONLY WHEN PLACING AN ORDER, PLEASE, ALWAYS USE COSIBO REFERENCE NUMBERS AND DO NOT MENTION THE ORIGINAL REFERENCE NUMBERS OF THE TRUCK MANUFACTURERS IN THE INVOICE TO VEHICLE OWNERS OR TO ANYBODY ELSE. THE CUSTOMER TAKES HIS OWN RESPONSIBILITY IF HE DOES NOT COMPLY WITH WHAT ABOVE.

	Code	OEM new	OEM old
FRONT PANEL	62280	1383609	
	<ul style="list-style-type: none"> ● Model ★ Application 		
	<ul style="list-style-type: none"> ● 4 TRUCK ★ CR LHD CH 1227496 - CH 4371634 - CH 9021603 - CH 3500001 - CP/CR RHD CH 1233808 - CH 4382182 - CH 9027044 - CH 3500001 - CP LHD CH 1230215 - CH 4376385 - CH 9023917 - CH 3500001 		
FRONT GRILLE	61971	1397570	1371856
	<ul style="list-style-type: none"> ● 4 TRUCK ★ CR LHD/RHD 		
UPPER GRILLE NET	62310	1401929	
	<ul style="list-style-type: none"> ● 4 TRUCK ★ CR LHD/RHD FOR OUR 61971 		
MIDDLE GRILLE NET	62311	1371757	
	<ul style="list-style-type: none"> ● 4 TRUCK ★ CR LHD/RHD FOR OUR 61971 		
LOWER GRILLE NET	62312	1371758	
	<ul style="list-style-type: none"> ● 4 TRUCK ★ CR LHD/RHD FOR OUR 61971 		
RADIATOR GRILLE	62411	1870689	1366832
	<ul style="list-style-type: none"> ● 4 TRUCK ★ CP/CR 		





ALL THE COMPONENTS LISTED IN OUR CATALOGUE ARE NOT ORIGINAL, THOUGH PERFECTLY INTERCHANGEABLE. REFERENCE NUMBERS, EITHER ORIGINAL OR OF A DIFFERENT NATURE, ARE FOR INFORMATION PURPOSES ONLY WHEN PLACING AN ORDER, PLEASE, ALWAYS USE COSIBO REFERENCE NUMBERS AND DO NOT MENTION THE ORIGINAL REFERENCE NUMBERS OF THE TRUCK MANUFACTURERS IN THE INVOICE TO VEHICLE OWNERS OR TO ANYBODY ELSE. THE CUSTOMER TAKES HIS OWN RESPONSIBILITY IF HE DOES NOT COMPLY WITH WHAT ABOVE.

	Code	OEM new	OEM old
GRILLE	62275	1366384	1306198
	<ul style="list-style-type: none"> ● Model ★ Application 		
	<ul style="list-style-type: none"> ● 4 TRUCK ★ CP/CR/CT 		
LH GRILLE HINGE	62364	1381479	1306403
	<ul style="list-style-type: none"> ● 4 TRUCK ★ CP/CR FOR OUR 62275 		
RH GRILLE HINGE	62365	1381480	1306404
	<ul style="list-style-type: none"> ● 4 TRUCK ★ CP/CR FOR OUR 62275 		
LH GRILLE HINGE	62412	1383887	
	<ul style="list-style-type: none"> ● 4 TRUCK ★ CR LHD CH 1227496 - CH 4371634 - CH 9021603 - CH 3500001 - CR RHD CH 1233808 - CH 4382182 - CH 9027044 - CH 3500001 - CP LHD CH 1230215 - CH 4376385 - CH 9023917 - CH 3500001 - CP RHD CH 1233808 - CH 4382182 - CH 9027044 - CH 3500001 FOR OUR 61971 		
RH GRILLE HINGE	62413	1383888	
	<ul style="list-style-type: none"> ● 4 TRUCK ★ CR LHD CH 1227496 - CH 4371634 - CH 9021603 - CH 3500001 - CR RHD CH 1233808 - CH 4382182 - CH 9027044 - CH 3500001 - CP LHD CH 1230215 - CH 4376385 - CH 9023917 - CH 3500001 - CP RHD CH 1233808 - CH 4382182 - CH 9027044 - CH 3500001 FOR OUR 61971 		







ALL THE COMPONENTS LISTED IN OUR CATALOGUE ARE NOT ORIGINAL, THOUGH PERFECTLY INTERCHANGEABLE. REFERENCE NUMBERS, EITHER ORIGINAL OR OF A DIFFERENT NATURE, ARE FOR INFORMATION PURPOSES ONLY WHEN PLACING AN ORDER, PLEASE, ALWAYS USE COSIBO REFERENCE NUMBERS AND DO NOT MENTION THE ORIGINAL REFERENCE NUMBERS OF THE TRUCK MANUFACTURERS IN THE INVOICE TO VEHICLE OWNERS OR TO ANYBODY ELSE. THE CUSTOMER TAKES HIS OWN RESPONSIBILITY IF HE DOES NOT COMPLY WITH WHAT ABOVE.

	Code	OEM new	OEM old
FRONT GRILLE	61969	1317538	
	<ul style="list-style-type: none"> ● Model ★ Application 		
	<ul style="list-style-type: none"> ● 3 TRUCK ★ CABIN CG/CP CH 1189449 - CH 4322041 - CABIN CP 6X4 - 8X4 - CABIN CP CH 1184048 - CH 4316396 		
FRONT GRILLE HANDLE	62363	388536	
	<ul style="list-style-type: none"> ● 3 TRUCK ★ 93 - 113 - 143 		
GRILLE HINGE	62366	385159	
	<ul style="list-style-type: none"> ● 3 TRUCK ★ 93 - 113 - 143 		
GRILLE	62305	1397571	1371857
	<ul style="list-style-type: none"> ● 4 TRUCK ★ CP LHD/RHD 		

ALL THE COMPONENTS LISTED IN OUR CATALOGUE ARE NOT ORIGINAL, THOUGH PERFECTLY INTERCHANGEABLE. REFERENCE NUMBERS, EITHER ORIGINAL OR OF A DIFFERENT NATURE, ARE FOR INFORMATION PURPOSES ONLY WHEN PLACING AN ORDER, PLEASE, ALWAYS USE COSIBO REFERENCE NUMBERS AND DO NOT MENTION THE ORIGINAL REFERENCE NUMBERS OF THE TRUCK MANUFACTURERS IN THE INVOICE TO VEHICLE OWNERS OR TO ANYBODY ELSE. THE CUSTOMER TAKES HIS OWN RESPONSIBILITY IF HE DOES NOT COMPLY WITH WHAT ABOVE.

	Code	OEM new	OEM old
UPPER GRILLE NET 	63917	1401931	
<ul style="list-style-type: none"> ● Model ★ Application 			
<ul style="list-style-type: none"> ● 4 TRUCK ★ CP LHD/RHD FOR OUR 62305 			
LOWER GRILLE NET 	63918	1371754	
<ul style="list-style-type: none"> ● 4 TRUCK ★ CP LHD/RHD FOR OUR 62305 			
FRONT GRILLE 	62480	1755594	1538383
<ul style="list-style-type: none"> ● P-G-R-T TRUCK ★ CG/CR 			
LH COVER 	64676	1466031	
<ul style="list-style-type: none"> ● P-G-R-T TRUCK ★ CG/CR 			
RH COVER 	64677	1466032	
<ul style="list-style-type: none"> ● P-G-R-T TRUCK ★ CG/CR 			



ALL THE COMPONENTS LISTED IN OUR CATALOGUE ARE NOT ORIGINAL, THOUGH PERFECTLY INTERCHANGEABLE. REFERENCE NUMBERS, EITHER ORIGINAL OR OF A DIFFERENT NATURE, ARE FOR INFORMATION PURPOSES ONLY WHEN PLACING AN ORDER, PLEASE, ALWAYS USE COSIBO REFERENCE NUMBERS AND DO NOT MENTION THE ORIGINAL REFERENCE NUMBERS OF THE TRUCK MANUFACTURERS IN THE INVOICE TO VEHICLE OWNERS OR TO ANYBODY ELSE. THE CUSTOMER TAKES HIS OWN RESPONSIBILITY IF HE DOES NOT COMPLY WITH WHAT ABOVE.

	Code	OEM new	OEM old
UPPER GRILLE NET 	64691	1459133	
<ul style="list-style-type: none"> ● Model ★ Application 	<ul style="list-style-type: none"> ● P-G-R-T TRUCK ★ CG/CR FOR OUR 62480 		
MIDDLE GRILLE NET 	64692	1459134	
<ul style="list-style-type: none"> ● P-G-R-T TRUCK ★ CG/CR FOR OUR 62480 			
LOWER GRILLE NET 	64693	1459135	
<ul style="list-style-type: none"> ● P-G-R-T TRUCK ★ CG/CR FOR OUR 62480 			
FRONT GRILLE 	64697	1748085	
<ul style="list-style-type: none"> ● P-G-R-T TRUCK ★ CR LOW AND HIGH BUMPER 			
CLIP 	64682	1805399	1541484
<ul style="list-style-type: none"> ● P-G-R-T TRUCK ★ CG/CP/CR 			
GRILLE NET 	64696	1459145	
<ul style="list-style-type: none"> ● P-G-R-T TRUCK ★ CR LOW BUMBER FOR OUR 64697 			

ALL THE COMPONENTS LISTED IN OUR CATALOGUE ARE NOT ORIGINAL, THOUGH PERFECTLY INTERCHANGEABLE. REFERENCE NUMBERS, EITHER ORIGINAL OR OF A DIFFERENT NATURE, ARE FOR INFORMATION PURPOSES ONLY WHEN PLACING AN ORDER, PLEASE, ALWAYS USE COSIBO REFERENCE NUMBERS AND DO NOT MENTION THE ORIGINAL REFERENCE NUMBERS OF THE TRUCK MANUFACTURERS IN THE INVOICE TO VEHICLE OWNERS OR TO ANYBODY ELSE. THE CUSTOMER TAKES HIS OWN RESPONSIBILITY IF HE DOES NOT COMPLY WITH WHAT ABOVE.

	Code	OEM new	OEM old
FRONT GRILLE	62481	1536807	
	<ul style="list-style-type: none"> ● Model ★ Application ● P-G-R-T TRUCK ★ CP/CG/CR LOW BUMPER - CP/CG/CR HIGH BUMPER 		
LH HINGE	64678	1727263	
	<ul style="list-style-type: none"> ● P-G-R-T TRUCK ★ CG/CP/CR/CT HIGH BUMPER CH 2004860 - CH 5113674 - CH 9095270 		
RH HINGE	64679	1727264	
	<ul style="list-style-type: none"> ● P-G-R-T TRUCK ★ CG/CP/CR/CT HIGH BUMPER CH 2004860 - CH 5113674 - CH 9095270 		
LH GRILLE HINGE	62532	1724264	1543307
	<ul style="list-style-type: none"> ● P-G-R-T TRUCK ★ CP/CG/CR LOW BUMPER - CT LOW BUMPER FOR OUR 62481 		

ALL THE COMPONENTS LISTED IN OUR CATALOGUE ARE NOT ORIGINAL, THOUGH PERFECTLY INTERCHANGEABLE. REFERENCE NUMBERS, EITHER ORIGINAL OR OF A DIFFERENT NATURE, ARE FOR INFORMATION PURPOSES ONLY WHEN PLACING AN ORDER, PLEASE, ALWAYS USE COSIBO REFERENCE NUMBERS AND DO NOT MENTION THE ORIGINAL REFERENCE NUMBERS OF THE TRUCK MANUFACTURERS IN THE INVOICE TO VEHICLE OWNERS OR TO ANYBODY ELSE. THE CUSTOMER TAKES HIS OWN RESPONSIBILITY IF HE DOES NOT COMPLY WITH WHAT ABOVE.

	Code	OEM new	OEM old
RH GRILLE HINGE	62531	1742265	1543308
	<ul style="list-style-type: none"> ● Model ★ Application 		
	<ul style="list-style-type: none"> ● P-G-R-T TRUCK ★ CP/CG/CR LOW BUMPER - CT LOW BUMPER FOR OUR 62481 		
UPPER GRILLE NET	64694	1459141	
	<ul style="list-style-type: none"> ● P-G-R-T TRUCK ★ CP/CG/CR LOW BUMPER FOR OUR 62481 		
LOWER GRILLE NET	64695	1459142	
	<ul style="list-style-type: none"> ● P-G-R-T TRUCK ★ CP/CG/CR LOW BUMPER FOR OUR 62481 		
GRILLE NET	64362	1459146	
	<ul style="list-style-type: none"> ● P-G-R-T TRUCK ★ CP LOW BUMPER FOR OUR 64706 		
MAIN FRAME	64364	1804628	1746585
	<ul style="list-style-type: none"> ● P-G-R-T TRUCK ★ CG/CR 		

ALL THE COMPONENTS LISTED IN OUR CATALOGUE ARE NOT ORIGINAL, THOUGH PERFECTLY INTERCHANGEABLE. REFERENCE NUMBERS, EITHER ORIGINAL OR OF A DIFFERENT NATURE, ARE FOR INFORMATION PURPOSES ONLY WHEN PLACING AN ORDER, PLEASE, ALWAYS USE COSIBO REFERENCE NUMBERS AND DO NOT MENTION THE ORIGINAL REFERENCE NUMBERS OF THE TRUCK MANUFACTURERS IN THE INVOICE TO VEHICLE OWNERS OR TO ANYBODY ELSE. THE CUSTOMER TAKES HIS OWN RESPONSIBILITY IF HE DOES NOT COMPLY WITH WHAT ABOVE.

HOOD AND GRILLE HINGE



● Model

★ Application

Code

OEM new

OEM old

62533

1767631

1431334

● 4 TRUCK

★





CT HOOD - CR GRILLE CH 1227023 - CH 4371353 - CH 9020783 - CH 3500001 -
CP GRILLE CH 1233805 - CH 4382184 - CH 9027006 - CH 3500089

● P-G-R-T TRUCK

★

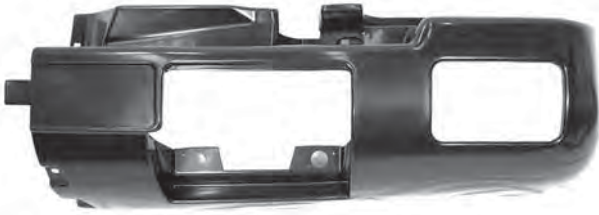
CP/CR GRILLE CH 2025384 - CH 5171872 - CH 9119291 - CH 3604451 - CT
HOOD - CP/CG/CR GRILLE CH 2025385 - CH 5171873 - CH 9119292 - CH
3604452

ALL THE COMPONENTS LISTED IN OUR CATALOGUE ARE NOT ORIGINAL, THOUGH PERFECTLY INTERCHANGEABLE. REFERENCE NUMBERS, EITHER ORIGINAL OR OF A DIFFERENT NATURE, ARE FOR INFORMATION PURPOSES ONLY WHEN PLACING AN ORDER, PLEASE, ALWAYS USE COSIBO REFERENCE NUMBERS AND DO NOT MENTION THE ORIGINAL REFERENCE NUMBERS OF THE TRUCK MANUFACTURERS IN THE INVOICE TO VEHICLE OWNERS OR TO ANYBODY ELSE. THE CUSTOMER TAKES HIS OWN RESPONSIBILITY IF HE DOES NOT COMPLY WITH WHAT ABOVE.

	Code	OEM new	OEM old
FRONT BUMPER 	61988	1303318	1110201
<ul style="list-style-type: none"> ● Model ★ Application 			
<ul style="list-style-type: none"> ● 3 TRUCK ★ 			
LH BUMPER 	61993	1329551	
<ul style="list-style-type: none"> ● 3 TRUCK ★ STREAMLINE 			
RH BUMPER 	61992	1329552	
<ul style="list-style-type: none"> ● 3 TRUCK ★ STREAMLINE 			
CENTRAL BUMPER 	64664	1731206	1422843
<ul style="list-style-type: none"> ● P-G-R-T TRUCK ★ CP/CR/CT 			
LH CORNER BUMPER 	64663	1439788	
<ul style="list-style-type: none"> ● P-G-R-T TRUCK ★ CP/CR/CT 			

ALL THE COMPONENTS LISTED IN OUR CATALOGUE ARE NOT ORIGINAL, THOUGH PERFECTLY INTERCHANGEABLE. REFERENCE NUMBERS, EITHER ORIGINAL OR OF A DIFFERENT NATURE, ARE FOR INFORMATION PURPOSES ONLY WHEN PLACING AN ORDER, PLEASE, ALWAYS USE COSIBO REFERENCE NUMBERS AND DO NOT MENTION THE ORIGINAL REFERENCE NUMBERS OF THE TRUCK MANUFACTURERS IN THE INVOICE TO VEHICLE OWNERS OR TO ANYBODY ELSE. THE CUSTOMER TAKES HIS OWN RESPONSIBILITY IF HE DOES NOT COMPLY WITH WHAT ABOVE.

	Code	OEM new	OEM old
RH CORNER BUMPER	64662	1439789	
<ul style="list-style-type: none"> ● Model ★ Application 			
<ul style="list-style-type: none"> ● P-G-R-T TRUCK ★ CP/CR/CT 			
			
LH COVER	64674	1523508	
<ul style="list-style-type: none"> ● P-G-R-T TRUCK ★ CP/CR/CT 			
			
RH COVER	64675	1523509	
<ul style="list-style-type: none"> ● P-G-R-T TRUCK ★ CP/CR/CT 			
			
CENTRAL BUMPER	62434	1504131	
<ul style="list-style-type: none"> ● P-G-R-T TRUCK ★ CP/CR/CT 			
			

ALL THE COMPONENTS LISTED IN OUR CATALOGUE ARE NOT ORIGINAL, THOUGH PERFECTLY INTERCHANGEABLE. REFERENCE NUMBERS, EITHER ORIGINAL OR OF A DIFFERENT NATURE, ARE FOR INFORMATION PURPOSES ONLY WHEN PLACING AN ORDER, PLEASE, ALWAYS USE COSIBO REFERENCE NUMBERS AND DO NOT MENTION THE ORIGINAL REFERENCE NUMBERS OF THE TRUCK MANUFACTURERS IN THE INVOICE TO VEHICLE OWNERS OR TO ANYBODY ELSE. THE CUSTOMER TAKES HIS OWN RESPONSIBILITY IF HE DOES NOT COMPLY WITH WHAT ABOVE.

LH CORNER BUMPER



- Model
- ★ Application

62432

1431925

- P-G-R-T TRUCK

- ★ CP/CR/CT

RH CORNER BUMPER



- P-G-R-T TRUCK

- ★ CP/CR/CT

62433

1431926

METAL BUMPER



- 4 TRUCK





- ★ CR/CR/CT

62250

1515190

1376832
1482069
1499231

ALL THE COMPONENTS LISTED IN OUR CATALOGUE ARE NOT ORIGINAL, THOUGH PERFECTLY INTERCHANGEABLE. REFERENCE NUMBERS, EITHER ORIGINAL OR OF A DIFFERENT NATURE, ARE FOR INFORMATION PURPOSES ONLY WHEN PLACING AN ORDER, PLEASE, ALWAYS USE COSIBO REFERENCE NUMBERS AND DO NOT MENTION THE ORIGINAL REFERENCE NUMBERS OF THE TRUCK MANUFACTURERS IN THE INVOICE TO VEHICLE OWNERS OR TO ANYBODY ELSE. THE CUSTOMER TAKES HIS OWN RESPONSIBILITY IF HE DOES NOT COMPLY WITH WHAT ABOVE.

	Code	OEM new	OEM old
INTERNAL REINFORCEMENT BUMPER 	62264	1514093	1395871 1499230
<ul style="list-style-type: none"> ● Model ★ Application 			
<ul style="list-style-type: none"> ● 4 TRUCK ★ CP/CR/CT 			
PLASTIC FRONT BUMPER 	61991	1400213	1324596
<ul style="list-style-type: none"> ● 4 TRUCK ★ CP/CR/CT 			
LH PLASTIC CORNER BUMPER 	61989	1324597	
<ul style="list-style-type: none"> ● 4 TRUCK ★ CP/CR/CT 			
RH PLASTIC CORNER BUMPER 	61990	1324598	
<ul style="list-style-type: none"> ● 4 TRUCK ★ CP/CR/CT 			

ALL THE COMPONENTS LISTED IN OUR CATALOGUE ARE NOT ORIGINAL, THOUGH PERFECTLY INTERCHANGEABLE. REFERENCE NUMBERS, EITHER ORIGINAL OR OF A DIFFERENT NATURE, ARE FOR INFORMATION PURPOSES ONLY WHEN PLACING AN ORDER, PLEASE, ALWAYS USE COSIBO REFERENCE NUMBERS AND DO NOT MENTION THE ORIGINAL REFERENCE NUMBERS OF THE TRUCK MANUFACTURERS IN THE INVOICE TO VEHICLE OWNERS OR TO ANYBODY ELSE. THE CUSTOMER TAKES HIS OWN RESPONSIBILITY IF HE DOES NOT COMPLY WITH WHAT ABOVE.

	Code	OEM new	OEM old
CENTRAL BUMPER	64747	1482078	
<ul style="list-style-type: none"> ● Model ★ Application 			
<ul style="list-style-type: none"> ● 4 TRUCK ★ CR/CP/CT 			



LH CORNER BUMPER	64745	1482079	
<ul style="list-style-type: none"> ● 4 TRUCK ★ CP/CR/CT 			



RH CORNER BUMPER	64746	1482080	
<ul style="list-style-type: none"> ● 4 TRUCK ★ CP/CR/CT 			



ALL THE COMPONENTS LISTED IN OUR CATALOGUE ARE NOT ORIGINAL, THOUGH PERFECTLY INTERCHANGEABLE. REFERENCE NUMBERS, EITHER ORIGINAL OR OF A DIFFERENT NATURE, ARE FOR INFORMATION PURPOSES ONLY WHEN PLACING AN ORDER, PLEASE, ALWAYS USE COSIBO REFERENCE NUMBERS AND DO NOT MENTION THE ORIGINAL REFERENCE NUMBERS OF THE TRUCK MANUFACTURERS IN THE INVOICE TO VEHICLE OWNERS OR TO ANYBODY ELSE. THE CUSTOMER TAKES HIS OWN RESPONSIBILITY IF HE DOES NOT COMPLY WITH WHAT ABOVE.

	Code	OEM new	OEM old
LH MUDGUARD COVER	62441	1364665	
● Model			
★ Application			
● 4 TRUCK			
★ CP/CR19			
● P-G-R-T TRUCK			
★ CG/CP19			



RH MUDGUARD COVER	62440	1364666	
● 4 TRUCK			
★ CP/CR19			
● P-G-R-T TRUCK			
★ CG/CP19			



LH MUDGUARD COVER	64698	1431933	
● P-G-R-T TRUCK			
★ CP/CG/CR - CR19			



	Code	OEM new	OEM old
RH MUDGUARD COVER	64699	1431934	
<ul style="list-style-type: none"> ● Model ★ Application 			
<ul style="list-style-type: none"> ● P-G-R-T TRUCK ★ CP/CG/CR - CR19 			



LH MUDGUARD COVER	64704	1431931	
<ul style="list-style-type: none"> ● P-G-R-T TRUCK ★ CR 			



RH MUDGUARD COVER	64707	1431932	
<ul style="list-style-type: none"> ● P-G-R-T TRUCK ★ CR 			



ALL THE COMPONENTS LISTED IN OUR CATALOGUE ARE NOT ORIGINAL, THOUGH PERFECTLY INTERCHANGEABLE. REFERENCE NUMBERS, EITHER ORIGINAL OR OF A DIFFERENT NATURE, ARE FOR INFORMATION PURPOSES ONLY WHEN PLACING AN ORDER, PLEASE, ALWAYS USE COSIBO REFERENCE NUMBERS AND DO NOT MENTION THE ORIGINAL REFERENCE NUMBERS OF THE TRUCK MANUFACTURERS IN THE INVOICE TO VEHICLE OWNERS OR TO ANYBODY ELSE. THE CUSTOMER TAKES HIS OWN RESPONSIBILITY IF HE DOES NOT COMPLY WITH WHAT ABOVE.

MUDGUARD HOOK



● Model
★ Application

Code

OEM new

OEM old

62256

1383520

● 4 TRUCK

★

● P-G-R-T TRUCK

★

ALL THE COMPONENTS LISTED IN OUR CATALOGUE ARE NOT ORIGINAL, THOUGH PERFECTLY INTERCHANGEABLE. REFERENCE NUMBERS, EITHER ORIGINAL OR OF A DIFFERENT NATURE, ARE FOR INFORMATION PURPOSES ONLY WHEN PLACING AN ORDER, PLEASE, ALWAYS USE COSIBO REFERENCE NUMBERS AND DO NOT MENTION THE ORIGINAL REFERENCE NUMBERS OF THE TRUCK MANUFACTURERS IN THE INVOICE TO VEHICLE OWNERS OR TO ANYBODY ELSE. THE CUSTOMER TAKES HIS OWN RESPONSIBILITY IF HE DOES NOT COMPLY WITH WHAT ABOVE.

LH LATERAL REAR MUDGUARD



	Code	OEM new	OEM old
● Model	60341	1357599	
★ Application			
● 4 TRUCK			
★ 94 - 114 - 124 - 144 - 164			
● P-G-R-T TRUCK			
★			

RH LATERAL REAR MUDGUARD



	Code	OEM new	OEM old
	60340	1357600	
● 4 TRUCK			
★ 94 - 114 - 124 - 144 - 164			
● P-G-R-T TRUCK			
★			

LH MUDGUARD COVER



	Code	OEM new	OEM old
	62308	1362708	
● 4 TRUCK			
★ 94 - 114 - 124 - 144 - 164			
● P-G-R-T TRUCK			
★ 6X2 6X2/4 6X4 8X2 8X2/4 8X2/6 8X4 8X4/4			

ALL THE COMPONENTS LISTED IN OUR CATALOGUE ARE NOT ORIGINAL, THOUGH PERFECTLY INTERCHANGEABLE. REFERENCE NUMBERS, EITHER ORIGINAL OR OF A DIFFERENT NATURE, ARE FOR INFORMATION PURPOSES ONLY WHEN PLACING AN ORDER, PLEASE, ALWAYS USE COSIBO REFERENCE NUMBERS AND DO NOT MENTION THE ORIGINAL REFERENCE NUMBERS OF THE TRUCK MANUFACTURERS IN THE INVOICE TO VEHICLE OWNERS OR TO ANYBODY ELSE. THE CUSTOMER TAKES HIS OWN RESPONSIBILITY IF HE DOES NOT COMPLY WITH WHAT ABOVE.

RH MUDGUARD COVER



● Model

★ Application

Code

OEM new

OEM old

62307

1368652

● 4 TRUCK

★ 94 - 114 - 124 - 144.164

● P-G-R-T TRUCK

★ 6X2 6X2/4 6X4 8X2 8X2/4 8X2/6 8X4 8X4/4

UPPER CENTRAL MUDGUARD



61964

1313592

● 3 TRUCK

★ MA4X2A - MA4X2A STREAMLINE - MA4X2Z - MA4X2Z STREAMLINE - MW4X2 - MW4X2 STREAMLINE - HA4X2A - HA4X2Z - HA4X2Z STREAMLINE - MA6X2A - MA6X2A STREAMLINE - MA6X2/4A LHD - RHD - MA6X2/4A LHD STREAMLINE

BRACKET



62035

1332320

● 3 TRUCK

★

LATERAL MUDGUARD PANEL



● Model

★ Application

Code

OEM new

OEM old

61965

1313594

● 3 TRUCK

- ★ MA4X2A - MA4X2A STREAMLINE - MA4X2Z - MA4X2Z STREAMLINE - MW4X2 - MW4X2 STREAMLINE - HA4X2A - HA4X2Z - HA4X2Z STREAMLINE - MA6X2A - MA6X2A STREAMLINE - MA6X2/4A LHD - RHD - MA6X2/4A LHD STREAMLINE

LH FRONT MUDGUARD



61972

392099

388169

● 3 TRUCK

- ★ CR19 6X4 AM56 - CP19 4X2 6X2 6X4 8X4

RH FRONT MUDGUARD



61973

392100

388170

● 3 TRUCK

- ★ CR19 6X4 AM56 - CP19 4X2 6X2 6X4 8X4

ALL THE COMPONENTS LISTED IN OUR CATALOGUE ARE NOT ORIGINAL, THOUGH PERFECTLY INTERCHANGEABLE. REFERENCE NUMBERS, EITHER ORIGINAL OR OF A DIFFERENT NATURE, ARE FOR INFORMATION PURPOSES ONLY WHEN PLACING AN ORDER, PLEASE, ALWAYS USE COSIBO REFERENCE NUMBERS AND DO NOT MENTION THE ORIGINAL REFERENCE NUMBERS OF THE TRUCK MANUFACTURERS IN THE INVOICE TO VEHICLE OWNERS OR TO ANYBODY ELSE. THE CUSTOMER TAKES HIS OWN RESPONSIBILITY IF HE DOES NOT COMPLY WITH WHAT ABOVE.

LH MUDGUARD



- **Model**
 - ★ **Application**
-
- **3 TRUCK**
 - ★ CR 13 4X2 6X2 6X4

Code	OEM new	OEM old
61974	1302771	

RH MUDGUARD



- **3 TRUCK**
- ★ CR 13 4X2 6X2 6X4

65390	1302772	
--------------	---------	--

ALL THE COMPONENTS LISTED IN OUR CATALOGUE ARE NOT ORIGINAL, THOUGH PERFECTLY INTERCHANGEABLE. REFERENCE NUMBERS, EITHER ORIGINAL OR OF A DIFFERENT NATURE, ARE FOR INFORMATION PURPOSES ONLY WHEN PLACING AN ORDER, PLEASE, ALWAYS USE COSIBO REFERENCE NUMBERS AND DO NOT MENTION THE ORIGINAL REFERENCE NUMBERS OF THE TRUCK MANUFACTURERS IN THE INVOICE TO VEHICLE OWNERS OR TO ANYBODY ELSE. THE CUSTOMER TAKES HIS OWN RESPONSIBILITY IF HE DOES NOT COMPLY WITH WHAT ABOVE.

LH MUDGUARD



- Model
- ★ Application

Code

OEM new

OEM old

61976

1325265

- 3 TRUCK

- ★ STREAMLINE CR 19

RH MUDGUARD



- 3 TRUCK

- ★ STREAMLINE CR 19

61975

1325266

LH REAR MUDGUARD PANEL



- 3 TRUCK

- ★ CP/CR

61979

288177

ALL THE COMPONENTS LISTED IN OUR CATALOGUE ARE NOT ORIGINAL, THOUGH PERFECTLY INTERCHANGEABLE. REFERENCE NUMBERS, EITHER ORIGINAL OR OF A DIFFERENT NATURE, ARE FOR INFORMATION PURPOSES ONLY WHEN PLACING AN ORDER, PLEASE, ALWAYS USE COSIBO REFERENCE NUMBERS AND DO NOT MENTION THE ORIGINAL REFERENCE NUMBERS OF THE TRUCK MANUFACTURERS IN THE INVOICE TO VEHICLE OWNERS OR TO ANYBODY ELSE. THE CUSTOMER TAKES HIS OWN RESPONSIBILITY IF HE DOES NOT COMPLY WITH WHAT ABOVE.

	Code	OEM new	OEM old
RH REAR MUDGUARD PANEL	61980	288178	
	● Model		
	★ Application		
	● 3 TRUCK		
	★ CP/CR		
REAR MUDGUARD	61966	1395276	1378194
	● 4 TRUCK		
	★ 94 - 114 - 124 - 144 - 164		
	● P-G-R-T TRUCK		
	★		
MUDGUARD TENSIONER	61907	1383858	
	● 4 TRUCK		
	★ 94 - 114 - 124 - 144 - 164		
	● P-G-R-T TRUCK		
	★		
FRONT LH / REAR RH MUDGUARD	62344	1485485	1408465
	● 4 TRUCK		
	★ CP 6X2/4 8X2 8X4		
	● P-G-R-T TRUCK		
	★ STD		

ALL THE COMPONENTS LISTED IN OUR CATALOGUE ARE NOT ORIGINAL, THOUGH PERFECTLY INTERCHANGEABLE. REFERENCE NUMBERS, EITHER ORIGINAL OR OF A DIFFERENT NATURE, ARE FOR INFORMATION PURPOSES ONLY WHEN PLACING AN ORDER, PLEASE, ALWAYS USE COSIBO REFERENCE NUMBERS AND DO NOT MENTION THE ORIGINAL REFERENCE NUMBERS OF THE TRUCK MANUFACTURERS IN THE INVOICE TO VEHICLE OWNERS OR TO ANYBODY ELSE. THE CUSTOMER TAKES HIS OWN RESPONSIBILITY IF HE DOES NOT COMPLY WITH WHAT ABOVE.

FRONT RH / REAR LH MUDGUARD



	Code	OEM new	OEM old
● Model	62345	1485486	1408466
★ Application			
● 4 TRUCK			
★ CP 6X2/4 8X2 8X4			
● P-G-R-T TRUCK			
★ STD			

MUDGUARD CLAMP



	Code	OEM new	OEM old
	62442	1390747	
● 4 TRUCK			
★ 4X2 4X4 6X2 6X2/4 6X4 6X6 8X2 8X2/4 8X4 8X4/4 8X6/4 8X8 10X4/6			
● P-G-R-T TRUCK			
★			

LH REAR MUDGUARD BRACKET



	Code	OEM new	OEM old
	64650	1725671	1400899 1457895
● 4 TRUCK			
★ 94 - 114 - 124 - 144 - 164 - M16 - A4X2 - 2 SPRING			
● P-G-R-T TRUCK			
★ M16 - A4X2 - 2 SPRING			

ALL THE COMPONENTS LISTED IN OUR CATALOGUE ARE NOT ORIGINAL, THOUGH PERFECTLY INTERCHANGEABLE. REFERENCE NUMBERS, EITHER ORIGINAL OR OF A DIFFERENT NATURE, ARE FOR INFORMATION PURPOSES ONLY WHEN PLACING AN ORDER, PLEASE, ALWAYS USE COSIBO REFERENCE NUMBERS AND DO NOT MENTION THE ORIGINAL REFERENCE NUMBERS OF THE TRUCK MANUFACTURERS IN THE INVOICE TO VEHICLE OWNERS OR TO ANYBODY ELSE. THE CUSTOMER TAKES HIS OWN RESPONSIBILITY IF HE DOES NOT COMPLY WITH WHAT ABOVE.

RH REAR MUDGUARD BRACKET



● Model

★ Application

Code

OEM new

OEM old

64651

1725672

1400900
1457896

● 4 TRUCK

★ 94 - 114 - 124 - 144 - 164 - M16 - A4X2 - 2 SPRING

● P-G-R-T TRUCK

★ M16 - A4X2 - 2 SPRING

LH REAR MUDGUARD BRACKET



64643

1725675

● 4 TRUCK

★ 94 - 114 - 124 - 144 - 164 - M12 - 2 SPRING

● P-G-R-T TRUCK

★ M12 - 2 SPRING

RH REAR MUDGUARD BRACKET



64644

1725676

● 4 TRUCK

★ 94 - 114 - 124 - 144 - 164 - M12 - 2 SPRING

● P-G-R-T TRUCK

★ M12 - 2 SPRING

LH REAR MUDGUARD BRACKET



● Model

★ Application

Code

OEM new

OEM old

64350

1732855

● 4 TRUCK

★ 94 - 114 - 124 - 144 - 164 - FOR VEHICLE W/O STABILIZER BAR - M16 - 2 MOLLE

● P-G-R-T TRUCK

★ FOR VEHICLE W/O STABILIZER BAR - M16 - 2 SPRING

RH REAR MUDGUARD BRACKET



● 4 TRUCK

★ 94 - 114 - 124 - 144 - 164 - FOR VEHICLE W/O STABILIZER BAR - M16 - 2 SPRING

● P-G-R-T TRUCK

★ FOR VEHICLE W/O STABILIZER BAR/PER VEICOLI SENZA BARRA STABILIZZATRICE - M16 - 2 SPRING/2 MOLLE

64349

1732856

LH REAR MUDGUARD BRACKET SET



● 4 TRUCK

★ 94 - 114 - 124 - 144 - 164 - M16 - A4X2 - 2 SPRINGS

● P-G-R-T TRUCK

★ M16 - A4X2 - 2 SPRINGS

64106

64106

ALL THE COMPONENTS LISTED IN OUR CATALOGUE ARE NOT ORIGINAL, THOUGH PERFECTLY INTERCHANGEABLE. REFERENCE NUMBERS, EITHER ORIGINAL OR OF A DIFFERENT NATURE, ARE FOR INFORMATION PURPOSES ONLY WHEN PLACING AN ORDER, PLEASE, ALWAYS USE COSIBO REFERENCE NUMBERS AND DO NOT MENTION THE ORIGINAL REFERENCE NUMBERS OF THE TRUCK MANUFACTURERS IN THE INVOICE TO VEHICLE OWNERS OR TO ANYBODY ELSE. THE CUSTOMER TAKES HIS OWN RESPONSIBILITY IF HE DOES NOT COMPLY WITH WHAT ABOVE.

RH REAR MUDGUARD BRACKET SET



● Model

★ Application

Code

OEM new

OEM old

64107

64107

● 4 TRUCK

★ 94 - 114 - 124 - 144 - 164 - M16 - A4X2 - 2 SPRINGS

● P-G-R-T TRUCK

★ M16 - A4X2 - 2 SPRINGS

LH BRACKET



63987

1523607

● 4 TRUCK

★ 94 - 114 - 124 - 144 - 164 - M16 - A4X2 - 2 SPRINGS WITHOUT STABILIZER BAR

● P-G-R-T TRUCK

★ M16 - A4X2 - 2 SPRINGS WITHOUT STABILIZER BAR

RH BRACKET



63988

1523608

● 4 TRUCK

★ 94 - 114 - 124 - 144 - 164 - M16 - A4X2 - 2 SPRINGS WITHOUT STABILIZER BAR

● P-G-R-T TRUCK

★ M16 - A4X2 - 2 SPRINGS WITHOUT STABILIZER BAR

LH REAR MUDGUARD BRACKET



63965

1725663

● 4 TRUCK

★ B4X2 2 SPRINGS M16

● P-G-R-T TRUCK

★ B4X2 2 SPRINGS M16

ALL THE COMPONENTS LISTED IN OUR CATALOGUE ARE NOT ORIGINAL, THOUGH PERFECTLY INTERCHANGEABLE. REFERENCE NUMBERS, EITHER ORIGINAL OR OF A DIFFERENT NATURE, ARE FOR INFORMATION PURPOSES ONLY WHEN PLACING AN ORDER, PLEASE, ALWAYS USE COSIBO REFERENCE NUMBERS AND DO NOT MENTION THE ORIGINAL REFERENCE NUMBERS OF THE TRUCK MANUFACTURERS IN THE INVOICE TO VEHICLE OWNERS OR TO ANYBODY ELSE. THE CUSTOMER TAKES HIS OWN RESPONSIBILITY IF HE DOES NOT COMPLY WITH WHAT ABOVE.

	Code	OEM new	OEM old
RH REAR MUDGUARD BRACKET	63964	1725664	
● Model			
★ Application			
● 4 TRUCK			
★ B4X2 2 SPRINGS M16			
● P-G-R-T TRUCK			
★ B4X2 2 SPRINGS M16			



BATTERY COVER ASSY	62384	1785531	1409860 1482405
● 4 TRUCK			
★ CP/CR			
● P-G-R-T TRUCK			
★			



BATTERY COVER RUBBER STRAP	65246	1529552	366595
● 3 BUS			
★			
● 3 TRUCK			
★			
● 4 TRUCK			
★			
● P-G-R-T TRUCK			
★			



	Code	OEM new	OEM old
LH CORNER PANEL	65306	280377	
<ul style="list-style-type: none"> ● Model ★ Application 			
<ul style="list-style-type: none"> ● 3 TRUCK ★ CG/CP CH 1189448 - CH 4322040 			



RH CORNER PANEL	65305	280378	
<ul style="list-style-type: none"> ● 3 TRUCK ★ CG/CP CH 1189448 - CH 4322040 			



LH CORNER PANEL	65308	388305	
<ul style="list-style-type: none"> ● 3 TRUCK ★ CG/CP CH 1189449 - CH 4322041 			



RH CORNER PANEL	65307	388306	
<ul style="list-style-type: none"> ● 3 TRUCK ★ CG/CP CH 1189449 - CH 4322041 			



ALL THE COMPONENTS LISTED IN OUR CATALOGUE ARE NOT ORIGINAL, THOUGH PERFECTLY INTERCHANGEABLE. REFERENCE NUMBERS, EITHER ORIGINAL OR OF A DIFFERENT NATURE, ARE FOR INFORMATION PURPOSES ONLY WHEN PLACING AN ORDER, PLEASE, ALWAYS USE COSIBO REFERENCE NUMBERS AND DO NOT MENTION THE ORIGINAL REFERENCE NUMBERS OF THE TRUCK MANUFACTURERS IN THE INVOICE TO VEHICLE OWNERS OR TO ANYBODY ELSE. THE CUSTOMER TAKES HIS OWN RESPONSIBILITY IF HE DOES NOT COMPLY WITH WHAT ABOVE.

LH AIR CONVEYORS



- Model
- ★ Application

Code	OEM new	OEM old
62100	1370329	

- 4 TRUCK
- ★ CR

RH AIR CONVEYORS



- 4 TRUCK
- ★ CR

62101	1370330	
-------	---------	--

ALL THE COMPONENTS LISTED IN OUR CATALOGUE ARE NOT ORIGINAL, THOUGH PERFECTLY INTERCHANGEABLE. REFERENCE NUMBERS, EITHER ORIGINAL OR OF A DIFFERENT NATURE, ARE FOR INFORMATION PURPOSES ONLY WHEN PLACING AN ORDER, PLEASE, ALWAYS USE COSIBO REFERENCE NUMBERS AND DO NOT MENTION THE ORIGINAL REFERENCE NUMBERS OF THE TRUCK MANUFACTURERS IN THE INVOICE TO VEHICLE OWNERS OR TO ANYBODY ELSE. THE CUSTOMER TAKES HIS OWN RESPONSIBILITY IF HE DOES NOT COMPLY WITH WHAT ABOVE.

LH AIR CONVEYOR CORNER



- Model
- ★ Application

Code	OEM new	OEM old
62431	1381565	

- 4 TRUCK
- ★ CP

RH AIR CONVEYOR CORNER



- 4 TRUCK
- ★ CR

62430	1381566	
-------	---------	--

ALL THE COMPONENTS LISTED IN OUR CATALOGUE ARE NOT ORIGINAL, THOUGH PERFECTLY INTERCHANGEABLE. REFERENCE NUMBERS, EITHER ORIGINAL OR OF A DIFFERENT NATURE, ARE FOR INFORMATION PURPOSES ONLY WHEN PLACING AN ORDER, PLEASE, ALWAYS USE COSIBO REFERENCE NUMBERS AND DO NOT MENTION THE ORIGINAL REFERENCE NUMBERS OF THE TRUCK MANUFACTURERS IN THE INVOICE TO VEHICLE OWNERS OR TO ANYBODY ELSE. THE CUSTOMER TAKES HIS OWN RESPONSIBILITY IF HE DOES NOT COMPLY WITH WHAT ABOVE.

LH AIR CONVEYOR COVER



- Model
- ★ Application

Code	OEM new	OEM old
62429	1382727	

- 4 TRUCK
- ★ CR

RH AIR CONVEYOR COVER



- 4 TRUCK
- ★ CR

62428	1382728	
-------	---------	--

ALL THE COMPONENTS LISTED IN OUR CATALOGUE ARE NOT ORIGINAL, THOUGH PERFECTLY INTERCHANGEABLE. REFERENCE NUMBERS, EITHER ORIGINAL OR OF A DIFFERENT NATURE, ARE FOR INFORMATION PURPOSES ONLY WHEN PLACING AN ORDER, PLEASE, ALWAYS USE COSIBO REFERENCE NUMBERS AND DO NOT MENTION THE ORIGINAL REFERENCE NUMBERS OF THE TRUCK MANUFACTURERS IN THE INVOICE TO VEHICLE OWNERS OR TO ANYBODY ELSE. THE CUSTOMER TAKES HIS OWN RESPONSIBILITY IF HE DOES NOT COMPLY WITH WHAT ABOVE.

LH AIR CONVEYOR



- Model
- ★ Application

Code	OEM new	OEM old
62281	1386957	

- 4 TRUCK
- ★ CP

RH AIR CONVEYOR



- 4 TRUCK
- ★ CP

62282	1537675	1386958
-------	---------	---------

ALL THE COMPONENTS LISTED IN OUR CATALOGUE ARE NOT ORIGINAL, THOUGH PERFECTLY INTERCHANGEABLE. REFERENCE NUMBERS, EITHER ORIGINAL OR OF A DIFFERENT NATURE, ARE FOR INFORMATION PURPOSES ONLY WHEN PLACING AN ORDER, PLEASE, ALWAYS USE COSIBO REFERENCE NUMBERS AND DO NOT MENTION THE ORIGINAL REFERENCE NUMBERS OF THE TRUCK MANUFACTURERS IN THE INVOICE TO VEHICLE OWNERS OR TO ANYBODY ELSE. THE CUSTOMER TAKES HIS OWN RESPONSIBILITY IF HE DOES NOT COMPLY WITH WHAT ABOVE.

LH AIR CONVEYOR CORNER



- Model
- ★ Application

Code	OEM new	OEM old
62446	1386959	

- 4 TRUCK
- ★ CP

RH AIR CONVEYOR CORNER



- 4 TRUCK
- ★ CP

62445	1386960	
-------	---------	--

ALL THE COMPONENTS LISTED IN OUR CATALOGUE ARE NOT ORIGINAL, THOUGH PERFECTLY INTERCHANGEABLE. REFERENCE NUMBERS, EITHER ORIGINAL OR OF A DIFFERENT NATURE, ARE FOR INFORMATION PURPOSES ONLY WHEN PLACING AN ORDER, PLEASE, ALWAYS USE COSIBO REFERENCE NUMBERS AND DO NOT MENTION THE ORIGINAL REFERENCE NUMBERS OF THE TRUCK MANUFACTURERS IN THE INVOICE TO VEHICLE OWNERS OR TO ANYBODY ELSE. THE CUSTOMER TAKES HIS OWN RESPONSIBILITY IF HE DOES NOT COMPLY WITH WHAT ABOVE.

LH AIR CONVEYOR COVER



- Model
- ★ Application

Code	OEM new	OEM old
62448	1370107	

- 4 TRUCK
- ★ CP

RH AIR CONVEYOR COVER



- 4 TRUCK
- ★ CP

62447	1370108	
-------	---------	--

ALL THE COMPONENTS LISTED IN OUR CATALOGUE ARE NOT ORIGINAL, THOUGH PERFECTLY INTERCHANGEABLE. REFERENCE NUMBERS, EITHER ORIGINAL OR OF A DIFFERENT NATURE, ARE FOR INFORMATION PURPOSES ONLY WHEN PLACING AN ORDER, PLEASE, ALWAYS USE COSIBO REFERENCE NUMBERS AND DO NOT MENTION THE ORIGINAL REFERENCE NUMBERS OF THE TRUCK MANUFACTURERS IN THE INVOICE TO VEHICLE OWNERS OR TO ANYBODY ELSE. THE CUSTOMER TAKES HIS OWN RESPONSIBILITY IF HE DOES NOT COMPLY WITH WHAT ABOVE.

LH AIR CONVEYOR SET



● Model

★ Application

Code

OEM new

OEM old

62449

62449

● 4 TRUCK

★ CP COMPOSED BY: NO.1 PC 62281 - NO.1 PC 62448 - NO.1 PC 62446

RH AIR CONVEYOR SET



● 4 TRUCK

★ CP COMPOSED BY: NO.1 PC 62282 - NO.1 PC 62447 - NO.1 PC 62445

62450

62450

LH AIR CONVEYOR SET



● 4 TRUCK

★ CR COMPOSED BY NO.1 PC 62100 - NO.1 PC 62429 - NO.1 PC62431

62498

62498

ALL THE COMPONENTS LISTED IN OUR CATALOGUE ARE NOT ORIGINAL, THOUGH PERFECTLY INTERCHANGEABLE. REFERENCE NUMBERS, EITHER ORIGINAL OR OF A DIFFERENT NATURE, ARE FOR INFORMATION PURPOSES ONLY WHEN PLACING AN ORDER, PLEASE, ALWAYS USE COSIBO REFERENCE NUMBERS AND DO NOT MENTION THE ORIGINAL REFERENCE NUMBERS OF THE TRUCK MANUFACTURERS IN THE INVOICE TO VEHICLE OWNERS OR TO ANYBODY ELSE. THE CUSTOMER TAKES HIS OWN RESPONSIBILITY IF HE DOES NOT COMPLY WITH WHAT ABOVE.

RH AIR CONVEYOR SET



● Model

★ Application

Code

62497

OEM new

62497

OEM old

● 4 TRUCK

★ CR COMPOSED BY NO.1 PC 62101 - NO.1 PC 62428 - NO.1 PC 62430

LH AIR CONVEYORS



62483

1538384

● P-G-R-T TRUCK

★ CG/CR CH 2040738 - CH 5211086 - CH 9135263 - CH 3635259

RH AIR CONVEYORS



	Code	OEM new	OEM old
● Model	62482	1538385	
★ Application			
● P-G-R-T TRUCK			
★	CG/CR CH 2040738 - CH 5211086 - CH 9135263 - CH 3635259		

LH HINGE



	62291	1440108	1381563
● 4 TRUCK			
★	CP/CR		

RH HINGE



	62292	1440113	1381564
● 4 TRUCK			
★	CP/CR		

ALL THE COMPONENTS LISTED IN OUR CATALOGUE ARE NOT ORIGINAL, THOUGH PERFECTLY INTERCHANGEABLE. REFERENCE NUMBERS, EITHER ORIGINAL OR OF A DIFFERENT NATURE, ARE FOR INFORMATION PURPOSES ONLY WHEN PLACING AN ORDER, PLEASE, ALWAYS USE COSIBO REFERENCE NUMBERS AND DO NOT MENTION THE ORIGINAL REFERENCE NUMBERS OF THE TRUCK MANUFACTURERS IN THE INVOICE TO VEHICLE OWNERS OR TO ANYBODY ELSE. THE CUSTOMER TAKES HIS OWN RESPONSIBILITY IF HE DOES NOT COMPLY WITH WHAT ABOVE.

LH AIR CONVEYORS



- Model
- ★ Application

Code	OEM new	OEM old
64207	1543608	

- P-G-R-T TRUCK
- ★ CP

RH CORNER



- P-G-R-T TRUCK
- ★ CP

64208	1543609	
-------	---------	--

ALL THE COMPONENTS LISTED IN OUR CATALOGUE ARE NOT ORIGINAL, THOUGH PERFECTLY INTERCHANGEABLE. REFERENCE NUMBERS, EITHER ORIGINAL OR OF A DIFFERENT NATURE, ARE FOR INFORMATION PURPOSES ONLY WHEN PLACING AN ORDER, PLEASE, ALWAYS USE COSIBO REFERENCE NUMBERS AND DO NOT MENTION THE ORIGINAL REFERENCE NUMBERS OF THE TRUCK MANUFACTURERS IN THE INVOICE TO VEHICLE OWNERS OR TO ANYBODY ELSE. THE CUSTOMER TAKES HIS OWN RESPONSIBILITY IF HE DOES NOT COMPLY WITH WHAT ABOVE.

LH AIR CONVEYOR CORNER



- Model
- ★ Application

Code	OEM new	OEM old
64680	1856475	1495956 1749716 1798863

- P-G-R-T TRUCK

- ★ CG/CR

RH AIR CONVEYOR CORNER



- P-G-R-T TRUCK

- ★ CG/CR

64681	1856474	1495957 1749717 1798864
-------	---------	-------------------------------

ALL THE COMPONENTS LISTED IN OUR CATALOGUE ARE NOT ORIGINAL, THOUGH PERFECTLY INTERCHANGEABLE. REFERENCE NUMBERS, EITHER ORIGINAL OR OF A DIFFERENT NATURE, ARE FOR INFORMATION PURPOSES ONLY WHEN PLACING AN ORDER, PLEASE, ALWAYS USE COSIBO REFERENCE NUMBERS AND DO NOT MENTION THE ORIGINAL REFERENCE NUMBERS OF THE TRUCK MANUFACTURERS IN THE INVOICE TO VEHICLE OWNERS OR TO ANYBODY ELSE. THE CUSTOMER TAKES HIS OWN RESPONSIBILITY IF HE DOES NOT COMPLY WITH WHAT ABOVE.

LH AIR CONVEYOR CORNER



	Code	OEM new	OEM old
● Model	64329	1856473	1496293
★ Application			
● P-G-R-T TRUCK			
★ CP			

RH AIR CONVEYOR CORNER



	Code	OEM new	OEM old
	64330	1856472	1496294
● P-G-R-T TRUCK			
★ CP			

ALL THE COMPONENTS LISTED IN OUR CATALOGUE ARE NOT ORIGINAL, THOUGH PERFECTLY INTERCHANGEABLE. REFERENCE NUMBERS, EITHER ORIGINAL OR OF A DIFFERENT NATURE, ARE FOR INFORMATION PURPOSES ONLY WHEN PLACING AN ORDER, PLEASE, ALWAYS USE COSIBO REFERENCE NUMBERS AND DO NOT MENTION THE ORIGINAL REFERENCE NUMBERS OF THE TRUCK MANUFACTURERS IN THE INVOICE TO VEHICLE OWNERS OR TO ANYBODY ELSE. THE CUSTOMER TAKES HIS OWN RESPONSIBILITY IF HE DOES NOT COMPLY WITH WHAT ABOVE.

LH MUDGUARD PROFILE



● Model

★ Application

Code

OEM new

OEM old

63961

1517649

1429393

● 4 TRUCK

★ CP/CR - 164

● P-G-R-T TRUCK

★ CG/CP/CR

RH MUDGUARD PROFILE



63960

1517650

1429394

● 4 TRUCK

★ CP/CR - 164

● P-G-R-T TRUCK

★ CG/CP/CR

	Code	OEM new	OEM old
RUBBER BUSHING	64114	1355667	
<ul style="list-style-type: none"> ● Model ★ Application 			
<ul style="list-style-type: none"> ● 4 TRUCK 			
<ul style="list-style-type: none"> ★ CP/CR/CT 14/19 - CP/CR 19L - TOPLINE 			
<ul style="list-style-type: none"> ● P-G-R-T TRUCK 			
<ul style="list-style-type: none"> ★ CP/CG/CR/CT NORMAL - LOW - CP/CR/CT LOW - CR19 HIGH - CR/CG HIGH - TOPLINE 			



SUN VISOR	61987	316756	330749
------------------	--------------	--------	--------



<ul style="list-style-type: none"> ● 3 TRUCK 			
<ul style="list-style-type: none"> ★ 			

LH CABIN LIGHT	61602	301843	
-----------------------	--------------	--------	--



<ul style="list-style-type: none"> ● 3 TRUCK 			
<ul style="list-style-type: none"> ★ 			

RH CAB LIGHT	61911	301844	
---------------------	--------------	--------	--



<ul style="list-style-type: none"> ● 3 TRUCK 			
<ul style="list-style-type: none"> ★ 			

ALL THE COMPONENTS LISTED IN OUR CATALOGUE ARE NOT ORIGINAL, THOUGH PERFECTLY INTERCHANGEABLE. REFERENCE NUMBERS, EITHER ORIGINAL OR OF A DIFFERENT NATURE, ARE FOR INFORMATION PURPOSES ONLY WHEN PLACING AN ORDER, PLEASE, ALWAYS USE COSIBO REFERENCE NUMBERS AND DO NOT MENTION THE ORIGINAL REFERENCE NUMBERS OF THE TRUCK MANUFACTURERS IN THE INVOICE TO VEHICLE OWNERS OR TO ANYBODY ELSE. THE CUSTOMER TAKES HIS OWN RESPONSIBILITY IF HE DOES NOT COMPLY WITH WHAT ABOVE.

	Code	OEM new	OEM old
RUBBER PAD	62240	301845	
			
<ul style="list-style-type: none"> ● Model ★ Application 			
<ul style="list-style-type: none"> ● 3 TRUCK ★ 			
SUN VISOR WHITE LIGHT	64069	199846	
			
<ul style="list-style-type: none"> ● 3 TRUCK ★ TOPLINE 			
SUNVISOR WITH 2 LAMPS	62407	1769452	1430533
			
<ul style="list-style-type: none"> ● 4 TRUCK ★ CP/CR/CT14 - CP/CR19L - CP/CR/CT19 ● P-G-R-T TRUCK ★ CG/CP/CR/CT STD - CG/CP/CR/CT LOW 			
SUN VISOR WITH SPOT LAMP HOLES	62496	1539870	1379814
			
<ul style="list-style-type: none"> ● 4 TRUCK ★ 8X8WLS/ZLS CR - CP/CR/CT 14/19 - CP/CR19L ● P-G-R-T TRUCK ★ CP/CR/CT STD AND LOW - CR 19 HIGH 			
SUN VISOR WITHOUT SPOT LAMP HOLES	62550	1539871	1355656
			
<ul style="list-style-type: none"> ● 4 TRUCK ★ 8X8WLS/ZLS CR - CP/CR/CT 14/19 - CP/CR19L ● P-G-R-T TRUCK ★ CP/CR/CT STD AND LOW - CR19 HIGH 			

ALL THE COMPONENTS LISTED IN OUR CATALOGUE ARE NOT ORIGINAL, THOUGH PERFECTLY INTERCHANGEABLE. REFERENCE NUMBERS, EITHER ORIGINAL OR OF A DIFFERENT NATURE, ARE FOR INFORMATION PURPOSES ONLY WHEN PLACING AN ORDER, PLEASE, ALWAYS USE COSIBO REFERENCE NUMBERS AND DO NOT MENTION THE ORIGINAL REFERENCE NUMBERS OF THE TRUCK MANUFACTURERS IN THE INVOICE TO VEHICLE OWNERS OR TO ANYBODY ELSE. THE CUSTOMER TAKES HIS OWN RESPONSIBILITY IF HE DOES NOT COMPLY WITH WHAT ABOVE.

	Code	OEM new	OEM old
SUN VISOR	63733	1355655	
<ul style="list-style-type: none"> ● Model ★ Application 			
<ul style="list-style-type: none"> ● 4 TRUCK 			
<ul style="list-style-type: none"> ★ 8X8WLS/ZLS CR - CP/CR/CT19 - CP/CR14 - CP/CR19L - TOP LINE 			
<ul style="list-style-type: none"> ● P-G-R-T TRUCK 			
<ul style="list-style-type: none"> ★ CP/CR/CT STD AND LOW - CR19 HIGH - CR19H - TOP LINE 			



BLUE LENS SPOT LAMP WITH LED	64684	64684	
-------------------------------------	--------------	-------	--



● 4 TRUCK

★

BLUE SPOT LAMP	62283	62283	
-----------------------	--------------	-------	--



● 4 TRUCK

★

WHITE SUN VISOR LIGHT	62341	1326935	
------------------------------	--------------	---------	--



● 4 TRUCK

★

● P-G-R-T TRUCK

★

ALL THE COMPONENTS LISTED IN OUR CATALOGUE ARE NOT ORIGINAL, THOUGH PERFECTLY INTERCHANGEABLE. REFERENCE NUMBERS, EITHER ORIGINAL OR OF A DIFFERENT NATURE, ARE FOR INFORMATION PURPOSES ONLY WHEN PLACING AN ORDER, PLEASE, ALWAYS USE COSIBO REFERENCE NUMBERS AND DO NOT MENTION THE ORIGINAL REFERENCE NUMBERS OF THE TRUCK MANUFACTURERS IN THE INVOICE TO VEHICLE OWNERS OR TO ANYBODY ELSE. THE CUSTOMER TAKES HIS OWN RESPONSIBILITY IF HE DOES NOT COMPLY WITH WHAT ABOVE.

	Code	OEM new	OEM old
WHITE SUN VISOR LIGHT	64298	1910437	1798980
	<ul style="list-style-type: none"> ● Model ★ Application 		
	<ul style="list-style-type: none"> ● P-G-R-T TRUCK ★ 		
AMBER SUN VISOR LIGHT	64299	1910438	1798981
	<ul style="list-style-type: none"> ● P-G-R-T TRUCK ★ 		
AMBER SUN VISOR LIGHT	64382	1372174	
	<ul style="list-style-type: none"> ● 4 TRUCK ★ ● P-G-R-T TRUCK ★ 		
BULB HOLDER	64348	64348	
	<ul style="list-style-type: none"> ● 4 TRUCK ★ FOR OUR 62341 & 64382 ● P-G-R-T TRUCK ★ FOR OUR 62341 & 64382 		

ALL THE COMPONENTS LISTED IN OUR CATALOGUE ARE NOT ORIGINAL, THOUGH PERFECTLY INTERCHANGEABLE. REFERENCE NUMBERS, EITHER ORIGINAL OR OF A DIFFERENT NATURE, ARE FOR INFORMATION PURPOSES ONLY WHEN PLACING AN ORDER, PLEASE, ALWAYS USE COSIBO REFERENCE NUMBERS AND DO NOT MENTION THE ORIGINAL REFERENCE NUMBERS OF THE TRUCK MANUFACTURERS IN THE INVOICE TO VEHICLE OWNERS OR TO ANYBODY ELSE. THE CUSTOMER TAKES HIS OWN RESPONSIBILITY IF HE DOES NOT COMPLY WITH WHAT ABOVE.

	Code	OEM new	OEM old
SUN VISOR SPOT LAMP	62285	1749953	1379997 584085
● Model			
★ Application			
● 4 TRUCK			
★			
● P-G-R-T TRUCK			
★			



AIR DEFLECTOR	63680	1893533	1730221 1780585 1851989 588002
● 4 TRUCK			
★ 94 - 114 - 124 - 144 - 164 - CP/CR			



	Code	OEM new	OEM old
CLAMP D.6	64082	813933	
<ul style="list-style-type: none"> ● Model ★ Application 			
<ul style="list-style-type: none"> ● 3 BUS ★ 			
<ul style="list-style-type: none"> ● F-K-N BUS ★ 			
<ul style="list-style-type: none"> ● 3 TRUCK ★ 			
<ul style="list-style-type: none"> ● 4 TRUCK ★ 			
<ul style="list-style-type: none"> ● P-G-R-T TRUCK ★ 			



CLAMP D.10	64083	813935	
<ul style="list-style-type: none"> ● 4 BUS ★ 			
<ul style="list-style-type: none"> ● F-K-N BUS ★ 			
<ul style="list-style-type: none"> ● 3 TRUCK ★ 			
<ul style="list-style-type: none"> ● 4 TRUCK ★ 			



CLAMP D. 16	64084	813937	
<ul style="list-style-type: none"> ● 3 BUS ★ 			
<ul style="list-style-type: none"> ● 4 BUS ★ 			
<ul style="list-style-type: none"> ● F-K-N BUS ★ 			
<ul style="list-style-type: none"> ● 3 TRUCK ★ 			



ALL THE COMPONENTS LISTED IN OUR CATALOGUE ARE NOT ORIGINAL, THOUGH PERFECTLY INTERCHANGEABLE. REFERENCE NUMBERS, EITHER ORIGINAL OR OF A DIFFERENT NATURE, ARE FOR INFORMATION PURPOSES ONLY WHEN PLACING AN ORDER, PLEASE, ALWAYS USE COSIBO REFERENCE NUMBERS AND DO NOT MENTION THE ORIGINAL REFERENCE NUMBERS OF THE TRUCK MANUFACTURERS IN THE INVOICE TO VEHICLE OWNERS OR TO ANYBODY ELSE. THE CUSTOMER TAKES HIS OWN RESPONSIBILITY IF HE DOES NOT COMPLY WITH WHAT ABOVE.

	Code	OEM new	OEM old
CLAMP D.20	64085	813939	
	<ul style="list-style-type: none"> ● Model ★ Application 		
	<ul style="list-style-type: none"> ● 4 BUS ★ 		
	<ul style="list-style-type: none"> ● F-K-N BUS ★ 		
	<ul style="list-style-type: none"> ● 3 TRUCK ★ 		
	<ul style="list-style-type: none"> ● P-G-R-T TRUCK ★ 		

CLAMP D.25	64086	813941	
	<ul style="list-style-type: none"> ● 3 BUS ★ 		
	<ul style="list-style-type: none"> ● 4 BUS ★ 		
	<ul style="list-style-type: none"> ● F-K-N BUS ★ 		
	<ul style="list-style-type: none"> ● 3 TRUCK ★ 		
	<ul style="list-style-type: none"> ● P-G-R-T TRUCK ★ 		

ALL THE COMPONENTS LISTED IN OUR CATALOGUE ARE NOT ORIGINAL, THOUGH PERFECTLY INTERCHANGEABLE. REFERENCE NUMBERS, EITHER ORIGINAL OR OF A DIFFERENT NATURE, ARE FOR INFORMATION PURPOSES ONLY WHEN PLACING AN ORDER, PLEASE, ALWAYS USE COSIBO REFERENCE NUMBERS AND DO NOT MENTION THE ORIGINAL REFERENCE NUMBERS OF THE TRUCK MANUFACTURERS IN THE INVOICE TO VEHICLE OWNERS OR TO ANYBODY ELSE. THE CUSTOMER TAKES HIS OWN RESPONSIBILITY IF HE DOES NOT COMPLY WITH WHAT ABOVE.

		Code	OEM new	OEM old
CLAMP D.5	● Model	64089	813932	
	★ Application			
	● 3 BUS			
	★			
	● 4 BUS			
	★			
	● F-K-N BUS			
	★			
	● 4 TRUCK			
	★			
● P-G-R-T TRUCK				
★				



CLAMP D.8		64090	813934	
	● F-K-N BUS			
	★			
	● 3 TRUCK			
	★			
	● 4 TRUCK			
	★			



ALL THE COMPONENTS LISTED IN OUR CATALOGUE ARE NOT ORIGINAL, THOUGH PERFECTLY INTERCHANGEABLE. REFERENCE NUMBERS, EITHER ORIGINAL OR OF A DIFFERENT NATURE, ARE FOR INFORMATION PURPOSES ONLY WHEN PLACING AN ORDER, PLEASE, ALWAYS USE COSIBO REFERENCE NUMBERS AND DO NOT MENTION THE ORIGINAL REFERENCE NUMBERS OF THE TRUCK MANUFACTURERS IN THE INVOICE TO VEHICLE OWNERS OR TO ANYBODY ELSE. THE CUSTOMER TAKES HIS OWN RESPONSIBILITY IF HE DOES NOT COMPLY WITH WHAT ABOVE.

	Code	OEM new	OEM old
CLAMP D.13	64091	813936	
● Model			
★ Application			
● 3 BUS			
★			
● 4 BUS			
★			
● F-K-N BUS			
★			
● 3 TRUCK			
★			
● 4 TRUCK			
★			
● P-G-R-T TRUCK			
★			



	Code	OEM new	OEM old
CLAMP D.18	64092	813938	
● 4 BUS			
★			
● F-K-N BUS			
★			
● 3 TRUCK			
★			
● 4 TRUCK			
★			



ALL THE COMPONENTS LISTED IN OUR CATALOGUE ARE NOT ORIGINAL, THOUGH PERFECTLY INTERCHANGEABLE. REFERENCE NUMBERS, EITHER ORIGINAL OR OF A DIFFERENT NATURE, ARE FOR INFORMATION PURPOSES ONLY WHEN PLACING AN ORDER, PLEASE, ALWAYS USE COSIBO REFERENCE NUMBERS AND DO NOT MENTION THE ORIGINAL REFERENCE NUMBERS OF THE TRUCK MANUFACTURERS IN THE INVOICE TO VEHICLE OWNERS OR TO ANYBODY ELSE. THE CUSTOMER TAKES HIS OWN RESPONSIBILITY IF HE DOES NOT COMPLY WITH WHAT ABOVE.

	Code	OEM new	OEM old
CLAMP D.22	64093	813940	
<ul style="list-style-type: none"> ● Model ★ Application 			
<ul style="list-style-type: none"> ● 4 BUS ★ 			
<ul style="list-style-type: none"> ● F-K-N BUS ★ 			
<ul style="list-style-type: none"> ● 3 TRUCK ★ 			
<ul style="list-style-type: none"> ● P-G-R-T TRUCK ★ 			



CLAMP D. 45	64094	813942	
<ul style="list-style-type: none"> ● 3 BUS ★ 			
<ul style="list-style-type: none"> ● F-K-N BUS ★ 			
<ul style="list-style-type: none"> ● 3 TRUCK ★ 			



CLAMP D.28	64095	804578	
<ul style="list-style-type: none"> ● F-K-N BUS ★ 			
<ul style="list-style-type: none"> ● 3 TRUCK ★ 			



ALL THE COMPONENTS LISTED IN OUR CATALOGUE ARE NOT ORIGINAL, THOUGH PERFECTLY INTERCHANGEABLE. REFERENCE NUMBERS, EITHER ORIGINAL OR OF A DIFFERENT NATURE, ARE FOR INFORMATION PURPOSES ONLY WHEN PLACING AN ORDER, PLEASE, ALWAYS USE COSIBO REFERENCE NUMBERS AND DO NOT MENTION THE ORIGINAL REFERENCE NUMBERS OF THE TRUCK MANUFACTURERS IN THE INVOICE TO VEHICLE OWNERS OR TO ANYBODY ELSE. THE CUSTOMER TAKES HIS OWN RESPONSIBILITY IF HE DOES NOT COMPLY WITH WHAT ABOVE.

	Code	OEM new	OEM old
CLAMP D.35	64096	804589	
<ul style="list-style-type: none"> ● Model ★ Application 			
<ul style="list-style-type: none"> ● 4 BUS ★ 			
<ul style="list-style-type: none"> ● F-K-N BUS ★ 			
<ul style="list-style-type: none"> ● 3 TRUCK ★ 			
<ul style="list-style-type: none"> ● 4 TRUCK ★ 			



CLAMP D.32	64100	804583	
<ul style="list-style-type: none"> ● 4 BUS ★ 			
<ul style="list-style-type: none"> ● F-K-N BUS ★ 			
<ul style="list-style-type: none"> ● 3 TRUCK ★ 			
<ul style="list-style-type: none"> ● 4 TRUCK ★ 			
<ul style="list-style-type: none"> ● P-G-R-T TRUCK ★ 			



CLAMP D.38	64101	804591	
<ul style="list-style-type: none"> ● 4 BUS ★ 			
<ul style="list-style-type: none"> ● F-K-N BUS ★ 			
<ul style="list-style-type: none"> ● 3 TRUCK ★ 			



ALL THE COMPONENTS LISTED IN OUR CATALOGUE ARE NOT ORIGINAL, THOUGH PERFECTLY INTERCHANGEABLE. REFERENCE NUMBERS, EITHER ORIGINAL OR OF A DIFFERENT NATURE, ARE FOR INFORMATION PURPOSES ONLY WHEN PLACING AN ORDER, PLEASE, ALWAYS USE COSIBO REFERENCE NUMBERS AND DO NOT MENTION THE ORIGINAL REFERENCE NUMBERS OF THE TRUCK MANUFACTURERS IN THE INVOICE TO VEHICLE OWNERS OR TO ANYBODY ELSE. THE CUSTOMER TAKES HIS OWN RESPONSIBILITY IF HE DOES NOT COMPLY WITH WHAT ABOVE.

AIR PRESSUR GAUGE 0 - 12 BAR



- Model
 - ★ Application
- | | Code | OEM new | OEM old |
|--|--------------|---------|---------|
| | 62436 | 62436 | |
- ALL VEHICLES
 - ★ ALL VEHICLES

TIRE INFLATING GUN



- | | | | |
|--|--------------|-------|--|
| | 65381 | 65381 | |
|--|--------------|-------|--|
- ALL VEHICLES
 - ★ ALL VEHICLES

CAB LIFTING PUMP



	Code	OEM new	OEM old
● Model	62346	1549740	1422640
★ Application			1534976

● 4 TRUCK
★ OSC11 G03 - CP/CR NORMAL/LOW - CR HIGH(TOPLINE) - CR 19T
● P-G-R-T TRUCK
★ CP/CR 19 NORMAL/LOW - CP/CR 16

CAB LIFTING PUMP



	62356	1314653	
--	--------------	---------	--

● 3 TRUCK
★ STREAMLINE LHD

CAB LIFTING PUMP



	62406	1375497	1349010
--	--------------	---------	---------

● 4 TRUCK
★ 94 - 114 - 124 - 144 - 164

ALL THE COMPONENTS LISTED IN OUR CATALOGUE ARE NOT ORIGINAL, THOUGH PERFECTLY INTERCHANGEABLE. REFERENCE NUMBERS, EITHER ORIGINAL OR OF A DIFFERENT NATURE, ARE FOR INFORMATION PURPOSES ONLY WHEN PLACING AN ORDER, PLEASE, ALWAYS USE COSIBO REFERENCE NUMBERS AND DO NOT MENTION THE ORIGINAL REFERENCE NUMBERS OF THE TRUCK MANUFACTURERS IN THE INVOICE TO VEHICLE OWNERS OR TO ANYBODY ELSE. THE CUSTOMER TAKES HIS OWN RESPONSIBILITY IF HE DOES NOT COMPLY WITH WHAT ABOVE.

	Code	OEM new	OEM old
CAB LIFTING PUMP	64110	1549741	
<ul style="list-style-type: none"> ● Model ★ Application 			
<ul style="list-style-type: none"> ● 4 TRUCK 			
<ul style="list-style-type: none"> ★ CR HIGH TOPOLINE - CR 19T 			
<ul style="list-style-type: none"> ● P-G-R-T TRUCK 			
<ul style="list-style-type: none"> ★ CR 19 			



CAB LIFTING PUMP	65073	1378527	368926
<ul style="list-style-type: none"> ● 3 TRUCK 			
<ul style="list-style-type: none"> ★ 4 POINTS 			



CAB LIFTING PUMP	65074	1378531	383524
<ul style="list-style-type: none"> ● 3 TRUCK 			
<ul style="list-style-type: none"> ★ 2 POINTS 			



ALL THE COMPONENTS LISTED IN OUR CATALOGUE ARE NOT ORIGINAL, THOUGH PERFECTLY INTERCHANGEABLE. REFERENCE NUMBERS, EITHER ORIGINAL OR OF A DIFFERENT NATURE, ARE FOR INFORMATION PURPOSES ONLY WHEN PLACING AN ORDER, PLEASE, ALWAYS USE COSIBO REFERENCE NUMBERS AND DO NOT MENTION THE ORIGINAL REFERENCE NUMBERS OF THE TRUCK MANUFACTURERS IN THE INVOICE TO VEHICLE OWNERS OR TO ANYBODY ELSE. THE CUSTOMER TAKES HIS OWN RESPONSIBILITY IF HE DOES NOT COMPLY WITH WHAT ABOVE.

CAB TILT.PUMP REP.KIT



	Code	OEM new	OEM old
● Model	62315	1320457	1105809
★ Application			
● 3 TRUCK			
★	2 POINTS AND 4 POINTS CABIN - STREAMLINE - ALSO FOR RHD CH 1180589 - CH 4313040		
● 4 TRUCK			
★			

CAB TILT.PUMP REP.KIT

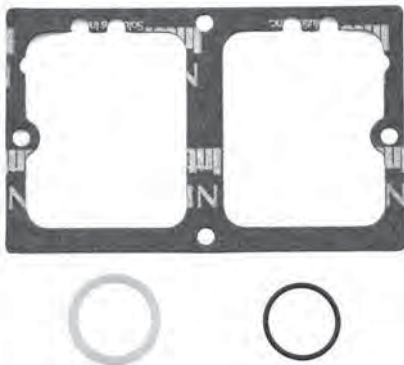

	Code	OEM new	OEM old
	63938	1427794	
● 4 TRUCK			
★	TO REPAIR OUR REFERENCES 62346 - 62356 - 65073 - 65074		
● P-G-R-T TRUCK			
★	TO REPAIR OUR REFERENCES 62346 - 62356 - 65073 - 65074		

CAB TILT.PUMP REP.KIT



	Code	OEM new	OEM old
	63942	1541984	1427793
● 3 TRUCK			
★	4 POINTS CABIN - STREAMLINE - ALSO FOR RHD CH 1180589 - CH 4313040 - CH 1256268 - 1292232 - TO REPAIR OUR REFERENCES 62346 - 62356 - 65073		
● 4 TRUCK			
★	CH 1256268 - 1292232 - TO REPAIR OUR REFERENCES 62346 - 62356 - 65073		
● P-G-R-T TRUCK			
★			

ALL THE COMPONENTS LISTED IN OUR CATALOGUE ARE NOT ORIGINAL, THOUGH PERFECTLY INTERCHANGEABLE. REFERENCE NUMBERS, EITHER ORIGINAL OR OF A DIFFERENT NATURE, ARE FOR INFORMATION PURPOSES ONLY WHEN PLACING AN ORDER, PLEASE, ALWAYS USE COSIBO REFERENCE NUMBERS AND DO NOT MENTION THE ORIGINAL REFERENCE NUMBERS OF THE TRUCK MANUFACTURERS IN THE INVOICE TO VEHICLE OWNERS OR TO ANYBODY ELSE. THE CUSTOMER TAKES HIS OWN RESPONSIBILITY IF HE DOES NOT COMPLY WITH WHAT ABOVE.

CABIN LIFTING CYLINDER



	Code	OEM new	OEM old
● Model ★ Application	65316	1549739	1517325
● 4 TRUCK			
★ CP			
● P-G-R-T TRUCK			
★ CP/CG/CR			

CAB LIFTING CYLINDER REPAIR KIT

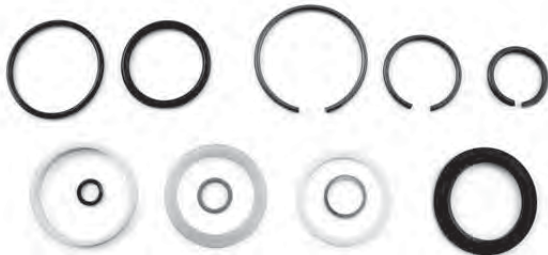

	62334	1105803	
● 3 TRUCK			
★			

REP. KIT FOR CAB TILTING HYDR.CYL.



	62314	385840	
● 3 TRUCK			
★			

ALL THE COMPONENTS LISTED IN OUR CATALOGUE ARE NOT ORIGINAL, THOUGH PERFECTLY INTERCHANGEABLE. REFERENCE NUMBERS, EITHER ORIGINAL OR OF A DIFFERENT NATURE, ARE FOR INFORMATION PURPOSES ONLY WHEN PLACING AN ORDER, PLEASE, ALWAYS USE COSIBO REFERENCE NUMBERS AND DO NOT MENTION THE ORIGINAL REFERENCE NUMBERS OF THE TRUCK MANUFACTURERS IN THE INVOICE TO VEHICLE OWNERS OR TO ANYBODY ELSE. THE CUSTOMER TAKES HIS OWN RESPONSIBILITY IF HE DOES NOT COMPLY WITH WHAT ABOVE.

CAB LIFTING CYLINDER REPAIR KIT



- Model
- ★ Application

Code

OEM new

OEM old

62455

1369053

- 4 TRUCK

- ★

CAB LIFTING CYLINDER REPAIR KIT



- 4 TRUCK

- ★

- P-G-R-T TRUCK

- ★

62456

1433656

CAB LIFTING CYLINDER REPAIR KIT



- 4 TRUCK

- ★

- P-G-R-T TRUCK

- ★

62457

1541982

1433655

ALL THE COMPONENTS LISTED IN OUR CATALOGUE ARE NOT ORIGINAL, THOUGH PERFECTLY INTERCHANGEABLE. REFERENCE NUMBERS, EITHER ORIGINAL OR OF A DIFFERENT NATURE, ARE FOR INFORMATION PURPOSES ONLY WHEN PLACING AN ORDER, PLEASE, ALWAYS USE COSIBO REFERENCE NUMBERS AND DO NOT MENTION THE ORIGINAL REFERENCE NUMBERS OF THE TRUCK MANUFACTURERS IN THE INVOICE TO VEHICLE OWNERS OR TO ANYBODY ELSE. THE CUSTOMER TAKES HIS OWN RESPONSIBILITY IF HE DOES NOT COMPLY WITH WHAT ABOVE.

	Code	OEM new	OEM old
CAB LIFTING CYLINDER REPAIR KIT	62458	1541983	1433654
 <ul style="list-style-type: none"> ● Model ★ Application 			
<ul style="list-style-type: none"> ● 4 TRUCK ★ 			
<ul style="list-style-type: none"> ● P-G-R-T TRUCK ★ 			

CAB LIFTING CYLINDER REPAIR KIT	62477	1524337	1501180
 <ul style="list-style-type: none"> ● 4 TRUCK ★ 			
<ul style="list-style-type: none"> ● P-G-R-T TRUCK ★ 			

CABIN LIFTING CYLINDER	62357	1549738	1466506 1517324
 <ul style="list-style-type: none"> ● 4 TRUCK ★ CR 			
<ul style="list-style-type: none"> ● P-G-R-T TRUCK ★ CP/CG/CR 			

CABIN LIFTING CYLINDER	62476	1720924	
 <ul style="list-style-type: none"> ● P-G-R-T TRUCK ★ CP/CG/CR - CR 19 			

ALL THE COMPONENTS LISTED IN OUR CATALOGUE ARE NOT ORIGINAL, THOUGH PERFECTLY INTERCHANGEABLE. REFERENCE NUMBERS, EITHER ORIGINAL OR OF A DIFFERENT NATURE, ARE FOR INFORMATION PURPOSES ONLY WHEN PLACING AN ORDER, PLEASE, ALWAYS USE COSIBO REFERENCE NUMBERS AND DO NOT MENTION THE ORIGINAL REFERENCE NUMBERS OF THE TRUCK MANUFACTURERS IN THE INVOICE TO VEHICLE OWNERS OR TO ANYBODY ELSE. THE CUSTOMER TAKES HIS OWN RESPONSIBILITY IF HE DOES NOT COMPLY WITH WHAT ABOVE.

	Code	OEM new	OEM old
CABIN LIFTING CYLINDER	64711	1549737	1477876
<ul style="list-style-type: none"> ● Model ★ Application 			
<ul style="list-style-type: none"> ● 4 TRUCK ★ CR HIGH(TOPLINE) CH 1922233 - CH 4501310 - CH 9083649 - CH 3548541 			



CAB LIFTING LEVER	65317	1386571	
<ul style="list-style-type: none"> ● 4 TRUCK ★ CP/CR LHD/RHD - 8X8 WLS 			
<ul style="list-style-type: none"> ● P-G-R-T TRUCK ★ CG/CP/CR 			



CAB LIFTING LEVER	65318	1325626	
<ul style="list-style-type: none"> ● 3 BUS ★ 			
<ul style="list-style-type: none"> ● 4 BUS ★ 			
<ul style="list-style-type: none"> ● F-K-N BUS ★ 			
<ul style="list-style-type: none"> ● 3 TRUCK ★ 			
<ul style="list-style-type: none"> ● 4 TRUCK ★ 			
<ul style="list-style-type: none"> ● P-G-R-T TRUCK ★ 			





VIBRATION BUSHING	66584	1357380	
<ul style="list-style-type: none"> ● 4 TRUCK ★ CP/CR - CR HIGH (TOPLINE) 			
<ul style="list-style-type: none"> ● P-G-R-T TRUCK ★ CP/CG/CR 			



ALL THE COMPONENTS LISTED IN OUR CATALOGUE ARE NOT ORIGINAL, THOUGH PERFECTLY INTERCHANGEABLE. REFERENCE NUMBERS, EITHER ORIGINAL OR OF A DIFFERENT NATURE, ARE FOR INFORMATION PURPOSES ONLY WHEN PLACING AN ORDER, PLEASE, ALWAYS USE COSIBO REFERENCE NUMBERS AND DO NOT MENTION THE ORIGINAL REFERENCE NUMBERS OF THE TRUCK MANUFACTURERS IN THE INVOICE TO VEHICLE OWNERS OR TO ANYBODY ELSE. THE CUSTOMER TAKES HIS OWN RESPONSIBILITY IF HE DOES NOT COMPLY WITH WHAT ABOVE.

		Code	OEM new	OEM old
ADAPTOR	● Model	60361	1804064	1768694
	★ Application			
				
● 4 TRUCK				
★ OSC11 G03 - CP/CR NORMAL/LOW - CR HIGH(TOPLINE) - CR 19T				
● P-G-R-T TRUCK				
★ CP/CR 19 NORMAL/LOW - CP/CR 16				

CABIN HOSE		62324/1	1526569	1371200
				
● 4 TRUCK				
★ CP/CR STD LOW - CR HIGH TOPLINE - 8X4				

CABIN HOSE		62324/2	1526571	1371207
				
● 4 TRUCK				
★ CP/CR STD LOW - CR HIGH TOPLINE - 8X4				

CABIN HOSE		62324/3	1851213	1371208 1526572
				
● 4 TRUCK				
★ CP/CR STD LOW - CR HIGH TOPLINE - 8X4				

ALL THE COMPONENTS LISTED IN OUR CATALOGUE ARE NOT ORIGINAL, THOUGH PERFECTLY INTERCHANGEABLE. REFERENCE NUMBERS, EITHER ORIGINAL OR OF A DIFFERENT NATURE, ARE FOR INFORMATION PURPOSES ONLY WHEN PLACING AN ORDER, PLEASE, ALWAYS USE COSIBO REFERENCE NUMBERS AND DO NOT MENTION THE ORIGINAL REFERENCE NUMBERS OF THE TRUCK MANUFACTURERS IN THE INVOICE TO VEHICLE OWNERS OR TO ANYBODY ELSE. THE CUSTOMER TAKES HIS OWN RESPONSIBILITY IF HE DOES NOT COMPLY WITH WHAT ABOVE.

CABIN HOSE



	Code	OEM new	OEM old
● Model	62324/4	1371201	1526570
★ Application			

- **4 TRUCK**
- ★ CP/CR STD LOW - CR HIGH TOPLINE - 8X4

CABIN HOSE



	62324/5	1526573	1426339
--	----------------	---------	---------

- **4 TRUCK**
- ★ CP/CR STD LOW - CR HIGH TOPLINE - 8X4

CABIN HOSE SET



	62324	62324	
--	--------------	-------	--

- **4 TRUCK**
- ★ CP/CR STD LOW - CR HIGH TOPLINE - 8X4 COMPOSED BY: NO.1 PC 62324/1 - NO.1 PC 62324/2 - NO.1 PC 62324/3 - NO.1 PC 62324/4 - NO.1 PC 62324/5

ALL THE COMPONENTS LISTED IN OUR CATALOGUE ARE NOT ORIGINAL, THOUGH PERFECTLY INTERCHANGEABLE. REFERENCE NUMBERS, EITHER ORIGINAL OR OF A DIFFERENT NATURE, ARE FOR INFORMATION PURPOSES ONLY WHEN PLACING AN ORDER, PLEASE, ALWAYS USE COSIBO REFERENCE NUMBERS AND DO NOT MENTION THE ORIGINAL REFERENCE NUMBERS OF THE TRUCK MANUFACTURERS IN THE INVOICE TO VEHICLE OWNERS OR TO ANYBODY ELSE. THE CUSTOMER TAKES HIS OWN RESPONSIBILITY IF HE DOES NOT COMPLY WITH WHAT ABOVE.





RUBBER HOSE



- Model
 - ★ Application
-
- P-G-R-T TRUCK
 - ★ CG/CP/CR

Code	OEM new	OEM old
64356	1790071	

ALL THE COMPONENTS LISTED IN OUR CATALOGUE ARE NOT ORIGINAL, THOUGH PERFECTLY INTERCHANGEABLE. REFERENCE NUMBERS, EITHER ORIGINAL OR OF A DIFFERENT NATURE, ARE FOR INFORMATION PURPOSES ONLY WHEN PLACING AN ORDER, PLEASE, ALWAYS USE COSIBO REFERENCE NUMBERS AND DO NOT MENTION THE ORIGINAL REFERENCE NUMBERS OF THE TRUCK MANUFACTURERS IN THE INVOICE TO VEHICLE OWNERS OR TO ANYBODY ELSE. THE CUSTOMER TAKES HIS OWN RESPONSIBILITY IF HE DOES NOT COMPLY WITH WHAT ABOVE.

	Code	OEM new	OEM old
<p>WIPER BLADE</p> 	63866	1742920	1323416
<ul style="list-style-type: none"> ● Model ★ Application 			
<ul style="list-style-type: none"> ● 3 TRUCK ★ 			
<p>WIPER BLADE</p> 	63882	1541106	1431178
<ul style="list-style-type: none"> ● 4 TRUCK ★ 			
<ul style="list-style-type: none"> ● P-G-R-T TRUCK ★ 			
<p>WIPER ARM</p> 	64373	1864620	1380034 1431177 1543076 1751403
<ul style="list-style-type: none"> ● 4 TRUCK ★ CP/CR/CT 			
<ul style="list-style-type: none"> ● P-G-R-T TRUCK ★ 			
<p>WINDSCREEN WIPER LEVER HOUSING</p> 	62376	1323400	
<ul style="list-style-type: none"> ● 3 TRUCK ★ STREAMLINE 			

ALL THE COMPONENTS LISTED IN OUR CATALOGUE ARE NOT ORIGINAL, THOUGH PERFECTLY INTERCHANGEABLE. REFERENCE NUMBERS, EITHER ORIGINAL OR OF A DIFFERENT NATURE, ARE FOR INFORMATION PURPOSES ONLY WHEN PLACING AN ORDER, PLEASE, ALWAYS USE COSIBO REFERENCE NUMBERS AND DO NOT MENTION THE ORIGINAL REFERENCE NUMBERS OF THE TRUCK MANUFACTURERS IN THE INVOICE TO VEHICLE OWNERS OR TO ANYBODY ELSE. THE CUSTOMER TAKES HIS OWN RESPONSIBILITY IF HE DOES NOT COMPLY WITH WHAT ABOVE.

	Code	OEM new	OEM old
WINDSCREEN WIPER LEVER	62377	1323410	
<ul style="list-style-type: none"> ● Model ★ Application 			
<ul style="list-style-type: none"> ● 3 TRUCK ★ STREAMLINE 			



WINDSCREEN WIPER LINK ASSY	62372	1323401	
<ul style="list-style-type: none"> ● 3 TRUCK ★ STREAMLINE 			



WINDSCREEN WIPER LINK	62373	1353735	
<ul style="list-style-type: none"> ● 3 TRUCK ★ STREAMLINE 			



WINDSCREEN WIPER LINK	63365	288212	
<ul style="list-style-type: none"> ● 2 TRUCK ★ 92 - 112 - 142 ● 3 TRUCK ★ 93 - 113 - 143 1ST SERIES 			



WINDSCREEN WIPER LINK	63366	288213	
<ul style="list-style-type: none"> ● 2 TRUCK ★ 92 - 112 - 142 ● 3 TRUCK ★ 93 - 113 - 143 1ST SERIES 			



ALL THE COMPONENTS LISTED IN OUR CATALOGUE ARE NOT ORIGINAL, THOUGH PERFECTLY INTERCHANGEABLE. REFERENCE NUMBERS, EITHER ORIGINAL OR OF A DIFFERENT NATURE, ARE FOR INFORMATION PURPOSES ONLY WHEN PLACING AN ORDER, PLEASE, ALWAYS USE COSIBO REFERENCE NUMBERS AND DO NOT MENTION THE ORIGINAL REFERENCE NUMBERS OF THE TRUCK MANUFACTURERS IN THE INVOICE TO VEHICLE OWNERS OR TO ANYBODY ELSE. THE CUSTOMER TAKES HIS OWN RESPONSIBILITY IF HE DOES NOT COMPLY WITH WHAT ABOVE.

WINDSCREEN WIPER LINK



- Model
- ★ Application

Code	OEM new	OEM old
63367	288214	

- **2 TRUCK**
- ★ 92 - 112 - 142
- **3 TRUCK**
- ★ 93 - 113 - 143 1ST SERIES

LH WINDSCREEN WIPER LEVER HOUSING



- **2 TRUCK**
- ★ 92 - 112 - 142
- **3 TRUCK**
- ★ 93 - 113 - 143 1ST SERIES

62370	375904	288208
--------------	--------	--------

RH WINDSCREEN WIPER LEVER HOUSING



- **2 TRUCK**
- ★ 92 - 112 - 142
- **3 TRUCK**
- ★ 93 - 113 - 143 1ST SERIES

62369	375903	288207
--------------	--------	--------

ALL THE COMPONENTS LISTED IN OUR CATALOGUE ARE NOT ORIGINAL, THOUGH PERFECTLY INTERCHANGEABLE. REFERENCE NUMBERS, EITHER ORIGINAL OR OF A DIFFERENT NATURE, ARE FOR INFORMATION PURPOSES ONLY WHEN PLACING AN ORDER, PLEASE, ALWAYS USE COSIBO REFERENCE NUMBERS AND DO NOT MENTION THE ORIGINAL REFERENCE NUMBERS OF THE TRUCK MANUFACTURERS IN THE INVOICE TO VEHICLE OWNERS OR TO ANYBODY ELSE. THE CUSTOMER TAKES HIS OWN RESPONSIBILITY IF HE DOES NOT COMPLY WITH WHAT ABOVE.

CENTAL WINDSCREEN WIPER LEVER HOUSING



	Code	OEM new	OEM old
● Model	62371	375905	288209
★ Application			
● 2 TRUCK			
★ 92 - 112 - 142			
● 3 TRUCK			
★ 93 - 113 - 143 1ST SERIES			

WINDSCREEN WIPER LINK



	63362	1525890	1358288
● 4 TRUCK			
★ CP/CR/CT 94 - 114 - 124 - 144 - 164			
● P-G-R-T TRUCK			
★			

WINDSCREEN WIPER LINK



	63363	1525888	1358289
● 4 TRUCK			
★ CP/CR/CT 94 - 114 - 124 - 144 - 164			
● P-G-R-T TRUCK			
★			

WINDSCREEN WIPER LINK (FOR RIGHT HAND DRIVE)



	63364	1525889	1358290
● 4 TRUCK			
★ CP/CR/CT 94 - 114 - 124 - 144 - 164			
● P-G-R-T TRUCK			
★			

ALL THE COMPONENTS LISTED IN OUR CATALOGUE ARE NOT ORIGINAL, THOUGH PERFECTLY INTERCHANGEABLE. REFERENCE NUMBERS, EITHER ORIGINAL OR OF A DIFFERENT NATURE, ARE FOR INFORMATION PURPOSES ONLY WHEN PLACING AN ORDER, PLEASE, ALWAYS USE COSIBO REFERENCE NUMBERS AND DO NOT MENTION THE ORIGINAL REFERENCE NUMBERS OF THE TRUCK MANUFACTURERS IN THE INVOICE TO VEHICLE OWNERS OR TO ANYBODY ELSE. THE CUSTOMER TAKES HIS OWN RESPONSIBILITY IF HE DOES NOT COMPLY WITH WHAT ABOVE.

WINDSCREEN WIPER LEVER



	Code	OEM new	OEM old
● Model	62375	1358291	1525887
★ Application			
● 4 TRUCK			
★ CP/CR/CT 94 - 114 - 124 - 144 - 164			
● P-G-R-T TRUCK			
★			

LH WINDSCREEN WIPER LEVER HOUSING



	Code	OEM new	OEM old
	63761	1525891	1337957
● 4 TRUCK			
★ CP/CR/CT 94 - 114 - 124 - 144 - 164			
● P-G-R-T TRUCK			
★			

RH WINDSCREEN WIPER LEVER HOUSING



	Code	OEM new	OEM old
	62374	1525892	1337958
● 4 TRUCK			
★ CP/CR/CT 94 - 114 - 124 - 144 - 164			
● P-G-R-T TRUCK			
★			

ALL THE COMPONENTS LISTED IN OUR CATALOGUE ARE NOT ORIGINAL, THOUGH PERFECTLY INTERCHANGEABLE. REFERENCE NUMBERS, EITHER ORIGINAL OR OF A DIFFERENT NATURE, ARE FOR INFORMATION PURPOSES ONLY WHEN PLACING AN ORDER, PLEASE, ALWAYS USE COSIBO REFERENCE NUMBERS AND DO NOT MENTION THE ORIGINAL REFERENCE NUMBERS OF THE TRUCK MANUFACTURERS IN THE INVOICE TO VEHICLE OWNERS OR TO ANYBODY ELSE. THE CUSTOMER TAKES HIS OWN RESPONSIBILITY IF HE DOES NOT COMPLY WITH WHAT ABOVE.

WASHER TANK



	Code	OEM new	OEM old
● Model	64722	1722694	1506330
★ Application			
● 4 TRUCK			
★ CP/CR/CT			

CAP



	62512	1371839	295960
● 3 TRUCK			
★			
● 4 BUS			
★ CL/CN			
● 4 TRUCK			
★ CP/CR/CT			
● F-K-N BUS			
★ CK/CNUB - CN UD - IKIB			
● P-G-R-T TRUCK			
★			

WINDSCREEN WASHER PUMP



	64509	1395994	353546
● 3 TRUCK			
★			
● 4 BUS			
★ CL/CN			
● F-K-N BUS			
★ CK/CNUB/CNUD - IKIB			

ALL THE COMPONENTS LISTED IN OUR CATALOGUE ARE NOT ORIGINAL, THOUGH PERFECTLY INTERCHANGEABLE. REFERENCE NUMBERS, EITHER ORIGINAL OR OF A DIFFERENT NATURE, ARE FOR INFORMATION PURPOSES ONLY WHEN PLACING AN ORDER, PLEASE, ALWAYS USE COSIBO REFERENCE NUMBERS AND DO NOT MENTION THE ORIGINAL REFERENCE NUMBERS OF THE TRUCK MANUFACTURERS IN THE INVOICE TO VEHICLE OWNERS OR TO ANYBODY ELSE. THE CUSTOMER TAKES HIS OWN RESPONSIBILITY IF HE DOES NOT COMPLY WITH WHAT ABOVE.

WINDSCREEN WASHER PUMP



	Code	OEM new	OEM old
● Model	62475	1548504	
★ Application			
● 4 TRUCK			
★ CP/CR/CT			
● P-G-R-T TRUCK			
★			

5 POLE WIPER MOTOR



	Code	OEM new	OEM old
	64052	1318506	
● 4 TRUCK			
★ CH UP TO 1224448 - CH UP TO 4367630 - CH UP TO 9018490			

6 POLE WIPER MOTOR



	Code	OEM new	OEM old
	64053	1392755	
● 4 TRUCK			
★ CH FROM 1224449 - CH FROM 4367631 - CH FROM 9018491			

ALL THE COMPONENTS LISTED IN OUR CATALOGUE ARE NOT ORIGINAL, THOUGH PERFECTLY INTERCHANGEABLE. REFERENCE NUMBERS, EITHER ORIGINAL OR OF A DIFFERENT NATURE, ARE FOR INFORMATION PURPOSES ONLY WHEN PLACING AN ORDER, PLEASE, ALWAYS USE COSIBO REFERENCE NUMBERS AND DO NOT MENTION THE ORIGINAL REFERENCE NUMBERS OF THE TRUCK MANUFACTURERS IN THE INVOICE TO VEHICLE OWNERS OR TO ANYBODY ELSE. THE CUSTOMER TAKES HIS OWN RESPONSIBILITY IF HE DOES NOT COMPLY WITH WHAT ABOVE.

		Code	OEM new	OEM old
SWITCH	● Model	62520	1488067	353626
	★ Application			
	● 3 BUS			
	★			
	● 4 BUS			
	★			
	● 3 TRUCK			
★				
● 4 TRUCK				
★				



RELAY		63447	1431781	1391322 243460
	● F-K-N BUS			
	★ IKIB			
	● 3 TRUCK			
	★			
	● 4 TRUCK			
	★ CP/CR/CT - ADR - WEBASTO ADR			
● P-G-R-T TRUCK				
★				





SWITCH		65176	1350317	
	● 3 BUS			
	★ GR801R WITH RETARDER WITH ABS			
	● 3 TRUCK			
	★ GR/GRS900R WITH RETARDER			
	● 4 TRUCK			
	★ GRS890R 8X8 WLS/ZLS - GRS900R - R124 8X8 WLS/ZLS			



ALL THE COMPONENTS LISTED IN OUR CATALOGUE ARE NOT ORIGINAL, THOUGH PERFECTLY INTERCHANGEABLE. REFERENCE NUMBERS, EITHER ORIGINAL OR OF A DIFFERENT NATURE, ARE FOR INFORMATION PURPOSES ONLY WHEN PLACING AN ORDER, PLEASE, ALWAYS USE COSIBO REFERENCE NUMBERS AND DO NOT MENTION THE ORIGINAL REFERENCE NUMBERS OF THE TRUCK MANUFACTURERS IN THE INVOICE TO VEHICLE OWNERS OR TO ANYBODY ELSE. THE CUSTOMER TAKES HIS OWN RESPONSIBILITY IF HE DOES NOT COMPLY WITH WHAT ABOVE.

		Code	OEM new	OEM old
SWITCH	● Model	62276	1363131	1328177 290950
	★ Application			
	● 3 BUS			
	★			
	● 3 TRUCK			
	★ P113 ML/HL 4X2 6X2			

SPEED SENSOR	65186	1853436	1111459
	● 3 BUS		
	★		
	● 3 TRUCK		
	★ GR871 - GRS900 - GR880		
	● 4 BUS		
	★ GR801R		
	● 4 TRUCK		
	★ 94 - 114 - 124 - 144 - 164		
	● P-G-R-T TRUCK		
	★ GR801		

OIL PRESSURE MONITOR	62295	1434135	
	● 3 TRUCK		
	★ G/P/R/T 93 - P/R/T 113/143 GRS900 GA/GAE770/774		
	● 4 TRUCK		
	★ 94 - 114 - 124 - 144 - 164		

ALL THE COMPONENTS LISTED IN OUR CATALOGUE ARE NOT ORIGINAL, THOUGH PERFECTLY INTERCHANGEABLE. REFERENCE NUMBERS, EITHER ORIGINAL OR OF A DIFFERENT NATURE, ARE FOR INFORMATION PURPOSES ONLY WHEN PLACING AN ORDER, PLEASE, ALWAYS USE COSIBO REFERENCE NUMBERS AND DO NOT MENTION THE ORIGINAL REFERENCE NUMBERS OF THE TRUCK MANUFACTURERS IN THE INVOICE TO VEHICLE OWNERS OR TO ANYBODY ELSE. THE CUSTOMER TAKES HIS OWN RESPONSIBILITY IF HE DOES NOT COMPLY WITH WHAT ABOVE.

		Code	OEM new	OEM old
SWITCH	● Model	63604	1488066	353621
	★ Application			
	● 3 TRUCK			
	★			
● 4 TRUCK				
★	94 - 114 - 124 - 144 - 164			



SWITCH		64134	1327015	
	● 4 BUS			
	★			
	● 4 TRUCK			
★				



SWITCH		64493	353623	
	● 3 TRUCK			
	★			
	● 4 TRUCK			
★	94 - 114 - 124 - 144 - 164			



SWITCH		61137	365015	
	● 3 BUS			
	★			
	● 3 TRUCK			
	★			
	● 4 BUS			
	★			
	● 4 TRUCK			
★	94 - 114 - 124 - 144 - 164			



ALL THE COMPONENTS LISTED IN OUR CATALOGUE ARE NOT ORIGINAL, THOUGH PERFECTLY INTERCHANGEABLE. REFERENCE NUMBERS, EITHER ORIGINAL OR OF A DIFFERENT NATURE, ARE FOR INFORMATION PURPOSES ONLY WHEN PLACING AN ORDER, PLEASE, ALWAYS USE COSIBO REFERENCE NUMBERS AND DO NOT MENTION THE ORIGINAL REFERENCE NUMBERS OF THE TRUCK MANUFACTURERS IN THE INVOICE TO VEHICLE OWNERS OR TO ANYBODY ELSE. THE CUSTOMER TAKES HIS OWN RESPONSIBILITY IF HE DOES NOT COMPLY WITH WHAT ABOVE.

TANK LEVEL MONITOR









	Code	OEM new	OEM old
● Model	63644	1434134	1423207
★ Application			
● 3 TRUCK			
★ G/P/R/T 93 - P/R/T 113/143 GRS900 GA/GAE770/774			
● 4 TRUCK			
★ 94 - 114 - 124 - 144 - 164			

INPULSE SENSOR



	62530	1852113	1742947
● 4 TRUCK			
★			
● P-G-R-T TRUCK			
★			
● 3 BUS			
★			
● 4 BUS			
★			
● F-K-N BUS			
★			

ALL THE COMPONENTS LISTED IN OUR CATALOGUE ARE NOT ORIGINAL, THOUGH PERFECTLY INTERCHANGEABLE. REFERENCE NUMBERS, EITHER ORIGINAL OR OF A DIFFERENT NATURE, ARE FOR INFORMATION PURPOSES ONLY WHEN PLACING AN ORDER, PLEASE, ALWAYS USE COSIBO REFERENCE NUMBERS AND DO NOT MENTION THE ORIGINAL REFERENCE NUMBERS OF THE TRUCK MANUFACTURERS IN THE INVOICE TO VEHICLE OWNERS OR TO ANYBODY ELSE. THE CUSTOMER TAKES HIS OWN RESPONSIBILITY IF HE DOES NOT COMPLY WITH WHAT ABOVE.

	Code	OEM new	OEM old
<p>GAS SPRING</p> 	61621	353592	341299
<ul style="list-style-type: none"> ● Model ★ Application 			
<ul style="list-style-type: none"> ● 3 TRUCK ★ CG/CP/CR 			
<p>GAS SPRING</p> 	62395	1374642	
<ul style="list-style-type: none"> ● 4 TRUCK ★ CP/CR CH 1232869 - CH 1232870 - CH 4381208 - CH 4381209 - CH 9026437 - CH 9026438 			
<p>GAS SPRING</p> 	63620	1306492	
<ul style="list-style-type: none"> ● 4 TRUCK ★ CP LHD CH 1230214 - CH 1230215 - CH 4376384 - CH 4376385 - CH 9023916 - CH 9023917 - CR LHD CH 1227495 - CH 1227496 - CH 4371633 - CH 4371634 - CH 9021602 - CH 9021603 - CP/CR RHD CH 1233807 - CH 1233808 - CH 4382181 - CH 4382182 - CH 9027043 - CH 9027044 			
<p>GAS SPRING</p> 	64049	1331164	
<ul style="list-style-type: none"> ● 3 TRUCK ★ STREAMLINE 			
<p>GAS SPRING</p> 	64060	1481371	
<ul style="list-style-type: none"> ● P-G-R-T TRUCK ★ CG/CR 			
<p>GAS SPRING</p> 	64062	1369553	
<ul style="list-style-type: none"> ● 4 TRUCK ★ CP LHD CH 1230215 - CH 4376385 - CH 9023917 - CH 3500001 - CR LHD CH 1227496 - CH 4371634 - CH 9021603 - CH 3500001 - CP/CR RHD CH 1233808 - CH 4382182 - CH 9027044 - CH 3500001 			

ALL THE COMPONENTS LISTED IN OUR CATALOGUE ARE NOT ORIGINAL, THOUGH PERFECTLY INTERCHANGEABLE. REFERENCE NUMBERS, EITHER ORIGINAL OR OF A DIFFERENT NATURE, ARE FOR INFORMATION PURPOSES ONLY WHEN PLACING AN ORDER, PLEASE, ALWAYS USE COSIBO REFERENCE NUMBERS AND DO NOT MENTION THE ORIGINAL REFERENCE NUMBERS OF THE TRUCK MANUFACTURERS IN THE INVOICE TO VEHICLE OWNERS OR TO ANYBODY ELSE. THE CUSTOMER TAKES HIS OWN RESPONSIBILITY IF HE DOES NOT COMPLY WITH WHAT ABOVE.

RUBBER HOSE



- Model
- ★ Application

61212

346627

OEM old

- 3 TRUCK

- ★ CG/CP

RUBBER HOSE



61808

142729

- 3 TRUCK

- ★ GR900R/GRS900R

V-BELT L=2430



63934

1800527

1490821

- IND. MARINE ENGINE 4

- ★ DI12 40A

ALL THE COMPONENTS LISTED IN OUR CATALOGUE ARE NOT ORIGINAL, THOUGH PERFECTLY INTERCHANGEABLE. REFERENCE NUMBERS, EITHER ORIGINAL OR OF A DIFFERENT NATURE, ARE FOR INFORMATION PURPOSES ONLY WHEN PLACING AN ORDER, PLEASE, ALWAYS USE COSIBO REFERENCE NUMBERS AND DO NOT MENTION THE ORIGINAL REFERENCE NUMBERS OF THE TRUCK MANUFACTURERS IN THE INVOICE TO VEHICLE OWNERS OR TO ANYBODY ELSE. THE CUSTOMER TAKES HIS OWN RESPONSIBILITY IF HE DOES NOT COMPLY WITH WHAT ABOVE.

CABIN HEATER MOTOR

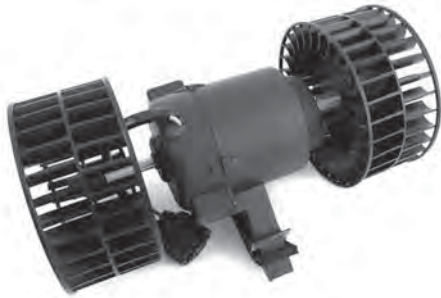

- Model
- ★ Application

Code	OEM new	OEM old
63187	1495692	1401436

- 4 TRUCK
- ★

FAN HEATING SENSOR



- 4 TRUCK
- ★ CP/CR/CT

64027	1738098	1425070
--------------	---------	---------

CABIN AIR FILTER

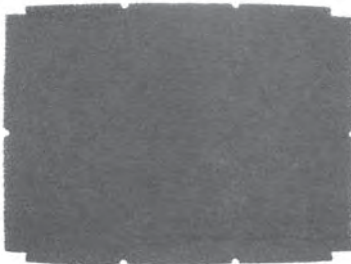

- 3 TRUCK
- ★

60922	303520	
--------------	--------	--

ALL THE COMPONENTS LISTED IN OUR CATALOGUE ARE NOT ORIGINAL, THOUGH PERFECTLY INTERCHANGEABLE. REFERENCE NUMBERS, EITHER ORIGINAL OR OF A DIFFERENT NATURE, ARE FOR INFORMATION PURPOSES ONLY WHEN PLACING AN ORDER, PLEASE, ALWAYS USE COSIBO REFERENCE NUMBERS AND DO NOT MENTION THE ORIGINAL REFERENCE NUMBERS OF THE TRUCK MANUFACTURERS IN THE INVOICE TO VEHICLE OWNERS OR TO ANYBODY ELSE. THE CUSTOMER TAKES HIS OWN RESPONSIBILITY IF HE DOES NOT COMPLY WITH WHAT ABOVE.

CABIN AIR FILTER



	Code	OEM new	OEM old
● Model	60631	1913503	1420197
★ Application			
● 4 BUS			
★ D9/DC11/D12/D14 12.2 BAR			
● 4 TRUCK			
★ D9/DC11/D12/D14 9,3/12,2 BAR - D16 9,3/12,2 BAR - D12 HPI 9,3/12,2 BAR - CP/CR/CT			
● F-K-N BUS			
★ D12 HPI - D9/D11/D12 PDE			
● P-G-R-T TRUCK			
★ D16 - HPI - D9/D11D12 PDE - CG/CP/CR			

CABIN AIR FILTER, ACTIVED CARBONS



	60631/1	1420197/1	
● 4 BUS			
★ D9/DC11/D12/D14 12.2 BAR			
● 4 TRUCK			
★ D9/DC11/D12/D14 9,3/12,2 BAR - D16 9,3/12,2 BAR - D12 HPI 9,3/12,2 BAR - CP/CR/CT			
● F-K-N BUS			
★ D12 HPI - D9/D11/D12 PDE			
● P-G-R-T TRUCK			
★ D16 - HPI - D9/D11D12 PDE - CG/CP/CR			

CABIN AIR FILTER



	64209	1913500	1770813
● P-G-R-T TRUCK			
★ D16 - HPI - D9/D11/D12 PDE -			

ALL THE COMPONENTS LISTED IN OUR CATALOGUE ARE NOT ORIGINAL, THOUGH PERFECTLY INTERCHANGEABLE. REFERENCE NUMBERS, EITHER ORIGINAL OR OF A DIFFERENT NATURE, ARE FOR INFORMATION PURPOSES ONLY WHEN PLACING AN ORDER, PLEASE, ALWAYS USE COSIBO REFERENCE NUMBERS AND DO NOT MENTION THE ORIGINAL REFERENCE NUMBERS OF THE TRUCK MANUFACTURERS IN THE INVOICE TO VEHICLE OWNERS OR TO ANYBODY ELSE. THE CUSTOMER TAKES HIS OWN RESPONSIBILITY IF HE DOES NOT COMPLY WITH WHAT ABOVE.

SOLENOID VALVE



	Code	OEM new	OEM old
● Model	62342	1536307	1421325
★ Application			
● 4 BUS			
★ CL/CN - CN94UA			
● F-K-N BUS			
★ IKIB			

RUBBER SPACER



	65254	302200	
● 3 BUS			
★			
● 3 TRUCK			
★			

O-RING DIAM.=59,5X3 mm



	60636	332119	392663
● F-K-N BUS			
★ K UD 6X2			

ALL THE COMPONENTS LISTED IN OUR CATALOGUE ARE NOT ORIGINAL, THOUGH PERFECTLY INTERCHANGEABLE. REFERENCE NUMBERS, EITHER ORIGINAL OR OF A DIFFERENT NATURE, ARE FOR INFORMATION PURPOSES ONLY WHEN PLACING AN ORDER, PLEASE, ALWAYS USE COSIBO REFERENCE NUMBERS AND DO NOT MENTION THE ORIGINAL REFERENCE NUMBERS OF THE TRUCK MANUFACTURERS IN THE INVOICE TO VEHICLE OWNERS OR TO ANYBODY ELSE. THE CUSTOMER TAKES HIS OWN RESPONSIBILITY IF HE DOES NOT COMPLY WITH WHAT ABOVE.

SOLENOID VALVE





- **Model**
- ★ **Application**

Code	OEM new	OEM old
65191	1536304	1340231 1421322

- **4 BUS**
- ★ CL/CN - CN LHD/RHD
- **F-K-N BUS**
- ★

ALL THE COMPONENTS LISTED IN OUR CATALOGUE ARE NOT ORIGINAL, THOUGH PERFECTLY INTERCHANGEABLE. REFERENCE NUMBERS, EITHER ORIGINAL OR OF A DIFFERENT NATURE, ARE FOR INFORMATION PURPOSES ONLY WHEN PLACING AN ORDER, PLEASE, ALWAYS USE COSIBO REFERENCE NUMBERS AND DO NOT MENTION THE ORIGINAL REFERENCE NUMBERS OF THE TRUCK MANUFACTURERS IN THE INVOICE TO VEHICLE OWNERS OR TO ANYBODY ELSE. THE CUSTOMER TAKES HIS OWN RESPONSIBILITY IF HE DOES NOT COMPLY WITH WHAT ABOVE.

		Code	OEM new	OEM old
LH SEAT SWITCH	● Model	62472	1391425	
	★ Application			
	● 4 TRUCK			
	★	LUXURY TYPE CH 1239401 - CH 1239402 - 1254179 - CH 4391862 - CH 4391863 - 4420246 - CH 9031835 - CH 9031836 - 9046286 - CH 3500759 - CH 3500760 - 3513489 - MEDIUM TYPE A CH 1239401 - CH 1239402 - 1254179 - CH 4391862 - CH 4391863 - 4420246 - CH 9031835 - CH 9031836 - 9046286 - CH 3500759 - CH 3500760 - 3513489		

RH SEAT SWITCH	62471	1391426	
	● 4 TRUCK		
	★	LUXURY TYPE CH 1239401 - CH 1239402 - 1254179 - CH 4391862 - CH 4391863 - 4420246 - CH 9031835 - CH 9031836 - 9046286 - CH 3500759 - CH 3500760 - 3513489 - MEDIUM TYPE A CH 1239401 - CH 1239402 - 1254179 - CH 4391862 - CH 4391863 - 4420246 - CH 9031835 - CH 9031836 - 9046286 - CH 3500759 - CH 3500760 - 3513489	

LH SEAT SWITCH	62474	1440370	
	● 4 TRUCK		
	★	MEDIUM TYPE A CH 1254180 - CH 4420247 - CH 9046287 - CH 3513490 - LUXURY TYPE CH 1254180 - CH 4420247 - CH 9046287 - CH 3513490	

ALL THE COMPONENTS LISTED IN OUR CATALOGUE ARE NOT ORIGINAL, THOUGH PERFECTLY INTERCHANGEABLE. REFERENCE NUMBERS, EITHER ORIGINAL OR OF A DIFFERENT NATURE, ARE FOR INFORMATION PURPOSES ONLY WHEN PLACING AN ORDER, PLEASE, ALWAYS USE COSIBO REFERENCE NUMBERS AND DO NOT MENTION THE ORIGINAL REFERENCE NUMBERS OF THE TRUCK MANUFACTURERS IN THE INVOICE TO VEHICLE OWNERS OR TO ANYBODY ELSE. THE CUSTOMER TAKES HIS OWN RESPONSIBILITY IF HE DOES NOT COMPLY WITH WHAT ABOVE.

RH SEAT SWITCH



	Code	OEM new	OEM old
● Model	62473	1440371	
★ Application			
● 4 TRUCK			
★	MEDIUM TYPE A CH 1254180 - CH 4420247 - CH 9046287 - CH 3513490 - LUXURY TYPE CH 1254180 - CH 4420247 - CH 9046287 - CH 3513490		

CONTROL CYLINDER SEAT



	62525	1440365	
● 4 TRUCK			
★	MEDIUM TYPE A & LUXURY TYPE CH 1254180 - CH 4420247 - CH 9046287 - CH 3513490		

SEAT LEVELING VALVE



	62538	1440367	
● 4 TRUCK			
★	MEDIUM TYPE A - LUXURY TYPE CH 1254180 - CH 4420247 - CH 9046287 - CH 3513490		

ALL THE COMPONENTS LISTED IN OUR CATALOGUE ARE NOT ORIGINAL, THOUGH PERFECTLY INTERCHANGEABLE. REFERENCE NUMBERS, EITHER ORIGINAL OR OF A DIFFERENT NATURE, ARE FOR INFORMATION PURPOSES ONLY WHEN PLACING AN ORDER, PLEASE, ALWAYS USE COSIBO REFERENCE NUMBERS AND DO NOT MENTION THE ORIGINAL REFERENCE NUMBERS OF THE TRUCK MANUFACTURERS IN THE INVOICE TO VEHICLE OWNERS OR TO ANYBODY ELSE. THE CUSTOMER TAKES HIS OWN RESPONSIBILITY IF HE DOES NOT COMPLY WITH WHAT ABOVE.

SEAT LINK



- Model
- ★ Application

Code	OEM new	OEM old
62539	1440364	

- 4 TRUCK

- ★ MEDIUM TYPE A - LUXURY TYPE CH 1254180 - CH 4420247 - CH 9046287 - CH 3513490

ALL THE COMPONENTS LISTED IN OUR CATALOGUE ARE NOT ORIGINAL, THOUGH PERFECTLY INTERCHANGEABLE. REFERENCE NUMBERS, EITHER ORIGINAL OR OF A DIFFERENT NATURE, ARE FOR INFORMATION PURPOSES ONLY WHEN PLACING AN ORDER, PLEASE, ALWAYS USE COSIBO REFERENCE NUMBERS AND DO NOT MENTION THE ORIGINAL REFERENCE NUMBERS OF THE TRUCK MANUFACTURERS IN THE INVOICE TO VEHICLE OWNERS OR TO ANYBODY ELSE. THE CUSTOMER TAKES HIS OWN RESPONSIBILITY IF HE DOES NOT COMPLY WITH WHAT ABOVE.

	Code	OEM new	OEM old
RUBBER DAMPER	65272	384595	
<ul style="list-style-type: none"> ● Model ★ Application 			
<ul style="list-style-type: none"> ● 3 TRUCK ★ DN/DS/DSC 			



RUBBER BUFFER	65273	1358828	1332090
<ul style="list-style-type: none"> ● 3 TRUCK ★ DN/DS/DSC 			



RUBBER DAMPER	62241	341403	319989
<ul style="list-style-type: none"> ● 3 TRUCK ★ STREAMLINE 			





RUBBER DAMPER	62242	348764	
<ul style="list-style-type: none"> ● 3 TRUCK ★ CH 1144377 - CH 4277346 			



ALL THE COMPONENTS LISTED IN OUR CATALOGUE ARE NOT ORIGINAL, THOUGH PERFECTLY INTERCHANGEABLE. REFERENCE NUMBERS, EITHER ORIGINAL OR OF A DIFFERENT NATURE, ARE FOR INFORMATION PURPOSES ONLY WHEN PLACING AN ORDER, PLEASE, ALWAYS USE COSIBO REFERENCE NUMBERS AND DO NOT MENTION THE ORIGINAL REFERENCE NUMBERS OF THE TRUCK MANUFACTURERS IN THE INVOICE TO VEHICLE OWNERS OR TO ANYBODY ELSE. THE CUSTOMER TAKES HIS OWN RESPONSIBILITY IF HE DOES NOT COMPLY WITH WHAT ABOVE.

	Code	OEM new	OEM old
RUBBER DAMPER	61222	390358	347241
 <ul style="list-style-type: none"> ● Model ★ Application 	<ul style="list-style-type: none"> ● 3 TRUCK ★ 		

RUBBER DAMPER	61223	390359	347245
 <ul style="list-style-type: none"> ● 3 TRUCK ★ 			

RUBBER DAMPER	62244	361243	
 <ul style="list-style-type: none"> ● 3 TRUCK ★ CT13/CT19 			

RUBBER BUSHING	62245	716360	
 <ul style="list-style-type: none"> ● 3 TRUCK ★ CT13/CT19 			

ALL THE COMPONENTS LISTED IN OUR CATALOGUE ARE NOT ORIGINAL, THOUGH PERFECTLY INTERCHANGEABLE. REFERENCE NUMBERS, EITHER ORIGINAL OR OF A DIFFERENT NATURE, ARE FOR INFORMATION PURPOSES ONLY WHEN PLACING AN ORDER, PLEASE, ALWAYS USE COSIBO REFERENCE NUMBERS AND DO NOT MENTION THE ORIGINAL REFERENCE NUMBERS OF THE TRUCK MANUFACTURERS IN THE INVOICE TO VEHICLE OWNERS OR TO ANYBODY ELSE. THE CUSTOMER TAKES HIS OWN RESPONSIBILITY IF HE DOES NOT COMPLY WITH WHAT ABOVE.

	Code	OEM new	OEM old
CAB BUSHING	61743	385266	



- Model
- ★ Application

- 3 TRUCK
- ★ CT13/CT19

PLASTIC BUSHING	62027	346085	
------------------------	--------------	--------	--



- 3 TRUCK

- ★

CAB BUSHING FULL RUBBERD INSIDE	60482	1394544	
--	--------------	---------	--



- 4 TRUCK

- ★ CR CH 1291876 - CH 1291877 - CH 4500364 - CH 4500365 - CH 9083194 - CH 9083195 - CH 3544687 - CH 3544688 - CP19 - CP CH 1291876 - CH 1291877 - CH 4500364 - CH 4500365 - CH 9083194 - CH 9083195 - CH 3544687 - CH 3544688 - CP19 CH 3555849 - CP14 CH 3555849

RUBBER BUSHING	62028	283295	
-----------------------	--------------	--------	--



- 3 TRUCK

- ★

ALL THE COMPONENTS LISTED IN OUR CATALOGUE ARE NOT ORIGINAL, THOUGH PERFECTLY INTERCHANGEABLE. REFERENCE NUMBERS, EITHER ORIGINAL OR OF A DIFFERENT NATURE, ARE FOR INFORMATION PURPOSES ONLY WHEN PLACING AN ORDER, PLEASE, ALWAYS USE COSIBO REFERENCE NUMBERS AND DO NOT MENTION THE ORIGINAL REFERENCE NUMBERS OF THE TRUCK MANUFACTURERS IN THE INVOICE TO VEHICLE OWNERS OR TO ANYBODY ELSE. THE CUSTOMER TAKES HIS OWN RESPONSIBILITY IF HE DOES NOT COMPLY WITH WHAT ABOVE.

BEARING



- Model
- ★ Application

Code	OEM new	OEM old
62029	348694	

- 3 TRUCK
- ★

RUBBER DAMPER



- 3 TRUCK
- ★

62030	1302008	
-------	---------	--

SPACER



- 3 TRUCK
- ★

62031	325014	
-------	--------	--

SPACER



- 3 TRUCK
- ★

62032	311755	
-------	--------	--

ALL THE COMPONENTS LISTED IN OUR CATALOGUE ARE NOT ORIGINAL, THOUGH PERFECTLY INTERCHANGEABLE. REFERENCE NUMBERS, EITHER ORIGINAL OR OF A DIFFERENT NATURE, ARE FOR INFORMATION PURPOSES ONLY WHEN PLACING AN ORDER, PLEASE, ALWAYS USE COSIBO REFERENCE NUMBERS AND DO NOT MENTION THE ORIGINAL REFERENCE NUMBERS OF THE TRUCK MANUFACTURERS IN THE INVOICE TO VEHICLE OWNERS OR TO ANYBODY ELSE. THE CUSTOMER TAKES HIS OWN RESPONSIBILITY IF HE DOES NOT COMPLY WITH WHAT ABOVE.

	Code	OEM new	OEM old
SPACER	62033	1121763	297571



- Model
- ★ Application

● 3 TRUCK

★

CAB BUSHING	62145	1356668	320775
--------------------	--------------	---------	--------



● 3 TRUCK

★

SPRING	63746	346568	
---------------	--------------	--------	--



● 3 TRUCK

★ CG/CP/CR13

ALL THE COMPONENTS LISTED IN OUR CATALOGUE ARE NOT ORIGINAL, THOUGH PERFECTLY INTERCHANGEABLE. REFERENCE NUMBERS, EITHER ORIGINAL OR OF A DIFFERENT NATURE, ARE FOR INFORMATION PURPOSES ONLY WHEN PLACING AN ORDER, PLEASE, ALWAYS USE COSIBO REFERENCE NUMBERS AND DO NOT MENTION THE ORIGINAL REFERENCE NUMBERS OF THE TRUCK MANUFACTURERS IN THE INVOICE TO VEHICLE OWNERS OR TO ANYBODY ELSE. THE CUSTOMER TAKES HIS OWN RESPONSIBILITY IF HE DOES NOT COMPLY WITH WHAT ABOVE.

	Code	OEM new	OEM old
SPRING	63747	383523	
<ul style="list-style-type: none"> ● Model ★ Application 			
<ul style="list-style-type: none"> ● 3 TRUCK ★ CP19 4X2 6X2 6X4 			



RUBBER MOUNTING	61226	329583	305345
<ul style="list-style-type: none"> ● 3 TRUCK ★ DN/DS/DSC 			



CAB BUSHING FULL RUBBERD INSIDE	60482	1394544	
<ul style="list-style-type: none"> ● P-G-R-T TRUCK ★ CR16/ 19 - CP16/ 19 - CP14 - CG 			



ALL THE COMPONENTS LISTED IN OUR CATALOGUE ARE NOT ORIGINAL, THOUGH PERFECTLY INTERCHANGEABLE. REFERENCE NUMBERS, EITHER ORIGINAL OR OF A DIFFERENT NATURE, ARE FOR INFORMATION PURPOSES ONLY WHEN PLACING AN ORDER, PLEASE, ALWAYS USE COSIBO REFERENCE NUMBERS AND DO NOT MENTION THE ORIGINAL REFERENCE NUMBERS OF THE TRUCK MANUFACTURERS IN THE INVOICE TO VEHICLE OWNERS OR TO ANYBODY ELSE. THE CUSTOMER TAKES HIS OWN RESPONSIBILITY IF HE DOES NOT COMPLY WITH WHAT ABOVE.

CAB BALL JOINT W/SEAL RINGS



	Code	OEM new	OEM old
● Model	64270	62470	
★ Application			
● P-G-R-T TRUCK			
★ CP - CT14 - CT19 - CT - CP 16/19 - CP14			
● 4 TRUCK			
★ CP19 - CR CH 1291876 - CH 1291877 - CH 4500364 - CH 4500365 - CH 9083194 - CH 9083195 - CH 3544687 - CH 3544688 - CP CH 1291876 - CH 1291877 - CH 4500364 - CH 4500365 - CH 9083194 - CH 9083195 - CH 3544687 - CH 3544688 - CT CH 1290103CH 1290104 - CH 4498394 - CH 4498395 - CH 9082906 - CH 9082907 - CT14 - CP19 CH 3555849 - CP14 CH 3555849			

CAB BALL JOINT W/SEAL RINGS



	Code	OEM new	OEM old
	64271	62471	
● P-G-R-T TRUCK			
★ CR 16/19 - CG			

CAB BUSHING PARTIAL RUBBERD INSIDE



	Code	OEM new	OEM old
	60482/T	1377562	
● 4 TRUCK			
★ CR CH 1291876 - CH 1291877 - CH 4500364 - CH 4500365 - CH 9083194 - CH 9083195 - CH 3544687 - CH 3544688 - CP19 - CP CH 1291876 - CH 1291877 - CH 4500364 - CH 4500365 - CH 9083194 - CH 9083195 - CH 3544687 - CH 3544688 - CP19 CH 3555849 - CP14 CH 3555849			
● P-G-R-T TRUCK			
★ CR16/ 19 - CP16/ 19 - CP14 - CG			

WASHER IN POLYURETHANE BLACK



	Code	OEM new	OEM old
	60490	1385170	
● 4 TRUCK			
★ CR CH 1291876 - CH 1291877 - CH 4500364 - CH 4500365 - CH 9083194 - CH 9083195 - CH 3544687 - CH 3544688 - CP19 - CP CH 1291876 - CH 1291877 - CH 4500364 - CH 4500365 - CH 9083194 - CH 9083195 - CH 3544687 - CH 3544688 - CP19 CH 3555849 - CP14 CH 3555849			
● P-G-R-T TRUCK			
★ CR16/ 19 - CP16/ 19 - CP14 - CG			

ALL THE COMPONENTS LISTED IN OUR CATALOGUE ARE NOT ORIGINAL, THOUGH PERFECTLY INTERCHANGEABLE. REFERENCE NUMBERS, EITHER ORIGINAL OR OF A DIFFERENT NATURE, ARE FOR INFORMATION PURPOSES ONLY WHEN PLACING AN ORDER, PLEASE, ALWAYS USE COSIBO REFERENCE NUMBERS AND DO NOT MENTION THE ORIGINAL REFERENCE NUMBERS OF THE TRUCK MANUFACTURERS IN THE INVOICE TO VEHICLE OWNERS OR TO ANYBODY ELSE. THE CUSTOMER TAKES HIS OWN RESPONSIBILITY IF HE DOES NOT COMPLY WITH WHAT ABOVE.

CABIN SUSPENSION REPAIR KIT



	Code	OEM new	OEM old
● Model	63808	63808	
★ Application			
● 4 TRUCK			
★ CP/ CR CABIN			
● P-G-R-T TRUCK			
★ CP/ CR CABIN			

PARTIAL CABIN SUSPENSION REPAIR SET



	63811	63811	
● 4 TRUCK			
★ CP/CR CABIN			
● P-G-R-T TRUCK			
★ CP/CR CABIN			

CABIN LOCK



	64067	1383496	
● 4 TRUCK			
★ CP19/CP19F - CR19 - CP/CR14 - CP28/31			

ALL THE COMPONENTS LISTED IN OUR CATALOGUE ARE NOT ORIGINAL, THOUGH PERFECTLY INTERCHANGEABLE. REFERENCE NUMBERS, EITHER ORIGINAL OR OF A DIFFERENT NATURE, ARE FOR INFORMATION PURPOSES ONLY WHEN PLACING AN ORDER, PLEASE, ALWAYS USE COSIBO REFERENCE NUMBERS AND DO NOT MENTION THE ORIGINAL REFERENCE NUMBERS OF THE TRUCK MANUFACTURERS IN THE INVOICE TO VEHICLE OWNERS OR TO ANYBODY ELSE. THE CUSTOMER TAKES HIS OWN RESPONSIBILITY IF HE DOES NOT COMPLY WITH WHAT ABOVE.

		Code	OEM new	OEM old
SEAL RING	● Model	63873	1780108	1343149
	★ Application			1459188
	● 4 TRUCK			
	★	CP19 - CR CH 1291876 - CH 1291877 - CH 4500364 - CH 4500365 - CH 9083194 - CH 9083195 - CH 3544687 - CH 3544688 - CP CH 1291876CH 1291877 - CH 4500364 - CH 4500365 - CH 9083194 - CH 9083195 - CH 3544687 - CH 3544688 - CT CH 1290103 - CH 1290104 - CH 4498394 - CH 4498395 - CH - CH 9082906 - CH 9082907 - CT14 - CP19 CH 3555849 - CP14 CH 3555849		
	● P-G-R-T TRUCK			
	★	CR16/ 19 - CP - CT14 - CP19 - CT - CP14 - CT19 - CG		

CABIN BALL JOINT	63361	1744210	1443114 1504160
	● 4 TRUCK		
	★	CP19 - CR CH 1291876 - CH 1291877 - CH 4500364 - CH 4500365 - CH 9083194 - CH 9083195 - CH 3544687 - CH 3544688 - CP CH 1291876 - CH 1291877 - CH 4500364 - CH 4500365 - CH 9083194 - CH 9083195 - CH 3544687 - CH 3544688 - CT CH 1290103CH 1290104 - CH 4498394 - CH 4498395 - CH 9082906 - CH 9082907 - CT14 - CP19 CH 3555849 - CP14 CH 3555849	
	● P-G-R-T TRUCK		
	★	CP - CT14 - CT19 - CT - CP 16/ 19 - CP14	

CABIN BALL JOINT	63927	1744211	
	● P-G-R-T TRUCK		
	★	CR 16/ 19 - CG	

ALL THE COMPONENTS LISTED IN OUR CATALOGUE ARE NOT ORIGINAL, THOUGH PERFECTLY INTERCHANGEABLE. REFERENCE NUMBERS, EITHER ORIGINAL OR OF A DIFFERENT NATURE, ARE FOR INFORMATION PURPOSES ONLY WHEN PLACING AN ORDER, PLEASE, ALWAYS USE COSIBO REFERENCE NUMBERS AND DO NOT MENTION THE ORIGINAL REFERENCE NUMBERS OF THE TRUCK MANUFACTURERS IN THE INVOICE TO VEHICLE OWNERS OR TO ANYBODY ELSE. THE CUSTOMER TAKES HIS OWN RESPONSIBILITY IF HE DOES NOT COMPLY WITH WHAT ABOVE.

	Code	OEM new	OEM old
CAB BUSHING	61324	1514505	1105972
<ul style="list-style-type: none"> ● Model ★ Application 			
<ul style="list-style-type: none"> ● 3 TRUCK ★ 			
<ul style="list-style-type: none"> ● 4 TRUCK ★ CT 			
<ul style="list-style-type: none"> ● P-G-R-T TRUCK ★ CT 			



CAB BUSHING	64111	1368039	
<ul style="list-style-type: none"> ● 4 TRUCK ★ CT 			
<ul style="list-style-type: none"> ● P-G-R-T TRUCK ★ CT 			



WASHER	65269	1353965	
<ul style="list-style-type: none"> ● 4 TRUCK ★ CT 			
<ul style="list-style-type: none"> ● P-G-R-T TRUCK ★ CT 			



RUBBER BUSHING	62239	1379244	
<ul style="list-style-type: none"> ● 4 TRUCK ★ CT 			
<ul style="list-style-type: none"> ● P-G-R-T TRUCK ★ CT 			



ALL THE COMPONENTS LISTED IN OUR CATALOGUE ARE NOT ORIGINAL, THOUGH PERFECTLY INTERCHANGEABLE. REFERENCE NUMBERS, EITHER ORIGINAL OR OF A DIFFERENT NATURE, ARE FOR INFORMATION PURPOSES ONLY WHEN PLACING AN ORDER, PLEASE, ALWAYS USE COSIBO REFERENCE NUMBERS AND DO NOT MENTION THE ORIGINAL REFERENCE NUMBERS OF THE TRUCK MANUFACTURERS IN THE INVOICE TO VEHICLE OWNERS OR TO ANYBODY ELSE. THE CUSTOMER TAKES HIS OWN RESPONSIBILITY IF HE DOES NOT COMPLY WITH WHAT ABOVE.

	Code	OEM new	OEM old
RUBBER BUSHING	62243	1372432	
	<ul style="list-style-type: none"> ● Model ★ Application 		
	<ul style="list-style-type: none"> ● 4 TRUCK ★ CP/CR/CT 		
	<ul style="list-style-type: none"> ● P-G-R-T TRUCK ★ CT - CP 14/16/19 		

RUBBER BUFFER	62274	1795583	397308
	<ul style="list-style-type: none"> ● 3 TRUCK ★ CR143 - DSC11 18 - CABIN CP/CR113 - CABIN CR13/19 D11 - CABIN CP/CR DSC11 21 - DSC11 21/22 (EDC/23) DTC11 		
	<ul style="list-style-type: none"> ● 4 TRUCK ★ CABIN CP14/CR14 - R164 		
	<ul style="list-style-type: none"> ● P-G-R-T TRUCK ★ CABIN CP/CG/CR 19M - CABIN CP/CR/CG 16/19 - CABIN CR16 D16 - CABIN CP/CG14 		
	<ul style="list-style-type: none"> ● 3 BUS ★ F113 RH 		
	<ul style="list-style-type: none"> ● IND. MARINE ENGINE 4 ★ DC9 - D116 50M - D16M 		

CAB BUSHING	65282	1353959	
	<ul style="list-style-type: none"> ● 4 TRUCK ★ 		

RUBBER BUFFER	66582	1357381	
	<ul style="list-style-type: none"> ● 4 TRUCK ★ 		
	<ul style="list-style-type: none"> ● P-G-R-T TRUCK ★ 		

ALL THE COMPONENTS LISTED IN OUR CATALOGUE ARE NOT ORIGINAL, THOUGH PERFECTLY INTERCHANGEABLE. REFERENCE NUMBERS, EITHER ORIGINAL OR OF A DIFFERENT NATURE, ARE FOR INFORMATION PURPOSES ONLY WHEN PLACING AN ORDER, PLEASE, ALWAYS USE COSIBO REFERENCE NUMBERS AND DO NOT MENTION THE ORIGINAL REFERENCE NUMBERS OF THE TRUCK MANUFACTURERS IN THE INVOICE TO VEHICLE OWNERS OR TO ANYBODY ELSE. THE CUSTOMER TAKES HIS OWN RESPONSIBILITY IF HE DOES NOT COMPLY WITH WHAT ABOVE.

		Code	OEM new	OEM old
CAB BUSHING	● Model	65282	1353959	
	★ Application			
	● P-G-R-T TRUCK			
	★			

RUBBER BUFFER	61731	285248	
	● 3 TRUCK		
	★ DN/DS		

CABIN REPAIR KIT	64152	1755638	
	● 4 TRUCK		
	★ CP19 - CR CH 1291876 - CH 1291877 - CH 4500364 - CH 4500365 - CH 9083194 - CH 9083195 - CH 3544687 - CH 3544688 - CP CH 1291876 - CH 1291877 - CH 4500364 - CH 4500365 - CH 9083194 - CH 983195 - CH 3544687 - CH 3544688 - CP19 CH 3555849 - CP14 CH 3555849		
	● P-G-R-T TRUCK		
	★ CR 16/ 19 - CP - CP14		

BOLT	65262	1768269	1375299
	● 4 TRUCK		
	★ CP19 - CR CH 1291876 - CH 1291877 - CH 4500364 - CH 4500365 - CH 9083194 - CH 9083195 - CH 3544687 - CH 3544688 - CP CH 1291876 - CH 1291877 - CH 4500364 - CH 4500365 - CH 9083194 - CH 983195 - CH 3544687 - CH 3544688 - CP19 CH 3555849 - CP14 CH 3555849		
	● P-G-R-T TRUCK		
	★ CR 16/19 - CP - CP14		

ALL THE COMPONENTS LISTED IN OUR CATALOGUE ARE NOT ORIGINAL, THOUGH PERFECTLY INTERCHANGEABLE. REFERENCE NUMBERS, EITHER ORIGINAL OR OF A DIFFERENT NATURE, ARE FOR INFORMATION PURPOSES ONLY WHEN PLACING AN ORDER, PLEASE, ALWAYS USE COSIBO REFERENCE NUMBERS AND DO NOT MENTION THE ORIGINAL REFERENCE NUMBERS OF THE TRUCK MANUFACTURERS IN THE INVOICE TO VEHICLE OWNERS OR TO ANYBODY ELSE. THE CUSTOMER TAKES HIS OWN RESPONSIBILITY IF HE DOES NOT COMPLY WITH WHAT ABOVE.

CABIN REPAIR KIT



	Code	OEM new	OEM old
● Model	65326	1742449	
★ Application			
● 4 TRUCK			
★	CP19 CH 3555849 - CR CH 1291876 - CH 1291877 - CH 4500364 - CH 4500365 - CH 9083194 - CH 9083195 - CH 3544687 - CH 3544688 - CP CH 1291876 - CH 1291877 - CH 4500364 - CH 4500365 - CH 9083194 - CH 9083195 - CH 3544687 - CH 3544688 - CP14 CH 3555849		
● P-G-R-T TRUCK			
★	CR 16/ 19 - CP - CP14		

BEARING



	65261	1324713	
● 4 TRUCK			
★	CR CH 1291876 - CH 1291877 - CH 4500364 - CH 4500365 - CH 9083194 - CH 9083195 - CH 3544687 - CH 3544688 - CP19 - CP CH 1291876 - CH 1291877 - CH 4500364 - CH 4500365 - CH 9083194 - CH 9083195 - CH 3544687 - CH 3544688 - CP19 CH 3555849 - CP14 CH 3555849		
● P-G-R-T TRUCK			
★	CR16/ 19 - CP16/ 19 - CP14 - CG		

OIL SEAL 36x52x7





	65263	1324712	
● 4 TRUCK			
★	CR CH 1291876 - CH 1291877 - CH 4500364 - CH 4500365 - CH 9083194 - CH 9083195 - CH 3544687 - CH 3544688 - CP19 - CP CH 1291876 - CH 1291877 - CH 4500364 - CH 4500365 - CH 9083194 - CH 9083195 - CH 3544687 - CH 3544688 - CP19 CH 3555849 - CP14 CH 3555849		
● P-G-R-T TRUCK			
★	CR16/ 19 - CP16/ 19 - CP14 - CG		

ALL THE COMPONENTS LISTED IN OUR CATALOGUE ARE NOT ORIGINAL, THOUGH PERFECTLY INTERCHANGEABLE. REFERENCE NUMBERS, EITHER ORIGINAL OR OF A DIFFERENT NATURE, ARE FOR INFORMATION PURPOSES ONLY WHEN PLACING AN ORDER, PLEASE, ALWAYS USE COSIBO REFERENCE NUMBERS AND DO NOT MENTION THE ORIGINAL REFERENCE NUMBERS OF THE TRUCK MANUFACTURERS IN THE INVOICE TO VEHICLE OWNERS OR TO ANYBODY ELSE. THE CUSTOMER TAKES HIS OWN RESPONSIBILITY IF HE DOES NOT COMPLY WITH WHAT ABOVE.

	Code	OEM new	OEM old
POLIURETHANE DAMPER	60481	1923654	1349805
	<ul style="list-style-type: none"> ● Model ★ Application 		
	<ul style="list-style-type: none"> ● 4 TRUCK ★ CP 19F - CP/CR/CT 19 - CR 19 8X8 WLS/ZLS - CP/CR 14 		
	<ul style="list-style-type: none"> ● P-G-R-T TRUCK ★ CP/CG/CR 16/19 - CP - CT 19 - CP/CG 14 		

RUBBER DAMPER	60481/1	1349805/1	
	<ul style="list-style-type: none"> ● 4 TRUCK ★ CP 19F - CP/CR/CT 19 - CR 19 8X8 WLS/ZLS - CP/CR 14 		
	<ul style="list-style-type: none"> ● P-G-R-T TRUCK ★ CP/CG/CR 16/19 - CP - CT 19 - CP/CG 14 		

VIBRATION DAMPER	60488	1349810	
	<ul style="list-style-type: none"> ● 4 TRUCK ★ CP/CR 19 - CP 14 - CP/CR/CT - CR 8X8 WLS/ZLS 		
	<ul style="list-style-type: none"> ● P-G-R-T TRUCK ★ CP/CR/CG 16/19 - CP/CG/CT - CP/CG 14 		

CAB BUSHING	62010	1894408	1343134 1481245
	<ul style="list-style-type: none"> ● 4 TRUCK ★ CP 19F - CP/CR 19 - CP/CR 14 - CT 14 - CT 19 		
	<ul style="list-style-type: none"> ● P-G-R-T TRUCK ★ CP/CR 19 - CP/CR 16 - CP 14 - CT 14 - CT 19 - CG 14 - CG 16 - CG 19 		

ALL THE COMPONENTS LISTED IN OUR CATALOGUE ARE NOT ORIGINAL, THOUGH PERFECTLY INTERCHANGEABLE. REFERENCE NUMBERS, EITHER ORIGINAL OR OF A DIFFERENT NATURE, ARE FOR INFORMATION PURPOSES ONLY WHEN PLACING AN ORDER, PLEASE, ALWAYS USE COSIBO REFERENCE NUMBERS AND DO NOT MENTION THE ORIGINAL REFERENCE NUMBERS OF THE TRUCK MANUFACTURERS IN THE INVOICE TO VEHICLE OWNERS OR TO ANYBODY ELSE. THE CUSTOMER TAKES HIS OWN RESPONSIBILITY IF HE DOES NOT COMPLY WITH WHAT ABOVE.

CAB. VIBRATION DAMPER



	Code	OEM new	OEM old
● Model	65255	1343100	
★ Application			
● 4 TRUCK			
★ CP 19F - CP/CR 19 - CP/CR 14 - CT 14 - CT 19			
● P-G-R-T TRUCK			
★ CP/CR 16/19 - CP/CR 19 - CP/CR 16 - CT 14 - CT 19 - CP 14 - CG 14 - CG 16 - CG 19			

SUP. CAB. LINK ROD



	Code	OEM new	OEM old
	64072	1781929	1343131
● 4 TRUCK			
★ CP 19F - CP/CR 19 - CP/CR 14			
● P-G-R-T TRUCK			
★ CP/CR 19 - CP/CR 16 - CP 14 - CG 14 - CG 16 - CG 19			

LEVEL VALVE

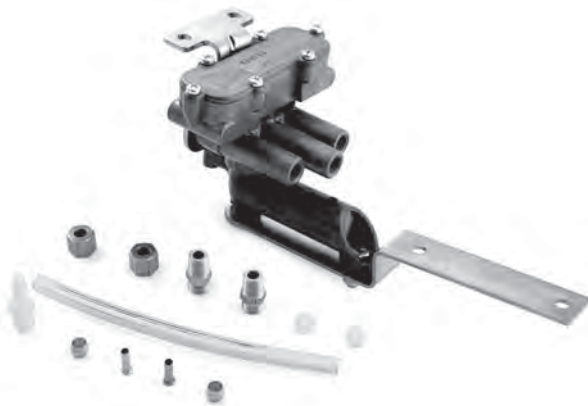

	Code	OEM new	OEM old
	61903	1118884	
● 3 TRUCK			
★ CG/CP/CR/CT 13 - CP 4X4 8X4 - CP/CR 19 4X2 6X2/4 6X4 8X4 - CT 19 - STRE-AMLINE			

LEVEL VALVE



	Code	OEM new	OEM old
	63646	1430545	1407139 1451839
● 4 TRUCK			
★ CP/CR/CT - CP/CR 14 - CP/CR 19			
● P-G-R-T TRUCK			
★ CP/CG 14/16/19 - CR16/16 - CP/CT			

ALL THE COMPONENTS LISTED IN OUR CATALOGUE ARE NOT ORIGINAL, THOUGH PERFECTLY INTERCHANGEABLE. REFERENCE NUMBERS, EITHER ORIGINAL OR OF A DIFFERENT NATURE, ARE FOR INFORMATION PURPOSES ONLY WHEN PLACING AN ORDER, PLEASE, ALWAYS USE COSIBO REFERENCE NUMBERS AND DO NOT MENTION THE ORIGINAL REFERENCE NUMBERS OF THE TRUCK MANUFACTURERS IN THE INVOICE TO VEHICLE OWNERS OR TO ANYBODY ELSE. THE CUSTOMER TAKES HIS OWN RESPONSIBILITY IF HE DOES NOT COMPLY WITH WHAT ABOVE.

CABIN LEVEL VALVE LINK L=125,50 MM



	Code	OEM new	OEM old
● Model	61648	1386423	1426199
★ Application			
● 4 TRUCK			
★	CR CH 1219154 - 2011266 - CH 4366923 - 5131637 - CH 9016603 - 9103389 - CH 3576359		
● P-G-R-T TRUCK			
★	CR CH 3604200		

CABIN LEVEL VALVE LINK L=40,5 MM



	61710	1372510	
● 4 TRUCK			
★	CP/CR14 CH 1243900 - 1265600 - CH 1265601 - 1280017 - CH 1280018 - CH 4400140 - 4442316 - CH 4442317 - 4471115 - CH 4471116 - CH 9036062 - 9057386 - CH 9057387 - 9069754 - CH 9069755 - CH 3508954 - 3524802 - CH 3524803 - 3533535 - CH 3533536 - CH 1294234 - CH 4508397 - CH 9086730 - CT CH 1243899 - CH 4400139 - CH 9036061 - CH 3508953 - CP/CR19 CT CH 1243900 - 1265600 - CH 1265601 - 1280017 - CH 4400140 - 4442316 - CH 4442317 - 4471115 - CH 9036062 - 9057386 - CH 9057387 - 9069754 - CH 3508954 - 3524802 - CH 3524803 - 3533535		
● P-G-R-T TRUCK			
★	CT CABIN		

CABIN LEVEL VALVE LINK L=55 MM



	64206	1386424	
● 4 TRUCK			
★	CP/CR CH 2011266 - CH 5131637 - CH 9103389 - CH 3576359		
● P-G-R-T TRUCK			
★	CP/CG 14/16/19 CR 16/19 CH 3604200 - CT		

ALL THE COMPONENTS LISTED IN OUR CATALOGUE ARE NOT ORIGINAL, THOUGH PERFECTLY INTERCHANGEABLE. REFERENCE NUMBERS, EITHER ORIGINAL OR OF A DIFFERENT NATURE, ARE FOR INFORMATION PURPOSES ONLY WHEN PLACING AN ORDER, PLEASE, ALWAYS USE COSIBO REFERENCE NUMBERS AND DO NOT MENTION THE ORIGINAL REFERENCE NUMBERS OF THE TRUCK MANUFACTURERS IN THE INVOICE TO VEHICLE OWNERS OR TO ANYBODY ELSE. THE CUSTOMER TAKES HIS OWN RESPONSIBILITY IF HE DOES NOT COMPLY WITH WHAT ABOVE.

4 POINTS CAB FRONT SHOCK ABSORBER FOR TRACTOR



	Code	OEM new	OEM old
● Model	62266	1424227	1363120
★ Application			
● 4 TRUCK			
★	CR CH 1291876 - CH 1291877 - CH 4500364 - CH 4500365 - CH 9083194 - CH 9083195 - CH 3544687 - CH 3544688 - CP CH 1291876 - CH 4500364 - CH 9083194 - CH 3544687		
● P-G-R-T TRUCK			
★	CR16/ 19 - CG		

4 POINTS REAR CAB SHOCK ABSORBER



	Code	OEM new	OEM old
	62267	1435856	
● 4 TRUCK			
★	CR14 CH 1292428 - CH 4501900 - CH 9083916 - CH 3547307 - CR19 CH 1292428 - CH 4501900 - CH 9083916 - CH 3547307		

CABIN SHOCK ABSORBER



	Code	OEM new	OEM old
	60438	1348117	
● 3 TRUCK			
★			

ALL THE COMPONENTS LISTED IN OUR CATALOGUE ARE NOT ORIGINAL, THOUGH PERFECTLY INTERCHANGEABLE. REFERENCE NUMBERS, EITHER ORIGINAL OR OF A DIFFERENT NATURE, ARE FOR INFORMATION PURPOSES ONLY WHEN PLACING AN ORDER, PLEASE, ALWAYS USE COSIBO REFERENCE NUMBERS AND DO NOT MENTION THE ORIGINAL REFERENCE NUMBERS OF THE TRUCK MANUFACTURERS IN THE INVOICE TO VEHICLE OWNERS OR TO ANYBODY ELSE. THE CUSTOMER TAKES HIS OWN RESPONSIBILITY IF HE DOES NOT COMPLY WITH WHAT ABOVE.

SHOCK ABSORBER



	Code	OEM new	OEM old
● Model	62211	1382827	
★ Application			
● 4 TRUCK			
★ CP19/CP19F - CP/CR14 - CR19			

FRONT AND REAR CAB SHOCK ABSORBER



	62296	1424231	1349840
● 4 TRUCK			
★ CP19F - 2 POINTS - REAR - CR CH 1291876 - CH 1291877 - CH 4500364 - CH 4500365 - CH 9083194 - CH 9083195 - CH 3544687 - CH 3544688 - 4 POINTS - FRONT - CP19 CH 1292428 - CH 4501900 - CH 9083916 - CH 3547307 - 52 POINTS - REAR - CP14 CH 1292428 - CH 4501900 - CH 9083916 - CH 3547307 - 2 POINTS - REAR - CP14/CR14 CH 1292429 - CH 4501901 - CH 9083917 - CH 3547308 - 4 POINTS - REAR - CP/CR19 CH 1292429 - CH 4501901 - CH 9083917 - CH 3547308 - 4 POINTS - REAR - CR14 CH 1292428 - CH 4501900 - CH 9083916 - CH 3547307 4 POINTS - REAR - CR19 CH 1292428 - CH 4501900 - CH 9083916 - CH 3547308 2 & 4 POINTS/2 & 4 PUNTI - REAR			
● P-G-R-T TRUCK			
★ CR16/19 4 POINTS - FRONT - CP/CR16 4 POINTS - REAR - CP19 LOW - NORMAL - HIGH - CR19 LOW - NORMAL 4 POINTS - REAR - CP14 4 POINTS - REAR - CG 4 POINTS - FRONT - CG14 4 POINTS - REAR - CG16 4 POINTS REAR - CG19 4 POINTS - REAR			

ALL THE COMPONENTS LISTED IN OUR CATALOGUE ARE NOT ORIGINAL, THOUGH PERFECTLY INTERCHANGEABLE. REFERENCE NUMBERS, EITHER ORIGINAL OR OF A DIFFERENT NATURE, ARE FOR INFORMATION PURPOSES ONLY WHEN PLACING AN ORDER, PLEASE, ALWAYS USE COSIBO REFERENCE NUMBERS AND DO NOT MENTION THE ORIGINAL REFERENCE NUMBERS OF THE TRUCK MANUFACTURERS IN THE INVOICE TO VEHICLE OWNERS OR TO ANYBODY ELSE. THE CUSTOMER TAKES HIS OWN RESPONSIBILITY IF HE DOES NOT COMPLY WITH WHAT ABOVE.

CABIN SHOCK ABSORBER



- Model
- ★ Application

Code	OEM new	OEM old
62322	1476415	

- 4 TRUCK
- ★ CP/CR/CT 19F - CP/CR/CT 14
- P-G-R-T TRUCK
- ★ CP/CR 16/19 - CT 14/19 - CG

CABIN SHOCK ABSORBER



- 4 TRUCK
- ★ CR
- P-G-R-T TRUCK
- ★ CR 16/19 - CG

61368	1435859	
-------	---------	--

CABIN SHOCK ABSORBER



- 4 TRUCK
- ★ 8X8 WLS/ZLS CR19 - CP 28/31
- P-G-R-T TRUCK
- ★ CR 16/19 - CR 19 - CP 28/31 - CG 19

64061	1444016	312465
-------	---------	--------

ALL THE COMPONENTS LISTED IN OUR CATALOGUE ARE NOT ORIGINAL, THOUGH PERFECTLY INTERCHANGEABLE. REFERENCE NUMBERS, EITHER ORIGINAL OR OF A DIFFERENT NATURE, ARE FOR INFORMATION PURPOSES ONLY WHEN PLACING AN ORDER, PLEASE, ALWAYS USE COSIBO REFERENCE NUMBERS AND DO NOT MENTION THE ORIGINAL REFERENCE NUMBERS OF THE TRUCK MANUFACTURERS IN THE INVOICE TO VEHICLE OWNERS OR TO ANYBODY ELSE. THE CUSTOMER TAKES HIS OWN RESPONSIBILITY IF HE DOES NOT COMPLY WITH WHAT ABOVE.

SHOCK ABSORBER



	Code	OEM new	OEM old
● Model	64741	1502468	
★ Application			
● 4 TRUCK			
★	CP/CR 14/19 CH 1292429 - CH 4501901 - CH 9083917 - CH 3547308		
● P-G-R-T TRUCK			
★	CR16/19 - CP/CR16 - CP19 LOW - NORMAL - HIGH - CR19 LOW - NORMAL - CG/CP14 - CG16/19		

ALL THE COMPONENTS LISTED IN OUR CATALOGUE ARE NOT ORIGINAL, THOUGH PERFECTLY INTERCHANGEABLE. REFERENCE NUMBERS, EITHER ORIGINAL OR OF A DIFFERENT NATURE, ARE FOR INFORMATION PURPOSES ONLY WHEN PLACING AN ORDER, PLEASE, ALWAYS USE COSIBO REFERENCE NUMBERS AND DO NOT MENTION THE ORIGINAL REFERENCE NUMBERS OF THE TRUCK MANUFACTURERS IN THE INVOICE TO VEHICLE OWNERS OR TO ANYBODY ELSE. THE CUSTOMER TAKES HIS OWN RESPONSIBILITY IF HE DOES NOT COMPLY WITH WHAT ABOVE.

	Code	OEM new	OEM old
SLIDER	62540	1877664	
<ul style="list-style-type: none"> ● Model ★ Application 			
<ul style="list-style-type: none"> ● 4 TRUCK ★ 			



LH CAB MOLDING	62484	1504019	1366837
<ul style="list-style-type: none"> ● 4 TRUCK ★ CT 			
<ul style="list-style-type: none"> ● P-G-R-T TRUCK ★ CT 			



RH CAB MOLDING	62485	1504020	1366838
<ul style="list-style-type: none"> ● 4 TRUCK ★ CT 			
<ul style="list-style-type: none"> ● P-G-R-T TRUCK ★ CT 			



HOOD RUBBER RING	64102	1520867	1366836 1441240
<ul style="list-style-type: none"> ● 4 TRUCK ★ CT 			
<ul style="list-style-type: none"> ● P-G-R-T TRUCK ★ CT 			



ALL THE COMPONENTS LISTED IN OUR CATALOGUE ARE NOT ORIGINAL, THOUGH PERFECTLY INTERCHANGEABLE. REFERENCE NUMBERS, EITHER ORIGINAL OR OF A DIFFERENT NATURE, ARE FOR INFORMATION PURPOSES ONLY WHEN PLACING AN ORDER, PLEASE, ALWAYS USE COSIBO REFERENCE NUMBERS AND DO NOT MENTION THE ORIGINAL REFERENCE NUMBERS OF THE TRUCK MANUFACTURERS IN THE INVOICE TO VEHICLE OWNERS OR TO ANYBODY ELSE. THE CUSTOMER TAKES HIS OWN RESPONSIBILITY IF HE DOES NOT COMPLY WITH WHAT ABOVE.

	Code	OEM new	OEM old
SEALING	62488	1346601	
<ul style="list-style-type: none"> ● Model ★ Application 			
<ul style="list-style-type: none"> ● 4 TRUCK ★ CT 			
<ul style="list-style-type: none"> ● P-G-R-T TRUCK ★ CT 			



MOLDING	62536	1366781	
<ul style="list-style-type: none"> ● 4 TRUCK ★ 			
<ul style="list-style-type: none"> ● P-G-R-T TRUCK ★ 			



MOLDING	62537	1366735	
<ul style="list-style-type: none"> ● 4 TRUCK ★ 			
<ul style="list-style-type: none"> ● P-G-R-T TRUCK ★ CG/CP/CR/CT 			



RUBBER BUFFER	62486	1341110	
<ul style="list-style-type: none"> ● 4 TRUCK ★ CP - CR 			
<ul style="list-style-type: none"> ● P-G-R-T TRUCK ★ CP - CG - CR 			



ALL THE COMPONENTS LISTED IN OUR CATALOGUE ARE NOT ORIGINAL, THOUGH PERFECTLY INTERCHANGEABLE. REFERENCE NUMBERS, EITHER ORIGINAL OR OF A DIFFERENT NATURE, ARE FOR INFORMATION PURPOSES ONLY WHEN PLACING AN ORDER, PLEASE, ALWAYS USE COSIBO REFERENCE NUMBERS AND DO NOT MENTION THE ORIGINAL REFERENCE NUMBERS OF THE TRUCK MANUFACTURERS IN THE INVOICE TO VEHICLE OWNERS OR TO ANYBODY ELSE. THE CUSTOMER TAKES HIS OWN RESPONSIBILITY IF HE DOES NOT COMPLY WITH WHAT ABOVE.

	Code	OEM new	OEM old
RUBBER BUFFER	62487	1522464	1385829
<ul style="list-style-type: none"> ● Model ★ Application 			
<ul style="list-style-type: none"> ● 4 TRUCK ★ 			
<ul style="list-style-type: none"> ● P-G-R-T TRUCK ★ 			

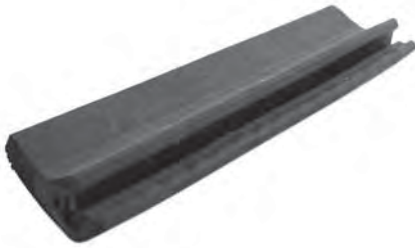

DOOR SEALING	62294	1346425	1306379
---------------------	--------------	---------	---------



<ul style="list-style-type: none"> ● 3 TRUCK ★
--

DOOR SEALING	62319	336590	
---------------------	--------------	--------	--



<ul style="list-style-type: none"> ● 3 TRUCK ★
--

ALL THE COMPONENTS LISTED IN OUR CATALOGUE ARE NOT ORIGINAL, THOUGH PERFECTLY INTERCHANGEABLE. REFERENCE NUMBERS, EITHER ORIGINAL OR OF A DIFFERENT NATURE, ARE FOR INFORMATION PURPOSES ONLY WHEN PLACING AN ORDER, PLEASE, ALWAYS USE COSIBO REFERENCE NUMBERS AND DO NOT MENTION THE ORIGINAL REFERENCE NUMBERS OF THE TRUCK MANUFACTURERS IN THE INVOICE TO VEHICLE OWNERS OR TO ANYBODY ELSE. THE CUSTOMER TAKES HIS OWN RESPONSIBILITY IF HE DOES NOT COMPLY WITH WHAT ABOVE.

	Code	OEM new	OEM old
WINDSCREEN SEALING	62422	1366851	

- Model
- ★ Application

● 4 TRUCK

★



ALL THE COMPONENTS LISTED IN OUR CATALOGUE ARE NOT ORIGINAL, THOUGH PERFECTLY INTERCHANGEABLE. REFERENCE NUMBERS, EITHER ORIGINAL OR OF A DIFFERENT NATURE, ARE FOR INFORMATION PURPOSES ONLY WHEN PLACING AN ORDER, PLEASE, ALWAYS USE COSIBO REFERENCE NUMBERS AND DO NOT MENTION THE ORIGINAL REFERENCE NUMBERS OF THE TRUCK MANUFACTURERS IN THE INVOICE TO VEHICLE OWNERS OR TO ANYBODY ELSE. THE CUSTOMER TAKES HIS OWN RESPONSIBILITY IF HE DOES NOT COMPLY WITH WHAT ABOVE.

SHOCK ABSORBER



● Model

★ Application

Code

OEM new

OEM old

61850

272400

● 3 TRUCK

★ HK 4X4 6X6 - ADA 4X2A 6X2/4A - ADA+ASA 6X2A/B

SHOCK ABSORBER



● 3 TRUCK

★ 4X2 6X2 6X2/4 AD - AD90 HL 4X2 6X2

66623

258420

FRONT AXLE SHOCK ABSORBER



● 4 TRUCK

★ P/R 8X2/8X4 (2X30 2X32 3X29) PARABOLIC SPRING - P/R 8X2*6 (2X30 2X32 3X29) PARABOLIC SPRING - P/R AM620 - AM920 - B4X2 - B6X4 PARABOLIC SPRING

● P-G-R-T TRUCK

★ P/R.8X2*6 2X30.2X32.3X29 PARABOLIC SPRING

63769

1861118

1388417

1420474

1421062

1861117

ALL THE COMPONENTS LISTED IN OUR CATALOGUE ARE NOT ORIGINAL, THOUGH PERFECTLY INTERCHANGEABLE. REFERENCE NUMBERS, EITHER ORIGINAL OR OF A DIFFERENT NATURE, ARE FOR INFORMATION PURPOSES ONLY WHEN PLACING AN ORDER, PLEASE, ALWAYS USE COSIBO REFERENCE NUMBERS AND DO NOT MENTION THE ORIGINAL REFERENCE NUMBERS OF THE TRUCK MANUFACTURERS IN THE INVOICE TO VEHICLE OWNERS OR TO ANYBODY ELSE. THE CUSTOMER TAKES HIS OWN RESPONSIBILITY IF HE DOES NOT COMPLY WITH WHAT ABOVE.

SHACKLE SPRING W/BUSHING



	Code	OEM new	OEM old
● Model	63556/1	1377739	1103026
★ Application			

● P-G-R-T TRUCK			
★ (PARABOLIC FRONT SPRING) 2X30 2X32 3X29 4X28 - 2X32 3X29 AMD900 AMD901 - (SUSPENSION SPRING) 2X30/32 3X29 4X28 7/9X15 8X2 8X4 8X2/6 ALSO REAR - (TRAPEZOIDAL FRONT SPRING) 7X15 9X15 - 7X15 AMD900 AMD901			

SHACKLE SPRING W/O BUSH



	63556/2	63556/2	
--	---------	---------	--

● P-G-R-T TRUCK			
★ (PARABOLIC FRONT SPRING) 2X30 2X32 3X29 4X28 - 2X32 3X29 AMD900 AMD901 - (SUSPENSION SPRING) 2X30/32 3X29 4X28 7/9X15 8X2 8X4 8X2/6 ALSO REAR - (TRAPEZOIDAL FRONT SPRING) 7X15 9X15 - 7X15 AMD900 AMD901			

REPAIR SET



	63898	552004	
--	-------	--------	--

● 3 TRUCK			
★ AS90			

ALL THE COMPONENTS LISTED IN OUR CATALOGUE ARE NOT ORIGINAL, THOUGH PERFECTLY INTERCHANGEABLE. REFERENCE NUMBERS, EITHER ORIGINAL OR OF A DIFFERENT NATURE, ARE FOR INFORMATION PURPOSES ONLY WHEN PLACING AN ORDER, PLEASE, ALWAYS USE COSIBO REFERENCE NUMBERS AND DO NOT MENTION THE ORIGINAL REFERENCE NUMBERS OF THE TRUCK MANUFACTURERS IN THE INVOICE TO VEHICLE OWNERS OR TO ANYBODY ELSE. THE CUSTOMER TAKES HIS OWN RESPONSIBILITY IF HE DOES NOT COMPLY WITH WHAT ABOVE.

U BOLT



- Model
- ★ Application

Code

OEM new

OEM old

65298

276228

- 3 BUS

- ★ AM 7X15

- 3 TRUCK

- ★ AM56/61 - AM70 - AM800

U BOLT



- 3 TRUCK

- ★ AM56/61

- 4 TRUCK

- ★ 2X30/32 3X29 4X28 7/9X15 8X2 8X4 8X2/6

- P-G-R-T TRUCK

- ★ 2X30/32 3X29 4X28 7/9X15 8X2 8X4 8X2/6

64068

1726130

1384353

U BOLT



- 3 TRUCK

- ★ ASA70/80 - ADA90

- 4 TRUCK

- ★ ADA1300 4X2 6X2 - ASA70 6X2 - ASA80

61550

1377799

363990

ALL THE COMPONENTS LISTED IN OUR CATALOGUE ARE NOT ORIGINAL, THOUGH PERFECTLY INTERCHANGEABLE. REFERENCE NUMBERS, EITHER ORIGINAL OR OF A DIFFERENT NATURE, ARE FOR INFORMATION PURPOSES ONLY WHEN PLACING AN ORDER, PLEASE, ALWAYS USE COSIBO REFERENCE NUMBERS AND DO NOT MENTION THE ORIGINAL REFERENCE NUMBERS OF THE TRUCK MANUFACTURERS IN THE INVOICE TO VEHICLE OWNERS OR TO ANYBODY ELSE. THE CUSTOMER TAKES HIS OWN RESPONSIBILITY IF HE DOES NOT COMPLY WITH WHAT ABOVE.

REPAIR SET



● Model

★ Application

Code

OEM new

OEM old

65380

65380

● 3 TRUCK

★ ASA70/80 - ADA90

● 4 TRUCK

★ ADA1300 4X2 6X2 - ASA70 6X2 - ASA80

SPRING BOLT



61313

1548054

255315

● 3 TRUCK

★ ASA80 ELC - 4X2A 6X2/4A ADA CH 1159364 - CH 4290503 - ML4X2A/B 6X2A/B 6X2/4A ADA ASA CH 1159365 - CH 4292504 - ML6X2A ADA ASA70 CH 1159364 - CH 4290503 - MA/MV4X2A MV4X2B ADA90 - MW4X2A/B ADA90 CH 1217086 - CH 1217087 - CH 4356549 - CH 4356550 - CH 9012600 - CH 9012601 - ML6X4A/B ADA ASA - MV6X2B ADA ASA - MA6X2A ADA90 ASA70 ASA80 - 6X2/4 ADA CH 1185688 - CH 4318985 - HL6X2A/B 6X4A/B 8X2A ADA ASA - ALL FOR PNEUMATIC SUSPENSION

● 4 TRUCK

★ ASA80 ELC - ADA1300 ELC 1.LA4X2NA.NB - 1.LB6X2NA.NB - ASA70 ELC LB6X2NA.NB - ADA1300/1500/1501 4X2 6X2 6X2*4 8X2 8X2/4 8X2*6 - ASA700 6X2 8X2 - ASA100 6X2 8X2 8X2/4 - ARA900 6X2*4 8X2*6 8X4*4 - ADA1100 6X2 4X2 CH 1247519 - CH 4406944 - CH 9039630 - CH 3507980 - ADA1100 4X2 CH 1247518 - CH 4406943 - CH 9039629 - CH 3507979 - ADA1100 6X2 CH 1247518 - CH 1247519 - CH 4406943 - CH 4406944 - CH 9039629 - CH 9039630 - CH 3507979 - CH 3507980 - 6X2/4L, REAR CH 1247518 - CH 4406943 - CH 9039629 - CH 3507979 ALL FOR PNEUMATIC SUSPENSION

● P-G-R-T TRUCK

★ ADA 4X2 6X2 6X4 6X2*4 8X2 8X2*6 8X4 8X4*4 - ASA 6X2 - ARA 6X2*4 8X2*6 ALL FOR PNEUMATIC SUSPENSION

● 3 BUS

★ ASA - ATA90 -

SPRING BOLT L=248 mm



	Code	OEM new	OEM old
● Model	64726	1548055	1338491
★ Application			
● 3 TRUCK			
★ ADA - ASA			
● 4 TRUCK			
★ ADA1300/1500/1501 - ASA700/1000 - ARA900 - ADA1100 - ADA1100 F958			
● P-G-R-T TRUCK			
★ ADA 4X2 6X2 6X2/4 6X4 8X2 8X2/6 8X4 8X4/4 - ASA 6X2 - ARA6X2/4 8X2/6 8X4/4 - ADA1300 8X4/4 F950/F958 AD FR - AD F RE - ADA1100 6X4 8X4 AD FR - AD RE - ADA1501P 6X4 8X4 8X4/4 AD FR - AD RE - ASA 8X2/4			
● 4 BUS			
★ F94 6X2			

RUBBER BUFFER



	60962	241922	
● 3 TRUCK			
★ AM - ADA - ADA+ASA - ARA			

RUBBER BUFFER





	60961	153287	
● 3 TRUCK			
★ AM - AD/AS90 - ADA - ASA - ADA+ASA - AS60 - ARA			

ALL THE COMPONENTS LISTED IN OUR CATALOGUE ARE NOT ORIGINAL, THOUGH PERFECTLY INTERCHANGEABLE. REFERENCE NUMBERS, EITHER ORIGINAL OR OF A DIFFERENT NATURE, ARE FOR INFORMATION PURPOSES ONLY WHEN PLACING AN ORDER, PLEASE, ALWAYS USE COSIBO REFERENCE NUMBERS AND DO NOT MENTION THE ORIGINAL REFERENCE NUMBERS OF THE TRUCK MANUFACTURERS IN THE INVOICE TO VEHICLE OWNERS OR TO ANYBODY ELSE. THE CUSTOMER TAKES HIS OWN RESPONSIBILITY IF HE DOES NOT COMPLY WITH WHAT ABOVE.

	Code	OEM new	OEM old
WASHER 	61315	272449	
<ul style="list-style-type: none"> ● Model ★ Application 			
<ul style="list-style-type: none"> ● 3 TRUCK ★ ADA+ASA70 			
RUBBER BUFFER 	65242	423730	
<ul style="list-style-type: none"> ● 3 BUS ★ AD90 - ADA90 OSC11 - ADA90 			
<ul style="list-style-type: none"> ● 4 BUS ★ ADA1300 IB/EB 			
RUBBER RING 	62238	307113	
<ul style="list-style-type: none"> ● 3 BUS ★ AD - AM 			
<ul style="list-style-type: none"> ● 3 TRUCK ★ AM - AMA - AD90 - AD/ADA - ADA+ASA - ARA 			
<ul style="list-style-type: none"> ● 4 TRUCK ★ 94 - 114 - 124 - 144 - 164 			
<ul style="list-style-type: none"> ● F-K-N BUS ★ 			
<ul style="list-style-type: none"> ● P-G-R-T TRUCK ★ 			

ALL THE COMPONENTS LISTED IN OUR CATALOGUE ARE NOT ORIGINAL, THOUGH PERFECTLY INTERCHANGEABLE. REFERENCE NUMBERS, EITHER ORIGINAL OR OF A DIFFERENT NATURE, ARE FOR INFORMATION PURPOSES ONLY WHEN PLACING AN ORDER, PLEASE, ALWAYS USE COSIBO REFERENCE NUMBERS AND DO NOT MENTION THE ORIGINAL REFERENCE NUMBERS OF THE TRUCK MANUFACTURERS IN THE INVOICE TO VEHICLE OWNERS OR TO ANYBODY ELSE. THE CUSTOMER TAKES HIS OWN RESPONSIBILITY IF HE DOES NOT COMPLY WITH WHAT ABOVE.

	Code	OEM new	OEM old
RUBBER BUFFER	61220	213604	
	● Model		
	★ Application		
	● 3 BUS		
	★ AM/AMA		
	● 3 TRUCK		
	★ AM56/61/70 - AMD105		
	● 4 TRUCK		
	★ AMD900/901 - AMA		
	● P-G-R-T TRUCK		
	★		

	Code	OEM new	OEM old
RUBBER BUFFER	61303	228483	
	● 3 BUS		
	★ AM/AMA		
	● 3 TRUCK		
	★ AM56/61/70 - AMD105		
	● 4 TRUCK		
	★ AMD900/901 - AMA		
	● P-G-R-T TRUCK		
	★		

ALL THE COMPONENTS LISTED IN OUR CATALOGUE ARE NOT ORIGINAL, THOUGH PERFECTLY INTERCHANGEABLE. REFERENCE NUMBERS, EITHER ORIGINAL OR OF A DIFFERENT NATURE, ARE FOR INFORMATION PURPOSES ONLY WHEN PLACING AN ORDER, PLEASE, ALWAYS USE COSIBO REFERENCE NUMBERS AND DO NOT MENTION THE ORIGINAL REFERENCE NUMBERS OF THE TRUCK MANUFACTURERS IN THE INVOICE TO VEHICLE OWNERS OR TO ANYBODY ELSE. THE CUSTOMER TAKES HIS OWN RESPONSIBILITY IF HE DOES NOT COMPLY WITH WHAT ABOVE.

	Code	OEM new	OEM old
RUBBER BUSHING	61305	1477867	1429110 310808
● Model			
★ Application			
● 3 BUS			
★ AM56/61 - AD - ADA - AD90			
● 3 TRUCK			
★ AMA - AM56/61			
● 4 BUS			
★ ADA1300D EB - ADA1300 4X2 IB/UD - AD1300 - ADA1300 6X2 IB/UB 8X2 IB - AM - ASA701			
● 4 TRUCK			
★ AMA			
● F-K-N BUS			
★			
● P-G-R-T TRUCK			
★ 4X2 6X2 6X2/2 8X2 - 6X4 8X4 BT201/300			



RUBBER BUFFER	60580	306902	
● 3 BUS			
★ ADA - AMA - ADA90 OSC11			
● 3 TRUCK			
★ AM56/61/70 - AMD105 - AM800/820			
● 4 BUS			
★ ADA1300 IB/EB/UB - ASA1300			
● F-K-N BUS			
★ ADA/ASA1300			



	Code	OEM new	OEM old
RUBBER RING	61734	339188	
<ul style="list-style-type: none"> ● Model ★ Application 			
<ul style="list-style-type: none"> ● 3 BUS ★ AM - AMI - ASA 			
<ul style="list-style-type: none"> ● 3 TRUCK ★ AM/AMA - ADA - ADA+ASA 			
<ul style="list-style-type: none"> ● 4 BUS ★ AM 			
<ul style="list-style-type: none"> ● 4 TRUCK ★ AMD900/901 - AM620/621/740/820/900/920 - ADA1300 - ASA70/80 - AD1300 BT 200I/B BT201I/B - AD1100P/1500P - AD1100P BT200I/B BT201I/B 			
<ul style="list-style-type: none"> ● P-G-R-T TRUCK ★ P/R 			



RUBBER BUFFER	62233	1344190	
<ul style="list-style-type: none"> ● 3 TRUCK ★ AMA - AD 			
<ul style="list-style-type: none"> ● 4 BUS ★ AMA860 			
<ul style="list-style-type: none"> ● 4 TRUCK ★ AMA - ARA820 - AMD900/901 - BT200I/B BT201I/B BT300I/B - BT300I 6X6 			
<ul style="list-style-type: none"> ● P-G-R-T TRUCK ★ BT201/300 6X4 8X4 - 6X2/4 8X2/4 			



RUBBER BUFFER	62235	423736	
<ul style="list-style-type: none"> ● 3 BUS ★ AM/AMA 			
<ul style="list-style-type: none"> ● 4 BUS ★ AMA - AMA FR RE 8X2 			



	Code	OEM new	OEM old
LH RUBBER BUFFER	62236	1322341	
	<ul style="list-style-type: none"> ● Model ★ Application 		
	<ul style="list-style-type: none"> ● 4 TRUCK ★ 2X30/32 3X29 4X28 7/9X15 8X2 8X4 8X2/6 - 2X3 3X29 7X15 AMD900/901 - 8X8 WLS/ZLS 3X29 AMD900 FR/RE - 8X8 2X32 AMD900/901 FR/RE 		
	<ul style="list-style-type: none"> ● P-G-R-T TRUCK ★ 2X30 2X32 3X29 4X28 7X15 8X2 8X4 8X2/6 9X15 - 2X32 3X29 7X15 AMD900/901 		
RH RUBBER BUFFER	62237	1324366	
	<ul style="list-style-type: none"> ● 4 TRUCK ★ 2X30/32 3X29 4X28 7/9X15 8X2 8X4 8X2/6 - 2X3 3X29 7X15 AMD900/901 - 8X8 WLS/ZLS 3X29 AMD900 FR/RE - 8X8 2X32 AMD900/901 FR/RE 		
	<ul style="list-style-type: none"> ● P-G-R-T TRUCK ★ 2X30 2X32 3X29 4X28 7X15 8X2 8X4 8X2/6 9X15 - 2X32 3X29 7X15 AMD900/901 		
SPACER TUBE	61306	213606	
	<ul style="list-style-type: none"> ● 3 BUS ★ AM56/61 		
	<ul style="list-style-type: none"> ● 3 TRUCK ★ AM56/61/70 - AMD105 		
	<ul style="list-style-type: none"> ● 4 BUS ★ AM 		
	<ul style="list-style-type: none"> ● F-K-N BUS ★ AM 		

ALL THE COMPONENTS LISTED IN OUR CATALOGUE ARE NOT ORIGINAL, THOUGH PERFECTLY INTERCHANGEABLE. REFERENCE NUMBERS, EITHER ORIGINAL OR OF A DIFFERENT NATURE, ARE FOR INFORMATION PURPOSES ONLY WHEN PLACING AN ORDER, PLEASE, ALWAYS USE COSIBO REFERENCE NUMBERS AND DO NOT MENTION THE ORIGINAL REFERENCE NUMBERS OF THE TRUCK MANUFACTURERS IN THE INVOICE TO VEHICLE OWNERS OR TO ANYBODY ELSE. THE CUSTOMER TAKES HIS OWN RESPONSIBILITY IF HE DOES NOT COMPLY WITH WHAT ABOVE.

		Code	OEM new	OEM old
BUSHING	● Model	61307	213607	
	★ Application			
	● 3 BUS			
	★ AM56/61			
	● 3 TRUCK			
	★ AM56/61/70 - AMD105			
● 4 BUS				
★ AM				
NUT M30X3,5		61314	811911	816089
	● 3 TRUCK			
	★ ASA80 ELC 1.19 TONS - ADA - ADA90 - ASA70/80 - R113/143			
	● 4 TRUCK			
	★ ADA1300 ELC 1.LA4X2NA NB - 1LB6X2NA NB - ASA80 ELC 1.19 TONS - ASA70 ELC 1.19 9 TONS LB6X2 NA NB - ADA1300/1500/1501 4X2 6X2/4 6X4 8X4 - ASA700 6X2 8X2 - ASA1000 6X2 8X2 8X2/4 - ARA900 6X2/4 8X2/6 8X4/4 - ADA1100 4X2 6X2 - ADA1300 8X4/4 F958 AD FR - AD RE - ADA1100 6X4 8X4 F958 AD FR - AD RE			
	● P-G-R-T TRUCK			
	★ ADA 4X2 6X2 6X2/4 6X4 8X2 8X2/6 8X4 8X4/4 - ASA 6X2 8X2/4 - ARA 6X2/4 8X2/6 8X4/4 - ADA1300 8X4/4 F950/F958 AD FR - AD RE - ADA1100 6X4 8X4 AD FR - AD RE - ADA1300 6X4 8X4 AD FR - AD R - ADA1501P 6X4 8X4 8X4/4 AD FR - AD RE			
	● 3 BUS			
	★ ASA - ATA90			
	● 4 BUS			
	★ F94 6X2			

ALL THE COMPONENTS LISTED IN OUR CATALOGUE ARE NOT ORIGINAL, THOUGH PERFECTLY INTERCHANGEABLE. REFERENCE NUMBERS, EITHER ORIGINAL OR OF A DIFFERENT NATURE, ARE FOR INFORMATION PURPOSES ONLY WHEN PLACING AN ORDER, PLEASE, ALWAYS USE COSIBO REFERENCE NUMBERS AND DO NOT MENTION THE ORIGINAL REFERENCE NUMBERS OF THE TRUCK MANUFACTURERS IN THE INVOICE TO VEHICLE OWNERS OR TO ANYBODY ELSE. THE CUSTOMER TAKES HIS OWN RESPONSIBILITY IF HE DOES NOT COMPLY WITH WHAT ABOVE.

MOUNTING KIT



	Code	OEM new	OEM old
● Model	64739	64739	
★ Application			
● 3 BUS			
★ ASA - ATA90 -			
● 3 TRUCK			
★ ASA80 ELC - 4X2A 6X2/4A ADA CH 1159364 - CH 4290503 - ML4X2A/B 6X2A/B 6X2/4A ADA ASA CH 1159365 - CH 4292504 - ML6X2A ADA ASA70 CH 1159364 - CH 4290503 - MA/MV4X2A MV4X2B ADA90 - MW4X2A/B ADA90 CH 1217086 - CH 1217087 - CH 4356549 - CH 4356550 - CH 9012600 - CH 9012601 - ML6X4A/B ADA ASA - MV6X2B ADA ASA - MA6X2A ADA90 ASA70 ASA80 - 6X2/4 ADA CH 1185688 - CH 4318985 - HL6X2A/B 6X4A/B 8X2A ADA ASA - ALL FOR PNEUMATIC SUSPENSION			
● 4 TRUCK			
★ ASA80 ELC - ADA1300 ELC 1.LA4X2NA.NB - 1.LB6X2NA.NB - ASA70 ELC LB6X2NA.NB - ADA1300/1500/1501 4X2 6X2 6X2*4 8X2 8X2/4 8X2*6 - ASA700 6X2 8X2 - ASA100 6X2 8X2 8X2/4 - ARA900 6X2*4 8X2*6 8X4*4 - ADA1100 6X2 4X2 CH 1247519 - CH 4406944 - CH 9039630 - CH 3507980 - ADA1100 4X2 CH 1247518 - CH 4406943 - CH 9039629 - CH 3507979 - ADA1100 6X2 CH 1247518 - CH 1247519 - CH 4406943 - CH 4406944 - CH 9039629 - CH 9039630 - CH 3507979 - CH 3507980 - 6X2/4L, REAR CH 1247518 - CH 4406943 - CH 9039629 - CH 3507979 ALL FOR PNEUMATIC SUSPENSION			
● P-G-R-T TRUCK			
★ ADA 4X2 6X2 6X4 6X2*4 8X2 8X2*6 8X4 8X4*4 - ASA 6X2 - ARA 6X2*4 8X2*6 ALL FOR PNEUMATIC SUSPENSION			

MOUNTING KIT



	64738	64738	
● 3 TRUCK			
★ ADA - ASA			
● 4 TRUCK			
★ ADA1300/1500/1501 - ASA700/1000 - ARA900 - ADA1100 - ADA1100 F958			
● P-G-R-T TRUCK			
★ ADA 4X2 6X2 6X2/4 6X4 8X2 8X2/6 8X4 8X4/4 - ASA 6X2 - ARA6X2/4 8X2/6 8X4/4 - ADA1300 8X4/4 F950/F958 AD FR - AD F RE - ADA1100 6X4 8X4 AD FR - AD RE - ADA1501P 6X4 8X4 8X4/4 AD FR - AD RE - ASA 8X2/4			
● 4 BUS			
★ F94 6X2			

ALL THE COMPONENTS LISTED IN OUR CATALOGUE ARE NOT ORIGINAL, THOUGH PERFECTLY INTERCHANGEABLE. REFERENCE NUMBERS, EITHER ORIGINAL OR OF A DIFFERENT NATURE, ARE FOR INFORMATION PURPOSES ONLY WHEN PLACING AN ORDER, PLEASE, ALWAYS USE COSIBO REFERENCE NUMBERS AND DO NOT MENTION THE ORIGINAL REFERENCE NUMBERS OF THE TRUCK MANUFACTURERS IN THE INVOICE TO VEHICLE OWNERS OR TO ANYBODY ELSE. THE CUSTOMER TAKES HIS OWN RESPONSIBILITY IF HE DOES NOT COMPLY WITH WHAT ABOVE.

	Code	OEM new	OEM old
WASHER	61858	1367370	
<ul style="list-style-type: none"> ● Model ★ Application 			
<ul style="list-style-type: none"> ● 3 TRUCK 			
<ul style="list-style-type: none"> ★ ADA - ASA 			
<ul style="list-style-type: none"> ● 4 TRUCK 			
<ul style="list-style-type: none"> ★ ADA1300/1500/1501 - ASA700/1000 - ARA900 - ADA1100 - ADA1100 F958 			
<ul style="list-style-type: none"> ● P-G-R-T TRUCK 			
<ul style="list-style-type: none"> ★ ADA 4X2 6X2 6X2/4 6X4 8X2 8X2/6 8X4 8X4/4 - ASA 6X2 - ARA6X2/4 8X2/6 8X4/4 - ADA1300 8X4/4 F950/F958 AD FR - AD F RE - ADA1100 6X4 8X4 AD FR - AD RE - ADA1501P 6X4 8X4 8X4/4 AD FR - AD RE - ASA 8X2/4 			
<ul style="list-style-type: none"> ● 4 BUS 			
<ul style="list-style-type: none"> ★ F94 6X2 			



	Code	OEM new	OEM old
RUBBERED BUSHING	61859	1362710	255669
<ul style="list-style-type: none"> ● 3 TRUCK 			
<ul style="list-style-type: none"> ★ ASA80 ELC - 4X2A 6X2/4A ADA - ML4X2A/B 6X2A/B 6X2/4A ADA ASA - ML6X2A ADA ASA70 - MA/MV4X2A MV4X2B ADA90 - MW4X2A/B ADA90 - ML6X4A/B ADA ASA - MV6X2B ADA ASA - MA6X2A ADA90 ASA70 ASA80 - 6X2/4 ADA - HL6X2A/B 6X4A/B 8X2A ADA ASA - ALL FOR PNEUMATIC SUSPENSION 			
<ul style="list-style-type: none"> ● 4 TRUCK 			
<ul style="list-style-type: none"> ★ ASA80 ELC - ADA1300 ELC 1.LA4X2NA.NB - 1.LB6X2NA.NB - ASA70 ELC LB6X2NA.NB - ADA1300/1500/1501 4X2 6X2 6X2*4 8X2 8X2/4 8X2*6 - ASA700 6X2 8X2 - ASA100 6X2 8X2 8X2/4 - ARA900 6X2*4 8X2*6 8X4*4 - ADA1100 6X2 4X2 - ADA1100 4X2 - ADA1100 6X2 - 6X2/4L,REAR ALL FOR PNEUMATIC SUSPENSION 			
<ul style="list-style-type: none"> ● P-G-R-T TRUCK 			
<ul style="list-style-type: none"> ★ ADA 4X2 6X2 6X4 6X2*4 8X2 8X2*6 8X4 8X4*4 - ASA 6X2 - ARA 6X2*4 8X2*6 ALL FOR PNEUMATIC SUSPENSION 			
<ul style="list-style-type: none"> ● 3 BUS 			
<ul style="list-style-type: none"> ★ ASA - ATA90 			



RUBBERED BUSHING



- Model
 - ★ Application
- | | Code | OEM new | OEM old |
|--|--------------|---------|---------|
| | 60252 | 362385 | |
- **3 TRUCK**
 - ★ ML6X2A ADA - ASA70

SPRING BRACKET



- | | Code | OEM new | OEM old |
|--|--------------|---------|---------|
| | 60912 | 1377728 | 202335 |
- **3 TRUCK**
 - ★ PARABOLIC SPRING 4X23 5X22 AD6X2 8X2

SPRING BRACKET



- | | Code | OEM new | OEM old |
|--|--------------|---------|---------|
| | 60909 | 275460 | |
- **3 TRUCK**
 - ★ AM61/70 - AM800/820

ALL THE COMPONENTS LISTED IN OUR CATALOGUE ARE NOT ORIGINAL, THOUGH PERFECTLY INTERCHANGEABLE. REFERENCE NUMBERS, EITHER ORIGINAL OR OF A DIFFERENT NATURE, ARE FOR INFORMATION PURPOSES ONLY WHEN PLACING AN ORDER, PLEASE, ALWAYS USE COSIBO REFERENCE NUMBERS AND DO NOT MENTION THE ORIGINAL REFERENCE NUMBERS OF THE TRUCK MANUFACTURERS IN THE INVOICE TO VEHICLE OWNERS OR TO ANYBODY ELSE. THE CUSTOMER TAKES HIS OWN RESPONSIBILITY IF HE DOES NOT COMPLY WITH WHAT ABOVE.

SPRING BRACKET



● Model

★ Application

Code

OEM new

OEM old

60554

283642

● 3 TRUCK

★ F700 - F800 - F950 - F954

● 3 BUS

★ F950

SPRING BOLT



60914

355145

128681

● 3 TRUCK

★ AM56/61/70 - AMD105 - AM800/820

● 4 TRUCK

★ 8X2 8X4 8X2/6 8X8 - AMD900/901

● P-G-R-T TRUCK

★ 2X30 2X32 3X29 4X28 7X15 8X2 8X4 8X2/6 9X15 - 2X32 3X29 7X15
AMD900/901

● 3 BUS

★ AM56/61

● 4 BUS

★ 8X15 9X15 AM

● F-K-N BUS

★ 8X15 9X15 AM

ALL THE COMPONENTS LISTED IN OUR CATALOGUE ARE NOT ORIGINAL, THOUGH PERFECTLY INTERCHANGEABLE. REFERENCE NUMBERS, EITHER ORIGINAL OR OF A DIFFERENT NATURE, ARE FOR INFORMATION PURPOSES ONLY WHEN PLACING AN ORDER, PLEASE, ALWAYS USE COSIBO REFERENCE NUMBERS AND DO NOT MENTION THE ORIGINAL REFERENCE NUMBERS OF THE TRUCK MANUFACTURERS IN THE INVOICE TO VEHICLE OWNERS OR TO ANYBODY ELSE. THE CUSTOMER TAKES HIS OWN RESPONSIBILITY IF HE DOES NOT COMPLY WITH WHAT ABOVE.

SPRING BUSHING



	Code	OEM new	OEM old
● Model	60916	128680	
★ Application			
● 3 TRUCK			
★ AM56/61/70 - AMD105 - AM800/820			
● 4 TRUCK			
★ 8X2 8X4 8X2/6 8X8 - AMD900/901			
● P-G-R-T TRUCK			
★ 2X30 2X32 3X29 4X28 7X15 8X2 8X4 8X2/6 9X15 - 2X32 3X29 7X15 AMD900/901			
● 3 BUS			
★ AM56/61			
● 4 BUS			
★ 8X15 9X15 AM			
● F-K-N BUS			
★ 8X15 9X15 AM			

SPRING BOLT



	60913	355147	135035
● 3 TRUCK			
★ AD80/90/100 - AD1500P - ARA			
● 4 TRUCK			
★ AD1300 4X2 - AD1500P 4X2 4X4 - AD1501P 4X2 4X4 - ARA820 ARA760 6X2/4 8X2/4			
● P-G-R-T TRUCK			
★ 3X26 2X26 - 7X15 6X14 - 9X15 6X14 - 12X15.6X14 - 4X4 3X26.2X26 AD1500P - 4X4 9X15.6X14 AD1500P - ASA 6X2/2 ARA 6X2/4 - 8X2/4			
● 3 BUS			
★ AD 11X15 - AD90 9X15			
● 4 BUS			
★ 10X15 AD - AD1300 9X15			
● F-K-N BUS			
★ 9X15 10X15 AD			

ALL THE COMPONENTS LISTED IN OUR CATALOGUE ARE NOT ORIGINAL, THOUGH PERFECTLY INTERCHANGEABLE. REFERENCE NUMBERS, EITHER ORIGINAL OR OF A DIFFERENT NATURE, ARE FOR INFORMATION PURPOSES ONLY WHEN PLACING AN ORDER, PLEASE, ALWAYS USE COSIBO REFERENCE NUMBERS AND DO NOT MENTION THE ORIGINAL REFERENCE NUMBERS OF THE TRUCK MANUFACTURERS IN THE INVOICE TO VEHICLE OWNERS OR TO ANYBODY ELSE. THE CUSTOMER TAKES HIS OWN RESPONSIBILITY IF HE DOES NOT COMPLY WITH WHAT ABOVE.

	Code	OEM new	OEM old
SPRING BUSHING	60917	135036	
● Model			
★ Application			
● 3 TRUCK			
★ AD80/90/100 - AD1500P - ARA			
● 4 TRUCK			
★ AD1300 4X2 - AD1500P 4X2 4X4 - AD1501P 4X2 4X4 - ARA820 ARA760 6X2/4 8X2/4			
● P-G-R-T TRUCK			
★ 3X26 2X26 - 7X15 6X14 - 9X15 6X14 - 12X15.6X14 - 4X4 3X26.2X26 AD1500P - 4X4 9X15.6X14 AD1500P - ASA 6X2/2 ARA 6X2/4 - 8X2/4			
● 3 BUS			
★ AD 11X15 - AD90 9X15			
● 4 BUS			
★ 10X15 AD - AD1300 9X15			
● F-K-N BUS			
★ 9X15 10X15 AD			



	60920	355148	202333
SPRING BOLT			
● 3 TRUCK			
★ AD 6X2 8X2			
● 4 TRUCK			
★ AD 6X2 8X2			
● P-G-R-T TRUCK			
★ 5X22 - 1X15.10X13 - AD 6X2 8X2			



	60921	135698	
SPRING BUSHING			
● 3 TRUCK			
★ AD 6X2 8X2			
● 4 TRUCK			
★ AD 6X2 8X2			
● P-G-R-T TRUCK			
★ 5X22 - 1X15.10X13 - AD 6X2 8X2			

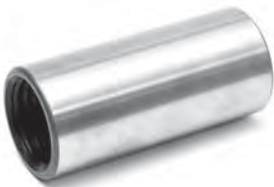

ALL THE COMPONENTS LISTED IN OUR CATALOGUE ARE NOT ORIGINAL, THOUGH PERFECTLY INTERCHANGEABLE. REFERENCE NUMBERS, EITHER ORIGINAL OR OF A DIFFERENT NATURE, ARE FOR INFORMATION PURPOSES ONLY WHEN PLACING AN ORDER, PLEASE, ALWAYS USE COSIBO REFERENCE NUMBERS AND DO NOT MENTION THE ORIGINAL REFERENCE NUMBERS OF THE TRUCK MANUFACTURERS IN THE INVOICE TO VEHICLE OWNERS OR TO ANYBODY ELSE. THE CUSTOMER TAKES HIS OWN RESPONSIBILITY IF HE DOES NOT COMPLY WITH WHAT ABOVE.

		Code	OEM new	OEM old
O-RING	● Model	60918	182929	
	★ Application			
	● 3 TRUCK			
	★	AM56/61/70 - AMD105 HK4X4 HK6X6 - AM800/820 - 8X2 8X4		
	● 4 TRUCK			
	★	2X30/32 3X29 4X28 7/9X15 8X2 8X4 8X2/6 - 2X32 3X29 7X15 8X8 AMD900/901 - 8X8 WLS/ZLS 3X29 AMD900		
	● P-G-R-T TRUCK			
	★	2X30 2X32 3X29 4X28 7X15 8X2 8X4 8X2/6 9X15 - 2X32 3X29 7X15 AMD900/901		
	● 3 BUS			
	★	AM56/61 - AM 7X15 8X15		
	● 4 BUS			
	★	8X15 9X15 AM		
● F-K-N BUS				
★	8X15 9X15 AM			



O-RING		60919	182931	
	● 3 TRUCK			
	★	AM56/61/70 - AMD105 HK4X4 HK6X6 - AM800/820 - 8X2 8X4		
	● 4 TRUCK			
	★	2X30/32 3X29 4X28 7/9X15 8X2 8X4 8X2/6 - 2X32 3X29 7X15 8X8 AMD900/901 - 8X8 WLS/ZLS 3X29 AMD900		
	● P-G-R-T TRUCK			
	★	2X30 2X32 3X29 4X28 7X15 8X2 8X4 8X2/6 9X15 - 2X32 3X29 7X15 AMD900/901		
	● 3 BUS			
	★	AM56/61 - AM 7X15 8X15		
	● 4 BUS			
	★	8X15 9X15 AM		
	● F-K-N BUS			
★	8X15 9X15 AM			



	Code	OEM new	OEM old
SPRING BRACKET SET	63813	63813	
<ul style="list-style-type: none"> ● Model ★ Application 			
<ul style="list-style-type: none"> ● P-G-R-T TRUCK 			
<ul style="list-style-type: none"> ★ 2X30 2X32 3X29 4X28 7X15 8X2 8X4 8X2/6 9X15 - 2X32 3X29 7X15 AMD900/901 COMPOSED BY: NO.1 PC 60914 - NO.1 PC 60916 - NO.2 PCS 60918 			
<ul style="list-style-type: none"> ● F-K-N BUS 			
<ul style="list-style-type: none"> ★ 8X15 9X15 AM COMPOSED BY: NO.1 PC 60914 - NO.1 PC 60916 - NO.2 PCS 60918 			
<ul style="list-style-type: none"> ● 4 BUS 			
<ul style="list-style-type: none"> ★ 8X15 9X15 AM COMPOSED BY: NO.1 PC 60914 - NO.1 PC 60916 - NO.2 PCS 60918 			
<ul style="list-style-type: none"> ● 4 TRUCK 			
<ul style="list-style-type: none"> ★ 8X2 8X4 8X2/6 8X8 - AMD900/901 COMPOSED BY: NO.1 PC 60914 - NO.1 PC 60916 - NO.2 PCS 60918 			
<ul style="list-style-type: none"> ● 3 BUS 			
<ul style="list-style-type: none"> ★ AM56/61 COMPOSED BY: NO.1 PC 60914 - NO.1 PC 60916 - NO.2 PCS 60918 			
<ul style="list-style-type: none"> ● 3 TRUCK 			
<ul style="list-style-type: none"> ★ AM56/61/70 - AMD105 - AM800/820 COMPOSED BY: NO.1 PC 60914 - NO.1 PC 60916 - NO.2 PCS 60918 			



	Code	OEM new	OEM old
SPRING BRACKET SET	63812	63812	
<ul style="list-style-type: none"> ● 4 BUS 			
<ul style="list-style-type: none"> ★ 10X15 AD - AD1300 9X15 COMPOSED BY: NO.1 PC 60913 - NO.1 PC 60917 - NO.2 PCS 60919 			
<ul style="list-style-type: none"> ● P-G-R-T TRUCK 			
<ul style="list-style-type: none"> ★ 3X26 2X26 - 7X15 6X14 - 9X15 6X14 - 12X15.6X14 - 4X4 3X26.2X26 AD1500P - 4X4 9X15.6X14 AD1500P - ASA 6X2/2 ARA 6X2/4 - 8X2/4 COMPOSED BY: NO.1 PC 60913 - NO.1 PC 60917 - NO.2 PCS 60919 			
<ul style="list-style-type: none"> ● F-K-N BUS 			
<ul style="list-style-type: none"> ★ 9X15 10X15 AD COMPOSED BY: NO.1 PC 60913 - NO.1 PC 60917 - NO.2 PCS 60919 			
<ul style="list-style-type: none"> ● 3 BUS 			
<ul style="list-style-type: none"> ★ AD 11X15 - AD90 9X15 COMPOSED BY: NO.1 PC 60913 - NO.1 PC 60917 - NO.2 PCS 60919 			
<ul style="list-style-type: none"> ● 4 TRUCK 			
<ul style="list-style-type: none"> ★ AD1300 4X2 - AD1500P 4X2 4X4 - AD1501P 4X2 4X4 - ARA820 ARA760 6X2/4 8X2/4 COMPOSED BY: NO.1 PC 60913 - NO.1 PC 60917 - NO.2 PCS 60919 			
<ul style="list-style-type: none"> ● 3 TRUCK 			
<ul style="list-style-type: none"> ★ AD80/90/100 - AD1500P - ARA COMPOSED BY: NO.1 PC 60913 - NO.1 PC 60917 - NO.2 PCS 60919 			



ALL THE COMPONENTS LISTED IN OUR CATALOGUE ARE NOT ORIGINAL, THOUGH PERFECTLY INTERCHANGEABLE. REFERENCE NUMBERS, EITHER ORIGINAL OR OF A DIFFERENT NATURE, ARE FOR INFORMATION PURPOSES ONLY WHEN PLACING AN ORDER, PLEASE, ALWAYS USE COSIBO REFERENCE NUMBERS AND DO NOT MENTION THE ORIGINAL REFERENCE NUMBERS OF THE TRUCK MANUFACTURERS IN THE INVOICE TO VEHICLE OWNERS OR TO ANYBODY ELSE. THE CUSTOMER TAKES HIS OWN RESPONSIBILITY IF HE DOES NOT COMPLY WITH WHAT ABOVE.

SPRING BRACKET SET



	Code	OEM new	OEM old
● Model	63814	63814	
★ Application			
● P-G-R-T TRUCK			
★ 5X22 - 1X15.10X13 - AD 6X2 8X2 COMPOSED BY: NO.1 PC 60920 - NO.1 PC 60921 - NO.2 PCS 60919			
● 3 TRUCK			
★ AD 6X2 8X2 COMPOSED BY: NO.1 PC 60920 - NO.1 PC 60921 - NO.2 PCS 60919			
● 4 TRUCK			
★ AD 6X2 8X2 COMPOSED BY: NO.1 PC 60920 - NO.1 PC 60921 - NO.2 PCS 60919			

SPRING BOLT



	62111	1364140	
● 4 BUS			
★ 10X15 AD - AD1300			
● F-K-N BUS			
★ 9X15 10X15 AD			
● 4 TRUCK			
★ AD1300 4X2 - AD1500P 4X2 4X4			
● P-G-R-T TRUCK			
★ AD1500P - 4X4			
● 3 TRUCK			
★ AD80/90/100			
● 3 BUS			
★ AD90			

RUBBER BUFFER



	61319	237884	
● 3 TRUCK			
★ AD1500P - ADA - ASA70			
● 4 TRUCK			
★ AD1300 - AD1500P - AD1501P			
● P-G-R-T TRUCK			
★ AD1500P			

ALL THE COMPONENTS LISTED IN OUR CATALOGUE ARE NOT ORIGINAL, THOUGH PERFECTLY INTERCHANGEABLE. REFERENCE NUMBERS, EITHER ORIGINAL OR OF A DIFFERENT NATURE, ARE FOR INFORMATION PURPOSES ONLY WHEN PLACING AN ORDER, PLEASE, ALWAYS USE COSIBO REFERENCE NUMBERS AND DO NOT MENTION THE ORIGINAL REFERENCE NUMBERS OF THE TRUCK MANUFACTURERS IN THE INVOICE TO VEHICLE OWNERS OR TO ANYBODY ELSE. THE CUSTOMER TAKES HIS OWN RESPONSIBILITY IF HE DOES NOT COMPLY WITH WHAT ABOVE.

	Code	OEM new	OEM old
RUBBER BUFFER	65028	1377692	1370142
<ul style="list-style-type: none"> ● Model ★ Application 			
<ul style="list-style-type: none"> ● 3 TRUCK ★ AD80/90/100 - AD1500P 			
<ul style="list-style-type: none"> ● 4 TRUCK ★ AD1300 - AD1500P - AD1501P - ADA1300/1500/1501 - ADA1100 - ADA1100 F958 			
<ul style="list-style-type: none"> ● P-G-R-T TRUCK ★ AD/ADA - AD1500P - ADA1300 F950/958 - ADA1100 - ADA1501P 			



RUBBER BUFFER	62219	120252	
<ul style="list-style-type: none"> ● 4 TRUCK ★ AD 			
<ul style="list-style-type: none"> ● P-G-R-T TRUCK ★ AD 			



RUBBER BUFFER	65244	285493	
<ul style="list-style-type: none"> ● 3 TRUCK ★ AD80/90/100 - ADA90 - ASA - ASA80 ELC 1.19 TONS 			
<ul style="list-style-type: none"> ● 4 TRUCK ★ ASA80 ELC 1.19 TONS - ADA1300 ELC 1.LA4X2NA NB - 1.LB6X2NA NB - ASA70 ELC 1.19.9 TONS LB6X2NA NB 			
<ul style="list-style-type: none"> ● 3 BUS ★ AD90 - ASA 			
<ul style="list-style-type: none"> ● 4 BUS ★ AD1300 - F94 6X2 			
<ul style="list-style-type: none"> ● F-K-N BUS ★ AD 			



SHOCK ABSORBER REPAIR SET



● Model
★ Application

Code

OEM new

OEM old

64036

550282

● 3 TRUCK

★

● 4 TRUCK

★

SHOCK ABSORBER REPAIR SET



● 3 TRUCK

★

● 4 TRUCK

★

64309

550283

ALL THE COMPONENTS LISTED IN OUR CATALOGUE ARE NOT ORIGINAL, THOUGH PERFECTLY INTERCHANGEABLE. REFERENCE NUMBERS, EITHER ORIGINAL OR OF A DIFFERENT NATURE, ARE FOR INFORMATION PURPOSES ONLY WHEN PLACING AN ORDER, PLEASE, ALWAYS USE COSIBO REFERENCE NUMBERS AND DO NOT MENTION THE ORIGINAL REFERENCE NUMBERS OF THE TRUCK MANUFACTURERS IN THE INVOICE TO VEHICLE OWNERS OR TO ANYBODY ELSE. THE CUSTOMER TAKES HIS OWN RESPONSIBILITY IF HE DOES NOT COMPLY WITH WHAT ABOVE.

	Code	OEM new	OEM old
RUBBER BUSHING	62491	1516496	
<ul style="list-style-type: none"> ● Model ★ Application 			
<ul style="list-style-type: none"> ● 4 BUS 			
<ul style="list-style-type: none"> ★ ADA1300 4X2 - 6X2 IB/UB - 8X2 IB - ASA701 CH 1848800 - CH 3556770 - AM CH 3550362 			
<ul style="list-style-type: none"> ● F-K-N BUS 			
<ul style="list-style-type: none"> ★ ADA1300 4X2 - 6X2 IB/UB - 8X2 IB - ASA701 CH 1848800 - CH 3556770 - AM - ADA1300 6X2/2 KIA 			
<ul style="list-style-type: none"> ● 4 TRUCK 			
<ul style="list-style-type: none"> ★ AMA AMD900 - AMD901 CH 1292429 - CH 4501901 - CH 9083917 - CH 3545542 - ARA 8X20 - 6X2/4N REAR - 			
<ul style="list-style-type: none"> ● P-G-R-T TRUCK 			
<ul style="list-style-type: none"> ★ 6X2/4 - 8X2/4 			



RUBBER BUFFER	64099	1370141	
<ul style="list-style-type: none"> ● 4 TRUCK 			
<ul style="list-style-type: none"> ★ BT201 AD1101P - BT201 2XAD1100P - BT201 2XAD1300 - BT300B - BT201B/10X20/90 2XAD1300 			
<ul style="list-style-type: none"> ● P-G-R-T TRUCK 			
<ul style="list-style-type: none"> ★ BT201 AD1101P - BT201 2XAD1100P - BT300 - BT300I - BT300 6X4 8X4 - BT201 AD1300 - 			



SHACKLE SPRING W/BUSHING	63556/1	1377739	1103026
<ul style="list-style-type: none"> ● F-K-N BUS 			
<ul style="list-style-type: none"> ★ (TRAPEZOIDAL FRONT SPRING) 8X15 9X15 AM 			



SHACKLE SPRING W/O BUSH



● Model

★ Application

Code

OEM new

OEM old

63556/2

63556/2

● F-K-N BUS

★ (TRAPEZOIDAL FRONT SPRING) 8X15 9X15 AM

ALL THE COMPONENTS LISTED IN OUR CATALOGUE ARE NOT ORIGINAL, THOUGH PERFECTLY INTERCHANGEABLE. REFERENCE NUMBERS, EITHER ORIGINAL OR OF A DIFFERENT NATURE, ARE FOR INFORMATION PURPOSES ONLY WHEN PLACING AN ORDER, PLEASE, ALWAYS USE COSIBO REFERENCE NUMBERS AND DO NOT MENTION THE ORIGINAL REFERENCE NUMBERS OF THE TRUCK MANUFACTURERS IN THE INVOICE TO VEHICLE OWNERS OR TO ANYBODY ELSE. THE CUSTOMER TAKES HIS OWN RESPONSIBILITY IF HE DOES NOT COMPLY WITH WHAT ABOVE.

TORQUE ROD



	Code	OEM new	OEM old
● Model	63852	1399180	1338769
★ Application			
● 3 TRUCK			
★	AD80 6X4 8X4 - AD85 6X4 8X4 - AD90 6X4 8X4		
● 4 TRUCK			
★	BT200B/I 4X30 F950/958 - BT200B/I 4X41 F950/958		

TORQUE ROD REPAIR SET



	65239	550806	
● 3 BUS			
★	AMA		
● 3 TRUCK			
★	AD80/85/90 6X4 8X4		
● 4 TRUCK			
★	94 - 114 - 124 - 144 - 164		
● P-G-R-T TRUCK			
★	BT300I/B 2XAD1100P		

TORQUE ROD REPAIR SET



	65240	550807	
● 3 TRUCK			
★	AMA		
● 4 TRUCK			
★	94 - 114 - 124 - 144 - 164		
● P-G-R-T TRUCK			
★			

ALL THE COMPONENTS LISTED IN OUR CATALOGUE ARE NOT ORIGINAL, THOUGH PERFECTLY INTERCHANGEABLE. REFERENCE NUMBERS, EITHER ORIGINAL OR OF A DIFFERENT NATURE, ARE FOR INFORMATION PURPOSES ONLY WHEN PLACING AN ORDER, PLEASE, ALWAYS USE COSIBO REFERENCE NUMBERS AND DO NOT MENTION THE ORIGINAL REFERENCE NUMBERS OF THE TRUCK MANUFACTURERS IN THE INVOICE TO VEHICLE OWNERS OR TO ANYBODY ELSE. THE CUSTOMER TAKES HIS OWN RESPONSIBILITY IF HE DOES NOT COMPLY WITH WHAT ABOVE.

TORQUE ROD REPAIR SET



- Model
- ★ Application

Code

OEM new

OEM old

65241

550808

- 3 TRUCK

- ★ AMA

- 4 TRUCK

- ★ 94 - 114 - 124 - 144 - 164

- P-G-R-T TRUCK

- ★

LEVELING VALVE

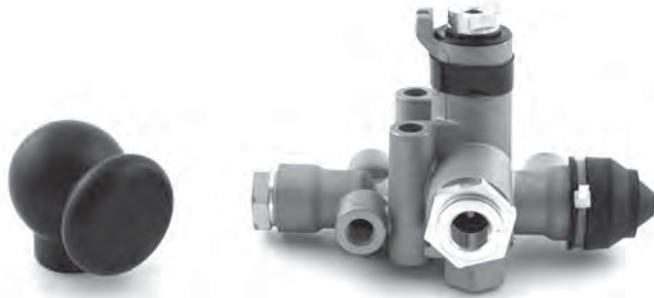

- 3 TRUCK

- ★ ASA70

- 4 TRUCK

- ★ 94 - 114 - 124 - 144 - 164

64189

1380814

322368

ALL THE COMPONENTS LISTED IN OUR CATALOGUE ARE NOT ORIGINAL, THOUGH PERFECTLY INTERCHANGEABLE. REFERENCE NUMBERS, EITHER ORIGINAL OR OF A DIFFERENT NATURE, ARE FOR INFORMATION PURPOSES ONLY WHEN PLACING AN ORDER, PLEASE, ALWAYS USE COSIBO REFERENCE NUMBERS AND DO NOT MENTION THE ORIGINAL REFERENCE NUMBERS OF THE TRUCK MANUFACTURERS IN THE INVOICE TO VEHICLE OWNERS OR TO ANYBODY ELSE. THE CUSTOMER TAKES HIS OWN RESPONSIBILITY IF HE DOES NOT COMPLY WITH WHAT ABOVE.

	Code	OEM new	OEM old
BOOT	65243	639320	
<ul style="list-style-type: none"> ● Model ★ Application 			
<ul style="list-style-type: none"> ● 3 BUS ★ 			
<ul style="list-style-type: none"> ● 3 TRUCK ★ 			
<ul style="list-style-type: none"> ● 4 BUS ★ 			
<ul style="list-style-type: none"> ● 4 TRUCK ★ 			



LEVELING VALVE	62521	475110	468568
-----------------------	--------------	--------	--------



<ul style="list-style-type: none"> ● 3 BUS ★ 			
<ul style="list-style-type: none"> ● 4 BUS ★ 			

SENSOR BULB	64070	1361131	
--------------------	--------------	---------	--



<ul style="list-style-type: none"> ● 4 TRUCK ★ B6X2NA/NB 			
--	--	--	--

ALL THE COMPONENTS LISTED IN OUR CATALOGUE ARE NOT ORIGINAL, THOUGH PERFECTLY INTERCHANGEABLE. REFERENCE NUMBERS, EITHER ORIGINAL OR OF A DIFFERENT NATURE, ARE FOR INFORMATION PURPOSES ONLY WHEN PLACING AN ORDER, PLEASE, ALWAYS USE COSIBO REFERENCE NUMBERS AND DO NOT MENTION THE ORIGINAL REFERENCE NUMBERS OF THE TRUCK MANUFACTURERS IN THE INVOICE TO VEHICLE OWNERS OR TO ANYBODY ELSE. THE CUSTOMER TAKES HIS OWN RESPONSIBILITY IF HE DOES NOT COMPLY WITH WHAT ABOVE.

		Code	OEM new	OEM old
SAFETY VALVE	● Model	65096	303496	
	★ Application			
	● 3 TRUCK			
	★			
● 2 TRUCK				
★				



SOLENOID VALVE	62342	1536307	1421325
● 3 BUS			
★			
● 3 TRUCK			
★ ASA70			
● 4 TRUCK			
★			



SOLENOID VALVE	65191	1536304	1340231 1421322
● 3 TRUCK			
★ ML 6X2/4 MA 6X2/4 - 4X2A 6X2A - 6X2A ASA70 - 6X2B			
● 4 TRUCK			
★ 4X2A - A4X2NA - 8X2/4 - 8X4/4 - NA/NB			



ALL THE COMPONENTS LISTED IN OUR CATALOGUE ARE NOT ORIGINAL, THOUGH PERFECTLY INTERCHANGEABLE. REFERENCE NUMBERS, EITHER ORIGINAL OR OF A DIFFERENT NATURE, ARE FOR INFORMATION PURPOSES ONLY WHEN PLACING AN ORDER, PLEASE, ALWAYS USE COSIBO REFERENCE NUMBERS AND DO NOT MENTION THE ORIGINAL REFERENCE NUMBERS OF THE TRUCK MANUFACTURERS IN THE INVOICE TO VEHICLE OWNERS OR TO ANYBODY ELSE. THE CUSTOMER TAKES HIS OWN RESPONSIBILITY IF HE DOES NOT COMPLY WITH WHAT ABOVE.

SHACKLE SPRING W/BUSHING



	Code	OEM new	OEM old
● Model	63556/1	1377739	1103026
★ Application			
● 3 TRUCK			
★	(TRAPEZOIDAL FRONT SPRING) 6X15 7X15 8X2 8X4 8X15 9X13 9X15 AM56 AM61 AM70 - MK HK 4X4 6X4 8X15 - HK 4X4 HK 6X6 AMD105 - EK 6X4 8X2 8X4 8X15 9X15 AM61 AM70 AM800 AM820 - (PARABOLIC FRONT SPRING) 2X28 2X30 2X32 3X29 AM - HK EK 6X4 3X29 2X30 2X32 AM - ML 8X4 4X22 AM - 3X29 EL 6X4 AM61 AM70 AM820 - 4X22 HL 8X2 AM - HK 8X4 EK 8X4 4X22 - 4X22 HL/EL 8X2 8X4 AM - EK 8X4 AM800 4X22 - MK 8X4 AM56 AM61 4X22 - MW 4X2A 2X30 AM		

SOLENOID VALVE



	65191	1536304	1340231 1421322
● 4 BUS			
★ OK			

SHACKLE SPRING W/BUSHING



	63556/1	1377739	1103026
● 4 TRUCK			
★	(SUSPENSION SPRING) 2X30/32 3X29 4X28 7/9X15 8X2 8X4 8X2/6 ALSO 8X2/6 REAR - (PARABOLIC SPRING) 2X32 3X29 AMD900 AM901 - 8X8 WLS/ZLS 3X29 AMD900 FR AMD900 RE - 8X8 2X32 AMD900 AMD901 FR - 8X8 2X32 AMD900 RE - (TRAPEZOIDAL SPRING) 7X15 AMD900 AMD901		

ALL THE COMPONENTS LISTED IN OUR CATALOGUE ARE NOT ORIGINAL, THOUGH PERFECTLY INTERCHANGEABLE. REFERENCE NUMBERS, EITHER ORIGINAL OR OF A DIFFERENT NATURE, ARE FOR INFORMATION PURPOSES ONLY WHEN PLACING AN ORDER, PLEASE, ALWAYS USE COSIBO REFERENCE NUMBERS AND DO NOT MENTION THE ORIGINAL REFERENCE NUMBERS OF THE TRUCK MANUFACTURERS IN THE INVOICE TO VEHICLE OWNERS OR TO ANYBODY ELSE. THE CUSTOMER TAKES HIS OWN RESPONSIBILITY IF HE DOES NOT COMPLY WITH WHAT ABOVE.

SHACKLE SPRING W/O BUSH



● Model

★ Application

Code

OEM new

OEM old

63556/2

63556/2

● 3 TRUCK

★

(TRAPEZOIDAL FRONT SPRING) 6X15 7X15 8X2 8X4 8X15 9X13 9X15 AM56 AM61 AM70 - MK HK 4X4 6X4 8X15 - HK 4X4 HK 6X6 AMD105 - EK 6X4 8X2 8X4 8X15 9X15 AM61 AM70 AM800 AM820 - (PARABOLIC FRONT SPRING) 2X28 2X30 2X32 3X29 AM - HK EK 6X4 3X29 2X30 2X32 AM - ML 8X4 4X22 AM - 3X29 EL 6X4 AM61 AM70 AM820 - 4X22 HL 8X2 AM - HK 8X4 EK 8X4 4X22 - 4X22 HL/EL 8X2 8X4 AM - EK 8X4 AM800 4X22 - MK 8X4 AM56 AM61 4X22 - MW 4X2A 2X30 AM

● 4 TRUCK

★

(SUSPENSION SPRING) 2X30/32 3X29 4X28 7/9X15 8X2 8X4 8X2/6 ALSO 8X2/6 REAR - (PARABOLIC SPRING) 2X32 3X29 AMD900 AM901 - 8X8 WLS/ZLS 3X29 AMD900 FR AMD900 RE - 8X8 2X32 AMD900 AMD901 FR - 8X8 2X32 AMD900 RE - (TRAPEZOIDAL SPRING) 7X15 AMD900 AMD901

REAR AXLE SHAFT



	Code	OEM new	OEM old
● Model	61218	252497	
★ Application			
● 3 TRUCK			
★ D1500P HE - 2X AD90/AD100 - 2X AD100 6X4 8X4 6X6			
● 4 TRUCK			
★ D1500P HE			

RING NUT



	61227	1343178	204724
● 3 TRUCK			
★ AD1500P HE - 2X AD90 - 2X AD100 6X4 8X4 6X6			
● 4 TRUCK			
★ BT201 B/I 4X30 4X41 10X20/90 - BT300 B/I - 8X8WLS/ZLS BT300 I - AD1500P HE			
● P-G-R-T TRUCK			
★ BT 201 - BT 300 - BT300 B/I			

GASKET





	61501	204750	
● 3 TRUCK			
★ AD 1500P HE - 2X AD90 - 2X AD100 6X4 8X4 6X6			
● 4 TRUCK			
★ AD 1500P HE			

ALL THE COMPONENTS LISTED IN OUR CATALOGUE ARE NOT ORIGINAL, THOUGH PERFECTLY INTERCHANGEABLE. REFERENCE NUMBERS, EITHER ORIGINAL OR OF A DIFFERENT NATURE, ARE FOR INFORMATION PURPOSES ONLY WHEN PLACING AN ORDER, PLEASE, ALWAYS USE COSIBO REFERENCE NUMBERS AND DO NOT MENTION THE ORIGINAL REFERENCE NUMBERS OF THE TRUCK MANUFACTURERS IN THE INVOICE TO VEHICLE OWNERS OR TO ANYBODY ELSE. THE CUSTOMER TAKES HIS OWN RESPONSIBILITY IF HE DOES NOT COMPLY WITH WHAT ABOVE.

	Code	OEM new	OEM old
WASHER	61502	204723	
	<ul style="list-style-type: none"> ● Model ★ Application 		
	<ul style="list-style-type: none"> ● 3 TRUCK ★ AD 1500P HE - 2XAD90 - 2XAD100 6X4 8X4 6X6 		
	<ul style="list-style-type: none"> ● 4 TRUCK ★ BT 201 B/I 4X30 4X4110X20/90 - BT 300 B/I - 8X8 WLS/ZLS BT300 I - AD 1500P HE 		
	<ul style="list-style-type: none"> ● P-G-R-T TRUCK ★ BT 201 - BT 300 - BT 300 B/I 		

	Code	OEM new	OEM old
WASHER	61503	204737	
	<ul style="list-style-type: none"> ● 3 TRUCK ★ AD1500P HE - 2XAD90 - 2XAD100 6X4 8X4 6X6 		
	<ul style="list-style-type: none"> ● 4 TRUCK ★ BT 201 B/I 4X30 4X41 10X20/90 - BT 300 B/I - AD1500P HE - 8X8 WLS/ZLS BT300 I 		
	<ul style="list-style-type: none"> ● P-G-R-T TRUCK ★ BT 201 - BT 300 B/I 		

	Code	OEM new	OEM old
WASHER	61504	204735	
	<ul style="list-style-type: none"> ● 3 TRUCK ★ AD1500P HE - 2X AD90 - 2X AD100 6X4 8X4 6X6 		
	<ul style="list-style-type: none"> ● 4 TRUCK ★ AD1500P HE 		

	Code	OEM new	OEM old
WASHER	61505	204736	
	<ul style="list-style-type: none"> ● 3 TRUCK ★ AD1500P HE - 2X AD90 - 2X AD100 6X4 8X4 6X6 		
	<ul style="list-style-type: none"> ● 4 TRUCK ★ AD1500P HE 		

ALL THE COMPONENTS LISTED IN OUR CATALOGUE ARE NOT ORIGINAL, THOUGH PERFECTLY INTERCHANGEABLE. REFERENCE NUMBERS, EITHER ORIGINAL OR OF A DIFFERENT NATURE, ARE FOR INFORMATION PURPOSES ONLY WHEN PLACING AN ORDER, PLEASE, ALWAYS USE COSIBO REFERENCE NUMBERS AND DO NOT MENTION THE ORIGINAL REFERENCE NUMBERS OF THE TRUCK MANUFACTURERS IN THE INVOICE TO VEHICLE OWNERS OR TO ANYBODY ELSE. THE CUSTOMER TAKES HIS OWN RESPONSIBILITY IF HE DOES NOT COMPLY WITH WHAT ABOVE.

	Code	OEM new	OEM old
WASHER	61506	1118446	204731
	<ul style="list-style-type: none"> ● Model ★ Application 		
	<ul style="list-style-type: none"> ● 3 TRUCK ★ AD1500P HE - 2X AD80 MK6X4/MK8X4/ML6X4 - 2X AD 85 HK 6X4 /8X4 - 2X AD90 - 2X AD100 6X4 8X4 6X6 - 2X AD90 HL 6X4 8X4 		
	<ul style="list-style-type: none"> ● 4TRUCK ★ AD1500P HE - BT200 B/I 		
SPACER RING	61507	204746	
	<ul style="list-style-type: none"> ● 3 TRUCK ★ AD1500P HE - 2X AD80 MK6X4/MK8X4/ML6X4 - 2X AD 85 HK 6X4 /8X4 - 2X AD90 - 2X AD100 6X4 8X4 6X6 - 2X AD90 HL 6X4 8X4 		
	<ul style="list-style-type: none"> ● 4 TRUCK ★ AD1500P HE - BT200 B/I 		
BUSHING	60866	1754546	204733 378277
	<ul style="list-style-type: none"> ● 3 TRUCK ★ AD1500P HE - 2X AD80 MK6X4/MK8X4/ML6X4 - 2X AD 85 HK 6X4 /8X4 - 2X AD90 - 2X AD100 6X4 8X4 6X6 - 2X AD90 HL 6X4 8X4 		
	<ul style="list-style-type: none"> ● 4 TRUCK ★ AD1500P HE - BT200 B/I 		

ALL THE COMPONENTS LISTED IN OUR CATALOGUE ARE NOT ORIGINAL, THOUGH PERFECTLY INTERCHANGEABLE. REFERENCE NUMBERS, EITHER ORIGINAL OR OF A DIFFERENT NATURE, ARE FOR INFORMATION PURPOSES ONLY WHEN PLACING AN ORDER, PLEASE, ALWAYS USE COSIBO REFERENCE NUMBERS AND DO NOT MENTION THE ORIGINAL REFERENCE NUMBERS OF THE TRUCK MANUFACTURERS IN THE INVOICE TO VEHICLE OWNERS OR TO ANYBODY ELSE. THE CUSTOMER TAKES HIS OWN RESPONSIBILITY IF HE DOES NOT COMPLY WITH WHAT ABOVE.

	Code	OEM new	OEM old
O-RING	61508	368033	
<ul style="list-style-type: none"> ● Model ★ Application 			
<ul style="list-style-type: none"> ● 3 TRUCK 			
<ul style="list-style-type: none"> ★ AD1500P HE - 2X AD100 			
<ul style="list-style-type: none"> ● 4 TRUCK 			
<ul style="list-style-type: none"> ★ AD1500P HE - R560/660/780/782 - RP735/835 			
<ul style="list-style-type: none"> ● P-G-R-T TRUCK 			
<ul style="list-style-type: none"> ★ R560/660/780/782 - RP735/835 - RBP735 			
<ul style="list-style-type: none"> ● 3 BUS 			
<ul style="list-style-type: none"> ★ 			
<ul style="list-style-type: none"> ● 4 BUS 			
<ul style="list-style-type: none"> ★ K/L94 - 114 - 124 R660 - RP835 			

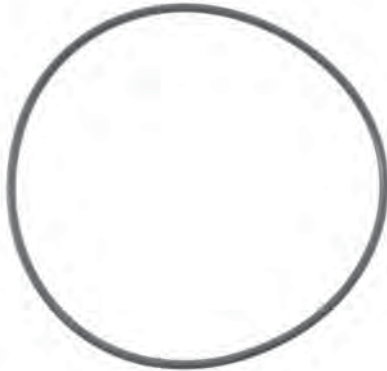

SHACKLE SPRING W/BUSHING	63556/1	1377739	1103026
<ul style="list-style-type: none"> ● 3 BUS 			
<ul style="list-style-type: none"> ★ (TRAPEZOIDAL FRONT SPRING) AM 7X15 			



O-RING	61508	368033	
<ul style="list-style-type: none"> ● IND. MARINE ENGINE 4 			
<ul style="list-style-type: none"> ★ 			

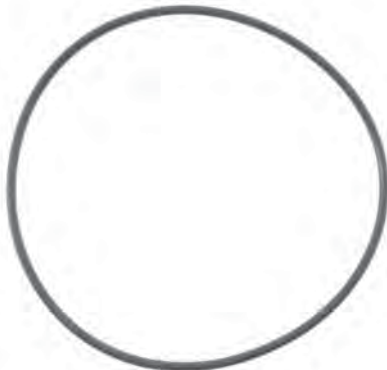

ALL THE COMPONENTS LISTED IN OUR CATALOGUE ARE NOT ORIGINAL, THOUGH PERFECTLY INTERCHANGEABLE. REFERENCE NUMBERS, EITHER ORIGINAL OR OF A DIFFERENT NATURE, ARE FOR INFORMATION PURPOSES ONLY WHEN PLACING AN ORDER, PLEASE, ALWAYS USE COSIBO REFERENCE NUMBERS AND DO NOT MENTION THE ORIGINAL REFERENCE NUMBERS OF THE TRUCK MANUFACTURERS IN THE INVOICE TO VEHICLE OWNERS OR TO ANYBODY ELSE. THE CUSTOMER TAKES HIS OWN RESPONSIBILITY IF HE DOES NOT COMPLY WITH WHAT ABOVE.

SHACKLE SPRING W/O BUSH



	Code	OEM new	OEM old
● Model	63556/2	63556/2	
★ Application			
● 3 BUS			
★ (TRAPEZOIDAL FRONT SPRING) AM 7X15			

O-RING

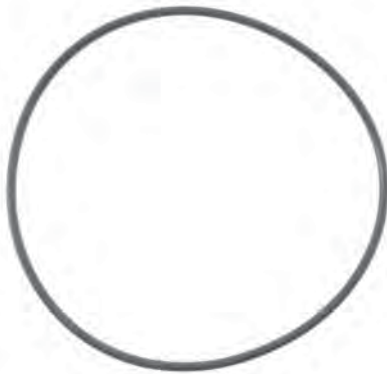



	61508	368033	
● F-K-N BUS			
★ R660/680			

FLANGE



	61509	204727	
● 3 TRUCK			
★ AD1500P HE - 2X AD90 - 2X AD100 6X4 8X4 6X6			
● 4 TRUCK			
★ AD1500P HE			

ALL THE COMPONENTS LISTED IN OUR CATALOGUE ARE NOT ORIGINAL, THOUGH PERFECTLY INTERCHANGEABLE. REFERENCE NUMBERS, EITHER ORIGINAL OR OF A DIFFERENT NATURE, ARE FOR INFORMATION PURPOSES ONLY WHEN PLACING AN ORDER, PLEASE, ALWAYS USE COSIBO REFERENCE NUMBERS AND DO NOT MENTION THE ORIGINAL REFERENCE NUMBERS OF THE TRUCK MANUFACTURERS IN THE INVOICE TO VEHICLE OWNERS OR TO ANYBODY ELSE. THE CUSTOMER TAKES HIS OWN RESPONSIBILITY IF HE DOES NOT COMPLY WITH WHAT ABOVE.

	Code	OEM new	OEM old
CONIC RING	61510	204719	
	<ul style="list-style-type: none"> ● Model ★ Application 		
	<ul style="list-style-type: none"> ● 3 TRUCK ★ AD1500P HE - 2X AD90 - 2X AD100 6X4 8X4 6X6 		
	<ul style="list-style-type: none"> ● 4 TRUCK ★ AD1500P HE 		
WASHER	61511	204722	
	<ul style="list-style-type: none"> ● 3 TRUCK ★ AD1500P HE - 2X AD90 - 2X AD100 6X4 8X4 6X6 		
	<ul style="list-style-type: none"> ● 4 TRUCK ★ AD1500P HE 		
OIL SEAL	60867	204728	
	<ul style="list-style-type: none"> ● 3 TRUCK ★ AD1500P HE - 2X AD90 - 2X AD100 6X4 8X4 6X6 		
	<ul style="list-style-type: none"> ● 4 TRUCK ★ AD1500P HE 		

ALL THE COMPONENTS LISTED IN OUR CATALOGUE ARE NOT ORIGINAL, THOUGH PERFECTLY INTERCHANGEABLE. REFERENCE NUMBERS, EITHER ORIGINAL OR OF A DIFFERENT NATURE, ARE FOR INFORMATION PURPOSES ONLY WHEN PLACING AN ORDER, PLEASE, ALWAYS USE COSIBO REFERENCE NUMBERS AND DO NOT MENTION THE ORIGINAL REFERENCE NUMBERS OF THE TRUCK MANUFACTURERS IN THE INVOICE TO VEHICLE OWNERS OR TO ANYBODY ELSE. THE CUSTOMER TAKES HIS OWN RESPONSIBILITY IF HE DOES NOT COMPLY WITH WHAT ABOVE.

	Code	OEM new	OEM old
REPAIR KIT	62467	62467	
	<ul style="list-style-type: none"> ● Model ★ Application 		
	<ul style="list-style-type: none"> ● 3 TRUCK ★ AD1500P HE - 2X AD90 - 2X AD100 6X4 8X4 6X6 		
	<ul style="list-style-type: none"> ● 4 TRUCK ★ AD1500P HE 		

REPAIR KIT	62468	62468	
	<ul style="list-style-type: none"> ● 3 TRUCK ★ AD1500P HE - 2X AD90 - 2X AD100 6X4 8X4 6X6 		
	<ul style="list-style-type: none"> ● 4 TRUCK ★ AD1500P HE 		

RUBBER RING	62466	1386104	
	<ul style="list-style-type: none"> ● 4 TRUCK ★ BT 201 B/I 4X30 4X41 10/20/90 - BT 300 B/I - 8X8 WLS/ZLS BT300 I 		
	<ul style="list-style-type: none"> ● P-G-R-T TRUCK ★ BT 201 - BT 300 - BT 300 B/I 		

ALL THE COMPONENTS LISTED IN OUR CATALOGUE ARE NOT ORIGINAL, THOUGH PERFECTLY INTERCHANGEABLE. REFERENCE NUMBERS, EITHER ORIGINAL OR OF A DIFFERENT NATURE, ARE FOR INFORMATION PURPOSES ONLY WHEN PLACING AN ORDER, PLEASE, ALWAYS USE COSIBO REFERENCE NUMBERS AND DO NOT MENTION THE ORIGINAL REFERENCE NUMBERS OF THE TRUCK MANUFACTURERS IN THE INVOICE TO VEHICLE OWNERS OR TO ANYBODY ELSE. THE CUSTOMER TAKES HIS OWN RESPONSIBILITY IF HE DOES NOT COMPLY WITH WHAT ABOVE.

	Code	OEM new	OEM old
OIL SEAL 140X170X15	63997	1386227	
<ul style="list-style-type: none"> ● Model ★ Application 			
<ul style="list-style-type: none"> ● 4 TRUCK 			
<ul style="list-style-type: none"> ★ BT 201 B/I 4X30 4X41 10X20/90 - BT 300 B/I - 8X8 WLS/ZLS BT 300 I 			
<ul style="list-style-type: none"> ● P-G-R-T TRUCK 			
<ul style="list-style-type: none"> ★ BT 201 - BT 300 - BT 300 B/I 			



OIL SEAL 140X170X13,6/17,4	64117	1431199	1357942 1380324 1390097
<ul style="list-style-type: none"> ● 3 TRUCK 			
<ul style="list-style-type: none"> ★ 2X AD80 MK6X4/MK8X4/ML6X4 - 2X AD90 HL 6X4 8X4 - 2X AD85 HK6X4 8X4 			
<ul style="list-style-type: none"> ● 4 TRUCK 			
<ul style="list-style-type: none"> ★ BT 200 B/I 			



REAR AXLE RUBBER MOUNTING	65310	1368681	204749
<ul style="list-style-type: none"> ● 3 TRUCK 			
<ul style="list-style-type: none"> ★ AD1500P HE - 2X AD90 - 2X AD100 6X4 8X4 6X6 			
<ul style="list-style-type: none"> ● 4 TRUCK 			
<ul style="list-style-type: none"> ★ AD1500P HE 			



REAR AXLE RUBBER MOUNTING DIA.18.5 MM	65302	1368682	349254
<ul style="list-style-type: none"> ● 3 TRUCK 			
<ul style="list-style-type: none"> ★ AD1500P HE - 2X AD90 - 2X AD100 6X4 8X4 6X6 			
<ul style="list-style-type: none"> ● 4 TRUCK 			
<ul style="list-style-type: none"> ★ AD1500P HE 			



ALL THE COMPONENTS LISTED IN OUR CATALOGUE ARE NOT ORIGINAL, THOUGH PERFECTLY INTERCHANGEABLE. REFERENCE NUMBERS, EITHER ORIGINAL OR OF A DIFFERENT NATURE, ARE FOR INFORMATION PURPOSES ONLY WHEN PLACING AN ORDER, PLEASE, ALWAYS USE COSIBO REFERENCE NUMBERS AND DO NOT MENTION THE ORIGINAL REFERENCE NUMBERS OF THE TRUCK MANUFACTURERS IN THE INVOICE TO VEHICLE OWNERS OR TO ANYBODY ELSE. THE CUSTOMER TAKES HIS OWN RESPONSIBILITY IF HE DOES NOT COMPLY WITH WHAT ABOVE.

	Code	OEM new	OEM old
REAR AXLE RUBBER MOUNTING DIA.17 MM	65300	1372786	248953
● Model			
★ Application			
● 3 TRUCK			
★ AD1500P HE - 2X AD90 - 2X AD100 6X4 8X4 6X6			
● 4 TRUCK			
★ AD1500P HE			



REAR AXLE RUBBER MOUNTING DIA.17.5 MM	65206	1386753	
● 4 TRUCK			
★			
● 4 BUS			
★			



RUBBER BUFFER	65231	222095	
● 3 TRUCK			
★ AD1500P HE - 2X AD80 MK6X4/MK8X4/ML6X4 - 2X AD85 HK6X4 8X4 - 2X AD90 HL6X4 8X4 - 2X AD100 6X4 8X4 6X6			



SHACKLE SPRING W/BUSHING	63556/1	1377739	1103026
● 4 BUS			
★ (TRAPEZOIDAL FRONT SPRING) 8X15 9X15 AM			



ALL THE COMPONENTS LISTED IN OUR CATALOGUE ARE NOT ORIGINAL, THOUGH PERFECTLY INTERCHANGEABLE. REFERENCE NUMBERS, EITHER ORIGINAL OR OF A DIFFERENT NATURE, ARE FOR INFORMATION PURPOSES ONLY WHEN PLACING AN ORDER, PLEASE, ALWAYS USE COSIBO REFERENCE NUMBERS AND DO NOT MENTION THE ORIGINAL REFERENCE NUMBERS OF THE TRUCK MANUFACTURERS IN THE INVOICE TO VEHICLE OWNERS OR TO ANYBODY ELSE. THE CUSTOMER TAKES HIS OWN RESPONSIBILITY IF HE DOES NOT COMPLY WITH WHAT ABOVE.

RUBBER BUFFER



● Model

★ Application

Code

OEM new

OEM old

65231

222095

● 4 TRUCK

- ★ AD1500P HE - BT 200 B/I 4X30 F950/F958 - BT 200 B/I 4X41 F950/F958 - 8X8 WLS/ZLS BT300I AD1101P - BT300I 2X AD1100P/AD1500P/AD1501P - BT300B/I 2X AD1500P/1501P

SHACKLE SPRING W/O BUSH



63556/2

63556/2

● 4 BUS

- ★ (TRAPEZOIDAL FRONT SPRING) 8X15 9X15 AM

RUBBER BUFFER



65231

222095

● P-G-R-T TRUCK

- ★ BT200 B/I 4X41 F950/F958 - BT200 B/I 4X30 F950/F958 - BT 300 I/B - AD1101P - BT 300 6X6 - BT300I/B 2X AD1100P - BT300I 2X AD1501P

O-RING

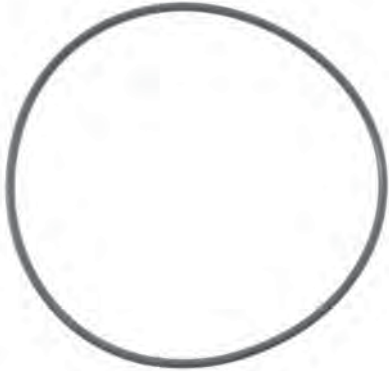

- Model
- ★ Application

- 3 TRUCK
- ★ AS60/AS90





Code

OEM new





OEM old

64790

804670

	Code	OEM new	OEM old
<p>CLAMP D.6</p> 	64082	813933	
<ul style="list-style-type: none"> ● Model ★ Application 			
<ul style="list-style-type: none"> ● 3 BUS ★ 			
<p>CLAMP D.10</p> 	64083	813935	
<ul style="list-style-type: none"> ● 3 TRUCK ★ 			
<p>CLAMP D. 16</p> 	64084	813937	
<ul style="list-style-type: none"> ● 3 BUS ★ 			
<p>CLAMP D.8</p> 	64090	813934	
<ul style="list-style-type: none"> ● 3 TRUCK ★ 			

ALL THE COMPONENTS LISTED IN OUR CATALOGUE ARE NOT ORIGINAL, THOUGH PERFECTLY INTERCHANGEABLE. REFERENCE NUMBERS, EITHER ORIGINAL OR OF A DIFFERENT NATURE, ARE FOR INFORMATION PURPOSES ONLY WHEN PLACING AN ORDER, PLEASE, ALWAYS USE COSIBO REFERENCE NUMBERS AND DO NOT MENTION THE ORIGINAL REFERENCE NUMBERS OF THE TRUCK MANUFACTURERS IN THE INVOICE TO VEHICLE OWNERS OR TO ANYBODY ELSE. THE CUSTOMER TAKES HIS OWN RESPONSIBILITY IF HE DOES NOT COMPLY WITH WHAT ABOVE.

	Code	OEM new	OEM old
<p>CLAMP D.13</p> 	64091	813936	
<ul style="list-style-type: none"> ● Model ★ Application 			
<ul style="list-style-type: none"> ● 3 BUS ★ 			
<p>CLAMP D.18</p> 	64092	813938	
<ul style="list-style-type: none"> ● 3 BUS ★ 			
<p>CLAMP D.22</p> 	64093	813940	
<ul style="list-style-type: none"> ● 3 TRUCK ★ 			
<p>CLAMP D.28</p> 	64095	804578	
<ul style="list-style-type: none"> ● 3 BUS ★ 			

ALL THE COMPONENTS LISTED IN OUR CATALOGUE ARE NOT ORIGINAL, THOUGH PERFECTLY INTERCHANGEABLE. REFERENCE NUMBERS, EITHER ORIGINAL OR OF A DIFFERENT NATURE, ARE FOR INFORMATION PURPOSES ONLY WHEN PLACING AN ORDER, PLEASE, ALWAYS USE COSIBO REFERENCE NUMBERS AND DO NOT MENTION THE ORIGINAL REFERENCE NUMBERS OF THE TRUCK MANUFACTURERS IN THE INVOICE TO VEHICLE OWNERS OR TO ANYBODY ELSE. THE CUSTOMER TAKES HIS OWN RESPONSIBILITY IF HE DOES NOT COMPLY WITH WHAT ABOVE.

		Code	OEM new	OEM old
SWITCH	● Model	62390	1425019	
	★ Application			
	● 4 BUS			
	★			
	● 4 TRUCK			
	★ 94 - 114 - 124 - 144 - 164			

SWITCH		62297	371910	
	● 3 BUS			
	★			
	● 3 TRUCK			
	★			

STEERING SHAFT		63354	1541653	1439270 1462613 1489734 1490913
	● 4 TRUCK			
	★ CR			
	● P-G-R-T TRUCK			
	★			
	● 4 BUS			
	★			
	● F-K-N BUS			
	★			

STEERING COLUMN		63617	470391	
	● 3 BUS			
	★			

ALL THE COMPONENTS LISTED IN OUR CATALOGUE ARE NOT ORIGINAL, THOUGH PERFECTLY INTERCHANGEABLE. REFERENCE NUMBERS, EITHER ORIGINAL OR OF A DIFFERENT NATURE, ARE FOR INFORMATION PURPOSES ONLY WHEN PLACING AN ORDER, PLEASE, ALWAYS USE COSIBO REFERENCE NUMBERS AND DO NOT MENTION THE ORIGINAL REFERENCE NUMBERS OF THE TRUCK MANUFACTURERS IN THE INVOICE TO VEHICLE OWNERS OR TO ANYBODY ELSE. THE CUSTOMER TAKES HIS OWN RESPONSIBILITY IF HE DOES NOT COMPLY WITH WHAT ABOVE.

		Code	OEM new	OEM old
STEERING SHAFT	● Model	63355	1540425	1462612
	★ Application			1490912
		● 4 TRUCK		
		★ CP		
		● P-G-R-T TRUCK		
		★		
		● 4 BUS		
		★		
		● F-K-N BUS		
		★		

		62138	389500	
STARTER AND LOCK STEERING CYLINDER	● 3 TRUCK			
	★			
		● 4 TRUCK		
		★		

ALL THE COMPONENTS LISTED IN OUR CATALOGUE ARE NOT ORIGINAL, THOUGH PERFECTLY INTERCHANGEABLE. REFERENCE NUMBERS, EITHER ORIGINAL OR OF A DIFFERENT NATURE, ARE FOR INFORMATION PURPOSES ONLY WHEN PLACING AN ORDER, PLEASE, ALWAYS USE COSIBO REFERENCE NUMBERS AND DO NOT MENTION THE ORIGINAL REFERENCE NUMBERS OF THE TRUCK MANUFACTURERS IN THE INVOICE TO VEHICLE OWNERS OR TO ANYBODY ELSE. THE CUSTOMER TAKES HIS OWN RESPONSIBILITY IF HE DOES NOT COMPLY WITH WHAT ABOVE.

	Code	OEM new	OEM old
<p>STEERING DRAG LINK</p> 	61549	278665	278666
<ul style="list-style-type: none"> ● Model ★ Application 			
<ul style="list-style-type: none"> ● 3 TRUCK ★ G/P/R 93 - P/R 113 - R 143 			
<p>STEERING DRAGLINK RHD</p> 	61924	352635	278663 278664
<ul style="list-style-type: none"> ● 3 TRUCK ★ P93 DN/DS/DSC - P/R113 - R143 			
<p>STEERING DRAG LINK</p> 	61933	1308643	
<ul style="list-style-type: none"> ● 3 TRUCK ★ R143 - P/R113 - P93 			
<p>STEERING DRAGLINK RHD</p> 	61923	1304571	381339
<ul style="list-style-type: none"> ● 3 TRUCK ★ P93 - P/R113 - R143 			
<p>STEERING DRAG LINK</p> 	61119	1768898	1379071 1384025
<ul style="list-style-type: none"> ● 4 TRUCK ★ 94 - 114 - 124 - 144 - 164 ● P-G-R-T TRUCK ★ 			

ALL THE COMPONENTS LISTED IN OUR CATALOGUE ARE NOT ORIGINAL, THOUGH PERFECTLY INTERCHANGEABLE. REFERENCE NUMBERS, EITHER ORIGINAL OR OF A DIFFERENT NATURE, ARE FOR INFORMATION PURPOSES ONLY WHEN PLACING AN ORDER, PLEASE, ALWAYS USE COSIBO REFERENCE NUMBERS AND DO NOT MENTION THE ORIGINAL REFERENCE NUMBERS OF THE TRUCK MANUFACTURERS IN THE INVOICE TO VEHICLE OWNERS OR TO ANYBODY ELSE. THE CUSTOMER TAKES HIS OWN RESPONSIBILITY IF HE DOES NOT COMPLY WITH WHAT ABOVE.

	Code	OEM new	OEM old
STEERING DRAG LINK RHD	63306	1769597	1384027
<ul style="list-style-type: none"> ● Model ★ Application 			
<ul style="list-style-type: none"> ● 4 TRUCK ★ 94 - 114 - 124 - 144 - 164 			
<ul style="list-style-type: none"> ● P-G-R-T TRUCK ★ 			



STEERING DRAG LINK	63587	1759691	1343283
<ul style="list-style-type: none"> ● 4 TRUCK ★ 94 - 114 - 124 - 144 - 164 			
<ul style="list-style-type: none"> ● P-G-R-T TRUCK ★ P/G/R 			



STEERING DRAG LINK RHD	63585	1394884	
<ul style="list-style-type: none"> ● 4 TRUCK ★ 94 - 114 - 124 - 144 - 164 			
<ul style="list-style-type: none"> ● P-G-R-T TRUCK ★ P/G/R 			



ALL THE COMPONENTS LISTED IN OUR CATALOGUE ARE NOT ORIGINAL, THOUGH PERFECTLY INTERCHANGEABLE. REFERENCE NUMBERS, EITHER ORIGINAL OR OF A DIFFERENT NATURE, ARE FOR INFORMATION PURPOSES ONLY WHEN PLACING AN ORDER, PLEASE, ALWAYS USE COSIBO REFERENCE NUMBERS AND DO NOT MENTION THE ORIGINAL REFERENCE NUMBERS OF THE TRUCK MANUFACTURERS IN THE INVOICE TO VEHICLE OWNERS OR TO ANYBODY ELSE. THE CUSTOMER TAKES HIS OWN RESPONSIBILITY IF HE DOES NOT COMPLY WITH WHAT ABOVE.

	Code	OEM new	OEM old
STEERING DRAG LINK LHD/RHD	63589	1759690	1343266
<ul style="list-style-type: none"> ● Model ★ Application 			
<ul style="list-style-type: none"> ● 4 TRUCK ★ 8X2 8X4 8X6 			
<ul style="list-style-type: none"> ● P-G-R-T TRUCK ★ P/R/G 			



LH BALL JOINT	60521	1738380	1358792 283783 395009
<ul style="list-style-type: none"> ● 3 TRUCK ★ P93 6X2/4 LHD/RHD - P - R113 6X2/4 LHD/RHD - R143 6X2/4 LHD/RHD 			
<ul style="list-style-type: none"> ● 4 TRUCK ★ 94/114/124/144/164 LHD/RHD 			
<ul style="list-style-type: none"> ● P-G-R-T TRUCK ★ P/R/G 6X2/4 8X2 8X4 8X2/4 8X2/6 			
<ul style="list-style-type: none"> ● 3 BUS ★ N113 CLB 			



RH BALL JOINT	60522	1358793	283784 395010
<ul style="list-style-type: none"> ● 3 TRUCK ★ P93 6X2/4 LHD/RHD - P - R113 6X2/4 LHD/RHD - R143 6X2/4 LHD/RHD 			
<ul style="list-style-type: none"> ● 4 TRUCK ★ 94/114/124/144/164 LHD/RHD 			
<ul style="list-style-type: none"> ● P-G-R-T TRUCK ★ P/R/G 6X2/4 8X2 8X4 8X2/4 8X2/6 			
<ul style="list-style-type: none"> ● 3 BUS ★ N113 CLB 			



ALL THE COMPONENTS LISTED IN OUR CATALOGUE ARE NOT ORIGINAL, THOUGH PERFECTLY INTERCHANGEABLE. REFERENCE NUMBERS, EITHER ORIGINAL OR OF A DIFFERENT NATURE, ARE FOR INFORMATION PURPOSES ONLY WHEN PLACING AN ORDER, PLEASE, ALWAYS USE COSIBO REFERENCE NUMBERS AND DO NOT MENTION THE ORIGINAL REFERENCE NUMBERS OF THE TRUCK MANUFACTURERS IN THE INVOICE TO VEHICLE OWNERS OR TO ANYBODY ELSE. THE CUSTOMER TAKES HIS OWN RESPONSIBILITY IF HE DOES NOT COMPLY WITH WHAT ABOVE.

	Code	OEM new	OEM old
BALL JOINT	64343	1738379	1357674
<ul style="list-style-type: none"> ● Model ★ Application 			
<ul style="list-style-type: none"> ● 4 TRUCK ★ P/R GB8X2/4 NA/NB LHD - P/R LA6X2/4 LHD/RHD - P/R LB6X2/4 NA/NB LHD/RHD - P DB6X2/4 NA/NB LHD/RHD OSC11 G03 - P114 GB6X2/4 NA LHD 			
<ul style="list-style-type: none"> ● P-G-R-T TRUCK ★ P/R/G 6X2/4 8X2/4 			



BALL JOINT	63591	1375228	
<ul style="list-style-type: none"> ● 3 TRUCK ★ R143 EK8X4L AM61 AM70 - 8X2 8X4 LHD - R143 8X2 8X4 LHD/RHD - P93 8X4 RHD - P93 8X2 8X4 LHD - P93 MK8X4R - P - R113 HK8X4L AM61 - MK8X4L AM56/AM61 - EK8X4L AM61/AM70 - P113 MK8X4R AM56/AM61 - EK8X4R AM61 - 8X2 8X4 LHD AM56 AM61 AM70 AM800 AM820 - 8X4 RHD - P - R113 8X2 8X4 LHD AM56 AM61 AM70 AM800 AM820 - P - R113 8X4 RHD 			
<ul style="list-style-type: none"> ● 4 TRUCK ★ P/R CB 8X4 LHD/RHD - P/R GB 8X2 8X4 LHD/RHD - P/R CB 8X4 LHD DSC12 05 - P/R GB 8X2 8X4 LHD/RHD DSC12 05 - P CB 8X4 N RHD FRONTLINE - P CB 8X8 LHD - 8X8 WLS/ZLS 			
<ul style="list-style-type: none"> ● P-G-R-T TRUCK ★ P/R/G CB 8X4 LHD - P/R/G L/D/CB 8X2 - L/CB 8X4 LHD/RHD - R L/C 8X2 - 8X4 LHD/RHD - R L/CB 8X2 8X4 LHD 			



DRAG LINK LHD	64003	1343262	
<ul style="list-style-type: none"> ● 4 TRUCK ★ 6X2/4 - 8X2/4 - 8X8 			
<ul style="list-style-type: none"> ● P-G-R-T TRUCK ★ 6X2/4 - 8X2 - 8X2/4 - 8X2*6 - 8X4 			



ALL THE COMPONENTS LISTED IN OUR CATALOGUE ARE NOT ORIGINAL, THOUGH PERFECTLY INTERCHANGEABLE. REFERENCE NUMBERS, EITHER ORIGINAL OR OF A DIFFERENT NATURE, ARE FOR INFORMATION PURPOSES ONLY WHEN PLACING AN ORDER, PLEASE, ALWAYS USE COSIBO REFERENCE NUMBERS AND DO NOT MENTION THE ORIGINAL REFERENCE NUMBERS OF THE TRUCK MANUFACTURERS IN THE INVOICE TO VEHICLE OWNERS OR TO ANYBODY ELSE. THE CUSTOMER TAKES HIS OWN RESPONSIBILITY IF HE DOES NOT COMPLY WITH WHAT ABOVE.

	Code	OEM new	OEM old
DRAG LINK	64186	1765382	
<ul style="list-style-type: none"> ● Model ★ Application 			
<ul style="list-style-type: none"> ● 4 TRUCK ★ 			
<ul style="list-style-type: none"> ● P-G-R-T TRUCK ★ 			



STEERING DRAG LINK	61654	370875	370875
<ul style="list-style-type: none"> ● 3 TRUCK ★ R93 LHD AM56/61 - P/R113 LHD AM56/61 - R143 LHD AM56/61 			



STEERING DRAG LINK	61656	390784	
<ul style="list-style-type: none"> ● 3 TRUCK ★ R93/113/143 			



ALL THE COMPONENTS LISTED IN OUR CATALOGUE ARE NOT ORIGINAL, THOUGH PERFECTLY INTERCHANGEABLE. REFERENCE NUMBERS, EITHER ORIGINAL OR OF A DIFFERENT NATURE, ARE FOR INFORMATION PURPOSES ONLY WHEN PLACING AN ORDER, PLEASE, ALWAYS USE COSIBO REFERENCE NUMBERS AND DO NOT MENTION THE ORIGINAL REFERENCE NUMBERS OF THE TRUCK MANUFACTURERS IN THE INVOICE TO VEHICLE OWNERS OR TO ANYBODY ELSE. THE CUSTOMER TAKES HIS OWN RESPONSIBILITY IF HE DOES NOT COMPLY WITH WHAT ABOVE.

FLEXIBLE HOSE



- Model
- ★ Application

Code

OEM new

OEM old

63353

346077

- 3 TRUCK

- ★ R113/143

- 4 TRUCK

- ★

- P-G-R-T TRUCK

- ★ P/G/R

RUBBER HOSE



- 4 TRUCK

- ★ 94 - 114 - 124 - 144 - 164

- P-G-R-T TRUCK

- ★ P/R/G

65359

1375391

RUBBER HOSE



- 4 TRUCK

- ★ 94 - 114 - 124 - 144 - 164

- P-G-R-T TRUCK

- ★ P/R/G

64721

1375390

ALL THE COMPONENTS LISTED IN OUR CATALOGUE ARE NOT ORIGINAL, THOUGH PERFECTLY INTERCHANGEABLE. REFERENCE NUMBERS, EITHER ORIGINAL OR OF A DIFFERENT NATURE, ARE FOR INFORMATION PURPOSES ONLY WHEN PLACING AN ORDER, PLEASE, ALWAYS USE COSIBO REFERENCE NUMBERS AND DO NOT MENTION THE ORIGINAL REFERENCE NUMBERS OF THE TRUCK MANUFACTURERS IN THE INVOICE TO VEHICLE OWNERS OR TO ANYBODY ELSE. THE CUSTOMER TAKES HIS OWN RESPONSIBILITY IF HE DOES NOT COMPLY WITH WHAT ABOVE.

O-RING DIAM.=59,5X3 mm



● Model
★ Application

Code

OEM new

OEM old

60636

332119

392663

● 3 BUS

★

● 4 TRUCK

★

● F-K-N BUS

★ K UD 6X2

● P-G-R-T TRUCK

★

ALL THE COMPONENTS LISTED IN OUR CATALOGUE ARE NOT ORIGINAL, THOUGH PERFECTLY INTERCHANGEABLE. REFERENCE NUMBERS, EITHER ORIGINAL OR OF A DIFFERENT NATURE, ARE FOR INFORMATION PURPOSES ONLY WHEN PLACING AN ORDER, PLEASE, ALWAYS USE COSIBO REFERENCE NUMBERS AND DO NOT MENTION THE ORIGINAL REFERENCE NUMBERS OF THE TRUCK MANUFACTURERS IN THE INVOICE TO VEHICLE OWNERS OR TO ANYBODY ELSE. THE CUSTOMER TAKES HIS OWN RESPONSIBILITY IF HE DOES NOT COMPLY WITH WHAT ABOVE.

	Code	OEM new	OEM old
CLAMP D. 16	64084	813937	
● Model			
★ Application			
● 3 BUS			
★			
● 4 BUS			
★			
● F-K-N BUS			
★			
● 3 TRUCK			
★			



CLAMP D.20	64085	813939	
● 3 BUS			
★			
● 4 BUS			
★			
● F-K-N BUS			
★			
● 3 TRUCK			
★			
● 4 TRUCK			
★			
● P-G-R-T TRUCK			
★			



ALL THE COMPONENTS LISTED IN OUR CATALOGUE ARE NOT ORIGINAL, THOUGH PERFECTLY INTERCHANGEABLE. REFERENCE NUMBERS, EITHER ORIGINAL OR OF A DIFFERENT NATURE, ARE FOR INFORMATION PURPOSES ONLY WHEN PLACING AN ORDER, PLEASE, ALWAYS USE COSIBO REFERENCE NUMBERS AND DO NOT MENTION THE ORIGINAL REFERENCE NUMBERS OF THE TRUCK MANUFACTURERS IN THE INVOICE TO VEHICLE OWNERS OR TO ANYBODY ELSE. THE CUSTOMER TAKES HIS OWN RESPONSIBILITY IF HE DOES NOT COMPLY WITH WHAT ABOVE.

	Code	OEM new	OEM old
CLAMP D.25	64086	813941	
<ul style="list-style-type: none"> ● Model ★ Application 			
<ul style="list-style-type: none"> ● 3 BUS ★ 			
<ul style="list-style-type: none"> ● 4 BUS ★ 			
<ul style="list-style-type: none"> ● F-K-N BUS ★ 			
<ul style="list-style-type: none"> ● 3 TRUCK ★ 			
<ul style="list-style-type: none"> ● 4 TRUCK ★ 			



CLAMP D.13	64091	813936	
<ul style="list-style-type: none"> ● 4 BUS ★ 			
<ul style="list-style-type: none"> ● F-K-N BUS ★ 			
<ul style="list-style-type: none"> ● 3 TRUCK ★ 			
<ul style="list-style-type: none"> ● 4 TRUCK ★ 			
<ul style="list-style-type: none"> ● P-G-R-T TRUCK ★ 			



CLAMP D.18	64092	813938	
<ul style="list-style-type: none"> ● 3 BUS ★ 			
<ul style="list-style-type: none"> ● 3 TRUCK ★ 			



ALL THE COMPONENTS LISTED IN OUR CATALOGUE ARE NOT ORIGINAL, THOUGH PERFECTLY INTERCHANGEABLE. REFERENCE NUMBERS, EITHER ORIGINAL OR OF A DIFFERENT NATURE, ARE FOR INFORMATION PURPOSES ONLY WHEN PLACING AN ORDER, PLEASE, ALWAYS USE COSIBO REFERENCE NUMBERS AND DO NOT MENTION THE ORIGINAL REFERENCE NUMBERS OF THE TRUCK MANUFACTURERS IN THE INVOICE TO VEHICLE OWNERS OR TO ANYBODY ELSE. THE CUSTOMER TAKES HIS OWN RESPONSIBILITY IF HE DOES NOT COMPLY WITH WHAT ABOVE.

	Code	OEM new	OEM old
CLAMP D.28	64095	804578	
<ul style="list-style-type: none"> ● Model ★ Application 			
<ul style="list-style-type: none"> ● 4 BUS ★ 			
<ul style="list-style-type: none"> ● 3 TRUCK ★ 			
<ul style="list-style-type: none"> ● 4 TRUCK ★ 			
<ul style="list-style-type: none"> ● P-G-R-T TRUCK ★ 			



CLAMP D.32	64100	804583	
<ul style="list-style-type: none"> ● 3 TRUCK ★ 			



ALL THE COMPONENTS LISTED IN OUR CATALOGUE ARE NOT ORIGINAL, THOUGH PERFECTLY INTERCHANGEABLE. REFERENCE NUMBERS, EITHER ORIGINAL OR OF A DIFFERENT NATURE, ARE FOR INFORMATION PURPOSES ONLY WHEN PLACING AN ORDER, PLEASE, ALWAYS USE COSIBO REFERENCE NUMBERS AND DO NOT MENTION THE ORIGINAL REFERENCE NUMBERS OF THE TRUCK MANUFACTURERS IN THE INVOICE TO VEHICLE OWNERS OR TO ANYBODY ELSE. THE CUSTOMER TAKES HIS OWN RESPONSIBILITY IF HE DOES NOT COMPLY WITH WHAT ABOVE.

LH SPOT LAMP CLEAR LENS



- Model
 - ★ Application
-
- P-G-R-T TRUCK
 - ★ LOW & HIGH BUMPER

Code	OEM new	OEM old
62425	1852569	1446353

RH SPOT LAMP CLEAR LENS



- P-G-R-T TRUCK
- ★ LOW & HIGH BUMPER

62424	1852570	1446354
-------	---------	---------

LH FOG LAMP CLEAR LENS



- P-G-R-T TRUCK
- ★ LOW & HIGH BUMPER

62426	1852572	1446355
-------	---------	---------

ALL THE COMPONENTS LISTED IN OUR CATALOGUE ARE NOT ORIGINAL, THOUGH PERFECTLY INTERCHANGEABLE. REFERENCE NUMBERS, EITHER ORIGINAL OR OF A DIFFERENT NATURE, ARE FOR INFORMATION PURPOSES ONLY WHEN PLACING AN ORDER, PLEASE, ALWAYS USE COSIBO REFERENCE NUMBERS AND DO NOT MENTION THE ORIGINAL REFERENCE NUMBERS OF THE TRUCK MANUFACTURERS IN THE INVOICE TO VEHICLE OWNERS OR TO ANYBODY ELSE. THE CUSTOMER TAKES HIS OWN RESPONSIBILITY IF HE DOES NOT COMPLY WITH WHAT ABOVE.

RH FOG LAMP CLEAR LENS



- Model
- ★ Application
- P-G-R-T TRUCK
- ★ LOW & HIGH BUMPER

Code	OEM new	OEM old
62427	1852573	1446356

LH LAMP HOUSING



- P-G-R-T TRUCK
- ★ LOW & HIGH BUMPER

64672	1786692	1523881
-------	---------	---------

RH LAMP HOUSING



- P-G-R-T TRUCK
- ★ LOW & HIGH BUMPER

64673	1786693	1523882
-------	---------	---------

LH FOG LAMP



- 4 TRUCK
- ★ 94 - 114 - 124 - 144 - 164

62261	1529070	1422991
-------	---------	---------

ALL THE COMPONENTS LISTED IN OUR CATALOGUE ARE NOT ORIGINAL, THOUGH PERFECTLY INTERCHANGEABLE. REFERENCE NUMBERS, EITHER ORIGINAL OR OF A DIFFERENT NATURE, ARE FOR INFORMATION PURPOSES ONLY WHEN PLACING AN ORDER, PLEASE, ALWAYS USE COSIBO REFERENCE NUMBERS AND DO NOT MENTION THE ORIGINAL REFERENCE NUMBERS OF THE TRUCK MANUFACTURERS IN THE INVOICE TO VEHICLE OWNERS OR TO ANYBODY ELSE. THE CUSTOMER TAKES HIS OWN RESPONSIBILITY IF HE DOES NOT COMPLY WITH WHAT ABOVE.

RH FOG LAMP



	Code	OEM new	OEM old
● Model	62262	1529071	1422992
★ Application			

● 4 TRUCK			
★ 94 - 114 - 124 - 144 - 164			

FOG LAMP BULB HOLDER



	62234	1400209	
--	-------	---------	--

● 4 TRUCK			
★			
● P-G-R-T TRUCK			
★			

LHD,LH HEADLAMP ASSY



	62258	1732509	1431257 1446587 1467000
--	-------	---------	-------------------------------

● 4 TRUCK			
★ 94 - 114 - 124 - 144 - 164			
● P-G-R-T TRUCK			
★			





LHD,RH HEADLAMP ASSY



	62257	1732510	1431256 1446588 1467003
--	-------	---------	-------------------------------

● 4 TRUCK			
★ 94 - 114 - 124 - 144 - 164			
● P-G-R-T TRUCK			
★			

ALL THE COMPONENTS LISTED IN OUR CATALOGUE ARE NOT ORIGINAL, THOUGH PERFECTLY INTERCHANGEABLE. REFERENCE NUMBERS, EITHER ORIGINAL OR OF A DIFFERENT NATURE, ARE FOR INFORMATION PURPOSES ONLY WHEN PLACING AN ORDER, PLEASE, ALWAYS USE COSIBO REFERENCE NUMBERS AND DO NOT MENTION THE ORIGINAL REFERENCE NUMBERS OF THE TRUCK MANUFACTURERS IN THE INVOICE TO VEHICLE OWNERS OR TO ANYBODY ELSE. THE CUSTOMER TAKES HIS OWN RESPONSIBILITY IF HE DOES NOT COMPLY WITH WHAT ABOVE.

	Code	OEM new	OEM old
<p>LH LENS</p> 	62278	1446583	
<ul style="list-style-type: none"> ● Model ★ Application 			
<ul style="list-style-type: none"> ● 4 TRUCK 			
<ul style="list-style-type: none"> ★ 94 - 114 - 124 - 144 - 164 FOR OUR 62258 			
<ul style="list-style-type: none"> ● P-G-R-T TRUCK 			
<ul style="list-style-type: none"> ★ FOR OUR 62258 			
<p>RH LENS</p> 	62279	1446584	
<ul style="list-style-type: none"> ● 4 TRUCK 			
<ul style="list-style-type: none"> ★ 94 - 114 - 124 - 144 - 164 FOR OUR 62257 			
<ul style="list-style-type: none"> ● P-G-R-T TRUCK 			
<ul style="list-style-type: none"> ★ FOR OUR 62257 			
<p>LHD,LH HEADLAMP REFLECTOR</p> 	62358	1385406	
<ul style="list-style-type: none"> ● 4 TRUCK 			
<ul style="list-style-type: none"> ★ 94 - 114 - 124 - 144 - 164 FOR OUR 62258 			
<ul style="list-style-type: none"> ● P-G-R-T TRUCK 			
<ul style="list-style-type: none"> ★ FOR OUR 62258 			
<p>LHD,RH HEADLAMP REFLECTOR</p> 	62359	1385407	
<ul style="list-style-type: none"> ● 4 TRUCK 			
<ul style="list-style-type: none"> ★ 94 - 114 - 124 - 144 - 164 FOR OUR 62257 			
<ul style="list-style-type: none"> ● P-G-R-T TRUCK 			
<ul style="list-style-type: none"> ★ FOR OUR 62257 			

ALL THE COMPONENTS LISTED IN OUR CATALOGUE ARE NOT ORIGINAL, THOUGH PERFECTLY INTERCHANGEABLE. REFERENCE NUMBERS, EITHER ORIGINAL OR OF A DIFFERENT NATURE, ARE FOR INFORMATION PURPOSES ONLY WHEN PLACING AN ORDER, PLEASE, ALWAYS USE COSIBO REFERENCE NUMBERS AND DO NOT MENTION THE ORIGINAL REFERENCE NUMBERS OF THE TRUCK MANUFACTURERS IN THE INVOICE TO VEHICLE OWNERS OR TO ANYBODY ELSE. THE CUSTOMER TAKES HIS OWN RESPONSIBILITY IF HE DOES NOT COMPLY WITH WHAT ABOVE.

	Code	OEM new	OEM old
LH HEADLAMP FRAME	62387	1385402	
<ul style="list-style-type: none"> ● Model ★ Application 			
<ul style="list-style-type: none"> ● 4 TRUCK 			
<ul style="list-style-type: none"> ★ 94 - 114 - 124 - 144 - 164 FOR OUR 62257 & 62258 - 63915 & 63916 			
<ul style="list-style-type: none"> ● P-G-R-T TRUCK 			
<ul style="list-style-type: none"> ★ FOR OUR 62257 & 62258 - 63915 & 63916 			



RH HEADLAMP FRAME	62388	1385403	
<ul style="list-style-type: none"> ● 4 TRUCK 			
<ul style="list-style-type: none"> ★ 94 - 114 - 124 - 144 - 164 FOR OUR 62257 & 62258 - 63915 & 63916 			
<ul style="list-style-type: none"> ● P-G-R-T TRUCK 			
<ul style="list-style-type: none"> ★ FOR OUR 62257 & 62258 - 63915 & 63916 			



LH/RH BULB HOLDER	62404	1732515	1467007
<ul style="list-style-type: none"> ● 4 TRUCK 			
<ul style="list-style-type: none"> ★ 94 - 114 - 124 - 144 - 164 FOR OUR 62257 & 62258 - 63915 & 63916 			
<ul style="list-style-type: none"> ● P-G-R-T TRUCK 			
<ul style="list-style-type: none"> ★ FOR OUR 62257 & 62258 - 63915 & 63916 			



RHD,LH HEADLAMP ASSY	63915	1732507	1348539 1431255 1446585 1467001
<ul style="list-style-type: none"> ● 4 TRUCK 			
<ul style="list-style-type: none"> ★ 94 - 114 - 124 - 144 - 164 			
<ul style="list-style-type: none"> ● P-G-R-T TRUCK 			
<ul style="list-style-type: none"> ★ 			



ALL THE COMPONENTS LISTED IN OUR CATALOGUE ARE NOT ORIGINAL, THOUGH PERFECTLY INTERCHANGEABLE. REFERENCE NUMBERS, EITHER ORIGINAL OR OF A DIFFERENT NATURE, ARE FOR INFORMATION PURPOSES ONLY WHEN PLACING AN ORDER, PLEASE, ALWAYS USE COSIBO REFERENCE NUMBERS AND DO NOT MENTION THE ORIGINAL REFERENCE NUMBERS OF THE TRUCK MANUFACTURERS IN THE INVOICE TO VEHICLE OWNERS OR TO ANYBODY ELSE. THE CUSTOMER TAKES HIS OWN RESPONSIBILITY IF HE DOES NOT COMPLY WITH WHAT ABOVE.

RHD,RH HEADLAMP ASSY

- Model
- ★ Application

Code	OEM new	OEM old
63916	1732508	1348540 1431254 1446586 1467002

- 4 TRUCK
- ★ 94 - 114 - 124 - 144 - 164

- P-G-R-T TRUCK
- ★



LH LENS

65373

1446581

1349781

- 4 TRUCK
- ★ 94 - 114 - 124 - 144 - 164 FOR OUR 63915

- P-G-R-T TRUCK
- ★ FOR OUR 63915



RH LENS

65374

1446582

1349782

- 4 TRUCK
- ★ 94 - 114 - 124 - 144 - 164 FOR OUR 63916

- P-G-R-T TRUCK
- ★ FOR OUR NS. 63916



ALL THE COMPONENTS LISTED IN OUR CATALOGUE ARE NOT ORIGINAL, THOUGH PERFECTLY INTERCHANGEABLE. REFERENCE NUMBERS, EITHER ORIGINAL OR OF A DIFFERENT NATURE, ARE FOR INFORMATION PURPOSES ONLY WHEN PLACING AN ORDER, PLEASE, ALWAYS USE COSIBO REFERENCE NUMBERS AND DO NOT MENTION THE ORIGINAL REFERENCE NUMBERS OF THE TRUCK MANUFACTURERS IN THE INVOICE TO VEHICLE OWNERS OR TO ANYBODY ELSE. THE CUSTOMER TAKES HIS OWN RESPONSIBILITY IF HE DOES NOT COMPLY WITH WHAT ABOVE.

LH HEADLAMP ASSY



	Code	OEM new	OEM old
● Model	63600	1308473	
★ Application			
● 2 TRUCK			
★ 82 - 92 - 112 - 142			
● 3 TRUCK			
★ STREAMLINE - 93 - 113 - 143			

RH HEADLAMP ASSY



	Code	OEM new	OEM old
	63599	1308474	
● 2 TRUCK			
★ 82 - 92 - 112 - 142			
● 2 TRUCK			
★ 82 - 92 - 112 - 142			
● 3 TRUCK			
★ STREAMLINE - 93 - 113 - 143			
● 3 TRUCK			
★ STREAMLINE - 93 - 113 - 143			

LH/RH HEADLAMP LENS



	Code	OEM new	OEM old
	62298	280553	
● 2 TRUCK			
★ 82 - 92 - 112 - 142 FOR OUR 63600 & 63599			
● 3 TRUCK			
★ STREAMLINE - 93 - 113 - 143 FOR OUR 63600 & 63599			

ALL THE COMPONENTS LISTED IN OUR CATALOGUE ARE NOT ORIGINAL, THOUGH PERFECTLY INTERCHANGEABLE. REFERENCE NUMBERS, EITHER ORIGINAL OR OF A DIFFERENT NATURE, ARE FOR INFORMATION PURPOSES ONLY WHEN PLACING AN ORDER, PLEASE, ALWAYS USE COSIBO REFERENCE NUMBERS AND DO NOT MENTION THE ORIGINAL REFERENCE NUMBERS OF THE TRUCK MANUFACTURERS IN THE INVOICE TO VEHICLE OWNERS OR TO ANYBODY ELSE. THE CUSTOMER TAKES HIS OWN RESPONSIBILITY IF HE DOES NOT COMPLY WITH WHAT ABOVE.

LHD,LH XENON HEADLAMP ASSY



	Code	OEM new	OEM old
● Model	64668	1892322	1730953 1760551 1900349
★ Application			
● 4 TRUCK			
★ 94 - 114 - 124 - 144 - 164			
● P-G-R-T TRUCK			
★			

LHD,RH XENON HEADLAMP ASSY



	Code	OEM new	OEM old
	64667	1892324	1730958 1760554 1900351
● 4 TRUCK			
★ 94 - 114 - 124 - 144 - 164			
● P-G-R-T TRUCK			
★			

RHD,LH HEADLAMP REFLECTOR



	Code	OEM new	OEM old
	65375	1385413	
● 4 TRUCK			
★ 94 - 114 - 124 - 144 - 164 FOR OUR 63915			
● P-G-R-T TRUCK			
★ FOR OUR 63915			

RHD,RH HEADLAMP REFLECTOR



	Code	OEM new	OEM old
	65376	138414	
● 4 TRUCK			
★ 94 - 114 - 124 - 144 - 164 FOR OUR 63916			
● P-G-R-T TRUCK			
★ FOR OUR 63916			

ALL THE COMPONENTS LISTED IN OUR CATALOGUE ARE NOT ORIGINAL, THOUGH PERFECTLY INTERCHANGEABLE. REFERENCE NUMBERS, EITHER ORIGINAL OR OF A DIFFERENT NATURE, ARE FOR INFORMATION PURPOSES ONLY WHEN PLACING AN ORDER, PLEASE, ALWAYS USE COSIBO REFERENCE NUMBERS AND DO NOT MENTION THE ORIGINAL REFERENCE NUMBERS OF THE TRUCK MANUFACTURERS IN THE INVOICE TO VEHICLE OWNERS OR TO ANYBODY ELSE. THE CUSTOMER TAKES HIS OWN RESPONSIBILITY IF HE DOES NOT COMPLY WITH WHAT ABOVE.

	Code	OEM new	OEM old
HADLAMP SEAL	65377	1385409	
<ul style="list-style-type: none"> ● Model ★ Application 			
<ul style="list-style-type: none"> ● 4 TRUCK 			
<ul style="list-style-type: none"> ★ 94 - 114 - 124 - 144 - 164 FOR OUR 62257 & 62258 - 63915 & 63916 			
<ul style="list-style-type: none"> ● P-G-R-T TRUCK 			
<ul style="list-style-type: none"> ★ FOR OUR 62257 & 62258 - 63915 & 63916 			



LIGHT HOUSING	64683	1300831	370990
----------------------	--------------	---------	--------



<ul style="list-style-type: none"> ● 3 TRUCK 			
<ul style="list-style-type: none"> ★ 			

LIGHT DAMPER	60023	1412265	1327274
---------------------	--------------	---------	---------



<ul style="list-style-type: none"> ● P-G-R-T TRUCK 			
<ul style="list-style-type: none"> ★ 			

ALL THE COMPONENTS LISTED IN OUR CATALOGUE ARE NOT ORIGINAL, THOUGH PERFECTLY INTERCHANGEABLE. REFERENCE NUMBERS, EITHER ORIGINAL OR OF A DIFFERENT NATURE, ARE FOR INFORMATION PURPOSES ONLY WHEN PLACING AN ORDER, PLEASE, ALWAYS USE COSIBO REFERENCE NUMBERS AND DO NOT MENTION THE ORIGINAL REFERENCE NUMBERS OF THE TRUCK MANUFACTURERS IN THE INVOICE TO VEHICLE OWNERS OR TO ANYBODY ELSE. THE CUSTOMER TAKES HIS OWN RESPONSIBILITY IF HE DOES NOT COMPLY WITH WHAT ABOVE.

LH INDICATOR



	Code	OEM new	OEM old
● Model	60511	1385410	
★ Application			
● 4 TRUCK			
★ 94 - 114 - 124 - 144 - 164 FOR OUR 62258 - 63915			
● P-G-R-T TRUCK			
★ FOR OUR 62258 - 63915			

RH INDICATOR



	Code	OEM new	OEM old
	60512	1387155	
● 4 TRUCK			
★ 94 - 114 - 124 - 144 - 164 FOR OUR 62257 - 63916			
● P-G-R-T TRUCK			
★ FOR OUR 62257 - 63916			

LH/RH CORNER LAMP



	Code	OEM new	OEM old
	64653	1747981	1521683
● P-G-R-T TRUCK			
★ FOR XENON LIGHT LHD & RHD			

ALL THE COMPONENTS LISTED IN OUR CATALOGUE ARE NOT ORIGINAL, THOUGH PERFECTLY INTERCHANGEABLE. REFERENCE NUMBERS, EITHER ORIGINAL OR OF A DIFFERENT NATURE, ARE FOR INFORMATION PURPOSES ONLY WHEN PLACING AN ORDER, PLEASE, ALWAYS USE COSIBO REFERENCE NUMBERS AND DO NOT MENTION THE ORIGINAL REFERENCE NUMBERS OF THE TRUCK MANUFACTURERS IN THE INVOICE TO VEHICLE OWNERS OR TO ANYBODY ELSE. THE CUSTOMER TAKES HIS OWN RESPONSIBILITY IF HE DOES NOT COMPLY WITH WHAT ABOVE.

LH INDICATOR LAMP ASSY

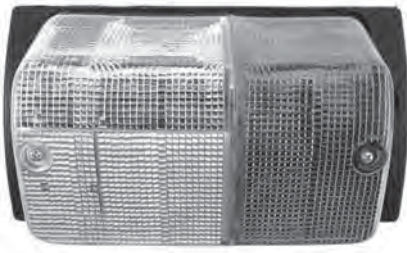

	Code	OEM new	OEM old
● Model	61661	1365968	394766
★ Application			
● 2 TRUCK			
★ 92 - 112 - 142			
● 3 TRUCK			
★ 93 - 113 - 143			

RH INDICATOR LAMP ASSY

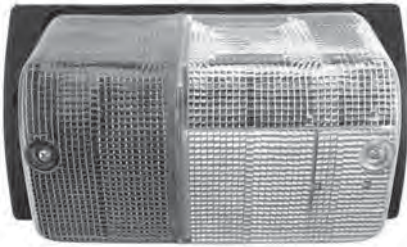

	Code	OEM new	OEM old
	61662	1365969	394767
● 2 TRUCK			
★ 92 - 112 - 142			
● 3 TRUCK			
★ 93 - 113 - 143			

LH INDICATOR LAMP ASSY

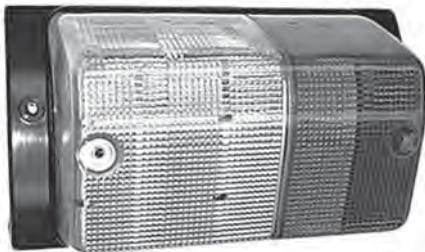

	Code	OEM new	OEM old
	62270	394768	
● 2 TRUCK			
★ 92 - 112 - 142			
● 3 TRUCK			
★ 93 - 113 - 143			

RH INDICATOR LAMP ASSY

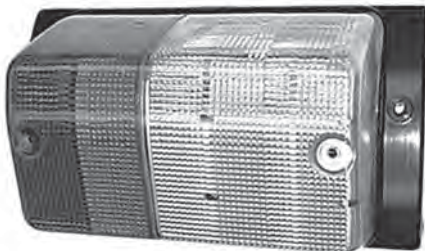

	Code	OEM new	OEM old
	62271	394769	
● 2 TRUCK			
★ 92 - 112 - 142			
● 3 TRUCK			
★ 93 - 113 - 143			

ALL THE COMPONENTS LISTED IN OUR CATALOGUE ARE NOT ORIGINAL, THOUGH PERFECTLY INTERCHANGEABLE. REFERENCE NUMBERS, EITHER ORIGINAL OR OF A DIFFERENT NATURE, ARE FOR INFORMATION PURPOSES ONLY WHEN PLACING AN ORDER, PLEASE, ALWAYS USE COSIBO REFERENCE NUMBERS AND DO NOT MENTION THE ORIGINAL REFERENCE NUMBERS OF THE TRUCK MANUFACTURERS IN THE INVOICE TO VEHICLE OWNERS OR TO ANYBODY ELSE. THE CUSTOMER TAKES HIS OWN RESPONSIBILITY IF HE DOES NOT COMPLY WITH WHAT ABOVE.

LH DIRECTION LAMP LENS

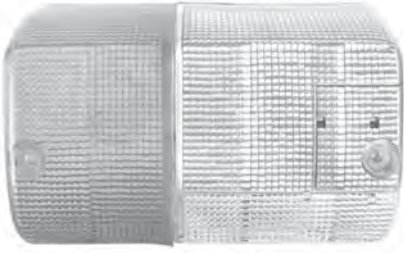

	Code	OEM new	OEM old
● Model	61663	1371292	313657
★ Application			
● 2 TRUCK			
★ 92 - 112 - 142			
● 3 TRUCK			
★ 93 - 113 - 143			

RH DIRECTION LAMP LENS

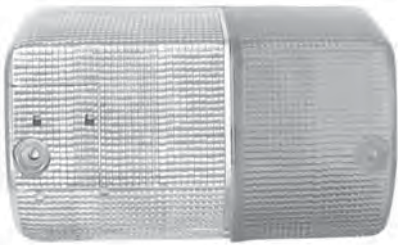

	Code	OEM new	OEM old
	61664	1371293	313658
● 2 TRUCK			
★ 92 - 112 - 142			
● 3 TRUCK			
★ 93 - 113 - 143			

INDICATOR AND PARKING LAMP



	Code	OEM new	OEM old
	62523	1304786	
● 3 TRUCK			
★ STREAMLINE			

SIDE INDICATOR



	Code	OEM new	OEM old
	62420	1304787	
● 3 TRUCK			
★ STREAMLINE			

ALL THE COMPONENTS LISTED IN OUR CATALOGUE ARE NOT ORIGINAL, THOUGH PERFECTLY INTERCHANGEABLE. REFERENCE NUMBERS, EITHER ORIGINAL OR OF A DIFFERENT NATURE, ARE FOR INFORMATION PURPOSES ONLY WHEN PLACING AN ORDER, PLEASE, ALWAYS USE COSIBO REFERENCE NUMBERS AND DO NOT MENTION THE ORIGINAL REFERENCE NUMBERS OF THE TRUCK MANUFACTURERS IN THE INVOICE TO VEHICLE OWNERS OR TO ANYBODY ELSE. THE CUSTOMER TAKES HIS OWN RESPONSIBILITY IF HE DOES NOT COMPLY WITH WHAT ABOVE.

SIDE MARKER LAMP ASSY



- Model
 - ★ Application
-
- P-G-R-T TRUCK
 - ★

Code	OEM new	OEM old
62524	1770301	1722531

ALL THE COMPONENTS LISTED IN OUR CATALOGUE ARE NOT ORIGINAL, THOUGH PERFECTLY INTERCHANGEABLE. REFERENCE NUMBERS, EITHER ORIGINAL OR OF A DIFFERENT NATURE, ARE FOR INFORMATION PURPOSES ONLY WHEN PLACING AN ORDER, PLEASE, ALWAYS USE COSIBO REFERENCE NUMBERS AND DO NOT MENTION THE ORIGINAL REFERENCE NUMBERS OF THE TRUCK MANUFACTURERS IN THE INVOICE TO VEHICLE OWNERS OR TO ANYBODY ELSE. THE CUSTOMER TAKES HIS OWN RESPONSIBILITY IF HE DOES NOT COMPLY WITH WHAT ABOVE.

LH/RH REAR TAIL LAMP



- Model
- ★ Application

Code	OEM new	OEM old
63438	1368123	371894 371896

- **3 TRUCK**
- ★ MA - MK8X4

LH/RH REAR LENS



- **3 TRUCK**
- ★ MA - MK8X4

60496	297568	
--------------	--------	--

LH REAR LIGHT



- **3 TRUCK**
- ★ STD - MA6X2Z

63357	1386272	1365958 1365960
--------------	---------	--------------------

ALL THE COMPONENTS LISTED IN OUR CATALOGUE ARE NOT ORIGINAL, THOUGH PERFECTLY INTERCHANGEABLE. REFERENCE NUMBERS, EITHER ORIGINAL OR OF A DIFFERENT NATURE, ARE FOR INFORMATION PURPOSES ONLY WHEN PLACING AN ORDER, PLEASE, ALWAYS USE COSIBO REFERENCE NUMBERS AND DO NOT MENTION THE ORIGINAL REFERENCE NUMBERS OF THE TRUCK MANUFACTURERS IN THE INVOICE TO VEHICLE OWNERS OR TO ANYBODY ELSE. THE CUSTOMER TAKES HIS OWN RESPONSIBILITY IF HE DOES NOT COMPLY WITH WHAT ABOVE.

RH REAR LIGHT



- Model
- ★ Application

Code	OEM new	OEM old
63356	1386271	1365959 1365961

- 3 TRUCK
- ★ STD - MA6X2Z

LIGHT DAMPER



- 3 TRUCK
- ★ MA - MK8X4

61317	366006	
-------	--------	--

LIGHT DAMPER



- 3 TRUCK
- ★ 4X4 6X6 HK6X4 - 8X4 TIPPER - MA HA MW 4X2 6X2 6X2/4 - STREAMLINE
- 4 TRUCK
- ★ 94 - 114 - 124 - 144 - 164

60023	1412265	1327274
-------	---------	---------

ALL THE COMPONENTS LISTED IN OUR CATALOGUE ARE NOT ORIGINAL, THOUGH PERFECTLY INTERCHANGEABLE. REFERENCE NUMBERS, EITHER ORIGINAL OR OF A DIFFERENT NATURE, ARE FOR INFORMATION PURPOSES ONLY WHEN PLACING AN ORDER, PLEASE, ALWAYS USE COSIBO REFERENCE NUMBERS AND DO NOT MENTION THE ORIGINAL REFERENCE NUMBERS OF THE TRUCK MANUFACTURERS IN THE INVOICE TO VEHICLE OWNERS OR TO ANYBODY ELSE. THE CUSTOMER TAKES HIS OWN RESPONSIBILITY IF HE DOES NOT COMPLY WITH WHAT ABOVE.

LH/RH REAR LIGHT LENS



	Code	OEM new	OEM old
● Model	63359	1350343	
★ Application			
● 3 TRUCK			
★ ATTENDERE ISTRUZIONI IN VALUTAZIONE			

LH TAIL LAMP (LHD/RHD)



	Code	OEM new	OEM old
	60501	1504608	1387877 1436867
● 4 TRUCK			
★			

RH TAIL LAMP (LHD/RHD)



	Code	OEM new	OEM old
	60500	1504609	1387878 1436868
● 4 TRUCK			
★			

RH/LH LENS REAR LENS



	Code	OEM new	OEM old
	60492	1380819	
● 4 TRUCK			
★			

ALL THE COMPONENTS LISTED IN OUR CATALOGUE ARE NOT ORIGINAL, THOUGH PERFECTLY INTERCHANGEABLE. REFERENCE NUMBERS, EITHER ORIGINAL OR OF A DIFFERENT NATURE, ARE FOR INFORMATION PURPOSES ONLY WHEN PLACING AN ORDER, PLEASE, ALWAYS USE COSIBO REFERENCE NUMBERS AND DO NOT MENTION THE ORIGINAL REFERENCE NUMBERS OF THE TRUCK MANUFACTURERS IN THE INVOICE TO VEHICLE OWNERS OR TO ANYBODY ELSE. THE CUSTOMER TAKES HIS OWN RESPONSIBILITY IF HE DOES NOT COMPLY WITH WHAT ABOVE.

	Code	OEM new	OEM old
REAR PLATE LIGHT	62269	1379384	
<ul style="list-style-type: none"> ● Model ★ Application 			
<ul style="list-style-type: none"> ● 4 TRUCK ★ 			
<ul style="list-style-type: none"> ● P-G-R-T TRUCK ★ 			
<ul style="list-style-type: none"> ● F-K-N BUS ★ CNUB 			



LH REAR LIGHT W/O PLATE LIGHT	64641	1792387	1504602
<ul style="list-style-type: none"> ● 4 TRUCK ★ 			
<ul style="list-style-type: none"> ● P-G-R-T TRUCK ★ 			



RH REAR LIGHT W/O PLATE LIGHT	64642	1792388	1504603
<ul style="list-style-type: none"> ● 4 TRUCK ★ 			
<ul style="list-style-type: none"> ● P-G-R-T TRUCK ★ 			



ALL THE COMPONENTS LISTED IN OUR CATALOGUE ARE NOT ORIGINAL, THOUGH PERFECTLY INTERCHANGEABLE. REFERENCE NUMBERS, EITHER ORIGINAL OR OF A DIFFERENT NATURE, ARE FOR INFORMATION PURPOSES ONLY WHEN PLACING AN ORDER, PLEASE, ALWAYS USE COSIBO REFERENCE NUMBERS AND DO NOT MENTION THE ORIGINAL REFERENCE NUMBERS OF THE TRUCK MANUFACTURERS IN THE INVOICE TO VEHICLE OWNERS OR TO ANYBODY ELSE. THE CUSTOMER TAKES HIS OWN RESPONSIBILITY IF HE DOES NOT COMPLY WITH WHAT ABOVE.

	Code	OEM new	OEM old
LH REAR LIGHT WITH PLATE LIGHT 	64639	1498102	
<ul style="list-style-type: none"> ● Model ★ Application 			
<ul style="list-style-type: none"> ● P-G-R-T TRUCK ★ 			
RH REAR LIGHT W/O PLATE LIGHT 	64640	1498103	
<ul style="list-style-type: none"> ● P-G-R-T TRUCK ★ 			
RH TAIL LAMP W/O ALARM 	64252	1792374	
<ul style="list-style-type: none"> ● 4 TRUCK ★ 			
<ul style="list-style-type: none"> ● P-G-R-T TRUCK ★ 			
LH TAIL LAMP WITH PLATE LIGHT 	64253	1792375	
<ul style="list-style-type: none"> ● 4 TRUCK ★ 			
<ul style="list-style-type: none"> ● P-G-R-T TRUCK ★ 			

ALL THE COMPONENTS LISTED IN OUR CATALOGUE ARE NOT ORIGINAL, THOUGH PERFECTLY INTERCHANGEABLE. REFERENCE NUMBERS, EITHER ORIGINAL OR OF A DIFFERENT NATURE, ARE FOR INFORMATION PURPOSES ONLY WHEN PLACING AN ORDER, PLEASE, ALWAYS USE COSIBO REFERENCE NUMBERS AND DO NOT MENTION THE ORIGINAL REFERENCE NUMBERS OF THE TRUCK MANUFACTURERS IN THE INVOICE TO VEHICLE OWNERS OR TO ANYBODY ELSE. THE CUSTOMER TAKES HIS OWN RESPONSIBILITY IF HE DOES NOT COMPLY WITH WHAT ABOVE.

LH HEADLIGHT HOUSING



	Code	OEM new	OEM old
● Model	62255	1543634	1324599
★ Application			
● 4 TRUCK			
★ 94 - 114 - 124 - 144 - 164			

RH HEADLIGHT HOUSING



	Code	OEM new	OEM old
	62254	1543635	1324600
● 4 TRUCK			
★ 94 - 114 - 124 - 144 - 164			

ALL THE COMPONENTS LISTED IN OUR CATALOGUE ARE NOT ORIGINAL, THOUGH PERFECTLY INTERCHANGEABLE. REFERENCE NUMBERS, EITHER ORIGINAL OR OF A DIFFERENT NATURE, ARE FOR INFORMATION PURPOSES ONLY WHEN PLACING AN ORDER, PLEASE, ALWAYS USE COSIBO REFERENCE NUMBERS AND DO NOT MENTION THE ORIGINAL REFERENCE NUMBERS OF THE TRUCK MANUFACTURERS IN THE INVOICE TO VEHICLE OWNERS OR TO ANYBODY ELSE. THE CUSTOMER TAKES HIS OWN RESPONSIBILITY IF HE DOES NOT COMPLY WITH WHAT ABOVE.

	Code	OEM new	OEM old
LH BRACKET	62444	1375427	

- Model
- ★ Application

- 4 TRUCK
- ★ 94 - 114 - 124 - 144 - 164



RH BRACKET	62443	1375428	
-------------------	--------------	---------	--

- 4 TRUCK
- ★ 94 - 114 - 124 - 144 - 164



LH HEADLIGHT FRAME	64655	1727991	1438557
---------------------------	--------------	---------	---------

- P-G-R-T TRUCK
- ★ CG/CP/CR



ALL THE COMPONENTS LISTED IN OUR CATALOGUE ARE NOT ORIGINAL, THOUGH PERFECTLY INTERCHANGEABLE. REFERENCE NUMBERS, EITHER ORIGINAL OR OF A DIFFERENT NATURE, ARE FOR INFORMATION PURPOSES ONLY WHEN PLACING AN ORDER, PLEASE, ALWAYS USE COSIBO REFERENCE NUMBERS AND DO NOT MENTION THE ORIGINAL REFERENCE NUMBERS OF THE TRUCK MANUFACTURERS IN THE INVOICE TO VEHICLE OWNERS OR TO ANYBODY ELSE. THE CUSTOMER TAKES HIS OWN RESPONSIBILITY IF HE DOES NOT COMPLY WITH WHAT ABOVE.

RH HEADLIGHT FRAME



	Code	OEM new	OEM old
● Model	64654	1727992	1438558
★ Application			

● P-G-R-T TRUCK
★ CG/CP/CR

LH HEADLAMP HOUSING



	64661	1431920	
--	--------------	---------	--

● P-G-R-T TRUCK
★ CG/CP/CR

RH HEADLAMP HOUSING



	64660	1431921	
--	--------------	---------	--

● P-G-R-T TRUCK
★ CG/CP/CR

ALL THE COMPONENTS LISTED IN OUR CATALOGUE ARE NOT ORIGINAL, THOUGH PERFECTLY INTERCHANGEABLE. REFERENCE NUMBERS, EITHER ORIGINAL OR OF A DIFFERENT NATURE, ARE FOR INFORMATION PURPOSES ONLY WHEN PLACING AN ORDER, PLEASE, ALWAYS USE COSIBO REFERENCE NUMBERS AND DO NOT MENTION THE ORIGINAL REFERENCE NUMBERS OF THE TRUCK MANUFACTURERS IN THE INVOICE TO VEHICLE OWNERS OR TO ANYBODY ELSE. THE CUSTOMER TAKES HIS OWN RESPONSIBILITY IF HE DOES NOT COMPLY WITH WHAT ABOVE.

LH SUPPORT



- Model
 - ★ Application
-
- P-G-R-T TRUCK
 - ★ CR/CT D16

Code	OEM new	OEM old
64657	1431922	

RH SUPPORT



- P-G-R-T TRUCK
- ★ CR/CT D16

64656	1431923	
-------	---------	--

LH SUPPORT



- P-G-R-T TRUCK
- ★ CG/CP/CT D9/11/12

64659	1438563	
-------	---------	--

ALL THE COMPONENTS LISTED IN OUR CATALOGUE ARE NOT ORIGINAL, THOUGH PERFECTLY INTERCHANGEABLE. REFERENCE NUMBERS, EITHER ORIGINAL OR OF A DIFFERENT NATURE, ARE FOR INFORMATION PURPOSES ONLY WHEN PLACING AN ORDER, PLEASE, ALWAYS USE COSIBO REFERENCE NUMBERS AND DO NOT MENTION THE ORIGINAL REFERENCE NUMBERS OF THE TRUCK MANUFACTURERS IN THE INVOICE TO VEHICLE OWNERS OR TO ANYBODY ELSE. THE CUSTOMER TAKES HIS OWN RESPONSIBILITY IF HE DOES NOT COMPLY WITH WHAT ABOVE.

RH SUPPORT



- Model
 - ★ Application
-
- P-G-R-T TRUCK
 - ★ CG/CP/CT D9/11/12

Code	OEM new	OEM old
64658	1438564	

ALL THE COMPONENTS LISTED IN OUR CATALOGUE ARE NOT ORIGINAL, THOUGH PERFECTLY INTERCHANGEABLE. REFERENCE NUMBERS, EITHER ORIGINAL OR OF A DIFFERENT NATURE, ARE FOR INFORMATION PURPOSES ONLY WHEN PLACING AN ORDER, PLEASE, ALWAYS USE COSIBO REFERENCE NUMBERS AND DO NOT MENTION THE ORIGINAL REFERENCE NUMBERS OF THE TRUCK MANUFACTURERS IN THE INVOICE TO VEHICLE OWNERS OR TO ANYBODY ELSE. THE CUSTOMER TAKES HIS OWN RESPONSIBILITY IF HE DOES NOT COMPLY WITH WHAT ABOVE.

	Code	OEM new	OEM old
LIGHT INDICATOR	60517	1358175	360248
● Model			
★ Application			
● 3 BUS			
★			
● 3 TRUCK			
★			



INDICATOR STALK	61645	367326	347893
● 3 BUS			
★			



WIPER INDICATOR	65248	360247	
● 3 BUS			
★			
● 3 TRUCK			
★			



ALL THE COMPONENTS LISTED IN OUR CATALOGUE ARE NOT ORIGINAL, THOUGH PERFECTLY INTERCHANGEABLE. REFERENCE NUMBERS, EITHER ORIGINAL OR OF A DIFFERENT NATURE, ARE FOR INFORMATION PURPOSES ONLY WHEN PLACING AN ORDER, PLEASE, ALWAYS USE COSIBO REFERENCE NUMBERS AND DO NOT MENTION THE ORIGINAL REFERENCE NUMBERS OF THE TRUCK MANUFACTURERS IN THE INVOICE TO VEHICLE OWNERS OR TO ANYBODY ELSE. THE CUSTOMER TAKES HIS OWN RESPONSIBILITY IF HE DOES NOT COMPLY WITH WHAT ABOVE.

DIRECTION INDICATOR



- **Model**
- ★ **Application**
- **4 BUS**
- ★ K/L/N 94
- **4 TRUCK**
- ★ 94 - 114 - 124 - 144 - 164

Code	OEM new	OEM old
65249	1402448	

DIRECTION INDICATOR WITH CRUISE CONTROL



- **4 BUS**
- ★ K/L/N 94
- **4 TRUCK**
- ★ 94 - 114 - 124 - 144 - 164

63809	1402449	
-------	---------	--

WIPER INDICATOR



- **4 BUS**
- ★ K/L/N 94
- **4 TRUCK**
- ★ 94 - 114 - 124 - 144 - 164

64184	1424970	1402450
-------	---------	---------

ALL THE COMPONENTS LISTED IN OUR CATALOGUE ARE NOT ORIGINAL, THOUGH PERFECTLY INTERCHANGEABLE. REFERENCE NUMBERS, EITHER ORIGINAL OR OF A DIFFERENT NATURE, ARE FOR INFORMATION PURPOSES ONLY WHEN PLACING AN ORDER, PLEASE, ALWAYS USE COSIBO REFERENCE NUMBERS AND DO NOT MENTION THE ORIGINAL REFERENCE NUMBERS OF THE TRUCK MANUFACTURERS IN THE INVOICE TO VEHICLE OWNERS OR TO ANYBODY ELSE. THE CUSTOMER TAKES HIS OWN RESPONSIBILITY IF HE DOES NOT COMPLY WITH WHAT ABOVE.

	Code	OEM new	OEM old
RELAY	65250	363712	331881
<ul style="list-style-type: none"> ● Model ★ Application 			
<ul style="list-style-type: none"> ● 3 BUS 			
<ul style="list-style-type: none"> ★ LHD/RHD 			
<ul style="list-style-type: none"> ● 3 TRUCK 			
<ul style="list-style-type: none"> ★ LHD/RHD 			



RELAY	65278	1334196	289929 334470 365559
<ul style="list-style-type: none"> ● 3 BUS 			
<ul style="list-style-type: none"> ★ 			
<ul style="list-style-type: none"> ● 3 TRUCK 			
<ul style="list-style-type: none"> ★ 			



SWITCH	61865	353628	
<ul style="list-style-type: none"> ● 3 TRUCK 			
<ul style="list-style-type: none"> ★ 			
<ul style="list-style-type: none"> ● 4 TRUCK 			
<ul style="list-style-type: none"> ★ 94 - 114 - 124 - 144 - 164 			



SWITCH	62398	1353142	
<ul style="list-style-type: none"> ● 4 TRUCK 			
<ul style="list-style-type: none"> ★ 94 - 114 - 124 - 144 - 164 - GA750R 			



ALL THE COMPONENTS LISTED IN OUR CATALOGUE ARE NOT ORIGINAL, THOUGH PERFECTLY INTERCHANGEABLE. REFERENCE NUMBERS, EITHER ORIGINAL OR OF A DIFFERENT NATURE, ARE FOR INFORMATION PURPOSES ONLY WHEN PLACING AN ORDER, PLEASE, ALWAYS USE COSIBO REFERENCE NUMBERS AND DO NOT MENTION THE ORIGINAL REFERENCE NUMBERS OF THE TRUCK MANUFACTURERS IN THE INVOICE TO VEHICLE OWNERS OR TO ANYBODY ELSE. THE CUSTOMER TAKES HIS OWN RESPONSIBILITY IF HE DOES NOT COMPLY WITH WHAT ABOVE.

		Code	OEM new	OEM old
RELAY	● Model	63450	1318306	278263
	★ Application			
	● 3 TRUCK			
	★			
	● 4 TRUCK			
	★			



RELAY		63447	1431781	1391322 243460
	● 3 TRUCK			
	★	LHD/RHD - EDC - RHD EDC G880 G900 - ABS CG/CP/CR/CT13 - ABS CR CT13 EDC ASR - CP CR CT13 ABS - ABS/ASR - ABS CP CR CT19 - ABS CR CT19 EDC/ASR - CP CR CT19 ABS - ABS/ASR - GA750 - 850CP13/19		
	● 4 TRUCK			
	★	ALLISON GA750 750R - GA751 751R - GA851 851R - GA852 852R LHD/RHD - ADR - WEBASTO ADR - CR19 TOPLINE		
	● P-G-R-T TRUCK			
	★			
	● 3 BUS			
	★	ABS/ASR		
	● 4 BUS			
★	N94 UD 4X2 - 6X2/4			
● F-K-N BUS				
★	CK/CN - IKIB - P2 - K/N - CNUD P700			



RELAY		63465	1902698	1327013 1401788 1504270
	● 4 TRUCK			
	★			
	● 4 BUS			
	★			



ALL THE COMPONENTS LISTED IN OUR CATALOGUE ARE NOT ORIGINAL, THOUGH PERFECTLY INTERCHANGEABLE. REFERENCE NUMBERS, EITHER ORIGINAL OR OF A DIFFERENT NATURE, ARE FOR INFORMATION PURPOSES ONLY WHEN PLACING AN ORDER, PLEASE, ALWAYS USE COSIBO REFERENCE NUMBERS AND DO NOT MENTION THE ORIGINAL REFERENCE NUMBERS OF THE TRUCK MANUFACTURERS IN THE INVOICE TO VEHICLE OWNERS OR TO ANYBODY ELSE. THE CUSTOMER TAKES HIS OWN RESPONSIBILITY IF HE DOES NOT COMPLY WITH WHAT ABOVE.

	Code	OEM new	OEM old
WIPER RELE'	63466	1902328	1335482 1523612 1741091
● Model			
★ Application			
● 4 TRUCK			
★ 94 - 114 - 124 - 144 - 164			
● 4 BUS			
★			



FLASHER RELAY	63467	1401789	1328548
● 4 TRUCK			
★			
● 4 BUS			
★			



SWITCH	64178	1475750	1387022
● 3 TRUCK			
★ LHD/RHD GR801 - GR/GRS/GRH900			
● 4 TRUCK			
★			
● 3 BUS			
★ GR801			
● 4 BUS			
★			



ALL THE COMPONENTS LISTED IN OUR CATALOGUE ARE NOT ORIGINAL, THOUGH PERFECTLY INTERCHANGEABLE. REFERENCE NUMBERS, EITHER ORIGINAL OR OF A DIFFERENT NATURE, ARE FOR INFORMATION PURPOSES ONLY WHEN PLACING AN ORDER, PLEASE, ALWAYS USE COSIBO REFERENCE NUMBERS AND DO NOT MENTION THE ORIGINAL REFERENCE NUMBERS OF THE TRUCK MANUFACTURERS IN THE INVOICE TO VEHICLE OWNERS OR TO ANYBODY ELSE. THE CUSTOMER TAKES HIS OWN RESPONSIBILITY IF HE DOES NOT COMPLY WITH WHAT ABOVE.

		Code	OEM new	OEM old
RELAY	● Model	63446	1543731	1407909 1439172 303535
	★ Application			
	● 3 BUS			
	★			
	● 3 TRUCK			
	★			
	● 4 BUS			
	★			
	● 4 TRUCK			
	★	94 - 114 - 124.144 - 164		
● F-K-N BUS				
★	CK/CN CNUD P700			
● P-G-R-T TRUCK				
★				



CABLE CONNECTOR M27	63593	1378882	
● 3 BUS			
★			
● 4 BUS			
★			
● IND. MARINE ENGINE 4			
★			
● IND. MARINE ENGINE 5			
★			
● 3 TRUCK			
★			
● 4 TRUCK			
★			
● P-G-R-T TRUCK			
★	2 POLE B9		



ALL THE COMPONENTS LISTED IN OUR CATALOGUE ARE NOT ORIGINAL, THOUGH PERFECTLY INTERCHANGEABLE. REFERENCE NUMBERS, EITHER ORIGINAL OR OF A DIFFERENT NATURE, ARE FOR INFORMATION PURPOSES ONLY WHEN PLACING AN ORDER, PLEASE, ALWAYS USE COSIBO REFERENCE NUMBERS AND DO NOT MENTION THE ORIGINAL REFERENCE NUMBERS OF THE TRUCK MANUFACTURERS IN THE INVOICE TO VEHICLE OWNERS OR TO ANYBODY ELSE. THE CUSTOMER TAKES HIS OWN RESPONSIBILITY IF HE DOES NOT COMPLY WITH WHAT ABOVE.

		Code	OEM new	OEM old
CABLE CONNECTOR M24	● Model	63594	1378883	1120398 1365170
	★ Application			
	● 3 BUS			
	★			
	● 4 BUS			
	★ ADR			
	● F-K-N BUS			
	★ 2 POLE			
	● IND. MARINE ENGINE 4			
	★			
	● IND. MARINE ENGINE 5			
	★ SG9 A280			
	● 3 TRUCK			
	★ ADR			
	● 4 TRUCK			
	★ ADR			
● P-G-R-T TRUCK				
★ 2 POLE				

		63598	355223	
CONNECTOR SET M24	● 3 BUS			
	★			
	● 4 BUS			
	★ ADR			
	● IND. MARINE ENGINE 4			
	★			
	● IND. MARINE ENGINE 5			
	★ SG9 A280			
	● 3 TRUCK			
	★ ADR			
	● 4 TRUCK			
	★ ADR			



ALL THE COMPONENTS LISTED IN OUR CATALOGUE ARE NOT ORIGINAL, THOUGH PERFECTLY INTERCHANGEABLE. REFERENCE NUMBERS, EITHER ORIGINAL OR OF A DIFFERENT NATURE, ARE FOR INFORMATION PURPOSES ONLY WHEN PLACING AN ORDER, PLEASE, ALWAYS USE COSIBO REFERENCE NUMBERS AND DO NOT MENTION THE ORIGINAL REFERENCE NUMBERS OF THE TRUCK MANUFACTURERS IN THE INVOICE TO VEHICLE OWNERS OR TO ANYBODY ELSE. THE CUSTOMER TAKES HIS OWN RESPONSIBILITY IF HE DOES NOT COMPLY WITH WHAT ABOVE.

OIL SENSOR



	Code	OEM new	OEM old
● Model	63847	1452862	1393113
★ Application			1488340
● 3 BUS			
★			
● IND. MARINE ENGINE 4			
★	DC9 51 A05 E		
● IND. MARINE ENGINE 5			
★	SG9 A280		
● 3 TRUCK			
★			
● 4 TRUCK			
★	DSC12 05 - EDC LHD/RHD		

PRESSURE SWITCH



	64177	1731130	
● 4 BUS			
★	K/L/N 4X2 6X2 8X2 6X2/2 6X2/4 LHD/RHD - DC19 19/20/21 PDE 4X2 6X2 6X2/4 8X2 6X2/4 LHD - L/N 6X2/2 LHD - L/N EDC 6X2/2 LHD - K/L/N EDC 4X2 6X2 6X2/4 8X2 LHD		

ALTERNATOR REGULATOR



	62249	1117253	1118188
● 3 BUS			
★	N1 28V 10/55A		
● 3 TRUCK			
★	N1 28V 10/55A		
● 4 BUS			
★	N1 28V 20/65A 1 POLE		
● 4 TRUCK			
★	N1 28V 20/65A 1 POLE		
● IND. MARINE ENGINE 4			
★	N1 28V 20/65A 1 POLE		

ALL THE COMPONENTS LISTED IN OUR CATALOGUE ARE NOT ORIGINAL, THOUGH PERFECTLY INTERCHANGEABLE. REFERENCE NUMBERS, EITHER ORIGINAL OR OF A DIFFERENT NATURE, ARE FOR INFORMATION PURPOSES ONLY WHEN PLACING AN ORDER, PLEASE, ALWAYS USE COSIBO REFERENCE NUMBERS AND DO NOT MENTION THE ORIGINAL REFERENCE NUMBERS OF THE TRUCK MANUFACTURERS IN THE INVOICE TO VEHICLE OWNERS OR TO ANYBODY ELSE. THE CUSTOMER TAKES HIS OWN RESPONSIBILITY IF HE DOES NOT COMPLY WITH WHAT ABOVE.

		Code	OEM new	OEM old
SWITCH	● Model	63051	316379	
	★ Application			
	● 3 TRUCK			
	★ TOPLINE			
	● 4 TRUCK			
★ 94 - 114 - 124 - 144 - 164				



ALL THE COMPONENTS LISTED IN OUR CATALOGUE ARE NOT ORIGINAL, THOUGH PERFECTLY INTERCHANGEABLE. REFERENCE NUMBERS, EITHER ORIGINAL OR OF A DIFFERENT NATURE, ARE FOR INFORMATION PURPOSES ONLY WHEN PLACING AN ORDER, PLEASE, ALWAYS USE COSIBO REFERENCE NUMBERS AND DO NOT MENTION THE ORIGINAL REFERENCE NUMBERS OF THE TRUCK MANUFACTURERS IN THE INVOICE TO VEHICLE OWNERS OR TO ANYBODY ELSE. THE CUSTOMER TAKES HIS OWN RESPONSIBILITY IF HE DOES NOT COMPLY WITH WHAT ABOVE.

SOLENOID SWITCH



- | Code | OEM new | OEM old |
|-------------------------------------|---------|---------|
| 63440 | 1405979 | |
| ● Model | | |
| ★ Application | | |
| ● 4 BUS | | |
| ★ D11 - D12 | | |
| ● IND. MARINE ENGINE 4 | | |
| ★ D11 - D12 - DI12 49A | | |
| ● 4 TRUCK | | |
| ★ D11 - D12 - DSC11 - DS111 - OSC11 | | |

V-BELT



- | Code | OEM new | OEM old |
|------------------|---------|---------|
| 60484 | 814210 | |
| ● 3 TRUCK | | |
| ★ DN/DS11 | | |
| ● 3 BUS | | |
| ★ | | |

V-BELT



- | Code | OEM new | OEM old |
|------------------|---------|---------|
| 61322 | 814209 | |
| ● 3 TRUCK | | |
| ★ DSC11 | | |

ALL THE COMPONENTS LISTED IN OUR CATALOGUE ARE NOT ORIGINAL, THOUGH PERFECTLY INTERCHANGEABLE. REFERENCE NUMBERS, EITHER ORIGINAL OR OF A DIFFERENT NATURE, ARE FOR INFORMATION PURPOSES ONLY WHEN PLACING AN ORDER, PLEASE, ALWAYS USE COSIBO REFERENCE NUMBERS AND DO NOT MENTION THE ORIGINAL REFERENCE NUMBERS OF THE TRUCK MANUFACTURERS IN THE INVOICE TO VEHICLE OWNERS OR TO ANYBODY ELSE. THE CUSTOMER TAKES HIS OWN RESPONSIBILITY IF HE DOES NOT COMPLY WITH WHAT ABOVE.

BELT L=1225 mm



● Model
★ Application

Code

OEM new

OEM old

64187

814195

● 3 BUS

★

● IND. MARINE ENGINE 4

★ D14 A/M 65A

ALL THE COMPONENTS LISTED IN OUR CATALOGUE ARE NOT ORIGINAL, THOUGH PERFECTLY INTERCHANGEABLE. REFERENCE NUMBERS, EITHER ORIGINAL OR OF A DIFFERENT NATURE, ARE FOR INFORMATION PURPOSES ONLY WHEN PLACING AN ORDER, PLEASE, ALWAYS USE COSIBO REFERENCE NUMBERS AND DO NOT MENTION THE ORIGINAL REFERENCE NUMBERS OF THE TRUCK MANUFACTURERS IN THE INVOICE TO VEHICLE OWNERS OR TO ANYBODY ELSE. THE CUSTOMER TAKES HIS OWN RESPONSIBILITY IF HE DOES NOT COMPLY WITH WHAT ABOVE.

SOLENOID VALVE



	Code	OEM new	OEM old
● Model	65191	1536304	1340231
★ Application			1421322
● 4 BUS			
★			
● 3 TRUCK			
★	T113 LHD - R113 LHD - T143 LHD - R143 LHD GRH880		

SWITCH



	Code	OEM new	OEM old
	63677	1472739	1420005
● 4 BUS			
★	GR/GR801R WITH OPTICRUISE		
● 4 TRUCK			
★	GRS890R - GRS/GRSH/GRS0900R - GRS920R - GT/GTD 800/900/901 - GR/GR801R		

SWITCH



	Code	OEM new	OEM old
	63055	1303471	370710
● 4 BUS			
★	GRS900CAG - G700/701		
● 4 TRUCK			
★	GR/GRS/GRH900		

SWITCH



	Code	OEM new	OEM old
	64304	1472738	
● 4 BUS			
★	CH 3527596 DIFF. LOCK		
● 4 TRUCK			
★	R780 8X8 - 4X4 4X4 6X2A/B/Z 6X2/4 6X6 6X4 8X2/6A/B 8X2A/Z 8X4A/B/Z 8X4/4A/B		

ALL THE COMPONENTS LISTED IN OUR CATALOGUE ARE NOT ORIGINAL, THOUGH PERFECTLY INTERCHANGEABLE. REFERENCE NUMBERS, EITHER ORIGINAL OR OF A DIFFERENT NATURE, ARE FOR INFORMATION PURPOSES ONLY WHEN PLACING AN ORDER, PLEASE, ALWAYS USE COSIBO REFERENCE NUMBERS AND DO NOT MENTION THE ORIGINAL REFERENCE NUMBERS OF THE TRUCK MANUFACTURERS IN THE INVOICE TO VEHICLE OWNERS OR TO ANYBODY ELSE. THE CUSTOMER TAKES HIS OWN RESPONSIBILITY IF HE DOES NOT COMPLY WITH WHAT ABOVE.

ACCELERATOR PEDAL COMPLETE



● Model

★ Application

Code

OEM new

OEM old

64119

64119

● 3 TRUCK

★

T93 LHD - R93 LHD - G93/P93 LHD/RHD - T113 LHD - P113 LHD/RHD - P113 HK6X4L EK6X4L - T143 LHD EDC - R143 LHD/RHD - P113 ML/HL 4X2 6X2 LHD GA850/GA850R - R143 LHD CR19 6X4 - P93 ML/MV/HL 4X2/6X2 LHD GA750/GA850R - R143 LHD 8X4 CR13 6X4 - R143 EK8X4L - P113 HK4X4L HK6X4L HK6X6L EK6X4L - R93 HK6X4L - R113 LHD/RHD - P113 HK4X4R HK6X6R MK8X4R - R143 LHD CR13/19 - P93 RHD EK330/340 - P93 RHD MV/ML/HL 4X2 6X2 GA776 - GA750/GA750R - R143 6X2/4 8X2 8X4 LHD - R143 4X2 6X2 6X4 LHD CR13/19 - R113 HK6X4L EK6X4L - R113 HK8X4L MK8X4L EK8X4L - P113 HK8X4L MK8X4L EK8X4L - R143 6X2/4 RHD - P113 DSC LHD - R143 LHD EDC - R113 DSC LHD - R113 EDC DTC - R113 8X2 8X4 LHD - R93 HK6X4L - P93 LHD/RHD GA776 - P93 ML/HL 4X2 6X2 LHD GA750

ACCELERATOR PEDAL



64132

390684

● 3 TRUCK

★

T93 LHD - R93 LHD - G93/P93 LHD/RHD - T113 LHD - P113 LHD/RHD - P113 HK6X4L EK6X4L - T143 LHD EDC - R143 LHD/RHD - P113 ML/HL 4X2 6X2 LHD GA850/GA850R - R143 LHD CR19 6X4 - P93 ML/MV/HL 4X2/6X2 LHD GA750/GA850R - R143 LHD 8X4 CR13 6X4 - R143 EK8X4L - P113 HK4X4L HK6X4L HK6X6L EK6X4L - R93 HK6X4L - R113 LHD/RHD - P113 HK4X4R HK6X6R MK8X4R - R143 LHD CR13/19 - P93 RHD EK330/340 - P93 RHD MV/ML/HL 4X2 6X2 GA776 - GA750/GA750R - R143 6X2/4 8X2 8X4 LHD - R143 4X2 6X2 6X4 LHD CR13/19 - R113 HK6X4L EK6X4L - R113 HK8X4L MK8X4L EK8X4L - P113 HK8X4L MK8X4L EK8X4L - R143 6X2/4 RHD - P113 DSC LHD - R143 LHD EDC - R113 DSC LHD - R113 EDC DTC - R113 8X2 8X4 LHD - R93 HK6X4L - P93 LHD/RHD GA776 - P93 ML/HL 4X2 6X2 LHD GA750

ACCELERATOR PEDAL BUSHING



60196

289445

● 3 TRUCK

★

● 3 BUS

★

● 4 BUS

★

F94H LHD/RHD - K114/124

		Code	OEM new	OEM old
BUSHING	● Model	64182	813245	
	★ Application			
	● 3 BUS			
	★			
	● 3 TRUCK			
	★ G/P/T 93 - P/T 113 - R/T 143			
	● 4 BUS			
	★ F94 H			
	● 4 TRUCK			
	★ P/R DSC11 74/75/79 - T114 - P OSC11 G03 - P94 N FRONTLINE - P/R94			



	Code	OEM new	OEM old
CLAMP D.6	64082	813933	
<ul style="list-style-type: none"> ● Model ★ Application 			
<ul style="list-style-type: none"> ● 3 TRUCK ★ 			
<ul style="list-style-type: none"> ● 4 TRUCK ★ 			
<ul style="list-style-type: none"> ● P-G-R-T TRUCK ★ 			
<ul style="list-style-type: none"> ● 3 BUS ★ 			
<ul style="list-style-type: none"> ● IND. MARINE ENGINE 4 ★ 			



CLAMP D.10	64083	813935	
<ul style="list-style-type: none"> ● 3 BUS ★ 			



CLAMP D.16	64084	813937	
<ul style="list-style-type: none"> ● 3 TRUCK ★ 			
<ul style="list-style-type: none"> ● 4 TRUCK ★ 			
<ul style="list-style-type: none"> ● P-G-R-T TRUCK ★ 			
<ul style="list-style-type: none"> ● 3 BUS ★ 			
<ul style="list-style-type: none"> ● 4 BUS ★ 			
<ul style="list-style-type: none"> ● IND. MARINE ENGINE 4 ★ 			



ALL THE COMPONENTS LISTED IN OUR CATALOGUE ARE NOT ORIGINAL, THOUGH PERFECTLY INTERCHANGEABLE. REFERENCE NUMBERS, EITHER ORIGINAL OR OF A DIFFERENT NATURE, ARE FOR INFORMATION PURPOSES ONLY WHEN PLACING AN ORDER, PLEASE, ALWAYS USE COSIBO REFERENCE NUMBERS AND DO NOT MENTION THE ORIGINAL REFERENCE NUMBERS OF THE TRUCK MANUFACTURERS IN THE INVOICE TO VEHICLE OWNERS OR TO ANYBODY ELSE. THE CUSTOMER TAKES HIS OWN RESPONSIBILITY IF HE DOES NOT COMPLY WITH WHAT ABOVE.

	Code	OEM new	OEM old
CLAMP D.20	64085	813939	
	<ul style="list-style-type: none"> ● Model ★ Application 		
	<ul style="list-style-type: none"> ● 3 TRUCK ★ 		
	<ul style="list-style-type: none"> ● P-G-R-T TRUCK ★ 		
	<ul style="list-style-type: none"> ● 4 BUS ★ 		
	<ul style="list-style-type: none"> ● IND. MARINE ENGINE 4 ★ 		
	<ul style="list-style-type: none"> ● F-K-N BUS ★ 		

CLAMP D.25	64086	813941	
	<ul style="list-style-type: none"> ● 3 TRUCK ★ 		
	<ul style="list-style-type: none"> ● P-G-R-T TRUCK ★ 		
	<ul style="list-style-type: none"> ● 3 BUS ★ 		

CLAMP D.5	64089	813932	
	<ul style="list-style-type: none"> ● 3 TRUCK ★ 		



ALL THE COMPONENTS LISTED IN OUR CATALOGUE ARE NOT ORIGINAL, THOUGH PERFECTLY INTERCHANGEABLE. REFERENCE NUMBERS, EITHER ORIGINAL OR OF A DIFFERENT NATURE, ARE FOR INFORMATION PURPOSES ONLY WHEN PLACING AN ORDER, PLEASE, ALWAYS USE COSIBO REFERENCE NUMBERS AND DO NOT MENTION THE ORIGINAL REFERENCE NUMBERS OF THE TRUCK MANUFACTURERS IN THE INVOICE TO VEHICLE OWNERS OR TO ANYBODY ELSE. THE CUSTOMER TAKES HIS OWN RESPONSIBILITY IF HE DOES NOT COMPLY WITH WHAT ABOVE.

	Code	OEM new	OEM old
CLAMP D.8	64090	813934	
	<ul style="list-style-type: none"> ● Model ★ Application 		
	<ul style="list-style-type: none"> ● 3 TRUCK ★ 		
	<ul style="list-style-type: none"> ● 4 BUS ★ 		

CLAMP D.13	64091	813936	
	<ul style="list-style-type: none"> ● 3 TRUCK ★ 		
	<ul style="list-style-type: none"> ● 4 TRUCK ★ 		
	<ul style="list-style-type: none"> ● 3 BUS ★ 		
	<ul style="list-style-type: none"> ● IND. MARINE ENGINE 4 ★ 		

CLAMP D.18	64092	813938	
	<ul style="list-style-type: none"> ● 4 TRUCK ★ 		
	<ul style="list-style-type: none"> ● 3 BUS ★ 		
	<ul style="list-style-type: none"> ● IND. MARINE ENGINE 4 ★ 		

ALL THE COMPONENTS LISTED IN OUR CATALOGUE ARE NOT ORIGINAL, THOUGH PERFECTLY INTERCHANGEABLE. REFERENCE NUMBERS, EITHER ORIGINAL OR OF A DIFFERENT NATURE, ARE FOR INFORMATION PURPOSES ONLY WHEN PLACING AN ORDER, PLEASE, ALWAYS USE COSIBO REFERENCE NUMBERS AND DO NOT MENTION THE ORIGINAL REFERENCE NUMBERS OF THE TRUCK MANUFACTURERS IN THE INVOICE TO VEHICLE OWNERS OR TO ANYBODY ELSE. THE CUSTOMER TAKES HIS OWN RESPONSIBILITY IF HE DOES NOT COMPLY WITH WHAT ABOVE.

	Code	OEM new	OEM old
<p>CLAMP D.22</p> 	64093	813940	
<ul style="list-style-type: none"> ● Model ★ Application 			
<ul style="list-style-type: none"> ● 3 TRUCK ★ 			
<ul style="list-style-type: none"> ● 4 TRUCK ★ 			
<ul style="list-style-type: none"> ● 4 BUS ★ 			
<ul style="list-style-type: none"> ● F-K-N BUS ★ 			
<p>CLAMP D.45</p> 	64094	813942	
<ul style="list-style-type: none"> ● 3 TRUCK ★ 			
<ul style="list-style-type: none"> ● 3 BUS ★ 			
<p>CLAMP D.28</p> 	64095	804578	
<ul style="list-style-type: none"> ● 3 TRUCK ★ 			
<ul style="list-style-type: none"> ● P-G-R-T TRUCK ★ 			
<ul style="list-style-type: none"> ● 4 BUS ★ 			
<ul style="list-style-type: none"> ● IND. MARINE ENGINE 4 ★ 			
<ul style="list-style-type: none"> ● F-K-N BUS ★ 			

ALL THE COMPONENTS LISTED IN OUR CATALOGUE ARE NOT ORIGINAL, THOUGH PERFECTLY INTERCHANGEABLE. REFERENCE NUMBERS, EITHER ORIGINAL OR OF A DIFFERENT NATURE, ARE FOR INFORMATION PURPOSES ONLY WHEN PLACING AN ORDER, PLEASE, ALWAYS USE COSIBO REFERENCE NUMBERS AND DO NOT MENTION THE ORIGINAL REFERENCE NUMBERS OF THE TRUCK MANUFACTURERS IN THE INVOICE TO VEHICLE OWNERS OR TO ANYBODY ELSE. THE CUSTOMER TAKES HIS OWN RESPONSIBILITY IF HE DOES NOT COMPLY WITH WHAT ABOVE.

	Code	OEM new	OEM old
CLAMP D.32	64100	804583	
<ul style="list-style-type: none"> ● Model ★ Application 			
<ul style="list-style-type: none"> ● 3 TRUCK ★ 			
<ul style="list-style-type: none"> ● 3 BUS ★ 			
<ul style="list-style-type: none"> ● 4 BUS ★ 			
<ul style="list-style-type: none"> ● IND. MARINE ENGINE 4 ★ 			



CLAMP D.38	64101	804591	
<ul style="list-style-type: none"> ● 3 BUS ★ 			



RUBBER BUSHING	64112	1350440	
<ul style="list-style-type: none"> ● 4 TRUCK ★ 			
<ul style="list-style-type: none"> ● P-G-R-T TRUCK ★ 			



RUBBER BUSHING	64113	1350441	
<ul style="list-style-type: none"> ● 4 TRUCK ★ 			
<ul style="list-style-type: none"> ● P-G-R-T TRUCK ★ 			



ALL THE COMPONENTS LISTED IN OUR CATALOGUE ARE NOT ORIGINAL, THOUGH PERFECTLY INTERCHANGEABLE. REFERENCE NUMBERS, EITHER ORIGINAL OR OF A DIFFERENT NATURE, ARE FOR INFORMATION PURPOSES ONLY WHEN PLACING AN ORDER, PLEASE, ALWAYS USE COSIBO REFERENCE NUMBERS AND DO NOT MENTION THE ORIGINAL REFERENCE NUMBERS OF THE TRUCK MANUFACTURERS IN THE INVOICE TO VEHICLE OWNERS OR TO ANYBODY ELSE. THE CUSTOMER TAKES HIS OWN RESPONSIBILITY IF HE DOES NOT COMPLY WITH WHAT ABOVE.

STARTER CABLE



	Code	OEM new	OEM old
● Model	60416	250318	
★ Application			
● 3 TRUCK			
★ P/R 113 LHD/RHD - P/R 113 6X2/4 RHD			

STOP CABLE



	Code	OEM new	OEM old
	60418	1343156	1343155 365161 365184
● 3 TRUCK			
★ G/P/R 93 - R143 - R143 6X2/4 RHD			

ACCELERATOR CABLE



	Code	OEM new	OEM old
	60420	1105971	1112015
● 3 TRUCK			
★ R143 LHD 8X4 CR13 6X4 - R143 4X2 6X2 6X4 LHD CR13/19 - R143 6X2/4 8X2 8X4 LHD			

ALL THE COMPONENTS LISTED IN OUR CATALOGUE ARE NOT ORIGINAL, THOUGH PERFECTLY INTERCHANGEABLE. REFERENCE NUMBERS, EITHER ORIGINAL OR OF A DIFFERENT NATURE, ARE FOR INFORMATION PURPOSES ONLY WHEN PLACING AN ORDER, PLEASE, ALWAYS USE COSIBO REFERENCE NUMBERS AND DO NOT MENTION THE ORIGINAL REFERENCE NUMBERS OF THE TRUCK MANUFACTURERS IN THE INVOICE TO VEHICLE OWNERS OR TO ANYBODY ELSE. THE CUSTOMER TAKES HIS OWN RESPONSIBILITY IF HE DOES NOT COMPLY WITH WHAT ABOVE.

STOP CABLE



- Model
- ★ Application

Code	OEM new	OEM old
63930	365162	1331139 312354 365160

- **3 BUS**

- ★ LHD/RHD

- **3 TRUCK**

- ★ LHD - CAG G770 GR871/880 GS771/772 GRS900 - P/R113 6X2/4 RHD

Cross reference COSIBO - SCANIA

COSIBO	Replacing	Page	COSIBO	Replacing	Page	COSIBO	Replacing	Page	COSIBO	Replacing	Page
60002	373472	A.3.1	60319	258410	A.29.2	60438	1348117	J.9.1	60573	551456	A.4.1
60003	1403587	A.3.1	60320	258411	A.29.2	60455	1117285	A.14.11	60575	551516	A.5.1
60005	159496	G.2.6	60321	258412	A.29.2	60479	1363634	A.21.3	60576	551470	A.5.1
60010	352211	A.1.1	60322	168778	A.29.2	60481	1923654	J.8.14	60580	306902	L.2.7
60014	1397521	A.1.2	60323	168781	A.29.3	60481/1	1349805/1	J.8.14	60584	1869993	A.16.5
60015	315060	C.3.3	60324	168782	A.29.3	60482	1394544	J.8.3	60587	551469	A.4.1
60016	319110	A.7.12	60325	258686	A.29.4	60482/T	1377562	J.8.7	60589	1388681	A.11.1
60017	1523410	A.1.5	60326	258687	A.29.5	60484	814210	A.23.5	60591	1891445	A.2.2
60018	1521209	A.1.6	60327	258688	A.29.5	60484	814210	N.31.1	60597	306278	B.1.7
60023	1412265	N.1.9	60328	258689	A.29.5	60488	1349810	J.8.14	60629	342988	A.25.1
60023	1412265	N.3.2	60329	258690	A.29.5	60490	1385170	J.8.7	60630	1372444	A.30.1
60047	284843	C.4.2	60330	258691	A.29.6	60492	1380819	N.3.3	60631	1913503	J.5.3
60058	385998	A.13.1	60331	169316	A.29.3	60496	297568	N.3.1	60631/1	1420197/1	J.5.3
60059	385997	A.13.1	60332	169317	A.29.3	60500	1504609	N.3.3	60632	1763776	A.29.1
60060	1510490	A.26.1	60333	169318	A.29.3	60501	1504608	N.3.3	60633	1508533	A.26.1
60073	250996	A.13.21	60334	169319	A.29.4	60505	550195	A.17.1	60634	1508534	A.26.2
60101	1471237	A.2.1	60335	169320	A.29.4	60506	1382113	A.17.1	60635	197800	A.5.4
60102	353843	A.2.3	60336	169321	A.29.4	60511	1385410	N.2.1	60635	197800	C.8.3
60109	393151	A.2.1	60340	1357600	I.54.1	60512	1387155	N.2.1	60635	197800	F.2.5
60111	1369981	A.7.12	60341	1357599	I.54.1	60517	1358175	N.30.1	60636	332119	A.14.9
60112	154621	A.7.13	60343	1338128	A.33.1	60521	1738380	E.2.1	60636	332119	H.14.1
60113	225931	A.7.13	60346	1361983	A.33.3	60521	1738380	F.5.1	60636	332119	J.6.1
60114	225353	A.7.14	60347	357402	A.33.3	60521	1738380	M.2.3	60636	332119	M.5.2
60115	225354	A.7.14	60359	1894478	A.21.16	60522	1358793	E.2.2	60653	308604	A.21.5
60116	238777	A.7.15	60361	1804064	J.1.8	60522	1358793	F.5.1	60654	273793	A.21.6
60127	323790	A.10.4	60362	551370	A.5.1	60522	1358793	M.2.3	60657	1105079	A.29.15
60127	323790	H.5.1	60367	1869988	A.16.5	60535	154261	H.40.2	60658	1105080	A.29.15
60129	1800538	A.23.5	60375	1413047	C.2.3	60536	154262	H.40.1	60659	1105081	A.29.16
60140	309885	A.18.1	60391	263161	A.7.15	60538	182930	H.40.4	60660	1105082	A.29.16
60141	364833	A.18.1	60398	40607	A.33.9	60539	141164	H.40.4	60661	1105083	A.29.16
60142	146526	C.9.1	60405	332738	A.18.1	60540	141163	H.40.1	60662	1105084	A.29.16
60155	1522377	B.1.1	60405	332738	C.9.1	60543	804782	H.40.4	60663	1105073	A.29.17
60196	289445	O.1.1	60407	242299	A.7.15	60546	123102	H.40.5	60664	1105074	A.29.17
60206	1388678	A.8.1	60408	242297	A.7.16	60547	289336	H.12.3	60665	1105075	A.29.17
60207	384464	A.4.3	60409	242298	A.7.16	60547/1	134494	H.12.4	60666	1105076	A.29.17
60237	1879537	D.2.1	60413	1112542	H.4.1	60549	180064	H.40.5	60667	1105077	A.29.18
60238	1797424	D.2.1	60415	1116635	A.7.7	60554	283642	L.2.14	60668	1105078	A.29.18
60239	1797425	D.2.2	60416	250318	O.2.6	60556	1387983	A.33.5	60669	381918	A.29.18
60249	338706	C.4.2	60418	1343156	O.2.6	60561	258459	A.8.1	60670	381919	A.29.18
60252	362385	L.2.13	60420	1105971	O.2.6	60564	357363	A.16.1	60671	381920	A.29.18
60279	1539231	G.2.1	60426	550453	B.1.4	60565	1384552	A.16.1	60672	381921	A.29.19
60299	193136	G.2.2	60432	1428892	A.33.5	60566	139616	A.13.2	60673	381922	A.29.19
60301	264310	G.2.2	60434	1768402	C.1.1	60567	1388682	A.10.1	60674	381923	A.29.19
60302	264311	G.2.2	60434	1301696	F.2.1	60568	371503	A.13.7	60675	381924	A.29.19
60304	1488083	C.2.1	60435	1496288	A.18.2	60569	1459004	A.13.8	60676	381925	A.29.19
60305	550732	E.1.1	60436	1438902	H.4.1	60570	551438	A.13.7	60677	365485	A.29.13

ALL THE COMPONENTS LISTED IN OUR CATALOGUE ARE NOT ORIGINAL, THOUGH PERFECTLY INTERCHANGEABLE. REFERENCE NUMBERS, EITHER ORIGINAL OR OF A DIFFERENT NATURE, ARE FOR INFORMATION PURPOSES ONLY WHEN PLACING AN ORDER, PLEASE, ALWAYS USE COSIBO REFERENCE NUMBERS AND DO NOT MENTION THE ORIGINAL REFERENCE NUMBERS OF THE TRUCK MANUFACTURERS IN THE INVOICE TO VEHICLE OWNERS OR TO ANYBODY ELSE. THE CUSTOMER TAKES HIS OWN RESPONSIBILITY IF HE DOES NOT COMPLY WITH WHAT ABOVE.

Cross reference COSIBO - SCANIA

COSIBO	Replacing	Page	COSIBO	Replacing	Page	COSIBO	Replacing	Page	COSIBO	Replacing	Page
60678	365486	A.29.13	60794	342832	B.2.2	60971	551449	A.5.2	61197	375087	G.2.12
60679	365487	A.29.14	60795	342833	B.2.2	60972	551484	A.4.2	61198	315022	C.5.1
60680	365489	A.29.14	60798	397956	B.2.2	60973	1392930	A.16.2	61199	1100867	A.5.9
60681	365490	A.29.14	60799	550446	B.1.2	60974	304309	B.2.3	61204	1433641	A.13.28
60682	365491	A.29.15	60807	360719	B.1.1	60975	362778	B.2.3	61205	165286	A.13.29
60683	305286	A.29.6	60808	1747895	B.1.1	60985	1897335	E.2.1	61206	362257	A.14.7
60684	305287	A.29.6	60810	1336159	B.1.4	60986	1749034	G.2.13	61207	371453	C.7.3
60685	305288	A.29.6	60836	1525988	C.4.2	60993	1409890	G.2.8	61208	1437727	C.7.3
60686	305289	A.29.6	60836	1525988	D.1.3	60994	1765061	G.2.9	61209	350270	C.7.1
60687	320813	A.29.7	60836	1525988	E.2.5	60998	1109871	A.22.6	61212	346627	A.27.1
60688	320814	A.29.7	60836	1525988	F.2.3	60999	170761	A.22.7	61212	346627	C.8.1
60689	348293	A.29.7	60836	1525988	H.6.7	61000	259065	A.26.2	61212	346627	J.5.1
60690	348294	A.29.7	60838	550730	E.1.2	61002	1314406	A.26.3	61213	354967	A.27.2
60692	263911	A.29.7	60845	550722	E.1.1	61005	1375837	A.26.1	61214	315270	C.5.1
60693	263912	A.29.8	60849	550731	E.1.1	61007	392309	G.2.9	61215	194414	C.5.1
60694	271147	A.29.8	60859	310979	E.2.4	61007/1	392309	G.2.10	61218	252497	L.7.1
60695	271148	A.29.8	60860	310980	E.2.4	61010	214008	F.2.4	61219	369478	A.10.2
60696	308385	A.29.8	60861	1337366	E.2.3	61017	370075	G.2.12	61220	213604	L.2.6
60697	308386	A.29.8	60862	1337367	E.2.3	61020	370074	G.2.7	61222	390358	J.8.2
60698	263917	A.29.9	60866	1754546	L.7.3	61023	1109870	A.10.2	61223	390359	J.8.2
60699	263918	A.29.9	60867	204728	L.7.6	61025	388528	C.3.4	61226	329583	J.8.6
60700	369291	A.29.12	60893	1313326	H.3.1	61026	338643	A.11.4	61227	1343178	L.7.1
60701	369292	A.29.12	60894	1313325	H.3.1	61026	338643	C.3.4	61230	1392935	A.10.1
60702	369293	A.29.12	60895	550539	C.1.6	61077	393950	A.21.4	61232	309065	A.21.5
60703	369295	A.29.12	60897	550520	C.1.3	61109	1122620	A.2.4	61233	211813	A.14.3
60704	369296	A.29.13	60900	550527	C.1.4	61119	1768898	M.2.1	61237	378299	A.8.2
60705	369297	A.29.13	60907	1384897	C.7.2	61120	211005	A.28.1	61240	242300	A.7.16
60706	312217	A.29.10	60908	1384898	C.7.3	61121	192882	A.28.4	61257	1448114	H.13.6
60707	312218	A.29.10	60909	275460	L.2.13	61137	365015	J.3.3	61259	218832	H.13.6
60708	312219	A.29.11	60912	1377728	L.2.13	61147	550044	A.26.5	61260	218831	H.13.6
60709	312221	A.29.11	60913	355147	L.2.15	61152	1362721	H.13.13	61265	309422	H.13.7
60710	312222	A.29.11	60914	355145	L.2.14	61153	1338019	H.13.13	61266	309421	H.13.7
60711	312223	A.29.11	60916	128680	L.2.15	61163	1448110	H.13.4	61297	1740992	G.2.6
60712	322693	A.29.9	60917	135036	L.2.16	61166	1448111	H.13.5	61303	228483	L.2.6
60713	322694	A.29.9	60918	182929	L.2.17	61167	1448112	H.13.5	61305	1477867	L.2.7
60714	322695	A.29.9	60919	182931	L.2.17	61168	1448113	H.13.8	61306	213606	L.2.9
60715	322697	A.29.10	60920	355148	L.2.16	61169	1448115	H.13.5	61307	213607	L.2.10
60716	322698	A.29.10	60921	135698	L.2.16	61174	1377571	A.26.3	61313	1548054	L.2.3
60717	322699	A.29.10	60922	303520	J.5.2	61180	551476	A.26.6	61314	811911	L.2.10
60718	371781	A.28.3	60955	154259	H.40.2	61183	550167	A.26.6	61315	272449	L.2.5
60720	392204	A.31.1	60957	1302857	H.13.12	61186	550206	A.26.6	61317	366006	N.3.2
60721	318523	A.31.1	60958	120828	H.13.1	61187	1522013	A.7.7	61319	237884	L.2.19
60754	1384624	C.7.1	60961	153287	L.2.4	61193	1769799	A.14.1	61322	814209	A.23.5
60758	551365	A.13.9	60962	241922	L.2.4	61194	1769798	A.14.2	61322	814209	N.31.1
60789	1367604	B.2.3	60969	1392931	A.16.1	61195	159656	H.8.3	61323	142575	H.13.12
60790	1797431	B.2.4	60970	1403258	A.3.2	61196	375086	G.2.7	61324	1514505	J.8.10

ALL THE COMPONENTS LISTED IN OUR CATALOGUE ARE NOT ORIGINAL, THOUGH PERFECTLY INTERCHANGEABLE. REFERENCE NUMBERS, EITHER ORIGINAL OR OF A DIFFERENT NATURE, ARE FOR INFORMATION PURPOSES ONLY WHEN PLACING AN ORDER, PLEASE, ALWAYS USE COSIBO REFERENCE NUMBERS AND DO NOT MENTION THE ORIGINAL REFERENCE NUMBERS OF THE TRUCK MANUFACTURERS IN THE INVOICE TO VEHICLE OWNERS OR TO ANYBODY ELSE. THE CUSTOMER TAKES HIS OWN RESPONSIBILITY IF HE DOES NOT COMPLY WITH WHAT ABOVE.

Cross reference COSIBO - SCANIA

COSIBO	Replacing	Page	COSIBO	Replacing	Page	COSIBO	Replacing	Page	COSIBO	Replacing	Page
61325	280651	H.13.2	61509	204727	L.7.5	61654	370875	M.2.5	61808	142729	J.5.1
61333	244090	C.6.1	61510	204719	L.7.6	61656	390784	M.2.5	61829	551519	A.5.2
61335	280652	H.13.2	61511	204722	L.7.6	61657	1106953	I.7.1	61830	1376280	H.5.4
61341	194838	B.2.1	61519	1309465	H.40.3	61658	1106955	I.7.2	61831	1376279	H.5.5
61341	194838	C.1.1	61529	1112539+	H.4.3	61659	296538	I.7.2	61832	551450	A.13.9
61344	1120884	B.1.5		1112540		61660	296538/A	I.7.2	61833	550343	A.13.9
61346	374338	A.12.1	61530	1342121	H.3.1	61661	1365968	N.2.2	61834	1305959	A.8.2
61348	1344182	A.21.7	61531	1103635	H.3.2	61662	1365969	N.2.2	61835	378264	A.13.4
61348	1757877	D.2.3	61536	1332503	A.12.1	61663	1371292	N.2.3	61836	1109288	A.13.4
61348	1757877	F.2.6	61536	1332503	H.4.1	61664	1371293	N.2.3	61837	1302827	A.7.2
61350	1120881	B.1.6	61537	15323	A.13.22	61703	297394	A.21.15	61838	1801737	A.13.5
61352	808214	B.1.6	61538	276087	A.13.21	61703	297394	C.8.2	61842	1392932	A.9.1
61363	336979	I.48.5	61548	1122696	A.32.1	61704	312646	A.21.11	61844	1384551	A.9.1
61366	1535698	B.2.6	61549	278665	M.2.1	61706	316640	I.7.3	61846	351197	A.24.3
61366	1535698	C.8.3	61550	1377799	L.2.2	61707	1545478	A.13.25	61849	156938	G.2.13
61368	1435859	J.9.3	61552	1412666	A.13.8	61708	288649	H.8.1	61850	272400	L.1.1
61371	235434	C.3.4	61553	1320292	A.13.3	61710	1372510	J.8.16	61851	1907845	G.2.10
61371	235434	F.1.2	61554	388402	A.13.7	61716	1378226	A.8.2	61852	1391386	H.5.4
61460	1370254	A.7.17	61560	551512	A.4.1	61728	1306975	I.48.6	61856	1386452	B.2.5
61461	1888025	A.7.17	61585	1116698	F.2.7	61729	1306976	I.48.6	61858	1367370	L.2.12
61463	1381926	A.21.10	61586	1116848	F.2.6	61731	285248	A.5.11	61859	1362710	L.2.12
61473	1361193	A.1.1	61587	1116699	F.2.7	61731	285248	J.8.12	61864	318350	A.27.1
61475	1361196	A.1.1	61602	301843	I.56.1	61734	339188	L.2.8	61865	353628	N.30.3
61476	1801529	A.1.4	61604	369375	I.30.6	61743	385266	J.8.3	61866	1321259	B.2.9
61477	1360833	A.1.5	61606	1406613	I.48.5	61745	1478450	A.32.1	61869	1340201	A.27.2
61482	366547	A.16.4	61607	1366849	I.48.7	61746	1303951	A.29.20	61878	1374083	H.5.2
61483	1746684	A.16.2	61608	1422701	H.14.1	61747	1303952	A.29.20	61879	1350817	H.13.11
61484	369276	A.13.3	61621	353592	J.4.1	61748	1303953	A.29.20	61902	1769800	A.14.3
61485	387775	A.13.1	61622	1852817	H.13.3	61749	1303954	A.29.20	61903	1118884	J.8.15
61486	364792	A.13.2	61624	234387	C.2.4	61750	1303955	A.29.20	61906	1856108	H.13.4
61487	364791	A.13.3	61627	367761	A.21.2	61751	1303956	A.29.21	61907	1383858	I.54.6
61490	365863	A.13.2	61628	393107	C.7.9	61752	1303957	A.29.21	61908	1349045	A.13.16
61490/1	222499	A.13.2	61629	393108	C.7.9	61753	1303958	A.29.21	61908	1349045	H.2.1
61491	170948	A.13.20	61630	323662	A.7.1	61759	1368736	A.7.11	61909	1402400	A.7.18
61492	170955	A.13.20	61631	1302828	A.7.1	61761	273022	G.2.5	61911	301844	I.56.1
61493	1120880	B.1.6	61632	1312934	A.7.2	61762	1388684	A.7.5	61916	1323823	A.7.18
61496	244780	C.2.7	61632	1312934	B.3.2	61764	1103619	B.2.1	61917	180435	A.13.27
61498	550534	C.1.5	61632	1312934	H.6.5	61764	1103619	C.3.2	61921	1384554	A.16.2
61501	204750	L.7.1	61640	1116847	F.2.4	61770/S	365488	A.29.25	61922	1384555	A.16.3
61502	204723	L.7.2	61643	1309563	C.6.4	61771/S	365484	A.29.25	61923	1304571	M.2.1
61503	204737	L.7.2	61644	336980	I.48.5	61790	1542159	H.5.3	61924	352635	M.2.1
61504	204735	L.7.2	61645	367326	N.30.1	61793	298823	A.27.2	61933	1308643	M.2.1
61505	204736	L.7.2	61648	1386423	J.8.16	61793	298823	C.8.1	61936	1375493	A.28.3
61506	1118446	L.7.3	61650	273023	G.2.5	61798	303643	A.27.1	61946	390533	F.1.1
61507	204746	L.7.3	61651	1327413	G.2.3	61799	223315	A.27.2	61953	1303472	C.2.4
61508	368033	L.7.4	61652	1879541	D.2.2	61808	142729	A.27.1	61953	1303472	F.4.1

ALL THE COMPONENTS LISTED IN OUR CATALOGUE ARE NOT ORIGINAL, THOUGH PERFECTLY INTERCHANGEABLE. REFERENCE NUMBERS, EITHER ORIGINAL OR OF A DIFFERENT NATURE, ARE FOR INFORMATION PURPOSES ONLY. WHEN PLACING AN ORDER, PLEASE, ALWAYS USE COSIBO REFERENCE NUMBERS AND DO NOT MENTION THE ORIGINAL REFERENCE NUMBERS OF THE TRUCK MANUFACTURERS IN THE INVOICE TO VEHICLE OWNERS OR TO ANYBODY ELSE. THE CUSTOMER TAKES HIS OWN RESPONSIBILITY IF HE DOES NOT COMPLY WITH WHAT ABOVE.

Cross reference COSIBO - SCANIA

COSIBO	Replacing	Page	COSIBO	Replacing	Page	COSIBO	Replacing	Page	COSIBO	Replacing	Page
61955	1427670	A.28.5	62133	316918	I.7.1	62262	1529071	N.1.3	62327	1390075	I.30.1
61959	391555	A.21.3	62136	316920	I.7.1	62264	1514093	I.51.4	62328	1354593	I.30.1
61961	1361136	B.1.3	62138	389500	M.1.2	62266	1424227	J.9.1	62334	1105803	J.1.4
61964	1313592	I.54.2	62145	1356668	J.8.5	62267	1435856	J.9.1	62335	361993	I.30.4
61965	1313594	I.54.3	62195	1406614	I.48.6	62269	1379384	N.3.4	62336	1497013	A.33.1
61966	1395276	I.54.6	62208	376116	I.48.2	62270	394768	N.2.2	62338	1354594	I.30.1
61969	1317538	I.50.3	62211	1382827	J.9.2	62271	394769	N.2.2	62339	1390074	I.30.1
61971	1397570	I.50.1	62214	295297	A.5.12	62274	1795583	A.21.7	62340	361994	I.30.4
61972	392099	I.54.3	62215	338395	A.5.12	62274	1795583	J.8.11	62341	1326935	I.56.3
61973	392100	I.54.3	62216	352543	A.5.12	62275	1366384	I.50.2	62342	1536307	J.6.1
61974	1302771	I.54.4	62217	1307953	A.5.13	62276	1363131	J.3.2	62342	1536307	L.6.2
61975	1325266	I.54.5	62218	1108488	A.5.13	62278	1446583	N.1.4	62343	1366850	I.48.7
61976	1325265	I.54.5	62219	120252	L.2.20	62279	1446584	N.1.4	62344	1485485	I.54.6
61979	288177	I.54.5	62221	1755952	A.24.3	62280	1383609	I.50.1	62345	1485486	I.54.7
61980	288178	I.54.6	62223	1304725	A.12.1	62281	1386957	I.55.5	62346	1549740	J.1.1
61987	316756	I.56.1	62225		A.32.2	62282	1537675	I.55.5	62347	1544330	I.48.4
61988	1303318	I.51.1	62226	1308969	B.2.6	62283	62283	I.56.3	62348	1544331	I.48.4
61989	1324597	I.51.4	62227	1307793	B.2.6	62285	1749953	I.56.5	62353	1535045	I.30.7
61990	1324598	I.51.4	62228	1345492	C.2.8	62290	1764885	A.21.1	62354	581025	I.48.4
61991	1400213	I.51.4	62229	395634	C.7.9	62291	1440108	I.55.10	62356	1314653	J.1.1
61992	1329552	I.51.1	62230	395635	C.7.10	62292	1440113	I.55.10	62357	1549738	J.1.6
61993	1329551	I.51.1	62231	1102585	C.7.10	62294	1346425	J.10.3	62358	1385406	N.1.4
62010	1894408	J.8.14	62232	1356372	C.7.12	62295	1434135	J.3.2	62359	1385407	N.1.4
62011	393932	A.21.5	62233	1344190	L.2.8	62296	1424231	J.9.2	62361	1381235	A.14.12
62012	1513717	B.1.2	62234	1400209	N.1.3	62297	371910	M.1.1	62361	1381235	C.3.5
62013	550464	B.1.4	62235	423736	L.2.8	62298	280553	N.1.7	62361	1381235	H.6.4
62014	355708	B.3.1	62236	1322341	L.2.9	62299	367762	A.21.2	62363	388536	I.50.3
62027	346085	J.8.3	62237	1324366	L.2.9	62300	1471599	I.30.7	62364	1381479	I.50.2
62028	283295	J.8.3	62238	307113	L.2.5	62305	1397571	I.50.3	62365	1381480	I.50.2
62029	348694	J.8.4	62239	1379244	J.8.10	62307	1368652	I.54.2	62366	385159	I.50.3
62030	1302008	J.8.4	62240	301845	I.56.2	62308	1362708	I.54.1	62369	375903	J.2.3
62031	325014	J.8.4	62241	341403	J.8.1	62310	1401929	I.50.1	62370	375904	J.2.3
62032	311755	J.8.4	62242	348764	J.8.1	62311	1371757	I.50.1	62371	375905	J.2.4
62033	1121763	J.8.5	62243	1372432	J.8.11	62312	1371758	I.50.1	62372	1323401	J.2.2
62035	1332320	I.54.2	62244	361243	J.8.2	62313	1403954	A.21.10	62373	1353735	J.2.2
62040	1336882	A.18.2	62245	716360	J.8.2	62314	385840	J.1.4	62374	1525892	J.2.5
62040	1336882	C.9.1	62249	1117253	N.30.8	62315	1320457	J.1.3	62375	1358291	J.2.5
62041	1113033	D.1.1	62250	1515190	I.51.3	62319	336590	J.10.3	62376	1323400	J.2.1
62047	326631	A.13.16	62254	1543635	N.4.1	62321	356942	I.48.7	62377	1323410	J.2.2
62067	376243	I.7.3	62255	1543634	N.4.1	62322	1476415	J.9.3	62379	1396542	I.7.11
62089	1747894	B.1.2	62256	1383520	I.52.3	62324	62324	J.1.9	62382	1486634	A.11.4
62100	1370329	I.55.2	62257	1732510	N.1.3	62324/1	1526569	J.1.8	62383	1850567	H.6.1
62101	1370330	I.55.2	62258	1732509	N.1.3	62324/2	1526571	J.1.8	62384	1785531	I.54.11
62105	1521210	A.1.6	62259/1	62259/1	A.13.10	62324/3	1851213	J.1.8	62387	1385402	N.1.5
62108	1116987	A.1.2	62260	1764886	A.21.1	62324/4	1371201	J.1.9	62388	1385403	N.1.5
62111	1364140	L.2.19	62261	1529070	N.1.2	62324/5	1526573	J.1.9	62389	1413146	I.48.9

ALL THE COMPONENTS LISTED IN OUR CATALOGUE ARE NOT ORIGINAL, THOUGH PERFECTLY INTERCHANGEABLE. REFERENCE NUMBERS, EITHER ORIGINAL OR OF A DIFFERENT NATURE, ARE FOR INFORMATION PURPOSES ONLY. WHEN PLACING AN ORDER, PLEASE, ALWAYS USE COSIBO REFERENCE NUMBERS AND DO NOT MENTION THE ORIGINAL REFERENCE NUMBERS OF THE TRUCK MANUFACTURERS IN THE INVOICE TO VEHICLE OWNERS OR TO ANYBODY ELSE. THE CUSTOMER TAKES HIS OWN RESPONSIBILITY IF HE DOES NOT COMPLY WITH WHAT ABOVE.

Cross reference COSIBO - SCANIA

COSIBO	Replacing	Page	COSIBO	Replacing	Page	COSIBO	Replacing	Page	COSIBO	Replacing	Page
62390	1425019	M.1.1	62450	62450	I.55.8	62520	1488067	J.3.1	63107	1315559	A.33.8
62395	1374642	J.4.1	62453	1854058	C.8.3	62521	475110	L.6.1	63109	1460812	E.2.5
62397	308678	A.21.17	62455	1369053	J.1.5	62522	1441235	C.7.4	63109	1460812	F.1.1
62397	308678	H.6.6	62456	1433656	J.1.5	62523	1304786	N.2.3	63110	1515117	C.7.7
62398	1353142	H.4.2	62457	1541982	J.1.5	62524	1770301	I.30.4	63112	1515118	C.7.7
62398	1353142	N.30.3	62458	1541983	J.1.6	62524	1770301	N.2.4	63114	1375383	A.9.2
62399	1396529	I.7.4	62459	1324663	H.8.2	62525	1440365	J.7.2	63117	1545062	B.2.4
62400	1396530	I.7.5	62460	1528991	F.2.2	62526	284015	C.2.8	63120	1865675	A.13.8
62401	1873018	A.30.1	62461	1103934	B.2.1	62527	1919065	C.7.5	63123	1527743	C.1.2
62402	1873014	A.14.11	62461	1103934	C.3.2	62528	1762624	A.21.6	63128	1318388	B.3.3
62403	1421021	A.16.5	62463	2000390	I.30.7	62529	1762623	A.21.6	63128	1318388	C.3.3
62404	1732515	N.1.5	62465	550813	F.2.2	62530	1852113	C.2.3	63139	1475868	A.18.2
62406	1375497	J.1.1	62466	1386104	L.7.7	62530	1852113	J.3.4	63140	369477	A.11.3
62407	1769452	I.56.2	62467	62467	L.7.7	62531	1742265	I.50.7	63148	292811	A.8.7
62411	1870689	I.50.1	62468	62468	L.7.7	62532	1724264	I.50.6	63151	372981	A.14.8
62412	1383887	I.50.2	62469	1484808	C.6.1	62533	1767631	I.50.8	63152	1316331	A.12.2
62413	1383888	I.50.2	62470	1484809	C.6.1	62534	1401839+	A.32.2	63154	1433110	A.21.11
62414	1515195	I.30.5	62471	1391426	J.7.1		1398636		63160	1315376	H.5.2
62415	1515194	I.30.5	62472	1391425	J.7.1	62535	1401840+	A.32.3	63161	1315377	H.5.3
62420	1304787	N.2.3	62473	1440371	J.7.2		1482500		63171	1745449	A.24.1
62421	62421	I.48.5	62474	1440370	J.7.1	62536	1366781	J.10.2	63172	1404924-	A.24.2
62422	1366851	J.10.4	62475	1548504	J.2.7	62537	1366735	J.10.2		1916620	
62424	1852570	N.1.1	62476	1720924	J.1.6	62538	1440367	J.7.2	63174	283281	A.24.2
62425	1852569	N.1.1	62477	1524337	J.1.6	62539	1440364	J.7.3	63175	1375718	A.21.11
62426	1852572	N.1.1	62478	1377566	C.8.3	62540	1877664	J.10.1	63176	318364	A.27.3
62427	1852573	N.1.2	62479	1377567	C.8.4	62542	1516474	A.16.3	63176	318364	C.8.1
62428	1382728	I.55.4	62480	1755594	I.50.4	62550	1539871	I.56.2	63178	301789	A.27.3
62429	1382727	I.55.4	62481	1536807	I.50.6	62552	1761195	G.2.2	63179	382985	A.27.3
62430	1381566	I.55.3	62482	1538385	I.55.10	62553	1390706	A.22.1	63180	382983	A.27.9
62431	1381565	I.55.3	62483	1538384	I.55.9	63005	294904	C.3.1	63187	1495692	J.5.2
62432	1431925	I.51.3	62484	1504019	J.10.1	63051	316379	N.30.9	63192	1375602	A.24.4
62433	1431926	I.51.3	62485	1504020	J.10.1	63055	1303471	C.2.5	63193	1421825	A.24.4
62434	1504131	I.51.2	62486	1341110	J.10.2	63055	1303471	F.4.1	63194	318362	A.21.3
62436	62436	I.110.1	62487	1522464	J.10.3	63055	1303471	N.40.1	63219	350572	A.21.12
62437	1803335	A.23.8	62488	1346601	J.10.2	63057	384970	C.7.5	63229	412080	A.21.9
62439	1921972	C.9.2	62489	1420776	A.8.3	63064	551351	A.13.10	63229	412080	C.8.1
62440	1364666	I.52.1	62490	1368061	A.5.5	63068	815454	H.5.5	63241	184490	C.3.1
62441	1364665	I.52.1	62491	1516496	L.4.1	63071	815457	H.5.6	63253	254333	C.3.2
62442	1390747	I.54.7	62496	1539870	I.56.2	63073	815458	H.5.6	63262	1114838	C.3.1
62443	1375428	N.4.2	62497	62497	I.55.9	63074	815459	H.5.6	63275	378480	F.2.5
62444	1375427	N.4.2	62498	62498	I.55.8	63083	1401982	A.8.3	63276	1319557	C.2.2
62445	1386960	I.55.6	62512	1371839	A.21.17	63084	1111494	A.31.2	63280	551350	A.4.2
62446	1386959	I.55.6	62512	1371839	H.6.5	63085	1367028	A.8.3	63281	551363	A.4.3
62447	1370108	I.55.7	62512	1371839	J.2.6	63093	1500455	A.33.2	63292	1514086	A.23.3
62448	1370107	I.55.7	62518	1521553	H.14.1	63094	1397273	A.33.4	63293	550269	A.26.7
62449	62449	I.55.8	62519	1543688	A.7.11	63097	1300367	A.33.7	63295	551355	A.26.7

ALL THE COMPONENTS LISTED IN OUR CATALOGUE ARE NOT ORIGINAL, THOUGH PERFECTLY INTERCHANGEABLE. REFERENCE NUMBERS, EITHER ORIGINAL OR OF A DIFFERENT NATURE, ARE FOR INFORMATION PURPOSES ONLY WHEN PLACING AN ORDER, PLEASE, ALWAYS USE COSIBO REFERENCE NUMBERS AND DO NOT MENTION THE ORIGINAL REFERENCE NUMBERS OF THE TRUCK MANUFACTURERS IN THE INVOICE TO VEHICLE OWNERS OR TO ANYBODY ELSE. THE CUSTOMER TAKES HIS OWN RESPONSIBILITY IF HE DOES NOT COMPLY WITH WHAT ABOVE.

Cross reference COSIBO - SCANIA

COSIBO	Replacing	Page	COSIBO	Replacing	Page	COSIBO	Replacing	Page	COSIBO	Replacing	Page
63296	551369	A.26.7	63369	1732776	I.7.4	63549	1328995	A.7.4	63627	291826	A.8.4
63297	488368	A.21.12	63370	1732778	I.7.4	63550	1440359	A.5.8	63639	1800521	A.23.6
63300	373210	A.21.12	63372	1304292	A.5.7	63554	1484765	A.7.4	63640	1803333	A.23.6
63301	375527	A.21.13	63373/S	1313677	A.29.24	63554	1484765	C.1.7	63644	1434134	J.3.4
63303	1108053	A.13.30	63374/S	1382071	A.29.24	63555	1484766	A.7.5	63646	1430545	J.8.15
63306	1769597	M.2.2	63375	1356677	A.13.21	63555	1484766	C.1.8	63649	1671745	A.13.19
63307	1386453	B.2.7	63376	1374700	A.13.17	63556/1	1377739	L.2.1	63652	1859654	A.23.1
63308	1386454	B.2.7	63377	1380451	A.13.17	63556/1	1377739	L.4.1	63675	1341701	A.29.22
63321	1445398	A.21.8	63378	1371209	A.13.18	63556/1	1377739	L.6.3	63676	1341702	A.29.21
63322	1422564	A.29.1	63384	1514087	A.23.3	63556/1	1377739	L.7.4	63677	1472739	C.2.5
63323	1422474	A.33.8	63385	131115	A.5.6	63556/2	63556/2	L.2.1	63677	1472739	N.40.1
63326	1485717	C.7.5	63386	157274	A.5.6	63556/2	63556/2	L.4.2	63678	550537	C.1.5
63327	1482997	C.7.6	63387	131455	A.5.6	63556/2	63556/2	L.6.4	63680	1893533	I.56.5
63328	339130	C.7.7	63388	323451	A.7.3	63556/2	63556/2	L.7.5	63683	550550	H.6.2
63329	307443	C.7.2	63388	323451	C.1.7	63558	551356	A.5.2	63684	63684	H.6.3
63330	1502384	C.5.2	63389	1305676	C.6.2	63559	1349497	A.7.6	63708	550247	A.5.8
63330	1502384	F.2.1	63407	550154	H.6.5	63565	1444941	A.3.2	63712	1442706	I.7.3
63331	1472144	C.6.2	63408	1332967	A.13.11	63567	1340408	B.1.7	63733	1355655	I.56.3
63332	1474732	C.6.3	63409	1332968	A.13.11	63569	1753479	B.3.2	63739	581201	I.7.11
63333	1472142	C.6.3	63410	1332969	A.13.11	63570	329638	C.2.6	63746	346568	J.8.5
63334	1515869	C.6.4	63411	1332970	A.13.12	63571	1375369	A.29.26	63747	383523	J.8.6
63335	1472145	C.6.5	63412	1332971	A.13.12	63572	1375370	A.29.26	63749	304332	D.1.3
63336	63336	H.40.5	63413	1333116	A.13.24	63573	1375371	A.29.26	63750	1313606	A.2.3
63337	804672	C.6.7	63414	1545479	A.13.23	63574	1375372	A.29.27	63753	1411774	H.2.1
63338	804658	C.6.7	63416	1320973	A.5.7	63575	1375373	A.29.27	63754	63754	C.2.1
63339	1472718	C.6.6	63438	1368123	N.3.1	63576	1375374	A.29.27	63755	1364636	C.2.2
63344	1515870	C.6.6	63440	1405979	N.31.1	63585	1394884	M.2.2	63757	1104213	H.13.3
63345	1502385	F.2.1	63446	1543731	N.30.6	63587	1759691	M.2.2	63759	1377386	C.7.6
63346	1112829	H.13.8	63447	1431781	A.12.2	63589	1759690	M.2.3	63761	1525891	J.2.5
63347	1112830	H.13.9	63447	1431781	C.2.5	63591	1375228	M.2.4	63764	1372154	H.14.2
63348	1789560	H.13.9	63447	1431781	H.8.2	63593	1378882	N.30.6	63765	1372155	H.14.2
63349	1789561	H.13.9	63447	1431781	J.3.1	63594	1378883	N.30.7	63766	1872152	A.16.6
63350	1789562	H.13.10	63447	1431781	N.30.4	63598	355223	N.30.7	63767	1433183	A.10.3
63353	346077	M.5.1	63450	1318306	N.30.4	63599	1308474	N.1.7	63769	1861118	L.1.1
63354	1541653	M.1.1	63465	1902698	N.30.4	63600	1308473	N.1.7	63777	63777	A.13.12
63355	1540425	M.1.2	63466	1902328	N.30.5	63601	1377231	A.27.3	63778	1364290	A.33.6
63356	1386271	N.3.2	63467	1401789	N.30.5	63601	1377231	C.8.2	63779	1374413	H.2.1
63357	1386272	N.3.1	63468	270739	A.13.18	63602	1341729	A.27.4	63780	1354420	A.13.13
63359	1350343	N.3.3	63469	270738	A.13.18	63604	1488066	J.3.3	63781	1340899	A.13.13
63361	1744210	J.8.9	63470	293853	A.13.19	63607	1109281	A.13.17	63782	1354428	A.13.13
63362	1525890	J.2.4	63540	1346905	I.48.3	63617	470391	M.1.1	63783	1355353	A.13.14
63363	1525888	J.2.4	63541	1346906	I.48.3	63618	1869987	A.16.6	63784	1422198	A.13.13
63364	1525889	J.2.4	63545	1791152	A.1.4	63619	1395248	A.13.19	63785	1422200	A.13.13
63365	288212	J.2.2	63546	1785076	A.1.3	63620	1306492	J.4.1	63786	1412398	A.22.1
63366	288213	J.2.2	63547	1309051	A.13.6	63621	63621	C.5.2	63791	1865749	H.13.7
63367	288214	J.2.3	63548	1862376	A.7.3	63625	63625	C.6.5	63792	1448117	H.13.8

ALL THE COMPONENTS LISTED IN OUR CATALOGUE ARE NOT ORIGINAL, THOUGH PERFECTLY INTERCHANGEABLE. REFERENCE NUMBERS, EITHER ORIGINAL OR OF A DIFFERENT NATURE, ARE FOR INFORMATION PURPOSES ONLY WHEN PLACING AN ORDER, PLEASE, ALWAYS USE COSIBO REFERENCE NUMBERS AND DO NOT MENTION THE ORIGINAL REFERENCE NUMBERS OF THE TRUCK MANUFACTURERS IN THE INVOICE TO VEHICLE OWNERS OR TO ANYBODY ELSE. THE CUSTOMER TAKES HIS OWN RESPONSIBILITY IF HE DOES NOT COMPLY WITH WHAT ABOVE.

Cross reference COSIBO - SCANIA

COSIBO	Replacing	Page	COSIBO	Replacing	Page	COSIBO	Replacing	Page	COSIBO	Replacing	Page
63793	63793	C.2.6	63918	1371754	I.50.4	64003	1343262	M.2.4	64082	813933	L.60.1
63794	63794	A.23.10	63919	1863896	A.13.14	64006	1545149	A.33.9	64082	813933	O.2.1
63795	63795	A.23.11	63920	1541367	A.13.15	64007	1722828	A.33.10	64083	813935	A.105.1
63797	1732782	I.7.9	63921	1541368	A.13.15	64008	1549482	A.26.4	64083	813935	C.50.1
63800	1366141	I.7.10	63922	1850826	A.13.15	64009	1335674	A.16.6	64083	813935	H.50.1
63801	1396541	I.7.11	63923	1863897	A.13.16	64016	1431701	A.16.8	64083	813935	I.105.1
63804	1367027	A.8.4	63924	1863898	A.13.16	64016	1431701	H.4.3	64083	813935	L.60.1
63808	63808	J.8.8	63925	63925	A.13.14	64017	1439822	A.21.9	64083	813935	O.2.1
63809	1402449	N.30.2	63926	1431979	A.24.2	64022	1374326	A.9.2	64084	813937	A.105.2
63811	63811	J.8.8	63927	1744211	J.8.9	64023	1346177	I.48.2	64084	813937	B.50.1
63812	63812	L.2.18	63929	1388070	A.21.8	64024	1346178	I.48.3	64084	813937	C.50.1
63813	63813	L.2.18	63929	1388070	B.8.1	64025	1346119	I.48.9	64084	813937	H.50.1
63814	63814	L.2.19	63929	1388070	H.6.6	64026	1366764	I.48.9	64084	813937	I.105.1
63844	1379621	C.7.13	63930	365162	O.2.7	64027	1738098	J.5.2	64084	813937	L.60.1
63845	1472771	C.7.14	63931	550469	A.4.4	64028	1424074	A.32.3	64084	813937	M.30.1
63846	1341683	B.2.9	63933	1468555	A.3.3	64033	1873183	G.2.1	64084	813937	O.2.1
63847	1452862	A.12.2	63934	1800527	A.23.9	64034	1374500	A.22.6	64085	813939	A.105.2
63847	1452862	N.30.8	63934	1800527	J.5.1	64036	550282	L.3.1	64085	813939	C.50.1
63852	1399180	L.5.1	63938	1427794	J.1.3	64049	1331164	J.4.1	64085	813939	H.50.1
63853	1411851	A.8.4	63942	1541984	J.1.3	64050	376283	I.48.1	64085	813939	I.105.2
63854	1401984	A.8.5	63954	1382072	A.29.22	64051	376284	I.48.1	64085	813939	M.30.1
63855	1414422	A.8.5	63955	1382073	A.29.22	64052	1318506	J.2.7	64085	813939	O.2.2
63856	1375839	A.26.3	63956	1382074	A.29.23	64053	1392755	J.2.7	64086	813941	A.105.3
63857	1354979	A.22.1	63957	1313681	A.29.23	64054	1849428	A.21.17	64086	813941	C.50.2
63858	1859655	A.23.1	63958	1313682	A.29.23	64058	1870001	A.16.7	64086	813941	H.50.2
63860	1732783	I.7.10	63959	1313683	A.29.23	64060	1481371	J.4.1	64086	813941	I.105.2
63862	1746684	A.13.5	63960	1517650	I.55.14	64061	1444016	J.9.3	64086	813941	M.30.2
63863	390918	A.13.6	63961	1517649	I.55.14	64062	1369553	J.4.1	64086	813941	O.2.2
63864	1481301	A.32.1	63962	1496659	I.35.1	64064	1340860	H.12.1	64087	1355703	A.8.7
63865	550553	H.6.2	63963	1411129	H.6.6	64065	1340859	H.12.1	64088	1321727	H.13.1
63866	1742920	J.2.1	63964	1725664	I.54.11	64066	1858884	A.23.4	64089	813932	A.105.3
63867	1797845	C.8.4	63965	1725663	I.54.10	64067	1383496	J.8.8	64089	813932	H.50.2
63873	1780108	J.8.9	63966	1888464	A.23.6	64068	1726130	L.2.2	64089	813932	I.105.3
63882	1541106	J.2.1	63967	1800539	A.23.7	64069	199846	I.56.2	64089	813932	O.2.2
63885	1754943	B.1.3	63968	1420911	A.23.8	64070	1361131	H.8.3	64090	813934	A.105.4
63886	1873016	A.30.2	63969	1888465	A.23.7	64070	1361131	L.6.1	64090	813934	B.50.1
63893	1789568	H.13.11	63987	1523607	I.54.10	64071	1461414	C.4.1	64090	813934	C.50.2
63894	1789567	H.13.10	63988	1523608	I.54.10	64072	1781929	J.8.15	64090	813934	F.50.1
63896	1403823	A.1.7	63991	1382075	A.29.24	64074	358404	C.3.4	64090	813934	H.50.2
63898	552004	F.5.2	63992	1302531	A.29.25	64080	378613	C.3.5	64090	813934	I.105.3
63898	552004	L.2.1	63994	561991	A.5.10	64081	1350394	A.27.10	64090	813934	L.60.1
63913	1442292	I.48.8	63997	1386227	L.7.8	64082	813933	A.105.1	64090	813934	O.2.3
63914	1442293	I.48.9	64000	1357628+	A.29.28	64082	813933	C.50.1	64091	813936	A.105.4
63915	1732507	N.1.5		1357633		64082	813933	F.50.1	64091	813936	B.50.1
63916	1732508	N.1.6	64001	1789305	I.48.1	64082	813933	H.60.1	64091	813936	C.50.2
63917	1401931	I.50.4	64002	1789306	I.48.1	64082	813933	I.105.1	64091	813936	F.50.1

ALL THE COMPONENTS LISTED IN OUR CATALOGUE ARE NOT ORIGINAL, THOUGH PERFECTLY INTERCHANGEABLE. REFERENCE NUMBERS, EITHER ORIGINAL OR OF A DIFFERENT NATURE, ARE FOR INFORMATION PURPOSES ONLY WHEN PLACING AN ORDER, PLEASE, ALWAYS USE COSIBO REFERENCE NUMBERS AND DO NOT MENTION THE ORIGINAL REFERENCE NUMBERS OF THE TRUCK MANUFACTURERS IN THE INVOICE TO VEHICLE OWNERS OR TO ANYBODY ELSE. THE CUSTOMER TAKES HIS OWN RESPONSIBILITY IF HE DOES NOT COMPLY WITH WHAT ABOVE.

Cross reference COSIBO - SCANIA

COSIBO	Replacing	Page	COSIBO	Replacing	Page	COSIBO	Replacing	Page	COSIBO	Replacing	Page
64091	813936	H.50.3	64101	804591	O.2.5	64178	1475750	N.30.5	64312	1549495	C.1.3
64091	813936	I.105.4	64102	1520867	J.10.1	64182	813245	O.1.2	64314	550533	C.1.3
64091	813936	L.60.2	64103	1871043	A.5.9	64183	1888468	A.23.10	64315	1335673	A.16.7
64091	813936	M.30.2	64103	1871043	H.7.1	64184	1424970	N.30.2	64329	1856473	I.55.13
64091	813936	O.2.3	64104	1535052	I.30.8	64185	1859657	A.23.2	64330	1856472	I.55.13
64092	813938	A.105.5	64105	1805447	I.30.8	64186	1765382	M.2.5	64331	64331	B.2.5
64092	813938	B.50.2	64106	64106	I.54.9	64187	814195	A.23.10	64332	64332	C.7.8
64092	813938	C.50.2	64107	64107	I.54.10	64187	814195	N.31.2	64340	64340	B.3.1
64092	813938	H.50.3	64110	1549741	J.1.2	64188	551477	A.26.8	64343	1738379	E.2.2
64092	813938	I.105.4	64111	1368039	J.8.10	64189	1380814	L.5.2	64343	1738379	F.5.1
64092	813938	L.60.2	64112	1350440	O.2.5	64190	64190	A.7.20	64343	1738379	M.2.4
64092	813938	M.30.2	64113	1350441	O.2.5	64197	1466382	A.5.10	64344	1732322	I.30.6
64092	813938	O.2.3	64114	1355667	I.56.1	64206	1386424	J.8.16	64345	1529886	I.30.6
64093	813940	A.105.5	64117	1431199	L.7.8	64207	1543608	I.55.11	64346	1420908	A.23.8
64093	813940	B.50.2	64119	64119	O.1.1	64208	1543609	I.55.11	64347	1549330	A.31.1
64093	813940	C.50.3	64121	1800535	A.23.7	64209	1913500	J.5.3	64348	64348	I.56.4
64093	813940	H.50.3	64122	1756460	B.1.3	64210	345083	H.5.1	64349	1732856	I.54.9
64093	813940	I.105.5	64123	1789522	A.26.4	64226	1466383	A.7.8	64350	1732855	I.54.9
64093	813940	L.60.2	64129	64129	A.14.4	64232	1509813	A.7.9	64351	1392708	A.11.3
64093	813940	O.2.4	64130	64130	A.14.5	64244	1369975	C.7.6	64352	1373127	A.2.4
64094	813942	A.105.5	64131	64131	A.14.6	64245	1723518+	I.7.5	64354	1452542	H.14.2
64094	813942	C.50.3	64132	390684	O.1.1		1732782		64355	1733735	A.27.9
64094	813942	I.105.5	64134	1327015	J.3.3	64246	1737306	B.3.1	64356	1790071	A.27.9
64094	813942	O.2.4	64137	1502798	A.7.6	64251	1858885	A.23.4	64356	1790071	J.1.10
64095	804578	A.105.6	64138	64138	A.7.9	64252	1792374	N.3.5	64357	1325383	C.7.8
64095	804578	B.50.2	64140	64140	A.7.10	64253	1792375	N.3.5	64358	1433190	A.16.8
64095	804578	C.50.3	64142	1746135	A.7.8	64260	1342745	H.12.2	64358	1433190	H.4.4
64095	804578	I.105.5	64143	381235	A.7.19	64261	1342746	H.12.2	64362	1459146	I.50.7
64095	804578	L.60.2	64144	1351692	A.7.19	64270	62470	J.8.7	64363	1903797	C.6.5
64095	804578	M.30.3	64145	1539675	A.5.11	64271	62471	J.8.7	64364	1804628	I.50.7
64095	804578	O.2.4	64152	1755638	J.8.12	64273	551560	A.5.2	64368	1346181	I.48.2
64096	804589	A.105.6	64163	233275	G.2.11	64274	551573	A.4.4	64369	1425659	I.48.2
64096	804589	H.50.4	64164	1120873	G.2.11	64275	551570	A.4.5	64373	1864620	J.2.1
64096	804589	I.105.6	64165	1336380	G.2.11	64277	1437296	A.16.4	64374	1530783	A.22.4
64097	1379922	B.3.3	64166	1736562	G.2.12	64278	1336138	A.13.6	64375	1387547	A.16.7
64098	1302914	B.3.4	64167	1354103	A.26.5	64298	1910437	I.56.4	64376	1804034	A.26.8
64099	1370141	L.4.1	64169	1723519	I.7.6	64299	1910438	I.56.4	64378	1527913	A.2.2
64100	804583	A.105.6	64170	1723518	I.7.7	64301	1342708	G.2.10	64379	64379	A.13.26
64100	804583	C.50.3	64171	1484076+	I.7.12	64304	1472738	C.2.4	64382	1372174	I.56.4
64100	804583	H.50.4		1484078		64304	1472738	E.3.1	64385	64385	A.7.10
64100	804583	I.105.6	64172	1484076+	I.7.13	64304	1472738	F.4.1	64386	64386	A.7.10
64100	804583	M.30.3		1484079		64304	1472738	N.40.1	64397	1757877	A.21.7
64100	804583	O.2.5	64173	1916864	I.7.12	64306	1725112	A.4.5	64493	353623	J.3.3
64101	804591	A.105.7	64174	1484081	I.7.12	64307	1403883	A.26.2	64497	1868087	G.2.3
64101	804591	H.50.4	64175	550578	C.1.6	64309	550283	L.3.1	64498	339129	C.7.4
64101	804591	I.105.6	64177	1731130	N.30.8	64311	550577	C.1.7	64498/2	64498/2	C.7.4

ALL THE COMPONENTS LISTED IN OUR CATALOGUE ARE NOT ORIGINAL, THOUGH PERFECTLY INTERCHANGEABLE. REFERENCE NUMBERS, EITHER ORIGINAL OR OF A DIFFERENT NATURE, ARE FOR INFORMATION PURPOSES ONLY. WHEN PLACING AN ORDER, PLEASE, ALWAYS USE COSIBO REFERENCE NUMBERS AND DO NOT MENTION THE ORIGINAL REFERENCE NUMBERS OF THE TRUCK MANUFACTURERS IN THE INVOICE TO VEHICLE OWNERS OR TO ANYBODY ELSE. THE CUSTOMER TAKES HIS OWN RESPONSIBILITY IF HE DOES NOT COMPLY WITH WHAT ABOVE.

Cross reference COSIBO - SCANIA

COSIBO	Replacing	Page	COSIBO	Replacing	Page	COSIBO	Replacing	Page	COSIBO	Replacing	Page
64509	1395994	J.2.6	64683	1300831	N.1.9	64790	804670	E.1.3	65150	1375603	A.27.8
64522	294271	D.1.1	64684	64684	I.56.3	64790	804670	L.8.1	65151	371780	A.28.1
64522/1	294270	D.1.1	64686	1548318	C.7.8	64800	1349089	H.12.3	65151/1	371780/1	A.28.2
64524	1113031	D.1.2	64687	1391831	C.7.8	64801	1794440	H.13.4	65152	319792	A.28.2
64631	64631	A.21.4	64688	1391830	C.7.9	64998	1859656	A.23.2	65153	367624	A.28.2
64632	64632	A.21.4	64690	1794745	A.13.23	65001	1388680	A.11.1	65154	269342	A.28.1
64633	1387764	D.1.2	64691	1459133	I.50.5	65002	1522011	A.21.13	65155	1307770	A.28.3
64634	1387794	D.1.2	64692	1459134	I.50.5	65003	65003	C.6.6	65163	361481	A.32.3
64639	1498102	N.3.5	64693	1459135	I.50.5	65008	164433	F.2.3	65176	1350317	J.3.1
64640	1498103	N.3.5	64694	1459141	I.50.7	65021	1320602	A.21.2	65177	389035	B.1.5
64641	1792387	N.3.4	64695	1459142	I.50.7	65026	1380880	H.14.2	65177	389035	H.4.4
64642	1792388	N.3.4	64696	1459145	I.50.5	65028	1377692	L.2.20	65178	1409551	B.1.5
64643	1725675	I.54.8	64697	1748085	I.50.5	65036	372983	A.14.10	65178	1409551	H.4.4
64644	1725676	I.54.8	64698	1431933	I.52.1	65073	1378527	J.1.2	65179	283650	B.1.6
64645	1375838	A.26.5	64699	1431934	I.52.2	65074	1378531	J.1.2	65179	283650	C.2.7
64647	1486148	A.22.3	64700	1512423	I.30.2	65075	184808	F.2.4	65179	283650	H.8.2
64648	1332193	A.22.2	64701	1512424	I.30.2	65088	1335618	A.33.1	65180	287379	C.7.10
64649	1440406	A.22.5	64702	1442653	I.30.2	65089	550567	H.6.3	65181	287380	C.7.11
64650	1725671	I.54.7	64703	1442654	I.30.3	65089/2	550567/2	H.6.4	65182	339141	C.7.11
64651	1725672	I.54.8	64704	1431931	I.52.2	65091	315085	C.4.1	65183	1300097	C.7.11
64653	1747981	N.2.1	64707	1431932	I.52.2	65091	315085	D.1.3	65184	349034	C.7.11
64654	1727992	N.4.3	64708	1779120	I.30.3	65092	1525145	A.21.14	65186	1853436	C.2.4
64655	1727991	N.4.2	64709	1779121	I.30.3	65094	1888471	A.23.9	65186	1853436	J.3.2
64656	1431923	N.4.4	64711	1549737	J.1.7	65095	1800523	A.23.9	65187	1300043	C.8.4
64657	1431922	N.4.4	64721	1375390	M.5.1	65096	303496	H.8.1	65191	1536304	A.12.3
64658	1438564	N.4.5	64722	1722694	J.2.6	65096	303496	L.6.2	65191	1536304	C.2.3
64659	1438563	N.4.4	64723	1375382	G.2.14	65098	1510575	A.33.4	65191	1536304	E.3.1
64660	1431921	N.4.3	64726	1548055	L.2.4	65099	1794725	A.21.14	65191	1536304	F.10.1
64661	1431920	N.4.3	64738	64738	L.2.11	65119	1392929	A.14.1	65191	1536304	H.8.1
64662	1439789	I.51.2	64739	64739	L.2.11	65122	1541549	C.8.2	65191	1536304	J.6.2
64663	1439788	I.51.1	64740	1800871	A.33.2	65125	1373919	A.27.4	65191	1536304	L.6.2
64664	1731206	I.51.1	64741	1502468	J.9.4	65128	1376226	A.27.4	65191	1536304	N.40.1
64665	1483281	A.33.4	64742	1505748	A.33.4	65129	1374040	A.27.4	65192	1426449	C.1.2
64667	1892324	N.1.8	64745	1482079	I.51.5	65129	1374040	C.8.2	65193	550284	E.1.2
64668	1892322	N.1.8	64746	1482080	I.51.5	65130	1449431	A.27.5	65194	550257	E.1.3
64672	1786692	N.1.2	64747	1482078	I.51.5	65131	1376895	A.27.5	65206	1386753	L.7.9
64673	1786693	N.1.2	64748	64748	A.5.10	65132	1545116	A.27.5	65213	273024	G.2.4
64674	1523508	I.51.2	64749	551520	A.5.1	65133	1376896	A.27.6	65214	1104500	G.2.4
64675	1523509	I.51.2	64750	1849922	A.5.3	65134	1383873	A.27.6	65226	1338018	H.40.3
64676	1466031	I.50.4	64751	1488658	A.5.3	65135	1383990	A.27.6	65227	1866391	A.13.19
64677	1466032	I.50.4	64777	1373126	A.21.15	65136	1426194	A.27.7	65231	222095	L.7.9
64678	1727263	I.50.6	64778	1331820	A.21.16	65137	1395066	A.27.7	65233	1400769	H.4.2
64679	1727264	I.50.6	64778	1331820	C.1.8	65142	1385086	A.27.7	65237	397946	H.8.2
64680	1856475	I.55.12	64778	1331820	F.2.5	65143	1529007	A.27.8	65239	550806	L.5.1
64681	1856474	I.55.12	64790	804670	A.28.5	65144	1377331	A.27.8	65240	550807	L.5.1
64682	1805399	I.50.5	64790	804670	C.7.14	65145	1376949	A.27.8	65241	550808	L.5.2

ALL THE COMPONENTS LISTED IN OUR CATALOGUE ARE NOT ORIGINAL, THOUGH PERFECTLY INTERCHANGEABLE. REFERENCE NUMBERS, EITHER ORIGINAL OR OF A DIFFERENT NATURE, ARE FOR INFORMATION PURPOSES ONLY. WHEN PLACING AN ORDER, PLEASE, ALWAYS USE COSIBO REFERENCE NUMBERS AND DO NOT MENTION THE ORIGINAL REFERENCE NUMBERS OF THE TRUCK MANUFACTURERS IN THE INVOICE TO VEHICLE OWNERS OR TO ANYBODY ELSE. THE CUSTOMER TAKES HIS OWN RESPONSIBILITY IF HE DOES NOT COMPLY WITH WHAT ABOVE.

Cross reference COSIBO - SCANIA

COSIBO	Replacing	Page	COSIBO	Replacing	Page	COSIBO	Replacing	Page	COSIBO	Replacing	Page
65242	423730	L.2.5	65331	1851631	B.2.5	66606	1403609	H.3.3			
65243	639320	L.6.1	65332	1749123	B.2.7	66623	258420	L.1.1			
65244	285493	L.2.20	65334	1386647	A.1.3	68888	1535049	I.30.6			
65246	1529552	I.54.11	65335	1386648	A.1.3						
65248	360247	N.30.1	65336	1360836	A.1.2						
65249	1402448	N.30.2	65337	551387	A.5.3						
65250	363712	N.30.3	65338	551528	A.5.3						
65254	302200	J.6.1	65339	551386	A.5.4						
65255	1343100	J.8.15	65340	1765974	A.4.6						
65261	1324713	J.8.13	65342	1505366	A.8.5						
65262	1768269	J.8.12	65343	1449542	A.8.6						
65263	1324712	J.8.13	65344	1542104	A.8.6						
65269	1353965	J.8.10	65345	1392933	A.9.2						
65272	384595	J.8.1	65349	371497	A.9.3						
65273	1358828	J.8.1	65352	1896605	A.11.2						
65275	371211	A.13.11	65353	1374334	A.11.2						
65278	1334196	N.30.3	65359	1375391	M.5.1						
65279	1853773	A.13.20	65360	1769522	A.22.3						
65282	1353959	J.8.11	65361	1505749	A.33.5						
65283	1805603	H.2.2	65365	1442294	I.48.8						
65296	1421599	H.6.1	65366	1442295	I.48.8						
65298	276228	L.2.2	65368	1513719	B.2.8						
65300	1372786	L.7.9	65370	1865674	A.13.10						
65302	1368682	L.7.8	65373	1446581	N.1.6						
65305	280378	I.55.1	65374	1446582	N.1.6						
65306	280377	I.55.1	65375	1385413	N.1.8						
65307	388306	I.55.1	65376	138414	N.1.8						
65308	388305	I.55.1	65377	1385409	N.1.9						
65310	1368681	L.7.8	65379	1929397+	B.2.8						
65311	1775964	A.13.24		1382331							
65312	1775965	A.13.23	65380	65380	L.2.3						
65313	1439814	A.13.22	65381	65381	I.110.1						
65315	550268	C.7.1	65390	1302772	I.54.4						
65316	1549739	J.1.4	65394	1849060	A.24.1						
65317	1386571	J.1.7	65501	1444822	F.2.2						
65318	1325626	J.1.7	66520	120824	H.40.4						
65319	1440407	A.22.6	66573/1	242857	A.32.2						
65320	1511832	A.22.4	66578/1	1346612	C.7.13						
65321	65321	I.7.8	66579/1	1373520	A.22.5						
65322	65322	I.7.8	66580/1	1514089	C.7.13						
65323	65323	I.7.9	66581/1	488372	A.5.11						
65324	65324	I.7.7	66582	1357381	J.8.11						
65325	1390705	A.22.2	66583	1346606	C.7.12						
65326	1742449	J.8.13	66584	1357380	J.1.7						
65327	65327	C.6.7	66585	1346608	C.7.12						
65328	1521554	H.14.2	66600	242573	H.3.2						

ALL THE COMPONENTS LISTED IN OUR CATALOGUE ARE NOT ORIGINAL, THOUGH PERFECTLY INTERCHANGEABLE. REFERENCE NUMBERS, EITHER ORIGINAL OR OF A DIFFERENT NATURE, ARE FOR INFORMATION PURPOSES ONLY WHEN PLACING AN ORDER, PLEASE, ALWAYS USE COSIBO REFERENCE NUMBERS AND DO NOT MENTION THE ORIGINAL REFERENCE NUMBERS OF THE TRUCK MANUFACTURERS IN THE INVOICE TO VEHICLE OWNERS OR TO ANYBODY ELSE. THE CUSTOMER TAKES HIS OWN RESPONSIBILITY IF HE DOES NOT COMPLY WITH WHAT ABOVE.

Cross reference SCANIA - COSIBO

Replacing	COSIBO	Page	Replacing	COSIBO	Page	Replacing	COSIBO	Page	Replacing	COSIBO	Page
	62225	A.32.2	64631	64631	A.21.4	169316	60331	A.29.3	225353	60114	A.7.14
15323	61537	A.13.22	64632	64632	A.21.4	169317	60332	A.29.3	225354	60115	A.7.14
40607	60398	A.33.9	64684	64684	I.56.3	169318	60333	A.29.3	225931	60113	A.7.13
62283	62283	I.56.3	64738	64738	L.2.11	169319	60334	A.29.4	228483	61303	L.2.6
62324	62324	J.1.9	64739	64739	L.2.11	169320	60335	A.29.4	233275	64163	G.2.11
62421	62421	I.48.5	64748	64748	A.5.10	169321	60336	A.29.4	234387	61624	C.2.4
62436	62436	I.110.1	65003	65003	C.6.6	170761	60999	A.22.7	235434	61371	C.3.4
62449	62449	I.55.8	65321	65321	I.7.8	170948	61491	A.13.20	235434	61371	F.1.2
62450	62450	I.55.8	65322	65322	I.7.8	170955	61492	A.13.20	237884	61319	L.2.19
62467	62467	L.7.7	65323	65323	I.7.9	180064	60549	H.40.5	238777	60116	A.7.15
62468	62468	L.7.7	65324	65324	I.7.7	180435	61917	A.13.27	241922	60962	L.2.4
62470	64270	J.8.7	65327	65327	C.6.7	182929	60918	L.2.17	242297	60408	A.7.16
62471	64271	J.8.7	65380	65380	L.2.3	182930	60538	H.40.4	242298	60409	A.7.16
62497	62497	I.55.9	65381	65381	I.110.1	182931	60919	L.2.17	242299	60407	A.7.15
62498	62498	I.55.8	120252	62219	L.2.20	184490	63241	C.3.1	242300	61240	A.7.16
63336	63336	H.40.5	120824	66520	H.40.4	184808	65075	F.2.4	242573	66600	H.3.2
63621	63621	C.5.2	120828	60958	H.13.1	192882	61121	A.28.4	242857	66573/1	A.32.2
63625	63625	C.6.5	123102	60546	H.40.5	193136	60299	G.2.2	244090	61333	C.6.1
63684	63684	H.6.3	128680	60916	L.2.15	194414	61215	C.5.1	244780	61496	C.2.7
63754	63754	C.2.1	131115	63385	A.5.6	194838	61341	B.2.1	250318	60416	O.2.6
63777	63777	A.13.12	131455	63387	A.5.6	194838	61341	C.1.1	250996	60073	A.13.21
63793	63793	C.2.6	134494	60547/1	H.12.4	197800	60635	A.5.4	252497	61218	L.7.1
63794	63794	A.23.10	135036	60917	L.2.16	197800	60635	C.8.3	254333	63253	C.3.2
63795	63795	A.23.11	135698	60921	L.2.16	197800	60635	F.2.5	258410	60319	A.29.2
63808	63808	J.8.8	138414	65376	N.1.8	199846	64069	I.56.2	258411	60320	A.29.2
63811	63811	J.8.8	139616	60566	A.13.2	204719	61510	L.7.6	258412	60321	A.29.2
63812	63812	L.2.18	141163	60540	H.40.1	204722	61511	L.7.6	258420	66623	L.1.1
63813	63813	L.2.18	141164	60539	H.40.4	204723	61502	L.7.2	258459	60561	A.8.1
63814	63814	L.2.19	142575	61323	H.13.12	204727	61509	L.7.5	258686	60325	A.29.4
63925	63925	A.13.14	142729	61808	A.27.1	204728	60867	L.7.6	258687	60326	A.29.5
64106	64106	I.54.9	142729	61808	J.5.1	204735	61504	L.7.2	258688	60327	A.29.5
64107	64107	I.54.10	146526	60142	C.9.1	204736	61505	L.7.2	258689	60328	A.29.5
64119	64119	O.1.1	153287	60961	L.2.4	204737	61503	L.7.2	258690	60329	A.29.5
64129	64129	A.14.4	154259	60955	H.40.2	204746	61507	L.7.3	258691	60330	A.29.6
64130	64130	A.14.5	154261	60535	H.40.2	204750	61501	L.7.1	259065	61000	A.26.2
64131	64131	A.14.6	154262	60536	H.40.1	211005	61120	A.28.1	263161	60391	A.7.15
64138	64138	A.7.9	154621	60112	A.7.13	211813	61233	A.14.3	263911	60692	A.29.7
64140	64140	A.7.10	156938	61849	G.2.13	213604	61220	L.2.6	263912	60693	A.29.8
64190	64190	A.7.20	157274	63386	A.5.6	213606	61306	L.2.9	263917	60698	A.29.9
64331	64331	B.2.5	159496	60005	G.2.6	213607	61307	L.2.10	263918	60699	A.29.9
64332	64332	C.7.8	159656	61195	H.8.3	214008	61010	F.2.4	264310	60301	G.2.2
64340	64340	B.3.1	164433	65008	F.2.3	218831	61260	H.13.6	264311	60302	G.2.2
64348	64348	I.56.4	165286	61205	A.13.29	218832	61259	H.13.6	269342	65154	A.28.1
64379	64379	A.13.26	168778	60322	A.29.2	222095	65231	L.7.9	270738	63469	A.13.18
64385	64385	A.7.10	168781	60323	A.29.3	222499	61490/1	A.13.2	270739	63468	A.13.18
64386	64386	A.7.10	168782	60324	A.29.3	223315	61799	A.27.2	271147	60694	A.29.8

ALL THE COMPONENTS LISTED IN OUR CATALOGUE ARE NOT ORIGINAL, THOUGH PERFECTLY INTERCHANGEABLE. REFERENCE NUMBERS, EITHER ORIGINAL OR OF A DIFFERENT NATURE, ARE FOR INFORMATION PURPOSES ONLY. WHEN PLACING AN ORDER, PLEASE, ALWAYS USE COSIBO REFERENCE NUMBERS AND DO NOT MENTION THE ORIGINAL REFERENCE NUMBERS OF THE TRUCK MANUFACTURERS IN THE INVOICE TO VEHICLE OWNERS OR TO ANYBODY ELSE. THE CUSTOMER TAKES HIS OWN RESPONSIBILITY IF HE DOES NOT COMPLY WITH WHAT ABOVE.

Cross reference SCANIA - COSIBO

Replacing	COSIBO	Page	Replacing	COSIBO	Page	Replacing	COSIBO	Page	Replacing	COSIBO	Page
271148	60695	A.29.8	297394	61703	A.21.15	315085	65091	D.1.3	339141	65182	C.7.11
272400	61850	L.1.1	297394	61703	C.8.2	315270	61214	C.5.1	339188	61734	L.2.8
272449	61315	L.2.5	297568	60496	N.3.1	316379	63051	N.30.9	341403	62241	J.8.1
273022	61761	G.2.5	298823	61793	A.27.2	316640	61706	I.7.3	342832	60794	B.2.2
273023	61650	G.2.5	298823	61793	C.8.1	316756	61987	I.56.1	342833	60795	B.2.2
273024	65213	G.2.4	301789	63178	A.27.3	316918	62133	I.7.1	342988	60629	A.25.1
273793	60654	A.21.6	301843	61602	I.56.1	316920	62136	I.7.1	345083	64210	H.5.1
275460	60909	L.2.13	301844	61911	I.56.1	318350	61864	A.27.1	346077	63353	M.5.1
276087	61538	A.13.21	301845	62240	I.56.2	318362	63194	A.21.3	346085	62027	J.8.3
276228	65298	L.2.2	302200	65254	J.6.1	318364	63176	A.27.3	346568	63746	J.8.5
278665	61549	M.2.1	303496	65096	H.8.1	318364	63176	C.8.1	346627	61212	A.27.1
280377	65306	I.55.1	303496	65096	L.6.2	318523	60721	A.31.1	346627	61212	C.8.1
280378	65305	I.55.1	303520	60922	J.5.2	319110	60016	A.7.12	346627	61212	J.5.1
280553	62298	N.1.7	303643	61798	A.27.1	319792	65152	A.28.2	348293	60689	A.29.7
280651	61325	H.13.2	304309	60974	B.2.3	320813	60687	A.29.7	348294	60690	A.29.7
280652	61335	H.13.2	304332	63749	D.1.3	320814	60688	A.29.7	348694	62029	J.8.4
283281	63174	A.24.2	305286	60683	A.29.6	322693	60712	A.29.9	348764	62242	J.8.1
283295	62028	J.8.3	305287	60684	A.29.6	322694	60713	A.29.9	349034	65184	C.7.11
283642	60554	L.2.14	305288	60685	A.29.6	322695	60714	A.29.9	350270	61209	C.7.1
283650	65179	B.1.6	305289	60686	A.29.6	322697	60715	A.29.10	350572	63219	A.21.12
283650	65179	C.2.7	306278	60597	B.1.7	322698	60716	A.29.10	351197	61846	A.24.3
283650	65179	H.8.2	306902	60580	L.2.7	322699	60717	A.29.10	352211	60010	A.1.1
284015	62526	C.2.8	307113	62238	L.2.5	323451	63388	A.7.3	352543	62216	A.5.12
284843	60047	C.4.2	307443	63329	C.7.2	323451	63388	C.1.7	352635	61924	M.2.1
285248	61731	A.5.11	308385	60696	A.29.8	323662	61630	A.7.1	353592	61621	J.4.1
285248	61731	J.8.12	308386	60697	A.29.8	323790	60127	A.10.4	353623	64493	J.3.3
285493	65244	L.2.20	308604	60653	A.21.5	323790	60127	H.5.1	353628	61865	N.30.3
287379	65180	C.7.10	308678	62397	A.21.17	325014	62031	J.8.4	353843	60102	A.2.3
287380	65181	C.7.11	308678	62397	H.6.6	326631	62047	A.13.16	354967	61213	A.27.2
288177	61979	I.54.5	309065	61232	A.21.5	329583	61226	J.8.6	355145	60914	L.2.14
288178	61980	I.54.6	309421	61266	H.13.7	329638	63570	C.2.6	355147	60913	L.2.15
288212	63365	J.2.2	309422	61265	H.13.7	332119	60636	A.14.9	355148	60920	L.2.16
288213	63366	J.2.2	309885	60140	A.18.1	332119	60636	H.14.1	355223	63598	N.30.7
288214	63367	J.2.3	310979	60859	E.2.4	332119	60636	J.6.1	355708	62014	B.3.1
288649	61708	H.8.1	310980	60860	E.2.4	332119	60636	M.5.2	356942	62321	I.48.7
289336	60547	H.12.3	311755	62032	J.8.4	332738	60405	A.18.1	357363	60564	A.16.1
289445	60196	O.1.1	312217	60706	A.29.10	332738	60405	C.9.1	357402	60347	A.33.3
291826	63627	A.8.4	312218	60707	A.29.10	336590	62319	J.10.3	358404	64074	C.3.4
292811	63148	A.8.7	312219	60708	A.29.11	336979	61363	I.48.5	360247	65248	N.30.1
293853	63470	A.13.19	312221	60709	A.29.11	336980	61644	I.48.5	360719	60807	B.1.1
294270	64522/1	D.1.1	312222	60710	A.29.11	338395	62215	A.5.12	361243	62244	J.8.2
294271	64522	D.1.1	312223	60711	A.29.11	338643	61026	A.11.4	361481	65163	A.32.3
294904	63005	C.3.1	312646	61704	A.21.11	338643	61026	C.3.4	361993	62335	I.30.4
295297	62214	A.5.12	315022	61198	C.5.1	338706	60249	C.4.2	361994	62340	I.30.4
296538	61659	I.7.2	315060	60015	C.3.3	339129	64498	C.7.4	362257	61206	A.14.7
296538/A	61660	I.7.2	315085	65091	C.4.1	339130	63328	C.7.7	362385	60252	L.2.13

ALL THE COMPONENTS LISTED IN OUR CATALOGUE ARE NOT ORIGINAL, THOUGH PERFECTLY INTERCHANGEABLE. REFERENCE NUMBERS, EITHER ORIGINAL OR OF A DIFFERENT NATURE, ARE FOR INFORMATION PURPOSES ONLY. WHEN PLACING AN ORDER, PLEASE, ALWAYS USE COSIBO REFERENCE NUMBERS AND DO NOT MENTION THE ORIGINAL REFERENCE NUMBERS OF THE TRUCK MANUFACTURERS IN THE INVOICE TO VEHICLE OWNERS OR TO ANYBODY ELSE. THE CUSTOMER TAKES HIS OWN RESPONSIBILITY IF HE DOES NOT COMPLY WITH WHAT ABOVE.

Cross reference SCANIA - COSIBO

Replacing	COSIBO	Page	Replacing	COSIBO	Page	Replacing	COSIBO	Page	Replacing	COSIBO	Page
362778	60975	B.2.3	373472	60002	A.3.1	390359	61223	J.8.2	550469	63931	A.4.4
363712	65250	N.30.3	374338	61346	A.12.1	390533	61946	F.1.1	550520	60897	C.1.3
364791	61487	A.13.3	375086	61196	G.2.7	390684	64132	O.1.1	550527	60900	C.1.4
364792	61486	A.13.2	375087	61197	G.2.12	390784	61656	M.2.5	550533	64314	C.1.3
364833	60141	A.18.1	375527	63301	A.21.13	390918	63863	A.13.6	550534	61498	C.1.5
365015	61137	J.3.3	375903	62369	J.2.3	391555	61959	A.21.3	550537	63678	C.1.5
365162	63930	O.2.7	375904	62370	J.2.3	392099	61972	I.54.3	550539	60895	C.1.6
365484	61771/S	A.29.25	375905	62371	J.2.4	392100	61973	I.54.3	550550	63683	H.6.2
365485	60677	A.29.13	376116	62208	I.48.2	392204	60720	A.31.1	550553	63865	H.6.2
365486	60678	A.29.13	376243	62067	I.7.3	392309	61007	G.2.9	550567	65089	H.6.3
365487	60679	A.29.14	376283	64050	I.48.1	392309	61007/1	G.2.10	550577	64311	C.1.7
365488	61770/S	A.29.25	376284	64051	I.48.1	393107	61628	C.7.9	550578	64175	C.1.6
365489	60680	A.29.14	378264	61835	A.13.4	393108	61629	C.7.9	550722	60845	E.1.1
365490	60681	A.29.14	378299	61237	A.8.2	393151	60109	A.2.1	550730	60838	E.1.2
365491	60682	A.29.15	378480	63275	F.2.5	393932	62011	A.21.5	550731	60849	E.1.1
365863	61490	A.13.2	378613	64080	C.3.5	393950	61077	A.21.4	550732	60305	E.1.1
366006	61317	N.3.2	381235	64143	A.7.19	394768	62270	N.2.2	550806	65239	L.5.1
366547	61482	A.16.4	381918	60669	A.29.18	394769	62271	N.2.2	550807	65240	L.5.1
367326	61645	N.30.1	381919	60670	A.29.18	395634	62229	C.7.9	550808	65241	L.5.2
367624	65153	A.28.2	381920	60671	A.29.18	395635	62230	C.7.10	550813	62465	F.2.2
367761	61627	A.21.2	381921	60672	A.29.19	397946	65237	H.8.2	551350	63280	A.4.2
367762	62299	A.21.2	381922	60673	A.29.19	397956	60798	B.2.2	551351	63064	A.13.10
368033	61508	L.7.4	381923	60674	A.29.19	412080	63229	A.21.9	551355	63295	A.26.7
369276	61484	A.13.3	381924	60675	A.29.19	412080	63229	C.8.1	551356	63558	A.5.2
369291	60700	A.29.12	381925	60676	A.29.19	423730	65242	L.2.5	551363	63281	A.4.3
369292	60701	A.29.12	382983	63180	A.27.9	423736	62235	L.2.8	551365	60758	A.13.9
369293	60702	A.29.12	382985	63179	A.27.3	470391	63617	M.1.1	551369	63296	A.26.7
369295	60703	A.29.12	383523	63747	J.8.6	475110	62521	L.6.1	551370	60362	A.5.1
369296	60704	A.29.13	384464	60207	A.4.3	488368	63297	A.21.12	551386	65339	A.5.4
369297	60705	A.29.13	384595	65272	J.8.1	488372	66581/1	A.5.11	551387	65337	A.5.3
369375	61604	I.30.6	384970	63057	C.7.5	550044	61147	A.26.5	551438	60570	A.13.7
369477	63140	A.11.3	385159	62366	I.50.3	550154	63407	H.6.5	551449	60971	A.5.2
369478	61219	A.10.2	385266	61743	J.8.3	550167	61183	A.26.6	551450	61832	A.13.9
370074	61020	G.2.7	385840	62314	J.1.4	550195	60505	A.17.1	551456	60573	A.4.1
370075	61017	G.2.12	385997	60059	A.13.1	550206	61186	A.26.6	551469	60587	A.4.1
370875	61654	M.2.5	385998	60058	A.13.1	550247	63708	A.5.8	551470	60576	A.5.1
371211	65275	A.13.11	387775	61485	A.13.1	550257	65194	E.1.3	551476	61180	A.26.6
371453	61207	C.7.3	388305	65308	I.55.1	550268	65315	C.7.1	551477	64188	A.26.8
371497	65349	A.9.3	388306	65307	I.55.1	550269	63293	A.26.7	551484	60972	A.4.2
371503	60568	A.13.7	388402	61554	A.13.7	550282	64036	L.3.1	551512	61560	A.4.1
371780	65151	A.28.1	388528	61025	C.3.4	550283	64309	L.3.1	551516	60575	A.5.1
371781	60718	A.28.3	388536	62363	I.50.3	550284	65193	E.1.2	551519	61829	A.5.2
371910	62297	M.1.1	389035	65177	B.1.5	550343	61833	A.13.9	551520	64749	A.5.1
372981	63151	A.14.8	389035	65177	H.4.4	550446	60799	B.1.2	551528	65338	A.5.3
372983	65036	A.14.10	389500	62138	M.1.2	550453	60426	B.1.4	551560	64273	A.5.2
373210	63300	A.21.12	390358	61222	J.8.2	550464	62013	B.1.4	551570	64275	A.4.5

ALL THE COMPONENTS LISTED IN OUR CATALOGUE ARE NOT ORIGINAL, THOUGH PERFECTLY INTERCHANGEABLE. REFERENCE NUMBERS, EITHER ORIGINAL OR OF A DIFFERENT NATURE, ARE FOR INFORMATION PURPOSES ONLY. WHEN PLACING AN ORDER, PLEASE, ALWAYS USE COSIBO REFERENCE NUMBERS AND DO NOT MENTION THE ORIGINAL REFERENCE NUMBERS OF THE TRUCK MANUFACTURERS IN THE INVOICE TO VEHICLE OWNERS OR TO ANYBODY ELSE. THE CUSTOMER TAKES HIS OWN RESPONSIBILITY IF HE DOES NOT COMPLY WITH WHAT ABOVE.

Cross reference SCANIA - COSIBO

Replacing	COSIBO	Page	Replacing	COSIBO	Page	Replacing	COSIBO	Page	Replacing	COSIBO	Page
551573	64274	A.4.4	813932	64089	I.105.3	813938	64092	M.30.2	1105075	60665	A.29.17
552004	63898	F.5.2	813932	64089	O.2.2	813938	64092	O.2.3	1105076	60666	A.29.17
552004	63898	L.2.1	813933	64082	A.105.1	813939	64085	A.105.2	1105077	60667	A.29.18
561991	63994	A.5.10	813933	64082	C.50.1	813939	64085	C.50.1	1105078	60668	A.29.18
581025	62354	I.48.4	813933	64082	F.50.1	813939	64085	H.50.1	1105079	60657	A.29.15
581201	63739	I.7.11	813933	64082	H.60.1	813939	64085	I.105.2	1105080	60658	A.29.15
62259/1	62259/1	A.13.10	813933	64082	I.105.1	813939	64085	M.30.1	1105081	60659	A.29.16
63556/2	63556/2	L.2.1	813933	64082	L.60.1	813939	64085	O.2.2	1105082	60660	A.29.16
63556/2	63556/2	L.4.2	813933	64082	O.2.1	813940	64093	A.105.5	1105083	60661	A.29.16
63556/2	63556/2	L.6.4	813934	64090	A.105.4	813940	64093	B.50.2	1105084	60662	A.29.16
63556/2	63556/2	L.7.5	813934	64090	B.50.1	813940	64093	C.50.3	1105803	62334	J.1.4
639320	65243	L.6.1	813934	64090	C.50.2	813940	64093	H.50.3	1105971	60420	O.2.6
64498/2	64498/2	C.7.4	813934	64090	F.50.1	813940	64093	I.105.5	1106953	61657	I.7.1
716360	62245	J.8.2	813934	64090	H.50.2	813940	64093	L.60.2	1106955	61658	I.7.2
804578	64095	A.105.6	813934	64090	I.105.3	813940	64093	O.2.4	1108053	63303	A.13.30
804578	64095	B.50.2	813934	64090	L.60.1	813941	64086	A.105.3	1108488	62218	A.5.13
804578	64095	C.50.3	813934	64090	O.2.3	813941	64086	C.50.2	1109281	63607	A.13.17
804578	64095	I.105.5	813935	64083	A.105.1	813941	64086	H.50.2	1109288	61836	A.13.4
804578	64095	L.60.2	813935	64083	C.50.1	813941	64086	I.105.2	1109870	61023	A.10.2
804578	64095	M.30.3	813935	64083	H.50.1	813941	64086	M.30.2	1109871	60998	A.22.6
804578	64095	O.2.4	813935	64083	I.105.1	813941	64086	O.2.2	1111494	63084	A.31.2
804583	64100	A.105.6	813935	64083	L.60.1	813942	64094	A.105.5	1112539+	61529	H.4.3
804583	64100	C.50.3	813935	64083	O.2.1	813942	64094	C.50.3	1112540		
804583	64100	H.50.4	813936	64091	A.105.4	813942	64094	I.105.5	1112542	60413	H.4.1
804583	64100	I.105.6	813936	64091	B.50.1	813942	64094	O.2.4	1112829	63346	H.13.8
804583	64100	M.30.3	813936	64091	C.50.2	814195	64187	A.23.10	1112830	63347	H.13.9
804583	64100	O.2.5	813936	64091	F.50.1	814195	64187	N.31.2	1113031	64524	D.1.2
804589	64096	A.105.6	813936	64091	H.50.3	814209	61322	A.23.5	1113033	62041	D.1.1
804589	64096	H.50.4	813936	64091	I.105.4	814209	61322	N.31.1	1114838	63262	C.3.1
804589	64096	I.105.6	813936	64091	L.60.2	814210	60484	A.23.5	1116635	60415	A.7.7
804591	64101	A.105.7	813936	64091	M.30.2	814210	60484	N.31.1	1116698	61585	F.2.7
804591	64101	H.50.4	813936	64091	O.2.3	815454	63068	H.5.5	1116699	61587	F.2.7
804591	64101	I.105.6	813937	64084	A.105.2	815457	63071	H.5.6	1116847	61640	F.2.4
804591	64101	O.2.5	813937	64084	B.50.1	815458	63073	H.5.6	1116848	61586	F.2.6
804658	63338	C.6.7	813937	64084	C.50.1	815459	63074	H.5.6	1116987	62108	A.1.2
804670	64790	A.28.5	813937	64084	H.50.1	1100867	61199	A.5.9	1117253	62249	N.30.8
804670	64790	C.7.14	813937	64084	I.105.1	1102585	62231	C.7.10	1117285	60455	A.14.11
804670	64790	E.1.3	813937	64084	L.60.1	1103619	61764	B.2.1	1118446	61506	L.7.3
804670	64790	L.8.1	813937	64084	M.30.1	1103619	61764	C.3.2	1118884	61903	J.8.15
804672	63337	C.6.7	813937	64084	O.2.1	1103635	61531	H.3.2	1120873	64164	G.2.11
804782	60543	H.40.4	813938	64092	A.105.5	1103934	62461	B.2.1	1120880	61493	B.1.6
808214	61352	B.1.6	813938	64092	B.50.2	1103934	62461	C.3.2	1120881	61350	B.1.6
811911	61314	L.2.10	813938	64092	C.50.2	1104213	63757	H.13.3	1120884	61344	B.1.5
813245	64182	O.1.2	813938	64092	H.50.3	1104500	65214	G.2.4	1121763	62033	J.8.5
813932	64089	A.105.3	813938	64092	I.105.4	1105073	60663	A.29.17	1122620	61109	A.2.4
813932	64089	H.50.2	813938	64092	L.60.2	1105074	60664	A.29.17	1122696	61548	A.32.1

ALL THE COMPONENTS LISTED IN OUR CATALOGUE ARE NOT ORIGINAL, THOUGH PERFECTLY INTERCHANGEABLE. REFERENCE NUMBERS, EITHER ORIGINAL OR OF A DIFFERENT NATURE, ARE FOR INFORMATION PURPOSES ONLY WHEN PLACING AN ORDER, PLEASE, ALWAYS USE COSIBO REFERENCE NUMBERS AND DO NOT MENTION THE ORIGINAL REFERENCE NUMBERS OF THE TRUCK MANUFACTURERS IN THE INVOICE TO VEHICLE OWNERS OR TO ANYBODY ELSE. THE CUSTOMER TAKES HIS OWN RESPONSIBILITY IF HE DOES NOT COMPLY WITH WHAT ABOVE.

Cross reference SCANIA - COSIBO

Replacing	COSIBO	Page	Replacing	COSIBO	Page	Replacing	COSIBO	Page	Replacing	COSIBO	Page
1300043	65187	C.8.4	1309563	61643	C.6.4	1326935	62341	I.56.3	1342745	64260	H.12.2
1300097	65183	C.7.11	1312934	61632	A.7.2	1327015	64134	J.3.3	1342746	64261	H.12.2
1300367	63097	A.33.7	1312934	61632	B.3.2	1327413	61651	G.2.3	1343100	65255	J.8.15
1300831	64683	N.1.9	1312934	61632	H.6.5	1328995	63549	A.7.4	1343156	60418	O.2.6
1301696	60434	F.2.1	1313325	60894	H.3.1	1329551	61993	I.51.1	1343178	61227	L.7.1
1302008	62030	J.8.4	1313326	60893	H.3.1	1329552	61992	I.51.1	1343262	64003	M.2.4
1302531	63992	A.29.25	1313592	61964	I.54.2	1331164	64049	J.4.1	1344182	61348	A.21.7
1302771	61974	I.54.4	1313594	61965	I.54.3	1331820	64778	A.21.16	1344190	62233	L.2.8
1302772	65390	I.54.4	1313606	63750	A.2.3	1331820	64778	C.1.8	1345492	62228	C.2.8
1302827	61837	A.7.2	1313677	63373/S	A.29.24	1331820	64778	F.2.5	1346119	64025	I.48.9
1302828	61631	A.7.1	1313681	63957	A.29.23	1332193	64648	A.22.2	1346177	64023	I.48.2
1302857	60957	H.13.12	1313682	63958	A.29.23	1332320	62035	I.54.2	1346178	64024	I.48.3
1302914	64098	B.3.4	1313683	63959	A.29.23	1332503	61536	A.12.1	1346181	64368	I.48.2
1303318	61988	I.51.1	1314406	61002	A.26.3	1332503	61536	H.4.1	1346425	62294	J.10.3
1303471	63055	C.2.5	1314653	62356	J.1.1	1332967	63408	A.13.11	1346601	62488	J.10.2
1303471	63055	F.4.1	1315376	63160	H.5.2	1332968	63409	A.13.11	1346606	66583	C.7.12
1303471	63055	N.40.1	1315377	63161	H.5.3	1332969	63410	A.13.11	1346608	66585	C.7.12
1303472	61953	C.2.4	1315559	63107	A.33.8	1332970	63411	A.13.12	1346612	66578/1	C.7.13
1303472	61953	F.4.1	1316331	63152	A.12.2	1332971	63412	A.13.12	1346905	63540	I.48.3
1303951	61746	A.29.20	1317538	61969	I.50.3	1333116	63413	A.13.24	1346906	63541	I.48.3
1303952	61747	A.29.20	1318306	63450	N.30.4	1334196	65278	N.30.3	1348117	60438	J.9.1
1303953	61748	A.29.20	1318388	63128	B.3.3	1335618	65088	A.33.1	1349045	61908	A.13.16
1303954	61749	A.29.20	1318388	63128	C.3.3	1335673	64315	A.16.7	1349045	61908	H.2.1
1303955	61750	A.29.20	1318506	64052	J.2.7	1335674	64009	A.16.6	1349089	64800	H.12.3
1303956	61751	A.29.21	1319557	63276	C.2.2	1336138	64278	A.13.6	1349497	63559	A.7.6
1303957	61752	A.29.21	1320292	61553	A.13.3	1336159	60810	B.1.4	1349810	60488	J.8.14
1303958	61753	A.29.21	1320457	62315	J.1.3	1336380	64165	G.2.11	1350317	65176	J.3.1
1304292	63372	A.5.7	1320602	65021	A.21.2	1336882	62040	A.18.2	1350343	63359	N.3.3
1304571	61923	M.2.1	1320973	63416	A.5.7	1336882	62040	C.9.1	1350394	64081	A.27.10
1304725	62223	A.12.1	1321259	61866	B.2.9	1337366	60861	E.2.3	1350440	64112	O.2.5
1304786	62523	N.2.3	1321727	64088	H.13.1	1337367	60862	E.2.3	1350441	64113	O.2.5
1304787	62420	N.2.3	1322341	62236	L.2.9	1338018	65226	H.40.3	1350817	61879	H.13.11
1305676	63389	C.6.2	1323400	62376	J.2.1	1338019	61153	H.13.13	1351692	64144	A.7.19
1305959	61834	A.8.2	1323401	62372	J.2.2	1338128	60343	A.33.1	1353142	62398	H.4.2
1306492	63620	J.4.1	1323410	62377	J.2.2	1340201	61869	A.27.2	1353142	62398	N.30.3
1306975	61728	I.48.6	1323823	61916	A.7.18	1340408	63567	B.1.7	1353735	62373	J.2.2
1306976	61729	I.48.6	1324366	62237	L.2.9	1340859	64065	H.12.1	1353959	65282	J.8.11
1307770	65155	A.28.3	1324597	61989	I.51.4	1340860	64064	H.12.1	1353965	65269	J.8.10
1307793	62227	B.2.6	1324598	61990	I.51.4	1340899	63781	A.13.13	1354103	64167	A.26.5
1307953	62217	A.5.13	1324663	62459	H.8.2	1341110	62486	J.10.2	1354420	63780	A.13.13
1308473	63600	N.1.7	1324712	65263	J.8.13	1341683	63846	B.2.9	1354428	63782	A.13.13
1308474	63599	N.1.7	1324713	65261	J.8.13	1341701	63675	A.29.22	1354593	62328	I.30.1
1308643	61933	M.2.1	1325265	61976	I.54.5	1341702	63676	A.29.21	1354594	62338	I.30.1
1308969	62226	B.2.6	1325266	61975	I.54.5	1341729	63602	A.27.4	1354979	63857	A.22.1
1309051	63547	A.13.6	1325383	64357	C.7.8	1342121	61530	H.3.1	1355353	63783	A.13.14
1309465	61519	H.40.3	1325626	65318	J.1.7	1342708	64301	G.2.10	1355655	63733	I.56.3

ALL THE COMPONENTS LISTED IN OUR CATALOGUE ARE NOT ORIGINAL, THOUGH PERFECTLY INTERCHANGEABLE. REFERENCE NUMBERS, EITHER ORIGINAL OR OF A DIFFERENT NATURE, ARE FOR INFORMATION PURPOSES ONLY WHEN PLACING AN ORDER, PLEASE, ALWAYS USE COSIBO REFERENCE NUMBERS AND DO NOT MENTION THE ORIGINAL REFERENCE NUMBERS OF THE TRUCK MANUFACTURERS IN THE INVOICE TO VEHICLE OWNERS OR TO ANYBODY ELSE. THE CUSTOMER TAKES HIS OWN RESPONSIBILITY IF HE DOES NOT COMPLY WITH WHAT ABOVE.

cosibo

40050 Castello d'Argile - Bologna - Italy
Via L.Einaudi, 11/C - Tel. +39 051 977831 - Fax commerciale +39 051 977590
www.cosibo.it



Cross reference SCANIA - COSIBO

Replacing	COSIBO	Page	Replacing	COSIBO	Page	Replacing	COSIBO	Page	Replacing	COSIBO	Page
1355667	64114	I.56.1	1367028	63085	A.8.3	1374413	63779	H.2.1	1378226	61716	A.8.2
1355703	64087	A.8.7	1367370	61858	L.2.12	1374500	64034	A.22.6	1378527	65073	J.1.2
1356372	62232	C.7.12	1367604	60789	B.2.3	1374642	62395	J.4.1	1378531	65074	J.1.2
1356668	62145	J.8.5	1368039	64111	J.8.10	1374700	63376	A.13.17	1378882	63593	N.30.6
1356677	63375	A.13.21	1368061	62490	A.5.5	1375228	63591	M.2.4	1378883	63594	N.30.7
1357380	66584	J.1.7	1368123	63438	N.3.1	1375369	63571	A.29.26	1379244	62239	J.8.10
1357381	66582	J.8.11	1368652	62307	I.54.2	1375370	63572	A.29.26	1379384	62269	N.3.4
1357599	60341	I.54.1	1368681	65310	L.7.8	1375371	63573	A.29.26	1379621	63844	C.7.13
1357600	60340	I.54.1	1368682	65302	L.7.8	1375372	63574	A.29.27	1379922	64097	B.3.3
1357628+	64000	A.29.28	1368736	61759	A.7.11	1375373	63575	A.29.27	1380451	63377	A.13.17
1357633			1369053	62455	J.1.5	1375374	63576	A.29.27	1380814	64189	L.5.2
1358175	60517	N.30.1	1369553	64062	J.4.1	1375382	64723	G.2.14	1380819	60492	N.3.3
1358291	62375	J.2.5	1369975	64244	C.7.6	1375383	63114	A.9.2	1380880	65026	H.14.2
1358793	60522	E.2.2	1369981	60111	A.7.12	1375390	64721	M.5.1	1381235	62361	A.14.12
1358793	60522	F.5.1	1370107	62448	I.55.7	1375391	65359	M.5.1	1381235	62361	C.3.5
1358793	60522	M.2.3	1370108	62447	I.55.7	1375427	62444	N.4.2	1381235	62361	H.6.4
1358828	65273	J.8.1	1370141	64099	L.4.1	1375428	62443	N.4.2	1381479	62364	I.50.2
1360833	61477	A.1.5	1370254	61460	A.7.17	1375493	61936	A.28.3	1381480	62365	I.50.2
1360836	65336	A.1.2	1370329	62100	I.55.2	1375497	62406	J.1.1	1381565	62431	I.55.3
1361131	64070	H.8.3	1370330	62101	I.55.2	1375602	63192	A.24.4	1381566	62430	I.55.3
1361131	64070	L.6.1	1371201	62324/4	J.1.9	1375603	65150	A.27.8	1381926	61463	A.21.10
1361136	61961	B.1.3	1371209	63378	A.13.18	1375718	63175	A.21.11	1382071	63374/S	A.29.24
1361193	61473	A.1.1	1371292	61663	N.2.3	1375837	61005	A.26.1	1382072	63954	A.29.22
1361196	61475	A.1.1	1371293	61664	N.2.3	1375838	64645	A.26.5	1382073	63955	A.29.22
1361983	60346	A.33.3	1371754	63918	I.50.4	1375839	63856	A.26.3	1382074	63956	A.29.23
1362708	62308	I.54.1	1371757	62311	I.50.1	1376226	65128	A.27.4	1382075	63991	A.29.24
1362710	61859	L.2.12	1371758	62312	I.50.1	1376279	61831	H.5.5	1382113	60506	A.17.1
1362721	61152	H.13.13	1371839	62512	A.21.17	1376280	61830	H.5.4	1382727	62429	I.55.4
1363131	62276	J.3.2	1371839	62512	H.6.5	1376895	65131	A.27.5	1382728	62428	I.55.4
1363634	60479	A.21.3	1371839	62512	J.2.6	1376896	65133	A.27.6	1382827	62211	J.9.2
1364140	62111	L.2.19	1372154	63764	H.14.2	1376949	65145	A.27.8	1383496	64067	J.8.8
1364290	63778	A.33.6	1372155	63765	H.14.2	1377231	63601	A.27.3	1383520	62256	I.52.3
1364636	63755	C.2.2	1372174	64382	I.56.4	1377231	63601	C.8.2	1383609	62280	I.50.1
1364665	62441	I.52.1	1372432	62243	J.8.11	1377331	65144	A.27.8	1383858	61907	I.54.6
1364666	62440	I.52.1	1372444	60630	A.30.1	1377386	63759	C.7.6	1383873	65134	A.27.6
1365968	61661	N.2.2	1372510	61710	J.8.16	1377562	60482/T	J.8.7	1383887	62412	I.50.2
1365969	61662	N.2.2	1372786	65300	L.7.9	1377566	62478	C.8.3	1383888	62413	I.50.2
1366141	63800	I.7.10	1373126	64777	A.21.15	1377567	62479	C.8.4	1383990	65135	A.27.6
1366384	62275	I.50.2	1373127	64352	A.2.4	1377571	61174	A.26.3	1384551	61844	A.9.1
1366735	62537	J.10.2	1373520	66579/1	A.22.5	1377692	65028	L.2.20	1384552	60565	A.16.1
1366764	64026	I.48.9	1373919	65125	A.27.4	1377728	60912	L.2.13	1384554	61921	A.16.2
1366781	62536	J.10.2	1374040	65129	A.27.4	1377739	63556/1	L.2.1	1384555	61922	A.16.3
1366849	61607	I.48.7	1374040	65129	C.8.2	1377739	63556/1	L.4.1	1384624	60754	C.7.1
1366850	62343	I.48.7	1374083	61878	H.5.2	1377739	63556/1	L.6.3	1384897	60907	C.7.2
1366851	62422	J.10.4	1374326	64022	A.9.2	1377739	63556/1	L.7.4	1384898	60908	C.7.3
1367027	63804	A.8.4	1374334	65353	A.11.2	1377799	61550	L.2.2	1385086	65142	A.27.7

ALL THE COMPONENTS LISTED IN OUR CATALOGUE ARE NOT ORIGINAL, THOUGH PERFECTLY INTERCHANGEABLE. REFERENCE NUMBERS, EITHER ORIGINAL OR OF A DIFFERENT NATURE, ARE FOR INFORMATION PURPOSES ONLY. WHEN PLACING AN ORDER, PLEASE, ALWAYS USE COSIBO REFERENCE NUMBERS AND DO NOT MENTION THE ORIGINAL REFERENCE NUMBERS OF THE TRUCK MANUFACTURERS IN THE INVOICE TO VEHICLE OWNERS OR TO ANYBODY ELSE. THE CUSTOMER TAKES HIS OWN RESPONSIBILITY IF HE DOES NOT COMPLY WITH WHAT ABOVE.

Cross reference SCANIA - COSIBO

Replacing	COSIBO	Page	Replacing	COSIBO	Page	Replacing	COSIBO	Page	Replacing	COSIBO	Page
1385170	60490	J.8.7	1391831	64687	C.7.8	1406613	61606	I.48.5	1431920	64661	N.4.3
1385402	62387	N.1.5	1392708	64351	A.11.3	1406614	62195	I.48.6	1431921	64660	N.4.3
1385403	62388	N.1.5	1392755	64053	J.2.7	1409551	65178	B.1.5	1431922	64657	N.4.4
1385406	62358	N.1.4	1392929	65119	A.14.1	1409551	65178	H.4.4	1431923	64656	N.4.4
1385407	62359	N.1.4	1392930	60973	A.16.2	1409890	60993	G.2.8	1431925	62432	I.51.3
1385409	65377	N.1.9	1392931	60969	A.16.1	1411129	63963	H.6.6	1431926	62433	I.51.3
1385410	60511	N.2.1	1392932	61842	A.9.1	1411774	63753	H.2.1	1431931	64704	I.52.2
1385413	65375	N.1.8	1392933	65345	A.9.2	1411851	63853	A.8.4	1431932	64707	I.52.2
1386104	62466	L.7.7	1392935	61230	A.10.1	1412265	60023	N.1.9	1431933	64698	I.52.1
1386227	63997	L.7.8	1394544	60482	J.8.3	1412265	60023	N.3.2	1431934	64699	I.52.2
1386271	63356	N.3.2	1394884	63585	M.2.2	1412398	63786	A.22.1	1431979	63926	A.24.2
1386272	63357	N.3.1	1395066	65137	A.27.7	1412666	61552	A.13.8	1433110	63154	A.21.11
1386423	61648	J.8.16	1395248	63619	A.13.19	1413047	60375	C.2.3	1433183	63767	A.10.3
1386424	64206	J.8.16	1395276	61966	I.54.6	1413146	62389	I.48.9	1433190	64358	A.16.8
1386452	61856	B.2.5	1395994	64509	J.2.6	1414422	63855	A.8.5	1433190	64358	H.4.4
1386453	63307	B.2.7	1396529	62399	I.7.4	1420776	62489	A.8.3	1433641	61204	A.13.28
1386454	63308	B.2.7	1396530	62400	I.7.5	1420908	64346	A.23.8	1433656	62456	J.1.5
1386571	65317	J.1.7	1396541	63801	I.7.11	1420911	63968	A.23.8	1434134	63644	J.3.4
1386647	65334	A.1.3	1396542	62379	I.7.11	1421021	62403	A.16.5	1434135	62295	J.3.2
1386648	65335	A.1.3	1397273	63094	A.33.4	1421599	65296	H.6.1	1435856	62267	J.9.1
1386753	65206	L.7.9	1397521	60014	A.1.2	1421825	63193	A.24.4	1435859	61368	J.9.3
1386957	62281	I.55.5	1397570	61971	I.50.1	1422198	63784	A.13.13	1437296	64277	A.16.4
1386959	62446	I.55.6	1397571	62305	I.50.3	1422200	63785	A.13.13	1437727	61208	C.7.3
1386960	62445	I.55.6	1399180	63852	L.5.1	1422474	63323	A.33.8	1438563	64659	N.4.4
1387155	60512	N.2.1	1400209	62234	N.1.3	1422564	63322	A.29.1	1438564	64658	N.4.5
1387547	64375	A.16.7	1400213	61991	I.51.4	1422701	61608	H.14.1	1438902	60436	H.4.1
1387764	64633	D.1.2	1400769	65233	H.4.2	1424074	64028	A.32.3	1439788	64663	I.51.1
1387794	64634	D.1.2	1401789	63467	N.30.5	1424227	62266	J.9.1	1439789	64662	I.51.2
1387983	60556	A.33.5	1401839+	62534	A.32.2	1424231	62296	J.9.2	1439814	65313	A.13.22
1388070	63929	A.21.8	1398636			1424970	64184	N.30.2	1439822	64017	A.21.9
1388070	63929	B.8.1	1401840+	62535	A.32.3	1425019	62390	M.1.1	1440108	62291	I.55.10
1388070	63929	H.6.6	1482500			1425659	64369	I.48.2	1440113	62292	I.55.10
1388678	60206	A.8.1	1401929	62310	I.50.1	1426194	65136	A.27.7	1440359	63550	A.5.8
1388680	65001	A.11.1	1401931	63917	I.50.4	1426449	65192	C.1.2	1440364	62539	J.7.3
1388681	60589	A.11.1	1401982	63083	A.8.3	1427670	61955	A.28.5	1440365	62525	J.7.2
1388682	60567	A.10.1	1401984	63854	A.8.5	1427794	63938	J.1.3	1440367	62538	J.7.2
1388684	61762	A.7.5	1402400	61909	A.7.18	1428892	60432	A.33.5	1440370	62474	J.7.1
1390074	62339	I.30.1	1402448	65249	N.30.2	1430545	63646	J.8.15	1440371	62473	J.7.2
1390075	62327	I.30.1	1402449	63809	N.30.2	1431199	64117	L.7.8	1440406	64649	A.22.5
1390705	65325	A.22.2	1403258	60970	A.3.2	1431701	64016	A.16.8	1440407	65319	A.22.6
1390706	62553	A.22.1	1403587	60003	A.3.1	1431701	64016	H.4.3	1441235	62522	C.7.4
1390747	62442	I.54.7	1403609	66606	H.3.3	1431781	63447	A.12.2	1442292	63913	I.48.8
1391386	61852	H.5.4	1403823	63896	A.1.7	1431781	63447	C.2.5	1442293	63914	I.48.9
1391425	62472	J.7.1	1403883	64307	A.26.2	1431781	63447	H.8.2	1442294	65365	I.48.8
1391426	62471	J.7.1	1403954	62313	A.21.10	1431781	63447	J.3.1	1442295	65366	I.48.8
1391830	64688	C.7.9	1405979	63440	N.31.1	1431781	63447	N.30.4	1442653	64702	I.30.2

ALL THE COMPONENTS LISTED IN OUR CATALOGUE ARE NOT ORIGINAL, THOUGH PERFECTLY INTERCHANGEABLE. REFERENCE NUMBERS, EITHER ORIGINAL OR OF A DIFFERENT NATURE, ARE FOR INFORMATION PURPOSES ONLY. WHEN PLACING AN ORDER, PLEASE, ALWAYS USE COSIBO REFERENCE NUMBERS AND DO NOT MENTION THE ORIGINAL REFERENCE NUMBERS OF THE TRUCK MANUFACTURERS IN THE INVOICE TO VEHICLE OWNERS OR TO ANYBODY ELSE. THE CUSTOMER TAKES HIS OWN RESPONSIBILITY IF HE DOES NOT COMPLY WITH WHAT ABOVE.

Cross reference SCANIA - COSIBO

Replacing	COSIBO	Page	Replacing	COSIBO	Page	Replacing	COSIBO	Page	Replacing	COSIBO	Page
1442654	64703	I.30.3	1472738	64304	F.4.1	1502384	63330	F.2.1	1522464	62487	J.10.3
1442706	63712	I.7.3	1472738	64304	N.40.1	1502385	63345	F.2.1	1523410	60017	A.1.5
1444016	64061	J.9.3	1472739	63677	C.2.5	1502468	64741	J.9.4	1523508	64674	I.51.2
1444822	65501	F.2.2	1472739	63677	N.40.1	1502798	64137	A.7.6	1523509	64675	I.51.2
1444941	63565	A.3.2	1472771	63845	C.7.14	1504019	62484	J.10.1	1523607	63987	I.54.10
1445398	63321	A.21.8	1474732	63332	C.6.3	1504020	62485	J.10.1	1523608	63988	I.54.10
1446581	65373	N.1.6	1475750	64178	N.30.5	1504131	62434	I.51.2	1524337	62477	J.1.6
1446582	65374	N.1.6	1475868	63139	A.18.2	1504608	60501	N.3.3	1525145	65092	A.21.14
1446583	62278	N.1.4	1476415	62322	J.9.3	1504609	60500	N.3.3	1525888	63363	J.2.4
1446584	62279	N.1.4	1477867	61305	L.2.7	1505366	65342	A.8.5	1525889	63364	J.2.4
1448110	61163	H.13.4	1478450	61745	A.32.1	1505748	64742	A.33.4	1525890	63362	J.2.4
1448111	61166	H.13.5	1481301	63864	A.32.1	1505749	65361	A.33.5	1525891	63761	J.2.5
1448112	61167	H.13.5	1481371	64060	J.4.1	1508533	60633	A.26.1	1525892	62374	J.2.5
1448113	61168	H.13.8	1482078	64747	I.51.5	1508534	60634	A.26.2	1525988	60836	C.4.2
1448114	61257	H.13.6	1482079	64745	I.51.5	1509813	64232	A.7.9	1525988	60836	D.1.3
1448115	61169	H.13.5	1482080	64746	I.51.5	1510490	60060	A.26.1	1525988	60836	E.2.5
1448117	63792	H.13.8	1482997	63327	C.7.6	1510575	65098	A.33.4	1525988	60836	F.2.3
1449431	65130	A.27.5	1483281	64665	A.33.4	1511832	65320	A.22.4	1525988	60836	H.6.7
1449542	65343	A.8.6	1484076+	64171	I.7.12	1512423	64700	I.30.2	1526569	62324/1	J.1.8
1452542	64354	H.14.2	1484078			1512424	64701	I.30.2	1526571	62324/2	J.1.8
1452862	63847	A.12.2	1484076+	64172	I.7.13	1513717	62012	B.1.2	1526573	62324/5	J.1.9
1452862	63847	N.30.8	1484079			1513719	65368	B.2.8	1527743	63123	C.1.2
1459004	60569	A.13.8	1484081	64174	I.7.12	1514086	63292	A.23.3	1527913	64378	A.2.2
1459133	64691	I.50.5	1484765	63554	A.7.4	1514087	63384	A.23.3	1528991	62460	F.2.2
1459134	64692	I.50.5	1484765	63554	C.1.7	1514089	66580/1	C.7.13	1529007	65143	A.27.8
1459135	64693	I.50.5	1484766	63555	A.7.5	1514093	62264	I.51.4	1529070	62261	N.1.2
1459141	64694	I.50.7	1484766	63555	C.1.8	1514505	61324	J.8.10	1529071	62262	N.1.3
1459142	64695	I.50.7	1484808	62469	C.6.1	1515117	63110	C.7.7	1529552	65246	I.54.11
1459145	64696	I.50.5	1484809	62470	C.6.1	1515118	63112	C.7.7	1529886	64345	I.30.6
1459146	64362	I.50.7	1485485	62344	I.54.6	1515190	62250	I.51.3	1530783	64374	A.22.4
1460812	63109	E.2.5	1485486	62345	I.54.7	1515194	62415	I.30.5	1535045	62353	I.30.7
1460812	63109	F.1.1	1485717	63326	C.7.5	1515195	62414	I.30.5	1535049	68888	I.30.6
1461414	64071	C.4.1	1486148	64647	A.22.3	1515869	63334	C.6.4	1535052	64104	I.30.8
1466031	64676	I.50.4	1486634	62382	A.11.4	1515870	63344	C.6.6	1535698	61366	B.2.6
1466032	64677	I.50.4	1488066	63604	J.3.3	1516474	62542	A.16.3	1535698	61366	C.8.3
1466382	64197	A.5.10	1488067	62520	J.3.1	1516496	62491	L.4.1	1536304	65191	A.12.3
1466383	64226	A.7.8	1488083	60304	C.2.1	1517649	63961	I.55.14	1536304	65191	C.2.3
1468555	63933	A.3.3	1488658	64751	A.5.3	1517650	63960	I.55.14	1536304	65191	E.3.1
1471237	60101	A.2.1	1495692	63187	J.5.2	1520867	64102	J.10.1	1536304	65191	F.10.1
1471599	62300	I.30.7	1496288	60435	A.18.2	1521209	60018	A.1.6	1536304	65191	H.8.1
1472142	63333	C.6.3	1496659	63962	I.35.1	1521210	62105	A.1.6	1536304	65191	J.6.2
1472144	63331	C.6.2	1497013	62336	A.33.1	1521553	62518	H.14.1	1536304	65191	L.6.2
1472145	63335	C.6.5	1498102	64639	N.3.5	1521554	65328	H.14.2	1536304	65191	N.40.1
1472718	63339	C.6.6	1498103	64640	N.3.5	1522011	65002	A.21.13	1536307	62342	J.6.1
1472738	64304	C.2.4	1500455	63093	A.33.2	1522013	61187	A.7.7	1536307	62342	L.6.2
1472738	64304	E.3.1	1502384	63330	C.5.2	1522377	60155	B.1.1	1536807	62481	I.50.6

ALL THE COMPONENTS LISTED IN OUR CATALOGUE ARE NOT ORIGINAL, THOUGH PERFECTLY INTERCHANGEABLE. REFERENCE NUMBERS, EITHER ORIGINAL OR OF A DIFFERENT NATURE, ARE FOR INFORMATION PURPOSES ONLY. WHEN PLACING AN ORDER, PLEASE, ALWAYS USE COSIBO REFERENCE NUMBERS AND DO NOT MENTION THE ORIGINAL REFERENCE NUMBERS OF THE TRUCK MANUFACTURERS IN THE INVOICE TO VEHICLE OWNERS OR TO ANYBODY ELSE. THE CUSTOMER TAKES HIS OWN RESPONSIBILITY IF HE DOES NOT COMPLY WITH WHAT ABOVE.

Cross reference SCANIA - COSIBO

Replacing	COSIBO	Page	Replacing	COSIBO	Page	Replacing	COSIBO	Page	Replacing	COSIBO	Page
1537675	62282	I.55.5	1722828	64007	A.33.10	1744210	63361	J.8.9	1775964	65311	A.13.24
1538384	62483	I.55.9	1723518	64170	I.7.7	1744211	63927	J.8.9	1775965	65312	A.13.23
1538385	62482	I.55.10	1723518+	64245	I.7.5	1745449	63171	A.24.1	1779120	64708	I.30.3
1539231	60279	G.2.1	1732782			1746135	64142	A.7.8	1779121	64709	I.30.3
1539675	64145	A.5.11	1723519	64169	I.7.6	1746684	61483	A.16.2	1780108	63873	J.8.9
1539870	62496	I.56.2	1724264	62532	I.50.6	1746684	63862	A.13.5	1781929	64072	J.8.15
1539871	62550	I.56.2	1725112	64306	A.4.5	1747894	62089	B.1.2	1785076	63546	A.1.3
1540425	63355	M.1.2	1725663	63965	I.54.10	1747895	60808	B.1.1	1785531	62384	I.54.11
1541106	63882	J.2.1	1725664	63964	I.54.11	1747981	64653	N.2.1	1786692	64672	N.1.2
1541367	63920	A.13.15	1725671	64650	I.54.7	1748085	64697	I.50.5	1786693	64673	N.1.2
1541368	63921	A.13.15	1725672	64651	I.54.8	1749034	60986	G.2.13	1789305	64001	I.48.1
1541549	65122	C.8.2	1725675	64643	I.54.8	1749123	65332	B.2.7	1789306	64002	I.48.1
1541653	63354	M.1.1	1725676	64644	I.54.8	1749953	62285	I.56.5	1789522	64123	A.26.4
1541982	62457	J.1.5	1726130	64068	L.2.2	1753479	63569	B.3.2	1789560	63348	H.13.9
1541983	62458	J.1.6	1727263	64678	I.50.6	1754546	60866	L.7.3	1789561	63349	H.13.9
1541984	63942	J.1.3	1727264	64679	I.50.6	1754943	63885	B.1.3	1789562	63350	H.13.10
1542104	65344	A.8.6	1727991	64655	N.4.2	1755594	62480	I.50.4	1789567	63894	H.13.10
1542159	61790	H.5.3	1727992	64654	N.4.3	1755638	64152	J.8.12	1789568	63893	H.13.11
1543608	64207	I.55.11	1731130	64177	N.30.8	1755952	62221	A.24.3	1790071	64356	A.27.9
1543609	64208	I.55.11	1731206	64664	I.51.1	1756460	64122	B.1.3	1790071	64356	J.1.10
1543634	62255	N.4.1	1732322	64344	I.30.6	1757877	61348	D.2.3	1791152	63545	A.1.4
1543635	62254	N.4.1	1732507	63915	N.1.5	1757877	61348	F.2.6	1792374	64252	N.3.5
1543688	62519	A.7.11	1732508	63916	N.1.6	1757877	64397	A.21.7	1792375	64253	N.3.5
1543731	63446	N.30.6	1732509	62258	N.1.3	1759690	63589	M.2.3	1792387	64641	N.3.4
1544330	62347	I.48.4	1732510	62257	N.1.3	1759691	63587	M.2.2	1792388	64642	N.3.4
1544331	62348	I.48.4	1732515	62404	N.1.5	1761195	62552	G.2.2	1794440	64801	H.13.4
1545062	63117	B.2.4	1732776	63369	I.7.4	1762623	62529	A.21.6	1794725	65099	A.21.14
1545116	65132	A.27.5	1732778	63370	I.7.4	1762624	62528	A.21.6	1794745	64690	A.13.23
1545149	64006	A.33.9	1732782	63797	I.7.9	1763776	60632	A.29.1	1795583	62274	A.21.7
1545478	61707	A.13.25	1732783	63860	I.7.10	1764885	62290	A.21.1	1795583	62274	J.8.11
1545479	63414	A.13.23	1732855	64350	I.54.9	1764886	62260	A.21.1	1797424	60238	D.2.1
1548054	61313	L.2.3	1732856	64349	I.54.9	1765061	60994	G.2.9	1797425	60239	D.2.2
1548055	64726	L.2.4	1733735	64355	A.27.9	1765382	64186	M.2.5	1797431	60790	B.2.4
1548318	64686	C.7.8	1736562	64166	G.2.12	1765974	65340	A.4.6	1797845	63867	C.8.4
1548504	62475	J.2.7	1737306	64246	B.3.1	1767631	62533	I.50.8	1800521	63639	A.23.6
1549330	64347	A.31.1	1738098	64027	J.5.2	1768269	65262	J.8.12	1800523	65095	A.23.9
1549482	64008	A.26.4	1738379	64343	E.2.2	1768402	60434	C.1.1	1800527	63934	A.23.9
1549495	64312	C.1.3	1738379	64343	F.5.1	1768898	61119	M.2.1	1800527	63934	J.5.1
1549737	64711	J.1.7	1738379	64343	M.2.4	1769452	62407	I.56.2	1800535	64121	A.23.7
1549738	62357	J.1.6	1738380	60521	E.2.1	1769522	65360	A.22.3	1800538	60129	A.23.5
1549739	65316	J.1.4	1738380	60521	F.5.1	1769597	63306	M.2.2	1800539	63967	A.23.7
1549740	62346	J.1.1	1738380	60521	M.2.3	1769798	61194	A.14.2	1800871	64740	A.33.2
1549741	64110	J.1.2	1740992	61297	G.2.6	1769799	61193	A.14.1	1801529	61476	A.1.4
1671745	63649	A.13.19	1742265	62531	I.50.7	1769800	61902	A.14.3	1801737	61838	A.13.5
1720924	62476	J.1.6	1742449	65326	J.8.13	1770301	62524	I.30.4	1803333	63640	A.23.6
1722694	64722	J.2.6	1742920	63866	J.2.1	1770301	62524	N.2.4	1803335	62437	A.23.8

ALL THE COMPONENTS LISTED IN OUR CATALOGUE ARE NOT ORIGINAL, THOUGH PERFECTLY INTERCHANGEABLE. REFERENCE NUMBERS, EITHER ORIGINAL OR OF A DIFFERENT NATURE, ARE FOR INFORMATION PURPOSES ONLY. WHEN PLACING AN ORDER, PLEASE, ALWAYS USE COSIBO REFERENCE NUMBERS AND DO NOT MENTION THE ORIGINAL REFERENCE NUMBERS OF THE TRUCK MANUFACTURERS IN THE INVOICE TO VEHICLE OWNERS OR TO ANYBODY ELSE. THE CUSTOMER TAKES HIS OWN RESPONSIBILITY IF HE DOES NOT COMPLY WITH WHAT ABOVE.

Cross reference SCANIA - COSIBO

Replacing	COSIBO	Page	Replacing	COSIBO	Page	Replacing	COSIBO	Page	Replacing	COSIBO	Page
1804034	64376	A.26.8	1869987	63618	A.16.6	1420197/1	60631/1	J.5.3			
1804064	60361	J.1.8	1869988	60367	A.16.5	1404924- 1916620	63172	A.24.2			
1804628	64364	I.50.7	1869993	60584	A.16.5						
1805399	64682	I.50.5	1870001	64058	A.16.7						
1805447	64105	I.30.8	1870689	62411	I.50.1						
1805603	65283	H.2.2	1871043	64103	A.5.9						
1849060	65394	A.24.1	1871043	64103	H.7.1						
1849428	64054	A.21.17	1872152	63766	A.16.6						
1849922	64750	A.5.3	1873014	62402	A.14.11						
1850567	62383	H.6.1	1873016	63886	A.30.2						
1850826	63922	A.13.15	1873018	62401	A.30.1						
1851213	62324/3	J.1.8	1873183	64033	G.2.1						
1851631	65331	B.2.5	1877664	62540	J.10.1						
1852113	62530	C.2.3	1879537	60237	D.2.1						
1852113	62530	J.3.4	1879541	61652	D.2.2						
1852569	62425	N.1.1	1888025	61461	A.7.17						
1852570	62424	N.1.1	1888464	63966	A.23.6						
1852572	62426	N.1.1	1888465	63969	A.23.7						
1852573	62427	N.1.2	1888468	64183	A.23.10						
1852817	61622	H.13.3	1888471	65094	A.23.9						
1853436	65186	C.2.4	1891445	60591	A.2.2						
1853436	65186	J.3.2	1892322	64668	N.1.8						
1853773	65279	A.13.20	1892324	64667	N.1.8						
1854058	62453	C.8.3	1893533	63680	I.56.5						
1856108	61906	H.13.4	1894408	62010	J.8.14						
1856472	64330	I.55.13	1894478	60359	A.21.16						
1856473	64329	I.55.13	1896605	65352	A.11.2						
1856474	64681	I.55.12	1897335	60985	E.2.1						
1856475	64680	I.55.12	1902328	63466	N.30.5						
1858884	64066	A.23.4	1902698	63465	N.30.4						
1858885	64251	A.23.4	1903797	64363	C.6.5						
1859654	63652	A.23.1	1907845	61851	G.2.10						
1859655	63858	A.23.1	1910437	64298	I.56.4						
1859656	64998	A.23.2	1910438	64299	I.56.4						
1859657	64185	A.23.2	1913500	64209	J.5.3						
1861118	63769	L.1.1	1913503	60631	J.5.3						
1862376	63548	A.7.3	1916864	64173	I.7.12						
1863896	63919	A.13.14	1919065	62527	C.7.5						
1863897	63923	A.13.16	1921972	62439	C.9.2						
1863898	63924	A.13.16	1923654	60481	J.8.14						
1864620	64373	J.2.1	1929397+	65379	B.2.8						
1865674	65370	A.13.10	1382331								
1865675	63120	A.13.8	2000390	62463	I.30.7						
1865749	63791	H.13.7	371780/1	65151/1	A.28.2						
1866391	65227	A.13.19	550567/2	65089/2	H.6.4						
1868087	64497	G.2.3	1349805/1	60481/1	J.8.14						

ALL THE COMPONENTS LISTED IN OUR CATALOGUE ARE NOT ORIGINAL, THOUGH PERFECTLY INTERCHANGEABLE. REFERENCE NUMBERS, EITHER ORIGINAL OR OF A DIFFERENT NATURE, ARE FOR INFORMATION PURPOSES ONLY WHEN PLACING AN ORDER, PLEASE, ALWAYS USE COSIBO REFERENCE NUMBERS AND DO NOT MENTION THE ORIGINAL REFERENCE NUMBERS OF THE TRUCK MANUFACTURERS IN THE INVOICE TO VEHICLE OWNERS OR TO ANYBODY ELSE. THE CUSTOMER TAKES HIS OWN RESPONSIBILITY IF HE DOES NOT COMPLY WITH WHAT ABOVE.

Since 1988, strength, agility and accuracy



Cosibo is specialised in the production and marketing of spare parts for heavy vehicles which are alternative and interchangeable with the original ones. In over twenty years of activity the Company has developed a business strength and a productive experience which today make it one of the most qualified reference points for the whole sector. A perfect knowledge of products, the total mastery of the technological processes, the great ability and agility in the management of commercial processes, make **Cosibo** one of the most reliable and competitive companies in its sector both in terms of products quality and promptness of action. In an industry, such as the one of heavy vehicles, where the evolution of the models, the technological innovation and the reliability of the products are the key for the success of the great manufacturers, the ability to innovate and update the range of available spare parts is an absolute and unavoidable value which has always been at the core of **Cosibo's** activity. Another competitive advantage has always been the managerial accuracy, the transparency of relationships and the understanding of the dynamics which rule the sector in the different markets. This advantage, over the years, has generated and consolidated the appreciation and diffusion of the **Cosibo** brand in each Country where the Company has decided to launch its activity. Supported by the verified effectiveness of its business strategy and of the choices made until today, **Cosibo** is currently offering a range of over 3,000 items for the vehicles of the main brands present on the market. **Cosibo** guarantees the absolute quality of the spare parts for vehicles of the following brands:

SCANIA • VOLVO • DAF • MERCEDES • IVECO • MAN • RENAULT

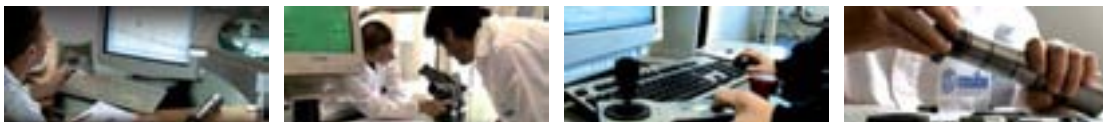

Cosibo certified quality for alternative spare parts



Cosibo S.p.A. 40050 Castello d'Argile · Bologna · Italy · Via L. Einaudi, 11/C
Tel. +39.051.977831 · Fax Sales Dept. +39.051.977590 · Fax Purchasing Dept/Production Dept. + 39.051.976515 · info@cosibo.it
www.cosibo.it · www.cosibo.com