



**C**ostruzione **E**miliana **I**ngranaggi



High Fidelity Spare Parts

2010  
2011

n°  
**902**

**Sterzo e Sospensione**  
*Steering and Suspension*



## Produzione e Innovazione Rigorosamente **Made in Italy**

La C.E.I. nasce nel lontano 1969 come costruttrice di ingranaggi per cambio e differenziale. In oltre 40 anni di storia abbiamo cercato di innovarci ed innovare i nostri prodotti mettendo sempre a frutto l'esperienza che deriva da anni spesi a studiare le problematiche costruttive di organi meccanici complessi.

I nostri stabilimenti produttivi ogni giorno lavorano tonnellate di materiale grezzo, modellandolo e trasformandolo sotto lo sguardo attento dei nostri tecnici, impegnati oggi come allora nella ricerca di una qualità paragonabile al ricambio originale ed in alcuni casi riuscendo perfino a migliorarla.

Il nostro impegno in tutti questi anni ci ha portato ad essere un'azienda leader nel settore ricambistico esportando i nostri prodotti in oltre 65 paesi toccando 5 continenti. Guardiamo ottimisti al futuro non dimenticando mai il nostro passato, pronti oggi più di ieri a raccogliere la sfida produttiva del nuovo millennio che siamo sicuri ci vedrà ancora protagonisti.

## Production and Innovation Strictly **Made in Italy**

C.E.I. was set up back in 1969 as a manufacturer of gearboxes and differential gears. In the 40 years and more of our existence we have tried to be innovative and to make our products innovative, making the most of our experience gained from years of studying the manufacturing problems of complex mechanisms.

Each day, our production facilities take tonnes of raw materials, shaping and transforming them under the watchful eyes of our technicians, committed now as in previous years to achieving a quality comparable to that of the original part and in some cases even managing to improve on it.

Throughout these years, our commitment has led us to be a leader in the spare parts sector and we export our products to over 65 countries across 5 continents. We look optimistically to the future, never forgetting our past, more ready than ever to take up the production challenge of the new millennium which we are sure will see us still with a part to play.

## Production et Innovation Rigoureusement **Made in Italy**

La Société C.E.I. a vu le jour en 1969 en tant que fabricant d'engrenages pour boîtes de vitesses et différentiels. En plus de 40 ans d'histoire, nous avons essayé de nous innover et d'innover nos produits en mettant toujours à profit l'expérience provenant d'années passées à étudier les problèmes liés à la construction d'organes mécaniques complexes.

Chaque jour, nos unités de production usinent des tonnes de matériau brut, le modelant et le transformant sous le regard attentif de nos techniciens, engagés aujourd'hui comme toujours dans la recherche d'une qualité comparable à la pièce de rechange d'origine et réussissant même dans certains cas à l'améliorer. Notre engagement tout au long de ces années nous a hissés à une position de leader sur le marché des pièces de rechange, grâce à l'exportation de nos produits dans plus de 65 pays des 5 continents. Nous regardons l'avenir avec optimisme sans jamais oublier notre passé, prêts aujourd'hui plus qu'hier à relever le défi du nouveau millénaire en matière de production, certains d'en être encore les protagonistes.

## Producción e innovación e **Made in Italy**

La empresa C.E.I. nació allá por el año 1969 como fábrica de engranajes para cajas de cambio y diferenciales. Llevamos más de 40 años procurando que la innovación caracterice a nuestra empresa y nuestros productos y aprovechando la experiencia adquirida durante los numerosos años que hemos dedicado al estudio de los problemas relacionados con la fabricación de componentes mecánicos complejos.

Nuestras fábricas elaboran diariamente toneladas de material bruto, moldeándolo y transformándolo bajo la mirada atenta de nuestros técnicos que, ahora como antaño, se dedican a asegurar un nivel de calidad comparable con el recambio original y que, en algunos casos, incluso la mejora.

Nuestra dedicación todo este tiempo nos ha convertido en una empresa líder en el sector de los recambios: exportamos nuestros productos a más de 65 países en 5 continentes. Miramos con optimismo hacia el futuro sin olvidar jamás el pasado y estamos cada vez más preparados para aceptar el reto productivo del nuevo milenio, en el que estamos seguros de que seguiremos siendo protagonistas.

**The Orange Way** Since 1969 Made in Italy

**Gearboxes/Trasmissioni**  
Boîtes à vitesses/Caja de Cambio

**CEI** 40<sup>th</sup> Anniversary 1969-2009 **Costruzione Emiliana Ingranaggi** Via Emilia 239 Anzola Emilia - Bologna ITALY  
HIGH FIDELITY SPARE PARTS [www.cei.it](http://www.cei.it) e-mail: [export@cei.it](mailto:export@cei.it)

**The Orange Way** Since 1969 Made in Italy

**Differential/Différentiel**  
Differenziale/Eje Diferencial

**CEI** 40<sup>th</sup> Anniversary 1969-2009 **Costruzione Emiliana Ingranaggi** Via Emilia 239 Anzola Emilia - Bologna ITALY  
HIGH FIDELITY SPARE PARTS [www.cei.it](http://www.cei.it) e-mail: [export@cei.it](mailto:export@cei.it)

**The Orange Way** Since 1969 Made in Italy

**Brake System/Componenti Freni**  
Système de Freinage/Sistema de Frenos

**CEI** 40<sup>th</sup> Anniversary 1969-2009 **Costruzione Emiliana Ingranaggi** Via Emilia 239 Anzola Emilia - Bologna ITALY  
HIGH FIDELITY SPARE PARTS [www.cei.it](http://www.cei.it) e-mail: [export@cei.it](mailto:export@cei.it)

**The Orange Way** Since 1969 Made in Italy

**Steering and Suspensions/Sterzo e Sospensioni**  
Volant et Suspensions/Dirección y Suspensión

**CEI** 40<sup>th</sup> Anniversary 1969-2009 **Costruzione Emiliana Ingranaggi** Via Emilia 239 Anzola Emilia - Bologna ITALY  
HIGH FIDELITY SPARE PARTS [www.cei.it](http://www.cei.it) e-mail: [export@cei.it](mailto:export@cei.it)





**HIGH FIDELITY SPARE PARTS**



# ELENCO CATALOGHI DISPONIBILI PER LE SEGUENTI GAMME DI NOSTRA PRODUZIONE

LIST OF THE AVAILABLE CATALOGUES FOR THE FOLLOWING PRODUCTION LINES  
LISTE DES CATALOGUES DISPONIBLES POUR LES GAMMES DE PRODUCTION SUIVANTES  
KATALOGE FÜR DIE FOLGENDEN PRODUKTION LINIEN  
LISTADO DE LOS CATALOGOS PARA LAS LINEAS SIGUIENTES



400.001 IVECO



400.025 DAF



400.050 MERCEDES



400.055 MAN



400.075 RENAULT V.I.



400.080 SCANIA



400.090 VOLVO



400.095 ZF Old Range



400.195 ZF Ecosplit



400.295 ZF Ecomid

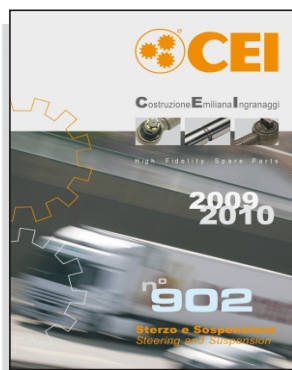

400.902 Ricambi  
Steering and Suspension



400.903 Ricambi  
Brake System and Engine





Figures part denominations references and data contained in this catalogue are not binding.  
CEI reserves the right to introduce any changes at any time without prior notice.

Le figure, le denominazioni, i riferimenti ed i dati contenuti nel presente catalogo non sono impegnativi.  
La CEI si riserva di apportare in ogni momento e senza preavviso tutte le variazioni che riterrà opportune.

Les figures, les dénominations, les références et les spécifications contenues dans ce catalogue ne sont pas engageantes.  
La CEI se réserve le droit d'apporter à tout moment et sans préavis les variations éventuelles qu'elle croit utiles.

Die in diesem Katalog enthalten Abbildungen, Benennungen Zeichen und Angaben sind unverbindlich.  
Die Firma CEI behält sich das Recht vor, jederzeit und ohne Viranzeige Änderungen vorzunehmen.

Las figuras, las denominaciones, las referencias y los datos contenidos en el presente catálogo no son empeñativos.  
CEI puede hacer en cada momento y sin preaviso todas las variaciones que sean oportunas.

#### **INTERCHANGEABILITY GUARANTY**

Our spare parts are interchangeable with the originals ones; our products bear our trade-mark.  
The original part numbers listed in this catalogue are for reference only.

#### **GARANZIA DI INTERCAMBIABILITÀ**

I nostri ricambi sono intercambiabili con gli originali; la nostra produzione riporta il nostro marchio.  
I riferimenti originali sono esposti a semplice titolo indicativo.

#### **GARANTIE D'INTERCHANGEABILITE**

Nos pièces détachées sont interchangeables avec les originaux.  
Nôtre production porte nôtre marque.  
Les numeros originaux mentionné dans ce catalogue sont seulement à titre indicatif.

#### **AUSTAUSCHBARKEITS-GARANTIE**

Unsere ersatzteile sind austauschbar mit den Originalzahnradern.  
Auf unseren Erzeugnissen ist unsere Schutzmarke aufgetragen.  
Die im gegenwärtigen Kalatolg genannten Originalnummern nur zum Hinweis dienen.

#### **GARANTIA DE INTERCAMBIABILIDAD**

Nuestros recambios son intercambiables con los originales.  
Todos nuestros productos, llevan grabada nuestra marca.  
Las referencias originales impresas en nuestro catalogo figuran exclusivamente a titulo indicativo.

---



**Tiranti Sterzo**

*Steering Rods*

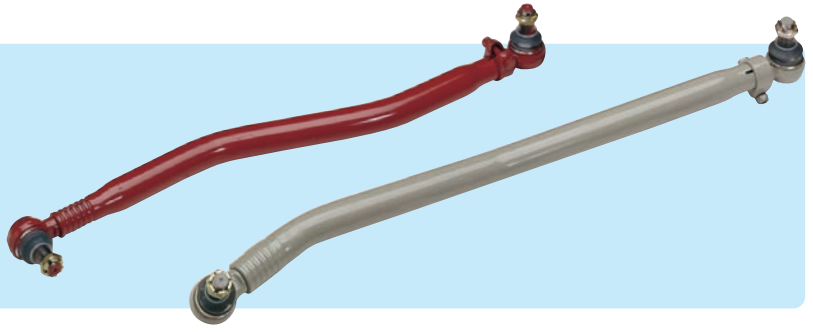

**Testine Sterzo**

*Steering Joints*

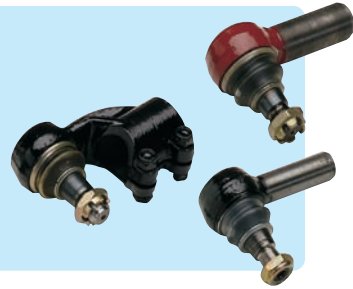

**Kit Perni Fusi**

*King Pin Sets*

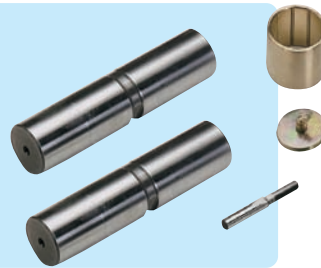

**Sospensione**

*Suspension*



**Torpress**

*Diapress*

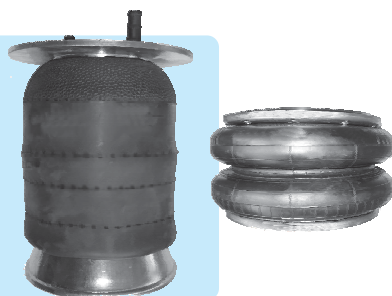



CEI no.  
**198.500**

O.E.M. Ref  
8558522  
8591222

Tubo / Tube Ø 30 mm

Lenght-L  
825 mm  
Lenght-L1  
780 mm



**Models OLD Range**

50 NC - 55 NC - 50.8 - 50.9 - 50.10 - 55.8 - 55.9 - 55.10 - 60.8 - 60.10 - 60.11 -  
65.10 - 70.10 - 79.10 - 79.13 - 79.14 - 80.13 - 83.10 - 90.12 - 90.13

OM50 - OM55 / MAGIRUS : 90D5.2FL/2FV/2FK/6FV/6FK

Note : In alternativa a / Alternative with : 198.595

Ball Joint



**198.475**

M24x1,5

CEI no.  
**198.595**

O.E.M. Ref  
8559559

Tubo / Tube Ø 30 mm

Lenght-L  
830 mm  
Lenght-L1  
780 mm



**Models OLD Range**

50 NC - 55 NC - 50.8 - 50.9 - 50.10 - 55.8 - 55.9 - 55.10 - 60.8 - 60.10 - 60.11 -  
65.10 - 70.10 - 79.10 - 79.13 - 79.14 - 80.13 - 83.10 - 90.12 - 90.13

OM50 - OM55 / MAGIRUS : 90D5.2FL/2FV/2FK/6FV/6FK

Note : In alternativa a / Alternative with : 198.500

Ball Joint



**198.475**

M24x1,5

CEI no.

198.501

O.E.M. Ref  
4665209

Lenght-L

Lenght-L1  
745 mm



<<< NESSUNA IMMAGINE - NO PICTURE >>>

**Models OLD Range**

100 NC - 110 NC - 110 PC  
OM110 - OM 110 PC

Veicoli con servosterzo - Truck with power-steering

Ball Joint



**198.496**

M25x1,5

CEI no.  
**198.526**

O.E.M. Ref  
61595957  
61591073  
61591070

Tubo / Tube Ø 38 mm

Lenght-L  
1020 mm  
Lenght-L1  
975 mm



**Models OLD Range**

100 NC - 110 NC - 110 PC  
OM110 - OM 110 PC

Veicoli con Cabina Ribaltabile - Truck with Tilting Cab

Ball Joint



**198.496**

M25x1,5

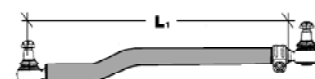
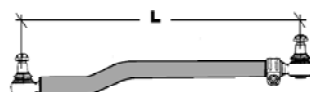



CEI no.  
**198.586**

O.E.M. Ref  
61595960  
61590824  
61590823

**Tubo / Tube Ø 38 mm**

Lenght-L  
1028 mm  
Lenght-L1  
978 mm

**Models OLD Range**  
130 NC/NR/NT  
OM 130

*Truck with Tilting Cab - Veicoli con Cabina Ribaltabile*



**Ball Joint**  
  
**198.480**  
M28x1,5

CEI no.  
**198.502**

O.E.M. Ref  
4665501  
4646452

**Tubo / Tube Ø 35 mm**

Lenght-L  
790 mm  
Lenght-L1  
740 mm

**Models OLD Range**  
130 NC/NR/NT  
OM 130

*Veicoli con Cabina Fissa - Truck with Fixed Cab*



**Ball Joint**  
  
**198.480**  
M28x1,5

CEI no.  
**198.588**

O.E.M. Ref  
61590910

**Tubo / Tube Ø 40 mm**

Lenght-L  
985 mm  
Lenght-L1  
935 mm

**Models OLD Range**  
150 NC17 - 150 NC20



<<< NESSUNA IMMAGINE - NO PICTURE >>>

**Ball Joint**  
  
**198.598**  
M30x1,5

CEI no.  
**198.503**

O.E.M. Ref  
4733752  
4666993

**Tubo / Tube Ø 48 mm**

Lenght-L  
904 mm  
Lenght-L1  
854 mm

**Models OLD Range**  
160 NC/NR/NT  
OM 160

*Guida Sinistra / Left Drive*



**Ball Joint**  
  
**198.498**  
M38x1,5

All original equipment manufacturers' numbers, symbols, pictures, models and description used in this catalogue are for reference only, and it is not implied that any part listed is the product of these manufactures. Tutti i nostri particolari non sono originali ma con essi intercambiabili. I riferimenti originali, le figure, i modelli sono esposti a semplice titolo indicativo. La nostra produzione riporta il nostro marchio.

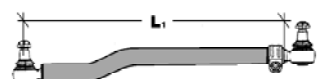
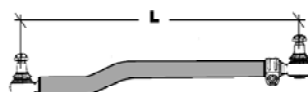



**CEI no.**  
198.504

**O.E.M. Ref**  
4733704  
4666991

**Tube / Tube Ø 46 mm**

**Lenght-L**  
910 mm  
**Lenght-L1**  
855 mm

**Models OLD Range**  
160 NC/NR/NT  
OM 160

*Guida Destra / Right Drive*



<<< NESSUNA IMMAGINE - NO PICTURE >>>

**Ball Joint**



**198.498**  
M38x1,5

**CEI no.**  
198.505

**O.E.M. Ref**  
4699246

**Tube / Tube Ø 46 mm**

**Lenght-L**  
970 mm  
**Lenght-L1**  
920 mm

**Models OLD Range**  
170 NC26/NT26/NC33/NT33/NC35/NT35  
190 NC26/NT26/NC33/NT33/NC35/NT35

*Guida Sinistra / Left Drive*



**Ball Joint**



**198.485**  
M38x1,5

**CEI no.**  
198.506

**O.E.M. Ref**  
4699305

**Tube / Tube Ø 46 mm**

**Lenght-L**  
970 mm  
**Lenght-L1**  
920 mm

**Models OLD Range**  
170 NC26/NT26/NC33/NT33/NC35/NT35  
190 NC26/NT26/NC33/NT33/NC35/NT35

*Guida Destra / Right Drive*



<<< NESSUNA IMMAGINE - NO PICTURE >>>

**Ball Joint**



**198.485**  
M38x1,5

**CEI no.**  
198.507

**O.E.M. Ref**  
4669091  
4520694

**Tube / Tube Ø 46 mm**

**Lenght-L**  
515 mm  
**Lenght-L1**  
460 mm

**Models OLD Range**  
180 N/NC/NT/NTS

*Assale Anteriore / Front Axle*



**Ball Joint**





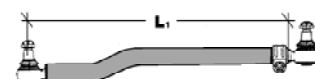
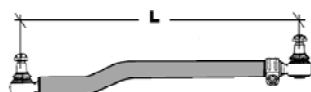

198.650  
M38x1,5



All original equipment manufacturers' numbers, symbols, pictures, models and description used in this catalogue are for reference only, and it is not implied that any part listed is the product of these manufacturers. Tutti i nostri particolari non sono originali ma con essi intercambiabili. I riferimenti originali, le figure, i modelli sono esposti a semplice titolo indicativo. La nostra produzione riporta il nostro marchio.

<p><b>CEI no.</b> <b>198.508</b></p> <p><b>O.E.M. Ref</b> 4669094 4520698</p> <p><b>Tubo / Tube Ø 46 mm</b></p>	<p><b>Lenght-L</b> 625 mm</p> <p><b>Lenght-L1</b> --</p> <p><b>Models <i>OLD Range</i></b> 180 N/NC/NT/NTS</p> <p><i>Assale Intermedio - Teste Fisse / Intermediate Axle - Fixed Ball Joint</i></p>	
---	---	--

<p><b>CEI no.</b> <b>198.521</b></p> <p><b>O.E.M. Ref</b> 4573092 4546822</p>	<p><b>Lenght-L</b> 885 mm</p> <p><b>Lenght-L1</b> 830 mm</p> <p><b>Models <i>OLD Range</i></b> 643 N/N1</p>	 <p>&lt;&lt;&lt; NESSUNA IMMAGINE - NO PICTURE &gt;&gt;&gt;</p>	<p><b>Ball Joint</b></p>  <p><b>198.480</b> M28x1,5</p>
---	---	---	---

<p><b>CEI no.</b> <b>198.502</b></p> <p><b>O.E.M. Ref</b> 4665501 4646452</p> <p><b>Tubo / Tube Ø 35 mm</b></p>	<p><b>Lenght-L</b> 790 mm</p> <p><b>Lenght-L1</b> 740 mm</p> <p><b>Models <i>OLD Range</i></b> 673 N/NT</p>		<p><b>Ball Joint</b></p>  <p><b>198.480</b> M28x1,5</p>
---	---	--	--

<p><b>CEI no.</b> <b>198.503</b></p> <p><b>O.E.M. Ref</b> 4733752 4666993</p> <p><b>Tubo / Tube Ø 48 mm</b></p>	<p><b>Lenght-L</b> 904 mm</p> <p><b>Lenght-L1</b> 854 mm</p> <p><b>Models <i>OLD Range</i></b> 684 N/NP/T/TP</p> <p><i>Guida Sinistra / Left Drive</i></p>		<p><b>Ball Joint</b></p>  <p><b>198.498</b> M38x1,5</p>
---	--	--	--

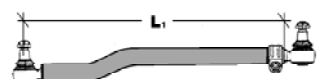
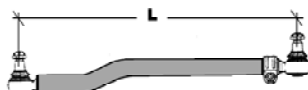



**CEI no.**  
**198.504**

**O.E.M. Ref**  
4733704  
4666991

**Lenght-L**  
910 mm  
**Lenght-L1**  
855 mm



<<< NESSUNA IMMAGINE - NO PICTURE >>>

**Models OLD Range**  
684 N/NP/T/TP

**Ball Joint**



**198.498**

M38x1,5

**Tubo / Tube Ø 46 mm**

*Guida Destra / Right Drive*

**CEI no.**  
**198.507**

**O.E.M. Ref**  
4669091  
4520694

**Lenght-L**  
515 mm  
**Lenght-L1**  
460 mm



**Models OLD Range**  
690 N/N1/N2/N3/N4/T1/T2  
691 N/T

**Ball Joint**



198.650

M38x1,5

**Tubo / Tube Ø 46 mm**

*Assale Anteriore / Front Axle*

**CEI no.**  
**198.508**

**O.E.M. Ref**  
4669094  
4520698

**Lenght-L**  
625 mm  
**Lenght-L1**  
--



**Models OLD Range**  
690 N/N1/N2/N3/N4/T1/T2  
691 N/T

**Tubo / Tube Ø 46 mm**

*Assale Intermedio - Teste Fisse / Intermediate Axle - Fixed Ball Joint*

**CEI no.**  
**198.543**

**O.E.M. Ref**  
4545422

**Lenght-L**  
905 mm  
**Lenght-L1**  
855 mm



**Models OLD Range**  
693 N/N1/T1

**Ball Joint**





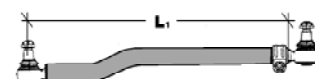
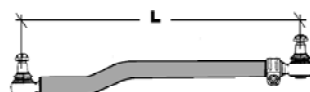

**198.498**



M38x1,5





All original equipment manufacturers' numbers, symbols, pictures, models and description used in this catalogue are for reference only, and it is not implied that any part listed is the product of these manufacturers. Tutti i nostri particolari non sono originali ma con essi intercambiabili. I riferimenti originali, le figure, i modelli sono esposti a semplice titolo indicativo. La nostra produzione riporta il nostro marchio.

<p><b>CEI no.</b> 198.511</p> <p><b>O.E.M. Ref</b> 4732549 4667156</p> <p><b>Tube / Tube Ø 48 mm</b></p>	<p><b>Lenght-L</b></p> <p><b>Lenght-L1</b> 855 mm</p> <p><b>Models <i>OLD Range</i></b> 619 N/N1/N1P/T1/T1P 697 N/NP/T/TP 300 PC/PT</p> <p><i>Guida Sinistra / Left Drive</i></p>	 <p><b>Ball Joint</b></p>  <p><b>198.498</b> M38x1,5</p>
--	---	---

<p><b>CEI no.</b> 198.510</p> <p><b>O.E.M. Ref</b> 4732546 4666954 4624032</p> <p><b>Tube / Tube Ø 50 mm</b></p>	<p><b>Lenght-L</b></p> <p><b>Lenght-L1</b> 855 mm</p> <p><b>Models <i>OLD Range</i></b> 619 N/N1/N1P/T1/T1P 697 N/NP/T/TP 300 PC/PT</p> <p><i>Guida Destra / Right Drive</i></p>	 <p><b>Ball Joint</b></p>  <p><b>198.498</b> M38x1,5</p>
--	--	--

<p><b>CEI no.</b> <b>198.590</b></p> <p><b>O.E.M. Ref</b> 8570528</p> <p><b>Tube / Tube Ø 40 mm</b></p>	<p><b>Lenght-L</b> 708 mm</p> <p><b>Lenght-L1</b> 655 mm</p> <p><b>Models <i>Z Series</i></b> ZETA Series : 50.9 - 60.10 - 60.11 - 79.14 TurboZETA Series : 50.8 - 50.10 - 60.11 - 65.10 - 65.12 - 70.10 - 75.10 - 79.10 - 79.12 - 79.13 - 79.14 - 90.13</p> <p><i>Veicoli con Servosterzo e Cabina Ribaltabile - Truck with power-steering and Tilting Cab</i></p>	 <p><b>Ball Joint</b></p>  <p><b>198.630</b> M30x1,5</p>
---	---	---

<p><b>CEI no.</b> 198.593</p> <p><b>O.E.M. Ref</b> 8567618 8582350</p> <p><b>Tube / Tube Ø 40 mm</b></p>	<p><b>Lenght-L</b> 755 mm</p> <p><b>Lenght-L1</b> 710 mm</p> <p><b>Models <i>Z Series</i></b> ZETA Series : 50.9 - 65.9 - 79.14 TurboZETA Series : 50.8 - 50.10 - 60.10 - 60.11 - 65.10 - 65.12 - 79.10 - 79.12 - 79.13 - 79.14 - 90.13</p> <p><i>Veicoli con Servosterzo e Cabina Fissa - Truck with power-steering and Fixed Cab</i></p>	 <p><b>Ball Joint</b></p>  <p><b>198.602</b> M28x1,5</p>
--	--	---

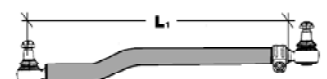
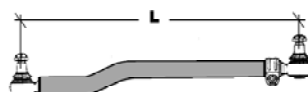



CEI no.  
**198.591**

O.E.M. Ref  
8591219  
8590443

*Tubo / Tube Ø 30 mm*

Lenght-L  
766 mm  
Lenght-L1  
720 mm

**Models Z Series**  
ZETA Series : 50.9  
TurboZETA Series : 60.11 - 65.12 - 79.12 - 79.14

*Veicoli senza Servos. e con Cab. Ribaltabile - Truck w/out power-steer and with Tilting Cab*



**Ball Joint**



**198.475**

*M24x1,5*

CEI no.  
**198.589**

O.E.M. Ref  
8590435

*Tubo / Tube Ø 40 mm*

Lenght-L  
715 mm  
Lenght-L1  
665 mm

**Models Z Series**  
95.14 - 109.14 (2nd Series - 2a Serie)  
ZETA Series : 95.14 - 109.14



**Ball Joint**



**198.602**

*M28x1,5*

CEI no.  
**198.587**

O.E.M. Ref  
4834037  
4773359

*Tubo / Tube Ø 36 mm*

Lenght-L  
979 mm  
Lenght-L1  
930 mm

**Models M Series**  
115.14 - 115.17 - 135.14 - 135.17



**Ball Joint**



**198.602**

*M28x1,5*

CEI no.  
**198.632**

O.E.M. Ref  
4815933  
4834039

*Tubo / Tube Ø 40 mm*

Lenght-L  
979 mm  
Lenght-L1  
930 mm

**Models M Series**  
145.17



**Ball Joint**



**198.602**

*M28x1,5*

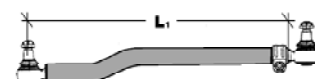
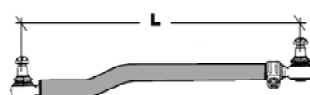

CEI no.  
**220.005**

O.E.M. Ref  
4793166  
4834041

Tubo / Tube Ø 48 mm

Lenght-L  
1001 mm  
Lenght-L1  
950 mm



**Models M Series**  
165.24 - 175.17 - 175.24 R/T/RSU

Ball Joint



**198.485**  
M38x1,5

CEI no.  
**220.011**

O.E.M. Ref  
4715615

Tubo / Tube Ø 48 mm

Lenght-L  
971 mm  
Lenght-L1  
920 mm



**Models T Series**  
160.26 - 160.26 T - 170.20 - 170.26 - 170.35 - 190.20 - 190.26 - 190.35 - 190.38  
**MAGIRUS** : 256M19FL/FLL/FS/FSL - 256M22FLL/FSL - 290M22FL - 320M19FL/FLL/FSL - 320M22FLL

Ball Joint



**198.485**  
M38x1,5

CEI no.  
**220.047**

O.E.M. Ref  
4747961  
4747960

Tubo / Tube Ø 48 mm

Lenght-L  
982 mm  
Lenght-L1  
933 mm



**Models T Series**  
180.24 - 180.26 - 190i26 - 190.26T - 190.30 - 190i35 - 190.38 - 240.26 - 240.35

Ball Joint



**198.525**  
M30x1,5

Versione Standard / Alternativa al 198.585 - Standard Version / Alternative with 198.585

CEI no.  
**198.585**

O.E.M. Ref  
42087841  
42087842

Tubo / Tube Ø 46 mm

Lenght-L  
982 mm  
Lenght-L1  
930 mm



**Models T Series**  
180.24 - 180.26 - 190i26 - 190.26T - 190.30 - 190i35 - 190.38 - 240.26 - 240.35

Ball Joint



**198.525**  
M30x1,5

Versione Standard / Alternativa al 220.047 - Standard Version / Alternative with 220.047

All original equipment manufacturers' numbers, symbols, pictures, models and description used in this catalogue are for reference only, and it is not implied that any part listed is the product of these manufactures. Tutti i nostri particolari non sono originali ma con essi intercambiabili. I riferimenti originali, le figure, i modelli sono esposti a semplice titolo indicativo. La nostra produzione riporta il nostro marchio.

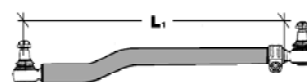
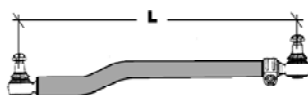



CEI no.  
**198.509**

O.E.M. Ref  
4747961  
4747960  
42087842

Tube / Tube Ø 46 mm

Lenght-L  
982 mm  
Lenght-L1  
932 mm



**Models T Series**

180.24 - 180.26 - 190i26 - 190.26T - 190.30 - 190i35 - 190.38 - 240.26 - 240.35

Versione Rinforzata / Reinforced version - Puo' Sostituire / Can be repl. : 220047/198585

Ball Joint



**198.485**

M38x1,5

CEI no.  
**198.513**

O.E.M. Ref  
42042950  
42041835  
42043912

Tube / Tube Ø 42 mm

Lenght-L  
910 mm  
Lenght-L1  
855 mm



**Models T Series**

160.23/25/30 - 190.25/26H/30H/32 - 220.32 - 260.23/26H/30H/30/35H - 330.25/26H

MAGIRUS : 256M19/M26/M33 - 320M19/M26

1a Serie / 1st Series

Ball Joint



**198.525**

M30x1,5

CEI no.  
**198.512**

O.E.M. Ref  
42001326  
42001325  
42086458

Tube / Tube Ø 42 mm

Lenght-L  
890 mm  
Lenght-L1  
835 mm



**Models T Series**

160.23/30 - 170.23/25/30H/34 - 190.26H/30H/32 - 220.32 - 260.23/25/26H/30H/34/35H - 330.25/26H/32/34/35/36

2a Serie / 2nd Series

Ball Joint



**198.525**

M30x1,5

CEI no.  
**220.047**

O.E.M. Ref  
4747961  
4747960

Tube / Tube Ø 48 mm

Lenght-L  
982 mm  
Lenght-L1  
933 mm



**Models TURBO**

TurboStar : 190.33 - 190.36 - 190.42 - 190.48 - 240.36 - 240.48  
TurboTech : 190.24 - 190.26 - 190.30 - 190.32(GV) - 190.36 - 190.36GV - 240.26 - 240.30 - 240.32GV - 240.36 - 240.36GV - 240.38 - 260.32 - 260.36

Versione Standard / Alternativa al 198.585 - Standard Version / Alternative with 198.585

Ball Joint



**198.525**

M30x1,5

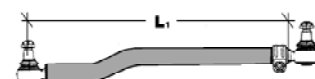
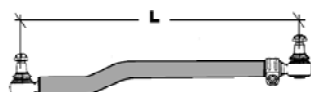

All original equipment manufacturers' numbers, symbols, pictures, models and description used in this catalogue are for reference only, and it is not implied that any part listed is the product of these manufacturers. Tutti i nostri particolari non sono originali ma con essi intercambiabili. I riferimenti originali, le figure, i modelli sono esposti a semplice titolo indicativo. La nostra produzione riporta il nostro marchio.

CEI no.  
**198.585**

O.E.M. Ref  
42087841  
42087842

**Tubo / Tube Ø 46 mm**

Lenght-L  
982 mm  
Lenght-L1  
930 mm



**Models TURBO**

TurboStar : 190.33 - 190.36 - 190.42 - 190.48 - 240.36 - 240.48  
TurboTech : 190.24 - 190.26 - 190.30 - 190.32(GV) - 190.36 - 190.36GV - 240.26 - 240.30 - 240.32GV - 240.36 - 240.36GV - 240.38 - 260.32 - 260.36

Versione Standard / Alternativa al 220.047 - Standard Version / Alternative with 220.047

Ball Joint



**198.525**  
M30x1,5

CEI no.  
**198.509**

O.E.M. Ref  
4747961  
4747960  
42087841  
42087842

**Tubo / Tube Ø 46 mm**

Lenght-L  
982 mm  
Lenght-L1  
932 mm



**Models TURBO**

TurboStar : 190.33 - 190.36 - 190.42 - 190.48 - 240.36 - 240.48  
TurboTech : 190.24 - 190.26 - 190.30 - 190.32(GV) - 190.36 - 190.36GV - 240.26 - 240.30 - 240.32GV - 240.36 - 240.36GV - 240.38 - 260.32 - 260.36

Versione Rinforzata - Reinforced Version / Può sostituire - Can be repl. 220.047 - 198.585

Ball Joint



**198.485**  
M38x1,5

CEI no.  
**220.183**

O.E.M. Ref  
98402544

**Tubo / Tube Ø 40 mm**

Lenght-L  
822 mm  
Lenght-L1  
770 mm



**Models CARGO, FIRE, TECTOR**  
**TECTOR Restyling, TECTOR E4**

60E10/12/14 - 65E10/12/12H/14 - 75E12/13/14/15/16/17/18 - 80E15/18/21 - 85E15H/18H - 100E15/17/18/21/22 - 180E21

Ball Joint



**198.598**  
M30x1,5

CEI no.  
**198.633**

O.E.M. Ref  
98467459

**Tubo / Tube Ø 40 mm**

Lenght-L  
822 mm  
Lenght-L1  
770 mm



**Models CARGO**

80E18/21

Ball Joint



**198.598**  
M30x1,5

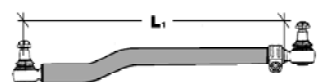
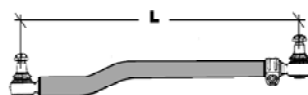



CEI no.  
**220.135**

O.E.M. Ref  
98475709

Tube / Tube Ø 52 mm

Lenght-L  
1190 mm  
Lenght-L1  
1165 mm



Models **CARGO**  
85E18 - 95E18 - 100.9E15

Ball Joint



**198.598**  
M30x1,5

CEI no.  
220.136

O.E.M. Ref  
98473328

Tube / Tube Ø 48 mm

Lenght-L  
966 mm  
Lenght-L1



<<< NESSUNA IMMAGINE - NO PICTURE >>>

Models **CARGO, FIRE, TECTOR**  
**TECTOR Restyling, TECTOR E4**  
95E15/18W21 - 100E18/21/22/25W - 135E18/21/22W/23/24W  
140E24/24W/25/28/30W - 150E18/24  
ML100E18W

Ball Joint



**198.525**  
M30x1,5

CEI no.  
**198.634**

O.E.M. Ref  
4854874

Tube / Tube Ø 42 mm

Lenght-L  
897 mm  
Lenght-L1  
865 mm



Models **CARGO, FIRE, TECTOR**  
**TECTOR Restyling, TECTOR E4**  
120E15/15H/17/18/18H/21/22/23 - 120EL15/18/21 - 130E15/18/21/23/24/28 -  
150E15/18/21/23/24/27/28 - 260E23 - 280E23 - 320E27

Ball Joint



**198.598**  
M30x1,5

CEI no.  
**220.280**

O.E.M. Ref  
500324282

Tube / Tube Ø 40 mm

Lenght-L  
785 mm  
Lenght-L1  
740 mm



Models **CARGO, TECTOR**  
**TECTOR Restyling, TECTOR E4**  
120E17/18/21/22 - 120EL15/15/21

Ball Joint



**198.598**  
M30x1,5

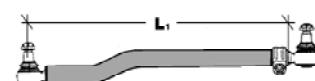
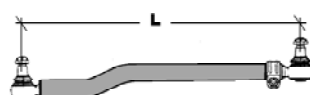

CEI no.  
**220.209**

O.E.M. Ref  
504049893

Tubo / Tube Ø 42 mm

Lenght-L  
890 mm  
Lenght-L1  
851 mm



Models **FIRE, TECTOR, TECTOR Restyl, TECTOR E4**

130E24 - 140E18/21/24/25/28/ - 150E28/30 - 160E18/21/22/24/25/28/30

Ball Joint



**198.525**

M30x1,5

CEI no.  
**220.137**

O.E.M. Ref  
98493054

Lenght-L  
887 mm  
Lenght-L1



<<< NESSUNA IMMAGINE - NO PICTURE >>>

Models **CARGO**

EuroCargo : 150E15H/18H/21H/23H

Ball Joint



**198.525**

M30x1,5

CEI no.  
**220.138**

O.E.M. Ref  
98469650  
98449025

Tubo / Tube Ø 36 mm

Lenght-L  
878 mm  
Lenght-L1  
824 mm



Models **CARGO, TECTOR, TECTOR Restyl.**

150E21/24 - 170E15/18/23/27 - 180E21/24/25/28/30 - 260E23KE/27KE/28KE

Ball Joint



**198.525**

M30x1,5

CEI no.  
**220.013**

O.E.M. Ref  
98446354

Tubo / Tube Ø 52 mm

Lenght-L  
901 mm  
Lenght-L1  
853 mm



Models **TECH**

EuroTech : 180E24/27/30/34 - 190E24/27/30 - 325E27 - 400E30/34

Ball Joint



**198.525**

M30x1,5

All original equipment manufacturers' numbers, symbols, pictures, models and description used in this catalogue are for reference only, and it is not implied that any part listed is the product of these manufacturers. Tutti i nostri particolari non sono originali ma con essi intercambiabili. I riferimenti originali, le figure, i modelli sono esposti a semplice titolo indicativo. La nostra produzione riporta il nostro marchio.

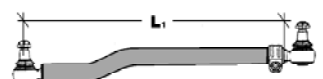
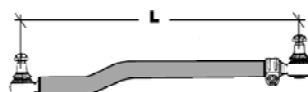

CEI no.  
**220.014**

O.E.M. Ref  
41005463  
8131582  
8132397

Tubo / Tube Ø 52 mm

Lenght-L  
953 mm  
Lenght-L1  
895 mm



**Models TECH, TECH CURSOR, STAR, STAR CURSOR**  
180E34/38/42 - 190E24/26/27/30/31/34/35/37/38/39/42/43/44/47/52 -  
240E25/26/30/34/38/42/47/52- 260E24/27/31/35/38/42/43/47/52/ -  
400E34/38/42/47/52 - 440E31/34/35/38/39/42/43/46/47/48/52

Ball Joint  
  
**198.525**  
M30x1,5

CEI no.  
**220.140**

O.E.M. Ref  
500397738

Tubo / Tube Ø 52 mm

Lenght-L  
959 mm  
Lenght-L1  
883 mm



**Models TECH CURSOR, STAR CURSOR**  
190E31/35/39/43

Ball Joint  
  
**221.055**  
M30x1,5

Ultime Generazioni / Latest Generation

CEI no.  
**220.014**

O.E.M. Ref  
41005463  
8131582  
8132397

Tubo / Tube Ø 52 mm

Lenght-L  
953 mm  
Lenght-L1  
895 mm



**Models TRAKKER, TRAKKER T.CURSOR**  
**TRAKKER ADIAT, TRAKKER ADIAT E4**  
190E24÷E44 - 190T27÷T45 - 260E30÷E48 - 260T31÷T50 - 330E34÷E37 -  
340E34÷E44 - 340T35÷T45 - 380E31÷E48 - 380T35÷T50 - 400E31÷E44 -  
400T35÷T50 - 410E35÷E48 - 410T35÷T50 - 440E34÷E44 - 440T38÷T50 -  
720E31÷E48 - 720T38÷T50

Ball Joint  
  
**198.525**  
M30x1,5

CEI no.  
**220.139**

O.E.M. Ref  
41005475  
41006093

Tubo / Tube Ø 52 mm

Lenght-L  
952 mm  
Lenght-L1  
900 mm



**Models TRAKKER**  
180E25 - 190E30/31/34/37/42 - 260E34/37/42 - 330E34/37 - 380E37/42 -  
410E44 - 400E37/42 - 720E37/720E42

Ball Joint  
  
**198.525**  
M30x1,5

Per modelli con trazione anteriore - For models with front drive

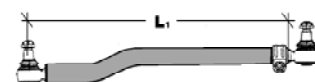
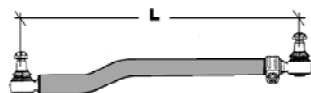



CEI no.  
**220.208**

O.E.M. Ref  
41215165  
41226580

Lenght-L  
959 mm  
Lenght-L1  
905 mm



Models **TRAKKER, TRAKKER T.CURSOR**  
**TRAKKER ADIAT, TRAKKER ADIAT E4**

180T24/27 - 190E31/35/37/38/42/44 - 190T31/33/35/36/38/41/44/45 -  
260E35/37/38/42/44 - 260T35/36/38/41/44/45 - 380E31/35/37/38/42/44 -  
380T35/36/38/41/42/44/45 - 400E37/38/42/44 - 400T38/41/44/45/ - 410E42/44  
- 410T45 - 720E37/38/42/44 - 720T3841/42/44/45

Ball Joint



**198.525**  
M30x1,5

Tube / Tube Ø 52 mm

CEI no.  
**220.014**

O.E.M. Ref  
41005463  
8131582  
8132397

Lenght-L  
953 mm  
Lenght-L1  
895 mm



Models **STRALIS, STRALIS E4**  
**NEW STRALIS 2007**

190S27/30/31/33/35/36/40/42/43/45/48/50  
260S27/30/31/33/35/36/40/42/43/44/45/48/50/54/56  
190S2440S31/33/35/36/40/42/43/44/45/48/50/54/56

Ball Joint



**198.525**  
M30x1,5

Tube / Tube Ø 52 mm

CEI no.  
**220.140**

O.E.M. Ref  
500397738

Lenght-L  
959 mm  
Lenght-L1  
883 mm



Models **STRALIS, STRALIS E4**  
**NEW STRALIS 2007**

190S27/31/33/36/40/42/43/45/48/50  
260S31/3

Ball Joint



**221.055**  
M30x1,5

Tube / Tube Ø 52 mm

CEI no.  
**220.290**

O.E.M. Ref  
4854871

Lenght-L  
1584 mm  
Lenght-L1

Barra di Accoppiamento - Assale Anteriore / Drag Link - Front Axle



<<< NESSUNA IMMAGINE - NO PICTURE >>>

Models **CARGO, FIRE, TECTOR**  
**TECTOR Restyling**

120E15/15H/18/18H/21H/23 - 130E15/18/21/23/24/28  
140E/18/21/24/28 - 150E15/18/21/23/24/27/28 - 260E23  
280E23 - 320E27/28T

Ball Joint



**198.599**

M30x1,5

Ball Joint



**198.598**

M30x1,5

Tube / Tube Ø 40 mm

Ultime Generazioni / Latest Generation

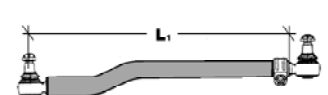
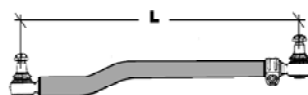

CEI no.  
**198.500**

O.E.M. Ref  
8558522  
8591222

Tube / Tube Ø 30 mm

Lenght-L  
825 mm  
Lenght-L1  
780 mm

Models **BUSES**  
50 AL

Note : In alternativa a / Alternative with : 198.595



Ball Joint



**198.475**  
M24x1,5

CEI no.  
**198.595**

O.E.M. Ref  
8559559

Tube / Tube Ø 30 mm

Lenght-L  
830 mm  
Lenght-L1  
780 mm

Models **BUSES**  
A60.9 - A60.10 - A70.12  
329 B

Note : In alternativa a / Alternative with : 198.500



Ball Joint



**198.475**  
M24x1,5

CEI no.  
198.593

O.E.M. Ref  
8567618  
8582350

Tube / Tube Ø 40 mm

Lenght-L  
755 mm  
Lenght-L1  
710 mm

Models **BUSES**  
Serie ZETA : A60.9 - A70.14 - A90.14

Veicoli con servosterzo - Truck with power-steering



Ball Joint



**198.602**  
M28x1,5

CEI no.  
**198.587**

O.E.M. Ref  
4834037  
4773359

Tube / Tube Ø 36 mm

Lenght-L  
979 mm  
Lenght-L1  
930 mm

Models **BUSES**  
A135.14 - A135.17



Ball Joint



**198.602**  
M28x1,5

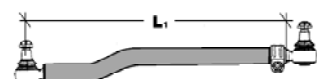
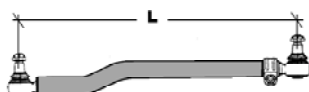

CEI no.  
**220.005**

O.E.M. Ref  
4793166  
4834041

Tube / Tube Ø 48 mm

Lenght-L  
1001 mm  
Lenght-L1  
950 mm

Models **BUSES**  
A175.24



Ball Joint



**198.485**  
M38x1,5

CEI no.  
220.002

O.E.M. Ref  
4659860

Lenght-L  
Lenght-L1  
1550 mm

Models **BUSES**  
343 - 343 L/ST



<<< NESSUNA IMMAGINE - NO PICTURE >>>

Ball Joint



**198.498**  
M38x1,5

CEI no.  
220.004

O.E.M. Ref  
4741957  
4741956

Tube / Tube Ø 48 mm

Lenght-L  
1441 mm  
Lenght-L1  
1390 mm

Models **BUSES**  
370S24 - 370SE.27



<<< NESSUNA IMMAGINE - NO PICTURE >>>

Ball Joint



**198.485**  
M38x1,5

CEI no.  
**198.566**

O.E.M. Ref  
4711108  
4711109

Tube / Tube Ø 50 mm

Lenght-L  
845 mm  
Lenght-L1  
800 mm

Models **BUSES**  
370S24 - 370S.25L - 370S30 - 370S35 - 370SE.29 - 370SE.35

Passo 6290 - Wheel base 6290



Ball Joint



**198.485**  
M38x1,5

All original equipment manufacturers' numbers, symbols, pictures, models and description used in this catalogue are for reference only, and it is not implied that any part listed is the product of these manufacturers. Tutti i nostri particolari non sono originali ma con essi intercambiabili. I riferimenti originali, le figure, i modelli sono esposti a semplice titolo indicativo. La nostra produzione riporta il nostro marchio.

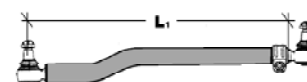
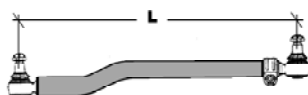



**CEI no.**  
**220.023**  
**O.E.M. Ref**  
**4672795**

**Lenght-L**  
**Lenght-L1**  
**1530 mm**



<<< NESSUNA IMMAGINE - NO PICTURE >>>

**Models BUSES**  
**409A**

**Ball Joint**

**CEI no.**  
**220.016**  
**O.E.M. Ref**  
**42044493**

**Lenght-L**  
**796 mm**  
**Lenght-L1**  
**750 mm**



<<< NESSUNA IMMAGINE - NO PICTURE >>>

**Models BUSES**  
**470.20 - 471.20 - 570.20 - 571.20 - 670.20 - 671.24**

**Ball Joint**



**221.055**

**M30x1,5**

**Tube / Tube Ø 48 mm**

**CEI no.**  
**220.141**  
**O.E.M. Ref**  
**500336085**  
**500308895**  
**99455009**

**Lenght-L**  
**883 mm**  
**Lenght-L1**



<<< NESSUNA IMMAGINE - NO PICTURE >>>

**Models BUSES CITYCLASS**  
**CityClass : 25 - 29 - 31 - 35 - 491.22/24/27 - 591.22/24/27**  
**CityClass OPENTOP**

**Ball Joint**



**221.055**

**M30x1,5**

**Tube / Tube Ø 52 mm**

**CEI no.**  
**220.142**  
**O.E.M. Ref**  
**98420110**  
**98420112**

**Lenght-L**  
**860 mm**  
**Lenght-L1**



<<< NESSUNA IMMAGINE - NO PICTURE >>>

**Models BUSES EUROCLASS**  
**EuroClass : 29 - 35 - 36 - 43 - HD**

**Ball Joint**



**198.525**

**M30x1,5**

**Tube / Tube Ø 30 mm**

**2 Pezzi per Autobus - 2 pcs. For Bus**

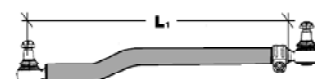
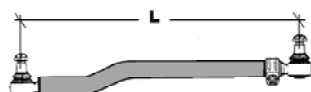

CEI no.  
**220.143**  
O.E.M. Ref  
500311471

Lenght-L  
888 mm  
Lenght-L1



<<< NESSUNA IMMAGINE - NO PICTURE >>>

**Models BUSES EURORIDER - MyWAY**  
EuroRider : 26 - 26A - 29 - 29A - 31 - 35 - 35A - 38 - 43  
MyWAY : 393.29 - 393.35

Ball Joint  
  
**198.485**  
M38x1,5

Tube / Tube Ø 62 mm

CEI no.  
**220.211**  
O.E.M. Ref  
500359179

Lenght-L  
Lenght-L1



<<< NESSUNA IMMAGINE - NO PICTURE >>>

**Models BUSES MIDIRIDER**  
MidiRider : 24 - 27 - 30

Ball Joint  

Tube / Tube Ø 62 mm

CEI no.  
**220.210**  
O.E.M. Ref  
42542824

Lenght-L  
Lenght-L1



<<< NESSUNA IMMAGINE - NO PICTURE >>>

**Models BUSES EUROPOLIS**  
EuroPolis : 200E.8.13 - 200E.8.17 - 200E.9.15 - 200E.10.20

Ball Joint

Tube / Tube Ø 62 mm

CEI no.  
**220.183**  
O.E.M. Ref  
98402544

Lenght-L  
822 mm  
Lenght-L1  
770 mm



**Models BUSES PROXYS - PROWAY - CC Series**  
CC100E21 - CC100E22  
PROXYS  
PROWAY

Ball Joint  
  
**198.598**  
M30x1,5

Tube / Tube Ø 40 mm

All original equipment manufacturers' numbers, symbols, pictures, models and description used in this catalogue are for reference only, and it is not implied that any part listed is the product of these manufacturers. Tutti i nostri particolari non sono originali ma con essi intercambiabili. I riferimenti originali, le figure, i modelli sono esposti a semplice titolo indicativo. La nostra produzione riporta il nostro marchio.

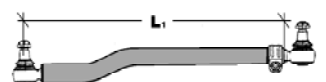
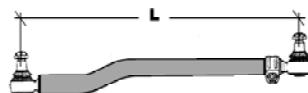

CEI no.  
**220.206**

O.E.M. Ref  
4704183

Tube / Tube Ø 48 mm

Lenght-L  
1050 mm  
Lenght-L1  
970 mm

Models **BUSES**  
370S24 -  
370SE29



Ball Joint



**198.486**

M38x1,5

Ball Joint



**198.485**

M38x1,5

CEI no.  
220.144

O.E.M. Ref  
4838587  
4822291

Tube / Tube Ø 48 mm

Lenght-L  
780 mm  
Lenght-L1

Models **BUSES**  
TurboCity : 480 - 580 - 680



<<< NESSUNA IMMAGINE - NO PICTURE >>>

Parte Sinistra / Left Side

Ball Joint



**198.525**

M30x1,5

CEI no.  
220.145

O.E.M. Ref  
4826513  
4827082  
4862449  
4862451

Tube / Tube Ø 48 mm

Lenght-L  
780 mm  
Lenght-L1

Models **BUSES**  
TurboCity : 480 - 580 - 680



<<< NESSUNA IMMAGINE - NO PICTURE >>>

Parte Destra / Right Side

Ball Joint



**198.525**

M30x1,5

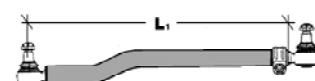
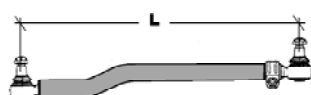



CEI no.  
**220.033**

O.E.M. Ref  
094016  
171215

Tubo / Tube Ø 40 mm

Lenght-L  
744 mm  
Lenght-L1  
680 mm

**Models OLD Range**  
F2100 - F2300 - F2500 - F2700



Ball Joint



221.019  
M30x1,5

CEI no.  
**220.015**

O.E.M. Ref  
094029  
117343

Tubo / Tube Ø 40 mm

Lenght-L  
872 mm  
Lenght-L1  
805 mm

**Models OLD Range**  
F2800 - F3300 - F3600



Ball Joint



221.019  
M30x1,5

CEI no.  
**220.194**

O.E.M. Ref  
1700913  
1406600

Tubo / Tube Ø 52 mm

Lenght-L  
890 mm  
Lenght-L1  
840 mm

**Models NEW Range "LF"**  
LF45



Ball Joint



221.082  
M30x1,5

CEI no.  
**220.212**

O.E.M. Ref  
1401937

Tubo / Tube Ø 46 mm

Lenght-L  
  
Lenght-L1  
930 mm

**Models NEW Range "LF"**  
LF55



<<< NESSUNA IMMAGINE - NO PICTURE >>>

Ball Joint

221.083  
M30x1,5

All original equipment manufacturers' numbers, symbols, pictures, models and description used in this catalogue are for reference only, and it is not implied that any part listed is the product of these manufacturers. Tutti i nostri particolari non sono originali ma con essi intercambiabili. I riferimenti originali, le figure, i modelli sono esposti a semplice titolo indicativo. La nostra produzione riporta il nostro marchio.

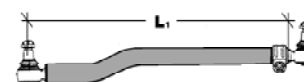
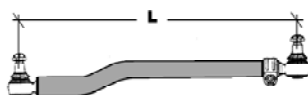

CEI no.  
**220.213**  
O.E.M. Ref  
1405309

Lenght-L  
Lenght-L1  
926 mm



<<< NESSUNA IMMAGINE - NO PICTURE >>>

Models **NEW Range "LF"**  
LF55

Ball Joint  
  
221.085

Tubo / Tube Ø 46 mm

CEI no.  
**220.078**  
O.E.M. Ref  
1351715  
1385492  
1283212

Lenght-L  
848 mm  
Lenght-L1  
798 mm



Models **NEW Range "F" - "CF"**  
F65 - 65CF - F75 - 75CF - F85 - 85CF

Ball Joint  
  
**198.630**  
M30x1,5

*Il tirante monta testine con Dadi autobloccanti - 198.630 usa dadi con coppiglia*  
*The Steering rod uses ball joints with self-lock nuts. 198.630 use nut with pin*

Tubo / Tube Ø 52 mm

CEI no.  
**220.077**  
O.E.M. Ref  
1351714  
1385497  
1283211  
1247956

Lenght-L  
876 mm  
Lenght-L1  
825 mm



Models **NEW Range "F" - "CF"**  
F65 - 65CF - F75 - 75CF - F85 - 85CF

Ball Joint  
  
**198.630**  
M30x1,5

*Il tirante monta testine con Dadi autobloccanti - 198.630 usa dadi con coppiglia*  
*The Steering rod uses ball joints with self-lock nuts. 198.630 use nut with pin*

Tubo / Tube Ø 52 mm

CEI no.  
**220.281**  
O.E.M. Ref  
1602820  
1448062  
1363858

Lenght-L  
843 mm  
Lenght-L1  
805 mm



Models **NEW Range "CF"**  
65CF - CF65 - 75CF - CF75 - 85CF - CF85

Ball Joint  
  
221.088  
M30x1,5

Tubo / Tube Ø 50 mm

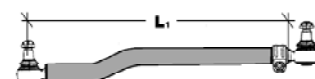
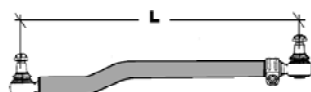

CEI no.  
**220.282**

O.E.M. Ref  
1602821  
1448063  
1363859

Tubo / Tube Ø 50 mm

Lenght-L  
857 mm  
Lenght-L1  
806 mm



**Models NEW Range "CF"**  
65CF - CF65 - 75CF - CF75 - 85CF - CF85

Ball Joint



221.088  
M30x1,5

CEI no.  
**220.284**

O.E.M. Ref  
1351716  
1277567

Tubo / Tube Ø 52 mm

Lenght-L  
840 mm  
Lenght-L1  
805 mm



**Models NEW Range "CF"**  
F75 - 75CF - F85 - 85CF

Ball Joint



**198.630**  
M30x1,5

CEI no.  
**220.283**

O.E.M. Ref  
1448064  
1373878

Tubo / Tube Ø 52 mm

Lenght-L  
855 mm  
Lenght-L1  
815 mm



**Models NEW Range "CF"**  
75CF - CF75 - 85CF - CF85

Ball Joint



221.087  
M30x1,5

CEI no.  
**220.001**

O.E.M. Ref  
094038  
525433  
554765

Tubo / Tube Ø 50 mm

Lenght-L  
995 mm  
Lenght-L1  
960 mm



**Models NEW Range "F" - "XF"**  
F95 - 95XF

Ball Joint



**198.525**  
M30x1,5

All original equipment manufacturers' numbers, symbols, pictures, models and description used in this catalogue are for reference only, and it is not implied that any part listed is the product of these manufacturers. Tutti i nostri particolari non sono originali ma con essi intercambiabili. I riferimenti originali, le figure, i modelli sono esposti a semplice titolo indicativo. La nostra produzione riporta il nostro marchio.

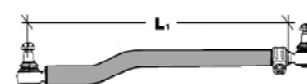
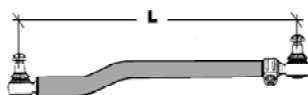

CEI no.  
**220.150**

O.E.M. Ref  
1351734  
1385499  
1291060

Tubo / Tube Ø 62 mm

Lenght-L  
1005 mm  
Lenght-L1  
980 mm

**Models NEW Range "F" - "XF"**  
F95 - 95XF - XF95

*Il tirante monta testine con Dadi autobloccanti - La testina 198.630 usa dadi con coppiglia*  
*The Steering rod uses ball joints with self-lock nuts. Ball Joint 198.630 use nut with pin*



**198.630**  
M30x1,5

CEI no.  
**220.193**

O.E.M. Ref  
1351735  
1385500  
1291048

Tubo / Tube Ø 62 mm

Lenght-L  
1008 mm  
Lenght-L1  
946 mm

**Models NEW Range "F" - "XF"**  
F95 - 95XF

*Sospensione Pneumatica / Pneumatic Suspension*



**198.630**  
M30x1,5

CEI no.  
**220.214**

O.E.M. Ref  
1426101  
094613  
362413

Tubo / Tube Ø 52 mm

Lenght-L  
1004 mm  
Lenght-L1  
950 mm

**Models NEW Range "F" - "XF"**  
F95 - XF95 - XF105



**198.525**  
M30x1,5

CEI no.  
**220.205**

O.E.M. Ref  
1353396  
1286343

Tubo / Tube Ø 52 mm

Lenght-L  
1725 mm  
Lenght-L1  
1680 mm

**Models NEW Range "F" - "CF" - "XF"**  
F75 - 75CF - CF75  
F85 - 85CF - CF85  
F95 - 95XF - XF95 - XF105

**Barra di Accoppiamento - Assale Anteriore / Drag Link - Front Axle**



**221.084**  
M30x1,5

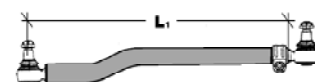
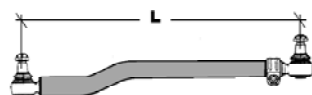



CEI no.  
**220.031**

O.E.M. Ref  
383 460 4505  
383 460 2405  
383 460 1605  
383 460 0805

Tubo / Tube Ø 40 mm

Lenght-L  
890 mm  
Lenght-L1  
833 mm



**Models NG**

1013-1017-1019 (Telai CH 380.xxx) / 1213-1217-1219 (Telai CH 381.xxx)  
1413-1417-1419-1424 (Telai CH 383.xxx)

● Vecchia Generazione - Guida Sinistra / Old Generation - Left Drive

**Ball Joint**



**221.057**  
M30x1,5

CEI no.  
**198.536**

O.E.M. Ref  
383 460 4405  
383 460 2305  
383 460 1405  
383 460 0605

Tubo / Tube Ø 40 mm

Lenght-L  
890 mm  
Lenght-L1  
840 mm



**Models NG**

1013-1017-1019 (Telai CH 380.xxx) / 1213-1217-1219 (Telai CH 381.xxx)  
1413-1417-1419-1424 (Telai CH 383.xxx)  
1613-1617-1619-1624-2219-2224 (Telai CH 385.xxx)

● Ultima Generazione - Guida Sinistra / Latest Generation - Left Drive

**Ball Joint**



**189.287**  
M30x1,5

CEI no.  
**220.151**

O.E.M. Ref  
387 460 4805  
387 460 4905  
387 460 0005

Tubo / Tube Ø 40 mm

Lenght-L  
880 mm  
Lenght-L1



<<< NESSUNA IMMAGINE - NO PICTURE >>>

**Models NG**

1626-1632-1719 (Telai CH 387.xxx) / 1919-1926-1932 (Telai CH 389.xxx)  
2026-2032 (Telai CH 391.xxx) / 2226-2232 (Telai CH 393.xxx)  
2626-2632 (Telai CH 395.xxx)

○ Vecchia Generazione - Guida Sinistra / Old Generation - Left Drive

**Ball Joint**



**189.287**  
M30x1,5

CEI no.  
**220.152**

O.E.M. Ref  
387 460 4405  
387 460 4505  
387 460 0605

Tubo / Tube Ø 40 mm

Lenght-L  
865 mm  
Lenght-L1



<<< NESSUNA IMMAGINE - NO PICTURE >>>

**Models NG**

1626-1632-1719 (Telai CH 387.xxx) / 1919-1926-1932 (Telai CH 389.xxx)  
2026-2032 (Telai CH 391.xxx) / 2226-2232 (Telai CH 393.xxx)  
2626-2632 (Telai CH 395.xxx)

○ Nuova Generazione - Guida Sinistra / New Generation - Left Drive

**Ball Joint**



**189.287**  
M30x1,5

All original equipment manufacturers' numbers, symbols, pictures, models and description used in this catalogue are for reference only, and it is not implied that any part listed is the product of these manufacturers. Tutti i nostri particolari non sono originali ma con essi intercambiabili. I riferimenti originali, le figure, i modelli sono esposti a semplice titolo indicativo. La nostra produzione riporta il nostro marchio.

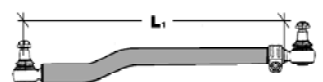
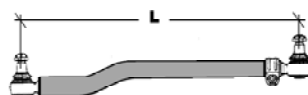

All original equipment manufacturers numbers, symbols, pictures, models and description used in this catalogue are for reference only, and it is not implied that any part listed is the product of these manufacturers. Tutti i nostri particolari non sono originali ma con essi intercambiabili. I riferimenti originali, le figure, i modelli sono esposti a semplice titolo indicativo. La nostra produzione riporta il nostro marchio.

**CEI no.**  
**198.535**

**O.E.M. Ref**  
647 460 0105  
647 460 0005  
387 460 3305  
387 460 3205  
387 460 1405

**Tube / Tube Ø 40 mm**

**Lenght-L**  
865 mm  
**Lenght-L1**  
815 mm

**Models NG**  
**1626-1632-1719** (Telai CH 387.xxx) / **1919-1926-1932** (Telai CH 389.xxx)  
**2026-2032** (Telai CH 391.xxx) / **2226-2232** (Telai CH 393.xxx)  
**2626-2632** (Telai CH 395.xxx)

○ **Ultima Generazione - Guida Sinistra / Latest Generation - Left Drive**



**Ball Joint**  
  
**198.525**  
M30x1,5

**CEI no.**  
**220.032**

**O.E.M. Ref**  
673 460 0605  
673 460 0805  
673 460 0405  
673 460 0205

**Ø Tubo 36 mm**

**Lenght-L**  
725 mm  
**Lenght-L1**  
680 mm

**Models LK**  
**709-711-809-811** (Telai 673.xxx)  
**814-914** (Telai 674.xxx)  
**817-917** (Telai 676.xxx)

**Guida Sinistra / Left Drive**



**Ball Joint**  
  
**221.057**  
M30x1,5

**CEI no.**  
**220.038**

**O.E.M. Ref**  
675 460 3005  
675 460 2405  
675 460 1805  
675 460 1205

**Ø Tubo 40 mm**

**Lenght-L**  
727 mm  
**Lenght-L1**  
670 mm

**Models LK**  
**1114** (Telai 675.xxx)  
**1117** (Telai 676.xxx)  
**1120** (Telai 677.xxx)

**Guida Sinistra / Left Drive**



**Ball Joint**  
  
**189.287**  
M30x1,5

**CEI no.**  
**220.006**

**O.E.M. Ref**  
675 460 2205  
675 460 2805  
675 460 1605  
675 460 1005

**Ø Tubo 40 mm**

**Lenght-L**  
780 mm  
**Lenght-L1**  
730 mm

**Models LK**  
**1314** (Telai 675.xxx)  
**1317** (Telai 676.xxx)  
**1320** (Telai 677.xxx)



❖ **1a Generazione - Guida Sinistra / 1st Generation - Left Drive**



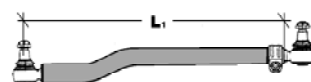
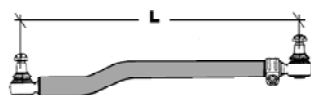



**Ball Joint**  
  
**189.287**  
M30x1,5



All original equipment manufacturers' numbers, symbols, pictures, models and description used in this catalogue are for reference only, and it is not implied that any part listed is the product of these manufacturers. Tutti i nostri particolari non sono originali ma con essi intercambiabili. I riferimenti originali, le figure, i modelli sono esposti a semplice titolo indicativo. La nostra produzione riporta il nostro marchio.

<p><b>CEI no.</b> <b>220.019</b></p> <p><b>O.E.M. Ref</b> 676 460 1105 676 460 1505 676 460 0605 676 460 0105</p> <p><b>Ø Tubo 40 mm</b></p>	<p><b>Lenght-L</b> 780 mm</p> <p><b>Lenght-L1</b> 740 mm</p> <p><b>Models LK</b> 1314 (Telai 675.xxx)   1317 (Telai 676.xxx) 1320-2020 (Telai 677.xxx) 1324-1824 (Telai 679.xxx)</p> <p>❖ 2nd Generazione - Guida Sinistra / 2nd Generation - Left Drive</p>		<p><b>Ball Joint</b></p>  <p><b>189.287</b> M30x1,5</p>
--	--	--	--

<p><b>CEI no.</b> <b>220.216</b></p> <p><b>O.E.M. Ref</b> 676 460 2105 676 460 1905</p> <p><b>Ø Tubo 42 mm</b></p>	<p><b>Lenght-L</b> 783 mm</p> <p><b>Lenght-L1</b></p> <p><b>Models LK</b> 1314-1514 (Telai 675.xxx)   1517 (Telai 676.xxx) 1520 (Telai 677.xxx) 1524 (Telai 679.xxx)</p> <p>⌘ 1a Generazione - Guida Sinistra / 1st Generation - Left Drive</p>	 <p>&lt;&lt;&lt; NESSUNA IMMAGINE - NO PICTURE &gt;&gt;&gt;</p>	<p><b>Ball Joint</b></p>  <p><b>189.287</b> M30x1,5</p>
--	---	---	---

<p><b>CEI no.</b> <b>220.217</b></p> <p><b>O.E.M. Ref</b> 676 460 3105</p> <p><b>Ø Tubo 42 mm</b></p>	<p><b>Lenght-L</b></p> <p><b>Lenght-L1</b></p> <p><b>Models LK</b> 1314-1514 (Telai 675.xxx)   1517 (Telai 676.xxx) 1520 (Telai 677.xxx) 1524 (Telai 679.xxx)</p> <p>⌘ 2nd Generazione - Guida Sinistra / 2nd Generation - Left Drive</p>	 <p>&lt;&lt;&lt; NESSUNA IMMAGINE - NO PICTURE &gt;&gt;&gt;</p>	<p><b>Ball Joint</b></p>  <p><b>198.630</b> M30x1,5</p>
---	---	---	--

<p><b>CEI no.</b> <b>220.035</b></p> <p><b>O.E.M. Ref</b> 617 460 3405 617 460 2405 617 460 2005</p> <p><b>Ø Tubo 42 mm</b></p>	<p><b>Lenght-L</b> 863 mm</p> <p><b>Lenght-L1</b> 794 mm</p> <p><b>Models MK / SK</b> 1214-1217-1222-1225-1425 (Telai 615.xxx)   1417 (Telai 616.xxx)   1617-1622-1627 (Telai 617.xxx)   1222-1224-1227-1231-1234 (Telai 650.xxx)   1417-1720-1724 (Telai 651.xxx)   1717-1722-1724-1726-1820-1824-1827 (Telai 652.xxx)</p> <p>Solo per la 2a Generazione - Guida Sinistra / 2nd Generation Only - Left Drive</p>		<p><b>Ball Joint</b></p>  <p><b>198.525</b> M30x1,5</p>
---	---	--	--

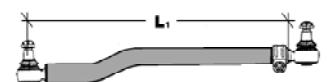
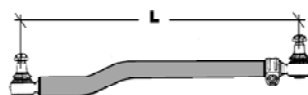

CEI no.

**198.628**

O.E.M. Ref  
620 460 3705  
620 460 2805  
620 460 2005  
620 460 0005

Ø Tubo 40 mm

Lenght-L

885 mm

Lenght-L1

835 mm

**Models MK / SK**

1628-1633-1635-1636-2033-2228-2233-2428 (Telai 620.xxx) / 1922-1928-1933-1935-1936-2222-2228-2422-2428-2528-2628 (Telai 621.xxx) / 2228-2233-2236-2238-3028-3033-3038 (Telai 623.xxx) / 2628-3328-3528 (Telai 624.xxx) / 3236-3244-3250-3850 (Telai 625.xxx) / 1635-1644-2435-2444 (Telai 645.xxx) / 1935-1944 (Telai 646.xxx) / 2035 (Telai 647.xxx) / 2235-2635-3335 (Telai 648.xxx) / 2635-2644-3344-3544 (Telai 649.xxx) / 1831-1834-1838-1844-1850-2531-2538 (Telai 655.xxx) / 1922-1929-1935-2038 (Telai 656.xxx) / 2428-2538-2544-2550-2553-3235 (Telai 658.xxx) / 2631-2634-2644-2650-2653-3550 (Telai 659.xxx)

■ □ 1a Generazione - Guida Sinistra / 1st Generation - Left Drive



Ball Joint



**198.525**

M30x1,5

CEI no.

**198.535**

O.E.M. Ref  
647 460 0105  
647 460 0005  
387 460 3305  
387 460 3205  
387 460 1405

Ø Tubo 40 mm

Lenght-L

865 mm

Lenght-L1

815 mm

**Models MK / SK**

1628-1633-1635-1636-2033-2228-2233-2428 (Telai 620.xxx) / 1922-1928-1933-1935-1936-2222-2228-2422-2428-2528-2628 (Telai 621.xxx) / 2228-2233-2236-2238-3028-3033-3038 (Telai 623.xxx) / 2628-3328-3528 (Telai 624.xxx) / 3236-3244-3250-3850 (Telai 625.xxx) / 1222 (Telai 650.xxx) / 1417-1420-1424-1426 (Telai 651.xxx) / 1717-1722-1724-1726-1820-1824-1827 (Telai 652.xxx) / 1922-1929-1935-2038 (Telai 656.xxx) / 2429-2435-2538-2544 (Telai 657.xxx) / 2428-2538-2544-2550-2553-3235 (Telai 658.xxx) / 2631-2634-2644-2650-2653-3550 (Telai 659.xxx)

■ □ 2a Generazione - Guida Sinistra / 2nd Generation - Left Drive



Ball Joint



**198.525**

M30x1,5

CEI no.

**220.037**

O.E.M. Ref  
620 460 3005  
620 460 2905  
620 460 0805  
620 460 0405

Ø Tubo 40 mm

Lenght-L

865 mm

Lenght-L1

800 mm

**Models MK / SK**

1922-1925-1928-1935-1936-2428-2528 (Telai 621.xxx) / 2628-3328-3528 (Telai 624.xxx) / 1935 (Telai 646.xxx) / 2635 (Telai 649.xxx) / 1729-1735-1831-1834-1838-1844-1850-2038 (Telai 655.xxx) / 1922-1929-1935-2038 (Telai 656.xxx) / 2631-2634-2644-2650-2653-3550 (Telai 659.xxx)

■ □ 2a Generazione - Guida Sinistra / 2nd Generation - Left Drive



Ball Joint



**198.525**

M30x1,5

CEI no.

**220.172**

O.E.M. Ref  
625 460 2505

Ø Tubo 42 mm

Lenght-L

860 mm

Lenght-L1

818 mm

**Models MK / SK**

3236-3244-3250-3850 (Telai 625.xxx) / 1729-1735-1831-1834-1838-1844-1850-2038 (Telai 655.xxx) / 1922-1929-1935-2038 (Telai 656.xxx) / 2428-2538-2544-2550-2553-3235 (Telai 658.xxx)

■ □ 2a Generazione - Guida Sinistra / 2nd Generation - Left Drive



Ball Joint



**221.033**

M30x1,5

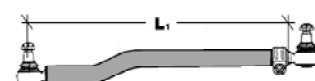
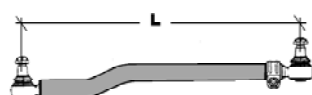





All original equipment manufacturers' numbers, symbols, pictures, models and description used in this catalogue are for reference only, and it is not implied that any part listed is the product of these manufacturers. Tutti i nostri particolari non sono originali ma con essi intercambiabili. I riferimenti originali, le figure, i modelli sono esposti a semplice titolo indicativo. La nostra produzione riporta il nostro marchio.

<p><b>CEI no.</b> <b>220.040</b></p> <p>O.E.M. Ref 000 460 9805 000 460 9905</p> <p><b>Ø Tubo 48 mm</b></p>	<p><b>Lenght-L</b> 900 mm</p> <p><b>Lenght-L1</b> 845 mm</p> <p><b>Models SK</b> 1831-1834-1838-1844-1850-2531-2538 (Telai 655.xxx) / 1922-1929-1935-2038 (Telai 656.xxx) / 2428-2538-2544-2550-2553-3235 (Telai 658.xxx) / 2631-2634-2644-2650-2653-3550 (Telai 659.xxx)</p> <p>■ 3a Generazione - Guida Sinistra / 3rd Generation - Left Drive</p>		<p><b>Ball Joint</b></p>  <p><b>221.033</b> M30x1,5</p>
---	--	--	--

<p><b>CEI no.</b> <b>220.153</b></p> <p>O.E.M. Ref 002 460 1405 002 460 1605</p> <p><b>Ø Tubo 48 mm</b></p>	<p><b>Lenght-L</b> 865 mm</p> <p><b>Lenght-L1</b> 835 mm</p> <p><b>Models SK</b> 1831-1834-1838-1844-1850-2531-2538 (Telai 655.xxx) 1922-1929-1935-2038 (Telai 656.xxx) 2428-2538-2544-2550-2553-3235 (Telai 658.xxx)</p> <p>■ 3a Generazione - Guida Sinistra / 3rd Generation - Left Drive</p>		<p><b>Ball Joint</b></p>  <p><b>221.033</b> M30x1,5</p>
---	--	--	---

<p><b>CEI no.</b> <b>220.117</b></p> <p>O.E.M. Ref 619 460 2905 619 460 2505 619 460 5205</p> <p><b>Ø Tubo 42 mm</b></p>	<p><b>Lenght-L</b> 860 mm</p> <p><b>Lenght-L1</b> 804 mm</p> <p><b>Models MK / SK</b> 1625-1628-2225-2228 (Telai 617.xxx) / 2219-2220-2222-2225-2822-2825-2828-3025 (Telai 619.xxx) / 1424-1427 (Telai 651.xxx) / 1717-1720-1726-1729-1733-1820-1827-1834-1926-2422-2426-2629-2431-2527-2531 (Telai 652.xxx) / 2420-2426-2427-2433-2524-2527-2531-2534 (Telai 653.xxx)</p> <p>Ω 1a Generazione - Guida Sinistra / 1st Generation - Left Drive</p>		<p><b>Ball Joint</b></p>  <p><b>221.033</b> M30x1,5</p>
--	---	--	--

<p><b>CEI no.</b> <b>220.030</b></p> <p>O.E.M. Ref 001 460 0405 001 460 0305</p> <p><b>Ø Tubo 48 mm</b></p>	<p><b>Lenght-L</b> 840 mm</p> <p><b>Lenght-L1</b> 786 mm</p> <p><b>Models MK / SK</b> 1625-1628-2225-2228 (Telai 617.xxx) / 2219-2220-2222-2225-2822-2825-2828-3025 (Telai 619.xxx) / 1424-1427 (Telai 651.xxx) / 1717-1720-1726-1729-1733-1820-1827-1834-1926-2422-2426-2629-2431-2527-2531 (Telai 652.xxx) / 2420-2426-2427-2433-2524-2527-2531-2534 (Telai 653.xxx)</p> <p>Ω 2a Generazione - Guida Sinistra / 2nd Generation - Left Drive</p>		<p><b>Ball Joint</b></p>  <p><b>198.525</b> M30x1,5</p>
---	---	--	--

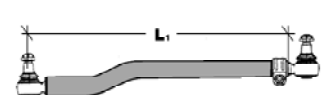
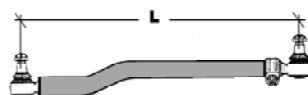

CEI no.  
**220.119**

O.E.M. Ref  
001 460 2905  
001 460 3005

Ø Tubo 52 mm

Lenght-L  
840 mm  
Lenght-L1  
778 mm

**Models MK / SK**

1625-1628-2225-2228 (Telai 617.xxx) / 2219-2220-2222-2225-2822-2825-2828-3025  
(Telai 619.xxx) / 1424-1427 (Telai 651.xxx) / 1717-1720-1726-1729-1733-1820-1827-  
1834-1926-2422-2426-2629-2431-2527-2531 (Telai 652.xxx) / 2420-2426-2427-2433-2524-  
2527-2531-2534 (Telai 653.xxx)

Ω 3a Generazione - Guida Sinistra / 3rd Generation - Left Drive



**Ball Joint**



**221.046**  
M30x1,5

CEI no.  
**220.215**

O.E.M. Ref  
667 460 1505  
667 460 1705

Ø Tubo 34 mm

Lenght-L  
500 mm  
Lenght-L1  
455 mm

**Models VARIO**

512-612-614 (Telai 667.xxx - Telai 668.xxx)  
810-812-814-815 (Telai 669.xxx - Telai 670.xxx)



**Ball Joint**



**198.477**  
M28x1,5

CEI no.  
**220.177**

O.E.M. Ref  
970 460 0705  
970 460 0905

Ø Tubo 42 mm

Lenght-L  
840 mm  
Lenght-L1  
795 mm

**Models ATEGO - NEW ATEGO**

714-715-814-815-818-823-917-923 (Telai 970.xxx - Telai 972.xxx)  
815 (Telai 976.xxx)

Versioni con Carico 3,5 Ton / Versions with 3,5 Ton Pay-load



**Ball Joint**



**198.630**  
M30x1,5

CEI no.  
**220.178**

O.E.M. Ref  
972 460 1405  
972 460 1605

Ø Tubo 40 mm

Lenght-L  
815 mm  
Lenght-L1  
785 mm

**Models ATEGO - NEW ATEGO**

814-815-818-823-917-923-1017-1023-1215-1223 (Telai 970.xxx - Telai 972.xxx)  
917-1017 (Telai 975.xxx)

Versioni con Carico 4,1 Ton / Versions with 4,1 Ton Pay-load



**Ball Joint**



**198.630**  
M30x1,5

CEI no.  
**220.179**

O.E.M. Ref  
972 460 1805  
972 460 2005

Ø Tubo 50 mm

Lenght-L  
880 mm  
Lenght-L1  
830 mm



**Models ATEGO - NEW ATEGO**

917-918-923-1017-1023-1214-1217-1223-1228-1318-1318-1328 (Telai 970.xxx  
- Telai 972.xxx) 1017-1217-1317-1323 (Telai 975.xxx)  
1225-1325 (Telai 976.xxx)

Versioni con Carico 5,3 Ton / Versions with 5,3 Ton Pay-load

Ball Joint



**221.033**  
M30x1,5

CEI no.  
**220.131**

O.E.M. Ref  
974 460 1205  
974 460 1005

Ø Tubo 50 mm

Lenght-L  
894 mm  
Lenght-L1  
826 mm



**Models ATEGO - NEW ATEGO**

1214-1215-1217-1218-1223-1317-1381-1323-1328-1517-1518-1523-1528  
(Telai 970.xxx - Telai 972.xxx) / 1323-1328 (Telai 974.xxx) / 1217-1317-1318-1323-  
1523 (Telai 975.xxx) / 1225-1325-1328-1528 (Telai 976.xxx)

Versioni con Carico 6,1 Ton / Versions with 6,1 Ton Pay-load

Ball Joint



**221.033**  
M30x1,5

CEI no.  
**220.220**

O.E.M. Ref  
972 460 1005  
972 460 1205

Ø Tubo 40 mm

Lenght-L  
873 mm  
Lenght-L1  
820 mm



**Models NEW ATEGO**

915-926-1017-1024 (Telai 970.xxx - Telai 976.xxx)

Ball Joint



**198.630**  
M30x1,5

CEI no.  
**220.219**

O.E.M. Ref  
974 460 2205  
974 460 0805  
974 460 0405

Ø Tubo 50 mm

Lenght-L  
  
Lenght-L1  
884 mm



<<< NESSUNA IMMAGINE - NO PICTURE >>>

**Models NEW ATEGO**

1225-1226-1317-1324 (Telai 970.xxx - Telai 976.xxx)

Ball Joint



**198.630**  
M30x1,5

All original equipment manufacturers' numbers, symbols, pictures, models and description used in this catalogue are for reference only, and it is not implied that any part listed is the product of these manufacturers. Tutti i nostri particolari non sono originali ma con essi intercambiabili. I riferimenti originali, le figure, i modelli sono esposti a semplice titolo indicativo. La nostra produzione riporta il nostro marchio.

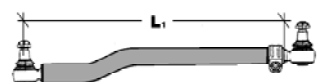
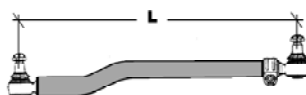

CEI no.  
**220.180**

O.E.M. Ref  
972 460 2805

Ø Tubo 42 mm

Lenght-L  
830 mm  
Lenght-L1  
795 mm



**Models ATEGO**

712-715-814-815-818-823-917-923-1017-1023-1215-1223 (Telai 970.xxx - Telai 972.xxx)

Versioni con Sospensione Pneumatica / Versions with Pneumatic Suspension

**Ball Joint**



**198.630**  
M30x1,5

CEI no.  
**220.218**

O.E.M. Ref  
974 460 0005  
974 460 0605

Ø Tubo 50 mm

Lenght-L  
  
Lenght-L1



<<< NESSUNA IMMAGINE - NO PICTURE >>>

**Models ATEGO**

1517-1519 (Telai 970.xxx) - (Telai 972.xxx)

Versioni con Sospensione Pneumatica / Versions with Pneumatic Suspension

**Ball Joint**



**221.033**  
M30x1,5

CEI no.  
**220.132**

O.E.M. Ref  
002 460 4905  
002 460 5005

Ø Tubo 40 mm

Lenght-L  
895 mm  
Lenght-L1  
842 mm



**Models AXOR and Maxi-ATEGO**

1823-1828-2523-2528-2628 (Telai 950.500÷600 / 952.500÷600)

1835-1840-1843-2535-2540-2543 (Telai 944.xxx)

Versioni con Sospensione Pneumatica / Versions with Pneumatic Suspension

**Ball Joint**



**221.058**  
M30x1,5

CEI no.  
**220.181**

O.E.M. Ref  
002 460 4505  
002 460 4605

Ø Tubo 36 mm

Lenght-L  
880 mm  
Lenght-L1  
830 mm



**Models AXOR and Maxi-ATEGO**

1823-1828-2523-2528-2628 (Telai 950.500÷600 / 952.500÷600)

1835-1840-1843-2535-2540-2543 (Telai 944.xxx)

Versioni con Freni a Tamburo / Versions with Drum Brake

**Ball Joint**



**221.034**  
M28x1,5

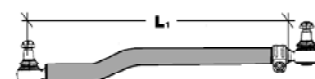
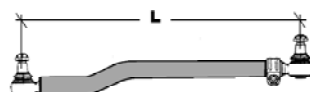



CEI no.  
**220.184**

O.E.M. Ref  
003 460 4405  
002 460 7505  
002 460 7605

Ø Tubo 38 mm

Lenght-L  
870 mm  
Lenght-L1  
836 mm



**Models Maxi-ATEGO**

1823-1828-2523-2528-2628 (Telai 950.500÷600 / 952.500÷600)

Versioni con Carico 9,0 Ton / Versions with 9,0 Ton Pay-load

Versioni con Freni a Disco - Version with Brake Discs

Ball Joint



**221.046**

M30x1,5

CEI no.  
**220.185**

O.E.M. Ref  
002 460 7705  
002 460 7805  
003 460 5105

Ø Tubo 36 mm

Lenght-L  
895 mm  
Lenght-L1  
866 mm



**Models Maxi-ATEGO**

1823-1828-2523-2528-2628 (Telai 950.500÷600 / 952.500÷600)

Versioni con Carico 7,5 Ton / Versions with 7,5 Ton Pay-load

Versioni con Freni a Tamburo / Versions with Drum Brake

Ball Joint



**221.034**

M28x1,5

CEI no.  
**220.059**

O.E.M. Ref  
001 460 6705  
000 460 7105  
000 460 7205

Ø Tubo 42 mm

Lenght-L  
879 mm  
Lenght-L1  
815 mm



**Models ACTROS**

1831-1835-1840-1843-2031-2040-2531-2540-2543-2548-2553-2631-2635-2640-2643-2648-

2657-3331-3335-3343-3348 (Telai 950.xxx) / 1831-1848-2031-2631-2640-2653-2657-3331-

3348-3340-3340 (Telai 952.xxx) / 2631-2635-2640-2643-3331-3340 (Telai 953.xxx) /

1831-1835-1840-1843-1853-1857-2031-2053-2640-2653-2657-3331-3357 (Telai 954.xxx)

Versioni con Freni a Disco - Version with Brake Discs

Ball Joint



**221.033**

M30x1,5

CEI no.  
**220.084**

O.E.M. Ref  
000 460 9305  
001 460 6905  
001 460 6905

Ø Tubo 40 mm

Lenght-L  
873 mm  
Lenght-L1  
808 mm



**Models ACTROS**

1831-1835-1840-1843-2531-2535-2543-2553-2557 (Telai 950.xxx) / 2531-2535-2543-2553-

2557 (Telai 952.xxx) / 1831-1843-1857-2640-2657 (Telai 954.xxx)

Versioni con Sospensione Pneumatica e Freni a Disco

For versions with Pneumatic Suspension and Brake Discs

Ball Joint



**221.033**

M30x1,5

All original equipment manufacturers' numbers, symbols, pictures, models and description used in this catalogue are for reference only, and it is not implied that any part listed is the product of these manufacturers. Tutti i nostri particolari non sono originali ma con essi intercambiabili. I riferimenti originali, le figure, i modelli sono esposti a semplice titolo indicativo. La nostra produzione riporta il nostro marchio.

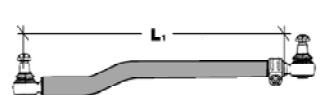
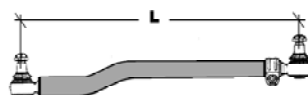

CEI no.  
**220.085**

O.E.M. Ref  
001 460 9805  
001 460 9905  
002 460 6305  
002 460 6405

Ø Tubo 38 mm

Lenght-L  
866 mm  
Lenght-L1  
812 mm



**Models ACTROS**

1831-1835-1840-1843-2031-2040-2527-2531-2540-2543-2548-2553-2631-2635-2640-2643-2648-2657-3331-3335-3343-3348 (Telai 950.xxx) / 1831-2031-2631-2653-2657-3331-3340-3348 (Telai 952.xxx) / 1831-1835-1840-1843-1857-2031-2053-2640-2653-3331-3357 (Telai 954.xxx)

Versioni con Balestre e Freni a Disco / Versions with Steel Spring Susp. and Brake Discs

**Ball Joint**



**221.033**

M30x1,5

CEI no.  
**220.081**

O.E.M. Ref  
001 460 0705  
001 460 0805  
001 460 7005

Ø Tubo 38 mm

Lenght-L  
888 mm  
Lenght-L1  
830 mm



**Models ACTROS**

2031-2035-3331-3340 (Telai 950.xxx) / 1831-1848-2031-2040-3331-3343-3348 (Telai 952.xxx) / 2031-2048-3331-3353 (Telai 954.xxx)

Versioni con Balestre e Freni a Tamburo / Versions with Steel Spring Susp. and Drum Brake

**Ball Joint**



**221.033**

M30x1,5

CEI no.  
**220.083**

O.E.M. Ref  
002 460 4805  
002 460 4705

Ø Tubo 40 mm

Lenght-L  
876 mm  
Lenght-L1  
824 mm



**Models ACTROS and NEW ACTROS (MP II)**

1831-1846-1848-1854-2046-2048-2531-2536-2554-2631-2646-2654-3331-3354-3358 (Telai 930.xxx) / 1831-1846-1850-2031-2046-2631-2646-2654-2658 (Telai 932.xxx) / 1823-1828-1831-1835-1840-1843-2031-2040-2531-2540-2543-2548-2553-2631-2635-2640-2643-2657-2648-3331-3335-3340-3343-3348 (Telai 950.xxx) / 1921-2031-2634-2653-2657 (Telai 952.xxx) / 2631-2635-2640-2643 (Telai 953.xxx) / 1831-1835-1840-1843-1543-2031-2053-2640-2653-2657-3331-3357-(Telai 954.xxx)

Versioni con Sospensione Pneumatica / Versions with Pneumatic Suspension

**Ball Joint**



**221.058**

M30x1,5

CEI no.  
**220.082**

O.E.M. Ref  
002 460 4305  
002 460 4405

Ø Tubo 36 mm

Lenght-L  
879 mm  
Lenght-L1  
822 mm



**Models Maxi-ATEGO - ACTROS and NEW ACTROS (MP II)**

1823-1828-1831-1846-1848-1854-2046-2048-2528-2531-2536-2554-2628-2631-2646-2654-3331-3354-3358 (Telai 930.xxx) / 1831-1846-1850-2031-2046-2631-2646-2654-2658 (Telai 932.xxx) / 1823-1828-1831-1835-1840-1843-2031-2040-2531-2540-2543-2548-2553-2631-2635-2640-2643-2657-2648-3331-3335-3340-3343-3348 (Telai 950.xxx) / 1921-2031-2634-2653-2657 (Telai 952.xxx) / 2631-2635-2640-2643 (Telai 953.xxx) / 1831-1835-1840-1843-1543-2031-2053-2640-2653-2657-3331-3357-(Telai 954.xxx)

Versioni con Balestre e Freni a Tamburo / Versions with Steel Spring Susp. and Drum Brake

**Ball Joint**



**221.034**

M28x1,5

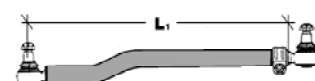
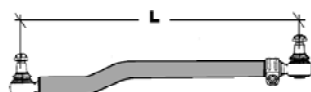



All original equipment manufacturers' numbers, symbols, pictures, models and description used in this catalogue are for reference only, and it is not implied that any part listed is the product of these manufacturers. Tutti i nostri particolari non sono originali ma con essi intercambiabili. I riferimenti originali, le figure, i modelli sono esposti a semplice titolo indicativo. La nostra produzione riporta il nostro marchio.

<p><b>CEI no.</b> <b>220.223</b></p> <p><b>O.E.M. Ref</b> 002 460 6205 002 460 6105</p>	<p><b>Lenght-L</b></p> <p><b>Lenght-L1</b></p>	 <<< NESSUNA IMMAGINE - NO PICTURE >>>	<p><b>Ball Joint</b></p>  <b>221.046</b> M30x1,5
<p><b>Models ACTROS and NEW ACTROS (MP II)</b>  <b>1823-1833</b> (Telai 952.xxx) / <b>3331-3353</b> (Telai 954.xxx)  <b>3331-3348</b> (Telai 932.xxx)          VL4 - VL5 Trazione Integrale /</p>			

<p><b>CEI no.</b> <b>220.226</b></p> <p><b>O.E.M. Ref</b> 002 460 5205 002 462 5105</p> <p><b>Ø Tubo 38 mm</b></p>	<p><b>Lenght-L</b> 885 mm</p> <p><b>Lenght-L1</b> 825 mm</p>		<p><b>Ball Joint</b></p>  <b>221.046</b> M30x1,5
<p><b>Models ACTROS and NEW ACTROS (MP II)</b>  <b>1823-1833</b> (Telai 952.xxx) / <b>3331-3353</b> (Telai 954.xxx)  <b>3331-3348</b> (Telai 932.xxx)          VL5 Trazione Integrale /          Versioni con Balestre e Freni a Tamburo / Versions with Steel Spring Susp. and Drum Brake</p>			

<p><b>CEI no.</b> <b>220.221</b></p> <p><b>O.E.M. Ref</b> 001 460 8105 001 460 5105</p> <p><b>Ø Tubo 42 mm</b></p>	<p><b>Lenght-L</b> 909 mm</p> <p><b>Lenght-L1</b></p>	 <<< NESSUNA IMMAGINE - NO PICTURE >>>	<p><b>Ball Joint</b></p>
<p><b>Models ACTROS and NEW ACTROS (MP II)</b>  <b>2531-2536</b> (Telai 950.xxx)  <b>2531-2536</b> (Telai 930.xxx)          VL4 Versione a 3 assali (6x2 - 6x4) /          Versioni con Balestre e Freni a Disco / Versions with Steel Spring Susp. and Brake Discs</p>			

<p><b>CEI no.</b> <b>220.225</b></p> <p><b>O.E.M. Ref</b> 002 460 6005 002 460 5905</p> <p><b>Ø Tubo 38 mm</b></p>	<p><b>Lenght-L</b> 935 mm</p> <p><b>Lenght-L1</b></p>	 <<< NESSUNA IMMAGINE - NO PICTURE >>>	<p><b>Ball Joint</b></p>  <b>221.046</b> M30x1,5
<p><b>Models ACTROS and NEW ACTROS (MP II)</b>  <b>3331</b> (Telai 954.xxx)  <b>3331-3348</b> (Telai 932.xxx)          VL4 Versione a 3 assali (6x2 - 6x4) /          Versioni con Balestre e Freni a Disco / Versions with Steel Spring Susp. and Brake Discs</p>			

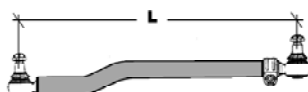

Note Tecniche  
Technical Notes  
L = mm  
L1 = mm

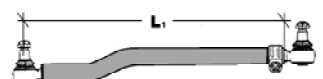

CEI no.  
**220.227**

O.E.M. Ref  
001 460 7105  
000 460 9505

Ø Tubo 52 mm

Lenght-L  
904 mm  
Lenght-L1  
855 mm



**Models ACTROS and NEW ACTROS (MP II)**

3335-3243 (Telai 953.xxx)

4140-4148 (Telai 932.xxx)

VL4 Versione a 4 assali (8x2 - 8x4) /

Versioni con Balestre e Freni a Disco / Versions with Steel Spring Susp. and Brake Discs

Ball Joint



**221.046**

M30x1,5

CEI no.  
220.222

O.E.M. Ref  
002 460 9005  
002 460 9105

Lenght-L

Lenght-L1



<<< NESSUNA IMMAGINE - NO PICTURE >>>

**Models ACTROS and NEW ACTROS (MP II)**

4140 (Telai 953.xxx)

4140-4148 (Telai 932.xxx)

VL4 Versione a 4 assali (8x2 - 8x4) /

Ball Joint

CEI no.  
220.224

O.E.M. Ref  
002 460 9305  
002 460 9205

Ø Tubo 42 mm

Lenght-L

Lenght-L1



<<< NESSUNA IMMAGINE - NO PICTURE >>>

**Models ACTROS and NEW ACTROS (MP II)**

4140 (Telai 953.xxx)

4140-4148 (Telai 932.xxx)

VL4 Versione a 4 assali (8x2 - 8x4) /

Ball Joint



**221.046**

M30x1,5

CEI no.  
**220.028**

O.E.M. Ref  
300 460 0505  
300 460 0405  
301 460 0505

Tubo / Tube Ø 38 mm

Lenght-L  
1146 mm  
Lenght-L1  
1110 mm



**Models BUSES**

O 303 (Telai CH 300.xxx - 301.xxx - 600.xxx)

O 305 (Telai CH 307.xxx)

In coppia con il 220.027 / Together with 220.027

Dalla Leva Sterzo al Supporto Intermedio / From Steering Lever to Intermediate Support

Ball Joint



**198.630**

M30x1,5

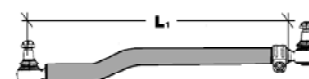
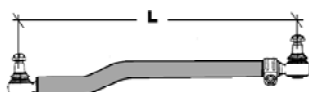



CEI no.  
**220.027**

O.E.M. Ref  
300 460 0705  
300 460 0605  
305 460 0305

Tubo / Tube Ø 36 mm

Lenght-L  
975 mm  
Lenght-L1  
930 mm



**Models BUSES**

**O 303** (Telai CH 300.xxx - 301.xxx - 600.xxx)  
**O 305** (Telai CH 307.xxx)

In coppia con il 220.028 / Together with 220.028

Dal Supporto Intermedio al Supporto Posteriore / From Intermediate Support to Rear Support

**Ball Joint**



**198.630**  
M30x1,5

CEI no.  
**220.154**

O.E.M. Ref  
356 330 0003  
613 330 0003

2 pcs. x Bus

Tubo / Tube Ø 32 mm

Lenght-L  
697 mm  
Lenght-L1



<<< NESSUNA IMMAGINE - NO PICTURE >>>

**Models BUSES**

**O 404** (Telai CH 356.xxx) - **O 350** (Telai CH 613.xxx)

In coppia con / Together with : 220.155

Dal Supporto Intermedio alla leva guida / From Intermediate Support to Drive Lever

**Ball Joint**



221.060  
M24x1,5

**Ball Joint**



221.059  
M24x1,5

CEI no.  
**220.155**

O.E.M. Ref  
356 330 0103  
613 330 0103

Tubo / Tube Ø 30 mm

Lenght-L  
506 mm  
Lenght-L1



<<< NESSUNA IMMAGINE - NO PICTURE >>>

**Models BUSES**

**O 404** (Telai CH 356.xxx) - **O 350** (Telai CH 613.xxx)

Teste Fisse-In coppia con / Fixed Joint Together with: 220.154

Dal Supporto Intermedio al Supporto Centrale / From Intermediate Support to Central Support

**Ball Joint**

CEI no.  
**220.050**

O.E.M. Ref  
393 330 0303  
393 330 0403  
393 330 0003  
350 330 7203

Ø Tubo 50 mm

Lenght-L  
1620 mm  
Lenght-L1  
1515 mm

**Barra di Accoppiamento - Assale Anteriore / Drag Link - Front Axle**



**Models NG**

Assali / Axles : 739.008-018-019-020-030-031-032-033-037-038-039-042-048-054-055-056-059-060-061-062-063-064-065-066-067-072-074-076-077-078-079-080-081-082-083-100-102-109-110-118-119-133-134-135-137-141-142-143-144-146-147-148-148-150 To 187

**Ball Joint**



**198.524**  
M30x1,5

**Ball Joint**



**198.525**  
M30x1,5

All original equipment manufacturers' numbers, symbols, pictures, models and description used in this catalogue are for reference only, and it is not implied that any part listed is the product of these manufacturers. Tutti i nostri particolari non sono originali ma con essi intercambiabili. I riferimenti originali, le figure, i modelli sono esposti a semplice titolo indicativo. La nostra produzione riporta il nostro marchio.

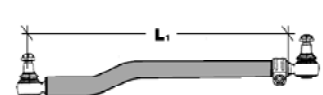
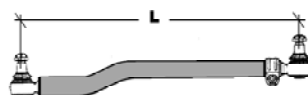

CEI no.  
**220.042**

O.E.M. Ref  
625 330 2503  
625 330 2403  
625 330 1603  
625 330 1503

Ø Tubo 50 mm

Lenght-L  
1590 mm  
Lenght-L1  
1510 mm

Barra di Accoppiamento - Assale Anteriore / Drag Link - Front Axle



**Models MK / LK / SK**

Assali / Axles : 739.004-005-006-009-012-013-036-046-050-051-057-091-116-117-189-190-400-401-410-411-431-432-433-434-435-436-437-438-439-440-441-442-443-444-445-560-580

1a generazione / 1st generation

Ball Joint



**221.045**

M30x1,5

Ball Joint



**221.046**

M30x1,5

CEI no.  
**220.164**

O.E.M. Ref  
942 330 0803  
949 330 0203  
949 330 0903  
949 330 0303

Ø Tubo 52 mm

Lenght-L  
1625 mm  
Lenght-L1  
1525 mm

Barra di Accoppiamento - Assale Anteriore / Drag Link - Front Axle



**Models MK / LK / SK**

Assali / Axles : 739.004-005-006-009-012-013-036-046-050-051-057-091-116-117-189-190-400-401-410-411-431-432-433-434-435-436-437-438-439-440-441-442-443-444-445-560-580

2a generazione / 2nd generation

Ball Joint



**221.045**

M30x1,5

Ball Joint



**221.046**

M30x1,5

CEI no.  
**220.043**

O.E.M. Ref  
620 330 0503  
620 330 0603  
620 330 0003

Ø Tubo 50 mm

Lenght-L  
1665 mm  
Lenght-L1  
1565 mm

Barra di Accoppiamento - Assale Anteriore / Drag Link - Front Axle



**Models MK / LK / SK**

Assali / Axles : 739.006-007-016-017-040-041-043-044-045-047-049-052-053-068-069-070-071-073-099-115-120-140-308-312-337

Ball Joint



**198.524**

M30x1,5

Ball Joint



**198.525**

M30x1,5

CEI no.  
**220.182**

O.E.M. Ref  
970 330 0003  
970 330 0103  
970 330 0203  
970 330 0303

Ø Tubo 40 mm

Lenght-L  
1640 mm  
Lenght-L1  
1573 mm

Barra di Accoppiamento - Assale Anteriore / Drag Link - Front Axle



**Models ATEGO**

Assale / Axles : 730.711-712-713-714-715-716-717-719

Ball Joint



**198.629**

M30x1,5

Ball Joint



**198.630**

M30x1,5

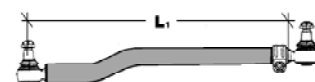
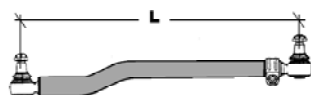

CEI no.  
**220.089**

O.E.M. Ref  
945 330 0203  
945 330 0303  
945 330 0503

Ø Tubo 40 mm

Lenght-L  
1465 mm  
Lenght-L1  
1355 mm

Barra di Accoppiamento - Assale Anteriore / Drag Link - Front Axle



**Models ACTROS**

**Models NEW ACTROS (MP II)**

Assale / Axles : 739.500-510-520-530-531-540-541-542-543-544-550

Ball Joint



**221.045**

M30x1,5

Ball Joint



**221.046**

M30x1,5

CEI no.  
**220.090**

O.E.M. Ref  
942 330 0903  
942 330 0503  
942 330 0603

Ø Tubo 50 mm

Lenght-L  
1565 mm  
Lenght-L1  
1455 mm

Barra di Accoppiamento - Assale Anteriore / Drag Link - Front Axle



**Models ACTROS, NEW ACTROS**

**Models Maxi-ATEGO**

Assale / Axles : 739.015-058-123-500-510-520-530-531-540-541-542-543-544-550

Ball Joint



**221.045**

M30x1,5

Ball Joint



**221.046**

M30x1,5

CEI no.  
**220.164**

O.E.M. Ref  
942 330 0803  
949 330 0203  
949 330 0903

Ø Tubo 52 mm

Lenght-L  
1625 mm  
Lenght-L1  
1525 mm

Barra di Accoppiamento - Assale Anteriore / Drag Link - Front Axle



**Models ACTROS & NEW ACTROS**

Assali / Axles : 739.005-009-012-013-014-116-117-122-123-189-190-196-400-401-410-411-430-431-432-433-434-435-436-437-438-439-440-441-442-443-444-445-500-510-520-531-540-541-542-543-544-550-560-561-570-580

Ball Joint



**221.045**

M30x1,5

Ball Joint



**221.046**

M30x1,5

CEI no.  
**220.086**

O.E.M. Ref  
941 330 0103  
941 330 0203  
941 330 0003

Ø Tubo 50 mm

Lenght-L  
1735 mm  
Lenght-L1  
1630 mm

Barra di Accoppiamento - Assale Anteriore / Drag Link - Front Axle



**Models ACTROS & NEW ACTROS (MP II)**

Assale / Axles : 739.500-510-520-530-531-540-541-542-543-544-550

Ball Joint



**221.045**

M30x1,5

Ball Joint



**221.046**

M30x1,5

All original equipment manufacturers' numbers, symbols, pictures, models and description used in this catalogue are for reference only, and it is not implied that any part listed is the product of these manufacturers. Tutti i nostri particolari non sono originali ma con essi intercambiabili. I riferimenti originali, le figure, i modelli sono esposti a semplice titolo indicativo. La nostra produzione riporta il nostro marchio.

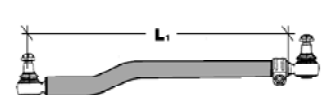
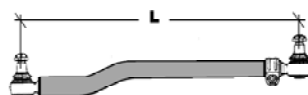

CEI no.  
**220.088**

O.E.M. Ref  
945 330 0103  
945 330 0003  
945 330 0403  
945 330 0603

Ø Tubo 62 mm

Lenght-L  
1735 mm  
Lenght-L1  
1646 mm

Barra di Accoppiamento - Assale Anteriore / Drag Link - Front Axle



**Models ACTROS & NEW ACTROS (MP II)**  
Assale / Axles : 739.500-510-520-530-531-540-541-542-543-544-550

Ball Joint



**221.061**  
M30x1,5

CEI no.  
**220.087**

O.E.M. Ref  
942 330 0103  
942 330 0003  
942 330 0203  
942 330 0703

Ø Tubo 52 mm

Lenght-L  
1735 mm  
Lenght-L1  
1665 mm

Barra di Accoppiamento - Assale Anteriore / Drag Link - Front Axle



**Models ACTROS & NEW ACTROS (MP II)**  
**Models Maxi-ATEGO**  
Assale / Axles : 739.500-510-520-530-531-540-541-542-543-544-550

Ball Joint



**221.046**  
M30x1,5

CEI no.  
**220.125**

O.E.M. Ref  
944 330 0203  
625 330 1203  
625 330 0903

Ø Tubo 60 mm

Lenght-L  
1580 mm  
Lenght-L1  
1532 mm

Barra di Accoppiamento - Assale Anteriore / Drag Link - Front Axle



**Models ACTROS & NEW ACTROS (MP II)**  
Assale / Axles : 730.101-109-111-119  
Assale / Axles : 730.900-910-911-913-915-917-918-921-923-925

Ball Joint

221.094  
M38x1,5

All original equipment manufacturers' numbers, symbols, pictures, models and description used in this catalogue are for reference only, and it is not implied that any part listed is the product of these manufacturers. Tutti i nostri particolari non sono originali ma con essi intercambiabili. I riferimenti originali, le figure, i modelli sono esposti a semplice titolo indicativo. La nostra produzione riporta il nostro marchio.

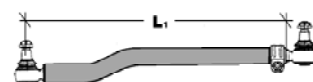
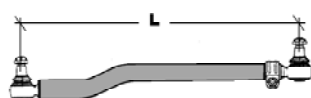

All original equipment manufacturers' numbers, symbols, pictures, models and description used in this catalogue are for reference only, and it is not implied that any part listed is the product of these manufactures. Tutti i nostri particolari non sono originali ma con essi intercambiabili. I riferimenti originali, le figure, i modelli sono esposti a semplice titolo indicativo. La nostra produzione riporta il nostro marchio.

**CEI no.**  
**220.127**

**O.E.M. Ref**  
81 46610 6305  
81 46610 6301  
81 46610 6328

**Ø Tubo 34 mm**

**Lenght-L**  
785 mm

**Lenght-L1**  
740 mm



**Models G90**  
6 Ton / 8 Ton / 9 Ton / 10 Ton (Telai / Chassis L xx Year 87'÷94')

**Ball Joint**  
  
**198.477**  
M28x1,5

**CEI no.**  
**220.156**

**O.E.M. Ref**  
85 46610 6104  
81 46610 6754  
81 46610 6753  
85 46610 6006  
85 46610 6031

**Ø Tubo 38 mm**

**Lenght-L**  
825 mm

**Lenght-L1**  
780 mm



**Models L2000-M2000**  
6 Ton / 8 Ton / 9 Ton / 10 Ton (Telai / Chassis L xx-Mxx Year 93' →)

**Ball Joint**  
  
**198.477**  
M28x1,5

**CEI no.**  
**220.207**

**O.E.M. Ref**  
85 46610 6102  
85 46610 6201  
85 46610 6030  
81 46610 6725

**Ø Tubo 32 mm**

**Lenght-L**  
850 mm

**Lenght-L1**  
826 mm



**Models L2000-M2000**  
6 Ton / 8 Ton / 9 Ton / 10 Ton (Telai / Chassis L xx-Mxx Year 93' →)

**Ball Joint**  
  
**221.022**  
M24x1,5

**CEI no.**  
**220.231**

**O.E.M. Ref**  
85 46610 6103  
85 46610 6202  
85 46610 6032  
85 46610 6003

**Lenght-L**

**Lenght-L1**



<<< NESSUNA IMMAGINE - NO PICTURE >>>

**Models L2000**  
8 Ton / 9 Ton / 10 Ton (Telai / Chassis Mxx Year 94' →)

**Veicoli 4x4 - 4x4 Models**

**Ball Joint**  
  
**198.630**  
M30x1,5

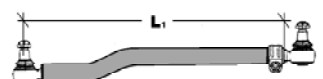
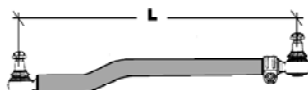



CEI no.  
**220.236**

O.E.M. Ref  
85 46610 6141  
85 46610 6205  
85 46610 6231  
85 46610 6105  
85 46610 6051  
Ø Tubo 38 mm

Lenght-L  
795 mm  
Lenght-L1  
745 mm



**Models L2000-M2000-TGL**  
11 / 12 / 13 / 14 / 15 / 20 Ton (Telai / Chassis L xx- Mxx- Nxx Year 95' →)

**Ball Joint**  
  
**198.630**  
M30x1,5

CEI no.  
**220.238**

O.E.M. Ref  
85 46610 6142  
85 46610 6212  
85 46610 6234  
85 46610 6112  
85 46610 6050  
Ø Tubo 38 mm

Lenght-L  
860 mm  
Lenght-L1  
810 mm



**Models L2000-M2000-TGL**  
11 / 12 / 13 / 14 / 15 / 20 Ton (Telai / Chassis L xx- Mxx- Nxx Year 95' →)

*Balestre Paraboliche / Parabolic Suspension*

**Ball Joint**  
  
**198.630**  
M30x1,5

CEI no.  
**220.228**

O.E.M. Ref  
85 46610 6140  
85 46610 6221  
85 46610 6121  
85 46610 6021  
Ø Tubo 38 mm

Lenght-L  
840 mm  
Lenght-L1  
800 mm



**Models L2000-M2000-TGL**  
11 Ton / 12 Ton (Telai / Chassis L xx- Mxx- Nxx Year 95' →)

**Ball Joint**  
  
**198.477**  
M28x1,5

CEI no.  
**220.237**

O.E.M. Ref  
85 46610 6143  
85 46610 6207  
85 46610 6107  
Ø Tubo 38 mm

Lenght-L  
860 mm  
Lenght-L1



<<< NESSUNA IMMAGINE - NO PICTURE >>>

**Models L2000**  
18 Ton / 19 Ton / 26 Ton (Telai / Chassis L xx Year 95' →)

**Ball Joint**  
  
**221.033**  
M30x1,5

CEI no.  
**220.234**

O.E.M. Ref  
81 46710 6436  
81 46710 6437  
81 46710 6455

Ø Tubo 40 mm

Lenght-L  
955 mm  
Lenght-L1  
905 mm



**Models M2000**  
12 Ton / 13 Ton / 14 Ton / 15 Ton (Telai / Chassis Mxx Year 88 '→)

**Ball Joint**  
  
**198.630**  
M30x1,5

CEI no.  
**220.241**

O.E.M. Ref  
85 46610 6150  
85 46610 6119  
85 46610 6019

Ø Tubo 40 mm

Lenght-L  
910 mm  
Lenght-L1  
855 mm



**Models M2000**  
12 Ton / 13 Ton / 14 Ton (Telai / Chassis Mxx Year 95 '→)

**Ball Joint**  
  
**198.630**  
M30x1,5

CEI no.  
**220.242**

O.E.M. Ref  
85 46610 6151  
85 46610 6020  
81 46610 6695  
81 46610 6693

Ø Tubo 40 mm

Lenght-L  
975 mm  
Lenght-L1  
915 mm



**Models M2000**  
12 Ton / 13 Ton / 14 Ton (Telai / Chassis Mxx Year 95 '→)

**Ball Joint**  
  
**198.630**  
M30x1,5

CEI no.  
**220.232**

O.E.M. Ref  
81 46710 6442  
81 46710 6443  
81 46710 6460

Ø Tubo 42 mm

Lenght-L  
1005 mm  
Lenght-L1  
950 mm



**Models M2000**  
15 Ton / 17 Ton / 18 Ton / 24 Ton (Telai / Chassis Mxx Year 87 '→)

**Ball Joint**  
  
**198.525**  
M30x1,5

All original equipment manufacturers' numbers, symbols, pictures, models and description used in this catalogue are for reference only, and it is not implied that any part listed is the product of these manufactures. Tutti i nostri particolari non sono originali ma con essi intercambiabili. I riferimenti originali, le figure, i modelli sono esposti a semplice titolo indicativo. La nostra produzione riporta il nostro marchio.

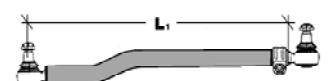
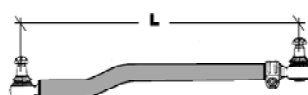

CEI no.  
**220.233**

O.E.M. Ref  
81 46710 6438  
81 46710 6439  
81 46710 6452

Ø Tubo 40 mm

Lenght-L  
1000 mm  
Lenght-L1  
950 mm



**Models M2000**  
17 Ton / 18 Ton / 24 Ton (Telai / Chassis Mxx Year 87' →)

Ball Joint



**198.630**  
M30x1,5

CEI no.  
**220.230**

O.E.M. Ref  
85 46610 6152  
85 46610 6218  
85 46610 6118  
85 46610 6018

Ø Tubo 42 mm

Lenght-L  
980 mm  
Lenght-L1  
925 mm



**Models M2000**  
18 Ton / 23 Ton / 25 Ton (Telai / Chassis Mxx Year 95' →)

Ball Joint



**221.033**  
M30x1,5

CEI no.  
**220.229**

O.E.M. Ref  
85 46610 6155  
85 46610 6222  
85 46610 6122  
85 46610 6022

Ø Tubo 42 mm

Lenght-L  
1020 mm  
Lenght-L1



<<< NESSUNA IMMAGINE - NO PICTURE >>>

**Models M2000**  
18 Ton / 25 Ton (Telai / Chassis L xx- Mxx Year 95' →)

Ball Joint



**198.525**  
M30x1,5

CEI no.  
**220.245**

O.E.M. Ref  
85 46610 6244

Lenght-L  
Lenght-L1



<<< NESSUNA IMMAGINE - NO PICTURE >>>

**Models TGL**  
7,5 Ton (Telai / Chassis Nxx Year 04' →)

Ball Joint

**CEI no.**  
**220.244**  
**O.E.M. Ref**  
85 46610 6245

**Lenght-L**  
**Lenght-L1**



<<< NESSUNA IMMAGINE - NO PICTURE >>>

**Models TGL**  
7,5 Ton (Telai / Chassis Nxx Year 04' →)

**Ball Joint**

**CEI no.**  
**220.246**  
**O.E.M. Ref**  
85 46610 6246

**Lenght-L**  
864 mm  
**Lenght-L1**



<<< NESSUNA IMMAGINE - NO PICTURE >>>

**Models TGL**  
8 Ton (Telai / Chassis Nxx Year 04' →)

**Ball Joint**

Ø Tubo 38 mm

**CEI no.**  
**220.247**  
**O.E.M. Ref**  
85 46610 6247

**Lenght-L**  
**Lenght-L1**



<<< NESSUNA IMMAGINE - NO PICTURE >>>

**Models TGL**  
8 Ton (Telai / Chassis Nxx Year 04' →)

**Ball Joint**

**CEI no.**  
**220.249**  
**O.E.M. Ref**  
85 46610 6162

**Lenght-L**  
820 mm  
**Lenght-L1**



<<< NESSUNA IMMAGINE - NO PICTURE >>>

**Models TGL**  
8 Ton (Telai / Chassis Nxx Year 04' →)

**Ball Joint**

Ø Tubo 38 mm

All original equipment manufacturers' numbers, symbols, pictures, models and description used in this catalogue are for reference only, and it is not implied that any part listed is the product of these manufacturers. Tutti i nostri particolari non sono originali ma con essi intercambiabili. I riferimenti originali, le figure, i modelli sono esposti a semplice titolo indicativo. La nostra produzione riporta il nostro marchio.

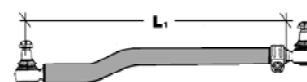
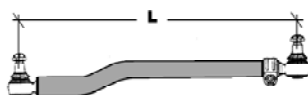

CEI no.

220.250

O.E.M. Ref

85 46610 6166

Lenght-L

Lenght-L1



<<< NESSUNA IMMAGINE - NO PICTURE >>>

Models **TGM**

15 Ton / 16 Ton (Telai / Chassis Nxx Year 05' →)

Ball Joint

CEI no.

220.248

O.E.M. Ref

85 46610 6163

Lenght-L

Lenght-L1



<<< NESSUNA IMMAGINE - NO PICTURE >>>

Models **TGM**

18 Ton / 26 Ton (Telai / Chassis Nxx Year 04' →)

Ball Joint

Ø Tubo 38 mm

CEI no.

**220.007**

O.E.M. Ref

81 46610 6722

81 46610 6723

81 46610 6721

81 46610 6361

81 46610 6360

Ø Tubo 50 mm

Lenght-L

1030 mm

Lenght-L1

985 mm



Models **F90- F2000**

16.281÷361 / 19.281÷361 / 22.281÷361 / 24.281÷361 / 26.281÷361 / 32.281÷361 / 33.281÷361 / 34.281÷361 (Telai 503÷509 Year 79'÷90')

16 Ton / 17 Ton / 19 Ton / 24 Ton / 26 Ton / 28 Ton / 30 Ton / 31 Ton / 32 Ton / 33 Ton / 34 Ton / 35 Ton (Telai E xx- F xx- T xx- U xx Year 85' →)

Ball Joint



**198.525**

M30x1,5

CEI no.

**220.286**

O.E.M. Ref

81 46710 6418

Lenght-L

1795 mm

Lenght-L1

1732 mm



Models **F90**

28 Ton / 30 Ton / 31 Ton / 32 Ton / 33 Ton / 34 Ton / 35 Ton / 38 Ton (Telai F xx Year 97' →)

Veicoli con sterzo a singolo e doppio circuito idraulico regolabile

Vesrion with single and double hydraulic adjustable steering system

Ball Joint

Ø Tubo 50 mm

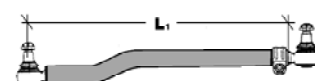
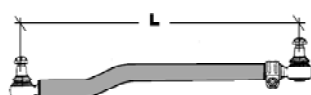



All original equipment manufacturers' numbers, symbols, pictures, models and description used in this catalogue are for reference only, and it is not implied that any part listed is the product of these manufacturers. Tutti i nostri particolari non sono originali ma con essi intercambiabili. I riferimenti originali, le figure, i modelli sono esposti a semplice titolo indicativo. La nostra produzione riporta il nostro marchio.

**CEI no.**  
**220.285**

**O.E.M. Ref**  
82 46610 6191  
81 46610 6790  
81 46610 6775  
81 46610 6791  
81 46610 6797  
**Ø Tubo 50 mm**

**Lenght-L**  
1755 mm  
**Lenght-L1**  
1705 mm



**Models F2000**

32 Ton / 33 Ton / 34 Ton / 35 Ton / 38 Ton / 41 Ton (Telai F xx Year 00' →)

*Veicoli con sterzo a singolo e doppio circuito idraulico regolabile*  
*Vehicles with single and double hydraulic adjustable steering system*

**Ball Joint**

**CEI no.**  
**220.130**

**O.E.M. Ref**  
81 46611 6197  
81 46611 6133  
81 46611 6132  
81 46611 6097  
81 46611 6096  
**Ø Tubo 60 mm**

**Lenght-L**  
963 mm  
**Lenght-L1**  
935 mm



**Models TGA**

18 Ton / 26 Ton / 33 Ton / 35 Ton / 41 Ton (Telai / Chassis H xx Year 99' →)

**Ball Joint**



**221.062**  
M30x1,5

**CEI no.**  
**220.196**

**O.E.M. Ref**  
81 46611 6199  
81 46611 6200  
81 46611 6206  
81 46611 6137  
81 46611 6135  
**Ø Tubo 52 mm**

**Lenght-L**  
950 mm  
**Lenght-L1**  
915 mm



**Models TGA**

18 Ton / 23 Ton / 25 Ton / 33 Ton (Telai / Chassis Mxx Year 99' →)

**Ball Joint**



**198.525**  
M30x1,5

**CEI no.**  
**220.251**

**O.E.M. Ref**  
81 46611 6201  
81 46611 6202  
81 46611 6203  
81 46611 6139  
81 46611 6138  
**Ø Tubo 52 mm**

**Lenght-L**  
1021 mm  
**Lenght-L1**



<<< NESSUNA IMMAGINE - NO PICTURE >>>

**Models TGA**

18 Ton / 26 Ton / 33 Ton / 35 Ton / 40 Ton / 41 Ton (Telai / Chassis Mxx Year 02' →)

**Ball Joint**



**198.525**  
M30x1,5

**CEI no.**  
**220.009**

**O.E.M. Ref**  
81 46711 6725  
81 46710 6354  
81 46710 6353  
81 46710 6361  
81 46710 6198  
Ø Tubo 50 mm

**Lenght-L**  
1652 mm  
**Lenght-L1**  
1540 mm

**Barra di Accoppiamento - Assale Anteriore / Drag Link - Front Axle**



**Models G-M-F 90 / L-M-F 2000**  
16 / 19 / 22 / 24 / 26 / 32 / 33 / 34.281÷361 (Telai 503÷546 Year 79'÷90')  
16 / 17 / 18 / 19 / 24 / 26 / 28 / 30 / 31 / 32 / 33 / 34 / 35 Ton (Telai E - F - L - M - T - U Year 85' →)

**Ball Joint**



**198.524**  
M30x1,5

**Ball Joint**



**198.525**  
M30x1,5

**CEI no.**  
**220.044**

**O.E.M. Ref**  
81 46711 6724  
81 46710 6904  
81 46710 6816  
81 46710 6397  
81 46710 6396  
Ø Tubo 50 mm

**Lenght-L**  
1628 mm  
**Lenght-L1**  
1570 mm

**Barra di Accoppiamento - Assale Anteriore / Drag Link - Front Axle**



**Models G-M-F 90 / L-M-F 2000**  
16 / 17 / 18 / 19 / 24 / 26 / 28 / 30 / 31 / 32 / 33 / 34 / 35 Ton (Telai E - F - L - M - T - U Year 85' →)

Terzo asse sterzante / 3rd Steering Axle  
In coppia con il 220.009 / Together with 220.009

**Ball Joint**



**198.525**  
M30x1,5

**CEI no.**  
**220.287**

**O.E.M. Ref**  
81 46711 6736  
81 46710 6912  
81 46710 6830  
Ø Tubo 52 mm

**Lenght-L**  
1572 mm  
**Lenght-L1**  
1532 mm

**Barra di Accoppiamento - Assale Anteriore / Drag Link - Front Axle**



**Models F 90 - F 2000 - TGA**  
19 / 24 / 26 / 28 / 30 / 31 / 32 / 33 / 34 / 35 Ton (Telai F - T - H Year 85' →)

Avantreno / Front Axle VA9-0950

**Ball Joint**



**221.033**  
M30x1,5

**CEI no.**  
**220.009**

**O.E.M. Ref**  
81 46711 6725  
81 46710 6354  
81 46710 6353  
81 46710 6361  
81 46710 6198  
Ø Tubo 50 mm

**Lenght-L**  
1652 mm  
**Lenght-L1**  
1540 mm

**Barra di Accoppiamento - Assale Anteriore / Drag Link - Front Axle**



**Models TGA**  
18 Ton / 26 Ton / 33 Ton / 35 Ton / 41 Ton (Telai H xxx Year 99' →)

**Ball Joint**



**198.524**  
M30x1,5

**Ball Joint**



**198.525**  
M30x1,5

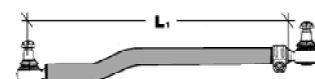
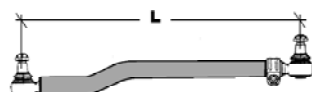

CEI no.  
**220.197**

O.E.M. Ref  
81 46711 6860  
81 46711 6773  
81 46711 6858  
84 46711 6863  
81 46711 6861  
Ø Tubo 52 mm

Lenght-L  
1660 mm  
Lenght-L1  
1610 mm

Barra di Accoppiamento - Assale Anteriore / Drag Link - Front Axle



**Models TGA**  
18 Ton / 26 Ton / 33 Ton / 35 Ton / 41 Ton (Telai H xxx  
Year 99' →)

Ball Joint



221.086  
M30x1,5

CEI no.  
**220.039**

O.E.M. Ref  
81 46711 6759  
81 46711 6760  
81 46711 6761  
81 46710 6877  
81 46710 6879  
Ø Tubo 40 mm

Lenght-L  
728 mm  
Lenght-L1

Barra di Accoppiamento - Assale Anteriore / Drag Link - Front Axle



**Models BUSES**  
SG 242-292-322 (Telai 793-888 Year 87' →)  
SG 280-290-292 ISRAEL (Telai 887-897 Year 87' →)  
Teste Fisse / Fixes Joint

Ball Joint

All original equipment manufacturers' numbers, symbols, pictures, models and description used in this catalogue are for reference only, and it is not implied that any part listed is the product of these manufactures.  
Tutti i nostri particolari non sono originali ma con essi intercambiabili. I riferimenti originali, le figure, i modelli sono esposti a semplice titolo indicativo. La nostra produzione riporta il nostro marchio.

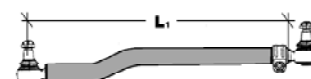
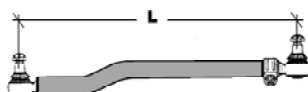

**CEI no.**  
**220.157**  
**O.E.M. Ref**  
50 00 446 680

**Lenght-L**  
898 mm  
**Lenght-L1**



<<< NESSUNA IMMAGINE - NO PICTURE >>>

**Models JK - S**  
JK 55-60-65-75  
S 100-130

**Ball Joint**  
  
**221.022**  
M24x1,5

Ø Tubo 30 mm

**CEI no.**  
**220.093**  
**O.E.M. Ref**  
50 00 541 230  
50 00 352 082  
50 00 352 083

**Lenght-L**  
880 mm  
**Lenght-L1**



<<< NESSUNA IMMAGINE - NO PICTURE >>>

**Models JE - S**  
JE 13-15 / JP 11-13 / JR 19-21 / J 4x4  
S 130-150-170 / S 4x4

**Ball Joint**  
  
**221.063**  
M30x1,5

Ø Tubo 40 mm

**CEI no.**  
**220.063**  
**O.E.M. Ref**  
50 10 130 456  
50 10 037 603  
50 10 037 602

**Lenght-L**  
885 mm  
**Lenght-L1**  
845 mm



**Models M - S - MIDLINER**  
M 150-180-210-220-230-250  
S 100-110-120-130-135-140-150-160-180-210-220-230(TI)-250  
MIDLINER GB  
1a Generazione / 1a generazione

**Ball Joint**  
  
**198.477**  
M28x1,5

Ø Tubo 40 mm

**CEI no.**  
**220.024**  
**O.E.M. Ref**  
50 10 130 393  
74 85 114 936

**Lenght-L**  
872 mm  
**Lenght-L1**  
825 mm



**Models M - S**  
M 140-150-160-180-200-210-220-230-250  
S 150-180-210-220-230-250 / MIDLINER GB  
2a Generazione / 2a generazione  
Versioni con Carico 11-12 Ton / Versions with 11-12 Ton Pay-load

**Ball Joint**  
  
**221.063**  
M30x1,5

Ø Tubo 40 mm

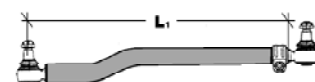
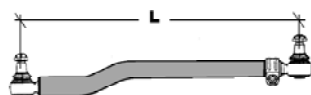

CEI no.  
**220.091**  
O.E.M. Ref  
50 10 294 199

Lenght-L  
870 mm  
Lenght-L1  
815 mm



**Models M - S**  
M 150-180-210-220-230-250  
S 150-180-210-220-230-250

2a Generazione / 2a generazione  
Versioni con Carico **15 Ton** / Versions with **15 Ton** Pay-load

**Ball Joint**  
  
221.063  
M30x1,5

Ø Tubo 38 mm

CEI no.  
220.100  
O.E.M. Ref  
50 10 383 410

Lenght-L  
570 mm  
Lenght-L1  
473 mm



**Models MASCOTT**  
MASCOTT

**Ball Joint**  
  
221.065  
M24x1,5

**Ball Joint**  
  
221.066  
M24x1,5

Ø Tubo 30 mm

CEI no.  
**220.158**  
O.E.M. Ref  
50 10 488 164

Lenght-L  
883 mm  
Lenght-L1  
847 mm



**Models MIDLUM**  
MIDLUM (7 Ton)

**Ball Joint**  
  
221.067  
M28x1,5

Ø Tubo 42 mm

CEI no.  
**220.092**  
O.E.M. Ref  
50 10 488 165

Lenght-L  
883 mm  
Lenght-L1  
844 mm



**Models MIDLUM**  
MIDLUM (10-12 Ton)

**Ball Joint**  
  
221.067  
M28x1,5

Ø Tubo 42 mm

All original equipment manufacturers' numbers, symbols, pictures, models and description used in this catalogue are for reference only, and it is not implied that any part listed is the product of these manufacturers. Tutti i nostri particolari non sono originali ma con essi intercambiabili. I riferimenti originali, le figure, i modelli sono esposti a semplice titolo indicativo. La nostra produzione riporta il nostro marchio.

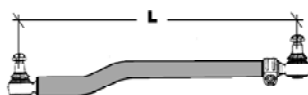

Note Tecniche  
Technical Notes  
L = mm  
L1 = mm

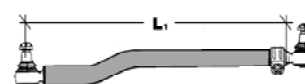



CEI no.  
**220.159**

O.E.M. Ref  
50 10 488 166

Ø Tubo 40 mm

Lenght-L  
924 mm  
Lenght-L1  
890 mm

Models **MIDLUM**  
MIDLUM (12 Ton)



Ball Joint



221.068  
M30x1,5

CEI no.  
**220.104**

O.E.M. Ref  
50 10 488 167  
50 10 305 367

Ø Tubo 42 mm

Lenght-L  
946 mm  
Lenght-L1  
895 mm

Models **MIDLUM**  
MIDLUM (14-15-16 Ton)



Ball Joint

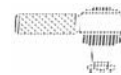

221.068  
M30x1,5

CEI no.  
**220.160**

O.E.M. Ref  
50 10 488 146

Ø Tubo 42 mm

Lenght-L  
930 mm  
Lenght-L1  
891 mm

Models **MIDLUM**  
MIDLUM (EXPORT 13-16 Ton)



Ball Joint



221.063  
M30x1,5

CEI no.  
220.022

O.E.M. Ref  
50 10 130 483  
50 00 787 472

Ø Tubo 52 mm

Lenght-L  
825 mm  
Lenght-L1  
790 mm

Models **C - CLR**  
C 210-230-260-280-290-300-340(TI)  
CLR 220 / CCH 300





Ball Joint

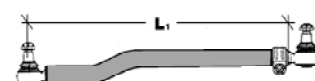
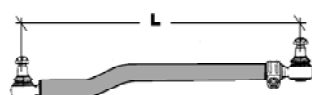

**198.657**  
M30x1,5





All original equipment manufacturers' numbers, symbols, pictures, models and description used in this catalogue are for reference only, and it is not implied that any part listed is the product of these manufacturers. Tutti i nostri particolari non sono originali ma con essi intercambiabili. I riferimenti originali, le figure, i modelli sono esposti a semplice titolo indicativo. La nostra produzione riporta il nostro marchio.

<p><b>CEI no.</b> 220.161</p> <p><b>O.E.M. Ref</b> 58 10 112 248</p> <p><b>Ø Tubo 42 mm</b></p>	<p><b>Lenght-L</b> 805 mm</p> <p><b>Lenght-L1</b></p> <p><b>Models C - CLR</b> C 210-230-260-280-290-300-340(TI) CLR 220 / CCH 300</p> <p><i>Modelli / Models 4x4 - 6x4</i></p>	 <p>&lt;&lt;&lt; NESSUNA IMMAGINE - NO PICTURE &gt;&gt;&gt;</p> <p><b>Ball Joint</b>  <b>198.657</b> M30x1,5</p>
---	---	---

<p><b>CEI no.</b> 220.008</p> <p><b>O.E.M. Ref</b> 50 10 144 552 50 10 144 549 50 00 787 304 50 00 725 267</p> <p><b>Ø Tubo 52 mm</b></p>	<p><b>Lenght-L</b> 975 mm</p> <p><b>Lenght-L1</b> 928 mm</p> <p><b>Models G - "G" MANAGER</b> G 170-200-210-220-230(TI)-260-270-290-320-340(TI) "G" MANAGER 4x2 - 6x2 - 6x4</p> <p><i>ESCLUSI allestimenti Trilex o con assali E5A23</i> <i>EXCLUDED Trilex Version or with Front Axles E5A23</i></p>	 <p><b>Ball Joint</b>  <b>198.657</b> M30x1,5</p>
---	---	---

<p><b>CEI no.</b> 220.010</p> <p><b>O.E.M. Ref</b> 50 10 144 556 50 10 144 551 50 00 745 719 50 00 791 330</p> <p><b>Ø Tubo 52 mm</b></p>	<p><b>Lenght-L</b> 975 mm</p> <p><b>Lenght-L1</b> 938 mm</p> <p><b>Models G - "G" MANAGER</b> G 210-220-230-260-270-290 "G" MANAGER 4x2 - 6x2 - 6x4</p> <p><i>CON allestimenti Trilex o con assali E5A23</i> <i>WITH Trilex Version or with Front Axles E5A23</i></p>	 <p><b>Ball Joint</b>  <b>198.657</b> M30x1,5</p>
---	---	--

<p><b>CEI no.</b> 220.061</p> <p><b>O.E.M. Ref</b> 50 10 144 554 50 00 725 268 74 85 120 948</p> <p><b>Ø Tubo 52 mm</b></p>	<p><b>Lenght-L</b> 975 mm</p> <p><b>Lenght-L1</b></p> <p><b>Models G - "G" MANAGER</b> G 210-220-230-260-270-290 "G" MANAGER 4x2 - 6x2 - 6x4</p> <p><i>Guida Destra / Right Drive</i></p>	 <p>&lt;&lt;&lt; NESSUNA IMMAGINE - NO PICTURE &gt;&gt;&gt;</p> <p><b>Ball Joint</b>  <b>198.657</b> M30x1,5</p>
---	---	---

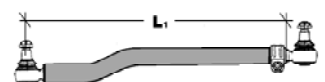
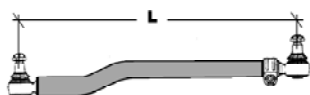

CEI no.

**198.653**

O.E.M. Ref

50 10 130 453  
50 10 138 060  
50 10 138 446  
50 10 160 453  
50 00 874 577  
Ø Tubo 52 mm

Lenght-L

1012 mm

Lenght-L1

965 mm



**Models G - GR - TR - "R" Series**

G 310-330-340-360-365-370-390-420

GR-GRH 280-305-350 / TR 280-305-350

"R" Fino al / Up to 1992

**Ball Joint**



**198.657**

M30x1,5

CEI no.

**220.025**

O.E.M. Ref

50 10 239 340  
50 10 239 386  
50 10 130 739

Lenght-L

1018 mm

Lenght-L1

955 mm



**Models "R" Series**

"R" Dal / From 1993

**Ball Joint**



**198.657**

M30x1,5

Ø Tubo 62 mm

CEI no.

**220.162**

O.E.M. Ref

50 10 239 387  
50 10 130 740

Lenght-L

1040 mm

Lenght-L1



<<< NESSUNA IMMAGINE - NO PICTURE >>>

**Models "R" Series**

"R" Dal / From 1993

**Ball Joint**



**198.657**

M30x1,5

Ø Tubo 62 mm

Per assali E6A / For Axles E6A

CEI no.

**220.060**

O.E.M. Ref

50 10 130 451

Lenght-L

1012 mm

Lenght-L1



<<< NESSUNA IMMAGINE - NO PICTURE >>>

**Models G - "R" Series**

G 310-330-340-365 / GR 280-305 / TR 280-305

"R" Fino al / Up to 1992 and "R" Dal / From 1993

"R" usa **solo** questo tipo per guida DX / "R" use **only** this type for RH Drive

Guida Destra / Right Drive

**Ball Joint**



**198.657**

M30x1,5

Ø Tubo 52 mm

CEI no.

**220.102**

O.E.M. Ref  
50 10 294 502

Ø Tubo 52 mm

Lenght-L  
860 mm  
Lenght-L1  
805 mm

Models **PREMIUM**  
PREMIUM



Ball Joint



**198.657**  
M30x1,5

CEI no.

**220.065**

O.E.M. Ref  
50 10 294 287

Ø Tubo 50 mm

Lenght-L  
809 mm  
Lenght-L1  
755 mm

Models **PREMIUM**  
PREMIUM



Ball Joint



**198.657**  
M30x1,5

Sospensione Anteriore Parabolica / Front Parabolic Suspension

CEI no.

220.265

O.E.M. Ref  
50 10 294 720

Ø Tubo 52 mm

Lenght-L  
827 mm  
Lenght-L1

Models **PREMIUM**  
PREMIUM



<<< NESSUNA IMMAGINE - NO PICTURE >>>

Ball Joint



**198.657**  
M30x1,5

Sospensione Anteriore Parabolica / Front Parabolic Suspension

CEI no.

**220.064**

O.E.M. Ref  
50 10 294 288

Ø Tubo 52 mm

Lenght-L  
825 mm  
Lenght-L1  
773 mm

Models **PREMIUM**  
PREMIUM



Ball Joint



**198.657**  
M30x1,5

Sospensione Meccanica / Mechanical Suspension

All original equipment manufacturers' numbers, symbols, pictures, models and description used in this catalogue are for reference only, and it is not implied that any part listed is the product of these manufacturers. Tutti i nostri particolari non sono originali ma con essi intercambiabili. I riferimenti originali, le figure, i modelli sono esposti a semplice titolo indicativo. La nostra produzione riporta il nostro marchio.

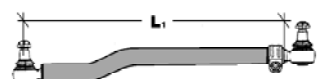
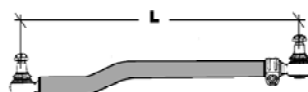

CEI no.

**220.103**

O.E.M. Ref  
50 10 630 617  
50 10 294 289

Ø Tubo 62 mm

Lenght-L

864 mm

Lenght-L1

811 mm

Models **PREMIUM**  
PREMIUM

Sospensione Pneumatica / Pneumatic Suspension



Ball Joint



**198.657**

M30x1,5

CEI no.

220.258

O.E.M. Ref  
50 01 868 382

Lenght-L

Lenght-L1

Models **PREMIUM**  
PREMIUM (PR)

Ultime Gen. 24 AF/CF/NF/RF/SF / Latest Gen. 24 AF/CF/NF/RF/SF



<<< NESSUNA IMMAGINE - NO PICTURE >>>

Ball Joint

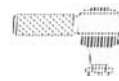

221.092

CEI no.

220.259

O.E.M. Ref  
50 01 868 383

Lenght-L

Lenght-L1

Models **PREMIUM**  
PREMIUM (PR - DXI)

Ultime Generazioni 29AB/AG / Latest Generation 29 AB/AG



<<< NESSUNA IMMAGINE - NO PICTURE >>>

Ball Joint

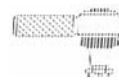

221.091

CEI no.

220.260

O.E.M. Ref  
50 01 868 384

Lenght-L

Lenght-L1

Models **PREMIUM**  
PREMIUM (PR - TR - DXI)

Ultime Generazioni 27 TC / Latest Generation 27 TC



<<< NESSUNA IMMAGINE - NO PICTURE >>>

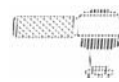

Ball Joint







221.091





All original equipment manufacturers' numbers, symbols, pictures, models and description used in this catalogue are for reference only, and it is not implied that any part listed is the product of these manufacturers. Tutti i nostri particolari non sono originali ma con essi intercambiabili. I riferimenti originali, le figure, i modelli sono esposti a semplice titolo indicativo. La nostra produzione riporta il nostro marchio.

<p><b>CEI no.</b> <b>220.261</b></p> <p><b>O.E.M. Ref</b> 50 01 868 385</p>	<p>Lenght-L</p> <p>Lenght-L1</p>	 <p>&lt;&lt;&lt; NESSUNA IMMAGINE - NO PICTURE &gt;&gt;&gt;</p>	<p><b>Ball Joint</b></p>  <p><b>221.091</b></p>
<p><b>Models PREMIUM</b> <b>PREMIUM (PR - DXI)</b></p> <p><i>Ultime Generazioni 29 RB/RG / Latest Generation 29 RB/RG</i></p>			

<p><b>CEI no.</b> <b>220.262</b></p> <p><b>O.E.M. Ref</b> 50 01 868 386</p>	<p>Lenght-L</p> <p>Lenght-L1</p>	 <p>&lt;&lt;&lt; NESSUNA IMMAGINE - NO PICTURE &gt;&gt;&gt;</p>	<p><b>Ball Joint</b></p>  <p><b>221.091</b></p>
<p><b>Models PREMIUM</b> <b>PREMIUM (PR - TR - DXI)</b></p> <p><i>Ultime Generazioni 27 TC / Latest Generation 27 TC</i></p>			

<p><b>CEI no.</b> <b>220.263</b></p> <p><b>O.E.M. Ref</b> 50 01 868 419</p>	<p>Lenght-L</p> <p>Lenght-L1</p>	 <p>&lt;&lt;&lt; NESSUNA IMMAGINE - NO PICTURE &gt;&gt;&gt;</p>	<p><b>Ball Joint</b></p>  <p><b>221.091</b></p>
<p><b>Models PREMIUM</b> <b>PREMIUM (PR - TR)</b></p> <p><i>Ultime Generazioni 27 TC / Latest Generation 27 TC</i></p>			

<p><b>CEI no.</b> <b>220.068</b></p> <p><b>O.E.M. Ref</b> 50 10 060 764 50 10 557 243</p> <p><b>Ø Tubo 36 mm</b></p>	<p>Lenght-L 720 mm</p> <p>Lenght-L1 670 mm</p>		<p><b>Ball Joint</b></p>  <p><b>198.657</b> M30x1,5</p>
<p><b>Models MAGNUM</b> <b>MAGNUM AE 380-385(TI)-390-400-420(TI)-430-440-470-480-500-520-560</b></p>			

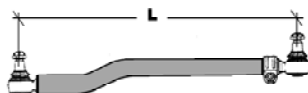

Note Tecniche  
Technical Notes  
L = mm  
L1 = mm

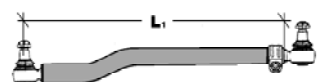

CEI no.

**220.112**

O.E.M. Ref

50 10 130 344

Lenght-L

737 mm

Lenght-L1

716 mm



**Models MAGNUM**

MAGNUM AE 380-385(TI)-390-400-420(TI)-430-440-470-480-500-520-560

Ball Joint



**198.657**

M30x1,5

Ø Tubo 52 mm

Sospensione Parabolica / Parabolic Suspension

CEI no.

**220.257**

O.E.M. Ref

50 10 557 523

Lenght-L

695 mm

Lenght-L1



<<< NESSUNA IMMAGINE - NO PICTURE >>>

**Models MAGNUM**

MAGNUM AE 400-440-480

Ball Joint



**198.525**

M30x1,5

Ø Tubo 52 mm

Sospensione Parabolica / Parabolic Suspension

CEI no.

**220.163**

O.E.M. Ref

50 10 383 203

Lenght-L

762 mm

Lenght-L1

692 mm



**Models MAGNUM**

MAGNUM AE 390-400-420(TI)-430-440-470-480-560

Ball Joint



**198.657**

M30x1,5

Ø Tubo 52 mm

Sospensione Pneumatica / Pneumatic Suspension

CEI no.

**220.253**

O.E.M. Ref

50 01 868 374

Lenght-L

605 mm

Lenght-L1



<<< NESSUNA IMMAGINE - NO PICTURE >>>

**Models MAGNUM**

MAGNUM (DXI)

Ball Joint

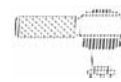

221.090

Ø Tubo 52 mm

Ultime Generazioni 17 TD / Latest Generation 17 TD

CEI no.

220.254

O.E.M. Ref  
50 01 868 375

Lenght-L

Lenght-L1



<<< NESSUNA IMMAGINE - NO PICTURE >>>

Models **MAGNUM**  
MAGNUM (DXI)

Ball Joint



221.090

Ultime Generazioni 17 RD/SD / Latest Generation 17 RD/SD

CEI no.

220.255

O.E.M. Ref  
50 01 868 376

Lenght-L

Lenght-L1

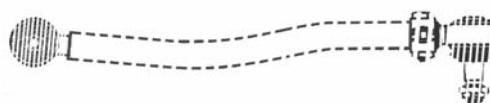

<<< NESSUNA IMMAGINE - NO PICTURE >>>

Models **MAGNUM**  
MAGNUM (DXI)

Ball Joint



221.090

Ultime Generazioni 17 RD/SD / Latest Generation 17 RD/SD

CEI no.

220.256

O.E.M. Ref  
50 01 868 377

Lenght-L

Lenght-L1



<<< NESSUNA IMMAGINE - NO PICTURE >>>

Models **MAGNUM**  
MAGNUM (DXI)

Ball Joint



221.090

Ultime Generazioni 17 TD / Latest Generation 17 TD

CEI no.

**220.098**

O.E.M. Ref  
50 10 488 052  
50 10 229 242

Lenght-L

936 mm

Lenght-L1

889 mm



Models **KERAX - MAXTER**  
MAXTER  
KERAX

Ball Joint



**198.657**

M30x1,5

Ø Tubo 52 mm

All original equipment manufacturers' numbers, symbols, pictures, models and description used in this catalogue are for reference only, and it is not implied that any part listed is the product of these manufacturers. Tutti i nostri particolari non sono originali ma con essi intercambiabili. I riferimenti originali, le figure, i modelli sono esposti a semplice titolo indicativo. La nostra produzione riporta il nostro marchio.

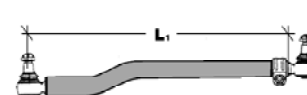
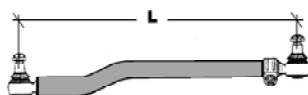

CEI no.

220.252

O.E.M. Ref  
50 10 259 241

Ø Tubo 50 mm

Lenght-L  
903 mm  
Lenght-L1



<<< NESSUNA IMMAGINE - NO PICTURE >>>

Models **KERAX - MAXTER**  
MAXTER  
KERAX

Ball Joint



**198.525**

M30x1,5

CEI no.

220.266

O.E.M. Ref  
50 10 557 524

Lenght-L  
Lenght-L1



<<< NESSUNA IMMAGINE - NO PICTURE >>>

Models **KERAX**  
KERAX

Ball Joint

CEI no.

220.267

O.E.M. Ref  
50 10 600 487

Lenght-L  
Lenght-L1



<<< NESSUNA IMMAGINE - NO PICTURE >>>

Models **KERAX**  
KERAX

Ball Joint



**198.657**

M30x1,5

CEI no.

220.268

O.E.M. Ref  
74 20 761 145

Lenght-L  
Lenght-L1



<<< NESSUNA IMMAGINE - NO PICTURE >>>

Models **KERAX**  
KERAX (DXI)

Ball Joint







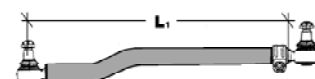
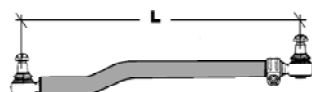

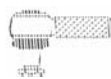

221.090

Ultime Gen. 34 FC/FF/NC/NF/SC/TC / Latest Gen. 34 FC/FF/NC/NF/SC/TC

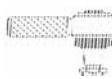

All original equipment manufacturers' numbers, symbols, pictures, models and description used in this catalogue are for reference only, and it is not implied that any part listed is the product of these manufacturers. Tutti i nostri particolari non sono originali ma con essi intercambiabili. I riferimenti originali, le figure, i modelli sono esposti a semplice titolo indicativo. La nostra produzione riporta il nostro marchio.

<p><b>CEI no.</b> <b>220.026</b></p> <p><b>O.E.M. Ref</b> 50 10 207 725 50 10 151 529 50 10 104 289 50 00 786 527 Ø Tubo 48 mm</p>	<p><b>Lenght-L</b> 2075 mm</p> <p><b>Lenght-L1</b> 2035 mm</p> <p><b>Models <b>BUS</b></b></p> <p><b>FR1 - FRH</b> <b>ILIADE</b></p>	<p></p> <p><b>Ball Joint</b>  <b>198.657</b> M30x1,5</p>
<p><b>CEI no.</b> <b>220.101</b></p> <p><b>O.E.M. Ref</b> 50 10 566 048</p> <p>Ø Tubo 30 mm</p>	<p><b>Lenght-L</b> 1418 mm</p> <p><b>Lenght-L1</b> 1350 mm</p> <p><b>Models <b>MASCOTT</b></b> <b>MASCOTTE</b></p>	<p><b>Barra di Accoppiamento - Assale Anteriore / Drag Link - Front Axle</b></p> <p></p> <p><b>Ball Joint</b>  221.069 M24x1,5</p> <p><b>Ball Joint</b>  221.070 M24x1,5</p>
<p><b>CEI no.</b> <b>220.105</b></p> <p><b>O.E.M. Ref</b> 50 10 566 062 50 10 439 023</p> <p>Ø Tubo 52 mm</p>	<p><b>Lenght-L</b> 1545 mm</p> <p><b>Lenght-L1</b> 1470 mm</p> <p><b>Models <b>M - S - MIDLUM</b></b> <b>M 150-180-210-220-230-250</b> <b>S 150-180-210-220-230-250</b> <b>MIDLUM</b></p>	<p><b>Barra di Accoppiamento - Assale Anteriore / Drag Link - Front Axle</b></p> <p></p> <p><b>Ball Joint</b>  221.054 M30x1,5</p>
<p><b>CEI no.</b> <b>220.110</b></p> <p><b>O.E.M. Ref</b> 50 10 566 058 50 10 308 215 50 10 145 581</p> <p>Ø Tubo 40 mm</p>	<p><b>Lenght-L</b> 1627 mm</p> <p><b>Lenght-L1</b> 1567 mm</p> <p><b>Models <b>MIDLUM - MAGNUM - KERAX</b></b> <b>MIDLUM 42B/44T/45D - MIDLUM DXI / MIDLUM EXPORT</b> <b>MAGNUM E-TECH 400/440/480</b> <b>KERAX FAB334</b></p>	<p><b>Barra di Accoppiamento - Assale Anteriore / Drag Link - Front Axle</b></p> <p></p> <p><b>Ball Joint</b>  <b>198.666</b> M30x1,5</p> <p><b>Ball Joint</b>  <b>198.657</b> M30x1,5</p>

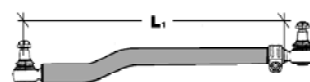
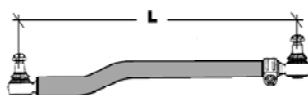



CEI no.  
**220.186**

O.E.M. Ref  
50 10 439 022

Ø Tubo 30 mm

Lenght-L  
1720 mm  
Lenght-L1  
1566 mm

Barra di Accoppiamento - Assale Anteriore / Drag Link - Front Axle



Models **PREMIUM**  
PREMIUM

MAGNUM 390 / 420TI / 430 / 470 / 560 Dal / From 1996 al / Up to 2000

Ultimi Tipi / Latest Generation

Ball Joint



221.054

M30x1,5

CEI no.  
**220.187**

O.E.M. Ref  
50 10 439 021  
50 10 566 063

Ø Tubo 52 mm

Lenght-L  
1758 mm  
Lenght-L1  
1700 mm

Barra di Accoppiamento - Assale Anteriore / Drag Link - Front Axle



Models **PREMIUM**  
PREMIUM

Sospensione Pneumatica / Pneumatic Suspension

Ultimi Tipi / Latest Generation

Ball Joint



221.054

M30x1,5

CEI no.  
**220.288**

O.E.M. Ref  
50 10 308 082  
50 10 566 059

Ø Tubo 48 mm

Lenght-L  
1693 mm  
Lenght-L1  
1655 mm

Barra di Accoppiamento - Assale Anteriore / Drag Link - Front Axle



Models **PREMIUM**  
PREMIUM

Sospensione Meccanica / Pneumatic Suspension

Ball Joint



198.666

M30x1,5

Ball Joint



198.657

M30x1,5

CEI no.  
**220.277**

O.E.M. Ref  
50 10 566 064

Lenght-L  
1720 mm  
Lenght-L1

Barra di Accoppiamento - Assale Anteriore / Drag Link - Front Axle



<<< NESSUNA IMMAGINE - NO PICTURE >>>

Models **PREMIUM**  
PREMIUM

Sospensione Pneumatica / Pneumatic Suspension

E81 VAR 103AE

Ball Joint

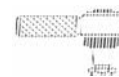

221.078

CEI no.

220.278

O.E.M. Ref  
50 01 868 363

Lenght-L

Barra di Accoppiamento - Assale Anteriore / Drag Link - Front Axle

Lenght-L1



<<< NESSUNA IMMAGINE - NO PICTURE >>>

Models **PREMIUM / MAGNUM**  
PREMIUM (PR - TR - DXI)  
MAGNUM (DXI)

Ball Joint



221.079

Ultime Generazioni / Latest Generation

CEI no.

220.279

O.E.M. Ref  
50 01 868 366

Lenght-L

Barra di Accoppiamento - Assale Anteriore / Drag Link - Front Axle

Lenght-L1



<<< NESSUNA IMMAGINE - NO PICTURE >>>

Models **PREMIUM**  
PREMIUM (PR - TR - DXI)

Ball Joint



221.079

Ultime Generazioni / Latest Generation

CEI no.

220.289

O.E.M. Ref  
50 10 630 821  
50 10 630 820

Lenght-L

Barra di Accoppiamento - Assale Anteriore / Drag Link - Front Axle

Lenght-L1

830 mm



<<< NESSUNA IMMAGINE - NO PICTURE >>>

Models **MAGNUM**  
MAGNUM (TGX)

Ball Joint

Ø Tubo 62 mm

All original equipment manufacturers' numbers, symbols, pictures, models and description used in this catalogue are for reference only, and it is not implied that any part listed is the product of these manufacturers. Tutti i nostri particolari non sono originali ma con essi intercambiabili. I riferimenti originali, le figure, i modelli sono esposti a semplice titolo indicativo. La nostra produzione riporta il nostro marchio.

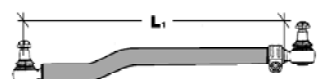
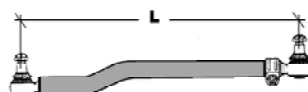

CEI no.  
**198.597**

O.E.M. Ref  
291396  
291395

Ø Tubo 40 mm

Lenght-L  
728 mm  
Lenght-L1  
675 mm



**Models 1 Series**  
LB / LBS / LBT 111  
LB / LBS / LBT 141

*Guida Sinistra / Left Drive*

**Ball Joint**



**198.525**  
M30x1,5

CEI no.  
**198.596**

O.E.M. Ref  
278665  
278666

Ø Tubo 48 mm

Lenght-L  
947 mm  
Lenght-L1  
890 mm



**Models 2-3 Series**  
G / P 82  
G / P / R 92 - G / P / R 112 - G / P / R 142  
G / P / R 93 - G / P / R 113 - G / P / R 143

*1a generazione - Guida Sinistra / 1st Generation - Left Drive*

**Ball Joint**



**198.525**  
M30x1,5

CEI no.  
**220.012**

O.E.M. Ref  
306981

Ø Tubo 48 mm

Lenght-L  
947 mm  
Lenght-L1  
882 mm



**Models 2-3 Series**  
G / P 82 - G / P / R 92 - G / P / R 112 - G / P / R 142  
G / P / R 93 - G / P / R 113 - G / P / R 143

*1a generazione. Versioni con balestre e anti-rollbar - Guida Sinistra  
1st Generation. Version with Leaves Spring and anti-rollbar - Guida Sinistra*

**Ball Joint**



**198.525**  
M30x1,5

CEI no.  
198.658

O.E.M. Ref  
352635  
278664  
278663

Ø Tubo 48 mm

Lenght-L  
947 mm  
Lenght-L1  
893 mm



**Models 2-3 Series**  
G / P 82  
G / P / R 92 - G / P / R 112 - G / P / R 142  
G / P / R 93 - G / P / R 113 - G / P / R 143

*1a generazione - Guida Destra / 1st Generation - Right Drive*



**Ball Joint**



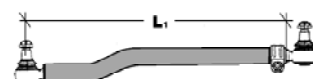
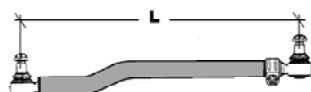



**198.525**  
M30x1,5





All original equipment manufacturers' numbers, symbols, pictures, models and description used in this catalogue are for reference only, and it is not implied that any part listed is the product of these manufacturers. Tutti i nostri particolari non sono originali ma con essi intercambiabili. I riferimenti originali, le figure, i modelli sono esposti a semplice titolo indicativo. La nostra produzione riporta il nostro marchio.

<p><b>CEI no.</b> <b>198.680</b></p> <p>O.E.M. Ref 390784</p> <p><b>Ø Tubo 42 mm</b></p>	<p>Lenght-L 855 mm</p> <p>Lenght-L1 810 mm</p> <p><b>Models 2-3 Series</b> G/P/R 92 - G/P/R 112 - G/P/R 142 G/P/R 93 - G/P/R 113 - G/P/R 143</p> <p><i>2a Generazione - Guida Sinistra / 2nd Generation - Left Drive</i></p>		<p><b>Ball Joint</b></p>  <p><b>198.525</b> M30x1,5</p>
--	--	--	--

<p><b>CEI no.</b> <b>220.021</b></p> <p>O.E.M. Ref 1369919 1304569 370875</p> <p><b>Ø Tubo 50 mm</b></p>	<p>Lenght-L 926 mm</p> <p>Lenght-L1 865 mm</p> <p><b>Models 3 Series</b> G/P/R 93 - G/P/R 113 - G/P/R 143</p> <p><i>Solo per Assali ant.Tipo / Only for Front Axles Type : AM56 - AM61</i></p>		<p><b>Ball Joint</b></p>  <p><b>198.525</b> M30x1,5</p>
--	--	--	---

<p><b>CEI no.</b> <b>220.264</b></p> <p>O.E.M. Ref 1112023</p> <p><b>Ø Tubo 50 mm</b></p>	<p>Lenght-L 900 mm</p> <p>Lenght-L1</p> <p><b>Models 3 Series</b> G/P/R 93 - G/P/R 113 - G/P/R 143</p> <p><i>Solo per Assali ant.Tipo / Only for Front Axles Type : AMA56</i></p>	 <p>&lt;&lt;&lt; NESSUNA IMMAGINE - NO PICTURE &gt;&gt;&gt;</p>	<p><b>Ball Joint</b></p>  <p><b>198.525</b> M30x1,5</p>
---	---	---	--

<p><b>CEI no.</b> <b>220.095</b></p> <p>O.E.M. Ref 1369917 382774 306913 300308</p> <p><b>Ø Tubo 50 mm</b></p>	<p>Lenght-L 926 mm</p> <p>Lenght-L1 890 mm</p> <p><b>Models 3 Series</b> T 93 - T 113 - T 143</p> <p><i>Solo per Assali ant.Tipo / Only for Front Axles Type : AM56 - AM61</i></p>	 <p>&lt;&lt;&lt; NESSUNA IMMAGINE - NO PICTURE &gt;&gt;&gt;</p>	<p><b>Ball Joint</b></p>  <p><b>198.525</b> M30x1,5</p>
--	--	---	--

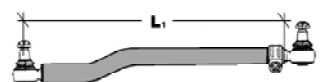
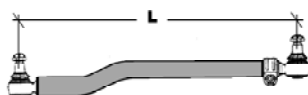

All original equipment manufacturers numbers, symbols, pictures, models and description used in this catalogue are for reference only, and it is not implied that any part listed is the product of these manufacturers. Tutti i nostri particolari non sono originali ma con essi intercambiabili. I riferimenti originali, le figure, i modelli sono esposti a semplice titolo indicativo. La nostra produzione riporta il nostro marchio.

**CEI no.**  
220.270  
**O.E.M. Ref**  
345124  
  
**Ø Tubo 50 mm**

**Lenght-L**  
927 mm  
**Lenght-L1**



<<< NESSUNA IMMAGINE - NO PICTURE >>>

**Models 3 Series**  
G/P/R 93 - G/P/R 113 - G/P/R 143

1a Generazione - **Guida Sinistra** / 1st Generation - **Left Drive**  
Solo per Assali ant.Tipo / Only for Front Axles Type : **AM70**

**Ball Joint**  
  
**198.525**  
M30x1,5

**CEI no.**  
220.133  
**O.E.M. Ref**  
1300284  
  
**Ø Tubo 52 mm**

**Lenght-L**  
765 mm  
**Lenght-L1**  
710 mm



**Models 3 Series**  
G/P/R 93 - G/P/R 113 - G/P/R 143

2a Generazione - **Guida Sinistra** / 2nd Generation - **Left Drive**  
Solo per Assali ant.Tipo / Only for Front Axles Type : **AM70**

**Ball Joint**  
  
**198.525**  
M30x1,5

**CEI no.**  
220.271  
**O.E.M. Ref**  
389151  
  
**Ø Tubo 52 mm**

**Lenght-L**  
843 mm  
**Lenght-L1**  
780 mm



<<< NESSUNA IMMAGINE - NO PICTURE >>>

**Models 3 Series**  
R 93 - R 113 - R 143

2a Generazione - **Guida Sinistra** / 2nd Generation - **Left Drive**  
Solo per Assali ant.Tipo / Only for Front Axles Type : **AM70**

**Ball Joint**  
  
**198.525**  
M30x1,5

**CEI no.**  
220.272  
**O.E.M. Ref**  
382780  
328702  
  
**Ø Tubo 40 mm**

**Lenght-L**  
554 mm  
**Lenght-L1**



<<< NESSUNA IMMAGINE - NO PICTURE >>>

**Models 3 Series**  
T 93 - T 113 - T 143

2a Generazione - **Guida Sinistra** / 2nd Generation - **Left Drive**  
Solo per Assali ant.Tipo / Only for Front Axles Type : **AM70**

**Ball Joint**  
  
**198.525**  
M30x1,5

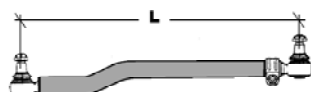

**Note Tecniche**  
**Technical Notes**  
L = mm  
L1 = mm

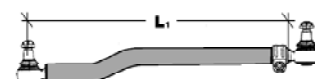



All original equipment manufacturers' numbers, symbols, pictures, models and description used in this catalogue are for reference only, and it is not implied that any part listed is the product of these manufacturers. Tutti i nostri particolari non sono originali ma con essi intercambiabili. I riferimenti originali, le figure, i modelli sono esposti a semplice titolo indicativo. La nostra produzione riporta il nostro marchio.

CEI no.  
**220.134**  
O.E.M. Ref  
1112511

Lenght-L  
843 mm  
Lenght-L1  
785 mm



**Models 3 Series**  
G/P/R 93 - G/P/R 113 - G/P/R 143

2a Generazione. Versioni con sospensione pneumatica - **Guida Sinistra**  
2nd Generation. Version with Air spring suspension - **Left Drive**

**Ball Joint**  
  
**198.525**  
M30x1,5

Ø Tubo 50 mm

CEI no.  
**198.690**  
O.E.M. Ref  
1304571  
381339

Lenght-L  
926 mm  
Lenght-L1  
870 mm



**Models 2-3 Series**  
G/P/R 92 - G/P/R 112 - G/P/R 142  
G/P/R 93 - G/P/R 113 - G/P/R 143

2a Generazione - **Guida Destra** / 2nd Generation - **Right Drive**

**Ball Joint**  
  
**198.525**  
M30x1,5

Ø Tubo 50 mm

CEI no.  
**220.165**  
O.E.M. Ref  
1324483  
1305012

Lenght-L  
800 mm  
Lenght-L1  
750 mm



**Models 3 Series**  
G/P/R 93 - G/P/R 113 - G/P/R 143

3a Generazione - **Guida Sinistra** / 3rd Generation - **Left Drive**

**Ball Joint**  
  
**198.525**  
M30x1,5

Ø Tubo 52 mm

CEI no.  
**220.079**  
O.E.M. Ref  
1768898  
1384025  
1379071  
1356055

Lenght-L  
1059 mm  
Lenght-L1  
1006 mm



**Models 4 Series | P-R Series**  
C/G/L/P/R 94 - C/G/L/P/R 114  
C/G/L/P/R 124 - C/G/L/P/R 144  
P/R 340 - 380 - 420 - 480 - 500 - 560 - 620

**Guida Sinistra** / **Left Drive**

**Ball Joint**  
  
**198.525**  
M30x1,5

Ø Tubo 52 mm

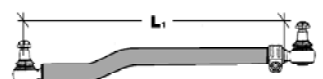
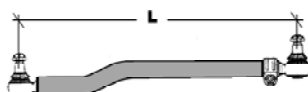

CEI no.  
**220.066**

O.E.M. Ref  
1769597  
1384027  
1379072  
1847312

Ø Tubo 52 mm

Lenght-L  
1059 mm  
Lenght-L1  
1006 mm



**Models 4 Series | P-R Series**

C/G/L/P/R 94 - C/G/L/P/R 114  
C/G/L/P/R 124 - C/G/L/P/R 144  
P/R 340 - 380 - 420 - 480 - 500 - 560 - 620  
Guida Destra / Right Drive

**Ball Joint**



**198.525**  
M30x1,5

CEI no.  
**220.067**

O.E.M. Ref  
1409918  
1385251  
1379178  
1369411

Ø Tubo 50 mm

Lenght-L  
1743 mm  
Lenght-L1  
1680 mm

**Barra di Accoppiamento - Assale Anteriore / Drag Link - Front Axle**



**Models 4 Series | P-R Series**

C/G/L/P/R 94 - C/G/L/P/R 114  
C/G/L/P/R 124 - C/G/L/P/R 144  
P/R 340 - 380 - 420 - 480 - 500 - 560 - 620

**Ball Joint**



**198.525**  
M30x1,5

CEI no.  
**220.176**

O.E.M. Ref  
1734019  
1395614  
1361413  
1897333

Ø Tubo 62 mm

Lenght-L  
1750 mm  
Lenght-L1  
1690 mm

**Barra di Accoppiamento - Assale Anteriore / Drag Link - Front Axle**



**Models 4 Series | P-R Series**

C/G/L/P/R 94 - C/G/L/P/R 114  
C/G/L/P/R 124 - C/G/L/P/R 144  
P/R 340 - 380 - 420 - 480 - 500 - 560 - 620  
Sosp. Pneumatica - Guida Sinistra / Air spring suspension - Left Drive

**Ball Joint**



**221.075**  
M30x1,5

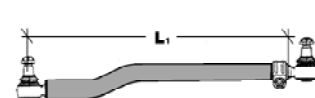
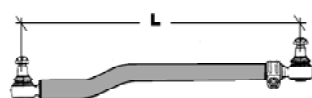

All original equipment manufacturers' numbers, symbols, pictures, models and description used in this catalogue are for reference only, and it is not implied that any part listed is the product of these manufacturers. Tutti i nostri particolari non sono originali ma con essi intercambiabili. I riferimenti originali, le figure, i modelli sono esposti a semplice titolo indicativo. La nostra produzione riporta il nostro marchio.

CEI no.  
**220.204**

O.E.M. Ref  
3124480  
6777855  
6791948  
20400909

Ø Tubo 30 mm

Lenght-L  
970 mm  
Lenght-L1  
930 mm

**Models**  
FL6.08 - FL6.12

*Guida Sinistra / Left Drive*



**Ball Joint**



**198.475**  
M24x1,5

CEI no.  
**220.058**

O.E.M. Ref  
6790572  
20400941

Ø Tubo 42 mm

Lenght-L  
850 mm  
Lenght-L1  
810 mm

**Models**  
FL6.12 - FL6.14

*Guida Sinistra / Left Drive*



**Ball Joint**



**221.073**  
M30x1,5

CEI no.  
**220.202**

O.E.M. Ref  
1071344  
3127737  
20400944

Ø Tubo 48 mm

Lenght-L  
871 mm  
Lenght-L1  
830 mm

**Models**  
FL6.15

*Guida Sinistra / Left Drive*



**Ball Joint**



**221.073**  
M30x1,5

CEI no.  
**220.203**

O.E.M. Ref  
6799189

Ø Tubo 40 mm

Lenght-L  
893 mm  
Lenght-L1  
840 mm

**Models**  
FL6.16 - FL6.26

*Guida Sinistra / Left Drive*



**Ball Joint**



**221.089**  
M30x1,5

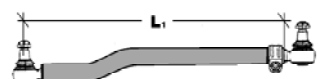
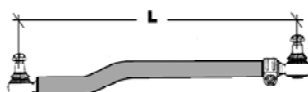

CEI no.  
**220.062**

O.E.M. Ref  
1592939

Ø Tubo 50 mm

Lenght-L  
823 mm  
Lenght-L1  
755 mm

**Models**  
F7  
FL7

*Guida Sinistra / Left Drive*



**Ball Joint**



**198.626**  
M30x1,5

CEI no.  
**220.003**

O.E.M. Ref  
1592940

Ø Tubo 50 mm

Lenght-L  
823 mm  
Lenght-L1  
755 mm

**Models**  
F7  
FL7

*Guida Destra / Right Drive*



**Ball Joint**



**198.626**  
M30x1,5

CEI no.  
**220.166**

O.E.M. Ref  
1080786

Ø Tubo 42 mm

Lenght-L  
856 mm  
Lenght-L1  
810 mm

**Models**  
F7  
FL7

*Sospensione Pneumatica - Guida Sx e Dx / Air Suspension - Lf & Rh Drive*



**Ball Joint**



**198.626**  
M30x1,5

CEI no.  
**220.076**

O.E.M. Ref  
20393061  
3988697  
3988695  
1075153

Ø Tubo 52 mm

Lenght-L  
881 mm  
Lenght-L1  
830 mm

**Models**  
FM7  
FM9

*Sospensione Pneumatica - Guida Sinistra / Air Suspension - Left Drive*



**Ball Joint**



**221.027**  
M30x1,5

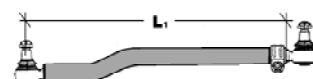
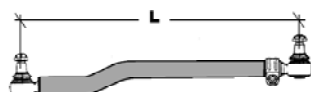



All original equipment manufacturers' numbers, symbols, pictures, models and description used in this catalogue are for reference only, and it is not implied that any part listed is the product of these manufacturers. Tutti i nostri particolari non sono originali ma con essi intercambiabili. I riferimenti originali, le figure, i modelli sono esposti a semplice titolo indicativo. La nostra produzione riporta il nostro marchio.

<p><b>CEI no.</b> <b>220.168</b></p> <p>O.E.M. Ref 20390745 21106936</p> <p><b>Ø Tubo 50 mm</b></p>	<p>Lenght-L 885 mm Lenght-L1 830 mm</p> <p><b>Models</b> FM7 FM9</p> <p><i>Sospensione Pneumatica - Guida Sinistra / Air Suspension - Left Drive</i> <i>Assale anteriore con cuscinetti "UNIT"/ Front axle with "UNIT" bearing</i></p>		<p><b>Ball Joint</b></p>  <p><b>221.071</b> M30x1,5</p>
---	--	--	--

<p><b>CEI no.</b> <b>220.034</b></p> <p>O.E.M. Ref 20393069 3988704 1075663</p> <p><b>Ø Tubo 52 mm</b></p>	<p>Lenght-L 861 mm Lenght-L1 820 mm</p> <p><b>Models</b> FM7 FM9</p> <p><i>Sospensione Meccanica - Guida Sinistra / Mechanic Susp. - Left Drive</i></p>		<p><b>Ball Joint</b></p>  <p><b>221.027</b> M30x1,5</p>
--	---	--	---

<p><b>CEI no.</b> <b>220.169</b></p> <p>O.E.M. Ref 20393186 20375555 3986452 21106930</p> <p><b>Ø Tubo 52 mm</b></p>	<p>Lenght-L 863 mm Lenght-L1 803 mm</p> <p><b>Models</b> FM7 FM9</p> <p><i>Sospensione Meccanica - Guida Sinistra / Mechanic Susp. - Left Drive</i> <i>Assale anteriore con cuscinetti "UNIT"/ Front axle with "UNIT" bearing</i></p>		<p><b>Ball Joint</b></p>  <p><b>221.071</b> M30x1,5</p>
--	---	--	--

<p><b>CEI no.</b> <b>220.170</b></p> <p>O.E.M. Ref 20393059 3988698 3988700 8156657</p> <p><b>Ø Tubo 52 mm</b></p>	<p>Lenght-L 881 mm Lenght-L1</p> <p><b>Models</b> FM7 FM9</p> <p><i>Sospensione Pneumatica - Guida Destra / Air Suspension - Right Drive</i></p>	 <p>&lt;&lt;&lt; NESSUNA IMMAGINE - NO PICTURE &gt;&gt;&gt;</p>	<p><b>Ball Joint</b></p>  <p><b>221.027</b> M30x1,5</p>
--	--	---	--

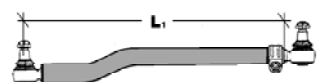
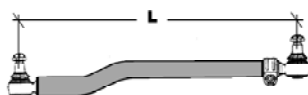



CEI no.  
**220.056**

O.E.M. Ref  
20393063  
1075664  
3988701

Ø Tubo 52 mm

Lenght-L  
861 mm  
Lenght-L1  
820 mm

**Models**  
FM7  
FM9

Sospensione Meccanica - **Guida Destra** / Mechanic Susp. - **Right Drive**



**Ball Joint**



**221.027**

M30x1,5

**Barra di Accoppiamento - Assale Anteriore | Drag Link - Front Axle**

CEI no.  
**220.167**

O.E.M. Ref  
1624464

Ø Tubo 60 mm

Lenght-L  
1779 mm  
Lenght-L1  
1750 mm

**Models**  
FL7

**Guida Sinistra** / Left Drive



<<< NESSUNA IMMAGINE - NO PICTURE >>>

**Ball Joint**



**198.626**

M30x1,5

CEI no.  
**198.691**

O.E.M. Ref  
1606283  
1576092

Ø Tubo 42 mm

Lenght-L  
870 mm  
Lenght-L1  
815 mm

**Models**  
F10  
F12

■ 1a generazione - **Guida Sinistra** / 1st Generation - **Left Drive**



**Ball Joint**



**198.626**

M30x1,5

CEI no.  
**198.623**

O.E.M. Ref  
1626751  
1610338

Ø Tubo 42 mm

Lenght-L  
850 mm  
Lenght-L1  
800 mm

**Models**  
F10  
F12  
F16

■ 2a generazione - **Guida Sinistra** / 2nd Generation - **Left Drive**



**Ball Joint**



**198.626**

M30x1,5

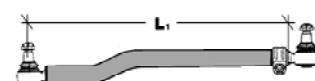
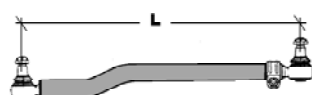

All original equipment manufacturers' numbers, symbols, pictures, models and description used in this catalogue are for reference only, and it is not implied that any part listed is the product of these manufacturers. Tutti i nostri particolari non sono originali ma con essi intercambiabili. I riferimenti originali, le figure, i modelli sono esposti a semplice titolo indicativo. La nostra produzione riporta il nostro marchio.

CEI no.  
**220.175**  
O.E.M. Ref  
1083744

Ø Tubo 42 mm

Lenght-L  
860 mm  
Lenght-L1  
793 mm

**Models**  
F10  
F12  
F16

■ 3a generazione - **Guida Sinistra** / 3rd Generation - **Left Drive**



**Ball Joint**  
  
**198.626**  
M30x1,5

CEI no.  
**220.273**  
O.E.M. Ref  
8154809

Lenght-L  
  
Lenght-L1

**Models**  
F10  
F12  
F16

■ 4a generazione - **Guida Sinistra** / 4th Generation - **Left Drive**



<<< NESSUNA IMMAGINE - NO PICTURE >>>

**Ball Joint**  
  
**198.626**  
M30x1,5

CEI no.  
**220.055**  
O.E.M. Ref  
1606284  
1576093

Ø Tubo 42 mm

Lenght-L  
870 mm  
Lenght-L1  
815 mm

**Models**  
F10  
F12

□ 1a generazione - **Guida Destra** / 1st Generation - **Right Drive**



**Ball Joint**  
  
**198.626**  
M30x1,5

CEI no.  
**198.733**  
O.E.M. Ref  
1626750  
1610074

Ø Tubo 42 mm

Lenght-L  
850 mm  
Lenght-L1  
800 mm

**Models**  
F10  
F12  
F16

□ 2a generazione - **Guida Destra** / 2nd Generation - **Right Drive**



**Ball Joint**  
  
**198.626**  
M30x1,5

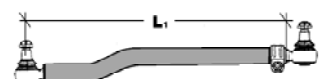
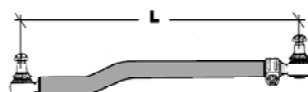

**CEI no.**  
**220.274**  
**O.E.M. Ref**  
**1083745**

Ø Tubo 42 mm

**Lenght-L**  
**845 mm**  
**Lenght-L1**



<<< NESSUNA IMMAGINE - NO PICTURE >>>

**Models**  
**F10**  
**F12**  
**F16**

☐ **3a generazione - Guida Destra / 3rd Generation - Right Drive**

**Ball Joint**



**198.626**  
M30x1,5

**CEI no.**  
**220.018**  
**O.E.M. Ref**  
**1626749**  
**1613562**

Ø Tubo 42 mm

**Lenght-L**  
**880 mm**  
**Lenght-L1**  
**830 mm**



**Models**  
**F10**  
**F12**  
**F16**

*Sosp.Pneumatica ant. - Guida Sinistra / Front Air Suspension - Left Drive*

**Ball Joint**



**198.626**  
M30x1,5

**CEI no.**  
**220.171**  
**O.E.M. Ref**  
**1088299**

Ø Tubo 42 mm

**Lenght-L**  
**880 mm**  
**Lenght-L1**  
**830 mm**



<<< NESSUNA IMMAGINE - NO PICTURE >>>

**Models**  
**F10**  
**F12**  
**F16**

*Sosp.Pneumatica ant. - Guida Destra / Front Air Suspension - Right Drive*

**Ball Joint**



**198.626**  
M30x1,5

**CEI no.**  
**220.062**  
**O.E.M. Ref**  
**1592939**

Ø Tubo 50 mm

**Lenght-L**  
**823 mm**  
**Lenght-L1**  
**755 mm**



**Models**  
**FL10**  
**FL12**

*Guida Sinistra / Left Drive*



**Ball Joint**





**198.626**  
M30x1,5

All original equipment manufacturers' numbers, symbols, pictures, models and description used in this catalogue are for reference only, and it is not implied that any part listed is the product of these manufacturers. Tutti i nostri particolari non sono originali ma con essi intercambiabili. I riferimenti originali, le figure, i modelli sono esposti a semplice titolo indicativo. La nostra produzione riporta il nostro marchio.

<p><b>CEI no.</b> <b>220.003</b></p> <p>O.E.M. Ref 1592940</p> <p><b>Ø Tubo 50 mm</b></p>	<p>Lenght-L 823 mm Lenght-L1 755 mm</p> <p><b>Models</b> FL10 FL12</p> <p><i>Guida Destra / Right Drive</i></p>	 <p><b>Ball Joint</b></p>  <p><b>198.626</b> M30x1,5</p>
---	---	---

<p><b>CEI no.</b> <b>220.166</b></p> <p>O.E.M. Ref 1080786</p> <p><b>Ø Tubo 42 mm</b></p>	<p>Lenght-L 856 mm Lenght-L1 810 mm</p> <p><b>Models</b> FL10 FL12</p> <p><i>Sospensione Pneumatica - Guida Sx e Dx / Air Suspension - Lf &amp; Rh Drive</i></p>	 <p><b>Ball Joint</b></p>  <p><b>198.626</b> M30x1,5</p>
---	--	--

<p><b>CEI no.</b> <b>220.048</b></p> <p>O.E.M. Ref 1628636</p> <p><b>Ø Tubo 52 mm</b></p>	<p>Lenght-L 881 mm Lenght-L1 790 mm</p> <p><b>Models</b> FH12 FH16</p> <p><i>1a Generazione / 1st Generation</i></p> <p>● <i>Sospensione Pneumatica - Guida Sinistra / Air Suspension - Left Drive</i></p>	 <p><b>Ball Joint</b></p>  <p><b>221.027</b> M30x1,5</p>
---	--	---

<p><b>CEI no.</b> <b>220.076</b></p> <p>O.E.M. Ref 20393061 3988697 3988695 1075153</p> <p><b>Ø Tubo 52 mm</b></p>	<p>Lenght-L 881 mm Lenght-L1 830 mm</p> <p><b>Models</b> FH12 - FH16 FM10 - FM12</p> <p><i>2a Generazione / 2nd Generation</i></p> <p>● <i>Sospensione Pneumatica - Guida Sinistra / Air Suspension - Left Drive</i></p>	 <p><b>Ball Joint</b></p>  <p><b>221.027</b> M30x1,5</p>
--	--	---

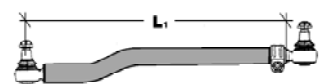
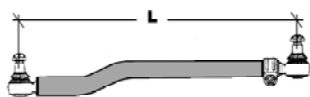

CEI no.  
**220.168**

O.E.M. Ref  
20390745  
21106836

Ø Tubo 50 mm

Lenght-L  
885 mm  
Lenght-L1  
830 mm



**Models**  
FH12 - FH16 - FM10 - FM12

2a Generazione / 2nd Generation

Sospensione Pneumatica - **Guida Sinistra** / Air Suspension - **Left Drive**

- Assale anteriore con cuscinetti "UNIT"/ Front axle with "UNIT" bearing

**Ball Joint**



**221.071**  
M30x1,5

CEI no.  
**220.275**

O.E.M. Ref  
20390746  
21106968

Lenght-L  
  
Lenght-L1



<<< NESSUNA IMMAGINE - NO PICTURE >>>

**Models**  
FH12 - FH16 - FM10 - FM12

2a Generazione / 2nd Generation

Sospensione Pneumatica - **Guida Destra** / Air Suspension - **Right Drive**

- Assale anteriore con cuscinetti "UNIT"/ Front axle with "UNIT" bearing

**Ball Joint**



**221.071**  
M30x1,5

CEI no.  
**220.029**

O.E.M. Ref  
1075005

Ø Tubo 52 mm

Lenght-L  
863 mm  
Lenght-L1  
800 mm



**Models**  
FH12  
FH16

1a Generazione / 1st Generation

- Sospensione Meccanica - **Guida Sinistra** / Mechanic Susp. - **Left Drive**

**Ball Joint**



**221.027**  
M30x1,5

CEI no.  
**220.034**

O.E.M. Ref  
20393069  
3988704  
1075663

Ø Tubo 52 mm

Lenght-L  
861 mm  
Lenght-L1  
820 mm



**Models**  
FH12 - FH16  
FM10 - FM12

2a Generazione / 2nd Generation

- Sospensione Meccanica - **Guida Sinistra** / Mechanic Susp. - **Left Drive**

**Ball Joint**



**221.027**  
M30x1,5

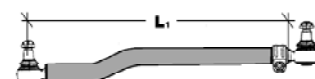
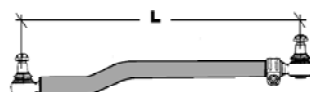







All original equipment manufacturers' numbers, symbols, pictures, models and description used in this catalogue are for reference only, and it is not implied that any part listed is the product of these manufacturers. Tutti i nostri particolari non sono originali ma con essi intercambiabili. I riferimenti originali, le figure, i modelli sono esposti a semplice titolo indicativo. La nostra produzione riporta il nostro marchio.

<p><b>CEI no.</b> <b>220.169</b></p> <p>O.E.M. Ref 20393186 20375555 3986452 21106930</p> <p><b>Ø Tubo 52 mm</b></p>	<p>Lenght-L 863 mm</p> <p>Lenght-L1 803 mm</p> <p><b>Models</b> FH12 - FH16 - FM10 - FM12</p> <p>2a Generazione / 2nd Generation</p> <p>Sospensione Meccanica - <b>Guida Sinistra</b> / Mechanic Susp. - <b>Left Drive</b></p> <p>○ Assale anteriore con cuscinetti "UNIT"/ Front axle with "UNIT" bearing</p>		<p><b>Ball Joint</b></p>  <p><b>221.071</b> M30x1,5</p>
--	--	--	--

<p><b>CEI no.</b> <b>220.276</b></p> <p>O.E.M. Ref 20393187 21406952</p> <p><b>Ø Tubo 52 mm</b></p>	<p>Lenght-L 863 mm</p> <p>Lenght-L1</p> <p><b>Models</b> FH12 - FH16 - FM10 - FM12</p> <p>2a Generazione / 2nd Generation</p> <p>Sospensione Meccanica - <b>Guida Destra</b> / Mechanic Susp. - <b>Right Drive</b></p> <p>○ Assale anteriore con cuscinetti "UNIT"/ Front axle with "UNIT" bearing</p>	 <p>&lt;&lt;&lt; NESSUNA IMMAGINE - NO PICTURE &gt;&gt;&gt;</p>	<p><b>Ball Joint</b></p>  <p><b>221.071</b> M30x1,5</p>
---	--	---	---

<p><b>CEI no.</b> <b>220.173</b></p> <p>O.E.M. Ref 8153931</p> <p><b>Ø Tubo 52 mm</b></p>	<p>Lenght-L 881 mm</p> <p>Lenght-L1</p> <p><b>Models</b> FH12 FH16</p> <p>1a Generazione / 1st Generation</p> <p>Ω Sospensione Pneumatica - <b>Guida Destra</b> / Air Suspension - <b>Right Drive</b></p>	 <p>&lt;&lt;&lt; NESSUNA IMMAGINE - NO PICTURE &gt;&gt;&gt;</p>	<p><b>Ball Joint</b></p>  <p><b>221.027</b> M30x1,5</p>
---	---	---	--

<p><b>CEI no.</b> <b>220.170</b></p> <p>O.E.M. Ref 20393059 3988698 3988700 8156657</p> <p><b>Ø Tubo 52 mm</b></p>	<p>Lenght-L</p> <p>Lenght-L1</p> <p><b>Models</b> FH12 - FH16 FM10 - FM12</p> <p>2a Generazione / 2nd Generation</p> <p>Ω Sospensione Pneumatica - <b>Guida Destra</b> / Air Suspension - <b>Right Drive</b></p>	 <p>&lt;&lt;&lt; NESSUNA IMMAGINE - NO PICTURE &gt;&gt;&gt;</p>	<p><b>Ball Joint</b></p>  <p><b>221.027</b> M30x1,5</p>
--	--	---	--

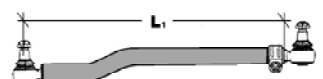
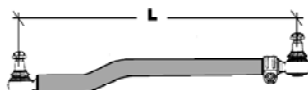

CEI no.  
**220.057**

O.E.M. Ref  
1075006  
85114190

Ø Tubo 52 mm

Lenght-L  
863 mm  
Lenght-L1  
800 mm

**Models**  
FH12  
FH16

1a Generazione / 1st Generation

❖ Sospensione Meccanica - **Guida Destra** / Mechanic Susp. - **Right Drive**



**Ball Joint**



**221.027**  
M30x1,5

CEI no.  
**220.056**

O.E.M. Ref  
20393063  
1075664  
3988701

Ø Tubo 52 mm

Lenght-L  
861 mm  
Lenght-L1  
820 mm

**Models**  
FH12 - FH16  
FM10 - FM12

2a Generazione / 2nd Generation

❖ Sospensione Meccanica - **Guida Destra** / Mechanic Susp. - **Right Drive**



**Ball Joint**



**221.027**  
M30x1,5

CEI no.  
**198.622**

O.E.M. Ref  
1626493  
1606277  
1588263

Ø Tubo 40 mm

Lenght-L  
710 mm  
Lenght-L1  
680 mm

**Models**  
N10 - NL10  
N12 - NL12

Con sterzo ZF 22.7 - 25.5 / With ZF Steering 22.7 - 25.5

**Guida Sinistra** / Left Drive



**Ball Joint**



**198.626**  
M30x1,5

CEI no.  
220.174

O.E.M. Ref  
1588017

Ø Tubo 42 mm

Lenght-L  
738 mm  
Lenght-L1

**Models**  
N10 - NL10  
N12 - NL12

Per sterzo ZF 23.6 / For ZF Steering 23.6

**Guida Sinistra** / Left Drive



<<< NESSUNA IMMAGINE - NO PICTURE >>>



**Ball Joint**



**198.626**  
M30x1,5









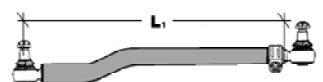
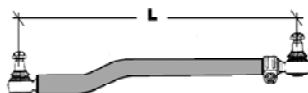



All original equipment manufacturers' numbers, symbols, pictures, models and description used in this catalogue are for reference only, and it is not implied that any part listed is the product of these manufacturers. Tutti i nostri particolari non sono originali ma con essi intercambiabili. I riferimenti originali, le figure, i modelli sono esposti a semplice titolo indicativo. La nostra produzione riporta il nostro marchio.

<p><b>CEI no.</b> 220.080</p> <p><b>O.E.M. Ref</b> 1626671 1613351 1599175</p> <p><b>Ø Tubo 62 mm</b></p>	<p><b>Lenght-L</b> 1779 mm</p> <p><b>Lenght-L1</b> 1726 mm</p> <p><b>Models</b> FL7</p> <p><b>Guida Destra / Right Drive</b></p>	<p><b>Barra di Accoppiamento - Assale Anteriore / Drag Link - Front Axle</b></p> 	<p><b>Ball Joint</b></p>  <p><b>198.626</b> M30x1,5</p>
---	--	---	--

<p><b>CEI no.</b> 220.167</p> <p><b>O.E.M. Ref</b> 1624464</p> <p><b>Ø Tubo 60 mm</b></p>	<p><b>Lenght-L</b> 1779 mm</p> <p><b>Lenght-L1</b> 1750 mm</p> <p><b>Models</b> FL10 FL12</p> <p><b>Guida Sinistra / Left Drive</b></p>	<p><b>Barra di Accoppiamento - Assale Anteriore / Drag Link - Front Axle</b></p>  <p>&lt;&lt;&lt; NESSUNA IMMAGINE - NO PICTURE &gt;&gt;&gt;</p>	<p><b>Ball Joint</b></p>  <p><b>198.626</b> M30x1,5</p>
---	---	--	---

<p><b>CEI no.</b> 220.080</p> <p><b>O.E.M. Ref</b> 1626671 1613351 1599175</p> <p><b>Ø Tubo 62 mm</b></p>	<p><b>Lenght-L</b> 1779 mm</p> <p><b>Lenght-L1</b> 1726 mm</p> <p><b>Models</b> FL10 FL12</p> <p><b>Guida Destra / Right Drive</b></p>	<p><b>Barra di Accoppiamento - Assale Anteriore / Drag Link - Front Axle</b></p> 	<p><b>Ball Joint</b></p>  <p><b>198.626</b> M30x1,5</p>
---	--	---	--







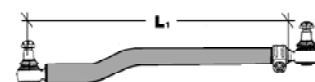
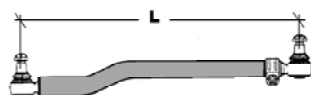



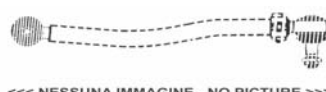



198.507 4669091	Suitable to <b>IVECO</b>		L mm 515	L1 mm 460	Ø mm 46
198.508 4669094	Suitable to <b>IVECO</b>		L mm 625	L1 mm	Ø mm 46
<b>198.590</b> 8570528	Suitable to <b>IVECO</b>		L mm 708	L1 mm 655	Ø mm 40
<b>198.589</b> 8590435	Suitable to <b>IVECO</b>		L mm 715	L1 mm 665	Ø mm 40
198.593 8567618	Suitable to <b>IVECO</b>		L mm 755	L1 mm 710	Ø mm 40
<b>198.591</b> 8591219	Suitable to <b>IVECO</b>		L mm 766	L1 mm 720	Ø mm 30
<b>220.280</b> 500324282	Suitable to <b>IVECO</b>		L mm 785	L1 mm 740	Ø mm 40
198.502 4665501	Suitable to <b>IVECO</b>		L mm 790	L1 mm 740	Ø mm 35
<b>198.633</b> 98467459	Suitable to <b>IVECO</b>		L mm 822	L1 mm 770	Ø mm 40
<b>220.183</b> 98402544	Suitable to <b>IVECO</b>		L mm 822	L1 mm 770	Ø mm 40
<b>198.500</b> 8558522	Suitable to <b>IVECO</b>		L mm 825	L1 mm 780	Ø mm 30
<b>198.595</b> 8559559	Suitable to <b>IVECO</b>		L mm 830	L1 mm 780	Ø mm 30
<b>220.138</b> 98469650	Suitable to <b>IVECO</b>		L mm 878	L1 mm 824	Ø mm 36











All original equipment manufacturers' numbers, symbols, pictures, models and description used in this catalogue are for reference only, and it is not implied that any part listed is the product of these manufacturers. Tutti i nostri particolari non sono originali ma con essi intercambiabili. I riferimenti originali, le figure, i modelli sono esposti a semplice titolo indicativo. La nostra produzione riporta il nostro marchio.

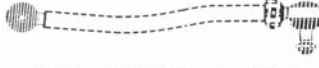

All original equipment manufacturer's numbers, symbols, pictures, models and description used in this catalogue are for reference only, and it is not implied that any part listed is the product of these manufacturers. Tutti i nostri particolari non sono originali ma con essi intercambiabili. I riferimenti originali, le figure, i modelli sono esposti a semplice titolo indicativo. La nostra produzione riporta il nostro marchio.



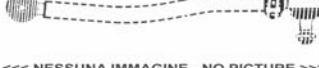









198.521 4573092	Suitable to <b>IVECO</b>	 <<< NESSUNA IMMAGINE - NO PICTURE >>>	L mm <b>885</b>	L1 mm <b>830</b>	Ø mm
220.137 98493054	Suitable to <b>IVECO</b>	 <<< NESSUNA IMMAGINE - NO PICTURE >>>	L mm <b>887</b>	L1 mm	Ø mm
<b>198.512</b> 42001326	Suitable to <b>IVECO</b>		L mm <b>890</b>	L1 mm <b>835</b>	Ø mm <b>42</b>
<b>220.209</b> 504049893	Suitable to <b>IVECO</b>		L mm <b>890</b>	L1 mm <b>851</b>	Ø mm <b>42</b>
<b>198.634</b> 4854874	Suitable to <b>IVECO</b>		L mm <b>897</b>	L1 mm <b>865</b>	Ø mm <b>42</b>
<b>220.013</b> 98446354	Suitable to <b>IVECO</b>		L mm <b>901</b>	L1 mm <b>853</b>	Ø mm <b>52</b>
198.503 4733752	Suitable to <b>IVECO</b>		L mm <b>904</b>	L1 mm <b>854</b>	Ø mm <b>48</b>
198.543 4545422	Suitable to <b>IVECO</b>		L mm <b>905</b>	L1 mm <b>855</b>	Ø mm
198.504 4733704	Suitable to <b>IVECO</b>	 <<< NESSUNA IMMAGINE - NO PICTURE >>>	L mm <b>910</b>	L1 mm <b>855</b>	Ø mm <b>46</b>
<b>198.513</b> 42042950	Suitable to <b>IVECO</b>		L mm <b>910</b>	L1 mm <b>855</b>	Ø mm <b>42</b>
<b>220.139</b> 41005475	Suitable to <b>IVECO</b>		L mm <b>952</b>	L1 mm <b>900</b>	Ø mm <b>52</b>
<b>220.014</b> 41005463	Suitable to <b>IVECO</b>		L mm <b>953</b>	L1 mm <b>895</b>	Ø mm <b>52</b>
<b>220.140</b> 500397738	Suitable to <b>IVECO</b>		L mm <b>959</b>	L1 mm <b>883</b>	Ø mm <b>52</b>

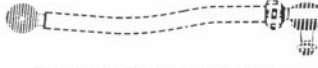

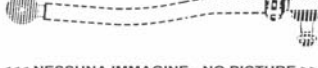



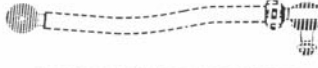







<b>220.208</b> 41215165	Suitable to <b>IVECO</b>		L mm <b>959</b>	L1 mm <b>905</b>	Ø mm <b>52</b>
<b>220.136</b> 98473328	Suitable to <b>IVECO</b>	 <<< NESSUNA IMMAGINE - NO PICTURE >>>	L mm <b>966</b>	L1 mm <b>48</b>	Ø mm <b>48</b>
<b>198.505</b> 4699246	Suitable to <b>IVECO</b>		L mm <b>970</b>	L1 mm <b>920</b>	Ø mm <b>46</b>
<b>198.506</b> 4699305	Suitable to <b>IVECO</b>	 <<< NESSUNA IMMAGINE - NO PICTURE >>>	L mm <b>970</b>	L1 mm <b>920</b>	Ø mm <b>46</b>
<b>220.011</b> 4715615	Suitable to <b>IVECO</b>		L mm <b>971</b>	L1 mm <b>920</b>	Ø mm <b>48</b>
<b>198.587</b> 4834037	Suitable to <b>IVECO</b>		L mm <b>979</b>	L1 mm <b>930</b>	Ø mm <b>36</b>
<b>198.632</b> 4815933	Suitable to <b>IVECO</b>		L mm <b>979</b>	L1 mm <b>930</b>	Ø mm <b>40</b>
<b>198.509</b> 4747961	Suitable to <b>IVECO</b>		L mm <b>982</b>	L1 mm <b>932</b>	Ø mm <b>46</b>
<b>198.585</b> 42087842	Suitable to <b>IVECO</b>		L mm <b>982</b>	L1 mm <b>930</b>	Ø mm <b>46</b>
<b>220.047</b> 4747961	Suitable to <b>IVECO</b>		L mm <b>982</b>	L1 mm <b>933</b>	Ø mm <b>48</b>
<b>198.588</b> 61590910	Suitable to <b>IVECO</b>	 <<< NESSUNA IMMAGINE - NO PICTURE >>>	L mm <b>985</b>	L1 mm <b>935</b>	Ø mm <b>40</b>
<b>220.005</b> 4793166	Suitable to <b>IVECO</b>		L mm <b>1001</b>	L1 mm <b>950</b>	Ø mm <b>48</b>
<b>198.526</b> 61595957	Suitable to <b>IVECO</b>		L mm <b>1020</b>	L1 mm <b>975</b>	Ø mm <b>38</b>

All original equipment manufacturers' numbers, symbols, pictures, models and description used in this catalogue are for reference only, and it is not implied that any part listed is the product of these manufacturers. Tutti i nostri particolari non sono originali ma con essi intercambiabili. I riferimenti originali, le figure, i modelli sono esposti a semplice titolo indicativo. La nostra produzione riporta il nostro marchio.

All original equipment manufacturer's numbers, symbols, pictures, models and description used in this catalogue are for reference only, and it is not implied that any part listed is the product of these manufacturers. Tutti i nostri particolari non sono originali ma con essi intercambiabili. I riferimenti originali, le figure, i modelli sono esposti a semplice titolo indicativo. La nostra produzione riporta il nostro marchio.







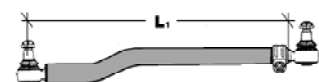
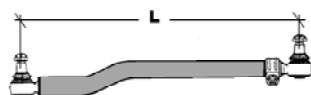





<b>198.586</b> 61595960	Suitable to <b>IVECO</b>		L mm <b>1028</b>	L 1 mm <b>978</b>	Ø mm <b>38</b>
<b>220.135</b> 98475709	Suitable to <b>IVECO</b>		L mm <b>1190</b>	L 1 mm <b>1165</b>	Ø mm <b>52</b>
<b>198.566</b> 4711108	Suitable to <b>IVECO BUS</b>		L mm <b>845</b>	L 1 mm <b>800</b>	Ø mm <b>50</b>
<b>220.290</b> 4854871	Suitable to <b>IVECO</b>	 ««« NESSUNA IMMAGINE - NO PICTURE »»»	L mm <b>1584</b>	L 1 mm <b>40</b>	Ø mm <b>40</b>
<b>220.144</b> 4838587	Suitable to <b>IVECO BUS</b>	 ««« NESSUNA IMMAGINE - NO PICTURE »»»	L mm <b>780</b>	L 1 mm <b>48</b>	Ø mm <b>48</b>
<b>220.145</b> 4826513	Suitable to <b>IVECO BUS</b>	 ««« NESSUNA IMMAGINE - NO PICTURE »»»	L mm <b>780</b>	L 1 mm <b>48</b>	Ø mm <b>48</b>
<b>220.016</b> 42044493	Suitable to <b>IVECO BUS</b>	 ««« NESSUNA IMMAGINE - NO PICTURE »»»	L mm <b>796</b>	L 1 mm <b>750</b>	Ø mm <b>48</b>
<b>220.142</b> 98420110	Suitable to <b>IVECO BUS</b>	 ««« NESSUNA IMMAGINE - NO PICTURE »»»	L mm <b>860</b>	L 1 mm <b>30</b>	Ø mm <b>30</b>
<b>220.141</b> 500336085	Suitable to <b>IVECO BUS</b>	 ««« NESSUNA IMMAGINE - NO PICTURE »»»	L mm <b>883</b>	L 1 mm <b>52</b>	Ø mm <b>52</b>
<b>220.143</b> 500311471	Suitable to <b>IVECO BUS</b>	 ««« NESSUNA IMMAGINE - NO PICTURE »»»	L mm <b>888</b>	L 1 mm <b>62</b>	Ø mm <b>62</b>
<b>220.206</b> 4704183	Suitable to <b>IVECO BUS</b>		L mm <b>1050</b>	L 1 mm <b>970</b>	Ø mm <b>48</b>
<b>220.004</b> 4741957	Suitable to <b>IVECO BUS</b>	 ««« NESSUNA IMMAGINE - NO PICTURE »»»	L mm <b>1441</b>	L 1 mm <b>1390</b>	Ø mm <b>48</b>
<b>220.033</b> 94016	Suitable to <b>DAF</b>		L mm <b>744</b>	L 1 mm <b>680</b>	Ø mm <b>40</b>













<b>220.284</b> 1351716	Suitable to <b>DAF</b>		L mm <b>840</b>	L1 mm <b>805</b>	Ø mm <b>52</b>
<b>220.281</b> 1602820	Suitable to <b>DAF</b>		L mm <b>843</b>	L1 mm <b>805</b>	Ø mm <b>50</b>
<b>220.078</b> 1351715	Suitable to <b>DAF</b>		L mm <b>848</b>	L1 mm <b>798</b>	Ø mm <b>52</b>
<b>220.283</b> 1448064	Suitable to <b>DAF</b>		L mm <b>855</b>	L1 mm <b>815</b>	Ø mm <b>52</b>
<b>220.282</b> 1602821	Suitable to <b>DAF</b>		L mm <b>857</b>	L1 mm <b>806</b>	Ø mm <b>50</b>
<b>220.015</b> 94029	Suitable to <b>DAF</b>		L mm <b>872</b>	L1 mm <b>805</b>	Ø mm <b>40</b>
<b>220.077</b> 1351714	Suitable to <b>DAF</b>		L mm <b>876</b>	L1 mm <b>825</b>	Ø mm <b>52</b>
<b>220.194</b> 1700913	Suitable to <b>DAF</b>		L mm <b>890</b>	L1 mm <b>840</b>	Ø mm <b>52</b>
<b>220.001</b> 94038	Suitable to <b>DAF</b>		L mm <b>995</b>	L1 mm <b>960</b>	Ø mm <b>50</b>
<b>220.214</b> 1426101	Suitable to <b>DAF</b>		L mm <b>1004</b>	L1 mm <b>950</b>	Ø mm <b>52</b>
<b>220.150</b> 1351734	Suitable to <b>DAF</b>		L mm <b>1005</b>	L1 mm <b>980</b>	Ø mm <b>62</b>
<b>220.193</b> 1351735	Suitable to <b>DAF</b>		L mm <b>1008</b>	L1 mm <b>946</b>	Ø mm <b>62</b>
<b>220.205</b> 1353396	Suitable to <b>DAF</b>		L mm <b>1725</b>	L1 mm <b>1680</b>	Ø mm <b>52</b>

All original equipment manufacturers' numbers, symbols, pictures, models and description used in this catalogue are for reference only, and it is not implied that any part listed is the product of these manufacturers. Tutti i nostri particolari non sono originali ma con essi intercambiabili. I riferimenti originali, le figure, i modelli sono esposti a semplice titolo indicativo. La nostra produzione riporta il nostro marchio.



All original equipment manufacturers' numbers, symbols, pictures, models and description used in this catalogue are for reference only, and it is not implied that any part listed is the product of these manufacturers. Tutti i nostri particolari non sono originali ma con essi intercambiabili. I riferimenti originali, le figure, i modelli sono esposti a semplice titolo indicativo. La nostra produzione riporta il nostro marchio.

220.212 1401937	Suitable to <b>DAF</b>	 <<< NESSUNA IMMAGINE - NO PICTURE >>>	L mm	L 1 mm	Ø mm
				930	46
220.213 1405309	Suitable to <b>DAF</b>	 <<< NESSUNA IMMAGINE - NO PICTURE >>>	L mm	L 1 mm	Ø mm
				926	46
<b>220.215</b> 667 460 1705	Suitable to <b>MERCEDES</b>		L mm	L 1 mm	Ø mm
			500	455	34
220.155 356 330 0103	Suitable to <b>MERCEDES</b>	 <<< NESSUNA IMMAGINE - NO PICTURE >>>	L mm	L 1 mm	Ø mm
			506		30
220.154 356 330 0003	Suitable to <b>MERCEDES</b>	 <<< NESSUNA IMMAGINE - NO PICTURE >>>	L mm	L 1 mm	Ø mm
			697		32
<b>220.032</b> 673 460 0605	Suitable to <b>MERCEDES</b>		L mm	L 1 mm	Ø mm
			725	680	36
<b>220.038</b> 675 460 3005	Suitable to <b>MERCEDES</b>		L mm	L 1 mm	Ø mm
			727	670	40
<b>220.006</b> 675 460 2205	Suitable to <b>MERCEDES</b>		L mm	L 1 mm	Ø mm
			780	730	40
<b>220.019</b> 676 460 1105	Suitable to <b>MERCEDES</b>		L mm	L 1 mm	Ø mm
			780	740	40
220.216 676 460 2105	Suitable to <b>MERCEDES</b>	 <<< NESSUNA IMMAGINE - NO PICTURE >>>	L mm	L 1 mm	Ø mm
			783		42
<b>220.178</b> 972 460 1405	Suitable to <b>MERCEDES</b>		L mm	L 1 mm	Ø mm
			815	785	40
<b>220.180</b> 972 460 2805	Suitable to <b>MERCEDES</b>		L mm	L 1 mm	Ø mm
			830	795	42
<b>220.030</b> 001 460 0405	Suitable to <b>MERCEDES</b>		L mm	L 1 mm	Ø mm
			840	786	48





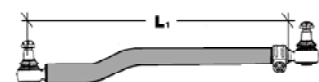
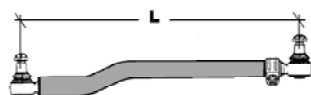







<b>220.119</b> 001 460 2905	Suitable to <b>MERCEDES</b>		L mm <b>840</b>	L1 mm <b>778</b>	Ø mm <b>52</b>
<b>220.177</b> 970 460 0705	Suitable to <b>MERCEDES</b>		L mm <b>840</b>	L1 mm <b>795</b>	Ø mm <b>42</b>
<b>220.117</b> 619 460 2905	Suitable to <b>MERCEDES</b>		L mm <b>860</b>	L1 mm <b>804</b>	Ø mm <b>42</b>
<b>220.172</b> 625 460 2505	Suitable to <b>MERCEDES</b>		L mm <b>860</b>	L1 mm <b>818</b>	Ø mm <b>42</b>
<b>220.035</b> 617 460 3405	Suitable to <b>MERCEDES</b>		L mm <b>863</b>	L1 mm <b>794</b>	Ø mm <b>42</b>
<b>198.535</b> 647 460 0105	Suitable to <b>MERCEDES</b>		L mm <b>865</b>	L1 mm <b>815</b>	Ø mm <b>40</b>
<b>220.037</b> 620 460 3005	Suitable to <b>MERCEDES</b>		L mm <b>865</b>	L1 mm <b>800</b>	Ø mm <b>40</b>
<b>220.152</b> 387 460 4405	Suitable to <b>MERCEDES</b>	 ««« NESSUNA IMMAGINE - NO PICTURE »»»	L mm <b>865</b>	L1 mm <b>40</b>	Ø mm <b>40</b>
<b>220.153</b> 002 460 1405	Suitable to <b>MERCEDES</b>		L mm <b>865</b>	L1 mm <b>835</b>	Ø mm <b>48</b>
<b>220.085</b> 001 460 9805	Suitable to <b>MERCEDES</b>		L mm <b>866</b>	L1 mm <b>812</b>	Ø mm <b>38</b>
<b>220.184</b> 002 460 7505	Suitable to <b>MERCEDES</b>		L mm <b>870</b>	L1 mm <b>836</b>	Ø mm <b>38</b>
<b>220.084</b> 000 460 9305	Suitable to <b>MERCEDES</b>		L mm <b>873</b>	L1 mm <b>808</b>	Ø mm <b>40</b>
<b>220.220</b> 972 460 1205	Suitable to <b>MERCEDES</b>		L mm <b>873</b>	L1 mm <b>820</b>	Ø mm <b>40</b>

All original equipment manufacturers numbers, symbols, pictures, models and description used in this catalogue are for reference only, and it is not implied that any part listed is the product of these manufacturers. Tutti i nostri particolari non sono originali ma con essi intercambiabili. I riferimenti originali, le figure, i modelli sono esposti a semplice titolo indicativo. La nostra produzione riporta il nostro marchio.





All original equipment manufacturers' numbers, symbols, pictures, models and description used in this catalogue are for reference only, and it is not implied that any part listed is the product of these manufacturers. Tutti i nostri particolari non sono originali ma con essi intercambiabili. I riferimenti originali, le figure, i modelli sono esposti a semplice titolo indicativo. La nostra produzione riporta il nostro marchio.

<b>220.083</b> 002 460 4805	Suitable to <b>MERCEDES</b>		L mm <b>876</b>	L1 mm <b>824</b>	Ø mm <b>40</b>
<b>220.059</b> 001 460 6705	Suitable to <b>MERCEDES</b>		L mm <b>879</b>	L1 mm <b>815</b>	Ø mm <b>42</b>
<b>220.082</b> 002 460 4305	Suitable to <b>MERCEDES</b>		L mm <b>879</b>	L1 mm <b>822</b>	Ø mm <b>36</b>
<b>220.151</b> 387 460 4805	Suitable to <b>MERCEDES</b>	 <<< NESSUNA IMMAGINE - NO PICTURE >>>	L mm <b>880</b>	L1 mm <b>880</b>	Ø mm <b>40</b>
<b>220.179</b> 972 460 1805	Suitable to <b>MERCEDES</b>		L mm <b>880</b>	L1 mm <b>830</b>	Ø mm <b>50</b>
<b>220.181</b> 002 460 4605	Suitable to <b>MERCEDES</b>		L mm <b>880</b>	L1 mm <b>830</b>	Ø mm <b>36</b>
<b>198.628</b> 620 460 3705	Suitable to <b>MERCEDES</b>		L mm <b>885</b>	L1 mm <b>835</b>	Ø mm <b>40</b>
<b>220.226</b> 002 460 5205	Suitable to <b>MERCEDES</b>		L mm <b>885</b>	L1 mm <b>825</b>	Ø mm <b>38</b>
<b>220.081</b> 001 460 0705	Suitable to <b>MERCEDES</b>		L mm <b>888</b>	L1 mm <b>830</b>	Ø mm <b>38</b>
<b>198.536</b> 383 460 4405	Suitable to <b>MERCEDES</b>		L mm <b>890</b>	L1 mm <b>840</b>	Ø mm <b>40</b>
<b>220.031</b> 383 460 4505	Suitable to <b>MERCEDES</b>		L mm <b>890</b>	L1 mm <b>833</b>	Ø mm <b>40</b>
<b>220.131</b> 974 460 1205	Suitable to <b>MERCEDES</b>		L mm <b>894</b>	L1 mm <b>826</b>	Ø mm <b>50</b>
<b>220.132</b> 002 460 5005	Suitable to <b>MERCEDES</b>		L mm <b>895</b>	L1 mm <b>842</b>	Ø mm <b>40</b>

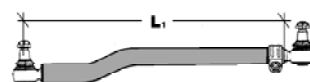
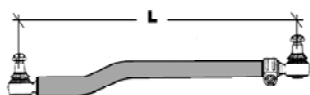

Part Number	Part Name	Image	L mm	L1 mm	Ø mm
<b>220.185</b> 002 460 7705	Suitable to <b>MERCEDES</b>		895	866	36
<b>220.040</b> 000 460 9805	Suitable to <b>MERCEDES</b>		900	845	48
<b>220.227</b> 001 460 7105	Suitable to <b>MERCEDES</b>		904	855	52
<b>220.221</b> 001 460 8105	Suitable to <b>MERCEDES</b>	 ««« NESSUNA IMMAGINE - NO PICTURE »»»	909		42
<b>220.225</b> 002 460 6005	Suitable to <b>MERCEDES</b>	 ««« NESSUNA IMMAGINE - NO PICTURE »»»	935		38
<b>220.027</b> 300 460 070	Suitable to <b>MERCEDES</b>		975	930	36
<b>220.028</b> 300 460 0505	Suitable to <b>MERCEDES</b>		1146	1110	38
<b>220.089</b> 945 330 0203	Suitable to <b>MERCEDES</b>		1465	1355	40
<b>220.090</b> 942 330 0903	Suitable to <b>MERCEDES</b>		1565	1455	50
<b>220.125</b> 944 330 0203	Suitable to <b>MERCEDES</b>		1580	1532	60
<b>220.042</b> 625 330 2503	Suitable to <b>MERCEDES</b>		1590	1510	50
<b>220.050</b> 393 330 0303	Suitable to <b>MERCEDES</b>		1620	1515	50
<b>220.164</b> 942 330 0803	Suitable to <b>MERCEDES</b>		1625	1525	52



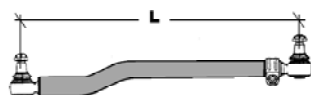



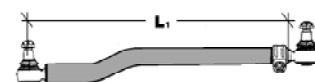





All original equipment manufacturers' numbers, symbols, pictures, models and description used in this catalogue are for reference only, and it is not implied that any part listed is the product of these manufacturers. Tutti i nostri particolari non sono originali ma con essi intercambiabili. I riferimenti originali, le figure, i modelli sono esposti a semplice titolo indicativo. La nostra produzione riporta il nostro marchio.















Note Tecniche  
Technical Notes  
L = mm  
L1 = mm















All original equipment manufacturer's numbers, symbols, pictures, models and description used in this catalogue are for reference only, and it is not implied that any part listed is the product of these manufacturers. Tutti i nostri particolari non sono originali ma con essi intercambiabili. I riferimenti originali, le figure, i modelli sono esposti a semplice titolo indicativo. La nostra produzione riporta il nostro marchio.

<b>220.182</b> 970 330 0003	Suitable to <b>MERCEDES</b>		L mm <b>1640</b>	L 1 mm <b>1573</b>	Ø mm <b>40</b>
<b>220.043</b> 620 330 0503	Suitable to <b>MERCEDES</b>		L mm <b>1665</b>	L 1 mm <b>1565</b>	Ø mm <b>50</b>
<b>220.086</b> 941 330 0103	Suitable to <b>MERCEDES</b>		L mm <b>1735</b>	L 1 mm <b>1630</b>	Ø mm <b>50</b>
<b>220.087</b> 942 330 0103	Suitable to <b>MERCEDES</b>		L mm <b>1735</b>	L 1 mm <b>1665</b>	Ø mm <b>52</b>
<b>220.088</b> 945 330 0103	Suitable to <b>MERCEDES</b>		L mm <b>1735</b>	L 1 mm <b>1646</b>	Ø mm <b>62</b>
<b>220.219</b> 974 460 2205	Suitable to <b>MERCEDES</b>	 ««« NESSUNA IMMAGINE - NO PICTURE »»»	L mm	L 1 mm <b>884</b>	Ø mm <b>50</b>
<b>220.039</b> 81 46711 6759	Suitable to <b>MAN</b>		L mm <b>728</b>	L 1 mm	Ø mm <b>40</b>
<b>220.127</b> 81 46610 6305	Suitable to <b>MAN</b>		L mm <b>785</b>	L 1 mm <b>740</b>	Ø mm <b>34</b>
<b>220.236</b> 85 46610 6141	Suitable to <b>MAN</b>		L mm <b>795</b>	L 1 mm <b>745</b>	Ø mm <b>38</b>
<b>220.249</b> 85 46610 6162	Suitable to <b>MAN</b>	 ««« NESSUNA IMMAGINE - NO PICTURE »»»	L mm	L 1 mm <b>820</b>	Ø mm <b>38</b>
<b>220.156</b> 85 46610 6104	Suitable to <b>MAN</b>		L mm <b>825</b>	L 1 mm <b>780</b>	Ø mm <b>38</b>
<b>220.228</b> 85 46610 6140	Suitable to <b>MAN</b>		L mm <b>840</b>	L 1 mm <b>800</b>	Ø mm <b>38</b>
<b>220.207</b> 85 46610 6102	Suitable to <b>MAN</b>		L mm <b>850</b>	L 1 mm <b>826</b>	Ø mm <b>32</b>

<b>220.238</b> 85 46610 6142	Suitable to <b>MAN</b>		L mm <b>860</b>	L1 mm <b>810</b>	Ø mm <b>38</b>
<b>220.237</b> 85 46610 6143	Suitable to <b>MAN</b>	 «« NESSUNA IMMAGINE - NO PICTURE »»	L mm <b>860</b>	L1 mm <b>810</b>	Ø mm <b>38</b>
<b>220.246</b> 85 46610 6246	Suitable to <b>MAN</b>	 «« NESSUNA IMMAGINE - NO PICTURE »»	L mm <b>864</b>	L1 mm <b>810</b>	Ø mm <b>38</b>
<b>220.241</b> 85 46610 6150	Suitable to <b>MAN</b>		L mm <b>910</b>	L1 mm <b>855</b>	Ø mm <b>40</b>
<b>220.196</b> 81 46611 6199	Suitable to <b>MAN</b>		L mm <b>950</b>	L1 mm <b>915</b>	Ø mm <b>52</b>
<b>220.234</b> 81 46710 6436	Suitable to <b>MAN</b>		L mm <b>955</b>	L1 mm <b>905</b>	Ø mm <b>40</b>
<b>220.130</b> 81 46611 6197	Suitable to <b>MAN</b>		L mm <b>963</b>	L1 mm <b>935</b>	Ø mm <b>60</b>
<b>220.242</b> 85 46610 6151	Suitable to <b>MAN</b>		L mm <b>975</b>	L1 mm <b>915</b>	Ø mm <b>40</b>
<b>220.230</b> 85 46610 6152	Suitable to <b>MAN</b>		L mm <b>980</b>	L1 mm <b>925</b>	Ø mm <b>42</b>
<b>220.233</b> 81 46710 6438	Suitable to <b>MAN</b>		L mm <b>1000</b>	L1 mm <b>950</b>	Ø mm <b>40</b>
<b>220.232</b> 81 46710 6442	Suitable to <b>MAN</b>		L mm <b>1005</b>	L1 mm <b>950</b>	Ø mm <b>42</b>
<b>220.229</b> 85 46610 6155	Suitable to <b>MAN</b>	 «« NESSUNA IMMAGINE - NO PICTURE »»	L mm <b>1020</b>	L1 mm <b>950</b>	Ø mm <b>42</b>
<b>220.251</b> 81 46611 6201	Suitable to <b>MAN</b>	 «« NESSUNA IMMAGINE - NO PICTURE »»	L mm <b>1021</b>	L1 mm <b>950</b>	Ø mm <b>52</b>







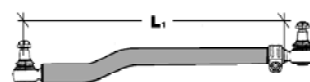
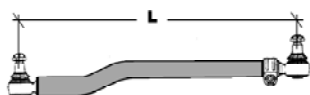





All original equipment manufacturers' numbers, symbols, pictures, models and description used in this catalogue are for reference only, and it is not implied that any part listed is the product of these manufacturers. Tutti i nostri particolari non sono originali ma con essi intercambiabili. I riferimenti originali, le figure, i modelli sono esposti a semplice titolo indicativo. La nostra produzione riporta il nostro marchio.

All original equipment manufacturers' numbers, symbols, pictures, models and description used in this catalogue are for reference only, and it is not implied that any part listed is the product of these manufacturers. Tutti i nostri particolari non sono originali ma con essi intercambiabili. I riferimenti originali, le figure, i modelli sono esposti a semplice titolo indicativo. La nostra produzione riporta il nostro marchio.

<b>220.007</b> 81 46610 6722	Suitable to <b>MAN</b>		L mm <b>1030</b>	L 1 mm <b>985</b>	Ø mm <b>50</b>
<b>220.287</b> 81 46710 6912	Suitable to <b>MAN</b>		L mm <b>1572</b>	L 1 mm <b>1532</b>	Ø mm <b>52</b>
<b>220.044</b> 81 46710 6904	Suitable to <b>MAN</b>		L mm <b>1628</b>	L 1 mm <b>1570</b>	Ø mm <b>50</b>
<b>220.009</b> 81 46710 6354	Suitable to <b>MAN</b>		L mm <b>1652</b>	L 1 mm <b>1540</b>	Ø mm <b>50</b>
<b>220.197</b> 81 46711 6860	Suitable to <b>MAN</b>		L mm <b>1660</b>	L 1 mm <b>1610</b>	Ø mm <b>52</b>
<b>220.285</b> 82 46610 6191	Suitable to <b>MAN</b>		L mm <b>1755</b>	L 1 mm <b>1705</b>	Ø mm <b>50</b>
<b>220.286</b> 81 46710 6418	Suitable to <b>MAN</b>		L mm <b>1795</b>	L 1 mm <b>1732</b>	Ø mm <b>50</b>
<b>220.100</b> 50 10 383 410	Suitable to <b>RENAULT</b>		L mm <b>570</b>	L 1 mm <b>473</b>	Ø mm <b>30</b>
<b>220.253</b> 50 01 868 374	Suitable to <b>RENAULT</b>	 <<< NESSUNA IMMAGINE - NO PICTURE >>>	L mm <b>605</b>	L 1 mm <b>52</b>	Ø mm <b>52</b>
<b>220.257</b> 50 10 557 523	Suitable to <b>RENAULT</b>	 <<< NESSUNA IMMAGINE - NO PICTURE >>>	L mm <b>695</b>	L 1 mm <b>52</b>	Ø mm <b>52</b>
<b>220.068</b> 50 10 060 764	Suitable to <b>RENAULT</b>		L mm <b>720</b>	L 1 mm <b>670</b>	Ø mm <b>36</b>
<b>220.112</b> 50 10 130 344	Suitable to <b>RENAULT</b>		L mm <b>737</b>	L 1 mm <b>716</b>	Ø mm <b>52</b>
<b>220.163</b> 50 10 383 203	Suitable to <b>RENAULT</b>		L mm <b>762</b>	L 1 mm <b>692</b>	Ø mm <b>52</b>

















220.161 58 10 112 248	Suitable to <b>RENAULT</b>	 <<< NESSUNA IMMAGINE - NO PICTURE >>>	L mm <b>805</b>	L 1 mm <b>42</b>	Ø mm
<b>220.065</b> 50 10 294 287	Suitable to <b>RENAULT</b>		L mm <b>809</b>	L 1 mm <b>755</b>	Ø mm <b>50</b>
220.022 50 10 130 483	Suitable to <b>RENAULT</b>		L mm <b>825</b>	L 1 mm <b>790</b>	Ø mm <b>52</b>
<b>220.064</b> 50 10 294 288	Suitable to <b>RENAULT</b>		L mm <b>825</b>	L 1 mm <b>773</b>	Ø mm <b>52</b>
220.265 50 10 294 720	Suitable to <b>RENAULT</b>	 <<< NESSUNA IMMAGINE - NO PICTURE >>>	L mm <b>827</b>	L 1 mm <b>52</b>	Ø mm
<b>220.102</b> 50 10 294 502	Suitable to <b>RENAULT</b>		L mm <b>860</b>	L 1 mm <b>805</b>	Ø mm <b>52</b>
<b>220.103</b> 50 10 630 617	Suitable to <b>RENAULT</b>		L mm <b>864</b>	L 1 mm <b>811</b>	Ø mm <b>62</b>
<b>220.091</b> 50 10 294 199	Suitable to <b>RENAULT</b>		L mm <b>870</b>	L 1 mm <b>815</b>	Ø mm <b>38</b>
<b>220.024</b> 50 10 130 393	Suitable to <b>RENAULT</b>		L mm <b>872</b>	L 1 mm <b>825</b>	Ø mm <b>40</b>
220.093 50 00 541 230	Suitable to <b>RENAULT</b>	 <<< NESSUNA IMMAGINE - NO PICTURE >>>	L mm <b>880</b>	L 1 mm <b>40</b>	Ø mm
<b>220.092</b> 50 10 488 165	Suitable to <b>RENAULT</b>		L mm <b>883</b>	L 1 mm <b>844</b>	Ø mm <b>42</b>
<b>220.158</b> 50 10 488 164	Suitable to <b>RENAULT</b>		L mm <b>883</b>	L 1 mm <b>847</b>	Ø mm <b>42</b>
<b>220.063</b> 50 10 130 456	Suitable to <b>RENAULT</b>		L mm <b>885</b>	L 1 mm <b>845</b>	Ø mm <b>40</b>

All original equipment manufacturers' numbers, symbols, pictures, models and description used in this catalogue are for reference only, and it is not implied that any part listed is the product of these manufacturers. Tutti i nostri particolari non sono originali ma con essi intercambiabili. I riferimenti originali, le figure, i modelli sono esposti a semplice titolo indicativo. La nostra produzione riporta il nostro marchio.

All original equipment manufacturer's numbers, symbols, pictures, models and description used in this catalogue are for reference only, and it is not implied that any part listed is the product of these manufacturers. Tutti i nostri particolari non sono originali ma con essi intercambiabili. I riferimenti originali, le figure, i modelli sono esposti a semplice titolo indicativo. La nostra produzione riporta il nostro marchio.

220.157 50 00 446 680	Suitable to <b>RENAULT</b>	 <<< NESSUNA IMMAGINE - NO PICTURE >>>	L mm <b>898</b>	L1 mm <b>30</b>	Ø mm
220.252 50 10 259 241	Suitable to <b>RENAULT</b>	 <<< NESSUNA IMMAGINE - NO PICTURE >>>	L mm <b>903</b>	L1 mm <b>50</b>	Ø mm
<b>220.159</b> 50 10 488 166	Suitable to <b>RENAULT</b>		L mm <b>924</b>	L1 mm <b>890</b>	Ø mm <b>40</b>
<b>220.160</b> 50 10 488 146	Suitable to <b>RENAULT</b>		L mm <b>930</b>	L1 mm <b>891</b>	Ø mm <b>42</b>
<b>220.098</b> 50 10 488 052	Suitable to <b>RENAULT</b>		L mm <b>936</b>	L1 mm <b>889</b>	Ø mm <b>52</b>
<b>220.104</b> 50 10 488 167	Suitable to <b>RENAULT</b>		L mm <b>946</b>	L1 mm <b>895</b>	Ø mm <b>42</b>
<b>220.008</b> 50 10 144 552	Suitable to <b>RENAULT</b>		L mm <b>975</b>	L1 mm <b>928</b>	Ø mm <b>52</b>
220.010 50 10 144 556	Suitable to <b>RENAULT</b>		L mm <b>975</b>	L1 mm <b>938</b>	Ø mm <b>52</b>
220.061 50 10 144 554	Suitable to <b>RENAULT</b>	 <<< NESSUNA IMMAGINE - NO PICTURE >>>	L mm <b>975</b>	L1 mm <b>52</b>	Ø mm
<b>198.653</b> 50 10 130 453	Suitable to <b>RENAULT</b>		L mm <b>1012</b>	L1 mm <b>965</b>	Ø mm <b>52</b>
220.060 50 10 130 451	Suitable to <b>RENAULT</b>	 <<< NESSUNA IMMAGINE - NO PICTURE >>>	L mm <b>1012</b>	L1 mm <b>52</b>	Ø mm
<b>220.025</b> 50 10 239 340	Suitable to <b>RENAULT</b>		L mm <b>1018</b>	L1 mm <b>955</b>	Ø mm <b>62</b>
220.162 50 10 239 387	Suitable to <b>RENAULT</b>	 <<< NESSUNA IMMAGINE - NO PICTURE >>>	L mm <b>1040</b>	L1 mm <b>62</b>	Ø mm

Part Number	Suitable to	Image	L mm	L1 mm	Ø mm
<b>220.101</b> 50 10 566 048	<b>RENAULT</b>		1418	1350	30
<b>220.105</b> 50 10 566 062	<b>RENAULT</b>		1545	1470	52
<b>220.110</b> 50 10 566 058	<b>RENAULT</b>		1627	1567	40
<b>220.288</b> 50 10 308 082	<b>RENAULT</b>		1693	1655	48
<b>220.186</b> 50 10 439 022	<b>RENAULT</b>		1720	1566	30
220.277 50 10 566 064	<b>RENAULT</b>	 <<< NESSUNA IMMAGINE - NO PICTURE >>>	1720		
<b>220.187</b> 50 10 439 021	<b>RENAULT</b>		1758	1700	52
220.026 50 10 207 725	<b>RENAULT</b>		2075	2035	48
220.289 50 10 630 821	<b>RENAULT</b>	 <<< NESSUNA IMMAGINE - NO PICTURE >>>		830	62
220.272 382780	<b>SCANIA</b>	 <<< NESSUNA IMMAGINE - NO PICTURE >>>	554		40
<b>198.597</b> 291396	<b>SCANIA</b>		728	675	40
<b>220.133</b> 1300284	<b>SCANIA</b>		765	710	52
<b>220.165</b> 1324483	<b>SCANIA</b>		800	750	52



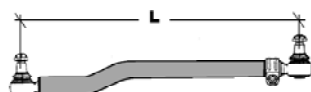



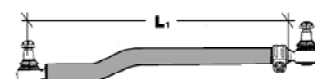





All original equipment manufacturers numbers, symbols, pictures, models and description used in this catalogue are for reference only, and it is not implied that any part listed is the product of these manufacturers. Tutti i nostri particolari non sono originali ma con essi intercambiabili. I riferimenti originali, le figure, i modelli sono esposti a semplice titolo indicativo. La nostra produzione riporta il nostro marchio.



Note Tecniche  
Technical Notes  
L = mm  
L1 = mm



All original equipment manufacturers' numbers, symbols, pictures, models and description used in this catalogue are for reference only, and it is not implied that any part listed is the product of these manufacturers. Tutti i nostri particolari non sono originali ma con essi intercambiabili. I riferimenti originali, le figure, i modelli sono esposti a semplice titolo indicativo. La nostra produzione riporta il nostro marchio.

220.271 389151	Suitable to <b>SCANIA</b>	 <<< NESSUNA IMMAGINE - NO PICTURE >>>	L mm <b>843</b>	L 1 mm <b>780</b>	Ø mm <b>52</b>
<b>220.134</b> 1112511	Suitable to <b>SCANIA</b>		L mm <b>843</b>	L 1 mm <b>785</b>	Ø mm <b>50</b>
<b>198.680</b> 390784	Suitable to <b>SCANIA</b>		L mm <b>855</b>	L 1 mm <b>810</b>	Ø mm <b>42</b>
220.264 1112023	Suitable to <b>SCANIA</b>	 <<< NESSUNA IMMAGINE - NO PICTURE >>>	L mm <b>900</b>	L 1 mm <b>810</b>	Ø mm <b>50</b>
<b>220.021</b> 1369919	Suitable to <b>SCANIA</b>		L mm <b>926</b>	L 1 mm <b>865</b>	Ø mm <b>50</b>
<b>198.690</b> 1304571	Suitable to <b>SCANIA</b>		L mm <b>926</b>	L 1 mm <b>870</b>	Ø mm <b>50</b>
220.095 1369917	Suitable to <b>SCANIA</b>	 <<< NESSUNA IMMAGINE - NO PICTURE >>>	L mm <b>926</b>	L 1 mm <b>890</b>	Ø mm <b>50</b>
220.270 345124	Suitable to <b>SCANIA</b>	 <<< NESSUNA IMMAGINE - NO PICTURE >>>	L mm <b>927</b>	L 1 mm <b>890</b>	Ø mm <b>50</b>
<b>220.012</b> 306981	Suitable to <b>SCANIA</b>		L mm <b>947</b>	L 1 mm <b>882</b>	Ø mm <b>48</b>
<b>198.596</b> 278665	Suitable to <b>SCANIA</b>		L mm <b>947</b>	L 1 mm <b>890</b>	Ø mm <b>48</b>
198.658 352635	Suitable to <b>SCANIA</b>		L mm <b>947</b>	L 1 mm <b>893</b>	Ø mm <b>48</b>
<b>220.066</b> 1769597	Suitable to <b>SCANIA</b>		L mm <b>1059</b>	L 1 mm <b>1006</b>	Ø mm <b>52</b>
<b>220.079</b> 1768898	Suitable to <b>SCANIA</b>		L mm <b>1059</b>	L 1 mm <b>1006</b>	Ø mm <b>52</b>





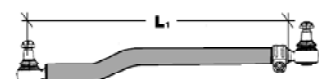
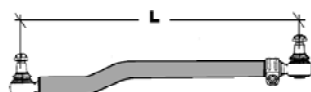







Part Number	Suitable to	Image	L mm	L1 mm	Ø mm
<b>220.067</b> 1409918	<b>SCANIA</b>		1743	1680	50
<b>220.176</b> 1395614	<b>SCANIA</b>		1750	1690	62
<b>198.622</b> 1626493	<b>VOLVO</b>		710	680	40
220.174 1588017	<b>VOLVO</b>	 «« NESSUNA IMMAGINE - NO PICTURE »»	738		42
<b>220.003</b> 1592940	<b>VOLVO</b>		823	755	50
<b>220.062</b> 1592939	<b>VOLVO</b>		823	755	50
220.274 1083745	<b>VOLVO</b>	 «« NESSUNA IMMAGINE - NO PICTURE »»	845		42
<b>198.623</b> 1626751	<b>VOLVO</b>		850	800	42
198.733 1626750	<b>VOLVO</b>		850	800	42
<b>220.058</b> 6790572	<b>VOLVO</b>		850	810	42
<b>220.166</b> 1080786	<b>VOLVO</b>		856	810	42
<b>220.175</b> 1083744	<b>VOLVO</b>		860	793	42
<b>220.034</b> 3988704	<b>VOLVO</b>		861	820	52

All original equipment manufacturers numbers, symbols, pictures, models and description used in this catalogue are for reference only, and it is not implied that any part listed is the product of these manufactures. Tutti i nostri particolari non sono originali ma con essi intercambiabili. I riferimenti originali, le figure, i modelli sono esposti a semplice titolo indicativo. La nostra produzione riporta il nostro marchio.





All original equipment manufacturer's numbers, symbols, pictures, models and description used in this catalogue are for reference only, and it is not implied that any part listed is the product of these manufacturers. Tutti i nostri particolari non sono originali ma con essi intercambiabili. I riferimenti originali, le figure, i modelli sono esposti a semplice titolo indicativo. La nostra produzione riporta il nostro marchio.







<b>220.056</b> 20393063	Suitable to <b>VOLVO</b>		L mm 861	L 1 mm 820	Ø mm 52
<b>220.029</b> 1075005	Suitable to <b>VOLVO</b>		L mm 863	L 1 mm 800	Ø mm 52
<b>220.057</b> 1075006	Suitable to <b>VOLVO</b>		L mm 863	L 1 mm 800	Ø mm 52
<b>220.169</b> 20393186	Suitable to <b>VOLVO</b>		L mm 863	L 1 mm 803	Ø mm 52
<b>220.276</b> 20393187	Suitable to <b>VOLVO</b>	 <<< NESSUNA IMMAGINE - NO PICTURE >>>	L mm 863	L 1 mm	Ø mm 52
<b>198.691</b> 1606283	Suitable to <b>VOLVO</b>		L mm 870	L 1 mm 815	Ø mm 42
<b>220.055</b> 1606284	Suitable to <b>VOLVO</b>		L mm 870	L 1 mm 815	Ø mm 42
<b>220.202</b> 1071344	Suitable to <b>VOLVO</b>		L mm 871	L 1 mm 830	Ø mm 48
<b>220.018</b> 1626749	Suitable to <b>VOLVO</b>		L mm 880	L 1 mm 830	Ø mm 42
<b>220.171</b> 1088299	Suitable to <b>VOLVO</b>	 <<< NESSUNA IMMAGINE - NO PICTURE >>>	L mm 880	L 1 mm 830	Ø mm 42
<b>220.048</b> 1628636	Suitable to <b>VOLVO</b>		L mm 881	L 1 mm 790	Ø mm 52
<b>220.076</b> 20393061	Suitable to <b>VOLVO</b>		L mm 881	L 1 mm 830	Ø mm 52
<b>220.173</b> 8153931	Suitable to <b>VOLVO</b>	 <<< NESSUNA IMMAGINE - NO PICTURE >>>	L mm 881	L 1 mm	Ø mm 52

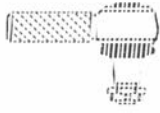

## **Testine Sterzo**

*Steering Joints*







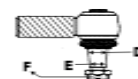
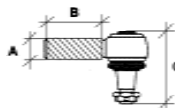

<p><b>CEI no.</b> 198.551</p> <p><b>O.E.M. Ref</b> 814304</p>	 <p style="text-align: center;">&lt;&lt;&lt; NESSUNA IMMAGINE - NO PICTURE &gt;&gt;&gt;</p> <p><b>Models</b> 616 N1/N2/N3</p>	<p><b>A 16x1,0 Destro / Right</b> <i>Misure / Size</i></p> <p><b>B</b> 52 <b>C</b> 65 <b>D</b> 15,9 <b>E</b> 14,5 <b>F</b> 12x1,5 <b>Conicita'</b> 1:8</p>
<p><b>CEI no.</b> 198.552</p> <p><b>O.E.M. Ref</b> 814305</p>	 <p><b>Models</b> 616 N1/N2/N3</p>	<p><b>A 16x1,0 Sinistro / Left</b> <i>Misure / Size</i></p> <p><b>B</b> 52 <b>C</b> 65 <b>D</b> 15,9 <b>E</b> 14,5 <b>F</b> 12x1,5 <b>Conicita'</b> 1:8</p>
<p><b>CEI no.</b> <b>198.494</b></p> <p><b>O.E.M. Ref</b> 4579231 9009501</p>	 <p><b>Models</b> 35/40/45 NC - OM50 - 625 N1/N2/N3</p>	<p><b>A 18x1,5 Destro / Right</b> <i>Misure / Size</i></p> <p><b>B</b> 70 <b>C</b> 80 <b>D</b> 18,2 <b>E</b> 16 <b>F</b> 14x1,5 <b>Conicita'</b> 1:10</p>
<p><b>CEI no.</b> <b>198.495</b></p> <p><b>O.E.M. Ref</b> 4579232 9009503</p>	 <p><b>Models</b> 35/40/45 NC - OM50 - 625 N1/N2/N3</p>	<p><b>A 18x1,5 Sinistro / Left</b> <i>Misure / Size</i></p> <p><b>B</b> 70 <b>C</b> 80 <b>D</b> 18,2 <b>E</b> 16 <b>F</b> 14x1,5 <b>Conicita'</b> 1:10</p>
<p><b>CEI no.</b> <b>198.475</b></p> <p><b>O.E.M. Ref</b> 8558527 42487165 93194626</p>	 <p><b>Models</b> OM 50 - 50.xx - 60.xx - 65.xx - 70.xx - 79.xx - 80.xx 83.xx - 90.xx</p>	<p><b>A 24x1,5 Destro / Right</b> <i>Misure / Size</i></p> <p><b>B</b> 70 <b>C</b> 95 <b>D</b> 22 <b>E</b> 19,9 <b>F</b> 18x1,5 <b>Conicita'</b> 1:10</p>
<p><b>CEI no.</b> <b>198.476</b></p> <p><b>O.E.M. Ref</b> 8558524 2966396 7984276 93194627</p>	 <p><b>Models</b> OM 50 - 50.xx - 60.xx - 65.xx - 70.xx - 79.xx - 80.xx 83.xx - 90.xx</p>	<p><b>A 24x1,5 Sinistro / Left</b> <i>Misure / Size</i></p> <p><b>B</b> 70 <b>C</b> 95 <b>D</b> 22 <b>E</b> 19,9 <b>F</b> 18x1,5 <b>Conicita'</b> 1:10</p>

All original equipment manufacturers' numbers, symbols, pictures, models and description used in this catalogue are for reference only, and it is not implied that any part listed is the product of these manufacturers. Tutti i nostri particolari non sono originali ma con essi intercambiabili. I riferimenti originali, le figure, i modelli sono esposti a semplice titolo indicativo. La nostra produzione riporta il nostro marchio.



All original equipment manufacturer's numbers, symbols, pictures, models and description used in this catalogue are for reference only, and it is not implied that any part listed is the product of these manufactures. Tutti i nostri particolari non sono originali ma con essi intercambiabili. I riferimenti originali, le figure, i modelli sono esposti a semplice titolo indicativo. La nostra produzione riporta il nostro marchio.

<p><b>CEI no.</b> <b>221.022</b></p> <p>O.E.M. Ref 42491937 42480024</p>	 <p><b>Models</b> 75.9 - 80.9</p>	<p><b>A 24x1,5 Destro / Right</b> <i>Misure / Size</i></p> <p><b>B</b> 80 <b>C</b> 86 <b>D</b> 20 <b>E</b> 18,1 <b>F</b> 16x1,5 <b>Conicita'</b> 1:10</p>
<p><b>CEI no.</b> <b>221.021</b></p> <p>O.E.M. Ref 8193649 42480023</p>	 <p><b>Models</b> 75.9 - 80.9</p>	<p><b>A 24x1,5 Sinistro / Left</b> <i>Misure / Size</i></p> <p><b>B</b> 80 <b>C</b> 86 <b>D</b> 20 <b>E</b> 18,1 <b>F</b> 16x1,5 <b>Conicita'</b> 1:10</p>
<p><b>CEI no.</b> <b>198.496</b></p> <p>O.E.M. Ref 4663787 4018036</p>	 <p><b>Models</b> Lupetto - Leoncino - Tigrotto - Daino - Cerbiatto OM 100 - 110 NC - 645 - 650 - 655 - 662 - Bus 314</p>	<p><b>A 25x1,5 Destro / Right</b> <i>Misure / Size</i></p> <p><b>B</b> 70 <b>C</b> 100 <b>D</b> 22,4 <b>E</b> 19,5 <b>F</b> 16x1,5 <b>Conicita'</b> 1:8</p>
<p><b>CEI no.</b> <b>198.497</b></p> <p>O.E.M. Ref 4663791 4018037</p>	 <p><b>Models</b> Lupetto - Leoncino - Tigrotto - Daino - Cerbiatto OM 100 - 110 NC - 645 - 650 - 655 - 662 - Bus 314</p>	<p><b>A 25x1,5 Sinistro / Left</b> <i>Misure / Size</i></p> <p><b>B</b> 70 <b>C</b> 100 <b>D</b> 22,4 <b>E</b> 19,5 <b>F</b> 16x1,5 <b>Conicita'</b> 1:8</p>
<p><b>CEI no.</b> <b>198.480</b></p> <p>O.E.M. Ref 4663972 4028250</p>	 <p><b>Models</b> 110NC - 130NC - 643 N/N1 - 673 N</p>	<p><b>A 28x1,5 Destro / Right</b> <i>Misure / Size</i></p> <p><b>B</b> 80 <b>C</b> 116 <b>D</b> 28,1 <b>E</b> 24,7 <b>F</b> 22x1,5 <b>Conicita'</b> 1:8</p>
<p><b>CEI no.</b> <b>198.481</b></p> <p>O.E.M. Ref 4663974</p>	 <p><b>Models</b> 110NC - 130NC - 643 N/N1 - 673 N</p>	<p><b>A 28x1,5 Sinistro / Left</b> <i>Misure / Size</i></p> <p><b>B</b> 80 <b>C</b> 116 <b>D</b> 28,1 <b>E</b> 24,7 <b>F</b> 22x1,5 <b>Conicita'</b> 1:8</p>



**CEI no.**  
**198.477**

O.E.M. Ref  
4833825  
8193645  
8558533  
8582322



**Models**  
OM 65÷80 - 50.xx - 60.xx - 79.xx - 80.xx - 90.xx  
109.xx - 160.xx - 190.xx

<b>A</b>	<b>28x1,5</b>	Destro / Right
<i>Misure / Size</i>		
<b>B</b>		70
<b>C</b>		95
<b>D</b>		22
<b>E</b>		19,9
<b>F</b>		18x1,5
<b>Conicita'</b>		1:10

**CEI no.**  
**198.478**

O.E.M. Ref  
4833826  
8123394  
8193646  
8558536



**Models**  
OM 65÷80 - 50.xx - 60.xx - 79.xx - 80.xx - 90.xx  
109.xx - 160.xx - 190.xx

<b>A</b>	<b>28x1,5</b>	Sinistro / Left
<i>Misure / Size</i>		
<b>B</b>		70
<b>C</b>		95
<b>D</b>		22
<b>E</b>		19,9
<b>F</b>		18x1,5
<b>Conicita'</b>		1:10

**CEI no.**  
**198.602**

O.E.M. Ref  
4688941  
8121641  
8582332  
7167757



**Models**  
OM 65 ÷ 80 - 50.xx - 60.xx - 79.xx - 80.xx - 90.xx  
109.xx - 115.xx - 135.xx - 140.xx - 150.xx - 693N/N1

<b>A</b>	<b>28x1,5</b>	Destro / Right
<i>Misure / Size</i>		
<b>B</b>		80
<b>C</b>		106,5
<b>D</b>		26
<b>E</b>		23,5
<b>F</b>		20x1,5
<b>Conicita'</b>		1:10

**CEI no.**  
**198.603**

O.E.M. Ref  
4688942  
8123326  
8582333



**Models**  
OM 65 ÷ 80 - 50.xx - 60.xx - 79.xx - 80.xx - 90.xx  
109.xx - 115.xx - 135.xx - 140.xx - 150.xx - 693N/N1

<b>A</b>	<b>28x1,5</b>	Sinistro / Left
<i>Misure / Size</i>		
<b>B</b>		80
<b>C</b>		106,5
<b>D</b>		26
<b>E</b>		23,5
<b>F</b>		20x1,5
<b>Conicita'</b>		1:10

**CEI no.**  
**198.630**

O.E.M. Ref  
42493781  
8122754  
2980323  
42483520



**Models**  
50.xx - 60.xx - 65.xx. - 70.xx - 75.xx - 79.xx - 90.xx  
110.13A - 130.13-16A/AN/ANW - 160.17A/AN/ANW

<b>A</b>	<b>30x1,5</b>	Destro / Right
<i>Misure / Size</i>		
<b>B</b>		80
<b>C</b>		106,5
<b>D</b>		26
<b>E</b>		23,5
<b>F</b>		20x1,5
<b>Conicita'</b>		1:10

**CEI no.**  
**198.629**

O.E.M. Ref  
42493782  
8122755  
2966272  
2980129







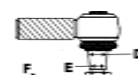
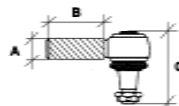

**Models**  
50.xx - 60.xx - 65.xx. - 70.xx - 75.xx - 79.xx - 90.xx  
110.13A - 130.13-16A/AN/ANW - 160.17A/AN/ANW

<b>A</b>	<b>30x1,5</b>	Sinistro / Left
<i>Misure / Size</i>		
<b>B</b>		80
<b>C</b>		106,5
<b>D</b>		26
<b>E</b>		23,5
<b>F</b>		20x1,5
<b>Conicita'</b>		1:10



All original equipment manufacturers' numbers, symbols, pictures, models and description used in this catalogue are for reference only, and it is not implied that any part listed is the product of these manufacturers. Tutti i nostri particolari non sono originali ma con essi intercambiabili. I riferimenti sono esposti a semplice titolo indicativo. La nostra produzione riporta il nostro marchio.

<p><b>CEI no.</b> <b>198.598</b></p> <p><b>O.E.M. Ref</b> 4833827 4833820 2966688 42485718</p>	 <p><b>Models</b> EuroCargo - EuroFire - Tector EuroPolis</p>	<p><b>A</b>    <b>30x1,5</b>    Destro / Right <i>Misure / Size</i></p> <p><b>B</b>                    74 <b>C</b>                    105 <b>D</b>                    26 <b>E</b>                    23,5 <b>F</b>                    20x1,5 <b>Conicita'</b>            1:10</p>
<p><b>CEI no.</b> <b>198.599</b></p> <p><b>O.E.M. Ref</b> 4833828 4833821 2984511</p>	 <p><b>Models</b> EuroCargo - EuroFire - Tector EuroPolis</p>	<p><b>A</b>    <b>30x1,5</b>    Sinistro / Left <i>Misure / Size</i></p> <p><b>B</b>                    74 <b>C</b>                    105 <b>D</b>                    26 <b>E</b>                    23,5 <b>F</b>                    20x1,5 <b>Conicita'</b>            1:10</p>
<p><b>CEI no.</b> <b>198.525</b></p> <p><b>O.E.M. Ref</b> 4802443 4833822 4833829 8122752</p>	 <p><b>Models</b> 180.xx-190.xx-220.xx-240.xx-260.xx- 300.xx-330.xx TurboTech/Star - EuroCargo / Tech / Star / Trakker</p>	<p><b>A</b>    <b>30x1,5</b>    Destro / Right <i>Misure / Size</i></p> <p><b>B</b>                    86 <b>C</b>                    117 <b>D</b>                    30 <b>E</b>                    27,1 <b>F</b>                    24x1,5 <b>Conicita'</b>            1:10</p>
<p><b>CEI no.</b> <b>198.524</b></p> <p><b>O.E.M. Ref</b> 4802444 4833830 2968584 8190225</p>	 <p><b>Models</b> 180.xx-190.xx-220.xx-240.xx-260.xx- 300.xx-330.xx TurboTech/Star - EuroCargo / Tech / Star / Trakker</p>	<p><b>A</b>    <b>30x1,5</b>    Sinistro / Left <i>Misure / Size</i></p> <p><b>B</b>                    86 <b>C</b>                    117 <b>D</b>                    30 <b>E</b>                    27,1 <b>F</b>                    24x1,5 <b>Conicita'</b>            1:10</p>
<p><b>CEI no.</b> <b>198.492</b></p> <p><b>O.E.M. Ref</b> 42483386 42488269</p>	 <p><b>Models</b> 160.xx-170.xx-175.xx-190.xx-220.xx-260.xx-300.xx 330.xx - TurboTech/Star - EuroTech/Star/Trakker</p>	<p><b>A</b>    <b>30x1,5</b>    Destro / Right <i>Misure / Size</i></p> <p><b>B</b>                    77 <b>C</b>                    117 <b>D</b>                    30 <b>E</b>                    27,1 <b>F</b>                    24x1,5 <b>Conicita'</b>            1:10</p>
<p><b>CEI no.</b> <b>198.493</b></p> <p><b>O.E.M. Ref</b> 42489395 42491957</p>	 <p><b>Models</b> 160.xx-170.xx-175.xx-190.xx-220.xx-260.xx-300.xx 330.xx-TurboTech / Star - EuroTech / Star / Trakker</p>	<p><b>A</b>    <b>30x1,5</b>    Sinistro / Left <i>Misure / Size</i></p> <p><b>B</b>                    77 <b>C</b>                    117 <b>D</b>                    30 <b>E</b>                    27,1 <b>F</b>                    24x1,5 <b>Conicita'</b>            1:10</p>

CEI no.  
**221.055**

O.E.M. Ref  
500309296



**Models**  
EuroTech - EuroStar - STRALIS

<b>A</b>	<b>30x1,5</b>	Destro / Right
<i>Misure / Size</i>		
<b>B</b>		86
<b>C</b>		117
<b>D</b>		30
<b>E</b>		27,1
<b>F</b>		24x1,5
<b>Conicita'</b>		1:10

CEI no.  
198.498

O.E.M. Ref  
4664292  
4510019



**Models**  
160NC - 180NC - 300 PC/PT - 619N/NP - 682 N2/N3  
684 N/NP - 690 N1/N2/N3/N4 - 692 N - 697 N/NP

<b>A</b>	<b>38x1,5</b>	Destro / Right
<i>Misure / Size</i>		
<b>B</b>		95
<b>C</b>		132
<b>D</b>		31,8
<b>E</b>		27
<b>F</b>		22x1,5
<b>Conicita'</b>		1:8

CEI no.  
**198.499**

O.E.M. Ref  
4664295  
4523292



**Models**  
160NC - 180NC - 300 PC/PT - 619N/NP - 682 N2/N3  
684 N/NP - 690 N1/N2/N3/N4 - 692 N - 697 N/NP

<b>A</b>	<b>38x1,5</b>	Sinistro / Left
<i>Misure / Size</i>		
<b>B</b>		95
<b>C</b>		132
<b>D</b>		31,8
<b>E</b>		27
<b>F</b>		22x1,5
<b>Conicita'</b>		1:8

CEI no.  
**198.485**

O.E.M. Ref  
4688948



**Models**  
170NC - 190NC - 160.xx - 165.xx - 175.xx - 180.xx  
190.xx-240.xx-260.xx-TurboTech / Star - Bus 370.xx

<b>A</b>	<b>38x1,5</b>	Destro / Right
<i>Misure / Size</i>		
<b>B</b>		83
<b>C</b>		118
<b>D</b>		30
<b>E</b>		27,1
<b>F</b>		24x1,5
<b>Conicita'</b>		1:10

CEI no.  
**198.486**

O.E.M. Ref  
4688949



**Models**  
170NC - 190NC - 160.xx - 165.xx - 175.xx - 180.xx  
190.xx-240.xx-260.xx-TurboTech / Star - Bus 370.xx

<b>A</b>	<b>38x1,5</b>	Sinistro / Left
<i>Misure / Size</i>		
<b>B</b>		83
<b>C</b>		118
<b>D</b>		30
<b>E</b>		27,1
<b>F</b>		24x1,5
<b>Conicita'</b>		1:10

CEI no.  
198.650

O.E.M. Ref  
4664586  
4520697

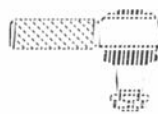





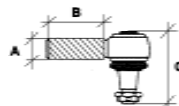

<<< NESSUNA IMMAGINE - NO PICTURE >>>

**Models**  
180NC - 690N1/N2/N3/N4 - 691N

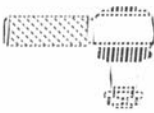





<b>A</b>	<b>38x1,5</b>	Destro / Right
<i>Misure / Size</i>		
<b>B</b>		93
<b>C</b>		102
<b>D</b>		32
<b>E</b>		28,5
<b>F</b>		24x1,5
<b>Conicita'</b>		

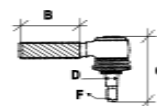
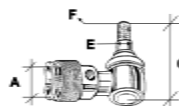
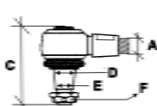

All original equipment manufacturer's numbers, symbols, pictures, models and description used in this catalogue are for reference only, and it is not implied that any part listed is the product of these manufacturers. Tutti i nostri particolari non sono originali ma con essi intercambiabili. I riferimenti sono esposti a semplice titolo indicativo. La nostra produzione riporta il nostro marchio.

<p><b>CEI no.</b> <b>221.003</b></p> <p><b>O.E.M. Ref</b> <b>4388159</b></p>	 <p style="text-align: center;">&lt;&lt;&lt; NESSUNA IMMAGINE - NO PICTURE &gt;&gt;&gt;</p> <p><b>Models</b> <b>Ducato - Talento 1a Serie / 1st Series</b> <i>Sospensioni Ant / Front Suspension</i></p>	<p><b>A</b>    <b>14x1,5</b>    Destro / Right <i>Misure / Size</i></p> <p><b>B</b></p> <p><b>C</b></p> <p><b>D</b></p> <p><b>E</b></p> <p><b>F</b></p> <p><b>Concità'</b>                    1:8</p>
<p><b>CEI no.</b> <b>221.004</b></p> <p><b>O.E.M. Ref</b> <b>7567284</b></p>	 <p><b>Models</b> <b>Ducato - Talento 2a Serie / 2nd Series</b> <i>Sospensioni Ant / Front Suspension</i></p>	<p><b>A</b>    <b>16x1,5</b>    Destro / Right <i>Misure / Size</i></p> <p><b>B</b>                                    76,5</p> <p><b>C</b></p> <p><b>D</b></p> <p><b>E</b></p> <p><b>F</b></p> <p><b>Concità'</b>                    1:8</p>
<p><b>CEI no.</b> <b>221.002</b></p> <p><b>O.E.M. Ref</b> <b>4336779</b></p>	 <p><b>Models</b> <b>Ducato - Talento (Dal / From 19885)</b> <i>Sterzo / Steering</i></p>	<p><b>A</b>    <b>16x1,5</b>    Destro / Right <i>Misure / Size</i></p> <p><b>B</b></p> <p><b>C</b>                                    66</p> <p><b>D</b>                                    16,8</p> <p><b>E</b></p> <p><b>F</b>                                    12x1,5</p> <p><b>Concità'</b>                    1:10</p>
<p><b>CEI no.</b> <b>198.472</b></p> <p><b>O.E.M. Ref</b> <b>1903652</b> <b>93800662</b> <b>93804059</b></p>	 <p><b>Models</b> <b>OM Grinta - Daily - New Daily</b> <i>Sterzo / Steering</i></p>	<p><b>A</b>    <b>16x1,5</b>    Destro / Right <i>Misure / Size</i></p> <p><b>B</b></p> <p><b>C</b>                                    68,5</p> <p><b>D</b>                                    18,3</p> <p><b>E</b></p> <p><b>F</b>                                    14x1,5</p> <p><b>Concità'</b>                    1:10</p>
<p><b>CEI no.</b> <b>221.074</b></p> <p><b>O.E.M. Ref</b> <b>42534911</b> <b>93827647</b></p>	 <p><b>Models</b> <b>Daily Serie "C" (35C9-35C13 etc.)</b> <i>Sterzo / Steering</i></p>	<p><b>A</b>    <b>16x1,5</b>    Destro / Right <i>Misure / Size</i></p> <p><b>B</b></p> <p><b>C</b>                                    91,3</p> <p><b>D</b>                                    18,2</p> <p><b>E</b></p> <p><b>F</b>                                    11x1,5</p> <p><b>Concità'</b>                    1:10</p>
<p><b>CEI no.</b> <b>198.473</b></p> <p><b>O.E.M. Ref</b> <b>500310933</b> <b>93804060</b> <b>93802209</b></p>	 <p><b>Models</b> <b>OM Grinta - Daily - New Daily - Daily Serie "C"</b> <i>Sospensioni Ant / Front Suspension</i></p>	<p><b>A</b>    <b>20x1,5</b>    Destro / Right <i>Misure / Size</i></p> <p><b>B</b></p> <p><b>C</b>                                    110</p> <p><b>D</b>                                    24,2</p> <p><b>E</b></p> <p><b>F</b>                                    18x1,5</p> <p><b>Concità'</b>                    1:10</p>



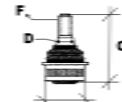
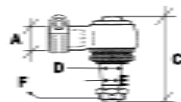
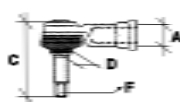

<p><b>CEI no.</b> <b>198.474</b></p> <p>O.E.M. Ref 93807545 93802242 93807320 93804061</p>	 <p><b>Models</b> OM Grinta - Daily - New Daily - Daily Serie "C" Sospensioni Ant / Front Suspension</p>	<p><b>A</b>    <b>20x1,5</b>    Destro / Right <i>Misure / Size</i></p> <p><b>B</b></p> <p><b>C</b>                    117</p> <p><b>D</b>                    24</p> <p><b>E</b></p> <p><b>F</b>                    18x1,5</p> <p><b>Concita'</b>            1:10</p>
<p><b>CEI no.</b> <b>221.020</b></p> <p>O.E.M. Ref 500337201 8580735</p>	 <p><b>Models</b> Daily - New Daily Sospensioni Ant / Front Suspension</p>	<p><b>A</b>    <b>20x1,5</b>    Destro / Right <i>Misure / Size</i></p> <p><b>B</b></p> <p><b>C</b>                    110,5</p> <p><b>D</b>                    24,2</p> <p><b>E</b>                    21,7</p> <p><b>F</b>                    18x1,5</p> <p><b>Concita'</b>            1:10</p>
<p><b>CEI no.</b> <b>198.636</b></p> <p>O.E.M. Ref 2463582 60115495</p>	 <p><b>Models</b> 75.xx-80.xx-120.xx-130.xx-160.xx A/AN/ANW Barra Stabilizzatrice Post. / Rear Stabilizer Bar</p>	<p><b>A</b>    <b>20x1,5</b>    Destro / Right <i>Misure / Size</i></p> <p><b>B</b></p> <p><b>C</b>                    106</p> <p><b>D</b>                    26</p> <p><b>E</b>                    23,5</p> <p><b>F</b>                    20x1,5</p> <p><b>Concita'</b></p>
<p><b>CEI no.</b> <b>198.637</b></p> <p>O.E.M. Ref 2460515</p>	 <p><b>Models</b> 160.xx-170.xx-190.xx-260.xx-300.xx-330.x AH/ANW Barra Stabilizzatrice Post. / Rear Stabilizer Bar</p>	<p><b>A</b>    <b>24x1,5</b>    Destro / Right <i>Misure / Size</i></p> <p><b>B</b></p> <p><b>C</b>                    116</p> <p><b>D</b>                    30</p> <p><b>E</b>                    27</p> <p><b>F</b>                    24x1,5</p> <p><b>Concita'</b></p>
<p><b>CEI no.</b> <b>198.482</b></p> <p>O.E.M. Ref 4665009</p>	 <p>&lt;&lt;&lt; NESSUNA IMMAGINE - NO PICTURE &gt;&gt;</p> <p><b>Models</b> 100-110-130 NC / 645-650-655-662-673 N/N1/N2/N3 Barra Stabilizzatrice Post. / Rear Stabilizer Bar</p>	<p><b>A</b>    <b>30x1,5</b>    Destro / Right <i>Misure / Size</i></p> <p><b>B</b></p> <p><b>C</b>                    98</p> <p><b>D</b>                    22,5</p> <p><b>E</b></p> <p><b>F</b>                    16x1,5</p> <p><b>Concita'</b></p>
<p><b>CEI no.</b> <b>198.491</b></p> <p>O.E.M. Ref 4664462 4582159</p>	 <p><b>Models</b> 160 NC - 300PC / 619-684-697 N/N1 Barra Stabilizzatrice Post. / Rear Stabilizer Bar</p>	<p><b>A</b>    <b>30x1,5</b>    Destro / Right <i>Misure / Size</i></p> <p><b>B</b></p> <p><b>C</b>                    123</p> <p><b>D</b>                    31,8</p> <p><b>E</b></p> <p><b>F</b>                    22x1,5</p> <p><b>Concita'</b></p>

All original equipment manufacturers numbers, symbols, pictures, models and description used in this catalogue are for reference only, and it is not implied that any part listed is the product of these manufacturers. Tutti i nostri particolari non sono originali ma con essi intercambiabili. I riferimenti originali, le figure, i modelli sono esposti a semplice titolo indicativo. La nostra produzione riporta il nostro marchio.



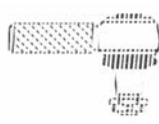
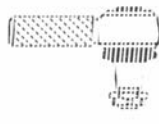
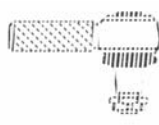

All original equipment manufacturer's numbers, symbols, pictures, models and description used in this catalogue are for reference only, and it is not implied that any part listed is the product of these manufactures. Tutti i nostri particolari non sono originali ma con essi intercambiabili. I riferimenti originali, le figure, i modelli sono esposti a semplice titolo indicativo. La nostra produzione riporta il nostro marchio.

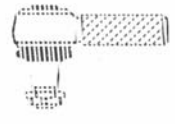
<p><b>CEI no.</b> 198.519</p> <p><b>O.E.M. Ref</b> 4688953</p>	 <p>&lt;&lt;&lt; NESSUNA IMMAGINE - NO PICTURE &gt;&gt;&gt;</p> <p><b>Models</b> 170 NC - 190 NC Barra Stabilizzatrice Post. / Rear Stabilizer Bar</p>	<p><b>A</b>    <b>30x1,5</b>    Destro / Right Misure / Size</p> <p><b>B</b></p> <p><b>C</b>                    117</p> <p><b>D</b></p> <p><b>E</b></p> <p><b>F</b>                    24x1,5</p> <p><b>Concitta'</b></p>
<p><b>CEI no.</b> 198.554</p> <p><b>O.E.M. Ref</b> 4688946</p>	 <p>&lt;&lt;&lt; NESSUNA IMMAGINE - NO PICTURE &gt;&gt;&gt;</p> <p><b>Models</b> 110 NC - 130 NC - 150 NC Servosterzo / Power-Steering</p>	<p><b>A</b>    <b>30x1,5</b>    Destro / Right Misure / Size</p> <p><b>B</b></p> <p><b>C</b>                    105</p> <p><b>D</b></p> <p><b>E</b></p> <p><b>F</b>                    20x1,5</p> <p><b>Concitta'</b></p>
<p><b>CEI no.</b> 198.490</p> <p><b>O.E.M. Ref</b> 4664349 4510017</p>	 <p>&lt;&lt;&lt; NESSUNA IMMAGINE - NO PICTURE &gt;&gt;&gt;</p> <p><b>Models</b> 180 NC / 682-690-691 N/N1/N2/N3 Avantreno / Front Axle</p>	<p><b>A</b>    <b>45x1,5</b>    Destro / Right Misure / Size</p> <p><b>B</b></p> <p><b>C</b>                    127</p> <p><b>D</b>                    31,75</p> <p><b>E</b>                    27,5</p> <p><b>F</b>                    22x1,5</p> <p><b>Concitta'</b>                    1:8</p>
<p><b>CEI no.</b> <b>198.489</b></p> <p><b>O.E.M. Ref</b> 4664347 4510018</p>	 <p><b>Models</b> 180 NC / 682-690-691 N/N1/N2/N3 Avantreno / Front Axle</p>	<p><b>A</b>    <b>45x1,5</b>    Sinistro / Left Misure / Size</p> <p><b>B</b></p> <p><b>C</b>                    127</p> <p><b>D</b>                    31,75</p> <p><b>E</b>                    27,5</p> <p><b>F</b>                    22x1,5</p> <p><b>Concitta'</b>                    1:8</p>
<p><b>CEI no.</b> 198.483</p> <p><b>O.E.M. Ref</b> 4732041 4664353 4514235</p>	 <p><b>Models</b> 160 NC - 300 PC / 619-684-697 N/N1/N2/N3 Avantreno / Front Axle</p>	<p><b>A</b>    <b>52x1,5</b>    Destro / Right Misure / Size</p> <p><b>B</b></p> <p><b>C</b>                    130</p> <p><b>D</b>                    32,35</p> <p><b>E</b></p> <p><b>F</b>                    22x1,5</p> <p><b>Concitta'</b>                    1:8</p>
<p><b>CEI no.</b> 198.484</p> <p><b>O.E.M. Ref</b> 4732042 4664351 4514236</p>	 <p>&lt;&lt;&lt; NESSUNA IMMAGINE - NO PICTURE &gt;&gt;&gt;</p> <p><b>Models</b> 160 NC - 300 PC / 619-684-697 N/N1/N2/N3 Avantreno / Front Axle</p>	<p><b>A</b>    <b>52x1,5</b>    Sinistro / Left Misure / Size</p> <p><b>B</b></p> <p><b>C</b>                    130</p> <p><b>D</b>                    32,35</p> <p><b>E</b></p> <p><b>F</b>                    22x1,5</p> <p><b>Concitta'</b>                    1:8</p>

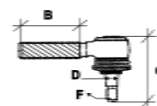
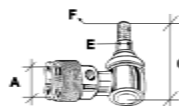
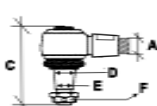



CEI no.  
**198.479**

O.E.M. Ref  
4665005



**Models**  
100 NC - 130NC - 645/650/662/973 N1/N2/N3  
Servosterzo / Power-Steering

<b>A</b>	<b>64x1,5</b>	Destro / Right
		<i>Misure / Size</i>
	<b>B</b>	
	<b>C</b>	100
	<b>D</b>	
	<b>E</b>	19,5
	<b>F</b>	16x1,5
	<b>Conicita'</b>	

CEI no.  
198.604

O.E.M. Ref  
4665007

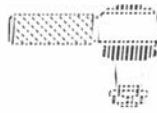

<<< NESSUNA IMMAGINE - NO PICTURE >>>

**Models**  
100 NC - 130NC - 645/650/662/973 N1/N2/N3  
Servosterzo / Power-Steering

<b>A</b>	<b>64x1,5</b>	Destro / Right
		<i>Misure / Size</i>
	<b>B</b>	
	<b>C</b>	98
	<b>D</b>	
	<b>E</b>	19,5
	<b>F</b>	16x1,5
	<b>Conicita'</b>	

CEI no.  
**198.553**

O.E.M. Ref  
4688944



**Models**  
100 NC-130NC-150NC (Con Cabina Rib./With Tilting Cab)  
Servosterzo / Power-Steering

<b>A</b>	<b>64x1,5</b>	Destro / Right
		<i>Misure / Size</i>
	<b>B</b>	
	<b>C</b>	108
	<b>D</b>	
	<b>E</b>	23,5
	<b>F</b>	20x1,5
	<b>Conicita'</b>	

CEI no.  
**198.605**

O.E.M. Ref  
4664345  
4562450



**Models**  
160 NC - 300 PC - 619N1 - 684N1 - 697N1  
Servosterzo / Power-Steering

<b>A</b>	<b>64x1,5</b>	Destro / Right
		<i>Misure / Size</i>
	<b>B</b>	
	<b>C</b>	125
	<b>D</b>	
	<b>E</b>	27,5
	<b>F</b>	22x1,5
	<b>Conicita'</b>	

CEI no.  
198.488

O.E.M. Ref  
4664343  
4544893



<<< NESSUNA IMMAGINE - NO PICTURE >>>

**Models**  
160 NC - 300 PC - 619N1 - 684N1 - 697N1  
Servosterzo / Power-Steering

<b>A</b>	<b>64x1,5</b>	Destro / Right
		<i>Misure / Size</i>
	<b>B</b>	
	<b>C</b>	123
	<b>D</b>	
	<b>E</b>	27,5
	<b>F</b>	22x1,5
	<b>Conicita'</b>	

CEI no.  
198.520

O.E.M. Ref  
4688952



**Models**  
170 NC  
Servosterzo / Power-Steering

<b>A</b>	<b>64x1,5</b>	Destro / Right
		<i>Misure / Size</i>
	<b>B</b>	
	<b>C</b>	117
	<b>D</b>	
	<b>E</b>	27
	<b>F</b>	24x1,5
	<b>Conicita'</b>	

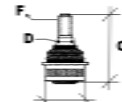
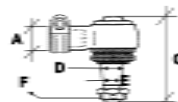
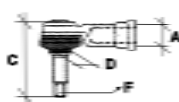

**CEI no.**  
**198.487**

**O.E.M. Ref**  
4668368  
4536229



<<< NESSUNA IMMAGINE - NO PICTURE >>

**Models**  
**180 NC - 690 N1/N2 - 691 N1/N2**  
*Servosterzo - Anteriore / Power-Steering - Front*

<b>A</b>	--	<b>Destro / Right</b>
		<i>Misure / Size</i>
	<b>B</b>	
	<b>C</b>	105
	<b>D</b>	32
	<b>E</b>	28,5
	<b>F</b>	24x1,5
	<b>Conicita'</b>	

**CEI no.**  
**221.056**

**O.E.M. Ref**  
500340769



<<< NESSUNA IMMAGINE - NO PICTURE >>

**Models**  
**CityClass491.22 - 491.22CNG - 491.27 - 491.27CNG**  
**591.22 - 591.22CNG - 591.24CNG - 591.27 - 591.27CNG**

<b>A</b>		<b>Destro / Right</b>
		<i>Misure / Size</i>
	<b>B</b>	
	<b>C</b>	
	<b>D</b>	
	<b>E</b>	
	<b>F</b>	
	<b>Conicita'</b>	

All original equipment manufacturer's numbers, symbols, pictures, models and description used in this catalogue are for reference only, and it is not implied that any part listed is the product of these manufactures. Tutti i nostri particolari non sono originali ma con essi intercambiabili. I riferimenti originali, le figure, i modelli sono esposti a semplice titolo indicativo. La nostra produzione riporta il nostro marchio.

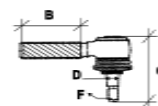
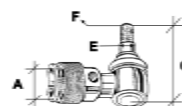
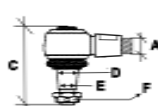

CEI no.  
**198.525**

O.E.M. Ref  
113254  
101694  
116740  
120239



**Models**  
BM64.26 - BM64.30 - BM64.36  
BM304F - BM305F

<b>A</b>	<b>30x1,5</b>	<b>Destro / Right</b>
		<i>Misure / Size</i>
<b>B</b>		86
<b>C</b>		117
<b>D</b>		30
<b>E</b>		27,1
<b>F</b>		24x1,5
<b>Conicita'</b>		1:10

CEI no.  
**198.524**

O.E.M. Ref  
113253  
101695



**Models**  
BM64.26 - BM64.30 - BM64.36  
BM304F - BM305F

<b>A</b>	<b>30x1,5</b>	<b>Sinistro / Left</b>
		<i>Misure / Size</i>
<b>B</b>		86
<b>C</b>		117
<b>D</b>		30
<b>E</b>		27,1
<b>F</b>		24x1,5
<b>Conicita'</b>		1:10

CEI no.  
**221.007**

O.E.M. Ref  
113251  
101347



**Models**  
BM64.26 - BM64.30 - BM64.36

<b>A</b>	<b>38x1,5</b>	<b>Destro / Right</b>
		<i>Misure / Size</i>
<b>B</b>		87
<b>C</b>		141
<b>D</b>		38
<b>E</b>		34,3
<b>F</b>		30x1,5
<b>Conicita'</b>		1:10

CEI no.  
**221.008**

O.E.M. Ref  
113252  
101348



**Models**  
BM64.26 - BM64.30 - BM64.36

<b>A</b>	<b>38x1,5</b>	<b>Sinistro / Left</b>
		<i>Misure / Size</i>
<b>B</b>		87
<b>C</b>		141
<b>D</b>		38
<b>E</b>		34,3
<b>F</b>		30x1,5
<b>Conicita'</b>		1:10

All original equipment manufacturers' numbers, symbols, pictures, models and description used in this catalogue are for reference only, and it is not implied that any part listed is the product of these manufacturers. Tutti i nostri particolari non sono originali ma con essi intercambiabili. I riferimenti originali, le figure, i modelli sono esposti a semplice titolo indicativo. La nostra produzione riporta il nostro marchio.

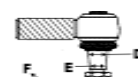
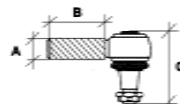

CEI no.  
**198.525**

O.E.M. Ref  
189716  
004206  
5004206



**Models**  
BredaMenarini / Inbus / Sicca : 201L

**A 30x1,5 Destro / Right**  
*Misure / Size*  
B 86  
C 117  
D 30  
E 27,1  
F 24x1,5  
**Conicita'** 1:10

CEI no.  
**198.524**

O.E.M. Ref  
5004204  
189717  
004204



**Models**  
BredaMenarini / Inbus / Sicca : 201L

**A 30x1,5 Sinistro / Left**  
*Misure / Size*  
B 86  
C 117  
D 30  
E 27,1  
F 24x1,5  
**Conicita'** 1:10

CEI no.

O.E.M. Ref  
000978



<<< NESSUNA IMMAGINE - NO PICTURE >>>

**Models**  
BredaMenarini / Inbus / Sicca : 330

**A 38x1,5 Destro / Right**  
*Misure / Size*  
B  
C  
D  
E  
F  
**Conicita'**

CEI no.

O.E.M. Ref  
000977  
000192



<<< NESSUNA IMMAGINE - NO PICTURE >>>

**Models**  
BredaMenarini / Inbus / Sicca : 330

**A 38x1,5 Sinistro / Left**  
*Misure / Size*  
B  
C  
D  
E  
F  
**Conicita'**

CEI no.

O.E.M. Ref  
000979  
5005120



<<< NESSUNA IMMAGINE - NO PICTURE >>>

**Models**  
BredaMenarini / Inbus / Sicca : 177

**A 45x1,5 Destro / Right**  
*Misure / Size*  
B  
C  
D  
E  
F  
**Conicita'**

CEI no.

O.E.M. Ref  
000980



<<< NESSUNA IMMAGINE - NO PICTURE >>>

**Models**  
BredaMenarini / Inbus / Sicca : 177

**A 45x1,5 Sinistro / Left**  
*Misure / Size*  
B  
C  
D  
E  
F  
**Conicita'**

All original equipment manufacturers' numbers, symbols, pictures, models and description used in this catalogue are for reference only, and it is not implied that any part listed is the product of these manufactures. Tutti i nostri particolari non sono originali ma con essi intercambiabili. I riferimenti originali, le figure, i modelli sono esposti a semplice titolo indicativo. La nostra produzione riporta il nostro marchio.

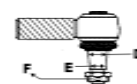
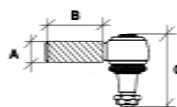

**CEI no.**  
**198.477**

O.E.M. Ref  
607451  
607453  
1228114  
1373135



**Models**  
From F1000 To F1900

<b>A</b>	<b>28x1,5</b>	<b>Destro / Right</b>
	<i>Misure / Size</i>	
<b>B</b>		70
<b>C</b>		95
<b>D</b>		22
<b>E</b>		19,9
<b>F</b>		18x1,5
<b>Conicita'</b>		1:10

**CEI no.**  
**198.478**

O.E.M. Ref  
607452  
110196  
1373137



**Models**  
From F1000 To F1900

<b>A</b>	<b>28x1,5</b>	<b>Sinistro / Left</b>
	<i>Misure / Size</i>	
<b>B</b>		70
<b>C</b>		95
<b>D</b>		22
<b>E</b>		19,9
<b>F</b>		18x1,5
<b>Conicita'</b>		1:10

**CEI no.**  
**198.525**

O.E.M. Ref  
1257890  
607981  
698450  
1149907



**Models**  
From F1000 To F2200  
F95 - XF95

<b>A</b>	<b>30x1,5</b>	<b>Destro / Right</b>
	<i>Misure / Size</i>	
<b>B</b>		86
<b>C</b>		117
<b>D</b>		30
<b>E</b>		27,1
<b>F</b>		24x1,5
<b>Conicita'</b>		1:10

**CEI no.**  
**198.524**

O.E.M. Ref  
696225  
696205  
607053  
1228115



**Models**  
From F1000 To F2200  
F95 - XF95

<b>A</b>	<b>30x1,5</b>	<b>Sinistro / Left</b>
	<i>Misure / Size</i>	
<b>B</b>		86
<b>C</b>		117
<b>D</b>		30
<b>E</b>		27,1
<b>F</b>		24x1,5
<b>Conicita'</b>		1:10

**CEI no.**  
**198.630**

O.E.M. Ref  
1331925  
698609  
1326896  
1229944



**Models**  
From F1000 To F2200  
From F65 to XF95

<b>A</b>	<b>30x1,5</b>	<b>Destro / Right</b>
	<i>Misure / Size</i>	
<b>B</b>		80
<b>C</b>		106,5
<b>D</b>		26
<b>E</b>		23,5
<b>F</b>		20x1,5
<b>Conicita'</b>		1:10

**CEI no.**  
**198.629**

O.E.M. Ref  
607998  
1315447  
1319838  
1338714





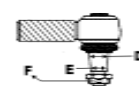
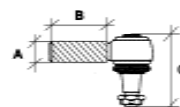

**Models**  
From F1000 To F2200  
From F65 to XF95



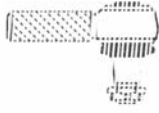



<b>A</b>	<b>30x1,5</b>	<b>Sinistro / Left</b>
	<i>Misure / Size</i>	
<b>B</b>		80
<b>C</b>		106,5
<b>D</b>		26
<b>E</b>		23,5
<b>F</b>		20x1,5
<b>Conicita'</b>		1:10



All original equipment manufacturers' numbers, symbols, pictures, models and description used in this catalogue are for reference only, and it is not implied that any part listed is the product of these manufactures. Tutti i nostri particolari non sono originali ma con essi intercambiabili. I riferimenti originali, le figure, i modelli sono esposti a semplice titolo indicativo. La nostra produzione riporta il nostro marchio.

<p><b>CEI no.</b> 221.082</p> <p><b>O.E.M. Ref</b> 1401942</p>	 <p><b>Models</b> LF45</p>	<p><b>A</b> <b>30x1,5</b> Destro / Right <i>Misure / Size</i></p> <p><b>B</b></p> <p><b>C</b> 107</p> <p><b>D</b> 22</p> <p><b>E</b></p> <p><b>F</b> 18x1,5</p> <p><b>Conicita'</b></p>
<p><b>CEI no.</b> 221.083</p> <p><b>O.E.M. Ref</b> 1407394 1401934</p>	 <p>&lt;&lt;&lt; NESSUNA IMMAGINE - NO PICTURE &gt;&gt;&gt;</p> <p><b>Models</b> LF55</p>	<p><b>A</b> <b>30x1,5</b> Destro / Right <i>Misure / Size</i></p> <p><b>B</b></p> <p><b>C</b> 127</p> <p><b>D</b> 26</p> <p><b>E</b></p> <p><b>F</b></p> <p><b>Conicita'</b></p>
<p><b>CEI no.</b> 221.087</p> <p><b>O.E.M. Ref</b> 1458874</p>	 <p><b>Models</b> 65CF-CF65-75CF-CF75-85CF-CF85</p>	<p><b>A</b> <b>30x1,5</b> Destro / Right <i>Misure / Size</i></p> <p><b>B</b></p> <p><b>C</b></p> <p><b>D</b></p> <p><b>E</b></p> <p><b>F</b></p> <p><b>Conicita'</b></p>
<p><b>CEI no.</b> 221.088</p> <p><b>O.E.M. Ref</b> 1638472</p>	 <p><b>Models</b> 65CF-CF65-75CF-CF75-85CF-CF85</p>	<p><b>A</b> <b>30x1,5</b> Destro / Right <i>Misure / Size</i></p> <p><b>B</b></p> <p><b>C</b></p> <p><b>D</b></p> <p><b>E</b></p> <p><b>F</b></p> <p><b>Conicita'</b></p>
<p><b>CEI no.</b> 221.084</p> <p><b>O.E.M. Ref</b> 1389190</p>	 <p><b>Models</b> 75CF-CF75-85CF-CF85-F95-95XF-XF95-XF105</p>	<p><b>A</b> <b>30x1,5</b> Destro / Right <i>Misure / Size</i></p> <p><b>B</b></p> <p><b>C</b> 141</p> <p><b>D</b> 26</p> <p><b>E</b></p> <p><b>F</b></p> <p><b>Conicita'</b></p>
<p><b>CEI no.</b> 221.019</p> <p><b>O.E.M. Ref</b> 1326861 696226 609643 1228110</p>	 <p><b>Models</b> From F2100 To F3600 From F65 to XF95</p>	<p><b>A</b> <b>30x1,5</b> Destro / Right <i>Misure / Size</i></p> <p><b>B</b> 86</p> <p><b>C</b> 131,5</p> <p><b>D</b> 30</p> <p><b>E</b> 27,1</p> <p><b>F</b> 24x1,5</p> <p><b>Conicita'</b> 1:10</p>



<p>CEI no. <b>221.018</b> O.E.M. Ref 606923</p>	  <p><i>Models</i> From F1600 To F3600</p>	<p><b>A 46x1,5 Destro / Right</b> <i>Misure / Size</i> B C 117,5 D 30 E 27,1 F 24x1,5 <b>Conicita' 1:10</b></p>
<p>CEI no. <b>221.017</b> O.E.M. Ref 606922</p>	  <p><i>Models</i> From F1600 To F3600</p>	<p><b>A 46x1,5 Sinistro / Left</b> <i>Misure / Size</i> B C 117,5 D 30 E 27,1 F 24x1,5 <b>Conicita' 1:10</b></p>
<p>CEI no. <b>221.006</b> O.E.M. Ref 0067389</p>	  <p><i>Models</i> From F65 to XF95</p>	<p><b>A 48x1,5 Destro / Right</b> <i>Misure / Size</i> B C 117,5 D 30 E 27,1 F 24x1,5 <b>Conicita' 1:10</b></p>
<p>CEI no. <b>221.005</b> O.E.M. Ref 0067303</p>	  <p><i>Models</i> From F65 to XF95</p>	<p><b>A 48x1,5 Sinistro / Left</b> <i>Misure / Size</i> B C 117,5 D 30 E 27,1 F 24x1,5 <b>Conicita' 1:10</b></p>
<p>CEI no. <b>221.029</b> O.E.M. Ref 1205215</p>	  <p><i>Models</i> F75 - CF75 - F85 - CF85</p>	<p><b>A 52x1,5 Destro / Right</b> <i>Misure / Size</i> B C 117,5 D 30 E 27,1 F 24x1,5 <b>Conicita' 1:10</b></p>
<p>CEI no. <b>221.030</b> O.E.M. Ref 1205248</p>	  <p><i>Models</i> F75 - CF75 - F85 - CF85</p>	<p><b>A 52x1,5 Sinistro / Left</b> <i>Misure / Size</i> B C 117,5 D 30 E 27,1 F 24x1,5 <b>Conicita' 1:10</b></p>

All original equipment manufacturers' numbers, symbols, pictures, models and description used in this catalogue are for reference only, and it is not implied that any part listed is the product of these manufacturers. Tutti i nostri particolari non sono originali ma con essi intercambiabili. I riferimenti originali, le figure, i modelli sono esposti a semplice titolo indicativo. La nostra produzione riporta il nostro marchio.

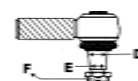
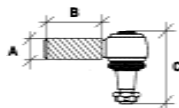

All original equipment manufacturer's numbers, symbols, pictures, models and description used in this catalogue are for reference only, and it is not implied that any part listed is the product of these manufactures. Tutti i nostri particolari non sono originali ma con essi intercambiabili. I riferimenti originali, le figure, i modelli sono esposti a semplice titolo indicativo. La nostra produzione riporta il nostro marchio.

<p><b>CEI no.</b> <b>198.475</b></p> <p><b>O.E.M. Ref</b> 000 330 9935 000 330 9735 000 330 7535 000 330 1235</p>		<p><b>A</b>    <b>24x1,5</b>    Destro / Right <i>Misure / Size</i></p> <p><b>B</b>                    70</p> <p><b>C</b>                    95</p> <p><b>D</b>                    22</p> <p><b>E</b>                    19,9</p> <p><b>F</b>                    18x1,5</p> <p><b>Conicita'</b>            1:10</p>
<p><b>Models</b> TRANSPORTER Series (507-508-609-610 etc.. / CH 309.xxx-310.xxx ect..)</p>		







<p><b>CEI no.</b> <b>198.476</b></p> <p><b>O.E.M. Ref</b> 000 330 9835 000 330 7635 001 330 0035 000 330 1335</p>		<p><b>A</b>    <b>24x1,5</b>    Sinistro / Left <i>Misure / Size</i></p> <p><b>B</b>                    70</p> <p><b>C</b>                    95</p> <p><b>D</b>                    22</p> <p><b>E</b>                    19,9</p> <p><b>F</b>                    18x1,5</p> <p><b>Conicita'</b>            1:10</p>
<p><b>Models</b> TRANSPORTER Series (507-508-609-610 etc.. / CH 309.xxx-310.xxx ect..)</p>		

<p><b>CEI no.</b> <b>221.022</b></p> <p><b>O.E.M. Ref</b> 000 330 8535 000 330 8735 000 330 6735 000 330 0635</p>		<p><b>A</b>    <b>24x1,5</b>    Destro / Right <i>Misure / Size</i></p> <p><b>B</b>                    80</p> <p><b>C</b>                    86</p> <p><b>D</b>                    20</p> <p><b>E</b>                    18,1</p> <p><b>F</b>                    16x1,5</p> <p><b>Conicita'</b>            1:10</p>
<p><b>Models</b> LK Series (709-809-811 etc.. / CH 314.xxx-316.xxx ect..)</p>		

<p><b>CEI no.</b> <b>221.021</b></p> <p><b>O.E.M. Ref</b> 000 330 8635 000 330 8835 000 330 6835 000 330 0735</p>		<p><b>A</b>    <b>24x1,5</b>    Sinistro / Left <i>Misure / Size</i></p> <p><b>B</b>                    80</p> <p><b>C</b>                    86</p> <p><b>D</b>                    20</p> <p><b>E</b>                    18,1</p> <p><b>F</b>                    16x1,5</p> <p><b>Conicita'</b>            1:10</p>
<p><b>Models</b> LK Series (709-809-811 etc.. / CH 314.xxx-316.xxx ect..)</p>		

<p><b>CEI no.</b> <b>221.059</b></p> <p><b>O.E.M. Ref</b> 000 460 7748 001 460 2148</p>	 <<< NESSUNA IMMAGINE - NO PICTURE >>>	<p><b>A</b>    <b>24x1,5</b>    Destro / Right <i>Misure / Size</i></p> <p><b>B</b></p> <p><b>C</b></p> <p><b>D</b>                    30</p> <p><b>E</b></p> <p><b>F</b></p> <p><b>Conicita'</b></p>
<p><b>Models</b> BUS Series (O404 - CH 356.xxx - 613.xxx etc..)</p>		





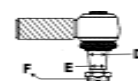
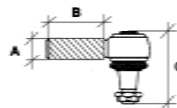

<p><b>CEI no.</b> <b>221.060</b></p> <p><b>O.E.M. Ref</b> 000 460 7848 001 460 2048</p>	 <<< NESSUNA IMMAGINE - NO PICTURE >>>	<p><b>A</b>    <b>24x1,5</b>    Sinistro / Left <i>Misure / Size</i></p> <p><b>B</b></p> <p><b>C</b></p> <p><b>D</b>                    30</p> <p><b>E</b></p> <p><b>F</b></p> <p><b>Conicita'</b></p>
<p><b>Models</b> BUS Series (O404 - CH 356.xxx - 613.xxx etc..)</p>		





<p><b>CEI no.</b> <b>198.477</b></p> <p><b>O.E.M. Ref</b> 000 330 9535 000 330 9335 000 330 7135 000 330 1535</p>	 <p><b>Models</b> TRANSPORTER - NG - LK Series (609÷809 / 1013÷1419 - CH 352.xxx-358.xxx etc..)</p>	<p><b>A</b>    <b>28x1,5</b>    Destro / Right <i>Misure / Size</i></p> <p><b>B</b>                    70 <b>C</b>                    95 <b>D</b>                    22 <b>E</b>                    19,9 <b>F</b>                    18x1,5 <b>Conicita'</b>            1:10</p>
<p><b>CEI no.</b> <b>198.478</b></p> <p><b>O.E.M. Ref</b> 000 330 9635 000 330 9435 000 330 7235 000 330 3335</p>	 <p><b>Models</b> TRANSPORTER - NG - LK Series (609÷809 / 1013÷1419 - CH 352.xxx-358.xxx etc..)</p>	<p><b>A</b>    <b>28x1,5</b>    Sinistro / Left <i>Misure / Size</i></p> <p><b>B</b>                    70 <b>C</b>                    95 <b>D</b>                    22 <b>E</b>                    19,9 <b>F</b>                    18x1,5 <b>Conicita'</b>            1:10</p>
<p><b>CEI no.</b> <b>221.034</b></p> <p><b>O.E.M. Ref</b> 001 460 4248 001 460 5048 001 460 8548</p> <p>Dado Autobl. / Nut Self-Lock</p>	 <p><b>Models</b> ATEGO - AXOR - ACTROS (1017÷1528 / 1831÷4140 - CH 950.xxx-970.xxx etc..)</p>	<p><b>A</b>    <b>28x1,5</b>    Destro / Right <i>Misure / Size</i></p> <p><b>B</b>                    80 <b>C</b>                    111,5 <b>D</b>                    28 <b>E</b>                    20x1,5 <b>F</b>                    20x1,5 <b>Conicita'</b>            1:6</p>
<p><b>CEI no.</b> <b>198.525</b></p> <p><b>O.E.M. Ref</b> 001 460 7748 000 460 2948 000 460 1048 001 460 1848</p>	 <p><b>Models</b> NG-LK-MK-SK-ATEGO-AXOR-ACTROS Series Vari modelli e telai / Various models and chassis</p>	<p><b>A</b>    <b>30x1,5</b>    Destro / Right <i>Misure / Size</i></p> <p><b>B</b>                    86 <b>C</b>                    117 <b>D</b>                    30 <b>E</b>                    27,1 <b>F</b>                    24x1,5 <b>Conicita'</b>            1:10</p>
<p><b>CEI no.</b> <b>198.524</b></p> <p><b>O.E.M. Ref</b> 000 460 3548 000 460 3448 000 460 1248 000 460 0648</p>	 <p><b>Models</b> NG-LK-MK-SK-ATEGO-AXOR-ACTROS Series Vari modelli e telai / Various models and chassis</p>	<p><b>A</b>    <b>30x1,5</b>    Sinistro / Left <i>Misure / Size</i></p> <p><b>B</b>                    86 <b>C</b>                    117 <b>D</b>                    30 <b>E</b>                    27,1 <b>F</b>                    24x1,5 <b>Conicita'</b>            1:10</p>
<p><b>CEI no.</b> <b>198.630</b></p> <p><b>O.E.M. Ref</b> 001 330 0135 001 330 0235 000 330 7335 000 330 5835</p>	 <p><b>Models</b> NG - LK - MK - SK - Series Vari modelli e telai / Various models and chassis</p>	<p><b>A</b>    <b>30x1,5</b>    Destro / Right <i>Misure / Size</i></p> <p><b>B</b>                    80 <b>C</b>                    106,5 <b>D</b>                    26 <b>E</b>                    23,5 <b>F</b>                    20x1,5 <b>Conicita'</b>            1:10</p>

All original equipment manufacturers numbers, symbols, pictures, models and description used in this catalogue are for reference only, and it is not implied that any part listed is the product of these manufacturers. Tutti i nostri particolari non sono originali ma con essi intercambiabili. I riferimenti originali, le figure, i modelli sono esposti a semplice titolo indicativo. La nostra produzione riporta il nostro marchio.

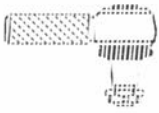

All original equipment manufacturer's numbers, symbols, pictures, models and description used in this catalogue are for reference only, and it is not implied that any part listed is the product of these manufacturers. Tutti i nostri particolari non sono originali ma con essi intercambiabili. I riferimenti sono esposti a semplice titolo indicativo. La nostra produzione riporta il nostro marchio.

<p><b>CEI no.</b> <b>198.629</b></p> <p><b>O.E.M. Ref</b> 302 330 0335 302 330 0235 302 330 0135 302 330 0035</p>	 <p><b>Models</b> NG - LK - MK - SK - Series Vari modelli e telai / Various models and chassis</p>	<p><b>A</b>    <b>30x1,5</b>    Sinistro / Left <i>Misure / Size</i></p> <p><b>B</b>                    80 <b>C</b>                    106,5 <b>D</b>                    26 <b>E</b>                    23,5 <b>F</b>                    20x1,5 <b>Conicita'</b>            1:10</p>
<p><b>CEI no.</b> <b>221.046</b></p> <p><b>O.E.M. Ref</b> 000 460 5748 000 460 6048 000 460 7048</p> <p>Dado Autobl. / Nut Self-Lock</p>	 <p><b>Models</b> LK - MK - SK - ACTROS Series Vari modelli e telai / Various models and chassis</p>	<p><b>A</b>    <b>30x1,5</b>    Destro / Right <i>Misure / Size</i></p> <p><b>B</b>                    86 <b>C</b>                    124,5 <b>D</b>                    32 <b>E</b>                    27x1,5 <b>F</b>                    27x1,5 <b>Conicita'</b>            1:10</p>
<p><b>CEI no.</b> <b>221.045</b></p> <p><b>O.E.M. Ref</b> 001 460 0548 001 460 1348 001 460 2548</p> <p>Dado Autobl. / Nut Self-Lock</p>	 <p><b>Models</b> LK - MK - SK - ACTROS Series Vari modelli e telai / Various models and chassis</p>	<p><b>A</b>    <b>30x1,5</b>    Sinistro / Left <i>Misure / Size</i></p> <p><b>B</b>                    86 <b>C</b>                    124,5 <b>D</b>                    32 <b>E</b>                    27x1,5 <b>F</b>                    27x1,5 <b>Conicita'</b>            1:10</p>
<p><b>CEI no.</b> <b>221.057</b></p> <p><b>O.E.M. Ref</b> 001 330 0335 001 330 0435 000 330 3135</p>	 <p><b>Models</b> NG - LK series (709÷917 / 1013÷1424 CH 380.xxx-673.xxx etc..)</p>	<p><b>A</b>    <b>30x1,5</b>    Destro / Right <i>Misure / Size</i></p> <p><b>B</b>                    80 <b>C</b>                    102 <b>D</b>                    22 <b>E</b>                    18x1,5 <b>F</b>                    18x1,5 <b>Conicita'</b>            1:10</p>
<p><b>CEI no.</b> <b>189.287</b></p> <p><b>O.E.M. Ref</b> 000 460 2648 000 460 2748 000 460 0148</p>	 <p><b>Models</b> NG - LK series (709÷917 / 1013÷1424 CH 380.xxx-673.xxx etc..)</p>	<p><b>A</b>    <b>30x1,5</b>    Destro / Right <i>Misure / Size</i></p> <p><b>B</b>                    95 <b>C</b>                    112,5 <b>D</b>                    26 <b>E</b>                    23,5 <b>F</b>                    20x1,5 <b>Conicita'</b>            1:10</p>
<p><b>CEI no.</b> <b>221.058</b></p> <p><b>O.E.M. Ref</b> 001 460 3848 001 460 4848 001 460 5148</p> <p>Dado Autobl. / Nut Self-Lock</p>	 <p><b>Models</b> ATEGO - AXOR Series</p>	<p><b>A</b>    <b>30x1,5</b>    Destro / Right <i>Misure / Size</i></p> <p><b>B</b>                    85 <b>C</b>                    110 <b>D</b>                    20x1,5 <b>E</b>                    20x1,5 <b>F</b>                    20x1,5 <b>Conicita'</b>            1:10</p>

<p><b>CEI no.</b> <b>221.033</b></p> <p>O.E.M. Ref 001 460 2248 001 460 1248 001 460 0848</p> <p>Dado Autobl. / Nut Self-Lock</p>	 <p><b>Models</b> ATEGO - AXOR - ACTROS (1017÷1528 / 1831÷4140 - CH 950.xxx-970.xxx etc..)</p>	<p><b>A</b>    <b>30x1,5</b>    Destro / Right <i>Misure / Size</i></p> <p><b>B</b>                    86</p> <p><b>C</b>                    117</p> <p><b>D</b>                    30</p> <p><b>E</b>                    27,1</p> <p><b>F</b>                    24x1,5</p> <p><b>Conicita'</b>            1:10</p>
<p><b>CEI no.</b> <b>221.061</b></p> <p>O.E.M. Ref 001 460 2948 000 460 9248</p> <p>Dado Autobl. / Nut Self-Lock</p>	 <p><b>Models</b> ACTROS (1831÷4140 - CH 950.xxx-954.xxx etc..)</p>	<p><b>A</b>    <b>30x1,5</b>    Destro / Right <i>Misure / Size</i></p> <p><b>B</b>                    60</p> <p><b>C</b>                    124,5</p> <p><b>D</b>                    32</p> <p><b>E</b>                    27,1</p> <p><b>F</b>                    27x1,5</p> <p><b>Conicita'</b>            1:10</p>
<p><b>CEI no.</b> <b>198.485</b></p> <p>O.E.M. Ref 001 330 1835</p>	 <p><b>Models</b> MK Series (3236 - 3244 - 3250 - 3850 / CH 625.xxx etc..)</p>	<p><b>A</b>    <b>38x1,5</b>    Destro / Right <i>Misure / Size</i></p> <p><b>B</b>                    83</p> <p><b>C</b>                    118</p> <p><b>D</b>                    30</p> <p><b>E</b>                    27,1</p> <p><b>F</b>                    24x1,5</p> <p><b>Conicita'</b>            1:10</p>
<p><b>CEI no.</b> <b>221.035</b></p> <p>O.E.M. Ref 901 333 1127</p> <p>Dado Autobl. / Nut Self-Lock</p>	 <p>&lt;&lt;&lt; NESSUNA IMMAGINE - NO PICTURE &gt;&gt;&gt;</p> <p><b>Models</b> SPRINTER Avantreno / Front Axle</p>	<p><b>A</b>                    -- <i>Misure / Size</i></p> <p><b>B</b>                    45,25</p> <p><b>C</b>                    103</p> <p><b>D</b>                    23,5</p> <p><b>E</b>                    20x1,5</p> <p><b>Conicita'</b></p>
<p><b>CEI no.</b> <b>221.013</b></p> <p>O.E.M. Ref 001 330 2635 001 330 4035 001 330 2135 000 330 7735</p>	 <p><b>Models</b> Buses 0303 (0303 CH300.xxx - 303.xxx)</p>	<p><b>A</b>    <b>35x1,5</b>    Destro / Right <i>Misure / Size</i></p> <p><b>B</b>                    104</p> <p><b>C</b>                    26</p> <p><b>D</b>                    20x1,5</p> <p><b>Conicita'</b>            1:10</p>
<p><b>CEI no.</b> <b>221.014</b></p> <p>O.E.M. Ref 001 330 2735 001 330 2235 000 330 7835 000 330 2935</p>	 <p><b>Models</b> Buses 0303 (0303 CH300.xxx - 303.xxx)</p>	<p><b>A</b>    <b>35x1,5</b>    Sinistro / Left <i>Misure / Size</i></p> <p><b>B</b>                    104</p> <p><b>C</b>                    26</p> <p><b>D</b>                    20x1,5</p> <p><b>Conicita'</b>            1:10</p>



All original equipment manufacturer's numbers, symbols, pictures, models and description used in this catalogue are for reference only, and it is not implied that any part listed is the product of these manufactures. Tutti i nostri particolari non sono originali ma con essi intercambiabili. I riferimenti originali, le figure, i modelli sono esposti a semplice titolo indicativo. La nostra produzione riporta il nostro marchio.

<p><b>CEI no.</b> <b>198.525</b></p> <p><b>O.E.M. Ref</b> 6851484000 6851480000 6851475000 6851531000</p>		<p><b>Models</b> S210 - S213 UL - S215 UL/SL - SG219 SL SG221 UL</p>	<p><b>A 30x1,5 Destro / Right</b> <i>Misure / Size</i></p> <p><b>B</b> 86 <b>C</b> 117 <b>D</b> 30 <b>E</b> 27,1 <b>F</b> 24x1,5 <b>Conicita'</b> 1:10</p>
---	---	--	--

<p><b>CEI no.</b> <b>198.524</b></p> <p><b>O.E.M. Ref</b> 6851485000 6851481000 6851476000</p>		<p><b>Models</b> S210 - S213 UL - S215 UL/SL - SG219 SL SG221 UL</p>	<p><b>A 30x1,5 Sinistro / Left</b> <i>Misure / Size</i></p> <p><b>B</b> 86 <b>C</b> 117 <b>D</b> 30 <b>E</b> 27,1 <b>F</b> 24x1,5 <b>Conicita'</b> 1:10</p>
--	---	--	---

<p><b>CEI no.</b> <b>189.287</b></p> <p><b>O.E.M. Ref</b> 6851533000 6861486000 6851478000 6851447000</p>		<p><b>Models</b> S210 - S213 UL - S215 UL/SL - SG219 SL SG221 UL</p>	<p><b>A 30x1,5 Destro / Right</b> <i>Misure / Size</i></p> <p><b>B</b> 95 <b>C</b> 112,5 <b>D</b> 26 <b>E</b> 23,5 <b>F</b> 20x1,5 <b>Conicita'</b> 1:10</p>
---	--	--	--

<p><b>CEI no.</b> <b>221.093</b></p> <p><b>O.E.M. Ref</b> 6851446000 6851487000 6851459000 6851532000</p>	 <p>&lt;&lt;&lt; NESSUNA IMMAGINE - NO PICTURE &gt;&gt;&gt;</p>	<p><b>Models</b> S210 - S213 UL - S215 UL/SL - SG219 SL SG221 UL</p>	<p><b>A 30x1,5 Sinistro / Left</b> <i>Misure / Size</i></p> <p><b>B</b> 95 <b>C</b> 112,5 <b>D</b> 26 <b>E</b> 23,5 <b>F</b> 20x1,5 <b>Conicita'</b> 1:10</p>
---	--	--	---

<p><b>CEI no.</b> <b>198.630</b></p> <p><b>O.E.M. Ref</b> 6851517000</p>		<p><b>Models</b></p>	<p><b>A 30x1,5 Destro / Right</b> <i>Misure / Size</i></p> <p><b>B</b> 80 <b>C</b> 106,5 <b>D</b> 26 <b>E</b> 23,5 <b>F</b> 20x1,5 <b>Conicita'</b> 1:10</p>
--	---	----------------------	--

<p><b>CEI no.</b> <b>198.629</b></p> <p><b>O.E.M. Ref</b> 6851516000</p>		<p><b>Models</b></p>	<p><b>A 30x1,5 Sinistro / Left</b> <i>Misure / Size</i></p> <p><b>B</b> 80 <b>C</b> 106,5 <b>D</b> 26 <b>E</b> 23,5 <b>F</b> 20x1,5 <b>Conicita'</b> 1:10</p>
--	---	----------------------	---







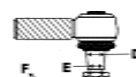
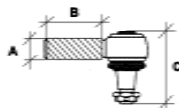

<p>CEI no. <b>221.046</b></p> <p>O.E.M. Ref 6851528000 6851522000</p> <p>Dado Autobl. / Nut Self-Lock</p>	 <p><b>Models</b> S216 - S228</p>	<p><b>A</b>    <b>30x1,5</b>    Destro / Right</p> <p>Misure / Size</p> <p><b>B</b>                    86</p> <p><b>C</b>                    124,5</p> <p><b>D</b>                    32</p> <p><b>E</b></p> <p><b>F</b>                    27x1,5</p> <p><b>Conicita'</b>            1:10</p>
---	--	--





<p>CEI no. <b>221.045</b></p> <p>O.E.M. Ref 6851521001</p> <p>Dado Autobl. / Nut Self-Lock</p>	 <p><b>Models</b> S216 - S228</p>	<p><b>A</b>    <b>30x1,5</b>    Sinistro / Left</p> <p>Misure / Size</p> <p><b>B</b>                    86</p> <p><b>C</b>                    124,5</p> <p><b>D</b>                    32</p> <p><b>E</b></p> <p><b>F</b>                    27x1,5</p> <p><b>Conicita'</b>            1:10</p>
--	--	---

All original equipment manufacturers' numbers, symbols, pictures, models and description used in this catalogue are for reference only, and it is not implied that any part listed is the product of these manufacturers. Tutti i nostri particolari non sono originali ma con essi intercambiabili. I riferimenti originali, le figure, i modelli sono esposti a semplice titolo indicativo. La nostra produzione riporta il nostro marchio.



All original equipment manufacturer's numbers, symbols, pictures, models and description used in this catalogue are for reference only, and it is not implied that any part listed is the product of these manufactures. Tutti i nostri particolari non sono originali ma con essi intercambiabili. I riferimenti originali, le figure, i modelli sono esposti a semplice titolo indicativo. La nostra produzione riporta il nostro marchio.

<p><b>CEI no.</b> <b>221.022</b></p> <p><b>O.E.M. Ref</b> 81 95301 0077 81 95301 6134 81 95301 6142 81 95301 6303</p>	 <p><b>Models</b> L.xx Series (6÷9 Ton)</p>	<p><b>A</b> <b>24x1,5</b> Destro / Right <i>Misure / Size</i></p> <p><b>B</b> 80 <b>C</b> 86 <b>D</b> 20 <b>E</b> 18,1 <b>F</b> 16x1,5 <b>Conicita'</b> 1:10</p>
<p><b>CEI no.</b> <b>221.021</b></p> <p><b>O.E.M. Ref</b> 81 95301 0078 81 95301 6141 81 95301 6304 81 95301 6322</p>	 <p><b>Models</b> L.xx Series (6÷9 Ton)</p>	<p><b>A</b> <b>24x1,5</b> Sinistro / Left <i>Misure / Size</i></p> <p><b>B</b> 80 <b>C</b> 86 <b>D</b> 20 <b>E</b> 18,1 <b>F</b> 16x1,5 <b>Conicita'</b> 1:10</p>
<p><b>CEI no.</b> <b>198.477</b></p> <p><b>O.E.M. Ref</b> 81 95301 6249 81 95301 6140 81 95301 6135 81 95301 6060</p>	 <p><b>Models</b> L.xx Series (6÷9 Ton) M.xx Series (10÷12 Ton)</p>	<p><b>A</b> <b>28x1,5</b> Destro / Right <i>Misure / Size</i></p> <p><b>B</b> 70 <b>C</b> 95 <b>D</b> 22 <b>E</b> 19,9 <b>F</b> 18x1,5 <b>Conicita'</b> 1:10</p>
<p><b>CEI no.</b> <b>198.478</b></p> <p><b>O.E.M. Ref</b> 81 95301 6222 81 95301 6139 81 95301 0079</p>	 <p><b>Models</b> L.xx Series (6÷9 Ton) M.xx Series (10÷12 Ton)</p>	<p><b>A</b> <b>28x1,5</b> Sinistro / Left <i>Misure / Size</i></p> <p><b>B</b> 70 <b>C</b> 95 <b>D</b> 22 <b>E</b> 19,9 <b>F</b> 18x1,5 <b>Conicita'</b> 1:10</p>
<p><b>CEI no.</b> <b>198.525</b></p> <p><b>O.E.M. Ref</b> 81 95301 6234 81 95301 6224 81 95301 6242 81 95301 6194</p>	 <p><b>Models</b> Old Gen CH 503÷930 - A.xx - E.xx - F.xx Series H.xx (TGA) - L.xx - M.xx - T.xx -U.xx - X.xx Series</p>	<p><b>A</b> <b>30x1,5</b> Destro / Right <i>Misure / Size</i></p> <p><b>B</b> 86 <b>C</b> 117 <b>D</b> 30 <b>E</b> 27,1 <b>F</b> 24x1,5 <b>Conicita'</b> 1:10</p>
<p><b>CEI no.</b> <b>198.524</b></p> <p><b>O.E.M. Ref</b> 81 95301 6237 81 95301 6223 81 95301 6179 81 95301 6157</p>	 <p><b>Models</b> Old Gen CH 503÷930 - A.xx - E.xx - F.xx Series H.xx (TGA) - L.xx - M.xx - T.xx -U.xx - X.xx Series</p>	<p><b>A</b> <b>30x1,5</b> Sinistro / Left <i>Misure / Size</i></p> <p><b>B</b> 86 <b>C</b> 117 <b>D</b> 30 <b>E</b> 27,1 <b>F</b> 24x1,5 <b>Conicita'</b> 1:10</p>

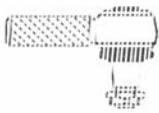
<p><b>CEI no.</b> <b>198.630</b></p> <p><b>O.E.M. Ref</b> 81 95301 6056 81 95301 6067 81 95301 6162 81 95301 6239</p>	 <p><b>Models</b> Old Gen CH 503+930 M.xx Series</p>	<p><b>A</b> <b>30x1,5</b> Destro / Right <i>Misure / Size</i></p> <p><b>B</b> 80 <b>C</b> 106,5 <b>D</b> 26 <b>E</b> 23,5 <b>F</b> 20x1,5 <b>Conicita'</b> 1:10</p>
<p><b>CEI no.</b> <b>198.629</b></p> <p><b>O.E.M. Ref</b> 81 95301 6163 81 95301 6273 81 95301 6068 81 95301 0074</p>	 <p><b>Models</b> Old Gen CH 503+930 M.xx Series</p>	<p><b>A</b> <b>30x1,5</b> Sinistro / Left <i>Misure / Size</i></p> <p><b>B</b> 80 <b>C</b> 106,5 <b>D</b> 26 <b>E</b> 23,5 <b>F</b> 20x1,5 <b>Conicita'</b> 1:10</p>
<p><b>CEI no.</b> <b>221.033</b></p> <p><b>O.E.M. Ref</b> 81 95301 6274 81 95301 6242 81 95301 6112</p> <p>Dado Autobl. / Nut Self-Lock</p>	 <p><b>Models</b> A.xx - E.xx - F.xx - H.xx (TGA) - L.xx Series M.xx - T.xx - X.xx Series</p>	<p><b>A</b> <b>30x1,5</b> Destro / Right <i>Misure / Size</i></p> <p><b>B</b> 86 <b>C</b> 117 <b>D</b> 30 <b>E</b> 27,1 <b>F</b> 24x1,5 <b>Conicita'</b> 1:10</p>
<p><b>CEI no.</b> <b>221.062</b></p> <p><b>O.E.M. Ref</b> 81 95301 6312 81 95301 6352</p> <p>Dado Autobl. / Nut Self-Lock</p>	 <p><b>Models</b> E.xx - H.xx (TGA) - T.xx Series</p>	<p><b>A</b> <b>30x1,5</b> Destro / Right <i>Misure / Size</i></p> <p><b>B</b> 100 <b>C</b> 118 <b>D</b> <b>E</b> <b>F</b> 24x1,5 <b>Conicita'</b></p>
<p><b>CEI no.</b> <b>221.086</b></p> <p><b>O.E.M. Ref</b> 81 95301 6288 81 77701 0096 81 77701 0093</p>	 <p>&lt;&lt;&lt; NESSUNA IMMAGINE - NO PICTURE &gt;&gt;</p> <p><b>Models</b> H.xx (TGA)</p>	<p><b>A</b> <b>30x1,5</b> Destro / Right <i>Misure / Size</i></p> <p><b>B</b> <b>C</b> 119 <b>D</b> 30 <b>E</b> <b>F</b> 24x1,5 <b>Conicita'</b></p>

All original equipment manufacturers' numbers, symbols, pictures, models and description used in this catalogue are for reference only, and it is not implied that any part listed is the product of these manufacturers. Tutti i nostri particolari non sono originali ma con essi intercambiabili. I riferimenti originali, le figure, i modelli sono esposti a semplice titolo indicativo. La nostra produzione riporta il nostro marchio.

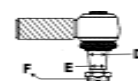
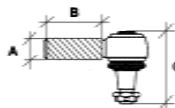



All original equipment manufacturer's numbers, symbols, pictures, models and description used in this catalogue are for reference only, and it is not implied that any part listed is the product of these manufactures. Tutti i nostri particolari non sono originali ma con essi intercambiabili. I riferimenti originali, le figure, i modelli sono esposti a semplice titolo indicativo. La nostra produzione riporta il nostro marchio.

<p><b>CEI no.</b> <b>221.022</b></p> <p><b>O.E.M. Ref</b> 50 01 860 123 50 00 814 097 50 01 844 136 50 00 807 554</p>		<p><b>A 24x1,5 Destro / Right</b> <i>Misure / Size</i></p> <p><b>B</b> 80 <b>C</b> 86 <b>D</b> 20 <b>E</b> 18,1 <b>F</b> 16x1,5 <b>Concitta'</b> 1:10</p>
<p><b>Models</b> J / JK 35-48-55-60-65-75 B 70-90-110-120</p>		

<p><b>CEI no.</b> <b>221.021</b></p> <p><b>O.E.M. Ref</b> 50 00 814 096 50 00 807 553 50 01 844 135</p>		<p><b>A 24x1,5 Sinistro / Left</b> <i>Misure / Size</i></p> <p><b>B</b> 80 <b>C</b> 86 <b>D</b> 20 <b>E</b> 18,1 <b>F</b> 16x1,5 <b>Concitta'</b> 1:10</p>
<p><b>Models</b> J / JK 35-48-55-60-65-75 B 70-90-110-120</p>		

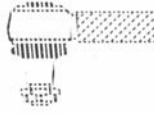
<p><b>CEI no.</b> <b>221.066</b></p> <p><b>O.E.M. Ref</b> 50 01 847 436</p>	 <<< NESSUNA IMMAGINE - NO PICTURE >>>	<p><b>A 24x1,5 Destro / Right</b> <i>Misure / Size</i></p> <p><b>B</b> 48 <b>C</b> 95 <b>D</b> 22 <b>E</b> <b>F</b> 18x1,5 <b>Concitta'</b> 1:10</p>
<p><b>Models</b> MASCOTT</p>		

<p><b>CEI no.</b> <b>221.065</b></p> <p><b>O.E.M. Ref</b> 50 01 847 437</p>	 <<< NESSUNA IMMAGINE - NO PICTURE >>>	<p><b>A 24x1,5 Sinistro / Left</b> <i>Misure / Size</i></p> <p><b>B</b> 48 <b>C</b> 95 <b>D</b> 22 <b>E</b> <b>F</b> 18x1,5 <b>Concitta'</b> 1:10</p>
<p><b>Models</b> MASCOTT</p>		





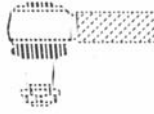

<p><b>CEI no.</b> <b>221.070</b></p> <p><b>O.E.M. Ref</b> 50 01 858 757</p>	 <<< NESSUNA IMMAGINE - NO PICTURE >>>	<p><b>A 24x1,5 Destro / Right</b> <i>Misure / Size</i></p> <p><b>B</b> 52 <b>C</b> 87,5 <b>D</b> 20 <b>E</b> <b>F</b> 16x1,5 <b>Concitta'</b> 1:10</p>
<p><b>Models</b> MASCOTT</p>		

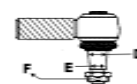
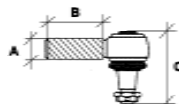
Dado Autobl. / Nut Self-Lock

<p><b>CEI no.</b> <b>221.069</b></p> <p><b>O.E.M. Ref</b> 50 01 858 756</p>	 <<< NESSUNA IMMAGINE - NO PICTURE >>>	<p><b>A 24x1,5 Sinistro / Left</b> <i>Misure / Size</i></p> <p><b>B</b> 52 <b>C</b> 87,5 <b>D</b> 20 <b>E</b> <b>F</b> 16x1,5 <b>Concitta'</b> 1:10</p>
<p><b>Models</b> MASCOTT</p>		

Dado Autobl. / Nut Self-Lock



<p><b>CEI no.</b> <b>198.477</b></p> <p><b>O.E.M. Ref</b> 50 00 823 987 50 00 559 335 50 01 825 687 00 03 406 242</p>	 <p><b>Models</b> "M" Series (150-180-210 etc..) "S" Series (150-180-210 etc..)</p>	<p><b>A 28x1,5 Destro / Right</b> <i>Misure / Size</i></p> <p>B 70 C 95 D 22 E 19,9 F 18x1,5 <b>Conicita' 1:10</b></p>
<p><b>CEI no.</b> <b>198.478</b></p> <p><b>O.E.M. Ref</b> 50 00 823 997 50 00 823 947 50 00 559 336</p>	 <p><b>Models</b> "M" Series (150-180-210 etc..) "S" Series (150-180-210 etc..)</p>	<p><b>A 28x1,5 Sinistro / Left</b> <i>Misure / Size</i></p> <p>B 70 C 95 D 22 E 19,9 F 18x1,5 <b>Conicita' 1:10</b></p>
<p><b>CEI no.</b> 221.067</p> <p><b>O.E.M. Ref</b> 50 01 851 800</p> <p>Dado Autobl. / Nut Self-Lock</p>	 <p>&lt;&lt;&lt; NESSUNA IMMAGINE - NO PICTURE &gt;&gt;&gt;</p> <p><b>Models</b> MIDLUM</p>	<p><b>A 28x1,5 Destro / Right</b> <i>Misure / Size</i></p> <p>B 55 C 92,5 D 22 E F 18x1,5 <b>Conicita' 1:10</b></p>
<p><b>CEI no.</b> <b>198.525</b></p> <p><b>O.E.M. Ref</b> 50 00 590 236 50 00 804 824 50 01 836 298 00 03 406 261</p>	 <p><b>Models</b> "R" Series (310-330-340 etc..) MAGNUM (AE380 - AE500 etc...)</p>	<p><b>A 30x1,5 Destro / Right</b> <i>Misure / Size</i></p> <p>B 86 C 117 D 30 E 27,1 F 24x1,5 <b>Conicita' 1:10</b></p>
<p><b>CEI no.</b> <b>198.524</b></p> <p><b>O.E.M. Ref</b> 00 03 401 170 50 01 836 297</p>	 <p><b>Models</b> "R" Series (310-330-340 etc..) MAGNUM (AE380 - AE500 etc...)</p>	<p><b>A 30x1,5 Sinistro / Left</b> <i>Misure / Size</i></p> <p>B 86 C 117 D 30 E 27,1 F 24x1,5 <b>Conicita' 1:10</b></p>
<p><b>CEI no.</b> <b>198.657</b></p> <p><b>O.E.M. Ref</b> 50 01 858 773 50 00 288 360</p>	 <p><b>Models</b> Old Series GB-GR-GBH / "C" - "G" - "R" Series MAXTER - PREMIUM - MAGNUM - KERAX</p>	<p><b>A 30x1,5 Destro / Right</b> <i>Misure / Size</i></p> <p>B 77 C 117,5 D 30 E 27,1 F 24x1,5 <b>Conicita' 1:10</b></p>

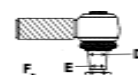
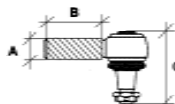

**CEI no.**  
**198.666**

**O.E.M. Ref**  
50 01 858 774  
50 00 288 361  
50 01 832 581



**Models**  
Old Series GB-GR-GBH / "C" - "G" - "R" Series  
MAXTER - PREMIUM - MAGNUM - KERAX

<b>A</b>	<b>30x1,5</b>	<b>Sinistro / Left</b>
<i>Misure / Size</i>		
<b>B</b>		77
<b>C</b>		117,5
<b>D</b>		30
<b>E</b>		27,1
<b>F</b>		24x1,5
<b>Conicita'</b>		1:10

**CEI no.**  
**198.630**

**O.E.M. Ref**  
00 03 406 212  
00 03 406 253  
50 00 242 159  
50 00 295 214



**Models**  
MACK Series (MS/CS 200-250-300 etc...)

<b>A</b>	<b>30x1,5</b>	<b>Destro / Right</b>
<i>Misure / Size</i>		
<b>B</b>		80
<b>C</b>		106,5
<b>D</b>		26
<b>E</b>		23,5
<b>F</b>		20x1,5
<b>Conicita'</b>		1:10

**CEI no.**  
**198.629**

**O.E.M. Ref**  
50 01 834 533  
00 03 486 218  
50 00 295 215  
50 01 850 550



**Models**  
MACK Series (MS/CS 200-250-300 etc...)

<b>A</b>	<b>30x1,5</b>	<b>Sinistro / Left</b>
<i>Misure / Size</i>		
<b>B</b>		80
<b>C</b>		106,5
<b>D</b>		26
<b>E</b>		23,5
<b>F</b>		20x1,5
<b>Conicita'</b>		1:10

**CEI no.**  
**221.063**

**O.E.M. Ref**  
50 01 832 582  
50 01 855 584

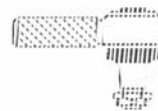

<<< NESSUNA IMMAGINE - NO PICTURE >>>

**Models**  
"M" - "S" Series (150-180-210 etc..)  
MIDLINER

<b>A</b>	<b>30x1,5</b>	<b>Destro / Right</b>
<i>Misure / Size</i>		
<b>B</b>		50
<b>C</b>		106,5
<b>D</b>		26
<b>E</b>		
<b>F</b>		20x1,5
<b>Conicita'</b>		1:10

**CEI no.**  
**221.068**

**O.E.M. Ref**  
50 01 852 264



<<< NESSUNA IMMAGINE - NO PICTURE >>>

**Models**  
MIDLUM

<b>A</b>	<b>30x1,5</b>	<b>Destro / Right</b>
<i>Misure / Size</i>		
<b>B</b>		55
<b>C</b>		106,5
<b>D</b>		26
<b>E</b>		
<b>F</b>		20x1,5
<b>Conicita'</b>		1:10

Dado Autobl. / Nut Self-Lock

**CEI no.**  
**221.054**

**O.E.M. Ref**  
50 01 852 452



<<< NESSUNA IMMAGINE - NO PICTURE >>>

**Models**  
"M" - "S" Series (150-180-210 etc..)  
MIDLUM

<b>A</b>	<b>30x1,5</b>	<b>Destro / Right</b>
<i>Misure / Size</i>		
<b>B</b>		58
<b>C</b>		117,5
<b>D</b>		30
<b>E</b>		
<b>F</b>		24x1,5
<b>Conicita'</b>		1:10

All original equipment manufacturers' numbers, symbols, pictures, models and description used in this catalogue are for reference only, and it is not implied that any part listed is the product of these manufactures. Tutti i nostri particolari non sono originali ma con essi intercambiabili. I riferimenti originali, le figure, i modelli sono esposti a semplice titolo indicativo. La nostra produzione riporta il nostro marchio.

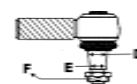
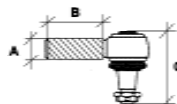

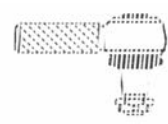

<p><b>CEI no.</b> 221.078</p> <p><b>O.E.M. Ref</b> 50 01 858 763</p>	 <p>&lt;&lt;&lt; NESSUNA IMMAGINE - NO PICTURE &gt;&gt;&gt;</p> <p><b>Models</b> PREMIUM</p>	<p><b>A</b>    <b>30x1,5</b>    Destro / Right Misure / Size</p> <p><b>B</b></p> <p><b>C</b>                    146</p> <p><b>D</b>                    27</p> <p><b>E</b></p> <p><b>F</b>                    24x1,5</p> <p><b>Conicita'</b></p>
--	---	---

<p><b>CEI no.</b> <b>198.485</b></p> <p><b>O.E.M. Ref</b> 50 01 832 580 00 03 401 207 50 01 831 481</p>	 <p><b>Models</b> Old Seeries GB-GR-GBH "C" - "G" - "R" Series</p>	<p><b>A</b>    <b>38x1,5</b>    Destro / Right Misure / Size</p> <p><b>B</b>                    83</p> <p><b>C</b>                    118</p> <p><b>D</b>                    30</p> <p><b>E</b>                    27,1</p> <p><b>F</b>                    24x1,5</p> <p><b>Conicita'</b>                    1:10</p>
---	---	---

<p><b>CEI no.</b> <b>198.486</b></p> <p><b>O.E.M. Ref</b> 50 01 832 579 00 03 401 206</p>	 <p><b>Models</b> Old Seeries GB-GR-GBH "C" - "G" - "R" Series</p>	<p><b>A</b>    <b>38x1,5</b>    Sinistro / Left Misure / Size</p> <p><b>B</b>                    83</p> <p><b>C</b>                    118</p> <p><b>D</b>                    30</p> <p><b>E</b>                    27,1</p> <p><b>F</b>                    24x1,5</p> <p><b>Conicita'</b>                    1:10</p>
---	--	--

All original equipment manufacturers numbers, symbols, pictures, models and description used in this catalogue are for reference only, and it is not implied that any part listed is the product of these manufactures. Tutti i nostri particolari non sono originali ma con essi intercambiabili. I riferimenti originali, le figure, i modelli sono esposti a semplice titolo indicativo. La nostra produzione riporta il nostro marchio.

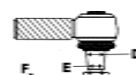
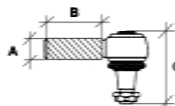

CEI no.

**221.051**

O.E.M. Ref  
50 00 288 362  
00 03 401 165



**Models**  
Old Seeries TR-GR  
"R" Series Fino al / Up to 1993

**A 52x1,5 Destro / Right**  
*Misure / Size*  
B  
C  
D 30  
E 27  
F 24x1,5  
**Conicita'**

CEI no.

**221.052**

O.E.M. Ref  
50 00 288 363



**Models**  
Old Seeries TR-GR  
"R" Series Fino al / Up to 1993

**A 52x1,5 Sinistro / Left**  
*Misure / Size*  
B  
C  
D 30  
E 27  
F 24x1,5  
**Conicita'**

CEI no.

221.076

O.E.M. Ref  
50 00 288 366



<<< NESSUNA IMMAGINE - NO PICTURE >>>

**Models**  
"R" Series Dal / From 1993  
**PREMIUM - MAGNUM**

**A 48x1,5 Destro / Right**  
*Misure / Size*  
B  
C  
D  
E  
F  
**Conicita'**

CEI no.

221.077

O.E.M. Ref  
50 00 288 367



<<< NESSUNA IMMAGINE - NO PICTURE >>>

**Models**  
"R" Series Dal / From 1993  
**PREMIUM - MAGNUM**

**A 48x1,5 Sinistro / Left**  
*Misure / Size*  
B  
C  
D  
E  
F  
**Conicita'**

All original equipment manufacturer's numbers, symbols, pictures, models and description used in this catalogue are for reference only, and it is not implied that any part listed is the product of these manufacturers. Tutti i nostri particolari non sono originali ma con essi intercambiabili. I riferimenti originali, le figure, i modelli sono esposti a semplice titolo indicativo. La nostra produzione riporta il nostro marchio.

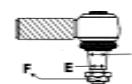
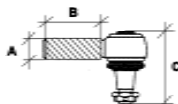

CEI no.  
**198.525**

O.E.M. Ref  
1358793  
395010  
283784  
1738381



Assale / Axles AM55 / 56 / 60 / 61 / 620 / 740 / 900  
Serie "1" (LBT 111-141 etc..) - Serie "2" (R142 etc..)  
Serie "3" (R113-143 etc..) - Serie "4" (114-144 etc..)

<b>A</b>	<b>30x1,5</b>	Destro / Right
Misure / Size		
<b>B</b>		86
<b>C</b>		117
<b>D</b>		30
<b>E</b>		27,1
<b>F</b>		24x1,5
<b>Conicita'</b>		1:10

CEI no.  
**198.524**

O.E.M. Ref  
1738380  
1358792  
395009  
283783



Assale / Axles AM55 / 56 / 60 / 61 / 620 / 740 / 900  
Serie "1" (LBT 111-141 etc..) - Serie "2" (R142 etc..)  
Serie "3" (R113-143 etc..) - Serie "4" (114-144 etc..)

<b>A</b>	<b>30x1,5</b>	Sinistro / Left
Misure / Size		
<b>B</b>		86
<b>C</b>		117
<b>D</b>		30
<b>E</b>		27,1
<b>F</b>		24x1,5
<b>Conicita'</b>		1:10

CEI no.  
221.019

O.E.M. Ref  
1337367  
352646



Assale / Axles AM 70  
Serie "3" (113-R143 etc..)

<b>A</b>	<b>30x1,5</b>	Destro / Right
Misure / Size		
<b>B</b>		86
<b>C</b>		131,5
<b>D</b>		30
<b>E</b>		27,1
<b>F</b>		24x1,5
<b>Conicita'</b>		1:10

CEI no.  
**221.042**

O.E.M. Ref  
1337366  
352645



Assale / Axles AM 70  
Serie "3" (113-R143 etc..)

<b>A</b>	<b>30x1,5</b>	Sinistro / Left
Misure / Size		
<b>B</b>		86
<b>C</b>		131,5
<b>D</b>		30
<b>E</b>		27,1
<b>F</b>		24x1,5
<b>Conicita'</b>		1:10

CEI no.  
**221.075**

O.E.M. Ref  
1738379  
1357674



Assale / Axles AM 760 / 860 / 900  
Serie "4" (114-124-144 etc..)

<b>A</b>	<b>30x1,5</b>	Destro / Right
Misure / Size		
<b>B</b>		
<b>C</b>		
<b>D</b>		40
<b>E</b>		
<b>F</b>		24x1,5
<b>Conicita'</b>		1:10

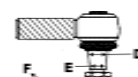
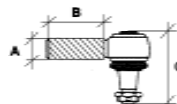

CEI no.  
**221.049**

O.E.M. Ref  
310980



Assale / Axles AM 56 - AM61  
Serie "3" (R113-R143 etc..)

**A 52x1,5** Destro / Right  
Misure / Size  
B  
C  
D 30  
E 27  
F 24x1,5  
Conicita' 1:10

CEI no.  
**221.048**

O.E.M. Ref  
310979



Assale / Axles AM 56 - AM61  
Serie "3" (R113-R143 etc..)

**A 52x1,5** Sinistro / Left  
Misure / Size  
B  
C  
D 30  
E 27  
F 24x1,5  
Conicita' 1:10

All original equipment manufacturer's numbers, symbols, pictures, models and description used in this catalogue are for reference only, and it is not implied that any part listed is the product of these manufactures.  
Tutti i nostri particolari non sono originali ma con essi intercambiabili. I riferimenti originali, le figure, i modelli sono esposti a semplice titolo indicativo. La nostra produzione riporta il nostro marchio.

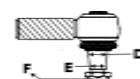
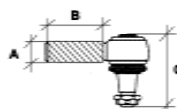

CEI no.  
**198.475**

O.E.M. Ref  
1696919

*Models*  
FL6  
FL608-615



<b>A</b>	<b>24x1,5</b>	Destro / Right
		<i>Misure / Size</i>
	<b>B</b>	70
	<b>C</b>	95
	<b>D</b>	22
	<b>E</b>	19,9
	<b>F</b>	18x1,5
	<b>Conicita'</b>	1:10

CEI no.  
**198.476**

O.E.M. Ref  
1696920

*Models*  
FL6  
FL608-615



<b>A</b>	<b>24x1,5</b>	Sinistro / Left
		<i>Misure / Size</i>
	<b>B</b>	70
	<b>C</b>	95
	<b>D</b>	22
	<b>E</b>	19,9
	<b>F</b>	18x1,5
	<b>Conicita'</b>	1:10

CEI no.  
**198.477**

O.E.M. Ref  
1698191  
1517444  
1517440

*Models*  
FL608-615



<b>A</b>	<b>28x1,5</b>	Destro / Right
		<i>Misure / Size</i>
	<b>B</b>	70
	<b>C</b>	95
	<b>D</b>	22
	<b>E</b>	19,9
	<b>F</b>	18x1,5
	<b>Conicita'</b>	1:10

CEI no.  
**198.478**

O.E.M. Ref  
1698190  
1695511  
1517439  
1517279

*Models*  
FL608-615



<b>A</b>	<b>28x1,5</b>	Sinistro / Left
		<i>Misure / Size</i>
	<b>B</b>	70
	<b>C</b>	95
	<b>D</b>	22
	<b>E</b>	19,9
	<b>F</b>	18x1,5
	<b>Conicita'</b>	1:10

CEI no.  
**198.624**

O.E.M. Ref  
1698846  
1698532  
1507823  
1505759

*Models*  
FL616-619 - FL7 - FS7 - F10 - FL10 - F12 - FL12  
F16 - N10 - NL10 - N12 - NL12



<b>A</b>	<b>30x1,5</b>	Destro / Right
		<i>Misure / Size</i>
	<b>B</b>	78
	<b>C</b>	119,5
	<b>D</b>	28,6
	<b>E</b>	23,9
	<b>F</b>	20x1,5
	<b>Conicita'</b>	1:6

CEI no.  
**198.625**

O.E.M. Ref  
1698847  
1698533  
1507822  
1505758





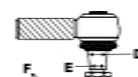
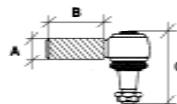

*Models*  
FL616-619 - FL7 - FS7 - F10 - FL10 - F12 - FL12  
F16 - N10 - NL10 - N12 - NL12







<b>A</b>	<b>30x1,5</b>	Sinistro / Left
		<i>Misure / Size</i>
	<b>B</b>	78
	<b>C</b>	119,5
	<b>D</b>	28,6
	<b>E</b>	23,9
	<b>F</b>	20x1,5
	<b>Conicita'</b>	1:6



All original equipment manufacturers' numbers, symbols, pictures, models and description used in this catalogue are for reference only, and it is not implied that any part listed is the product of these manufacturers. Tutti i nostri particolari non sono originali ma con essi intercambiabili. I riferimenti sono esposti a semplice titolo indicativo. La nostra produzione riporta il nostro marchio.

<p><b>CEI no.</b> <b>198.626</b></p> <p><b>O.E.M. Ref</b> 1695776 1698557 1695585 1507826</p>	 <p><b>Models</b> FL7 - FM7 - F10 - FL10 - FM10 - F12 - FM12 N10 - NL10 Buses B10B - B10M - B12</p>	<p><b>A</b>    <b>30x1,5</b>    Destro / Right <i>Misure / Size</i></p> <p><b>B</b>                    83</p> <p><b>C</b>                    125</p> <p><b>D</b>                    31,5</p> <p><b>E</b>                    27,3</p> <p><b>F</b>                    24x1,5</p> <p><b>Conicita'</b>            1:8</p>
<p><b>CEI no.</b> <b>221.001</b></p> <p><b>O.E.M. Ref</b> 1698840 1698558 6869744 6882112</p>	 <p><b>Models</b> FL7 - FM7 - F10 - FL10 - FM10 - F12 - FM12 N10 - NL10 Buses B10B - B10M - B12</p>	<p><b>A</b>    <b>30x1,5</b>    Sinistro / Left <i>Misure / Size</i></p> <p><b>B</b>                    83</p> <p><b>C</b>                    125</p> <p><b>D</b>                    31,5</p> <p><b>E</b>                    27,3</p> <p><b>F</b>                    24x1,5</p> <p><b>Conicita'</b>            1:8</p>
<p><b>CEI no.</b> <b>221.027</b></p> <p><b>O.E.M. Ref</b> 3092472 3090727 3988965 3110002</p>	 <p><b>Models</b> FM7 - FM9 - FM10 - FM12 FH12 - FH16</p>	<p><b>A</b>    <b>30x1,5</b>    Destro / Right <i>Misure / Size</i></p> <p><b>B</b>                    80</p> <p><b>C</b>                    109,5</p> <p><b>D</b>                    28,6</p> <p><b>E</b>                    23,9</p> <p><b>F</b>                    20x1,5</p> <p><b>Conicita'</b>            1:6</p>
<p><b>CEI no.</b> <b>221.028</b></p> <p><b>O.E.M. Ref</b> 3092471 3090728 3988968 3110001</p>	 <p><b>Models</b> FM7 - FM9 - FM10 - FM12 FH12 - FH16</p>	<p><b>A</b>    <b>30x1,5</b>    Sinistro / Left <i>Misure / Size</i></p> <p><b>B</b>                    80</p> <p><b>C</b>                    109,5</p> <p><b>D</b>                    28,6</p> <p><b>E</b>                    23,9</p> <p><b>F</b>                    20x1,5</p> <p><b>Conicita'</b>            1:6</p>
<p><b>CEI no.</b> <b>221.073</b></p> <p><b>O.E.M. Ref</b> 1697247 1696057 1695690</p> <p>Dado Autobl. / Nut Self-Lock</p>	 <p><b>Models</b> FL616-619</p>	<p><b>A</b>    <b>30x1,5</b>    Destro / Right <i>Misure / Size</i></p> <p><b>B</b>                    60</p> <p><b>C</b>                    106,5</p> <p><b>D</b>                    26</p> <p><b>E</b>                    20x1,5</p> <p><b>F</b>                    20x1,5</p> <p><b>Conicita'</b>            1:10</p>
<p><b>CEI no.</b> <b>221.095</b></p> <p><b>O.E.M. Ref</b> 1698839 1695689</p> <p>Dado Autobl. / Nut Self-Lock</p>	 <p>&lt;&lt;&lt; NESSUNA IMMAGINE - NO PICTURE &gt;&gt;&gt;</p> <p><b>Models</b> FL616-619</p>	<p><b>A</b>    <b>30x1,5</b>    Sinistro / Left <i>Misure / Size</i></p> <p><b>B</b>                    60</p> <p><b>C</b>                    106,5</p> <p><b>D</b>                    26</p> <p><b>E</b>                    20x1,5</p> <p><b>F</b>                    20x1,5</p> <p><b>Conicita'</b>            1:10</p>



<p><b>CEI no.</b> <b>221.089</b></p> <p>O.E.M. Ref 3098332 1698047</p> <p>Dado Autobl. / Nut Self-Lock</p>	 <p><b>Models</b> FL616-626</p>	<p><b>A 30x1,5 Destro / Right</b> <i>Misure / Size</i></p> <p><b>B</b> 60 <b>C</b> 106,5 <b>D</b> 26 <b>E</b> <b>F</b> 20x1,5 <b>Conicita'</b> 1:10</p>
<p><b>CEI no.</b> <b>221.071</b></p> <p>O.E.M. Ref 3093647</p> <p>Dado Autobl. / Nut Self-Lock</p>	 <p><b>Models</b> FM7-FM9-FM10-FH12-FM12-FH16</p>	<p><b>A 30x1,5 Destro / Right</b> <i>Misure / Size</i></p> <p><b>B</b> 100 <b>C</b> 114 <b>D</b> 28,90 <b>E</b> 24 <b>F</b> 20x1,5 <b>Conicita'</b> 1:8</p>
<p><b>CEI no.</b> <b>221.016</b></p> <p>O.E.M. Ref 1699401 1696901 1131742</p> <p>Speciale / Special</p>	 <p><b>Models</b> FL7 - FM7 - FM9 - FL10 - FM10 - FH12 - FM12 FH16 - Buses B9M - B10M</p>	<p><b>A 52x1,5 Destro / Right</b> <i>Misure / Size</i></p> <p><b>B</b> <b>C</b> 119,5 <b>D</b> 28,6 <b>E</b> 23,9 <b>F</b> 20x1,5 <b>Conicita'</b> 1:6</p>
<p><b>CEI no.</b> <b>221.015</b></p> <p>O.E.M. Ref 1699400 1696900 1131741</p> <p>Speciale / Special</p>	 <p><b>Models</b> FL7 - FM7 - FM9 - FL10 - FM10 - FH12 - FM12 FH16 - Buses B9M - B10M</p>	<p><b>A 52x1,5 Sinistro / Left</b> <i>Misure / Size</i></p> <p><b>B</b> <b>C</b> 119,5 <b>D</b> 28,6 <b>E</b> 23,9 <b>F</b> 20x1,5 <b>Conicita'</b> 1:6</p>

All original equipment manufacturers' numbers, symbols, pictures, models and description used in this catalogue are for reference only, and it is not implied that any part listed is the product of these manufacturers. Tutti i nostri particolari non sono originali ma con essi intercambiabili. I riferimenti originali, le figure, i modelli sono esposti a semplice titolo indicativo. La nostra produzione riporta il nostro marchio.

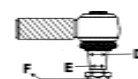
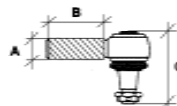

CEI no.  
**198.522**

O.E.M. Ref  
8558220



Suitable to **IVECO**  
FIAT OM Gearboxes

<b>A</b>	<b>16x1,5</b>	Destro / Right
		Misure / Size
	<b>B</b>	63
	<b>C</b>	60
	<b>D</b>	14,5
	<b>E</b>	12,3
	<b>F</b>	10x1,0
	<b>Conicita'</b>	

CEI no.  
221.039

O.E.M. Ref  
41203863  
42041327  
42079853  
41002118



<<< NESSUNA IMMAGINE - NO PICTURE >>>

Suitable to **IVECO**  
EuroCargo  
Gearboxes : 2838/2845/2855/2865/2870/2895

<b>A</b>	<b>10x1,5</b>	Destro / Right
		Misure / Size
	<b>B</b>	
	<b>C</b>	
	<b>D</b>	
	<b>E</b>	
	<b>F</b>	
	<b>Conicita'</b>	

CEI no.  
221.040

O.E.M. Ref  
41203864  
42041328  
42079852  
41002119

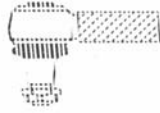

<<< NESSUNA IMMAGINE - NO PICTURE >>>

Suitable to **IVECO**  
EuroCargo  
Gearboxes : 2838/2845/2855/2865/2870/2895

<b>A</b>	<b>10x1,5</b>	Sinistro / Left
		Misure / Size
	<b>B</b>	
	<b>C</b>	
	<b>D</b>	
	<b>E</b>	
	<b>F</b>	
	<b>Conicita'</b>	

CEI no.  
221.041

O.E.M. Ref  
42042912  
42112249  
3435788



<<< NESSUNA IMMAGINE - NO PICTURE >>>

Suitable to **IVECO**  
EuroCargo  
Gearboxes : 2838/2845/2855/2865/2870/2895

<b>A</b>	<b>16x1,5</b>	Destro / Right
		Misure / Size
	<b>B</b>	
	<b>C</b>	
	<b>D</b>	
	<b>E</b>	
	<b>F</b>	
	<b>Conicita'</b>	

CEI no.  
**189.402**

O.E.M. Ref  
1384898  
371452  
305320



Suitable to **SCANIA**  
Serie "3" (R143 etc.) / Serie "4" (114-124-144 etc.)  
Gearboxes : GR870/871/880 - GR/GRS 801/900

<b>A</b>	<b>12x1,75</b>	Destro / Right
		Misure / Size
	<b>B</b>	
	<b>C</b>	47
	<b>D</b>	10
	<b>E</b>	
	<b>F</b>	10x1,5
	<b>Conicita'</b>	

CEI no.  
**189.403**

O.E.M. Ref  
1384897  
371451  
305319



Suitable to **SCANIA**  
Serie "3" (R143 etc.) / Serie "4" (114-124-144 etc.)  
Gearboxes : GR870/871/880 - GR/GRS 801/900

<b>A</b>	<b>12x1,75</b>	Sinistro / Left
		Misure / Size
	<b>B</b>	
	<b>C</b>	47
	<b>D</b>	10
	<b>E</b>	
	<b>F</b>	10x1,5
	<b>Conicita'</b>	

All original equipment manufacturer's numbers, symbols, pictures, models and description used in this catalogue are for reference only, and it is not implied that any part listed is the product of these manufactures. Tutti i nostri particolari non sono originali ma con essi intercambiabili. I riferimenti originali, le figure, i modelli sono esposti a semplice titolo indicativo. La nostra produzione riporta il nostro marchio.

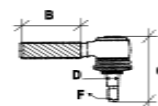
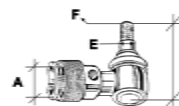
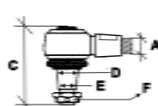

CEI no.  
**221.047**

O.E.M. Ref  
350270  
243664



Suitable to **SCANIA**  
Serie "3" (R143 etc.) / Serie "4" (114-124-144 etc.)  
Gearboxes : GR870/871/880 - GR/GRS 801/900

<b>A</b>	<b>14x2</b>	Destro / Right
	<i>Misure / Size</i>	
<b>B</b>		60
<b>C</b>		72
<b>D</b>		12
<b>E</b>		
<b>F</b>		10x1,5
<b>Conicita'</b>		1:12

CEI no.  
**221.024**

O.E.M. Ref  
382613



Suitable to **VOLVO**  
R/SR62 - R/SR70  
R/SR 1000 - 1400 - 1700

<b>A</b>	<b>12x1,5</b>	Destro / Right
	<i>Misure / Size</i>	
<b>B</b>		34
<b>C</b>		47
<b>D</b>		10
<b>E</b>		
<b>F</b>		10x1,5
<b>Conicita'</b>		

CEI no.  
**221.043**

O.E.M. Ref  
1527234  
1668638  
382745



Suitable to **VOLVO**  
R/SR62 - R/SR70  
R/SR 1000 - 1400 - 1700

<b>A</b>	<b>28x1,5</b>	Destro / Right
	<i>Misure / Size</i>	
<b>B</b>		49
<b>C</b>		75
<b>D</b>		16,3
<b>E</b>		
<b>F</b>		12x1,5
<b>Conicita'</b>		1:10

All original equipment manufacturers' numbers, symbols, pictures, models and description used in this catalogue are for reference only, and it is not implied that any part listed is the product of these manufacturers. Tutti i nostri particolari non sono originali ma con essi intercambiabili. I riferimenti originali, le figure, i modelli sono esposti a semplice titolo indicativo. La nostra produzione riporta il nostro marchio.

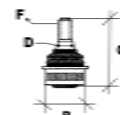
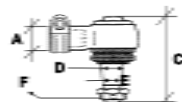
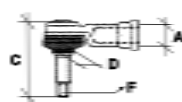

CEI no.  
**189.402**

O.E.M. Ref  
0501 206 800

8198188  
20447  
140362  
000 268 6289  
81 95301 6170  
50 10 129 530  
1190131

Suitable To  
**ZF**



**Cambi Vecchia Generazione**  
**Old Generation Gearboxes**

S6-36 / S6-65 / AK/S6-80 / AK/S6-90 /  
4S120-150GP / 5K/S90 GP / 5S92 GP /  
5K/S 110 GP / 5S111 GP

**EcoMid**

9S109 / 16S109 / 8S140 / 6S150C / S6-85  
/ 9S75

**EcoSplit I - EcoSplit II**

16S112 / 16S130 / 16S150 / 16S160 /  
16S190 / 16S220

**A 12x1,75** Destro / Right  
Misure / Size

**B**  
**C** 47  
**D** 10

**E**  
**F** 10x1,5

**Conicita'**

CEI no.  
**189.403**

O.E.M. Ref  
0501 206 799

8198187  
--  
140363  
000 268 6189  
81 95301 6174  
50 01 000 134  
1190132

Suitable To  
**ZF**



**Cambi Vecchia Generazione**  
**Old Generation Gearboxes**

S6-36 / S6-65 / AK/S6-80 / AK/S6-90 /  
4S120-150GP / 5K/S90 GP / 5S92 GP /  
5K/S 110 GP / 5S111 GP

**EcoMid**

9S109 / 16S109 / 8S140 / 6S150C / S6-85  
/ 9S75

**EcoSplit I - EcoSplit II**

16S112 / 16S130 / 16S150 / 16S160 /  
16S190 / 16S220

**A 12x1,75** Sinistro / Left  
Misure / Size

**B**  
**C** 47  
**D** 10

**E**  
**F** 10x1,5

**Conicita'**

CEI no.  
**189.401**

O.E.M. Ref  
0501 204 714

42487482  
20451  
542477  
000 268 4889  
81 95301 6169  
50 00 807 536  
1527453

Suitable To  
**ZF**



**Cambi Vecchia Generazione**  
**Old Generation Gearboxes**

S6-36 / S6-65 / AK/S6-80 / AK/S6-90 /  
4S120-150GP / 5K/S90 GP / 5S92 GP /  
5K/S 110 GP / 5S111 GP

**EcoMid**

9S109 / 16S109 / 8S140 / 6S150C / S6-85  
/ 9S75

**EcoSplit I - EcoSplit II**











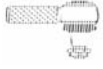







16S112 / 16S130 / 16S150 / 16S160 /  
16S190 / 16S220

**A 14x1,5** Destro / Right  
Misure / Size

**B** 60  
**C** 70  
**D** 12

**E**  
**F** 10x1



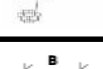



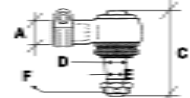
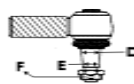
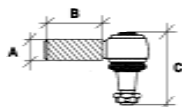













**Conicita'**

CEI no.			A mm	B mm	C mm	D mm	E mm	F mm	Con.
221.003	Dx		14x1,5						1:8
198.551	Dx		16x1,0	52	65	15,9	14,5	12x1,5	1:8
198.552	Sn		16x1,0	52	65	15,9	14,5	12x1,5	1:8
198.472	Dx		16x1,5		68,5	18,3		14x1,5	1:10
221.002	Dx		16x1,5		66	16,8		12x1,5	1:10
221.004	Dx		16x1,5	76,5					1:8
221.074	Dx		16x1,5		91,3	18,2		11x1,5	1:10
198.494	Dx		18x1,5	70	80	18,2	16	14x1,5	1:10
198.495	Sn		18x1,5	70	80	18,2	16	14x1,5	1:10
198.473	Dx		20x1,5		110	24,2		18x1,5	1:10
198.474	Dx		20x1,5		117	24		18x1,5	1:10
198.636	Dx		20x1,5		106	26	23,5	20x1,5	
221.020	Dx		20x1,5		110,5	24,2	21,7	18x1,5	1:10
198.475	Dx		24x1,5	70	95	22	19,9	18x1,5	1:10
198.476	Sn		24x1,5	70	95	22	19,9	18x1,5	1:10
198.637	Dx		24x1,5		116	30	27	24x1,5	
221.021	Sn		24x1,5	80	86	20	18,1	16x1,5	1:10
221.022	Dx		24x1,5	80	86	20	18,1	16x1,5	1:10
221.059	Dx		24x1,5			30			
221.060	Sn		24x1,5			30			
221.065	Sn		24x1,5	48	95	22		18x1,5	1:10

All original equipment manufacturers numbers, symbols, pictures, models and description used in this catalogue are for reference only, and it is not implied that any part listed is the product of these manufacturers. Tutti i nostri particolari non sono originali ma con essi intercambiabili. I riferimenti originali, le figure, i modelli sono esposti a semplice titolo indicativo. La nostra produzione riporta il nostro marchio.





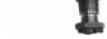

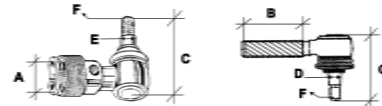
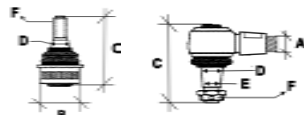













All original equipment manufacturer's numbers, symbols, pictures, models and description used in this catalogue are for reference only, and it is not implied that any part listed is the product of these manufacturers. Tutti i nostri particolari non sono originali ma con essi intercambiabili. I riferimenti originali, le figure, i modelli sono esposti a semplice titolo indicativo. La nostra produzione riporta il nostro marchio.

CEI no.			A mm	B mm	C mm	D mm	E mm	F mm	Con.
221.066	Dx		24x1,5	48	95	22		18x1,5	1:10
221.069	Sn		24x1,5	52	87,5	20		16x1,5	1:10
221.070	Dx		24x1,5	52	87,5	20		16x1,5	1:10
198.496	Dx		25x1,5	70	100	22,4	19,5	16x1,5	1:8
198.497	Sn		25x1,5	70	100	22,4	19,5	16x1,5	1:8
198.477	Dx		28x1,5	70	95	22	19,9	18x1,5	1:10
198.478	Sn		28x1,5	70	95	22	19,9	18x1,5	1:10
198.480	Dx		28x1,5	80	116	28,1	24,7	22x1,5	1:8
198.481	Sn		28x1,5	80	116	28,1	24,7	22x1,5	1:8
198.602	Dx		28x1,5	80	106,5	26	23,5	20x1,5	1:10
198.603	Sn		28x1,5	80	106,5	26	23,5	20x1,5	1:10
221.034	Dx		28x1,5	80	111,5	28		20x1,5	1:6
221.067	Dx		28x1,5	55	92,5	22		18x1,5	1:10
189.287	Dx		30x1,5	95	112,5	26	23,5	20x1,5	1:10
198.482	Dx		30x1,5		98	22,5		16x1,5	
198.491	Dx		30x1,5		123	31,8		22x1,5	
198.492	Dx		30x1,5	77	117	30	27,1	24x1,5	1:10
198.493	Sn		30x1,5	77	117	30	27,1	24x1,5	1:10
198.519	Dx		30x1,5		117			24x1,5	
198.524	Sn		30x1,5	86	117	30	27,1	24x1,5	1:10
198.525	Dx		30x1,5	86	117	30	27,1	24x1,5	1:10



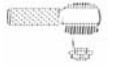

CEI no.			A mm	B mm	C mm	D mm	E mm	F mm	Con.
198.554	Dx		30x1,5		105			20x1,5	
198.598	Dx		30x1,5	74	105	26	23,5	20x1,5	1:10
198.599	Sn		30x1,5	74	105	26	23,5	20x1,5	1:10
198.624	Dx		30x1,5	78	119,5	28,6	23,9	20x1,5	1:6
198.625	Sn		30x1,5	78	119,5	28,6	23,9	20x1,5	1:6
198.626	Dx		30x1,5	83	125	31,5	27,3	24x1,5	1:8
198.629	Sn		30x1,5	80	106,5	26	23,5	20x1,5	1:10
198.630	Dx		30x1,5	80	106,5	26	23,5	20x1,5	1:10
198.657	Dx		30x1,5	77	117,5	30	27,1	24x1,5	1:10
198.666	Sn		30x1,5	77	117,5	30	27,1	24x1,5	1:10
221.001	Sn		30x1,5	83	125	31,5	27,3	24x1,5	1:8
221.019	Dx		30x1,5	86	131,5	30	27,1	24x1,5	1:10
221.027	Dx		30x1,5	80	109,5	28,6	23,9	20x1,5	1:6
221.028	Sn		30x1,5	80	109,5	28,6	23,9	20x1,5	1:6
221.033	Dx		30x1,5	86	117	30	27,1	24x1,5	1:10
221.042	Sn		30x1,5	86	131,5	30	27,1	24x1,5	1:10
221.045	Sn		30x1,5	86	124,5	32		27x1,5	1:10
221.046	Dx		30x1,5	86	124,5	32		27x1,5	1:10
221.054	Dx		30x1,5	58	117,5	30		24x1,5	1:10
221.055	Dx		30x1,5	86	117	30	27,1	24x1,5	1:10
221.057	Dx		30x1,5	80	102	22		18x1,5	1:10

All original equipment manufacturers numbers, symbols, pictures, models and description used in this catalogue are for reference only, and it is not implied that any part listed is the product of these manufacturers. Tutti i nostri particolari non sono originali ma con essi intercambiabili. I riferimenti originali, le figure, i modelli sono esposti a semplice titolo indicativo. La nostra produzione riporta il nostro marchio.

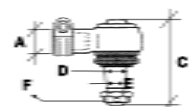
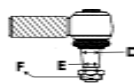
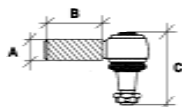

All original equipment manufacturer's numbers, symbols, pictures, models and description used in this catalogue are for reference only, and it is not implied that any part listed is the product of these manufacturers. Tutti i nostri particolari non sono originali ma con essi intercambiabili. I rifinitivi originali, le figure, i modelli sono esposti a semplice titolo indicativo. La nostra produzione riporta il nostro marchio.

CEI no.			A mm	B mm	C mm	D mm	E mm	F mm	Con.
221.058	Dx		30x1,5	85	110			20x1,5	
221.061	Dx		30x1,5	60	124,5	32		27x1,5	1:10
221.062	Dx		30x1,5	100	118			24x1,5	
221.063	Dx		30x1,5	50	106,5	26		20x1,5	1:10
221.068	Dx		30x1,5	55	106,5	26		20x1,5	1:10
221.071	Dx		30x1,5	100	114	28,9	24	20x1,5	1:08
221.073	Dx		30x1,5	60	106,5	26		20x1,5	1:10
221.075	Dx		30x1,5			40		24x1,5	1:10
221.078	Dx		30x1,5		146	27		24x1,5	
221.082	Dx		30x1,5		107	22		18x1,5	
221.083	Sn		30x1,5		127	26			
221.084	Dx		30x1,5		141	26			
221.086	Dx		30x1,5		119	30			
221.087	Dx		30x1,5						
221.088	Dx		30x1,5						
221.089	Dx		30x1,5	60	106,5	26		20x1,5	1:10
221.093	Sn		30x1,5	95	112,5	26	23,5	20x1,5	1:10
221.095	Sn		30x1,5	60	106,5	26		20x1,5	1:10
221.013	Dx		35x1,5		104	26		20x1,5	1:10
221.014	Sn		35x1,5		104	26		20x1,5	1:10
198.485	Dx		38x1,5	83	118	30	27,1	24x1,5	1:10

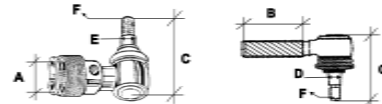
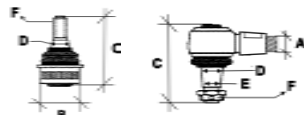



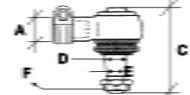
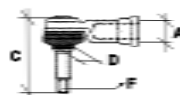
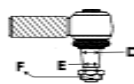
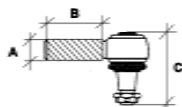

CEI no.			A mm	B mm	C mm	D mm	E mm	F mm	Con.
198.486	Sn		38x1,5	83	118	30	27,1	24x1,5	1:10
198.498	Dx		38x1,5	95	132	31,8	27	22x1,5	1:8
198.499	Sn		38x1,5	95	132	31,8	27	22x1,5	1:8
198.650	Dx		38x1,5	93	102	32	28,5	24x1,5	
221.007	Dx		38x1,5	87	141	38	34,3	30x1,5	1:10
221.008	Sn		38x1,5	87	141	38	34,3	30x1,5	1:10
198.489	Sn		45x1,5		127	31,75	27,5	22x1,5	1:8
198.490	Dx		45x1,5		127	31,75	27,5	22x1,5	1:8
221.017	Sn		46x1,5		117,5	30	27,1	24x1,5	1:10
221.018	Dx		46x1,5		117,5	30	27,1	24x1,5	1:10
221.005	Sn		48x1,5		117,5	30	27,1	24x1,5	1:10
221.006	Dx		48x1,5		117,5	30	27,1	24x1,5	1:10
221.076	Dx		48x1,5						
221.077	Sn		48x1,5						
198.483	Dx		52x1,5		130	32,35		22x1,5	1:8
198.484	Sn		52x1,5		130	32,35		22x1,5	1:8
221.015	Sn		52x1,5		119,5	28,6	23,9	20x1,5	1:6
221.016	Dx		52x1,5		119,5	28,6	23,9	20x1,5	1:6
221.029	Dx		52x1,5		117,5	30	27,1	24x1,5	1:10
221.030	Sn		52x1,5		117,5	30	27,1	24x1,5	1:10
221.048	Sn		52x1,5			30	27	24x1,5	1:10

All original equipment manufacturers numbers, symbols, pictures, models and description used in this catalogue are for reference only, and it is not implied that any part listed is the product of these manufacturers. Tutti i nostri particolari non sono originali ma con essi intercambiabili. I riferimenti originali, le figure, i modelli sono esposti a semplice titolo indicativo. La nostra produzione riporta il nostro marchio.





<p>CEI no. <b>280.082</b></p> <p>O.E.M. Ref 5129481 8273973</p>	<p><i>NESSUNA IMMAGINE - NO PICTURE</i></p>	<p><i>Modelli</i> <b>170 - 190</b></p> <p><i>Rotazione Destra / Right Rotation</i> <b>C25 - X</b></p>
<p>CEI no. <b>280.190</b></p> <p>O.E.M. Ref 42203318 8273975</p>		<p><i>Modelli</i> <b>673</b></p> <p><i>Rotazione Destra / Right Rotation</i> <b>C33 - X</b></p>
<p>CEI no. <b>280.221</b></p> <p>O.E.M. Ref 8273977</p>	<p><i>NESSUNA IMMAGINE - NO PICTURE</i></p>	<p><i>Modelli</i></p> <p><i>Rotazione Destra / Right Rotation</i> <b>C42 - X</b></p>
<p>CEI no. <b>280.223</b></p> <p>O.E.M. Ref 5130127 569309</p>	<p><i>NESSUNA IMMAGINE - NO PICTURE</i></p>	<p><i>Modelli</i> <b>110 - 150 - 160 - 184</b></p> <p><i>Rotazione Sinistra / Left Rotation</i> <b>A18 - X</b></p>
<p>CEI no. <b>280.015</b></p> <p>O.E.M. Ref 5129478 4826319</p>		<p><i>Modelli</i> <b>300 - 619 - 693 - 697</b></p> <p><i>Rotazione Sinistra / Left Rotation</i> <b>A25 - X</b></p>
<p>CEI no. <b>280.189</b></p> <p>O.E.M. Ref 4797729 4847939</p>		<p><i>Modelli</i> <b>643 - 662 - 683</b></p> <p><i>Rotazione Sinistra / Left Rotation</i> <b>A33 - X</b></p>
<p>CEI no. <b>280.186</b></p> <p>O.E.M. Ref 4797728 581610</p>		<p><i>Modelli</i> <b>682 (Motore-Engine 691)</b></p> <p><i>Rotazione Sinistra / Left Rotation</i> <b>A42 - X</b></p>

All original equipment manufacturers numbers, symbols, pictures, models and description used in this catalogue are for reference only, and it is not implied that any part listed is the product of these manufacturers. Tutti i nostri particolari non sono originali ma con essi intercambiabili. I riferimenti originali, le figure, i modelli sono esposti a semplice titolo indicativo. La nostra produzione riporta il nostro marchio.

**Kit Perni Fusi**  
*King Pin Sets*





CEI no.  
**230.015**

O.E.M. Ref  
1904696



For **Two** Wheels / Per **Due** Ruote

**CARGO - TECTOR - TECTOR Restyling**  
**60E<sub>xx</sub> - 65E<sub>xx</sub> - 75E<sub>xx</sub> - 80E<sub>xx</sub> - 85E<sub>xx</sub> - 100E<sub>xx</sub> - 180E<sub>xx</sub>**  
**Bus EuroPolis**

CEI no.  
**230.016**

O.E.M. Ref  
1904697



For **One** Wheel / Per **Una** Ruota

**CARGO - TECTOR - TECTOR Restyling**  
**120E<sub>xx</sub> - 130E<sub>xx</sub> - 150E<sub>15/18/23/27</sub> - 260E<sub>xx</sub> - 280E<sub>xx</sub> - 320E<sub>xx</sub>**

CEI no.  
**230.056**

O.E.M. Ref  
42470862



**Right** Wheel / Ruota **Destra**

**TECTOR E4**  
**120E<sub>xx</sub>**

CEI no.  
**230.057**

O.E.M. Ref  
42470863



**Left Wheel / Ruota Sinistra**

**TECTOR E4**  
**120EXX**

CEI no.  
**230.058**

O.E.M. Ref  
2995709



**Right Wheel / Ruota Destra**

**TECTOR E4**  
**140EXX - 150EXX - 160EXX**

CEI no.  
**230.059**

O.E.M. Ref  
2995710



**Left Wheel / Ruota Sinistra**

**TECTOR E4**  
**140EXX - 150EXX - 160EXX**

All original equipment manufacturer's numbers, symbols, pictures, models and description used in this catalogue are for reference only, and it is not implied that any part listed is the product of these manufacturers. Tutti i nostri particolari non sono originali ma con essi intercambiabili. I riferimenti originali, le figure, i modelli sono esposti a semplice titolo indicativo. La nostra produzione riporta il nostro marchio.

CEI no.  
**230.020**

O.E.M. Ref  
1904698  
2992185

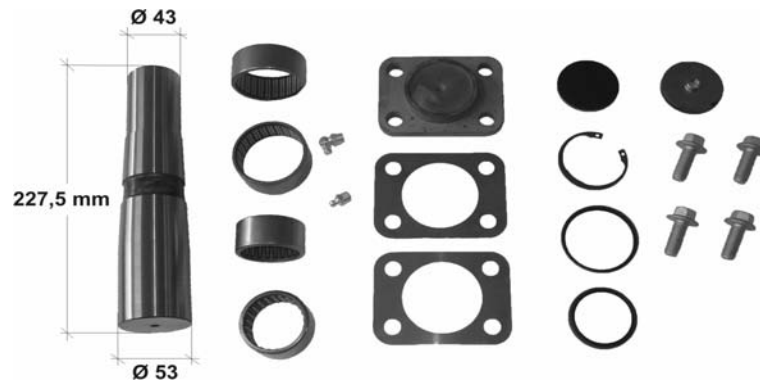

For **One** Wheel / Per **Una** Ruota

**TECH - TECH CURSOR - STAR - STAR CURSOR  
TRAKKER - TRAKKER T.CURSOR  
TRAKKER AD/AT, TRAKKER AD/AT E4  
STRALIS**

CEI no.  
**230.066**

O.E.M. Ref  
42471013



**Right** Wheel / Ruota **Destra**

**NEW STRALIS - STRALIS E4**

CEI no.  
**230.067**

O.E.M. Ref  
42471014



**Left** Wheel / Ruota **Sinistra**

**NEW STRALIS - STRALIS E4**

All original equipment manufacturers numbers, symbols, models and description used in this catalogue are for reference only, and it is not implied that any part listed is the product of these manufactures.  
Tutti i nostri particolari non sono originali ma con essi intercambiabili. I riferimenti originali, le figure, i modelli sono esposti a semplice titolo indicativo. La nostra produzione riporta il nostro marchio.

CEI no.  
230.021  
O.E.M. Ref  
681511

NESSUNA IMMAGINE - NO PICTURE

For **Two** Wheels / Per **Due** Ruote

*Models*  
**F1700 - F1900 - F2100**  
**F95**

All original equipment manufacturer's numbers, symbols, pictures, models and description used in this catalogue are for reference only, and it is not implied that any part listed is the product of these manufacturers. Tutti i nostri particolari non sono originali ma con essi intercambiabili. I riferimenti originali, le figure, i modelli sono esposti a semplice titolo indicativo. La nostra produzione riporta il nostro marchio.

CEI no.  
**230.022**  
O.E.M. Ref  
681706

CUSCINETTO / BEARING  
130.613 50x58x25



For **Two** Wheels / Per **Due** Ruote

*Models*  
**F1700 - F2100**  
**F65 - 65CF - F75 - 75CF - F85 - 85CF - F95 - 95XF**

CEI no.  
**230.060**  
O.E.M. Ref  
683499

CUSCINETTO / BEARING  
130.613 50x58x25

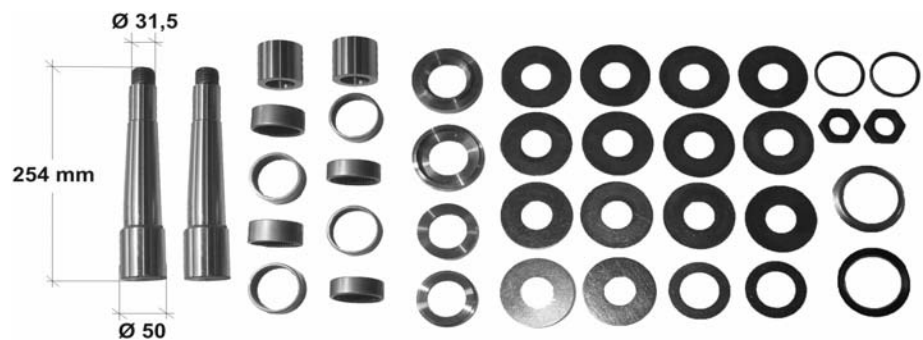

For **Two** Wheels / Per **Due** Ruote

*Models*  
**65CF - CF65 - 75CF - CF75 - 85CF - CF95 - 95XF - XF105**

CEI no.  
**230.061**

O.E.M. Ref  
683470



---

For **Two** Wheels / Per **Due** Ruote

---

*Models*

**75CF - CF75 - 85CF - CF95 - 95XF - XF105**

All original equipment manufacturers' numbers, symbols, pictures, models and description used in this catalogue are for reference only, and it is not implied that any part listed is the product of these manufacturers.  
Tutti i nostri particolari non sono originali ma con essi intercambiabili. I riferimenti originali, le figure, i modelli sono esposti a semplice titolo indicativo. La nostra produzione riporta il nostro marchio.

CEI no.

**230.074**

O.E.M. Ref  
CEI 230.074

Components

970 332 0406 Pin 1 pcs.  
plus various items



For **One** Wheel / Per **Una** Ruota

**ATEGO - NEW ATEGO** (CH 970.xxx - 972.xxx)  
**7 / 8 / 9 Ton**

CEI no.

**230.075**

O.E.M. Ref  
CEI 230.075

Components

975 332 0606 Pin 1 pcs.  
plus various items



For **One** Wheel / Per **Una** Ruota

**ATEGO - NEW ATEGO** (CH 970.xxx - 972.xxx)  
**12 / 13 / 15 Ton**

CUSCINETTO / BEARING  
130.764 38x67x22,8  
130.765 38x73x20

CEI no.

**230.068**

O.E.M. Ref  
CEI 230.068

Components

655 330 0019 1 pcs.  
655 330 0119 1 pcs.  
942 332 0006 2 pcs.



For **Two** Wheels / Per **Due** Ruote

**SK** (CH 655.xxx - 656.xxx - 658.xxx)  
**ACTROS** (CH 950.xxx - 952.xxx - 954.xxx)  
Versions with Drum Brakes / Versioni con freni a tamburo

CUSCINETTO / BEARING  
130.613 50x58x25



CEI no.

**230.069**

O.E.M. Ref  
CEI 230.069

Components

655 330 0419 1 pcs.  
655 330 0519 1 pcs.  
942 332 0006 2 pcs.



For **Two** Wheels / Per **Due** Ruote

**ACTROS** (CH 950.xxx - 952.xxx - 954.xxx)

**ACTROS MPII** (CH 930.xxx - 932.xxx)

Versions with Brake Disks / Versioni con freni a disco

CUSCINETTO / BEARING  
130.613 50x58x25  
130.850 50x78x25,5  
130.773 50x80x25

CEI no.

**230.070**

O.E.M. Ref  
CEI 230.070

Components

655 330 0619 1 pcs.  
655 330 0319 1 pcs.  
942 332 0006 2 pcs.



For **Two** Wheels / Per **Due** Ruote

**ACTROS** (CH 950.xxx - 952.xxx - 954.xxx)

**ACTROS MPII** (CH 930.xxx - 932.xxx)

Versions with Drum Brakes / Versioni con freni a tamburo

CUSCINETTO / BEARING  
130.613 50x58x25  
130.850 50x78x25,5  
130.773 50x80x25

CEI no.

**230.071**

O.E.M. Ref  
CEI 230.071

Components

942 330 0019 1 pcs.  
942 330 0119 1 pcs.  
942 332 1606 2 pcs.



For **Two** Wheels / Per **Due** Ruote

**ACTROS** (CH 950.xxx - 952.xxx - 954.xxx)

**ACTROS MPII** (CH 930.xxx - 932.xxx)

Versions with Brake Disks / Versioni con freni a disco

CUSCINETTO / BEARING  
130.850 50x78x25,5  
130.774 54x86x26

CEI no.

**230.072**

O.E.M. Ref  
CEI 230.072

Components

942 330 0219 1 pcs.

942 330 0319 1 pcs.

942 332 1906 2 pcs.



For **Two** Wheels / Per **Due** Ruote

**ACTROS** (CH 950.xxx - 952.xxx - 954.xxx)

**ACTROS MPII** (CH 930.xxx - 932.xxx)

Versions with Drum Brakes / Versioni con freni a tamburo

CUSCINETTO / BEARING

130.850 50x78x25,5

130.851 54x62x26,8

130.774 54x86x26

CEI no.

**230.073**

O.E.M. Ref  
CEI 230.073

Components

942 330 0419 1 pcs.

942 330 0519 1 pcs.

942 332 1906 2 pcs.



For **Two** Wheels / Per **Due** Ruote

**ACTROS** (CH 950.xxx - 952.xxx - 954.xxx)

**ACTROS MPII** (CH 930.xxx - 932.xxx)

Versions with Drum Brakes / Versioni con freni a tamburo

CUSCINETTO / BEARING

130.850 50x78x25,5

130.851 54x62x26,8

130.774 54x86x26

CEI no.

230.035

O.E.M. Ref

81 44205 6020

NESSUNA IMMAGINE - NO PICTURE

For **One** Wheel / Per **Una** Ruota

Models  
**L2000**

Chassis **Lxx** - Axle **V9-34/4042**

CEI no.

**230.063**

O.E.M. Ref

81 44205 6019



For **One** Wheel / Per **Una** Ruota

Models

**L2000 - M2000**

Chassis **Lxx/ Mxx** - Axle **V9-50L / V9-52L / V9-60L**

CUSCINETTO / BEARING  
130.768 42,3x67,8x17

CEI no.

**230.062**

O.E.M. Ref

81 44205 6033



For **One** Wheel / Per **Una** Ruota

Models

**L2000 - TGL**

Chassis **Lxx / Nxx** - Axle **V9-42 / VOK-03 / VOK-05**

CUSCINETTO / BEARING  
130.766 37,5x55x55

All original equipment manufacturers numbers, symbols, pictures, models and description used in this catalogue are for reference only, and it is not implied that any part listed is the product of these manufactures. Tutti i nostri particolari non sono originali ma con essi intercambiabili. I riferimenti originali, le figure, i modelli sono esposti a semplice titolo indicativo. La nostra produzione riporta il nostro marchio.

CEI no.

230.036

O.E.M. Ref

81 44205 6018

NESSUNA IMMAGINE - NO PICTURE

For **One** Wheel / Per **Una** Ruota

Models

**M90 - M2000**

Chassis **Mxx** - Axle **V7-42**

CEI no.

**230.064**

O.E.M. Ref

81 44205 6034

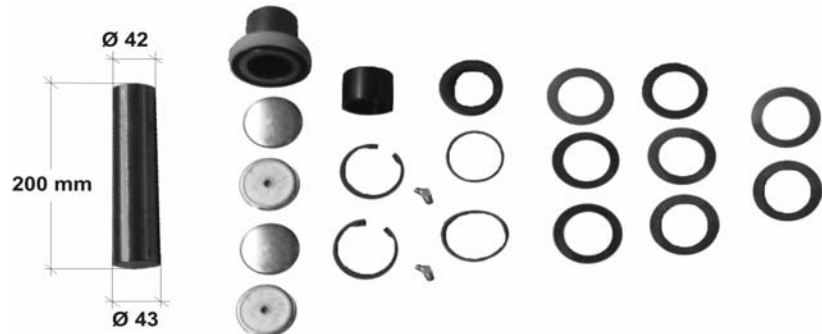

For **One** Wheel / Per **Una** Ruota

Models

**TGM**

Chassis **Nxx** - **VOK-06**

CUSCINETTO / BEARING

130.771 42x69,5x64

CEI no.

**230.017**

O.E.M. Ref

81 44205 6013

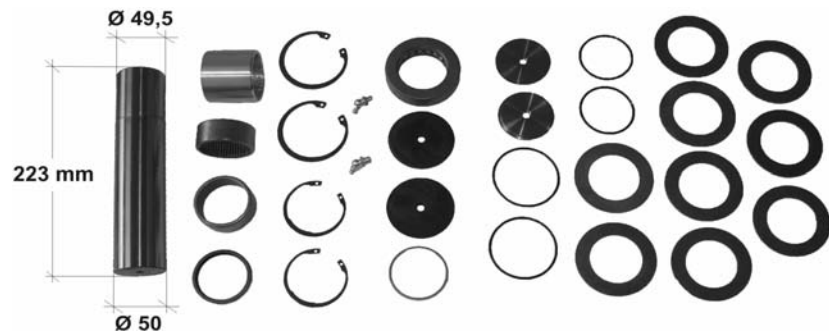

For **One** Wheel / Per **Una** Ruota

Models

**M90 - M2000 - F90 - F2000**

Chassis **Mxx** / **Fxx** / **Txx** / **Uxx**

Axle **V7-80** - Axle **V9-65/75/80**

CUSCINETTO / BEARING

130.316 50,5x78x22

130.613 50x58x25

CEI no.

**230.037**

O.E.M. Ref

81 44205 6023

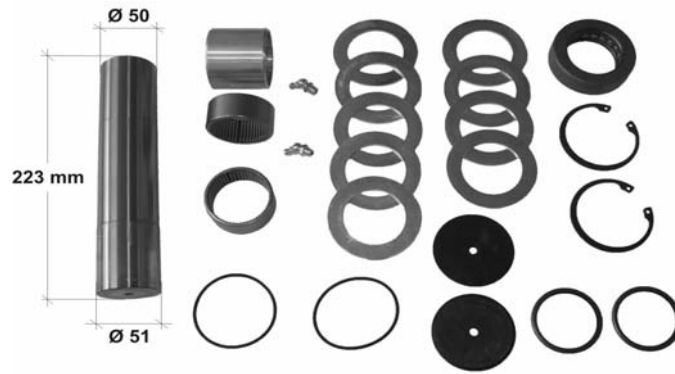

For **One** Wheel / Per **Una** Ruota

CUSCINETTO / BEARING  
130.316 50,5x78x22  
130.613 50x58x25

*Models*

**M2000 - F2000**

Chassis **Mxx / Txx** - Axle **V7-72 - V9-82**

CEI no.

**230.038**

O.E.M. Ref

81 44205 6030



For **One** Wheel / Per **Una** Ruota

CUSCINETTO / BEARING  
130.612  
D.52x60,5/94x77

*Models*

**F2000 - TGA**

Chassis **Txx / Hxx** - Axle **VOK-07/08/09**

All original equipment manufacturers' numbers, symbols, pictures, models and description used in this catalogue are for reference only, and it is not implied that any part listed is the product of these manufacturers.  
Tutti i nostri particolari non sono originali ma con essi intercambiabili. I riferimenti originali, le figure, i modelli sono esposti a semplice titolo indicativo. La nostra produzione riporta il nostro marchio.

CEI no.

**230.008**

O.E.M. Ref  
50 00 336 305

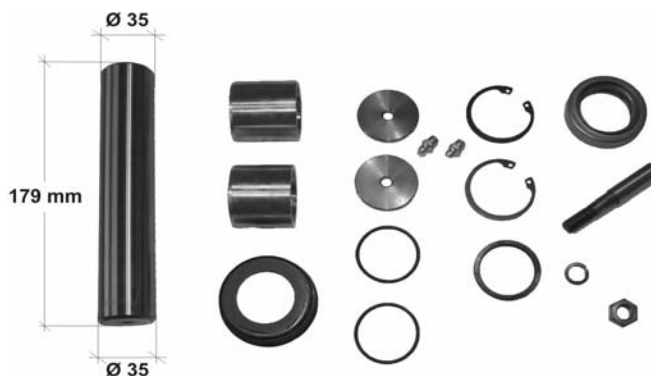

For **One** Wheel / Per **Una** Ruota

*Models*

**JP-JE-JR 13/15/19/21**

**M-S 130/150/160/170/180/210**

**M-S 4X4**

CUSCINETTO / BEARING

130.300

35,45x53x12/15,5

CEI no.

**230.009**

O.E.M. Ref  
50 00 336 306

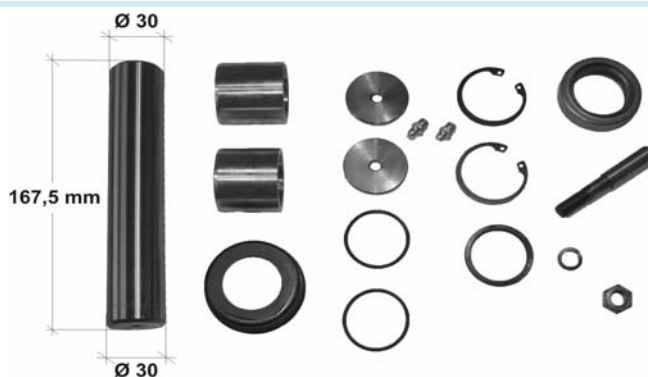

For **One** Wheel / Per **Una** Ruota

*Models*

**JN 55/60/85**

**M-S 100/120/130/135/140/150(TI)/160/170/180/210/220/230(TI)/250**

**PS 150/160 - MIDLINER**

CUSCINETTO / BEARING

130.301

30,45x48x12/15

CEI no.

**230.011**

O.E.M. Ref  
50 00 793 641



For **One** Wheel / Per **Una** Ruota

*Models*

**JK 55/60/65/75**

**M-S 100/110/120/130/135/140/150(TI)/160/170/180/210/220/230(TI)/250**

**MIDLINER**

CUSCINETTO / BEARING

130.302

30,45x48x12/15



CEI no.

**230.010**

O.E.M. Ref  
50 00 794 185



For **One** Wheel / Per **Una** Ruota

CUSCINETTO / BEARING  
130.300  
35,45x53x12/15,5

*Models*

**M-S 140/150(TI)/160/180/200/210/220/230(TI)/250**  
**PA 200/210 - MIDLINER**

CEI no.

**230.079**

O.E.M. Ref  
CEI 230.079

Con Perno / With Pin  
50 10 630 992 1 pcs.



For **One** Wheel / Per **Una** Ruota

CUSCINETTO / BEARING  
130.777 45,3x72x20

*Models*

**M-S 150/170/180/200/210/220/230(TI)/250**  
**MIDLUM - MIDLUM (DXI)**

CEI no.

**230.078**

O.E.M. Ref  
CEI 230.078

Con Perno / With Pin  
50 10 630 991 1 pcs.

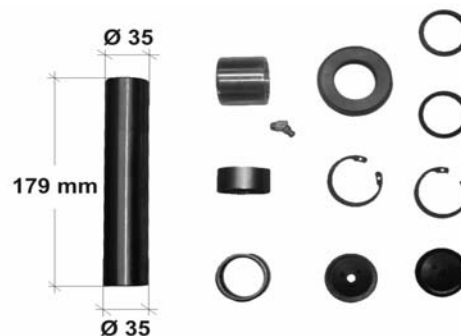

For **One** Wheel / Per **Una** Ruota

CUSCINETTO / BEARING  
130.776 35,5x61,5x17

*Models*

**MIDLUM - MIDLUM (DXI)**

CEI no.  
**230.001**

O.E.M. Ref  
50 00 794 319

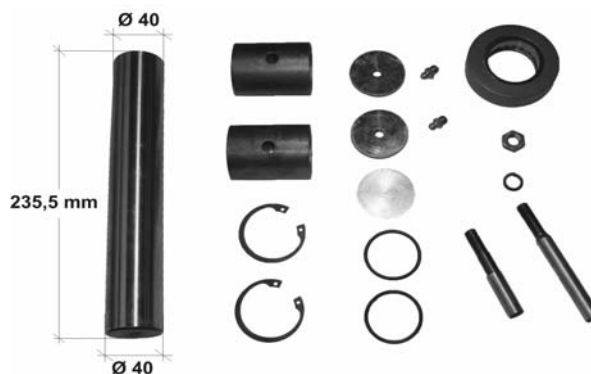

For **One** Wheel / Per **Una** Ruota

CUSCINETTO / BEARING  
130.292 40x72,6x19

*Models*

**G 210/230/260/270/290**

**GLC-GLR 190/230**

CEI no.  
**198.676**

O.E.M. Ref  
50 00 794 320



For **One** Wheel / Per **Una** Ruota

CUSCINETTO / BEARING  
130.287 46x83x24

*Models*

**C 210/230/260/290 - CLR 190/220 - GR 191/231**

**CBH 280/340/350/380**

**"R" 310/330/340/365 Dal/From 84' - "R" 370/390/420 Dal/From 89'**

CEI no.  
**230.004**

O.E.M. Ref  
50 00 793 828



For **One** Wheel / Per **Una** Ruota

CUSCINETTO / BEARING  
130.292 40x72,6x19

*Models*

**C 230/280 - GLC/GLR 190/230**

**G 200/210/220/230/270/32**

**G "MANAGER" 4X2 / 6X2 / 6X4**

CEI no.

**230.002**

O.E.M. Ref  
50 00 793 849



For **One** Wheel / Per **Una** Ruota

CUSCINETTO / BEARING  
130.293 46x78x22

*Models*

**C** 210/220/230/260/290/300/340TI - **CBH/CLM** 280/320/340/350/385  
**G** 200/210/220/230/260/270/290 - **GR** 191/231 - **GRH/TRH** 305/350  
**G** "MANAGER" 4X2 / 6X2 / 6X4 - **"R"** Fino/Up to 92' - **"R"** Dal/From to 93'

CEI no.

**230.012**

O.E.M. Ref  
CEI 230.012

Con Perno / With Pin  
50 10 056 002 1 pcs.



For **One** Wheel / Per **Una** Ruota

CUSCINETTO / BEARING  
130.303 50x80x22  
130.613 50x58x25

*Models*

**G** 260/290 - **"R"** Dal/From 90 al/Up to to 92' - **"R"** Dal/From to 93'  
**PREMIUM - MAGNUM (AE) - MAXTER - KERAX**  
**BUS TRACER**

CEI no.

**230.014**

O.E.M. Ref  
CEI 230.014

Con Perno / With Pin  
50 10 216 742 1 pcs.



For **One** Wheel / Per **Una** Ruota

CUSCINETTO / BEARING  
130.303 50x80x22  
130.613 50x58x25

*Models*

**MIDLUM**  
**PREMIUM**  
**MAGNUM (AE)**

CEI no.

**230.080**

O.E.M. Ref  
CEI 230.080

Con Perno / With Pin  
50 10 630 993 1 pcs.

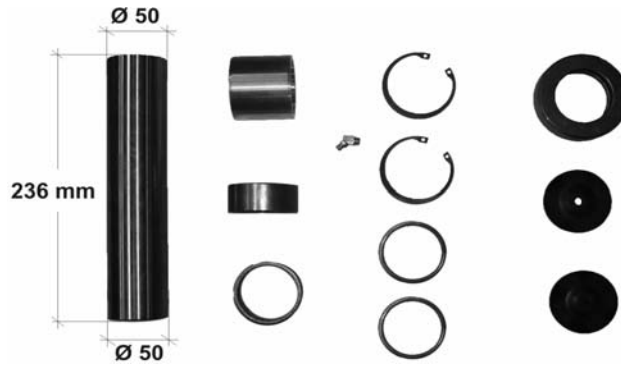

For **One** Wheel / Per **Una** Ruota

CUSCINETTO / BEARING  
130.303 50x80x22  
130.613 58x50x25

Models  
**MIDLUM**  
**PREMIUM**  
**MAGNUM (AE)**

CEI no.

**230.081**

O.E.M. Ref  
CEI 230.081

Con Perno / With Pin  
74 20 590 486 1 pcs.

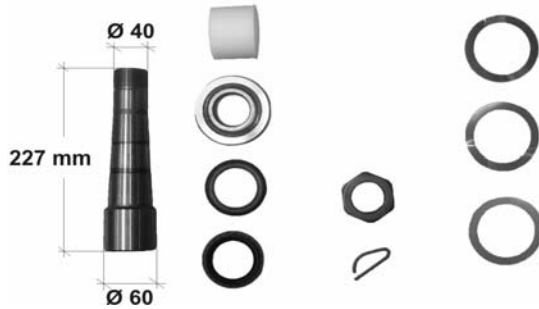

For **One** Wheel / Per **Una** Ruota

CUSCINETTO / BEARING  
130.778 40x90x39

Models  
**PREMIUM (TR/PR) - MAGNUM (DXI) - KERAX (DXI)**  
*Ultime generazioni / Latest generation*

CEI no.

**198.654**

O.E.M. Ref  
50 00 556 940



For **One** Wheel / Per **Una** Ruota

Models  
**BUS**  
**S-45 / S-53 / S-53RX / S-105R**

CEI no.

230.082

O.E.M. Ref

CEI 230.082

Con Perno / With Pin

50 01 839 873 1 pcs.

*NESSUNA IMMAGINE - NO PICTURE*

---

For **One** Wheel / Per **Una** Ruota

---

*Models*

**BUS**

**RECREO**

All original equipment manufacturers' numbers, symbols, pictures, models and description used in this catalogue are for reference only, and it is not implied that any part listed is the product of these manufacturers.  
Tutti i nostri particolari non sono originali ma con essi intercambiabili. I riferimenti originali, le figure, i modelli sono esposti a semplice titolo indicativo. La nostra produzione riporta il nostro marchio.

CEI no.  
**198.533**

O.E.M. Ref  
550733  
550723  
550711

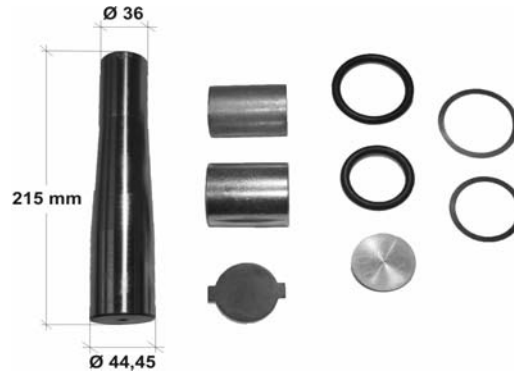

For **One** Wheel / Per **Una** Ruota

*Models*

**1 & 2 Series - Axle AM55**

L/LS/LBS 80-81-82 - L/LB/LS/LBS/LBT 110/140/111/141 - LT 146  
G/P/R/T 92 - 112 - 142

CEI no.  
**198.377**

O.E.M. Ref  
550732  
550714  
550713



For **One** Wheel / Per **Una** Ruota

**1 & 2 Series - Axle AM60**

L/LS/LBS 80-81-82 - L/LB/LS/LBS/LBT 110/140/111/141 - LT 146  
G/P/R/T 92 - 112 - 142

CEI no.  
**198.619**

O.E.M. Ref  
550730  
550729

CUSCINETTO / BEARING  
130.286 40x90x35,25



For **One** Wheel / Per **Una** Ruota

**3 Series - Axle AM56 - AM61**

G/P/R/T 93 - 113 - 143

Bus K 113

Senza Cuscinetto vedi  
W/out bearing see

**230.006**



CEI no.  
**230.006**  
O.E.M. Ref  
CEI 230.006

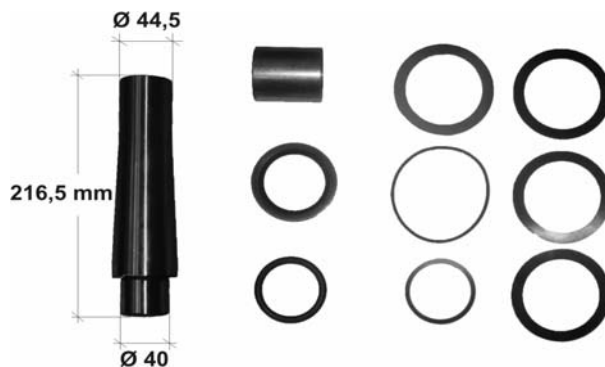

For **One** Wheel / Per **Una** Ruota

Con Cuscinetto vedi  
With bearing see  
**198.619**

*Models*  
**3 Series - Axle AM56 - AM61**  
G/P/R/T 93 - 113 - 143  
Bus K 113

CEI no.  
**230.039**

O.E.M. Ref  
550722



For **One** Wheel / Per **Una** Ruota

CUSCINETTO / BEARING  
130.286 40x90x35,25

*Models*  
**3 Series - Axle AM70**  
G/P/R/T 93 - 113 - 143 - Bus K 113  
1a Generazione / 1st Generation

CEI no.  
**230.040**

O.E.M. Ref  
550731



For **One** Wheel / Per **Una** Ruota

CUSCINETTO / BEARING  
130.286 40x90x35,25

*Models*  
**3 Series - Axle AM70**  
G/P/R/T 93 - 113 - 143 - Bus K 113  
2a Generazione / 2nd Generation

All original equipment manufacturers numbers, symbols, pictures, models and description used in this catalogue are for reference only, and it is not implied that any part listed is the product of these manufactures.  
Tutti i nostri particolari non sono originali ma con essi intercambiabili. I riferimenti originali, le figure, i modelli sono esposti a semplice titolo indicativo. La nostra produzione riporta il nostro marchio.

CEI no.  
**230.005**

O.E.M. Ref  
550257

CUSCINETTO / BEARING  
130.286 40x90x35,25

Senza Cuscinetto vedi  
W/out bearing see

**230.018**



For **One** Wheel / Per **Una** Ruota

Models

**4 Series - Axle AMIAMA 620-740-800-820-860-920**  
G/P/R/T 94 - 114 - 124 - 144 - 164  
1a Generazione / 1st Generation

CEI no.  
230.018

O.E.M. Ref  
CEI 230018

Con Cuscinetto vedi  
With bearing see

**230.005**



For **One** Wheel / Per **Una** Ruota

Models

**4 Series - Axle AMIAMA 620-740-800-820-860-920**  
G/P/R/T 94 - 114 - 124 - 144 - 164  
1a Generazione / 1st Generation

CEI no.  
**230.013**

O.E.M. Ref  
550284

CUSCINETTO / BEARING  
130.286 40x90x35,25

Senza Cuscinetto vedi  
W/out bearing see

**230.019**



For **One** Wheel / Per **Una** Ruota

**4 Series - PIR Series**

**Axle AMIAMA 620-740-800-820-860-920**  
G/P/R/T 94-114-124-144-164 -- P/R 340-380-420-480-500-560-620  
2a Generazione / 2nd Generation

CEI no.  
230.019  
O.E.M. Ref  
CEI 230019

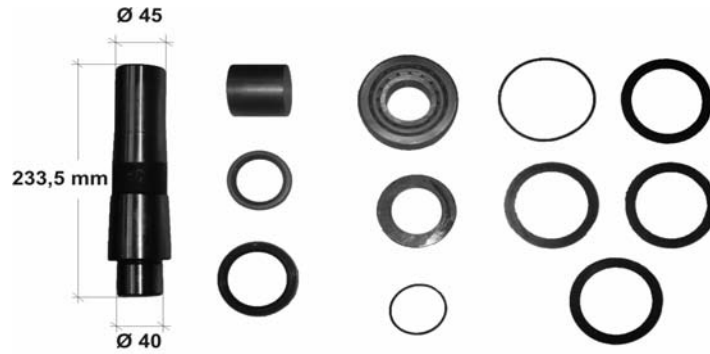

For **One** Wheel / Per **Una** Ruota

**4 Series - PIR Series**

**Axle AMIAMA 620-740-800-820-860-920**

**G/P/R/T 94-114-124-144-164 -- P/R 340-380-420-480-500-560-620**  
**2a Generazione / 2nd Generation**

Con Cuscinetto vedi  
With bearing see  
**230.013**

CEI no.  
230.041  
O.E.M. Ref  
1405343

**NESSUNA IMMAGINE - NO PICTURE**

For **One** Wheel / Per **Una** Ruota

**4 Series - PIR Series**

**Axle AMIAMA 620-740-800-820-860-920**

**G/P/R/T 94-114-124-144-164 -- P/R 340-380-420-480-500-560-620**  
**Kit Revisione Cuscinetto / Bearing Update Kit**

All original equipment manufacturers numbers, symbols, pictures, models and description used in this catalogue are for reference only, and it is not implied that any part listed is the product of these manufactures.  
Tutti i nostri particolari non sono originali ma con essi intercambiabili. I riferimenti originali, le figure, i modelli sono esposti a semplice titolo indicativo. La nostra produzione riporta il nostro marchio.

CEI no.  
**230.042**

O.E.M. Ref  
270920



For **One** Wheel / Per **Una** Ruota

*Models*

**FL 6 - FL 6.08 - 6.11**

*La versione originale non prevede il cuscinetto  
Original version does not include bearing*

CEI no.  
**230.044**

O.E.M. Ref  
276193



For **One** Wheel / Per **Una** Ruota

*Models*

**FL 6 - FL 6.12 - 6.15**

*La versione originale non prevede il cuscinetto  
Original version does not include bearing*

CEI no.  
**198.387**

O.E.M. Ref  
276029  
276014



For **One** Wheel / Per **Una** Ruota

*Models*

**F 86 - F 87 - F 88 - F 89 - N 86 - N 88**

**N 7 - N 10 - N 12**

Con Cuscinetto vedi  
With bearing see

**198.570**

CEI no.

198.570

O.E.M. Ref  
CEI 198.570

CUSCINETTO / BEARING  
130.364  
44,45x95,2530,95

Senza Cuscinetto vedi  
W/out bearing see

**198.387**



For **One** Wheel / Per **Una** Ruota

*Models*

**F 86 - F 87 - F 88 - F 89 - N 86 - N 88**  
**N 7 - N 10 - N 12**

CEI no.

**198.385**

O.E.M. Ref  
3090267  
276032  
276030  
276024

Con Cuscinetto vedi  
With bearing see

**198.568**



For **One** Wheel / Per **Una** Ruota

*Models*

**F 7 - FL 7 - FS 7 - F 10 - F 12 - F 16 - FL 10 - FL 12**  
**Buses B 7 - B 7R - B 9M - B 10M**

CEI no.

**198.568**

O.E.M. Ref  
CEI 198.568

CUSCINETTO / BEARING  
130.364  
44,45x95,2530,95

Senza Cuscinetto vedi  
W/out bearing see

**198.385**



For **One** Wheel / Per **Una** Ruota

*Models*

**F 7 - FL 7 - FS 7 - F 10 - F 12 - F 16 - FL 10 - FL 12**  
**Buses B 7 - B 7R - B 9M - B 10M**

CEI no.  
**198.386**

O.E.M. Ref  
3090266  
276023  
271142  
270912



For **One** Wheel / Per **Una** Ruota

Con Cuscinetto vedi  
With bearing see

**198.569**

*Models*

FL 7 - FS 7 - F 10 - F 12 - F 16 - FL 10 - FL 12  
FH 12 - FH 16 - FM 7 - FM 10 - FM 12  
Buses B 9M - B 10M - B 10B - B 10L - B 12

CEI no.  
**198.569**

O.E.M. Ref  
CEI 198.569

CUSCINETTO / BEARING  
**130.285**  
**38,1x90x35,25**



For **One** Wheel / Per **Una** Ruota

Senza Cuscinetto vedi  
W/out bearing see

**198.386**

*Models*

FL 7 - FS 7 - F 10 - F 12 - F 16 - FL 10 - FL 12  
FH 12 - FH 16 - FM 7 - FM 10 - FM 12  
Buses B 9M - B 10M - B 10B - B 10L - B 12

CEI no.  
**230.045**

O.E.M. Ref  
3092467



For **One** Wheel / Per **Una** Ruota

*Models*

FH 12 - FH 16 - FM 7 - FM 9 - FM 10 - FM 12 Buses B 12  
Per 1a serie con fuso 1076305 / For 1st generation haning 1076305 knuckle



CEI no.  
**230.043**

O.E.M. Ref  
3093731



For **One** Wheel / Per **Una** Ruota

*Models*

**FH 12 - FH 16 - FM 7 - FM 9 - FM 10 - FM 12 Buses B 12**  
Per 2a serie con fuso 3173778 / For 2nd generation haning 3173778 knuckle

CEI no.  
**230.065**

O.E.M. Ref  
85108338



For **One** Wheel / Per **Una** Ruota

*Models*

**FH 12 - FH 16 - FM 7 - FM 9 - FM 10 - FM 12**  
*Ultime generazioni / Latest Generation*

CEI no.  
**230.076**

O.E.M. Ref  
20751021



For **One** Wheel / Per **Una** Ruota

*Models*

**FH 12 - FH 16 - FM 7 - FM 9 - FM 10 - FM 12 Buses B 12**  
*Ultime generazioni / Latest Generation*

CUSCINETTO / BEARING  
130.779 40x90x40,5  
130.780 53x72x28

All original equipment manufacturers numbers, symbols, pictures, models and description used in this catalogue are for reference only, and it is not implied that any part listed is the product of these manufactures. Tutti i nostri particolari non sono originali ma con essi intercambiabili. I riferimenti originali, le figure, i modelli sono esposti a semplice titolo indicativo. La nostra produzione riporta il nostro marchio.

CEI no.

**230.077**

O.E.M. Ref  
CEI 230.077

Con Perno / With Pin  
20390834 1 pcs.

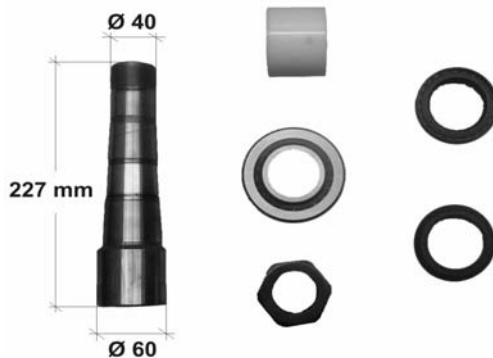

For **One** Wheel / Per **Una** Ruota

CUSCINETTO / BEARING  
130.778 40x90x39

*Models*

**FH 12 - FH 16 - FM 7 - FM 9 - FM 10 - FM 12 Buses B 12**  
*Ultime generazioni / Latest Generation*

CEI No	Suitable to	L. mm	∅	CEI No	Suitable to	L. mm	∅
230.060	DAF	254,00	31,50x50	230.012	RENAULT V.I.	225,50	50
230.061	DAF	267,00	40,50x55	230.081	RENAULT V.I.	227,00	40x60
230.022	DAF	271,00	31,50x50	230.001	RENAULT V.I.	235,50	40
230.056	IVECO	175,00	33x40	230.080	RENAULT V.I.	236,00	50
230.057	IVECO	175,00	33x40	230.014	RENAULT V.I.	236,50	50
230.015	IVECO	178,00	28x35	230.004	RENAULT V.I.	241,00	40
230.016	IVECO	199,00	35x43	198.654	RENAULT V.I.	257,00	30x38,25
230.058	IVECO	199,00	35x43	198.676	RENAULT V.I.	280,00	46
230.059	IVECO	199,00	35x43	230.002	RENAULT V.I.	280,00	46
230.066	IVECO	224,50	43x53	198.533	SCANIA	215,00	36x44,45
230.067	IVECO	224,50	43x53	198.619	SCANIA	216,50	44,5x40
230.020	IVECO	227,50	43x53	230.006	SCANIA	216,50	44,5x40
230.062	MAN	173,00	38x39	230.005	SCANIA	223,50	45x40
230.064	MAN	200,00	42x43	230.013	SCANIA	223,50	45x40
230.063	MAN	202,00	41,50x42	230.018	SCANIA	223,50	45x40
230.017	MAN	223,00	49,50x50	198.377	SCANIA	229,00	44,45x53,5
230.037	MAN	223,00	50x51	230.019	SCANIA	233,50	45x40
230.038	MAN	235,00	52x53	230.039	SCANIA	244,00	45x40
230.074	MERCEDES	188,00	30x38	230.040	SCANIA	244,00	45x40
230.068	MERCEDES	223,00	50	230.042	VOLVO	192,50	35x45
230.069	MERCEDES	223,00	50	230.044	VOLVO	220,50	35x45
230.070	MERCEDES	223,00	50	230.045	VOLVO	222,50	40x51
230.071	MERCEDES	223,00	54	230.065	VOLVO	227,00	40x60
230.075	MERCEDES	226,00	38	230.077	VOLVO	227,00	40x60
230.072	MERCEDES	237,00	54	230.043	VOLVO	232,00	40x60
230.073	MERCEDES	237,00	54	198.385	VOLVO	237,00	37x48
230.011	RENAULT V.I.	153,50	28	198.387	VOLVO	237,00	34x45
230.009	RENAULT V.I.	167,50	30	198.568	VOLVO	237,00	37x48
230.008	RENAULT V.I.	179,00	35	198.570	VOLVO	237,00	34x45
230.010	RENAULT V.I.	179,00	35	230.076	VOLVO	237,50	40x60
230.078	RENAULT V.I.	179,00	35	198.386	VOLVO	251,50	38x50
230.079	RENAULT V.I.	214,00	50	198.569	VOLVO	251,50	38x50

All original equipment manufacturers' numbers, symbols, pictures, models and description used in this catalogue are for reference only, and it is not implied that any part listed is the product of these manufacturers.  
 Tutti i nostri particolari non sono originali ma con essi intercambiabili. I riferimenti originali, le figure, i modelli sono esposti a semplice titolo indicativo. La nostra produzione riporta il nostro marchio.

**Sospensione**

*Suspension*



CEI no.

**198.573**

O.E.M. Ref  
4716271

**Barra a V / V-Stay**

Size / Misure

L = 690 mm

L 1 = 658 mm

Tube Ø 50 mm

**Note**

Uguale alla 198.695 ma con i bracci invertiti / Same as 198.695 but with inverted arms



**Kit A**

**198.639**

2968454



**Kit B W/Pin**

**198.612**

2980884

**Kit B W/out Pin**

**198.699**

CEI

**Models TURBO**

190.30 - 190.38 - 220.38 - 240.30

**TurboStar** 190.32 - 190.36 - 190.42 - 190.48

**TurboTech** 190.26 - 190.32 - 190.36 - 220.32 - 220.36 - 240.32 - 240.36

CEI no.

**198.695**

O.E.M. Ref  
4716799

**Barra a V / V-Stay**

Size / Misure

L = 658 mm

L 1 = 690 mm

Tube Ø 50 mm

**Note**

Uguale alla 198.573 ma con i bracci invertiti / Same as 198.573 but with inverted arms



**Kit A**

**198.639**

2968454



**Kit B W/Pin**

**198.612**

2980884

**Kit B W/out Pin**

**198.699**

CEI

**Models TURBO**

**TurboTech** 240.32 - 240.36

All original equipment manufacturers numbers, symbols, pictures, models and description used in this catalogue are for reference only, and it is not implied that any part listed is the product of these manufactures. Tutti i nostri particolari non sono originali ma con essi intercambiabili. I riferimenti originali, le figure, i modelli sono esposti a semplice titolo indicativo. La nostra produzione riporta il nostro marchio.





CEI no.  
225.027

O.E.M. Ref  
41034479  
41028600

Usa / Use  
**225.001**

Barra a V / V-Stay

Size / Misure  
L = 665 mm  
L1 = 665 mm  
Tube Ø 46 mm

Note

Progetto / Project  
TRW



**Kit A**  
226.049  
93162240

**Only Plate**  
190.418  
42535269



**Kit B**  
**226.022**  
93161960

Models **TECH - TECH CURSOR - STAR - STAR CURSOR**

Models **STRALIS - STRALIS E4 - NEW STRAILS 2007**

**EuroTech Tutti/All - EuroStar Tutti/All - Stralis Tutti/All**

La 1a generazione **41009665** usa kits laterali aventi fori da Ø 19mm (**226.006**)

1st generation **41009665** uses lateral kits having Ø 19 mm holes (**226.006**)

CEI no.  
**225.048**

O.E.M. Ref  
CEI 225.048

**Lunga Durata**  
**Long Life**

Barra a V / V-Stay

Size / Misure  
L = 665 mm  
L1 = 665 mm  
Tube Ø 46 mm

Note

Progetto / Project CEI



**Kit B**  
**198.968**  
CEI

**MODIFICA / MODIFICATION**  
**RINFORZATA / REINFORCED**



**Kit B**  
**226.022**  
93161960

Models **TECH - TECH CURSOR - STAR - STAR CURSOR**

Models **STRALIS - STRALIS E4 - NEW STRAILS 2007**

**EuroTech Tutti/All - EuroStar Tutti/All - Stralis Tutti/All**

La 225.048 sostituisce la 225.001 (Lemf) e la 225.027(Trw)

225.048 replaces 225.001 (Lemf) and 225.027(Trw)

All original equipment manufacturers numbers, symbols, pictures, models and description used in this catalogue are for reference only, and it is not implied that any part listed is the product of these manufacturers. Tutti i nostri particolari non sono originali ma con essi intercambiabili. I riferimenti originali, le figure, i modelli sono esposti a semplice titolo indicativo. La nostra produzione riporta il nostro marchio.

CEI no.  
**225.192**

O.E.M. Ref  
41042093  
500340451

**Barra a V / V-Stay**

Size / Misure  
L = 665 mm  
L 1 = 665 mm  
Tube Ø 46 mm

**Note**

Progetto / Project  
LEMFORDER

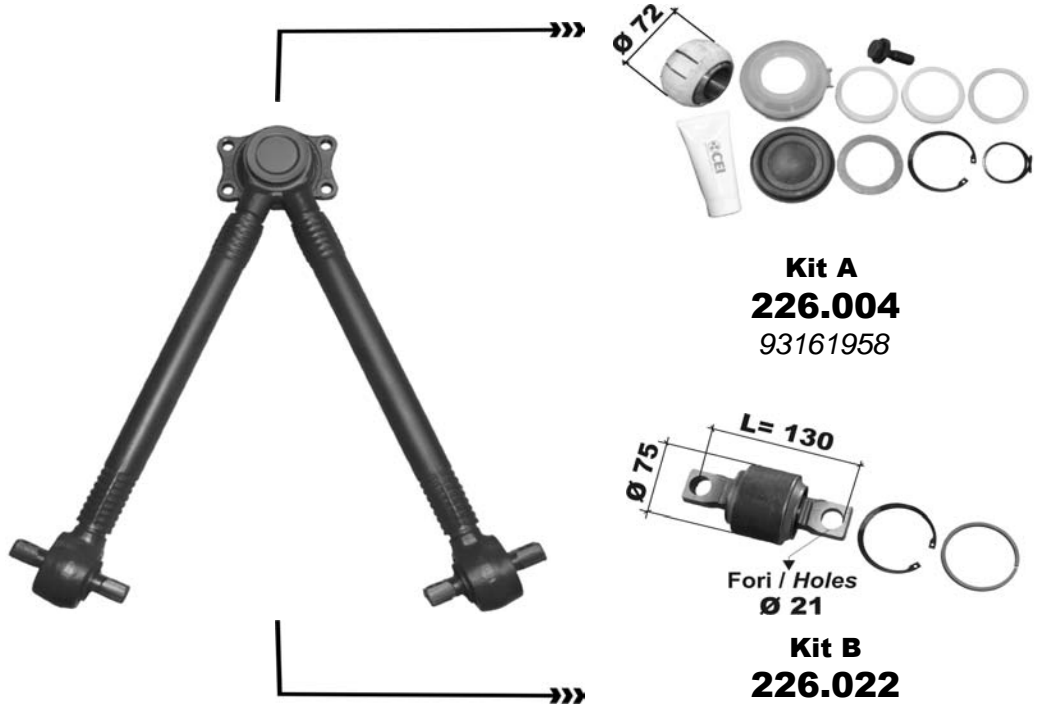

**Kit A**  
**226.004**  
93161958

**Kit B**  
**226.022**  
93161960

Models **TECH CURSOR - STAR CURSOR**  
Models **STRALIS - STRALIS E4 - NEW STRAILS 2007**  
**190E31/35/39/43 - 190S27/31/33/36/40/42/43/45/48/50**  
**260S31/33/36/40/42/43**

CEI no.  
225.065

O.E.M. Ref  
41033731

**Barra 1**  
Dx / Rh

CEI no.  
225.066

O.E.M. Ref  
41009961

**Barra 2**  
Sx / Lf

Tube Ø 52 mm

**Note**

Progetto / Project  
TRW

NESSUNA IMMAGINE - NO PICTURE

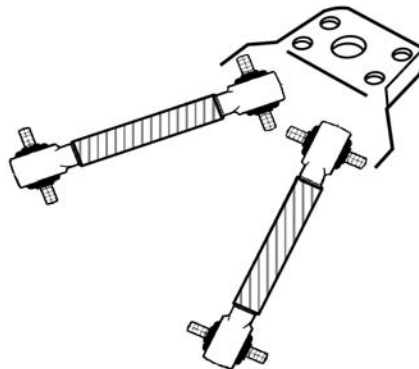

**Kit B**  
**226.006**  
93192361



**Kit A**  
**226.006**  
93192361

Models **TECH - TECH CURSOR - STAR - STAR CURSOR**  
Models **STRALIS - STRALIS E4 - NEW STRAILS 2007**  
**EuroTech 440E34/35/38/39/42/43**  
**EuroStar 440E35/38/39/42/43/47**  
**Stralis 440S40/42/43/45/48/54/56**

All original equipment manufacturer's numbers, symbols, pictures, models and description used in this catalogue are for reference only, and it is not implied that any part listed is the product of these manufactures. Tutti i nostri particolari non sono originali ma con essi intercambiabili. I riferimenti originali, le figure, i modelli sono esposti a semplice titolo indicativo. La nostra produzione riporta il nostro marchio.

CEI no.

**189.324**

O.E.M. Ref

4670853

4626261

**Barra / Arm**

**Models OLD Range**

**Size / Misure**

693 - 697

**L = 610 mm**

300PC/PT



CEI no.

**225.012**

O.E.M. Ref

41011006

42065332

**Barra / Arm**

**Size / Misure**

**L = 610 mm**

**Tube Ø 58 mm**

**Models OLD Range**

330.26H - 330.30H/N/NW

330.35H - 330.36H



**Repair Kit**



**226.025**

42493431

CEI no.

225.070

O.E.M. Ref

42041107

41011008

**Barra / Arm**

**Size / Misure**

**L = 610 mm**

**Tube Ø 50 mm**

**Models OLD Range**

260.23AH/AHB - 260.25AH - 260.34AH

300.32AH/34AH - 330.30AH/34H/36AH - 330.30N/AN/ANW - 340.34AH

NESSUNA IMMAGINE - NO PICTURE

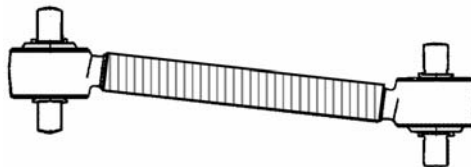

**Repair Kit**

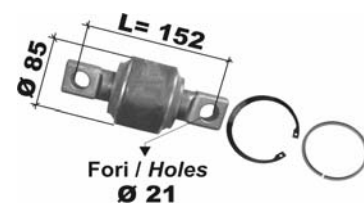

**226.011**

93192618

CEI no.

**198.572**

O.E.M. Ref  
4714134

**Barra / Arm**  
**Size / Misure**  
**L = 582 mm**  
**Tube Ø 48 mm**

**Note**

*Intercambiabile con*  
*Interchangeable with*

**198.641**

Progetto / Project  
LEMFORDER



**Repair Kit**



**198.612**  
2980884

**Repair Kit W/OUT PIN**



**198.699**  
CEI

**Models TURBO**

190.30 - 190.38 - 220.38 - 240.30

**TurboStar** 190.33 - 190.36 - 190.42 - 190.48

**TurboTech** 190.26 - 190.32 - 190.36 - 220.32 - 220.36 - 240.32 - 240.36

CEI no.

**198.641**

O.E.M. Ref  
42125057

**Barra / Arm**  
**Size / Misure**  
**L = 582 mm**  
**Tube Ø 48 mm**

**Note**

*Intercambiabile con*  
*Interchangeable with*

**198.572**

Progetto / Project  
EHRENREICH



**Repair Kit**



**198.640**  
93161371

**Repair Kit W/OUT PIN**



**198.644**  
CEI

**Models TURBO**

190.30 - 190.38 - 220.38 - 240.30

**TurboStar** 190.33 - 190.36 - 190.42 - 190.48

**TurboTech** 190.26 - 190.32 - 190.36 - 220.32 - 220.36 - 240.32 - 240.36

All original equipment manufacturer's numbers, symbols, pictures, models and description used in this catalogue are for reference only, and it is not implied that any part listed is the product of these manufacturers. Tutti i nostri particolari non sono originali ma con essi intercambiabili. I riferimenti originali, le figure, i modelli sono esposti a semplice titolo indicativo. La nostra produzione riporta il nostro marchio.

CEI no.

**225.002**

O.E.M. Ref  
98472466  
41009661  
41035951  
8137027

Barra / Arm  
Size / Misure  
L = 595 mm  
Tube Ø 46 mm



**Repair Kit**

**226.006**

93192361

Models **CARGO-TECH-TECH CURSOR-STAR-STAR CURSOR**

Models **STRALIS - STRALIS E4 - NEW STRAILS 2007**

EuroCargo 120E15/18/23 - 130E15/18/23 - 150E15/18/23/27 - 170E18/23/27

EuroCargo 260E23 - 280E23 - 320E27

EuroTech Tutti/All - EuroStar Tutti/All - Stralis Tutti/All

CEI no.

225.178

O.E.M. Ref  
500340452  
41034330

Barra / Arm  
Size / Misure  
L = 594 mm

NESSUNA IMMAGINE - NO PICTURE

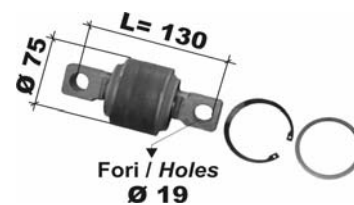
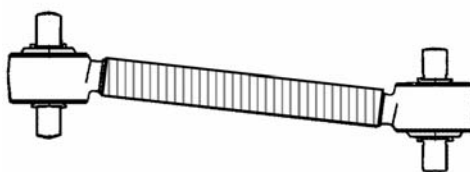

**Repair Kit**

**226.006**

93192361

Models **TECH - TECH CURSOR - STAR - STAR CURSOR**

Models **STRALIS - STRALIS E4 - NEW STRAILS 2007**

EuroTech 440E34/35/38/39/42/43

EuroStar 440E35/38/39/42/43/47

Stralis 440S40/42/43/45/48/54/56

CEI no.

225.070

O.E.M. Ref  
42041107  
41011008

Barra / Arm  
Size / Misure  
L = 610 mm  
Tube Ø 50 mm

4 o 6 pezzi per assale / 4 or 6 pcs. For axle

NESSUNA IMMAGINE - NO PICTURE

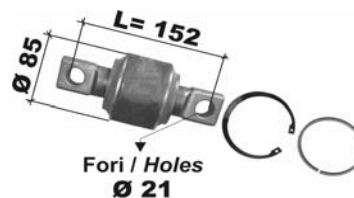
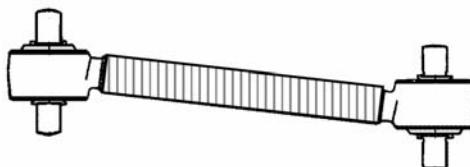

**Repair Kit**

**226.011**

93192618

Models **TECH - STAR - TRAKKER**

Models **TRAKKER T.CURSOR - TRAKKER ADIAT E4**

EuroTech 240E34/38 - 260E42 - 440E38/42

EuroStar 240E42/47 - 260E47/52 - 440E42/52

EuroTrakker 260E Tutti/All - 340E Tutti/All - 440E Tutti/All



CEI no.

225.166

O.E.M. Ref  
41218020

Barra / Arm  
Size / Misure

2 pezzi per assale / 2 pcs. For axle

NESSUNA IMMAGINE - NO PICTURE

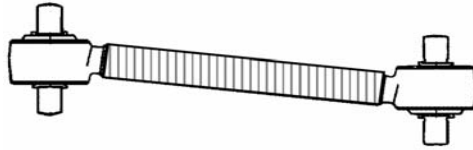

In coppia con / Together with : 42041107

Repair Kit

NESSUNA IMMAGINE  
NO PICTURE



226.080  
93161720

Models **TRAKKER T.CURSOR - TRAKKER ADIAT E4**

**EuroTrakker 260E Tutti/All - 340E Tutti/All - 440E Tutti/All**

*Solo Ultime Generazioni T.CURSOR / Only Latest Generation T.CURSOR*

CEI no.

**225.012**

O.E.M. Ref  
41011006  
42065332

Barra / Arm  
Size / Misure  
L = 610 mm  
Tube Ø 58 mm

4 o 6 pezzi per assale / 4 or 6 pcs. For axle



Repair Kit



**226.025**  
42493431

Models **TRAKKER-TRAKKER T.CURSOR-TRAKKER ADIAT E4**

**EuroTrakker 330E Tutti/All - 380E Tutti/All - 410E Tutti/All - 720E Tutti/All**

CEI no.

225.165

O.E.M. Ref  
41218021

Barra / Arm  
Size / Misure

2 pezzi per assale / 2 pcs. For axle

NESSUNA IMMAGINE - NO PICTURE

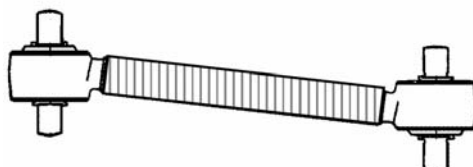

In coppia con / Together with : 42065332

Repair Kit

NESSUNA IMMAGINE  
NO PICTURE

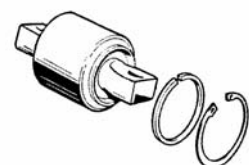

226.099  
93162288

Models **TRAKKER T.CURSOR - TRAKKER ADIAT E4**

**EuroTrakker 330E Tutti/All - 380E Tutti/All - 410E Tutti/All - 720E Tutti/All**

*Solo Ultime Generazioni T.CURSOR / Only Latest Generation T.CURSOR*



CEI no.  
225.133

O.E.M. Ref  
4820894

**Barra a V / V-Stay**

Size / Misure  
L = 873 mm  
L 1 = 873 mm  
Tube Ø 48 mm

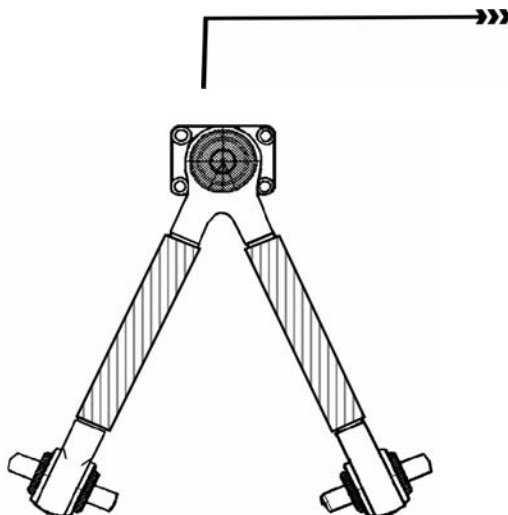

NESSUNA IMMAGINE - NO PICTURE



NESSUNA IMMAGINE  
NO PICTURE

**Kit A**

226.081  
93194456

NESSUNA IMMAGINE  
NO PICTURE



**Kit B**

226.100  
93194457

Models **TURBOCITY**  
TurboCity 480 - 580 - 680

CEI no.  
225.134

O.E.M. Ref  
99484068  
99432563

**Barra a V / V-Stay**

Size / Misure  
L = 660 mm  
L 1 = 660 mm  
Tube Ø 48 mm

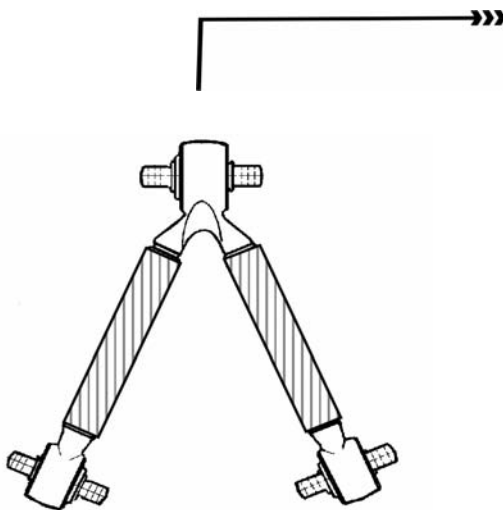

NESSUNA IMMAGINE - NO PICTURE

NESSUNA IMMAGINE  
NO PICTURE

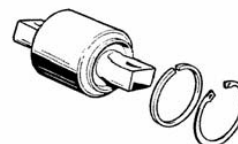

**Kit A**

226.082  
42530929



**Kit B W/Pin**

198.612  
2980884

**Kit B W/out Pin**

198.699  
CEI

**Note**

Models **CITYCLASS**  
CityClass 491.22/24/27 - 591.22/24/27  
CityClass 25 - 29 - 35  
Sospensione Anteriore / Front Suspension

All original equipment manufacturers numbers, symbols, pictures, models and description used in this catalogue are for reference only, and it is not implied that any part listed is the product of these manufacturers. Tutti i nostri particolari non sono originali ma con essi intercambiabili. I riferimenti originali, le figure, i modelli sono esposti a semplice titolo indicativo. La nostra produzione riporta il nostro marchio.

CEI no.  
**225.135**

O.E.M. Ref  
4865483

**Barra a V / V-Stay**

Size / Misure  
L = 703 mm  
L 1 = 703 mm  
Tube Ø 48 mm

**Note**



NESSUNA IMMAGINE  
NO PICTURE

**Kit A**  
**226.083**  
93194458



**Kit B W/Pin**  
**198.612**  
2980884

**Kit B W/out Pin**  
**198.699**  
CEI

Models **EUROCLASS**

**EuroClass 29 - 35 - 36 - HD**

Sospensione Posteriore / Rear Suspension

CEI no.  
225.136

O.E.M. Ref  
98487790

**Barra a V / V-Stay**

Size / Misure  
L = 686 mm  
L 1 = 686 mm  
Tube Ø 48 mm

**Note**

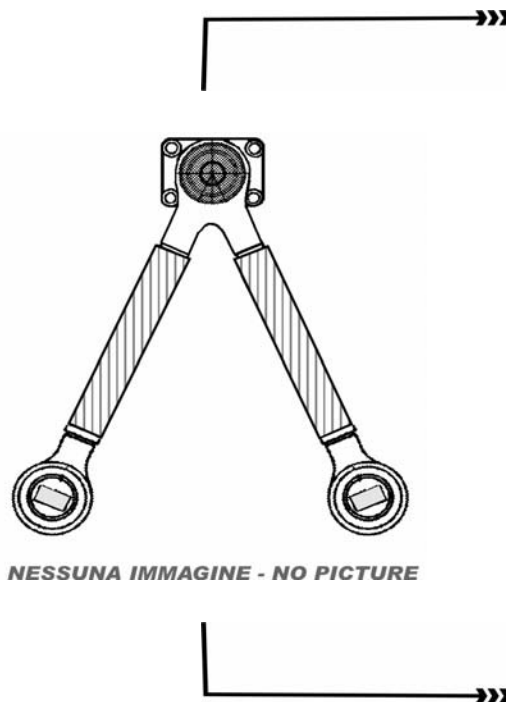

NESSUNA IMMAGINE - NO PICTURE



NESSUNA IMMAGINE  
NO PICTURE

**Kit A**  
**226.083**  
93194458



**Kit B**  
**226.018**  
42488722

Models **EURORIDER**

**EuroRider 26 - 26A - 29 - 29A - 31 - 35 - 35A - 38 - 43**

Sospensione Anteriore / Front Suspension

All original equipment manufacturer's numbers, symbols, pictures, models and description used in this catalogue are for reference only, and it is not implied that any part listed is the product of these manufacturers. Tutti i nostri particolari non sono originali ma con essi intercambiabili. I riferimenti originali, le figure, i modelli sono esposti a semplice titolo indicativo. La nostra produzione riporta il nostro marchio.

CEI no.

**198.675**

O.E.M. Ref  
4738069

**Barra / Arm**  
**Size / Misure**  
L = 730 mm  
Tube Ø 48 mm

**Note**

**NUOVO TIPO**  
**NEW TYPE**



**Repair Kit**



**198.681**

CEI

**Repair Kit W/OUT PIN**



**198.644**

CEI

**Models OLD BUSES**

**370S24 - 370S25L - 370S30 - 370S35 - 370SE27 - 370SE29 - 370SE35**

**Barra INFERIORE - 2 pezzi per assale / LOWER arm - 2 pcs for axle**

**Sospensionioni ANTERIORI / FRONT Suspension**

CEI no.

O.E.M. Ref

--

**Barra / Arm**  
**Size / Misure**  
L = 730 mm

**Note**

**VECCHIO TIPO**  
**OLD TYPE**

**Non piu' fornita**  
**No more supplied**



**Repair Kit**



**198.689**

CEI

**Repair Kit W/OUT PIN**



**198.699**

CEI

**Models OLD BUSES**

**370S24 - 370S25L - 370S30 - 370S35 - 370SE27 - 370SE29 - 370SE35**

**Barra INFERIORE - 2 pezzi per assale / LOWER arm - 2 pcs for axle**

**Sospensionioni ANTERIORI / FRONT Suspension**

All original equipment manufacturers numbers, symbols, pictures, models and description used in this catalogue are for reference only, and it is not implied that any part listed is the product of these manufactures. Tutti i nostri particolari non sono originali ma con essi intercambiabili. I riferimenti originali, le figure, i modelli sono esposti a semplice titolo indicativo. La nostra produzione riporta il nostro marchio.

CEI no.

225.071

O.E.M. Ref

4759025

4703862

4703861

**Barra / Arm**  
**Size / Misure**  
**L = 595 mm**  
**Tube Ø 48 mm**



NESSUNA IMMAGINE - NO PICTURE

**Repair Kit**



NESSUNA IMMAGINE  
NO PICTURE

139.430

4746348

**Models OLD BUSES**

**370S24 - 370S25L - 370S30 - 370S35 - 370SE27 - 370SE29 - 370SE35**

**Barra SUPERIORE - 1 pezzo per assale / UPPER arm - 1 pc for axle**

**Sospensionioni ANTERIORI / FRONT Suspension**

CEI no.

225.072

O.E.M. Ref

4703853

4703852

4759023

**Barra / Arm**  
**Size / Misure**  
**L = 960 mm**  
**Tube Ø 48 mm**



NESSUNA IMMAGINE - NO PICTURE

**Repair Kit**



NESSUNA IMMAGINE  
NO PICTURE

139.429

500343454

**Models OLD BUSES**

**370S24 - 370S25L - 370S30 - 370S35 - 370SE27 - 370SE29 - 370SE35**

**Barra TRASVERSALE - 1 pezzo per assale / TRANSVERSAL arm - 1 pc for axle**

**Sospensionioni ANTERIORI / FRONT Suspension**

CEI no.

225.073

O.E.M. Ref

4703858

4703857

4759027

**Barra / Arm**  
**Size / Misure**  
**L = 760 mm**  
**Tube Ø 48 mm**

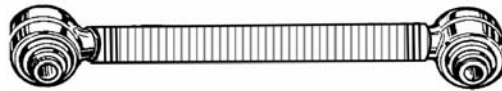

NESSUNA IMMAGINE - NO PICTURE

**Repair Kit**



NESSUNA IMMAGINE  
NO PICTURE

139.429

500343454

**Models OLD BUSES**

**370S24 - 370S25L - 370S30 - 370S35 - 370SE27 - 370SE29 - 370SE35**

**Barra INFERIORE - 2 pezzi per assale / LOWER arm - 2 pcs for axle**

**Sospensionioni POSTERIORI / REAR Suspension**

CEI no.

225.074

O.E.M. Ref

4804714

4804716

**Barra / Arm**  
**Size / Misure**  
L = 581 mm  
Tube Ø 48 mm



NESSUNA IMMAGINE - NO PICTURE

**Repair Kit**



NESSUNA IMMAGINE  
NO PICTURE

139.429

500343454

**Models OLD BUSES**

**370S24 - 370S25L - 370S30 - 370S35 - 370SE27 - 370SE29 - 370SE35**

**Barra SUPERIORE - 1 pezzo per assale / UPPER arm - 1 pc for axle**

**Sospensionioni POSTERIORI / REAR Suspension**

CEI no.

225.075

O.E.M. Ref

4711073

**Barra / Arm**  
**Size / Misure**



NESSUNA IMMAGINE - NO PICTURE

**Repair Kit**



NESSUNA IMMAGINE  
NO PICTURE

139.429

500343454

**Models OLD BUSES**

**370S24 - 370S25L - 370S30 - 370S35 - 370SE27 - 370SE29 - 370SE35**

**Barra TRASVERSALE - 1 pezzo per assale / TRANSVERSAL arm - 1 pc for axle**

**Sospensionioni POSTERIORI / REAR Suspension**

CEI no.

225.076

O.E.M. Ref

4808424

4808425

**Barra / Arm**  
**Size / Misure**  
L = 720 mm



NESSUNA IMMAGINE - NO PICTURE

**Repair Kit**



NESSUNA IMMAGINE  
NO PICTURE

226.084

500343452

**Models TURBOCITY**

**TurboCity 480 - 580 - 680**

**2 pezzi per assale / 2 pcs for Axle**

**Sospensionioni POSTERIORI / REAR Suspension**

All original equipment manufacturers numbers, symbols, pictures, models and description used in this catalogue are for reference only, and it is not implied that any part listed is the product of these manufacturers. Tutti i nostri particolari non sono originali ma con essi intercambiabili. I riferimenti originali, le figure, i modelli sono esposti a semplice titolo indicativo. La nostra produzione riporta il nostro marchio.



CEI no.

225.014

O.E.M. Ref  
98488010

In alternativa a  
Alternative To  
**500328489**

Barra / Arm  
Size / Misure  
L = 582 mm  
Tube Ø 48 mm



**Repair Kit**



**226.018**  
42488722

Models **CITYCLASS**

CityClass 491.22/27 - 591.22/27

Barra INFERIORE - 2 pezzi per assale / LOWER arm - 2 pcs for axle

Sospensionioni POSTERIORI / REAR Suspension

CEI no.

225.077

O.E.M. Ref  
500328489

In alternativa a  
Alternative To  
**98488010**

Barra / Arm  
Size / Misure  
L = 583 mm  
Tube Ø 48 mm



NESSUNA IMMAGINE - NO PICTURE

**Repair Kit**

NESSUNA IMMAGINE  
NO PICTURE



226.085  
42535445

Models **CITYCLASS**

CityClass 25 - 29 - 35 - 491.24 - 591.24

Barra INFERIORE - 2 pezzi per assale / LOWER arm - 2 pcs for axle

Sospensionioni POSTERIORI / REAR Suspension

CEI no.

225.078

O.E.M. Ref  
4862493

Barra / Arm  
Size / Misure  
L = 757 mm  
Tube Ø 48 mm



NESSUNA IMMAGINE - NO PICTURE

**Repair Kit**

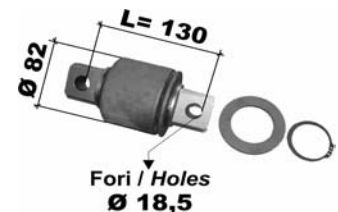

226.038  
500343812

Models **EUROCLASS**

EuroClass 29 - 35 - 36 - HD

Barra INFERIORE - 2 pezzi per assale / LOWER arm - 2 pcs for axle

Sospensionioni POSTERIORI / REAR Suspension



CEI no.

O.E.M. Ref

--

Barra / Arm  
Size / Misura

Models  
BM21 - BM301

Repair Kit

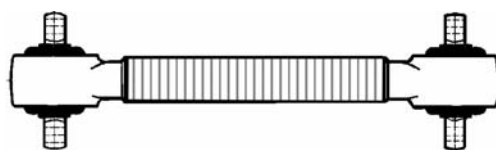

NESSUNA IMMAGINE - NO PICTURE

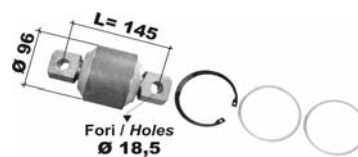

226.033

42005

CEI no.

O.E.M. Ref

100864

Barra / Arm  
Size / Misura

Models  
BM304 - BM305

Repair Kit

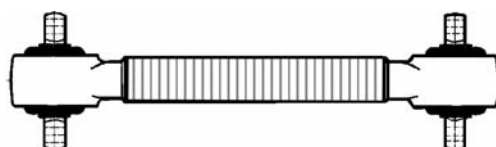

NESSUNA IMMAGINE - NO PICTURE



226.010

100862

All original equipment manufacturers' numbers, symbols, pictures, models and description used in this catalogue are for reference only, and it is not implied that any part listed is the product of these manufacturers.  
Tutti i nostri particolari non sono originali ma con essi intercambiabili. I riferimenti originali, le figure, i modelli sono esposti a semplice titolo indicativo. La nostra produzione riporta il nostro marchio.

CEI no.  
225.069

O.E.M. Ref  
080521  
276875

**Barra a V / V-Stay**  
Size / Misure  
L = 608 mm  
L 1 = 608 mm  
Tube Ø 50 mm

**Sos Pneumatiche**  
Pneumatic Susp.

1a Generazione  
**Sos da 1793875**  
1st Generation  
**Repl by 1793875**

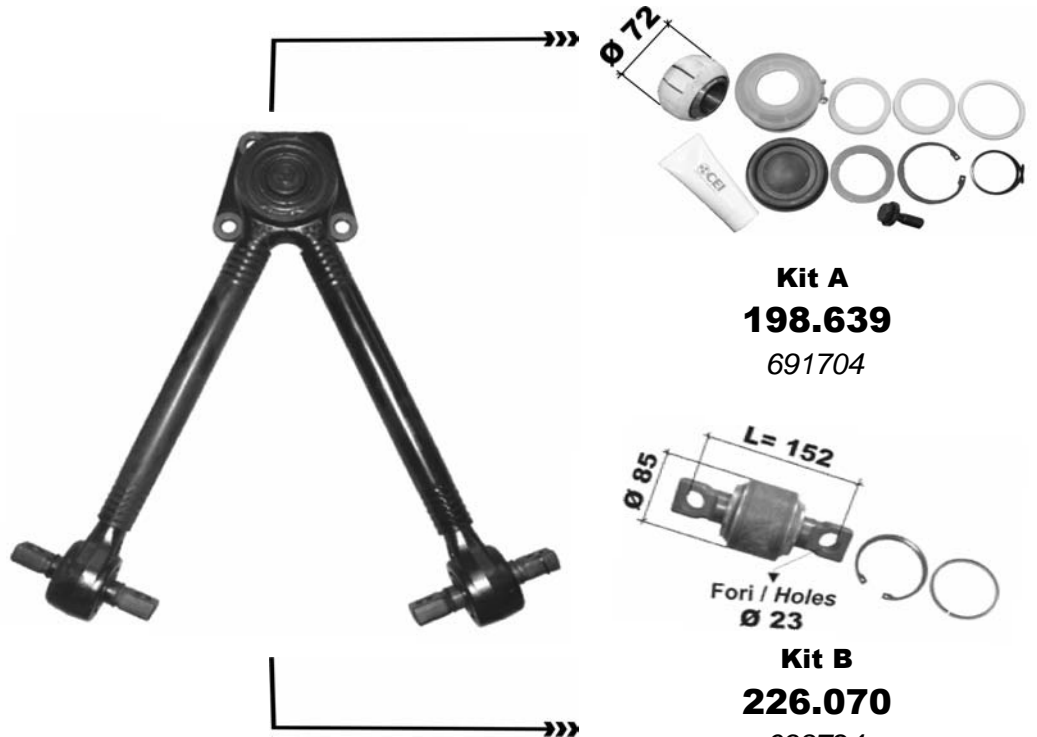

**Kit A**  
**198.639**  
691704

**Kit B**  
**226.070**  
698724

**OLD Models**  
F2100 - F2300 - F2500 - F2700  
**NEW Models**  
F65 - 65CF - F75 - 75CF - F85 - 85CF - F95 - 95XF

CEI no.  
**225.137**

O.E.M. Ref  
1793875  
1368270  
1390932  
1361651

**Barra a V / V-Stay**  
Size / Misure  
L = 608 mm  
L 1 = 608 mm  
Tube Ø 50 mm

**Sos Pneumatiche**  
Pneumatic Susp.

2a Generazione  
2nd Generation

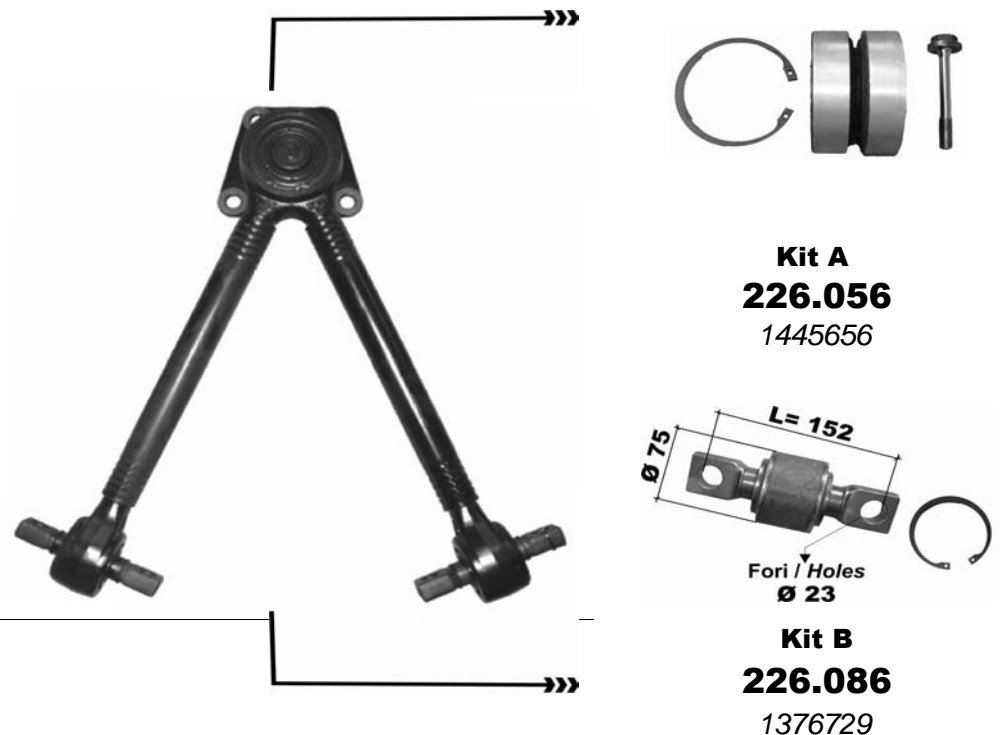

**Kit A**  
**226.056**  
1445656

**Kit B**  
**226.086**  
1376729

**NEW Models**  
F65 - 65CF - F75 - 75CF - F85 - 85CF - F95 - 95XF - XF105

All original equipment manufacturers' numbers, symbols, pictures, models and description used in this catalogue are for reference only, and it is not implied that any part listed is the product of these manufacturers. Tutti i nostri particolari non sono originali ma con essi intercambiabili. I riferimenti originali, le figure, i modelli sono esposti a semplice titolo indicativo. La nostra produzione riporta il nostro marchio.

CEI no.

**225.138**

O.E.M. Ref  
1793877  
1620437  
649819

**Barra a V / V-Stay**  
Size / Misure  
L = 550 mm  
L 1 = 550 mm  
Tube Ø 50 mm

**Sos Meccanica**  
Mechanical Susp.

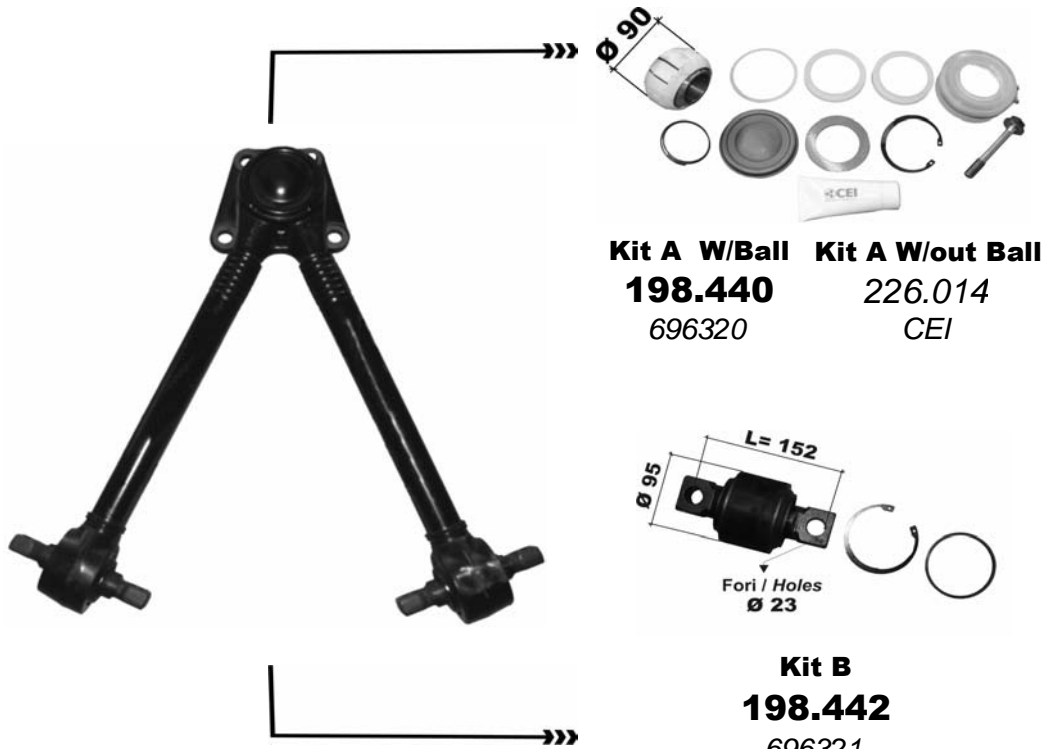

**OLD Models**

F2100 - F2300 - F2500 - F2700 - F3300 - F3600

**NEW Models**

F75 - 75CF - F85 - 85CF - F95 - 95XF - XF105

CEI no.

**225.139**

O.E.M. Ref  
1793876  
1620436  
1361652

**Barra a V / V-Stay**  
Size / Misure  
L = 608 mm  
L 1 = 608 mm  
Tube Ø 50 mm

**Sos Meccanica**  
Mechanical Susp.

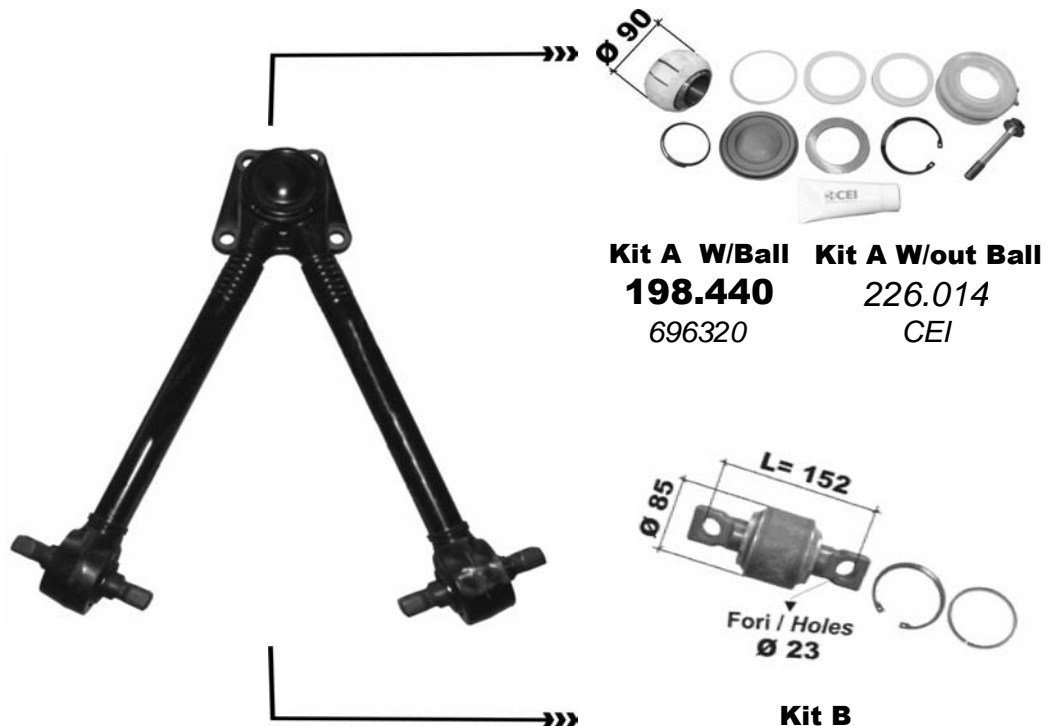

**NEW Models**

F75 - 75CF - F85 - 85CF - F95 - 95XF

All original equipment manufacturers numbers, symbols, pictures, models and description used in this catalogue are for reference only, and it is not implied that any part listed is the product of these manufactures. Tutti i nostri particolari non sono originali ma con essi intercambiabili. I riferimenti originali, le figure, i modelli sono esposti a semplice titolo indicativo. La nostra produzione riporta il nostro marchio.

CEI no.  
225.079

O.E.M. Ref  
1261101

**Barra 1**  
Dx / Rh

CEI no.  
225.079

O.E.M. Ref  
1261101

**Barra 2**  
Sx / Lf

Size / Misure  
L = 390 mm  
Tube Ø 50 mm

NESSUNA IMMAGINE - NO PICTURE

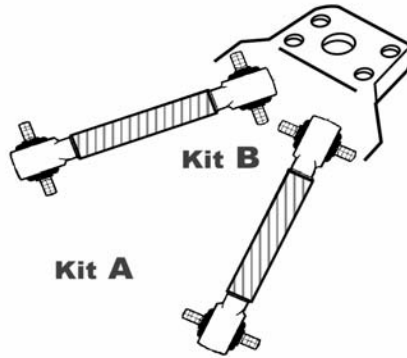

<b>Kit A W/Pin</b>	<b>Kit A W/out Pin</b>
<b>198.642</b>	<b>198.644</b>
693778	CEI



<b>Kit B W/Pin</b>	<b>Kit B W/out Pin</b>
<b>198.612</b>	<b>198.699</b>
1271124	CEI

**NEW Models**  
F95

**Sospensione Meccaniche | Mechanical Suspension**

CEI no.  
225.140

O.E.M. Ref  
658102

**Barra a V / V-Stay**  
Size / Misure  
L = 870 mm  
L1 = 870 mm  
Tube Ø 48 mm

NESSUNA IMMAGINE - NO PICTURE

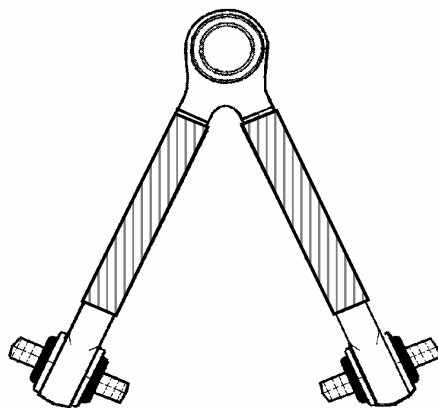

NESSUNA IMMAGINE  
NO PICTURE

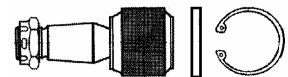

**Kit A**  
226.013  
689747

NESSUNA IMMAGINE  
NO PICTURE



**Kit B**  
226.087  
689748

**BUS Models**  
SB2700 - SB2750 - SBR3000 - SBR3015 - SB4000

All original equipment manufacturers' numbers, symbols, pictures, models and description used in this catalogue are for reference only, and it is not implied that any part listed is the product of these manufactures. Tutti i nostri particolari non sono originali ma con essi intercambiabili. I riferimenti originali, le figure, i modelli sono esposti a semplice titolo indicativo. La nostra produzione riporta il nostro marchio.

CEI no.

225.080

O.E.M. Ref  
267743

**Sos Pneumatiche**  
**Pneumatic Susp.**

Barra / Arm  
Size / Misure  
L = 605 mm  
Tube Ø 37 mm

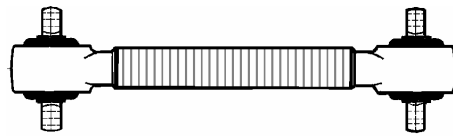

NESSUNA IMMAGINE - NO PICTURE

**Repair Kit**



**198.411**

691709

**Models OLD & NEW**

F2100 - F2300 - F2500 - F2700

F65 - 65CF - F75 - 75CF - F85 - 85CF - F95 - 95XF

1a generazione - Sos da 1361650 / 1st Generation Repl. By 1361650

CEI no.

**225.081**

O.E.M. Ref  
1656428  
1361650  
1361649

**Sos Pneumatiche**  
**Pneumatic Susp.**

Barra / Arm  
Size / Misure  
L = 611 mm  
Tube Ø 48 mm

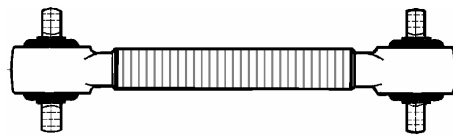

NESSUNA IMMAGINE - NO PICTURE

**Repair Kit**

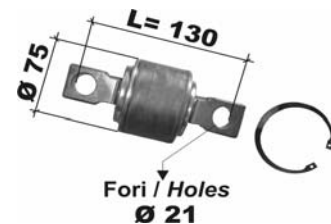

**226.088**

1376728

**Models NEW**

F65 - 65CF - CF65 - F75 - 75CF - CF75 - F85 - 85CF - CF85 - F95 - 95XF - XF95 - XF105

2a generazione / 2nd Generation

CEI no.

225.082

O.E.M. Ref  
1620438  
1284860

655697 / 655695

**Sos Meccanica**  
**Mechanical Susp.**

Barra / Arm  
Size / Misure  
L = 600 mm  
Tube Ø 50 mm

NESSUNA IMMAGINE - NO PICTURE

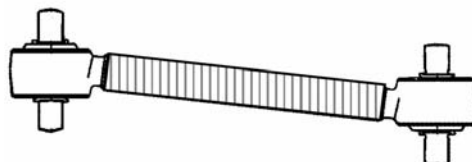

**Repair Kit**



**198.411**

691709

**Models OLD & NEW**

F2100 - F2300 - F2500 - F2700 - F3300 - F3600

F75 - 75CF - CF75 - F85 - 85CF - CF85 - F95 - 95XF - XF95 - XF105

CEI no.  
225.173  
O.E.M. Ref  
1294251

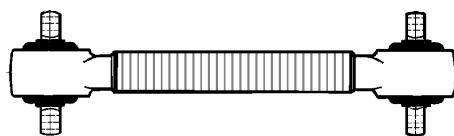

NESSUNA IMMAGINE - NO PICTURE

**Repair Kit**

NESSUNA IMMAGINE  
NO PICTURE



226.063

**Sos Meccanica**  
**Mechanical Susp.**

**Barra / Arm**  
**Size / Misure**  
L = 606 mm  
Tube Ø 40 mm

**Models NEW**

F75 - 75CF - CF75 - F85 - 85CF - CF85 - F95 - 95XF - XF95 - XF105

CEI no.  
225.083  
O.E.M. Ref  
658103

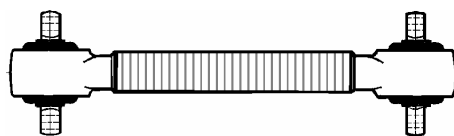

NESSUNA IMMAGINE - NO PICTURE

**Repair Kit**

NESSUNA IMMAGINE  
NO PICTURE



226.087  
689748

**Sos Pneumatiche**  
**Pneumatic Susp.**

**Barra / Arm**  
**Size / Misure**  
L = 600 mm  
Tube Ø 46 mm

**BUS Models**

SB2700 - SB2750 - SBR3000 - SBR3015 - SB4000

**Barra Superiore - In coppia con 658104 | Upper Arm - Together with 658104**

CEI no.  
225.084  
O.E.M. Ref  
658104

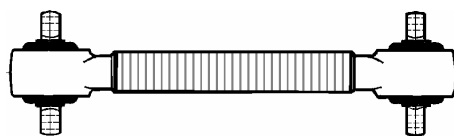

NESSUNA IMMAGINE - NO PICTURE

**Repair Kit**



226.018  
689749

**Sos Pneumatiche**  
**Pneumatic Susp.**

**Barra / Arm**  
**Size / Misure**  
L = 600 mm  
Tube Ø 48 mm

**BUS Models**

SB2700 - SB2750 - SBR3000 - SBR3015 - SB4000

**Barra Inferiore - In coppia con 658103 | Lower Arm - Together with 658103**

All original equipment manufacturer's numbers, symbols, pictures, models and description used in this catalogue are for reference only, and it is not implied that any part listed is the product of these manufacturers. Tutti i nostri particolari non sono originali ma con essi intercambiabili. I riferimenti originali, le figure, i modelli sono esposti a semplice titolo indicativo. La nostra produzione riporta il nostro marchio.



CEI no.

**198.648**

O.E.M. Ref  
658 350 0005  
655 350 0305  
393 350 5505  
393 350 5405

**Barra a V / V-Stay**  
Size / Misure  
L = 623 mm  
L<sub>1</sub> = 623 mm  
Tube Ø 60 mm



Models **NG | MK | SK**

Puo essere usata al posto di

Can be used instead of

**658 350 0105**

**658 350 0205**

1217-1429-1424-1613-1617-1624-1626-1632-1926-1932-2219-2226-2232 (Telai 380=387.xxx-393.xxx)  
1419-1420-1422-1425-1617-1620-1622-1625-1628-1628-1633-1928-1933-2028-2033-2219-2220-2222-  
2225-2233-2228-2233-2236-2238-2425-2428-2432-2433 (Telai 616-617-619-620-621-622-623.xxx)  
1729-1735-1929-1935-2429-2435-2448-2531-2535-2538-2544-2550-3238-3244 (Telai 655-656-657-658.xxx)



**Kit A W/Ball**  
**198.647**

000 350 0405

**Kit B W/out Ball**  
**226.017**

CEI



**Kit B W/Pin**  
**198.642**

000 586 1433

**Kit B W/out Pin**  
**198.644**

000 586 1533

CEI no.

**225.141**

O.E.M. Ref  
658 350 0105

**Barra a V / V-Stay**  
Size / Misure  
L = 509 mm  
L<sub>1</sub> = 622 mm  
Tube Ø 56 mm

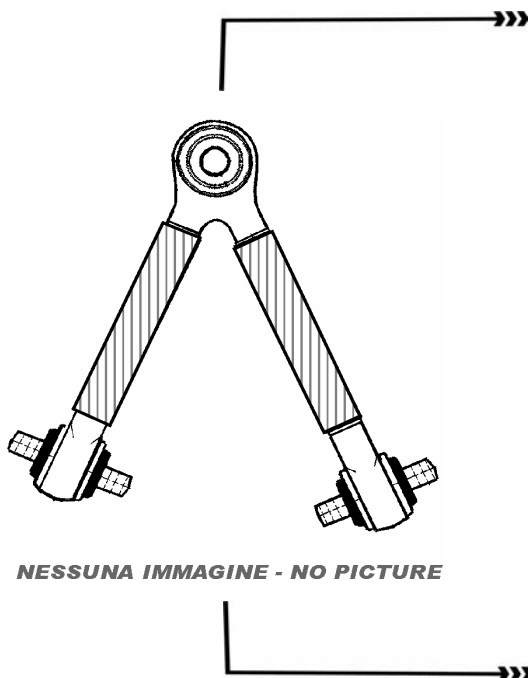

NESSUNA IMMAGINE - NO PICTURE



**Kit A**  
**226.056**  
000 350 1705



**Kit B**  
**226.072**  
000 350 1805

Puo' essere sostituita da

Can be replaced by

**658 350 0005**

**Assale Posteriore**  
Rear Axle

Models **SK**

2429-2435-2531-2534-2538-2544-2448-2550-2650 (Telai 658.xxx)

All original equipment manufacturers numbers, symbols, pictures, models and description used in this catalogue are for reference only, and it is not implied that any part listed is the product of these manufactures. Tutti i nostri particolari non sono originali ma con essi intercambiabili. I riferimenti originali, le figure, i modelli sono esposti a semplice titolo indicativo. La nostra produzione riporta il nostro marchio.

CEI no.

225.142

O.E.M. Ref

658 350 0205

656 350 0005

**Barra a V / V-Stay**

Size / Misure

L = 622 mm

L<sub>1</sub> = 509 mm

Tube Ø 56 mm

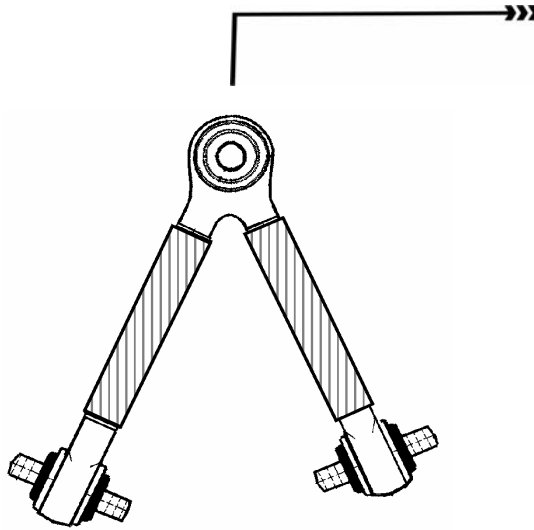

NESSUNA IMMAGINE - NO PICTURE



**Kit A**

**226.056**

000 350 1705



Fori / Holes  
Ø 21

**Kit B**

**226.072**

000 350 1805

Puo' essere sostituita da

Can be replaced by

658 350 0005

**Asse Posteriore e Terzo**

Asse

Rear Axle and 3rd Axle

**Models SK**

1729-1735-1748-1831-1834-1838-1844-1850-2429-2435-2531-2534-2538-2544-2550-2650

(Telai 655.xxx-656.xxx-657.xxx-658.xxx)

CEI no.

225.059

O.E.M. Ref

654 350 0105

654 350 0305

653 350 0205

653 350 0105

653 350 0005

**Barra a V / V-Stay**

Size / Misure

L = 623 mm

L<sub>1</sub> = 623 mm

Tube Ø 56 mm



**Kit A W/Ball**

**198.647**

000 350 0405

**Kit B W/out Ball**

**226.017**

CEI



Fori / Holes  
Ø 21

**Kit B W/Pin**

**198.642**

000 586 1433

**Kit B W/out Pin**

**198.644**

000 586 1533

1a Generazione

1st Generation

**Asse Posteriore e Terzo**

Asse

Rear Axle and 3rd Axle

**Models SK**

1420-1422-1424-1426 (Telai 651.xxx)

1717-1720-1722-1726-1733-1820-1824-1827-1831-1834-2422-2524-2531-2534-2527 (Telai 652.xxx)

2420-2422-2426-2433-2522-2524-2527-2531-2534-3234 (Telai 653.xxx - 654.xxx)

CEI no.

225.143

O.E.M. Ref  
653 350 0405

**Barra a V / V-Stay**  
Size / Misure  
L = 623 mm  
L<sub>1</sub> = 657 mm  
Tube Ø 56 mm

2a Generazione  
2nd Generation

Assale Posteriore  
Rear Axle

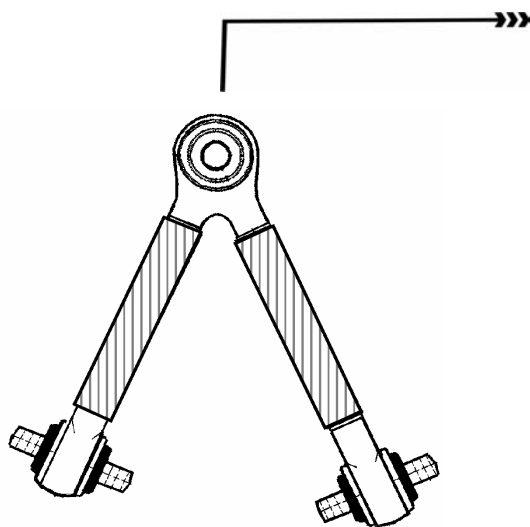

NESSUNA IMMAGINE - NO PICTURE



**Kit A**  
**226.056**  
000 350 1705



Fori / Holes  
Ø 21

**Kit B**  
**226.072**  
000 350 1805

**Models SK**

1420-1422-1424-1426 (Telai 651.xxx)

1717-1720-1722-1726-1733-1820-1824-1827-1831-1834-2422-2524-2531-2534-2527 (Telai 652.xxx)

2420-2422-2426-2433-2522-2524-2527-2531-2534-3234 (Telai 653.xxx - 654.xxx)

CEI no.

225.144

O.E.M. Ref  
653 350 0305

**Barra a V / V-Stay**  
Size / Misure  
L = 657 mm  
L<sub>1</sub> = 623 mm  
Tube Ø 56 mm

2a Generazione  
2nd Generation

Terzo Asse  
3rd Axle

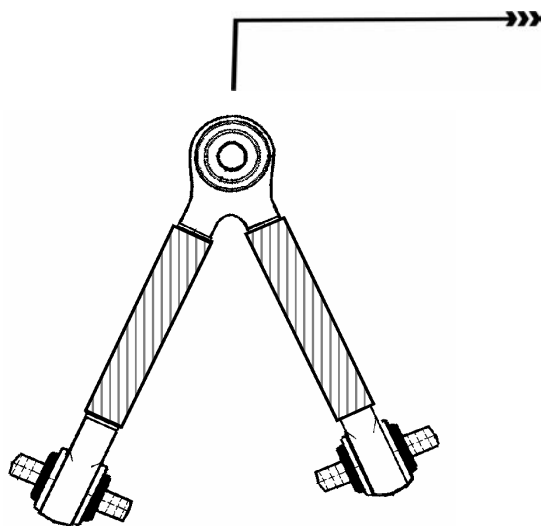

NESSUNA IMMAGINE - NO PICTURE



**Kit A**  
**226.056**  
000 350 1705



Fori / Holes  
Ø 21

**Kit B**  
**226.072**  
000 350 1805

**Models SK**

1420-1422-1424-1426 (Telai 652.xxx)

1717-1720-1722-1726-1733-1820-1824-1827-1831 (Telai 652.xxx)

2420-2422-2426-2433-2522-2524-2527-2531-2534 (Telai 653.xxx - 654.xxx)

CEI no.

225.145

O.E.M. Ref

974 350 0505

974 350 0405

974 350 0005

**Barra a V / V-Stay**

Size / Misure

L = 761 mm

L<sub>1</sub> = 761 mm

Tube Ø 46 mm

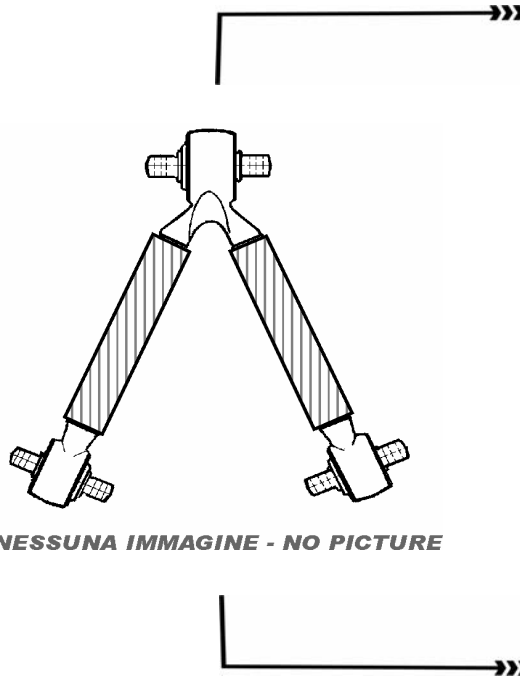

NESSUNA IMMAGINE - NO PICTURE

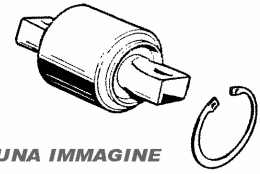

NESSUNA IMMAGINE  
NO PICTURE

**Kit A**

226.090

000 350 2105

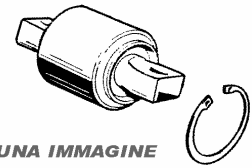

NESSUNA IMMAGINE  
NO PICTURE

**Kit B**

226.089

000 350 4705

**Models ATEGO**

1214-1228-1317-1323-1328-1517-1528 (Telai 970.xxx-974.xxx-975.xxx)

CEI no.

225.039

O.E.M. Ref

942 350 0805

942 350 0505

**Barra a V / V-Stay**

Size / Misure

L = 622 mm

L<sub>1</sub> = 622 mm

Tube Ø 48 mm



Fori / Holes  
Ø 25

**Kit A**

226.066

000 350 2305

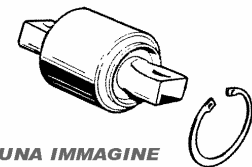

NESSUNA IMMAGINE  
NO PICTURE

**Kit B**

226.091

000 350 3305

Versioni Standard

Standard Models

**Models AXOR**

1835-1843 (Telai 944.xxx)

All original equipment manufacturer's numbers, symbols, pictures, models and description used in this catalogue are for reference only, and it is not implied that any part listed is the product of these manufacturers. Tutti i nostri particolari non sono originali ma con essi intercambiabili. I riferimenti originali, le figure, i modelli sono esposti a semplice titolo indicativo. La nostra produzione riporta il nostro marchio.

CEI no.

225.146

O.E.M. Ref

942 350 0205

Barra a V / V-Stay  
Size / Misure

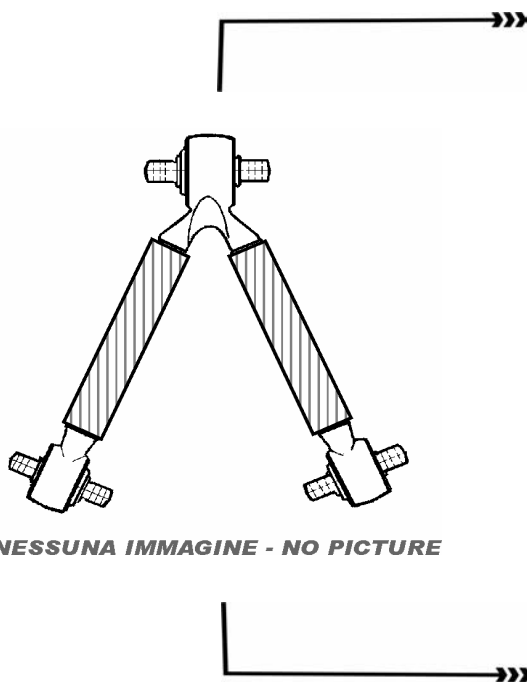

NESSUNA IMMAGINE - NO PICTURE

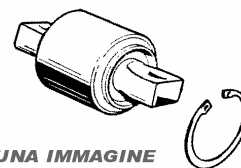

NESSUNA IMMAGINE  
NO PICTURE

Kit A

226.093

942 326 0150

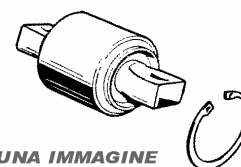

NESSUNA IMMAGINE  
NO PICTURE

Kit B

226.092

942 326 0250

Struttura Leggera  
Light Chassis

Models **AXOR**

1835-1840-1843-2535-2540-2543 (Telai 944.xxx)

CEI no.

**225.040**

O.E.M. Ref

947 350 0105

947 350 0705

944 350 0305

944 350 0005

Barra a V / V-Stay

Size / Misure

L = 622 mm

L<sub>1</sub> = 622 mm

Tube Ø 48 mm



Fori / Holes  
Ø 25

Kit A

**226.066**

000 350 2305



Fori / Holes  
Ø 25

Kit B

**226.054**

000 350 2205

Carichi Standard  
Standard Load  
(2x 10-13 Ton)

Models **ACTROS, NEW ACTROS and Maxi-ATEGO**

1831-1832-1835-1840-1843-1846-1848-1853-1854-1857-1858-2531-2532-2535-2536-2543-2553-2554-2557-2631-2640-2648-2657-2658 (Telai 930.xxx-932.xxx-934.xxx-950.xxx-952.xxx-954.xxx)

1823-1828-2523-2528-2628 (Telai 950.500÷600 / 954.500÷599 / 957.500÷600)

All original equipment manufacturers numbers, symbols, pictures, models and description used in this catalogue are for reference only, and it is not implied that any part listed is the product of these manufacturers. Tutti i nostri particolari non sono originali ma con essi intercambiabili. I riferimenti originali, le figure, i modelli sono esposti a semplice titolo indicativo. La nostra produzione riporta il nostro marchio.



CEI no.  
**225.060**

O.E.M. Ref  
948 350 3005  
948 350 0405  
947 350 0905  
944 350 0505

**Barra a V / V-Stay**  
Size / Misure  
L = 622 mm  
L<sub>1</sub> = 622 mm  
Tube Ø 48 mm

**Tipo Rinforzato**  
Reinforced Type

Puo essere usata al posto di  
Can be used instead of  
947 350 0105

Carichi Standard  
Standard Load  
(2x 10-13 Ton)



Fori / Holes  
Ø 25

**Kit A**  
**226.069**  
000 350 2405



Fori / Holes  
Ø 25

**Kit B**  
**226.054**  
000 350 2205

**Models ACTROS , NEW ACTROS and Maxi-ATEGO**

1831-1832-1835-1840-1843-1846-1848-1853-1854-1857-1858-2531-2532-2535-2536-2543-2553-2554-  
2557-2631-2640-2648-2657-2658-3331-3346-3350-4140-4150 (Telai 930-932-934-950-952-954.xxx)  
1823-1828-2523-2528-2628 (Telai 950.500=600 / 954.500=599 / 957.500=600)

CEI no.  
**225.058**

O.E.M. Ref  
948 350 2205  
948 350 1705

**Barra a V / V-Stay**  
Size / Misure  
L = 622 mm  
L<sub>1</sub> = 622 mm  
Tube Ø 56 mm

Carichi Pesanti  
Heavy Load  
(2x 16 Ton)



Fori / Holes  
Ø 25

**Kit A**  
**226.068**  
000 350 3605



Fori / Holes  
Ø 23

**Kit B**  
**226.067**  
000 350 3705

**Models ACTROS and NEW ACTROS**

3331-3340-3343-3346-3348-3350-3353-3354-3357-3358-4140-4143-4146-4148-4150 (Telai 930.xxx-  
932.xxx-933.xxx-934.xxx-950.xxx-952.xxx-953.xxx-954.xxx)

**Macchine cava-cantiere / Heavy Off Road Trucks**



CEI no.

**225.147**

O.E.M. Ref  
948 350 2305  
948 350 0905

**Barra a V / V-Stay**

Size / Misure  
L = 667 mm  
L<sub>1</sub> = 667 mm  
Tube Ø 58 mm



Fori / Holes  
Ø 25

**Kit A**

**226.068**

000 350 3605



Fori / Holes  
Ø 23

**Kit B**

**226.067**

000 350 3705

Carichi Pesantissimi

Heavier Load  
(2x 18 TON)

(ed oltre - and over)

Models **ACTROS and NEW ACTROS**

3331-3340-3343-3346-3348-3350-3353-3354-3357-3358-4140-4143-4146-4148-4150 (Telai 930.xxx-932.xxx-933.xxx-934.xxx-950.xxx-952.xxx-953.xxx-954.xxx)

Macchine cava-cantiere / Heavy Off Road Trucks

CEI no.

**225.148**

O.E.M. Ref  
942 350 1105  
942 350 0105

**Barra a V / V-Stay**

Size / Misure  
L = 622 mm  
L<sub>1</sub> = 622 mm  
Tube Ø 46 mm

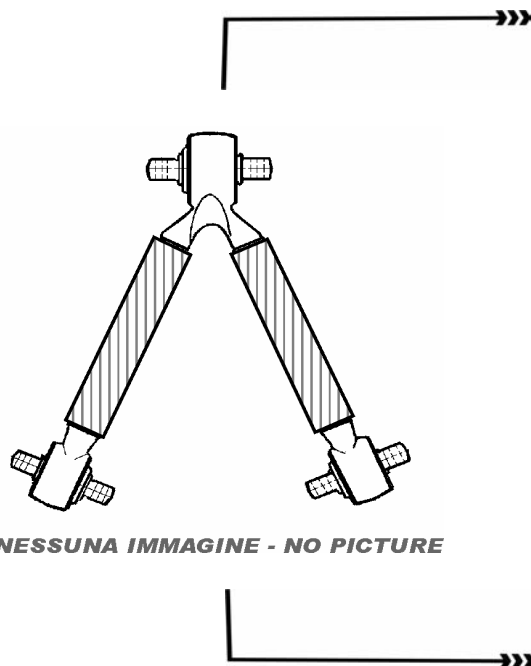

NESSUNA IMMAGINE - NO PICTURE

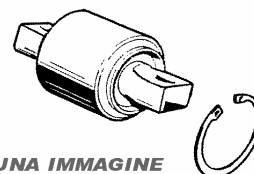

NESSUNA IMMAGINE  
NO PICTURE

**Kit A**

**226.090**

000 350 4605

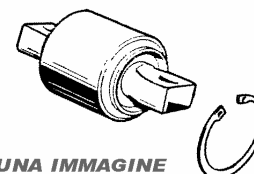

NESSUNA IMMAGINE  
NO PICTURE

**Kit B**

**226.089**

000 350 4705

Models **ACTROS and NEW ACTROS, ECONIC**

1823-1833-2528-2531-2532-2533-2543-2548-2555-2623-2628 (Telai 930.xxx-950.xxx-957.xxx)

Automezzi con asse aggiunto trainato / Trucks with extra trailer added

CEI no.  
225.149  
O.E.M. Ref  
947 350 0505

**Barra a V / V-Stay**  
Size / Misure  
L = 565 mm  
L<sub>1</sub> = 565 mm

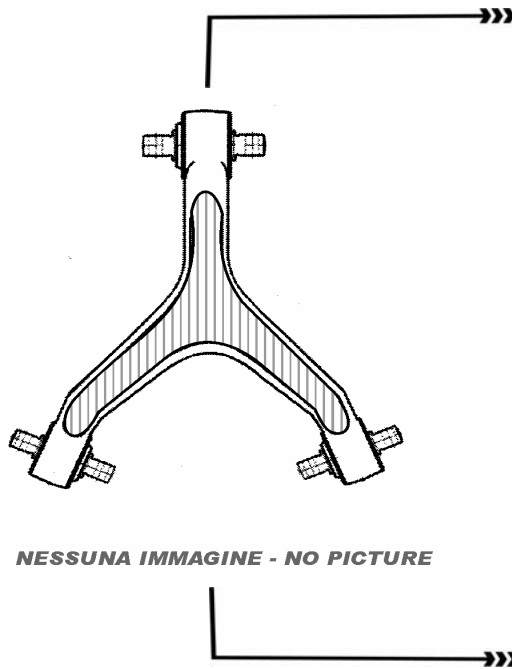

NESSUNA IMMAGINE - NO PICTURE



Fori / Holes  
Ø 25

**Kit A**

**226.066**

000 350 2305



Fori / Holes  
Ø 25

**Kit B**

**226.115**

000 350 2505

**Models ACTROS and NEW ACTROS Special Applications**

2531-2535-2543-2553-2557-2631-2640-2657-2658 (Telai 932.xxx-950.xxx-952.xxx)

Automezzi con cassone ribaltabile / Trucks with tilting cart

CEI no.  
225.150  
O.E.M. Ref  
613 330 0010  
356 330 1410

**Barra a V / V-Stay**  
Size / Misure  
L = 901 mm  
L<sub>1</sub> = 901 mm  
Tube Ø 48 mm

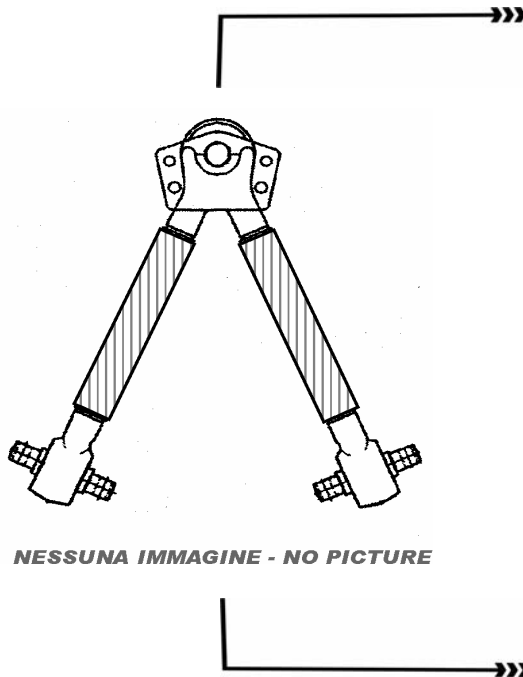

NESSUNA IMMAGINE - NO PICTURE

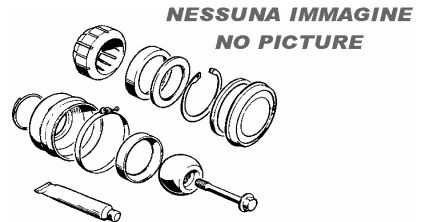

**Kit A**

**226.095**

000 330 0310



**Kit B**

**226.094**

000 330 0410

**Models BUSES**

O350-O403-O404 (Telai 356.xxx-613.xxx)

Parte Sinistra / Left Side

All original equipment manufacturer's numbers, symbols, pictures, models and description used in this catalogue are for reference only, and it is not implied that any part listed is the product of these manufacturers. Tutti i nostri particolari non sono originali ma con essi intercambiabili. I riferimenti originali, le figure, i modelli sono esposti a semplice titolo indicativo. La nostra produzione riporta il nostro marchio.

CEI no.

225.151

O.E.M. Ref

613 330 0110

356 330 1510

**Barra a V / V-Stay**

Size / Misure

L = 901 mm

L<sub>1</sub> = 901 mm

Tube Ø 48 mm

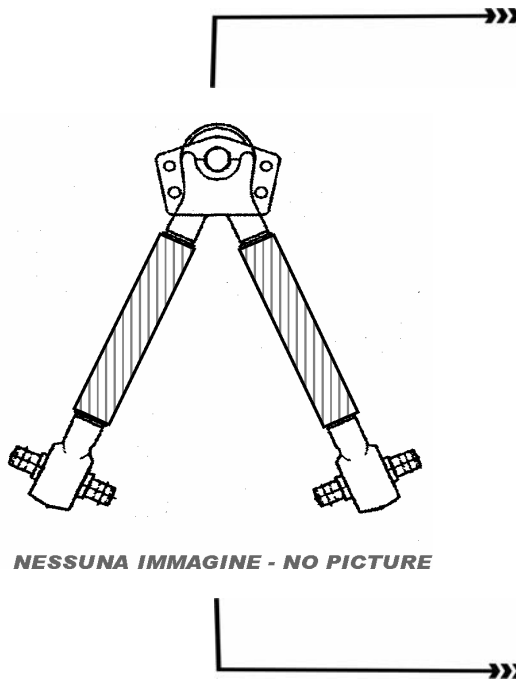

NESSUNA IMMAGINE - NO PICTURE

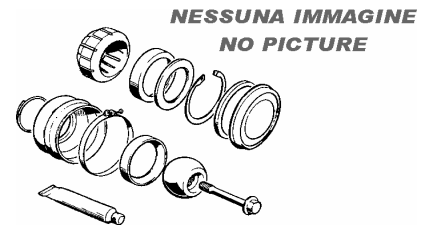

NESSUNA IMMAGINE  
NO PICTURE

**Kit A**

226.095

000 330 0310



NESSUNA IMMAGINE  
NO PICTURE

**Kit B**

226.094

000 330 0410

Models **BUSES**

O350-O403-O404 (Telai 356.xxx-613.xxx)

Parte Destra / Left Right

CEI no.

149.074

O.E.M. Ref  
343 320 1632

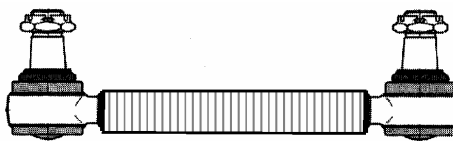

NESSUNA IMMAGINE - NO PICTURE

**Barra / Arm**  
**Size / Misure**  
L = 595 mm  
Tube Ø 50 mm

**Note**

Vecchio Tipo Sostituito da  
343 320 1832

Old Type - Replaced By  
343 320 1832

**Repair Kit**

NESSUNA IMMAGINE  
NO PICTURE



198.261  
343 586 0032

**Repair Kit W/OUT PIN**

NESSUNA IMMAGINE  
NO PICTURE



198.252  
000 586 0632

**Models NG (Old Range)**  
2624 (Telai 343.xxx)

CEI no.

189.278

O.E.M. Ref  
343 320 1732



**Barra / Arm**  
**Size / Misure**  
L = 595 mm  
Tube Ø 50 mm

**Note**

Vecchio Tipo Sostituito da  
343 320 1832

Old Type - Replaced By  
343 320 1832

**Repair Kit**

NESSUNA IMMAGINE  
NO PICTURE

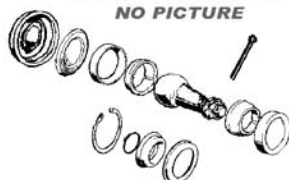

198.261  
343 586 0032

**Repair Kit W/OUT PIN**

NESSUNA IMMAGINE  
NO PICTURE



198.252  
000 586 0632

**Models NG (Old Range)**  
2624 (Telai 343.xxx)

All original equipment manufacturer's numbers, symbols, pictures, models and description used in this catalogue are for reference only, and it is not implied that any part listed is the product of these manufacturers. Tutti i nostri particolari non sono originali ma con essi intercambiabili. I riferimenti originali, le figure, i modelli sono esposti a semplice titolo indicativo. La nostra produzione riporta il nostro marchio.

CEI no.

225.085

O.E.M. Ref  
343 320 1832

**Barra / Arm**  
**Size / Misure**  
L = 595 mm  
Tube Ø 50 mm

Sostituisce / Replaced  
**343 320 1632**  
**343 320 1732**

**Note**  
Nuovo Tipo Regolabile  
New Type adjustable

NESSUNA IMMAGINE - NO PICTURE

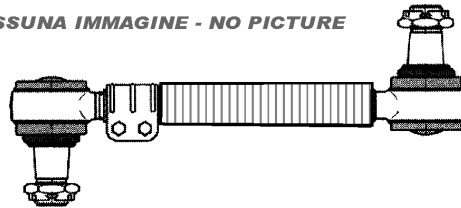

**Repair Kit**

NESSUNA IMMAGINE  
NO PICTURE

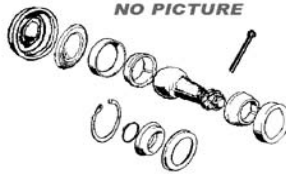

198.261  
343 586 0032

**Repair Kit W/OUT PIN**

NESSUNA IMMAGINE  
NO PICTURE



198.252  
000 586 0632

**Models NG (Old Range)**  
2624 (Telai 343.xxx)

CEI no.

225.086

O.E.M. Ref  
385 350 0106  
395 320 0332

**Barra / Arm**  
**Size / Misure**  
L = 610 mm  
Tube Ø 50 mm

**Repair Kit**

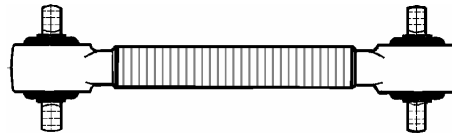

NESSUNA IMMAGINE - NO PICTURE

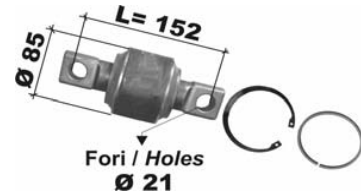

**226.011**  
000 350 0613

**Models NG (Old Range)**  
608-709-808-809-913-1013-1113-2219-2224 (Telai 314.xxx-316.xxx-318.xxx-385.xxx)  
Parte Superiore / Upper Side

CEI no.

225.011

O.E.M. Ref  
385 350 0206  
381 350 0306

**Barra / Arm**  
**Size / Misure**  
L = 612 mm  
Tube Ø 48 mm

**Repair Kit**

NESSUNA IMMAGINE  
NO PICTURE

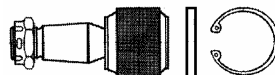

226.013  
000 350 1013

**Repair Kit**

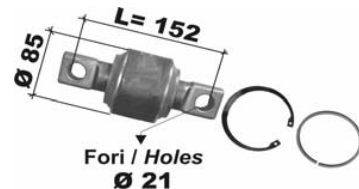

**226.011**  
000 350 0613

**Models NG (Old Range)**  
2219-2224 (Telai 385.xxx)  
Parte Inferiore / Lower Side

All original equipment manufacturers numbers, symbols, pictures, models and description used in this catalogue are for reference only, and it is not implied that any part listed is the product of these manufacturers. Tutti i nostri particolari non sono originali ma con essi intercambiabili. I riferimenti originali, le figure, i modelli sono esposti a semplice titolo indicativo. La nostra produzione riporta il nostro marchio.

CEI no.

225.087

O.E.M. Ref

381 350 0206

383 350 0006

**Barra / Arm**  
**Size / Misure**  
**L = 595 mm**  
**Tube Ø 50 mm**

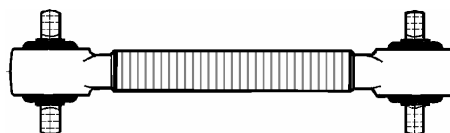

NESSUNA IMMAGINE - NO PICTURE

**Repair Kit**



**198.642**

000 586 1433

**Repair Kit W/OUT PIN**



**198.644**

000 586 1533

**Models NG (Old Range)**

2226-2232-2626-2632 (Telai 393.xxx-395.xxx)

**Parte Anteriore Superiore / Upper Front Side**

CEI no.

225.088

O.E.M. Ref

395 320 0132

**Barra / Arm**  
**Size / Misure**  
**L = 568 mm**  
**Tube Ø 50 mm**

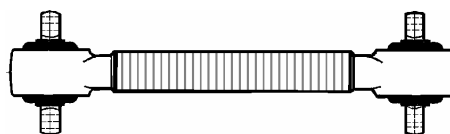

NESSUNA IMMAGINE - NO PICTURE

**Repair Kit**



**198.642**

000 586 1433

**Repair Kit W/OUT PIN**



**198.644**

000 586 1533

**Models NG (Old Range)**

2226-2232-2626-2632 (Telai 393.xxx-395.xxx)

**Parte Posteriore Superiore / Upper Rear Side**

All original equipment manufacturer's numbers, symbols, pictures, models and description used in this catalogue are for reference only, and it is not implied that any part listed is the product of these manufacturers. Tutti i nostri particolari non sono originali ma con essi intercambiabili. I riferimenti originali, le figure, i modelli sono esposti a semplice titolo indicativo. La nostra produzione riporta il nostro marchio.



CEI no.

225.007

O.E.M. Ref  
395 320 1532

Barra / Arm  
Size / Misure  
L = 628 mm  
Tube Ø 50 mm



**Repair Kit**



**198.642**

000 586 1433

**Repair Kit W/OUT PIN**



**198.644**

000 586 1533

**Models NG (Old Range)**

2226-2232-2626-2632 (Telai 393.xxx-395.xxx)

Parte Inferiore (Anteriore e Posteriore) / Lower Side (Front and Rear)

CEI no.

225.089

O.E.M. Ref  
393 320 0232

Barra / Arm  
Size / Misure  
L = 627 mm  
Tube Ø 50 mm

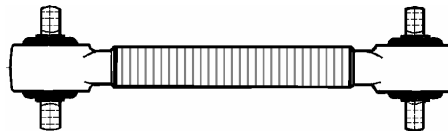

NESSUNA IMMAGINE - NO PICTURE

**Repair Kit**



**198.642**

000 586 1433

**Repair Kit W/OUT PIN**



**198.644**

000 586 1533

**Models NG (Old Range)**

2626-2632 (Telai 395.xxx)

Parte Anteriore Superiore / Upper Front Side

PER Parte Posteriore  
Superiore usare  
395 320 0132  
FOR Upper Rear Side use  
395 320 0132

CEI no.

225.090

O.E.M. Ref  
395 320 1432

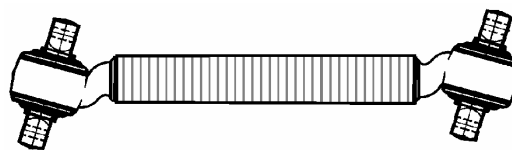

NESSUNA IMMAGINE - NO PICTURE

**Barra / Arm**  
**Size / Misure**  
L = 638 mm  
Tube Ø 50 mm

**Repair Kit**



**198.642**

000 586 1433

**Repair Kit W/OUT PIN**



**198.644**

000 586 1533

**Models NG (Old Range)**

2626-2632 (Telai 395.xxx)

**Parte Inferiore (Anteriore e Posteriore) / Lower Side (Front and Rear)**

CEI no.

225.091

O.E.M. Ref  
385 350 0006  
653 350 0006



NESSUNA IMMAGINE - NO PICTURE

**Barra / Arm**  
**Size / Misure**  
L = 500 mm  
Tube Ø 50 mm

**Repair Kit**



**198.642**

000 586 1433

**Repair Kit W/OUT PIN**



**198.644**

000 586 1533

**Models NG (Old Range) and MK (New Range)**

2219 (Telai 385.xxx)

2219-2220-2222 (Telai 619.xxx)

All original equipment manufacturer's numbers, symbols, pictures, models and description used in this catalogue are for reference only, and it is not implied that any part listed is the product of these manufacturers. Tutti i nostri particolari non sono originali ma con essi intercambiabili. I riferimenti originali, le figure, i modelli sono esposti a semplice titolo indicativo. La nostra produzione riporta il nostro marchio.

CEI no.

225.092

O.E.M. Ref

624 350 0606

659 350 1706

659 350 4006

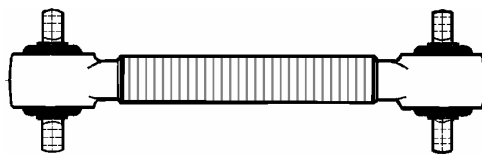

NESSUNA IMMAGINE - NO PICTURE

Repair Kit

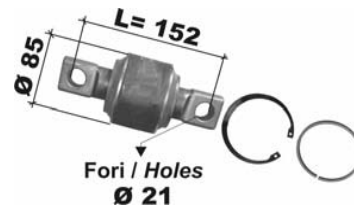

**226.011**

000 350 0613

Barra / Arm

Size / Misure

L = 629 mm

Tube Ø 50 mm

**Models MK (New Range)**

2028-2036-2628-3336 (Telai 624.xxx)

Autocarri 6x6 / 6x6 Trucks

Parte Superiore / Upper Side

CEI no.

225.093

O.E.M. Ref

624 350 0306

659 350 1406

659 350 3706

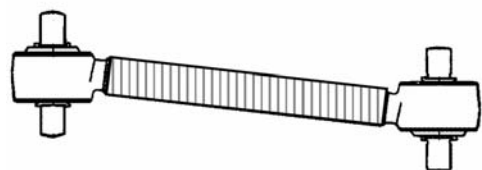

NESSUNA IMMAGINE - NO PICTURE

Repair Kit

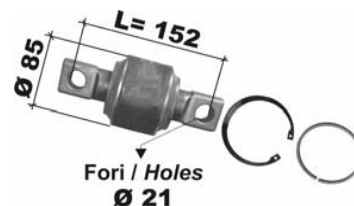

**226.011**

000 350 0613

Barra / Arm

Size / Misure

L = 629 mm

Tube Ø 50 mm

**Models MK (New Range)**

2028-2036-2628-3336 (Telai 624.xxx)

Autocarri 6x6 / 6x6 Trucks

Parte Inferiore / Lower Side

CEI no.

225.022

O.E.M. Ref

624 350 0506

659 350 1606

659 350 3906



Repair Kit



**226.039**

000 350 0113

Barra / Arm

Size / Misure

L = 629 mm

Tube Ø 58 mm

**Models NG (Old Range) and MK (New Range)**

2029-2629 (Telai 398.xxx)

3236-3244-3250-3820-3850 (Telai 625.xxx)

Parte Superiore / Upper Side

All original equipment manufacturers numbers, symbols and description used in this catalogue are for reference only, and it is not implied that any part listed is the product of these manufacturers. Tutti i nostri particolari non sono originali ma con essi intercambiabili. I riferimenti originali, le figure, i modelli sono esposti a semplice titolo indicativo. La nostra produzione riporta il nostro marchio.

**CEI no.**  
225.021

**O.E.M. Ref**  
624 350 0406  
659 350 1506  
659 350 3806

**Barra / Arm**  
**Size / Misure**  
**L = 629 mm**  
**Tube Ø 58 mm**



**226.025**  
000 350 0413

**Models NG (Old Range) and MK (New Range)**

2029-2629 (Telai 398.xxx)  
3236-3244-3250-3820-3850 (Telai 625.xxx)

**Parte Inferiore / Lower Side**

**CEI no.**  
225.094

**O.E.M. Ref**  
659 350 0106  
659 350 2406  
395 350 0206

**Barra / Arm**  
**Size / Misure**  
**L = 585 mm**  
**Tube Ø 50 mm**

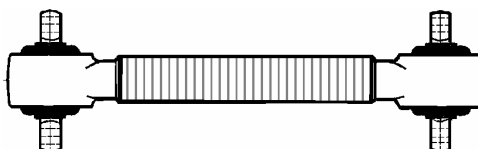

NESSUNA IMMAGINE - NO PICTURE

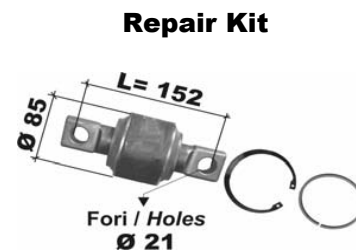

**226.011**  
000 350 0613

**Models NG (Old Range) and MK (New Range) and SK (New Range)**

2226-2232-2626-2632 (Telai 393.xxx - 395.xxx)  
2222-2225-2228-2233-2236-2238-2822-2825-2828-3025-3028-3033-3228-3328-3238-3235-3244-3250-3253-3535 (Telai 619.xxx - 623.xxx - 625.xxx)  
2422-2426-2427-2429-2433-2435-2448-2524-2527-2531-2534-2535-2538-2544-2550-2553-3238-3235-3244-3333 (Telai 653.xxx - 658.xxx)

**Parte Superiore / Upper Side**

**CEI no.**  
225.023

**O.E.M. Ref**  
659 350 0406  
659 350 2706  
395 350 0706

**Barra / Arm**  
**Size / Misure**  
**L = 585 mm**  
**Tube Ø 50 mm**



**226.011**  
000 350 0613

**Models NG (Old Range) and MK (New Range) and SK (New Range)**

2226-2232-2626-2632 (Telai 393.xxx - 395.xxx)  
2222-2225-2228-2233-2236-2238-2822-2825-2828-3025-3028-3033-3228-3328-3238-3235-3244-3250-3253-3535 (Telai 619.xxx - 623.xxx - 625.xxx)  
2422-2426-2427-2429-2433-2435-2448-2524-2527-2531-2534-2535-2538-2544-2550-2553-3238-3235-3244-3333 (Telai 653.xxx - 658.xxx)

**Parte Inferiore / Lower Side**

All original equipment manufacturer's numbers, symbols, pictures, models and description used in this catalogue are for reference only, and it is not implied that any part listed is the product of these manufacturers. Tutti i nostri particolari non sono originali ma con essi intercambiabili. I riferimenti originali, le figure, i modelli sono esposti a semplice titolo indicativo. La nostra produzione riporta il nostro marchio.

CEI no.

225.024

O.E.M. Ref

659 350 3406

659 350 1106

624 350 0006

395 350 0006

Barra / Arm

Size / Misure

L = 579 mm

Tube Ø 58 mm



Repair Kit



**226.025**

000 350 0413

Models **NG (Old Range) and MK (New Range) and SK (New Range)**

2624-2626-2628-2632-3332 (Telai 343.xxx - 395.xxx)

2628-2633-2636-3235-2638-3050-3328-3333-3336-3338-3528-3534-3535-3536-3538-3544-3550-4435-4436-4445-4645-4836-4850-4853-5038-5436-6036 (Telai 624.xxx - 625.xxx)

2629-2631-2634-2635-2638-2644-2648-2650-2653-3335-3529-3538-3544-3548-3550-3553-4635-4645-4648-4844-4850-5053 (Telai 659.xxx)

Parte Superiore / Upper Side

CEI no.

225.095

O.E.M. Ref

659 350 1206

659 350 3506

624 350 0106

Barra / Arm

Size / Misure

L = 579 mm

Tube Ø 50 mm

NESSUNA IMMAGINE - NO PICTURE

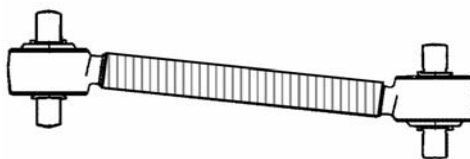

Repair Kit



**226.011**

000 350 0613

Models **NG (Old Range) and MK (New Range) and SK (New Range)**

2624-2626-2628-2632-3332 (Telai 343.xxx - 395.xxx)

2628-2633-2636-3235-2638-3050-3328-3333-3336-3338-3528-3534-3535-3536-3538-3544-3550-4435-4436-4445-4645-4836-4850-4853-5038-5436-6036 (Telai 624.xxx - 625.xxx)

2629-2631-2634-2635-2638-2644-2648-2650-2653-3335-3529-3538-3544-3548-3550-3553-4635-4645-4648-4844-4850-5053 (Telai 659.xxx)

Parte Inferiore / Lower Side

CEI no.

225.096

O.E.M. Ref

659 350 1906

659 350 4206

625 350 0106

Barra / Arm

Size / Misure

L = 645 mm

Tube Ø 58 mm

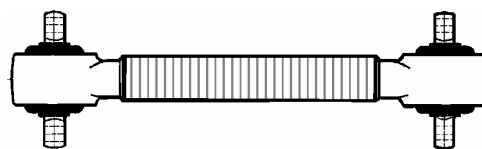

NESSUNA IMMAGINE - NO PICTURE

Repair Kit



**226.039**

000 350 0113

Models **MK (New Range)**

4050-4850 (Telai 625.xxx) Veicoli 8x8 / Trucks 8x8

Parte Superiore / Upper Side



CEI no.

225.097

O.E.M. Ref

659 350 0906

659 350 3206

395 350 1206

395 350 1106

**Barra / Arm**

**Size / Misure**

**L = 635 mm**

**Tube Ø 58 mm**

NESSUNA IMMAGINE - NO PICTURE

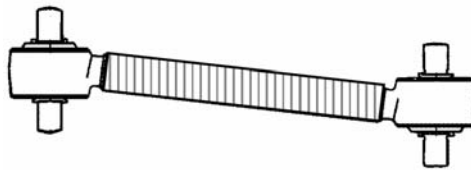

**Repair Kit**

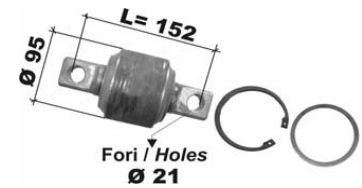

**226.025**

000 350 0413

**Models MK (New Range)**

4050-4850 (Telai 625.xxx) Veicoli 8x8 / Trucks 8x8

Parte Inferiore / Lower Side

CEI no.

225.098

O.E.M. Ref

653 350 0106

381 350 0606

**Barra / Arm**

**Size / Misure**

**L = 522 mm**

**Tube Ø 52 mm**

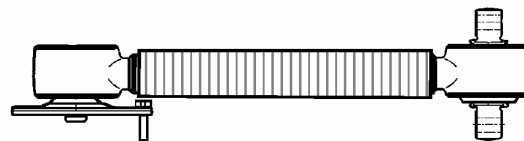

NESSUNA IMMAGINE - NO PICTURE

**Repair Kit A**

NESSUNA IMMAGINE  
NO PICTURE

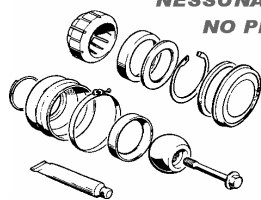

**226.129**

000 350 0205

**Repair Kit B**



**198.642**

000 350 0213

**Note**

Vecchio Tipo Sostituito da  
652 350 0306

Old Type - Replaced By  
652 350 0306

**Models NG (Old Range) and MK (New Range) and SK (New Range)**

1017-1217-1419-1424-1613-1617-1619-1624-2219 (Telai 380.xxx-381.xxx-383.xxx-385.xxx)

1419-1420-1422-1425-1617-1620-1622-1625-1628-1733-2219-2220-2222-2225-2425-2428-2432-2433 (Telai 616.xxx-617.xxx-619.xxx)

1420-1422-1424-1426-1427-1431-1717-1720-1722-1726-1727-1729-1732-1733-1820-1824-1827-1831-1834-2320-2327-2420-2422-2427-2433-2434-2524-2527-2531-2533-3231-3234 (Telai 651.xxx-652.xxx-653.xxx)



CEI no.

225.010

O.E.M. Ref  
652 350 0306

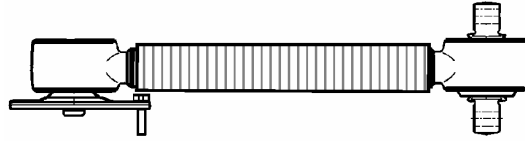

NESSUNA IMMAGINE - NO PICTURE

Barra / Arm  
Size / Misure  
L = 522 mm  
Tube Ø 52 mm

**Note**

Nuovo Tipo  
New Type

**Repair Kit A**

NESSUNA IMMAGINE  
NO PICTURE

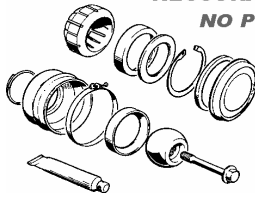

226.130  
000 350 1905

**Repair Kit B**

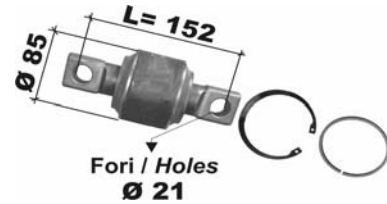

**226.011**  
000 350 0613

**Models NG (Old Range) and MK (New Range) and SK (New Range)**

1017-1217-1419-1424-1613-1617-1619-1624-2219 (Telai 380.xxx-381.xxx-383.xxx-385.xxx)

1419-1420-1422-1425-1617-1620-1622-1625-1628-1733-2219-2220-2222-2225-2425-2428-2432-2433 (Telai 616.xxx-617.xxx-619.xxx)

1420-1422-1424-1426-1427-1431-1717-1720-1722-1726-1727-1729-1732-1733-1820-1824-1827-1831-1834-2320-2327-2420-2422-2427-2433-2434-2524-2527-2531-2533-3231-3234 (Telai 651.xxx-652.xxx-653.xxx)

Sostituisce / Replaced

**343 320 1632**

CEI no.

225.099

O.E.M. Ref  
654 350 0506  
654 350 0406  
654 352 0005

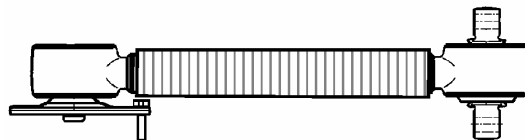

NESSUNA IMMAGINE - NO PICTURE

Barra / Arm  
Size / Misure  
L = 652 mm  
Tube Ø 52 mm

**Note**

**Repair Kit A**

NESSUNA IMMAGINE  
NO PICTURE

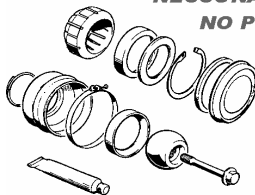

226.130  
000 350 1905

**Repair Kit B**



**226.011**  
000 350 0613

**Models SK (New Range)**

2420-2422-2426-2433-2522-2524-2527-2531-2534 (Telai 654.xxx)

Parte Sinistra e Destra / Left and Right side

All original equipment manufacturers numbers, symbols, pictures, models and description used in this catalogue are for reference only, and it is not implied that any part listed is the product of these manufactures. Tutti i nostri particolari non sono originali ma con essi intercambiabili. I riferimenti originali, le figure, i modelli sono esposti a semplice titolo indicativo. La nostra produzione riporta il nostro marchio.

CEI no.

**198.643**

O.E.M. Ref

655 350 0006

658 350 0206

658 350 0006

Vecchio Tipo  
Old Type

Barra / Arm

Size / Misure

L = 585 mm

Tube Ø 50 mm



Repair Kit



**226.011**

000 350 0613

**Models NG (Old Range) and MK (New Range) and SK (New Range)**

1626-1632-1926-1932-2226-2232 (Telai 387.xxx-389.xxx-393.xxx)

1628-1633-1636-1733-1928-2228-2233-2236-2238-2428-2433-3025-3028-3038-3228-3233  
(Telai 620.xxx-621.xxx-623.xxx-625.xxx)

1729-1735-1748-1850-2429-2434-2435-2448-2531-2535-2538-2544-2550-3238-3235-3244-3250- (Telai 655.xxx-658.xxx)

CEI no.

225.005

O.E.M. Ref

620 350 0106

620 350 0006

Nuovo Tipo con Kit  
New Type with Kit

Barra / Arm

Size / Misure

L = 595 mm

Tube Ø 62 mm

Alternativa a / Alter. To

**655 350 0306**



NESSUNA IMMAGINE - NO PICTURE

Repair Kit



**198.642**

000 586 1433

**Models MK (New Range) and SK (New Range)**

1628-1633-1636-1638-1928-1933-1936-2028-2033-2036 (Telai 620.xxx-621.xxx-622.xxx)

1729-1735-1748-1831-1834-1838-1844-1850-1929-2429-2448-2435-2531-2534-2538-2544-2550-2553-3235-3238-3244-3250- (Telai 655.xxx-656.xxx-657.xxx-658.xxx)

CEI no.

225.009

O.E.M. Ref

655 350 0306

655 350 0506

Nuovo Tipo con S-Block  
New Type with S-Block

Barra / Arm

Size / Misure

L = 595 mm

Tube Ø 62 mm

Alternativa a / Alter. To

**620 350 0106**



NESSUNA IMMAGINE - NO PICTURE

Repair Kit



**226.011**

000 350 0613

**Models MK (New Range) and SK (New Range)**

1628-1633-1636-1638-1928-1933-1936-2028-2033-2036 (Telai 620.xxx-621.xxx-622.xxx)

1729-1735-1748-1831-1834-1838-1844-1850-1929-2429-2448-2435-2531-2534-2538-2544-2550-2553-3235-3238-3244-3250- (Telai 655.xxx-656.xxx-657.xxx-658.xxx)

All original equipment manufacturers' numbers, symbols, pictures, models and description used in this catalogue are for reference only, and it is not implied that any part listed is the product of these manufacturers. Tutti i nostri particolari non sono originali ma con essi intercambiabili. I riferimenti originali, le figure, i modelli sono esposti a semplice titolo indicativo. La nostra produzione riporta il nostro marchio.

CEI no.

225.100

O.E.M. Ref  
974 330 0107

**Barra / Arm**  
**Size / Misure**  
**L = 813 mm**  
**Tube Ø 48 mm**

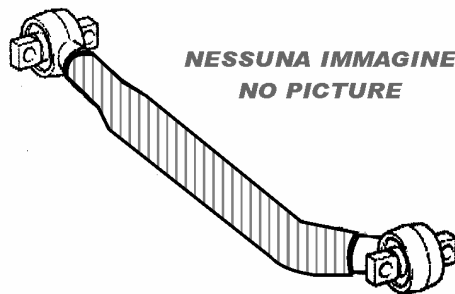

NESSUNA IMMAGINE  
NO PICTURE

**Repair Kit A**

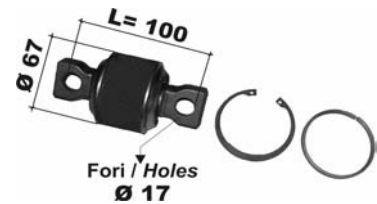

226.074  
000 330 1411

**Models ATEGO and New ATEGO**

1214-1228-1317-1328-1517-1528 (Telai 970.xxx)

**Braccio TRASVERSALE / TRANSVERSAL Arm**

**Sospensione Pneumatica / Pneumatic Suspension**

CEI no.

225.101

O.E.M. Ref  
972 330 0211

**Barra / Arm**  
**Size / Misure**  
**L = 748 mm**  
**Tube Ø 50 mm**

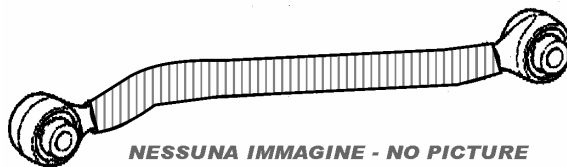

NESSUNA IMMAGINE - NO PICTURE

**Repair Kit**



NESSUNA IMMAGINE  
NO PICTURE

226.131  
000 330 1711

**Models ATEGO and New ATEGO**

1214-1228-1317-1328-1517-1528 (Telai 970.xxx)

**Braccio LONGITUDINALE - Parte Sinistra / LENGTHWISE Arm - Left Side**

**Sospensione Pneumatica / Pneumatic Suspension**

CEI no.

225.102

O.E.M. Ref  
972 330 0311

**Barra / Arm**  
**Size / Misure**  
**L = 748 mm**  
**Tube Ø 50 mm**

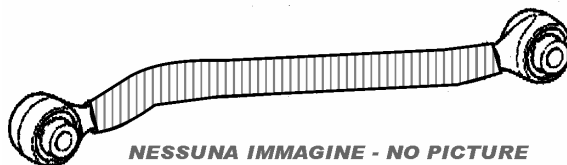

NESSUNA IMMAGINE - NO PICTURE

**Repair Kit**



NESSUNA IMMAGINE  
NO PICTURE

226.131  
000 330 1711

**Models ATEGO and New ATEGO**

1214-1228-1317-1328-1517-1528 (Telai 970.xxx)

**Braccio LONGITUDINALE - Parte Destra / LENGTHWISE Arm - Right Side**

**Sospensione Pneumatica / Pneumatic Suspension**

CEI no.

225.103

O.E.M. Ref

948 350 1205

948 350 0805

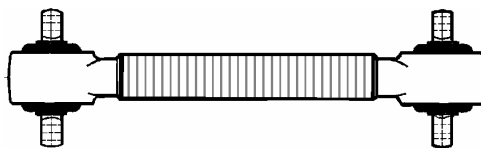

NESSUNA IMMAGINE - NO PICTURE

Repair Kit



**226.073**

000 350 2705

In alternativa / Alternative

**948 350 2405**

Barra / Arm

Size / Misure

L = 565 mm

Tube Ø 50 mm

**Models ACTROS and NEW ACTROS (MP II)**

2628-2631-2635-2640-2643-2646-2653-2654-2657-3231-3235-3240-3241-3243-3244-3331-3340-3343-3346-3348-3353-3354-3357-3358-4140-4143-4146-4148 (Telai 930.xxx-932.xxx-933.xxx-934.xxx-950.xxx-952.xxx-953.xxx-954.xxx)

CEI no.

225.104

O.E.M. Ref

948 350 2405

948 350 2005

948 350 1305

NESSUNA IMMAGINE - NO PICTURE

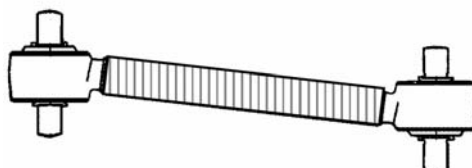

Repair Kit



**226.073**

000 350 2705

In alternativa / Alternative

**948 350 1205**

Barra / Arm

Size / Misure

L = 565 mm

Tube Ø 50 mm

**Models ACTROS and NEW ACTROS (MP II)**

2628-2631-2635-2640-2643-2646-2653-2654-2657-3231-3235-3240-3241-3243-3244-3331-3340-3343-3346-3348-3353-3354-3357-3358-4140-4143-4146-4148 (Telai 930.xxx-932.xxx-933.xxx-934.xxx-950.xxx-952.xxx-953.xxx-954.xxx)

CEI no.

225.105

O.E.M. Ref

948 350 2505

948 350 1005

945 350 0105

NESSUNA IMMAGINE - NO PICTURE

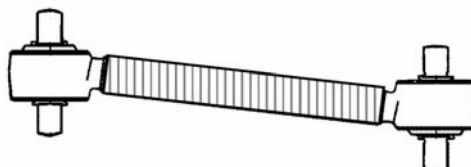

Repair Kit



**226.073**

000 350 2705

Barra / Arm

Size / Misure

L = 615 mm

Tube Ø 52 mm

**Models ACTROS and NEW ACTROS (MP II)**

3331-3340-3343-3346-3348-3350-3353-3354-3357-3358-4140-4148-4143-4146-4148-4150 (Telai 930.xxx-932.xxx-933.xxx-934.xxx-950.xxx-952.xxx-953.xxx-954.xxx)

Assali con distanza maggiorata (1450 mm) / Oversized lengthed Axles (1450 mm)

All original equipment manufacturer's numbers, symbols, pictures, models and description used in this catalogue are for reference only, and it is not implied that any part listed is the product of these manufacturers. Tutti i nostri particolari non sono originali ma con essi intercambiabili. I riferimenti originali, le figure, i modelli sono esposti a semplice titolo indicativo. La nostra produzione riporta il nostro marchio.

CEI no.

225.106

O.E.M. Ref  
941 330 0007

Barra / Arm  
Size / Misure  
L = 845 mm  
Tube Ø 60 mm

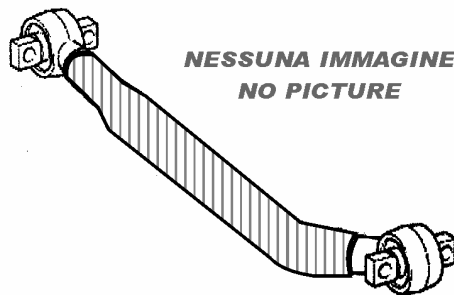

Repair Kit

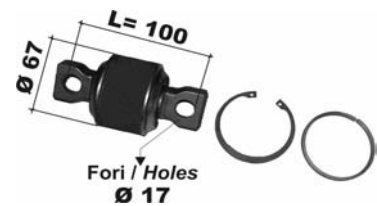

226.074  
000 330 1411

Models **ACTROS, New ACTROS & Maxi-ATEGO (Latest Range)**

1831-1832-1835-1840-1843-1846-1848-1853-1854-1857-1858-2531-2532-2535-2543-2548-2553-2554-2557-2558-2631-2640-2648-2650-2657-2658 (Telai 930-934-950-954.xxx)

1823-1828-2528-2628 (Telai 950.500÷699 - 957.500÷699)

Braccio TRASVERSALE / TRANSVERSAL Arm  
Sospensione Pneumatica / Pneumatic Suspension

CEI no.

225.107

O.E.M. Ref  
941 330 0011

Barra / Arm  
Size / Misure  
L = 754 mm  
Tube Ø 58 mm

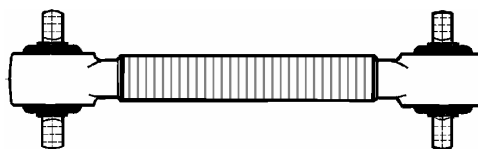

Repair Kit

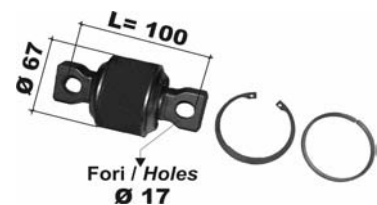

226.074  
000 330 1411

Models **ACTROS, New ACTROS & Maxi-ATEGO (Latest Range)**

1831-1832-1835-1840-1843-1846-1848-1853-1854-1857-1858-2531-2532-2535-2543-2548-2553-2554-2557-2558-2631-2640-2648-2650-2657-2658 (Telai 930-934-950-954.xxx)

1823-1828-2528-2628 (Telai 950.500÷699 - 957.500÷699)

Braccio ASSALE / AXLE Arm  
Sospensione Pneumatica / Pneumatic Suspension

CEI no.

225.108

O.E.M. Ref  
945 330 0011

Barra / Arm  
Size / Misure  
L = 755 mm  
Tube Ø 58 mm

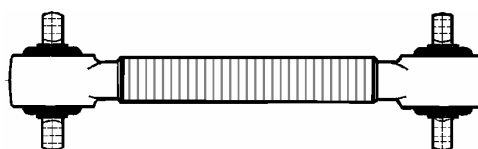

Repair Kit

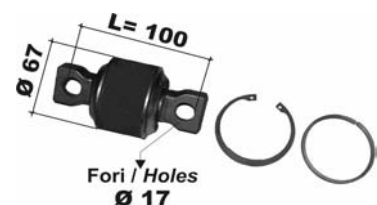

226.074  
000 330 1411

Models **ACTROS, New ACTROS & Maxi-ATEGO (Latest Range)**

2531-2535-2536 (Telai 930.xxx-934.xxx-950.xxx-954.xxx)

2523-2528 (Telai 950.600÷699)

Braccio 3° ASSE / 3RD AXLE Arm  
Sospensione Pneumatica / Pneumatic Suspension

CEI no.

225.109

O.E.M. Ref  
357 333 0905  
357 333 0605

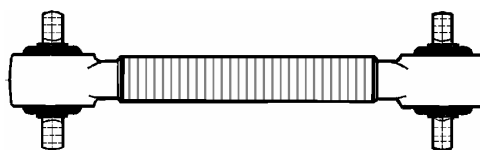

NESSUNA IMMAGINE - NO PICTURE

Repair Kit



**226.018**

000 330 0707

Barra / Arm

Size / Misure

L = 662 mm

Tube Ø 50 mm

Models **BUSES**

O 405 CITARO (Telai 357.xxx-612.xxx)

Parte Superiore / Upper Side

Sospensione Pneumatica / Pneumatic Suspension

CEI no.

225.110

O.E.M. Ref  
357 333 0205

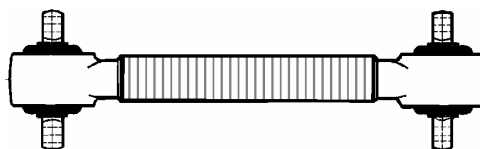

NESSUNA IMMAGINE - NO PICTURE

Repair Kit

NESSUNA IMMAGINE  
NO PICTURE



**226.098**

000 330 0611

Barra / Arm

Size / Misure

L = 750 mm

Tube Ø 48 mm

Models **BUSES**

O 405 CITARO (Telai 357.xxx-612.xxx)

Parte Inferiore / Lower Side

Sospensione Pneumatica / Pneumatic Suspension

All original equipment manufacturer's numbers, symbols, pictures, models and description used in this catalogue are for reference only, and it is not implied that any part listed is the product of these manufacturers. Tutti i nostri particolari non sono originali ma con essi intercambiabili. I riferimenti originali, le figure, i modelli sono esposti a semplice titolo indicativo. La nostra produzione riporta il nostro marchio.



CEI no.

225.111

O.E.M. Ref

8226357000

8226232000

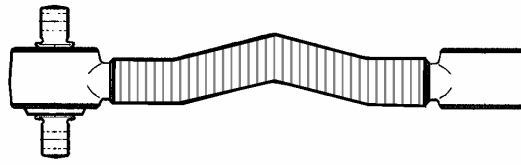

NESSUNA IMMAGINE - NO PICTURE

**Repair Kit A**



**226.018**

8226232066

**Repair Kit B**

2 pezzi / 2 pcs.



NESSUNA IMMAGINE  
NO PICTURE

4771347000

**Barra / Arm**  
**Size / Misure**  
**L = 660 mm**  
**Tube Ø 50 mm**

**Models**

**S 210 - S 211 - S 213 - S 215 - S 216 - SG219 SL - SG 221 UL - S 228**

**Sospensione Pneumatica / Pneumatic Suspension**

All original equipment manufacturers' numbers, symbols, pictures, models and description used in this catalogue are for reference only, and it is not implied that any part listed is the product of these manufacturers.  
Tutti i nostri particolari non sono originali ma con essi intercambiabili. I riferimenti originali, le figure, i modelli sono esposti a semplice titolo indicativo. La nostra produzione riporta il nostro marchio.

CEI no.  
225.152

O.E.M. Ref  
81 43270 6053  
81 43270 9053

**Barra a V / V-Stay**

Size / Misure  
L = 693 mm  
L1 = 693 mm  
Tube Ø 46 mm

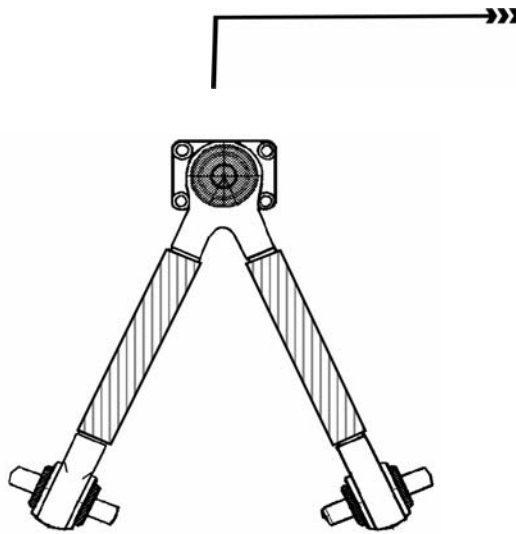

NESSUNA IMMAGINE - NO PICTURE

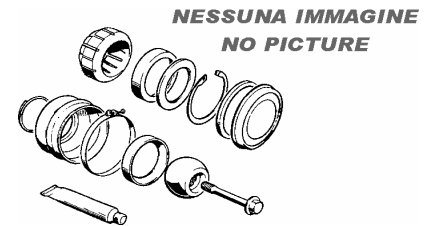

NESSUNA IMMAGINE  
NO PICTURE

**Kit A**  
226.103  
81 43270 6065



NESSUNA IMMAGINE  
NO PICTURE

**Kit B**  
226.102  
81 43230 6051

**Sos. Pneumatiche**  
Pneumatic Susp.

**Models L2000 - M90 - M2000**

12 Ton / 13 Ton / 14 Ton / 15 Ton / 18 Ton / 19 Ton (Telai L xx Year 95 →)

12 Ton / 13 Ton / 14 Ton / 15 Ton / 18 Ton / 23 Ton / 24 Ton / 25 Ton (Mxx Year 88' →)

CEI no.

**198.561**

O.E.M. Ref  
81 43270 6076  
81 43270 6078  
81 43270 6082  
81 43270 6054  
81 43270 6034

**Barra a V / V-Stay**

Size / Misure  
L = 621 mm  
L1 = 621 mm  
Tube Ø 58 mm



**Kit A W/Pin**    **Kit A W/out Pin**  
**198.440**        **226.014**  
81 95301 6132        CEI

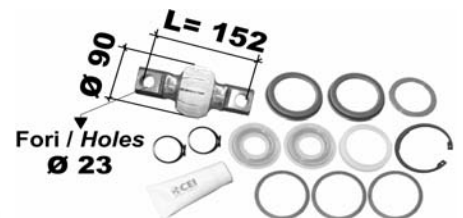

**Kit B W/Ball**    **Kit B W/out Ball**  
**198.461**        **226.015**  
81 95301 6132        CEI

**Sos. Pneumatiche**  
Pneumatic Susp.

**Models F90 - F2000**

16.281÷361 / 19.281÷361 / 22.281÷361 / 24.281÷361 / 26.281÷361 / 32.281÷361 / 33.281÷361 / 34.281÷361 (Telai 503÷509 Year 79'÷90')

16 Ton / 17 Ton / 19 Ton / 24 Ton / 26 Ton / 28 Ton / 30 Ton / 31 Ton / 32 Ton / 33 Ton 34 Ton 35 Ton (Telai E xx- F xx- T xx- U xx Year 85' →)

All original equipment manufacturer's numbers, symbols, pictures, models and description used in this catalogue are for reference only, and it is not implied that any part listed is the product of these manufactures. Tutti i nostri particolari non sono originali ma con essi intercambiabili. I riferimenti originali, le figure, i modelli sono esposti a semplice titolo indicativo. La nostra produzione riporta il nostro marchio.

CEI no.

225.153

O.E.M. Ref

81 43270 6077  
81 43270 6081  
81 43270 6075  
81 43270 6067  
81 43270 6056

**Barra a V / V-Stay**

Size / Misure

L = 627 mm  
L 1 = 627 mm  
Tube Ø 58 mm

**Sos. Meccaniche**  
Mechanical Susp.

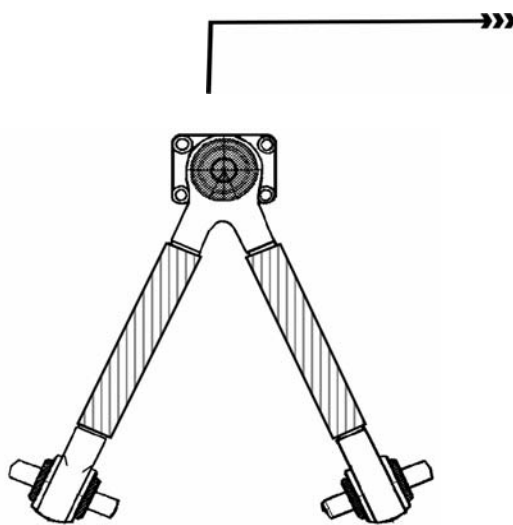

NESSUNA IMMAGINE - NO PICTURE



**Kit A W/Pin**  
**198.440**

81 95301 6132

**Kit A W/out Pin**  
**226.014**

CEI



Fori / Holes  
Ø 23

**Kit B**  
**226.064**

81 43270 6079

**Models F2000**

24 Ton / 26 Ton / 28 Ton / 30 Ton / 31 Ton / 32 Ton / 33 Ton 34 Ton 35 Ton (Telai F xx- T xx Year 88' →)

Veicoli con Ponti Tandem (CAVA-CANTIERE) / Trucks with Tandem Axle (DUMPER)

CEI no.

225.183

O.E.M. Ref

81 43270 6129  
81 43270 6130  
81 43270 6131

**Barra a V / V-Stay**

Size / Misure

L = 642 mm  
L 1 = 642 mm  
Tube Ø 48 mm

**Sos. Pneumatiche**  
Pneumatic Susp.



NESSUNA IMMAGINE  
NO PICTURE



**Kit B**  
**226.125**  
81 43270 6134



Fori / Holes  
Ø 19

**Kit B**  
**226.117**  
81 43270 6119

**Models TGM**

15 Ton / 16 Ton / 18 Ton (Telai N xx Year 04' →)

All original equipment manufacturers numbers, symbols, pictures, models and description used in this catalogue are for reference only, and it is not implied that any part listed is the product of these manufacturers. Tutti i nostri particolari non sono originali ma con essi intercambiabili. I riferimenti originali, le figure, i modelli sono esposti a semplice titolo indicativo. La nostra produzione riporta il nostro marchio.

CEI no.

**225.154**

O.E.M. Ref  
81 43270 6096  
81 43270 6121  
81 43270 6114  
81 43220 6221

**Barra a V / V-Stay**

Size / Misure  
L = 627 mm  
L1 = 627 mm  
Tube Ø 48 mm

**Sos. Pneumatiche**  
Pneumatic Susp.



**Kit A W/Pin**    **Kit A W/out Pin**  
**198.440**        **226.014**  
81 95301 6132        CEI



Fori / Holes  
Ø 25  
**Kit B**  
**226.075**  
81 43270 6105

**Models TGA**  
18 Ton / 26 Ton / 33 Ton / 35 Ton (Telai Hxx Year 99' →)

CEI no.

**225.170**

O.E.M. Ref  
81 43270 6102  
81 43270 6106  
81 43270 6108

**Barra a V / V-Stay**  
Size / Misure

**Sos. Pneumatiche**  
Pneumatic Susp.



**Kit A**

**Kit B**

**Models TGA**  
18 Ton / 26 Ton / 33 Ton / 39 Ton / 41 Ton (Telai Hxx Year 99' →)

All original equipment manufacturer's numbers, symbols, pictures, models and description used in this catalogue are for reference only, and it is not implied that any part listed is the product of these manufactures. Tutti i nostri particolari non sono originali ma con essi intercambiabili. I riferimenti originali, le figure, i modelli sono esposti a semplice titolo indicativo. La nostra produzione riporta il nostro marchio.

CEI no.  
225.174  
O.E.M. Ref  
81 43270 6117

**Barra a V / V-Stay**  
Size / Misure  
L = 627 mm  
L 1 = 627 mm  
Tube Ø 58 mm

**Sos. Paraboliche**  
Parabolic Susp.

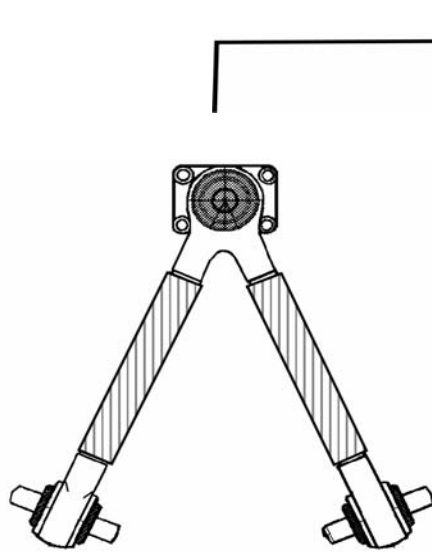

NESSUNA IMMAGINE - NO PICTURE



**Kit A W/Pin**      **Kit A W/out Pin**  
**198.440**      **226.014**  
81 95301 6132      CEI



**Kit B**  
226.126  
81 43270 6126

**Models TGA**

26 Ton / 33 Ton / 35 Ton / 40 Ton / 41 Ton (Telai H xx Year 01' →)  
Assali con sospensioni a molle paraboliche : HP1352 - HPD 1382 CON  
Axles with Parabolic Suspension : HP1352 - HPD 1382 CON

CEI no.  
225.176  
O.E.M. Ref  
81 43220 6271  
81 43220 6282  
81 43220 6314

**Barra a V / V-Stay**  
Size / Misure  
L = 572 mm

**Sos. Pneumatiche**  
Pneumatic Susp.

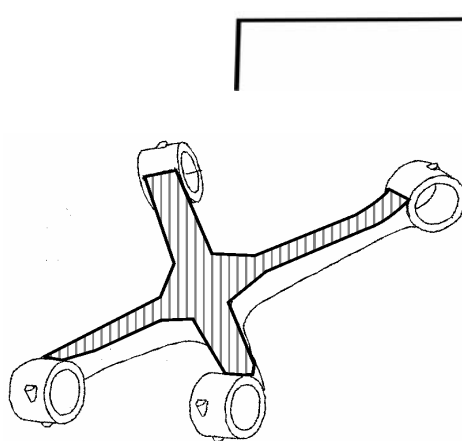

NESSUNA IMMAGINE - NO PICTURE

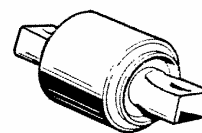

NESSUNA IMMAGINE  
NO PICTURE

**Kit A**  
226.127  
81 43220 6285

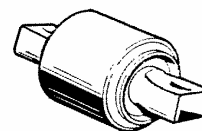

NESSUNA IMMAGINE  
NO PICTURE

**Kit B**  
226.127  
81 43220 6285

**Models TGA**

18 Ton / 26 Ton (Telai H xx Year 99' →)  
Versione stradale con pacchetto speciale carichi pesanti

All original equipment manufacturer's numbers, symbols, pictures, models and description used in this catalogue are for reference only, and it is not implied that any part listed is the product of these manufacturers. Tutti i nostri particolari non sono originali ma con essi intercambiabili. I riferimenti originali, le figure, i modelli sono esposti a semplice titolo indicativo. La nostra produzione riporta il nostro marchio.

CEI no.

**225.112**

O.E.M. Ref  
81 43220 6247

**Barra 1**  
Dx / Rh

CEI no.

**225.112**

O.E.M. Ref  
81 43220 6247

**Barra 2**  
Sx / Lf

**Sos. Pneumatiche**  
Pneumatic Susp.

Size / Misure  
L = 414 mm  
Tube Ø 50 mm

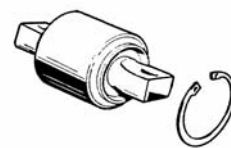

**Kit A**

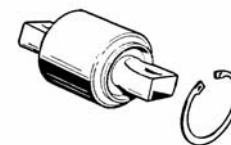

**Kit B**

**Models TGA**  
18 Ton (Telai Hxx Year 2000' →)

CEI no.

**225.155**

O.E.M. Ref  
81 43270 6087  
81 43270 6088  
81 43270 6094  
81 43270 6095

**Barra a V / V-Stay**

Size / Misure  
L = 627 mm  
L1 = 627 mm  
Tube Ø 48 mm

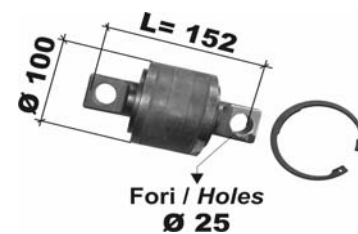

**Kit B**

**226.076**

81 43270 6110

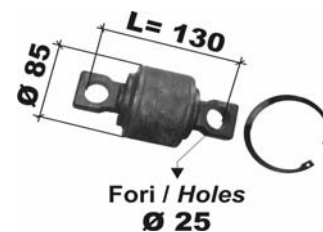

**Kit A**

**226.075**

81 43270 6105

**Sos. Meccaniche**  
Mechanical Susp.

**Models TGA**  
26 Ton / 33 Ton / 35 Ton / 40 Ton / 41 Ton / 50 Ton (Telai Hxx Year 99' →)  
Veicoli con Ponti Tandem (CAVA-CANTIERE) / Trucks with Tandem Axle (DUMPER)

All original equipment manufacturer's numbers, symbols, pictures, models and description used in this catalogue are for reference only, and it is not implied that any part listed is the product of these manufacturers. Tutti i nostri particolari non sono originali ma con essi intercambiabili. I riferimenti originali, le figure, i modelli sono esposti a semplice titolo indicativo. La nostra produzione riporta il nostro marchio.



CEI no.

225.156

O.E.M. Ref

81 43270 6039

81 43270 6037

**Barra a V / V-Stay**

Size / Misure

L = 445 mm

L 1 = 445 mm

Tube Ø 50 mm

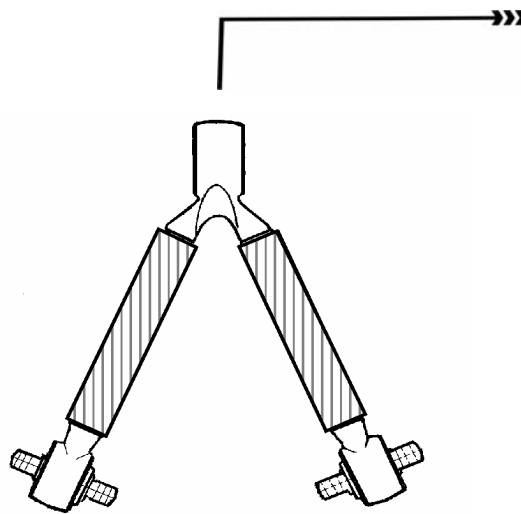

NESSUNA IMMAGINE - NO PICTURE

**Kit A**

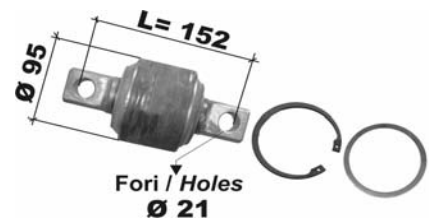

**Kit B**

**226.025**

81 43270 6040

**BUS Models**

SL200 - SG280 - SU240 - SU280

CEI no.

225.113

O.E.M. Ref

81 43230 6031

81 43230 6015

81 43230 9031

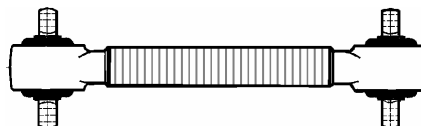

NESSUNA IMMAGINE - NO PICTURE

**Barra / Arm**  
**Size / Misure**  
**L = 595 mm**  
**Tube Ø 50 mm**

**Repair Kit**



**226.016**

81 43230 6043

**Repair Kit W/OUT PIN**



226.020

CEI

**Sosp.Pneumatiche**  
**Pneumatic Susp.**

**Models OLD RANGE**

12.157÷192 - 14.170÷192 (Telai 474-493-495 Year 82'÷89')

CEI no.

225.114

O.E.M. Ref

81 43230 6039

81 43230 6038

81 43230 9039

81 99164 8156



NESSUNA IMMAGINE - NO PICTURE

**Barra / Arm**  
**Size / Misure**  
**L = 755 mm**  
**Tube Ø 50 mm**

**Repair Kit**



**226.016**

81 43230 6043

**Repair Kit W/OUT PIN**



226.020

CEI

**Sospensioni Ant.**  
**Pneumatiche**  
**Front Pneumatic**  
**Suspension**

**Models OLD RANGE**

16.192÷372 - 19.280÷361 - 22.281÷361 - 24.281÷361 - 25.281÷361 - 26.281÷361 (Telai 470-504-506-522-754-930 Year 79'÷96')

TRANSVERSAL Arm / Braccio TRASVERSALE

All original equipment manufacturer's numbers, symbols, pictures, models and description used in this catalogue are for reference only, and it is not implied that any part listed is the product of these manufactures. Tutti i nostri particolari non sono originali ma con essi intercambiabili. I riferimenti originali, le figure, i modelli sono esposti a semplice titolo indicativo. La nostra produzione riporta il nostro marchio.

CEI no.

**225.006**

O.E.M. Ref

81 43230 6037

81 43230 9037



Barra / Arm

Size / Misure

L = 500 mm

Tube Ø 50 mm

**Repair Kit**



**226.016**

81 43230 6043

**Repair Kit W/OUT PIN**



226.020

CEI

**Sosp. Meccaniche**  
**Mechanical Susp.**

**Models OLD RANGE**

16.240÷372 - 19.280÷361 - 22.291÷361 - 24.291÷361 - 25.291÷361 (Telai  
470-504-506-522-754-930 Year 79'÷96')

CEI no.

**225.019**

O.E.M. Ref

81 43220 6052

81 43220 6020

81 43220 6041

81 43220 6056

81 43220 6026

Barra / Arm

Size / Misure

L = 565 mm

Tube Ø 50 mm

**Sosp. Meccanica**  
**Mechanical Susp.**



**Repair Kit**



**226.018**

81 43220 6055

**Models OLD RANGE**

26.281÷361 - 30.281÷361 - 32.281÷365 - 33.281÷361 - 34.281÷361 (Telai  
508-509-510-512-532-543 Year 79'÷95')

All original equipment manufacturers numbers, symbols, pictures, models and description used in this catalogue are for reference only, and it is not implied that any part listed is the product of these manufactures. Tutti i nostri particolari non sono originali ma con essi intercambiabili. I riferimenti originali, le figure, i modelli sono esposti a semplice titolo indicativo. La nostra produzione riporta il nostro marchio.

CEI no.

225.115

O.E.M. Ref

81 43220 6140

81 43220 9140

GRANDE - BIG

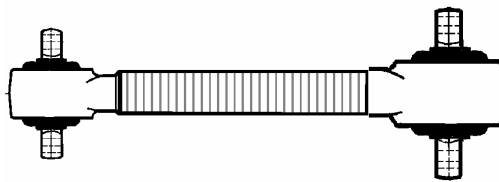

NESSUNA IMMAGINE - NO PICTURE

Repair Kit

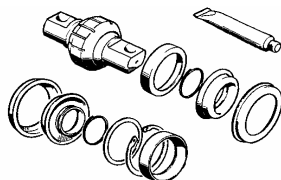

NESSUNA IMMAGINE - NO PICTURE

Repair Kit (Big)



**198.612**

81 43220 6108

Barra / Arm  
Size / Misure  
L = 596 mm  
Tube Ø 50 mm

**Sosp. Pneumatiche**  
**Pneumatic Susp.**

**Models L2000 - M2000**

12 Ton / 13 Ton / 14 Ton / 15 Ton (Telai Lxx-Mxx Year 95' →)

CEI no.

**225.008**

O.E.M. Ref

81 43220 6129

81 43220 6096

81 43220 6097

81 43220 6098

81 43220 9129

81 43230 6014

81 43230 6030



Versione **STANDARD** / **STANDARD** Version

Repair Kit



**198.612**

81 43220 6108

Repair Kit W/OUT PIN



**198.699**

CEI

Barra / Arm  
Size / Misure  
L = 570 mm

Tube Ø 48 mm

Intercambiabile con  
Interchangeable with

**225.036**

**225.168**

**Sosp. Pneumatica**  
**Pneumatic Susp.**

**Models F90- F2000**

16 Ton / 17 Ton / 19 Ton / 22 Ton / 24 Ton / 26 Ton / 27 Ton / 28 Ton / 30 Ton / 31 Ton / 32 Ton / 33 Ton / 34 Ton / 35 Ton (Telai Exx-Fxx-Txx-Uxx Year 85' →)

**Con Serie di Riparzioni - With Repair Kits**

CEI no.

**225.036**

O.E.M. Ref  
CEI

Barra / Arm  
Size / Misure  
L = 570 mm  
Tube Ø 48 mm

Sosp. Pneumatica  
Pneumatic Susp.

Repair Kit



Progetto CEI con/CEI Project with : **SILENT-BLOCK**  
Puo' Sostituire / Can be Replaced : **225.008**

**226.018**

81 43220 6055

Models **F90-F2000**

16 Ton / 17 Ton / 19 Ton / 22 Ton / 24 Ton / 26 Ton / 27 Ton / 28 Ton / 30 Ton / 31 Ton / 32 Ton / 33 Ton 34 Ton 35 Ton (Telai E xx- F xx- T xx- U xx Year 85' →)

Con Silent-Block - With Silent-Block

CEI no.

**225.168**

O.E.M. Ref  
81 43220 6129  
81 43220 6096  
81 43220 6097  
81 43220 6098  
81 43220 9129

Barra / Arm  
Size / Misure  
L = 570 mm  
Tube Ø 48 mm  
Sosp. Pneumatica  
Pneumatic Susp.

Repair Kit



Progetto LM Ultimo tipo / Project LM Latest Type  
Puo' Sostituire / Can be Replaced : **225.008**

Serie di riparazione non fornibile  
Repair kit not available

Models **F90-F2000**

16 Ton / 17 Ton / 19 Ton / 22 Ton / 24 Ton / 26 Ton / 27 Ton / 28 Ton / 30 Ton / 31 Ton / 32 Ton / 33 Ton 34 Ton 35 Ton (Telai E xx- F xx- T xx- U xx Year 85' →)

Con Silent-Block - With Silent-Block

**ULTIMO TIPO ALLEGGERITO - LATEST TYPE LIGHTENING**

CEI no.

**225.033**

O.E.M. Ref  
81 43220 6092  
81 43220 6090  
81 43220 6067

Barra / Arm  
Size / Misure  
L = 590 mm  
Tube Ø 48 mm  
Sosp. Meccanica  
Mechanical Susp.

Repair Kit



**226.018**

81 43220 6055

Models **F90-F2000**

22 Ton / 24 Ton / 25 Ton / 26 Ton / 27 Ton / 28 Ton / 30 Ton / 31 Ton / 32 Ton / 33 Ton 34 / 35 Ton / 37 Ton / 41 Ton (Telai E xx- F xx- T xx- U xx Year 90' →)

Veicoli con Ponti Tandem (CAVA-CANTIERE) / Trucks with Tandem Axle (DUMPER)

CEI no.

225.116

O.E.M. Ref

81 43220 6093

81 43220 6070

81 43220 6119

81 43220 6091

Barra / Arm

Size / Misure

L = 585 mm

Tube Ø 58 mm

Sosp. Meccanica

Mechanical Susp.

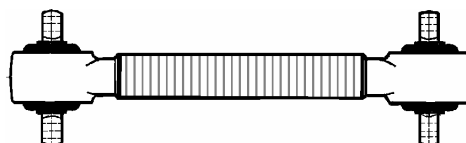

NESSUNA IMMAGINE - NO PICTURE

Repair Kit

NESSUNA IMMAGINE  
NO PICTURE



226.104

81 96401 0152

Models **F90-F2000**

22 Ton / 24 Ton / 25 Ton / 26 Ton / 27 Ton / 28 Ton / 30 Ton / 31 Ton / 32 Ton / 33 Ton 34 / 35 Ton / 37 Ton / 41 Ton (Telai E xx- F xx- T xx- U xx Year 90' →)

Veicoli con Ponti Tandem (CAVA-CANTIERE) / Trucks with Tandem Axle (DUMPER)  
Overweight Load / Carico Maggiorato

CEI no.

225.117

O.E.M. Ref

81 43220 6106

81 43220 6083

81 43220 6084

81 43220 6147

81 43230 6049

Barra / Arm

Size / Misure

L = 777 mm

Tube Ø 60 mm

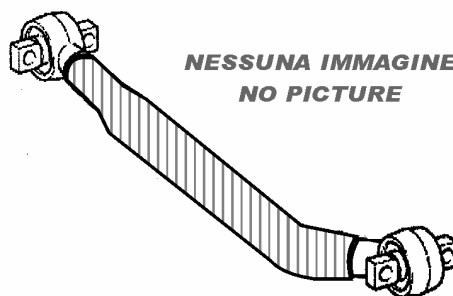

NESSUNA IMMAGINE  
NO PICTURE

Repair Kit A

NESSUNA IMMAGINE  
NO PICTURE



226.102

81 43230 6051

Models **F90-F2000**

18 Ton / 19 Ton / 22 Ton / 24 Ton / 25 Ton / 26 Ton / 27 T (Telai E-F-T-U 90' →)

TRANSVERSAL Arm / Braccio TRASVERSALE

Sospensione Pneumatica Anteriore / Front Pneumatic Suspension

CEI no.

225.177

O.E.M. Ref

81 43220 6319

Barra / Arm

Size / Misure

L = 661 mm

Tube Ø 40 mm

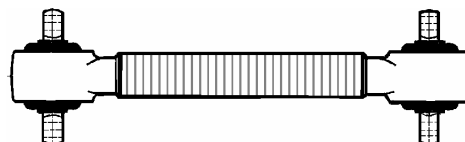

NESSUNA IMMAGINE - NO PICTURE

Repair Kit

NESSUNA IMMAGINE  
NO PICTURE



226.128

81 43230 6315

Models **TGM**

13 Ton / 15 Ton / 16 Ton / 18 Ton (Telai N xx Year 04' →)

Sospensione Pneumatica Anteriore / Front Pneumatic Suspension

All original equipment manufacturer's numbers, symbols, pictures, models and description used in this catalogue are for reference only, and it is not implied that any part listed is the product of these manufactures. Tutti i nostri particolari non sono originali ma con essi intercambiabili. I riferimenti originali, le figure, i modelli sono esposti a semplice titolo indicativo. La nostra produzione riporta il nostro marchio.



CEI no.

**225.118**

O.E.M. Ref

81 43220 6236

81 43226 6267

81 43220 6272

**Barra / Arm**

**Size / Misure**

**L = 566 mm**

**Tube Ø 50 mm**

**Sosp. Pneumatica**

**Pneumatic Susp.**



**Repair Kit**

NESSUNA IMMAGINE  
NO PICTURE

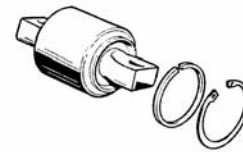

226.105

81 43220 6132

**Models TGA**

18 Ton / 26 Ton / 32 Ton / 33 Ton / 35 Ton / 41 Ton (Telai Hxx Year 99' →)

Sospensione Pneumatica/ Pneumatic Suspension

CEI no.

225.119

O.E.M. Ref

81 43220 6196

81 43220 6232

81 43220 6233

**Barra / Arm**

**Size / Misure**

**L = 596 mm**

**Tube Ø 48 mm**

**Sosp. Meccanica**

**Mechanical Susp.**

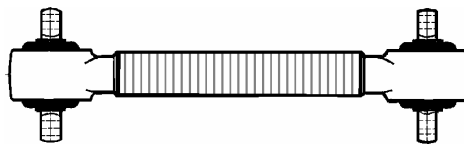

NESSUNA IMMAGINE - NO PICTURE

**Repair Kit**



226.097

81 43220 6250

**Models TGA**

26 Ton / 32 Ton / 33 Ton / 35 Ton / 40 Ton / 41 Ton / 50 Ton (Telai Hxx Year 99' →)

Veicoli con Ponti Tandem (CAVA-CANTIERE) / Trucks with Tandem Axle (DUMPER)

CEI no.

225.120

O.E.M. Ref

81 43220 6260

81 43220 6283

81 43220 6284

81 43220 6222

**Barra / Arm**

**Size / Misure**

**L = 941 mm**

**Tube Ø 60 mm**



NESSUNA IMMAGINE - NO PICTURE

**Repair Kit**

NESSUNA IMMAGINE  
NO PICTURE



226.106

81 43220 6244

**Models TGA**

18 Ton / 24 Ton / 26 Ton / 28 Ton / 33 Ton (Telai Hxx Year 99' →)

TRANSVERSAL Arm / Braccio TRASVERSALE

Sospensione Pneumatica Anteriore / Front Pneumatic Suspension

CEI no.

**225.032**

O.E.M. Ref  
81 43220 6025

**Barra / Arm**  
**Size / Misure**  
**L = 455 mm**  
**Tube Ø 50 mm**



**Models BUS**

SL 200 - SUE240 - SR280 (Telai 192-197-199-583-594 Year 77' →)

**Repair Kit**



**226.018**

81 43220 6055

CEI no.

**225.035**

O.E.M. Ref  
81 43220 6043

**Barra / Arm**  
**Size / Misure**  
**L = 661 mm**  
**Tube Ø 50 mm**



**Models BUS**

SR240 - SR280 (Telai 597 ISRAEL Year 79' →)

Upper Side / Parte Superiore

**Repair Kit**



**226.018**

81 43220 6055

CEI no.

**225.031**

O.E.M. Ref  
81 43220 6042

**Barra / Arm**  
**Size / Misure**  
**L = 762 mm**  
**Tube Ø 50 mm**



**Models BUS**

SR240 - SR280 (Telai 597 ISRAEL Year 79' →)

**Repair Kit**



**226.018**

81 43220 6055

All original equipment manufacturer's numbers, symbols, pictures, models and description used in this catalogue are for reference only, and it is not implied that any part listed is the product of these manufacturers. Tutti i nostri particolari non sono originali ma con essi intercambiabili. I riferimenti originali, le figure, i modelli sono esposti a semplice titolo indicativo. La nostra produzione riporta il nostro marchio.



**CEI no.**  
225.121  
**O.E.M. Ref**  
50 10 164 533

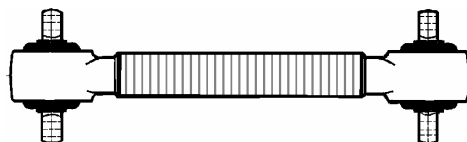

NESSUNA IMMAGINE - NO PICTURE

**Repair Kit**

NESSUNA IMMAGINE  
NO PICTURE



226.060  
50 00 823 228

**Barra / Arm**  
**Size / Misure**

**Models M - S**  
M/S 140 - 150 - 160 - 180 - 200 - 210 - 220 - 230TI - 250  
PA/PS 150 - 160 - 200 - 210  
MIDLINER

**CEI no.**  
225.122  
**O.E.M. Ref**  
00 23 123 275

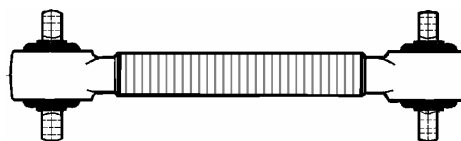

NESSUNA IMMAGINE - NO PICTURE

**Repair Kit**

**Only PIN**

**Barra / Arm**  
**Size / Misure**  
L = 535 mm  
Tube Ø 50 mm

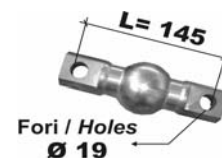

**198.674**

50 01 014 424

**107.127**

50 00 808 789

**Models GRH - TRH Series**  
GRH 235 - GRH/TRH 305 - GRH/TRH 350

**CEI no.**  
**Old Version**

**O.E.M. Ref**  
50 10 094 838  
50 10 064 641  
00 23 123 253



**Repair Kit W/OUT PIN**

**Only PIN**

*This version is  
Replaced By  
Questa versione  
e' sostituita da*  
**198.645**



**198.674**

50 01 014 424

**107.127**

50 00 808 789

**Models**  
Vedi i Modelli dell 198.645 / For Models see 198.645

All original equipment manufacturer's numbers, symbols, pictures, models and description used in this catalogue are for reference only, and it is not implied that any part listed is the product of these manufactures. Tutti i nostri particolari non sono originali ma con essi intercambiabili. I riferimenti originali, le figure, i modelli sono esposti a semplice titolo indicativo. La nostra produzione riporta il nostro marchio.

CEI no.

**198.645**

O.E.M. Ref

50 10 094 941

50 10 094 838

50 10 064 641

00 23 123 253

**Barra / Arm**

**Size / Misure**

**L = 575 mm**

**Tube Ø 52 mm**



**Repair Kit**



**226.031**

50 01 014 345

**Repair Kit W/OUT PIN**



**198.644**

50 00 819 413

**Models GICIT, "R" Series - MAGNUM - KERAX**

C/G 230-260-280-290-300 -- CBH/CLM/GBH/GRH/TBH/THR 235-260-290-305-320-350-385

"R" Fino al / Up to 1992 "R" Dal / From 1993

MAGNUM AE 380-385(TI)-390-400-420(TI)-430-440-470-480-500-520-560

KERAX Fino al / Up to 1999 (Parte Inferiore / Lower Side)

CEI no.

225.049

O.E.M. Ref

50 10 530 366

**INFERIORE**

**LOWER**

**Barra / Arm**

**Size / Misure**

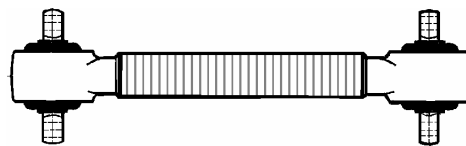

NESSUNA IMMAGINE - NO PICTURE

**Repair Kit**

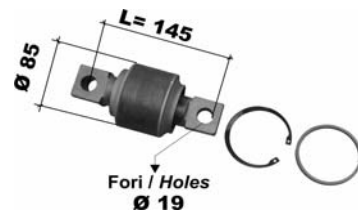

**226.050**

50 01 831 526

**Models MAGNUM - KERAX**

MAGNUM E-TECH 400-440-480 - KERAX 300.26-340.32 (Carichi Medi - Midium Load)

Lower Side / Parte Inferiore (4 pcs for Axle / 4 pezzi per assale)

Per MAGNUM la Sup. e' / For MAGNUM Upper is 50 10 094 941 (2 pcs)

Per KERAX la Sup. e' / For KERAX Upper is 50 10 467 915 (2 pcs)

CEI no.

**225.028**

O.E.M. Ref

50 10 389 262

**INFERIORE**

**LOWER**

**Barra / Arm**

**Size / Misure**

**L = 575 mm**

**Tube Ø 50 mm**



**Repair Kit**

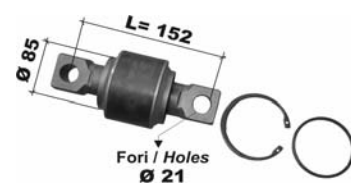

**226.052**

50 01 842 337

**Models KERAX**

KERAX 340.26-340.32-340.34-385.26-385.32-385.34-385.40 (Carichi Pesanti - Heavy Load)

Lower Side / Parte Inferiore (4 pcs for Axle / 4 pezzi per assale)

In coppia con / Together with : 50 10 094 839 / 50 10 094 840 KERAX Up to / Fino al 1999

In coppia con / Together with : 50 10 467 915 KERAX From / Dal 2000



CEI no.

**225.061**

O.E.M. Ref  
50 10 467 915

**SUPERIORE**  
**UPPER**

**Barra / Arm**  
**Size / Misure**  
**L = 575 mm**  
**Tube Ø 50 mm**



**Models KERAX**

**KERAX 300.26 - 340.32 - 340.34 - 385.26 - 385.32 - 385.34 - 385.40** Dal / From 2000  
**Upper Side / Parte Superiore (2 pcs for Axle / 2 pezzi per assale)**

In coppia con / Together with : 50 10 530 366 **KERAX (300.26-340.32)**

In coppia con / Together with : 50 10 389 262 **KERAX (340.34-385.26-385.32-385.34-385.40)**

**Repair Kit**



**226.052**

50 01 842 337

CEI no.

225.068

O.E.M. Ref  
50 10 094 840

Can be Replace By  
Puo' Essere sos da

**225.015**

**Barra / Arm**  
**Size / Misure**  
**L = 575 mm**  
**Tube Ø 48 mm**

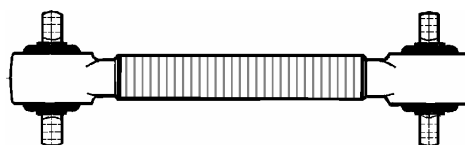

NESSUNA IMMAGINE - NO PICTURE

**Models MAXTER - KERAX**

**MAXTER - KERAX 340.26 - 340.32 - 385.26 - 385.32** Up To / Fino al 1999

**Upper Side / Parte Superiore (2 pcs for Axle / 2 pezzi per assale)**

In coppia con / Together with : 50 10 389 262

**Repair Kit**

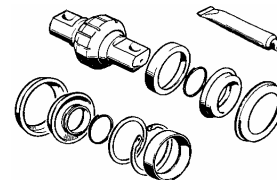

NESSUNA IMMAGINE  
NO PICTURE

**226.107**

50 01 823 278

CEI no.

**225.015**

O.E.M. Ref  
50 10 094 839

**SUPERIORE**  
**UPPER**

**Barra / Arm**  
**Size / Misure**  
**L = 575 mm**  
**Tube Ø 62 mm**



**Models MAXTER - KERAX**

**MAXTER - KERAX 340.34 - 385.34 - 385.40 - Up To / Fino al 1999**

**Upper Side / Parte Superiore (2 pcs for Axle / 2 pezzi per assale)**

In coppia con / Together with : 50 10 389 262

**Repair Kit**



**226.032**

50 01 823 280



CEI no.

225.175

O.E.M. Ref  
74 20 443 044



Repair Kit

NESSUNA IMMAGINE  
NO PICTURE



74 85 104 224

Models **PREMIUM**  
PREMIUM (PR - TR - DXI)  
Ultime Generazioni / Latest Generation

CEI no.

225.190

O.E.M. Ref  
74 20 532 931

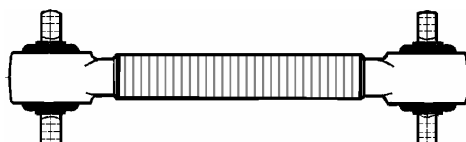

NESSUNA IMMAGINE - NO PICTURE

Repair Kit

NESSUNA IMMAGINE  
NO PICTURE



74 20 702 096

Models **KERAX**  
KERAX (DXI)

Ultime Gen. 34 FC/FF/NC/NF/SC/TC / Latest Gen. 34 FC/FF/NC/NF/SC/TC

CEI no.

225.038

O.E.M. Ref  
50 10 207 726  
50 00 869 572  
50 10 013 398

Barra / Arm  
Size / Misure  
L = 550 mm  
Tube Ø 46 mm

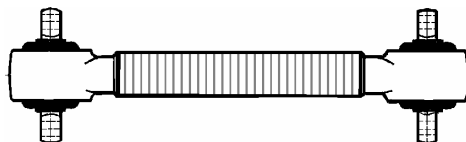

NESSUNA IMMAGINE - NO PICTURE

Repair Kit



**226.053**  
50 00 819 365

Models **BUS**  
BUS ILIADE - BUS FRH

All original equipment manufacturers numbers, symbols, pictures, models and description used in this catalogue are for reference only, and it is not implied that any part listed is the product of these manufactures. Tutti i nostri particolari non sono originali ma con essi intercambiabili. I riferimenti originali, le figure, i modelli sono esposti a semplice titolo indicativo. La nostra produzione riporta il nostro marchio.

CEI no.

225.037

O.E.M. Ref

50 10 207 727

50 00 869 573

50 10 013 397

**Barra / Arm**

**Size / Misure**

**L = 692 mm**

**Tube Ø 46 mm**

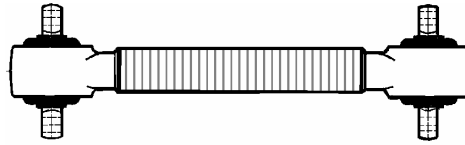

NESSUNA IMMAGINE - NO PICTURE

**Repair Kit**



**226.053**

50 00 819 365

**Models BUS**

BUS ILIADE - BUS FRH

CEI no.  
225.179

O.E.M. Ref  
1722582  
1440028

**Barra a V / V-Stay**

Size / Misure  
L = 613 mm  
L = 613 mm  
Tube Ø 46 mm

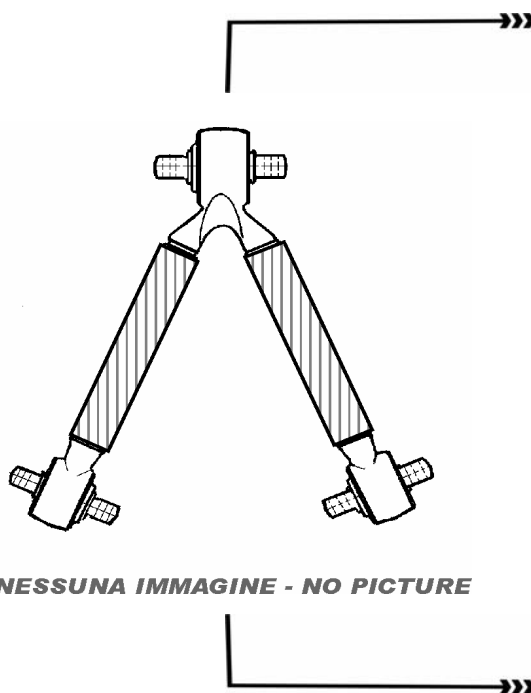

NESSUNA IMMAGINE - NO PICTURE

**Models P Series - R Series**

P / R 340 - 380 - 420 - 480 - 500 - 560 - 620

Sospensioni Pneumatiche ADA / Pneumatic suspension ADA

NESSUNA IMMAGINE  
NO PICTURE



**Kit A**

226.133  
1761964

NESSUNA IMMAGINE  
NO PICTURE

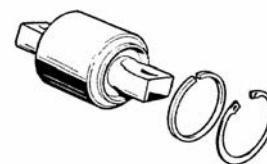

**Kit B**

226.132  
1444472

CEI no.  
225.180

O.E.M. Ref  
1740364  
1440029

**Barra a V / V-Stay**

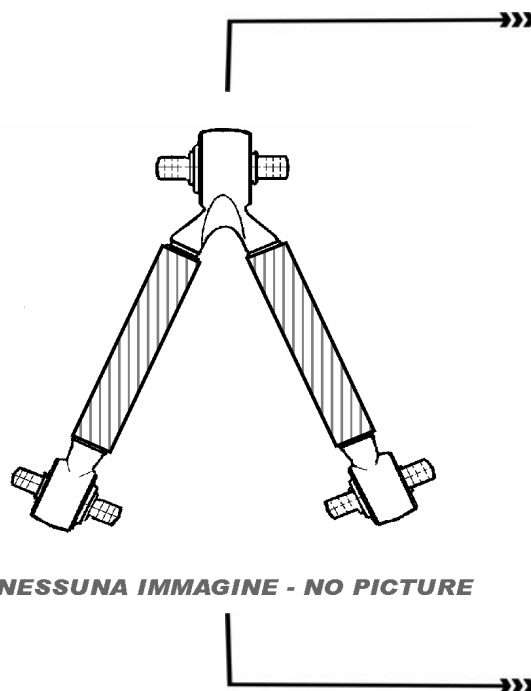

NESSUNA IMMAGINE - NO PICTURE

**Models P Series - R Series**

P / R 340 - 380 - 420 - 480 - 500 - 560 - 620

Sospensioni Pneumatiche ADA / Pneumatic suspension ADA

NESSUNA IMMAGINE  
NO PICTURE



**Kit A**

226.133  
1761964

NESSUNA IMMAGINE  
NO PICTURE



**Kit B**

226.132  
1444472

All original equipment manufacturers numbers, symbols, pictures, models and description used in this catalogue are for reference only, and it is not implied that any part listed is the product of these manufacturers. Tutti i nostri particolari non sono originali ma con essi intercambiabili. I riferimenti originali, le figure, i modelli sono esposti a semplice titolo indicativo. La nostra produzione riporta il nostro marchio.

CEI no.

**225.123**

O.E.M. Ref

1428349

1326775



**Repair Kit**



Fori / Holes  
Ø 17

**226.077**

550800

Sosp. Pneumatica Ant.

Front Pneumatic Susp.

**L = 522 mm**

**Tube Ø 46 mm**

**Models 3 - 4 Series**

C/G/L/P/R 93 - 94 - C/G/L/P/R 113 - 114

C/G/L/P/R 124 - C/G/L/P/R 143 - 144

Parte Superiore (2 pezzi per assale) / Upper Side (2 pcs for Axle)

CEI no.

225.124

O.E.M. Ref

1399180

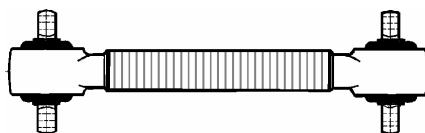

NESSUNA IMMAGINE - NO PICTURE

**Repair Kit**



Fori / Holes  
Ø 17

**226.078**

550806

Sosp. Pneumatica Ant.

Front Pneumatic Susp.

**L = 568 mm**

**Tube Ø 46 mm**

**Models 3 - 4 Series**

C/G/L/P/R 93 - 94 - C/G/L/P/R 113 - 114

C/G/L/P/R 124 - C/G/L/P/R 143 - 144

Parte Inferiore (4 pezzi per assale) / Lower Side (4 pcs for Axle)

CEI no.

**225.125**

O.E.M. Ref

1428347



**Repair Kit**



Fori / Holes  
Ø 17

**226.077**

550800

Sosp. Pneumatica Ant.

Front Pneumatic Susp.

**L = 568 mm**

**Tube Ø 46 mm**

**Models 4 Series**

C/G/L/P/R 94 - C/G/L/P/R 114

C/G/L/P/R 124 - C/G/L/P/R 144

Parte Inferiore (4 pezzi per assale) / Lower Side (4 pcs for Axle)

All original equipment manufacturer's numbers, symbols, pictures, models and description used in this catalogue are for reference only, and it is not implied that any part listed is the product of these manufacturers. Tutti i nostri particolari non sono originali ma con essi intercambiabili. I riferimenti originali, le figure, i modelli sono esposti a semplice titolo indicativo. La nostra produzione riporta il nostro marchio.

CEI no.

225.126

O.E.M. Ref

1464611

1353445

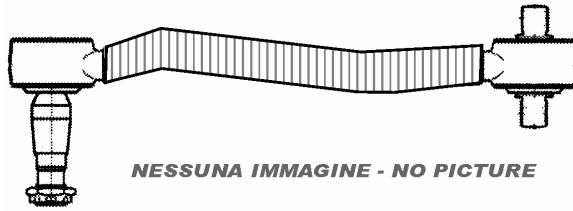

NESSUNA IMMAGINE - NO PICTURE

**Repair Kit**

NESSUNA IMMAGINE  
NO PICTURE

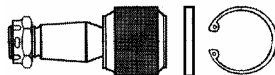

226.108

550807

**Repair Kit**

NESSUNA IMMAGINE  
NO PICTURE



226.109

550808

**Barra / Arm**  
**Size / Misure**  
**L = 705 mm**  
**Tube Ø 42 mm**

Sosp. Pneumatica Ant.  
Front Pneumatic Susp.

**Models 4 Series - R Series**

C/G/L/P/R 94 - C/G/L/P/R 114 - C/G/L/P/R 124 - C/G/L/P/R 144

Braccio TRASVERSALE / TRANSVERSAL Arm

CEI no.

225.127

O.E.M. Ref

1393298

1379423

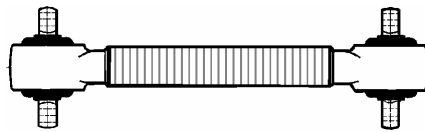

NESSUNA IMMAGINE - NO PICTURE

**Repair Kit**



Fori / Holes  
Ø 17

**226.077**

550800

Sosp. Pneumatica Ant.  
Front Pneumatic Susp.

**Models 4 Series - R Series**

C/G/L/P/R 94 - C/G/L/P/R 114 - C/G/L/P/R 124 - C/G/L/P/R 144

Braccio LONGITUDINALE / LENGTHWISE Arm

CEI no.

**225.123**

O.E.M. Ref

1428349

1326775



**Repair Kit**



Fori / Holes  
Ø 17

**226.077**

550800

**L = 522 mm**  
**Tube Ø 46 mm**  
Sosp. Parabolica BT200  
Parabolic Susp. BT200

**Models P Series - R Series**

P / R 340 - 380 - 420 - 480 - 500 - 560 - 620

Parte Superiore (2 pezzi per assale) / Upper Side (2 pcs for Axle)

CEI no.

**225.125**

O.E.M. Ref  
1428347

*L = 568 mm*  
*Tube Ø 46 mm*  
*Sosp. Parabolica BT200*  
*Parabolic Susp. BT200*



**Repair Kit**



**226.077**  
550800

**Models P Series - R Series**

P / R 340 - 380 - 420 - 480 - 500 - 560 - 620

Parte Inferiore (4 pezzi per assale) / Lower Side (4 pcs for Axle)

CEI no.

**225.184**

O.E.M. Ref  
1486758

*Sosp. Trapezoidale*  
*Trapezoidal Suspension*

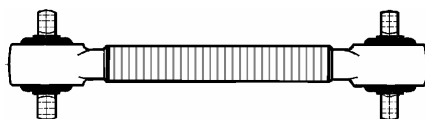

NESSUNA IMMAGINE - NO PICTURE

**Repair Kit**

NESSUNA IMMAGINE  
NO PICTURE

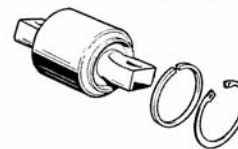

**226.134**  
1498131

**Models P Series - R Series**

P / R 340 - 380 - 420 - 480 - 500 - 560 - 620 -- "M" Type

Parte Superiore (2 pezzi per assale) / Upper Side (2 pcs for Axle)

CEI no.

**225.185**

O.E.M. Ref  
1782019

*Sosp. Trapezoidale*  
*Trapezoidal Suspension*

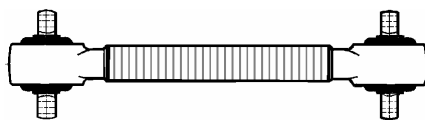

NESSUNA IMMAGINE - NO PICTURE

**Repair Kit**

NESSUNA IMMAGINE  
NO PICTURE



**226.135**  
1722753

**Models P Series - R Series**

P / R 340 - 380 - 420 - 480 - 500 - 560 - 620 -- "H/E" Type

Parte Superiore (2 pezzi per assale) / Upper Side (2 pcs for Axle)



CEI no.

225.186

O.E.M. Ref

1486756

Sosp. Trapezoidale  
Trapezoidal Suspension

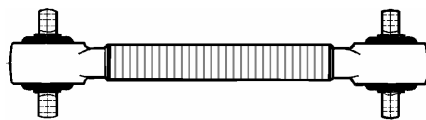

NESSUNA IMMAGINE - NO PICTURE

Repair Kit

NESSUNA IMMAGINE  
NO PICTURE



226.134

1498131

**Models P Series - R Series**

P / R 340 - 380 - 420 - 480 - 500 - 560 - 620 -- Con Freni a Disco / With Brake Discs

Parte Inferiore (4 pezzi per assale) / Lower Side (4 pcs for Axle)

CEI no.

225.187

O.E.M. Ref

1486757

1485758

Sosp. Trapezoidale  
Trapezoidal Suspension



NESSUNA IMMAGINE - NO PICTURE

Repair Kit

NESSUNA IMMAGINE  
NO PICTURE



226.134

1498131

**Models P Series - R Series**

P / R 340 - 380 - 420 - 480 - 500 - 560 - 620 "M" Type -- Con Tamburi/With Brake Drums

Parte Inferiore (4 pezzi per assale) / Lower Side (4 pcs for Axle)

CEI no.

225.188

O.E.M. Ref

1782023

Sosp. Trapezoidale  
Trapezoidal Suspension



NESSUNA IMMAGINE - NO PICTURE

Repair Kit

NESSUNA IMMAGINE  
NO PICTURE



226.135

1722753

**Models P Series - R Series**

P / R 340 - 380 - 420 - 480 - 500 - 560 - 620 "H/E" Type -- Con Tamburi/With Brake Drums

Parte Inferiore (4 pezzi per assale) / Lower Side (4 pcs for Axle)

CEI no.

225.128

O.E.M. Ref

489987

466801

**Barra / Arm**

**Size / Misure**

**L = 650 mm**

**Tube Ø 48 mm**

**Sosp. Pneumatica Post.**

**Rear Pneumatic Susp.**



**Repair Kit**



**226.018**

638862

**Models BUSES 3 - 4 Series**

**K93 - K113 - K94 - K114**

CEI no.  
225.157  
O.E.M. Ref  
1590068

**Barra a V / V-Stay**  
Size / Misure  
L = 644 mm  
L 1 = 644 mm  
Tube Ø 46 mm

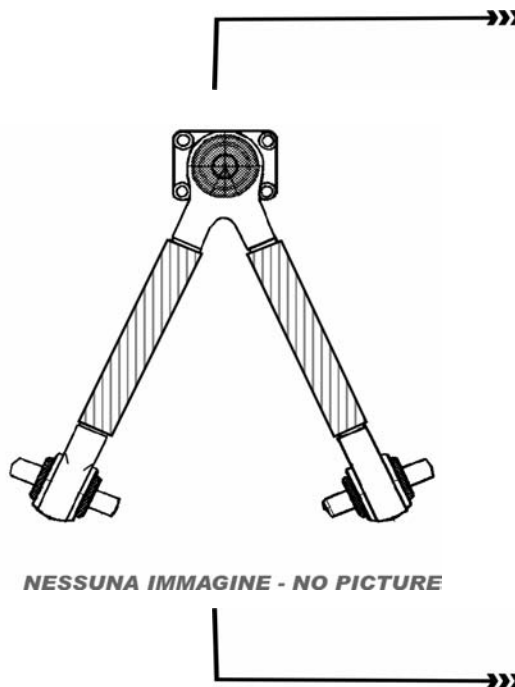

**Kit A**  
**226.136**  
271188



**Kit B**  
**226.079**  
271187

**Models**

**F10 - F12 - F16 / FL7 - FL10 - FL12 / N10 - N12 / NL10 - NL12**

Veicoli con carico sull'assale 17 TON - Carrello Cantiere Leggero - Sosp. Meccanica e Pneumat.

Trucks with Bogie 17 TON - Lighter bogie for building const. - Mechanical & Pneumatic Sosp.

CEI no.  
225.158  
O.E.M. Ref  
1606552

**Barra a V / V-Stay**  
Size / Misure  
L = 641 mm  
L 1 = 641 mm  
Tube Ø 48 mm

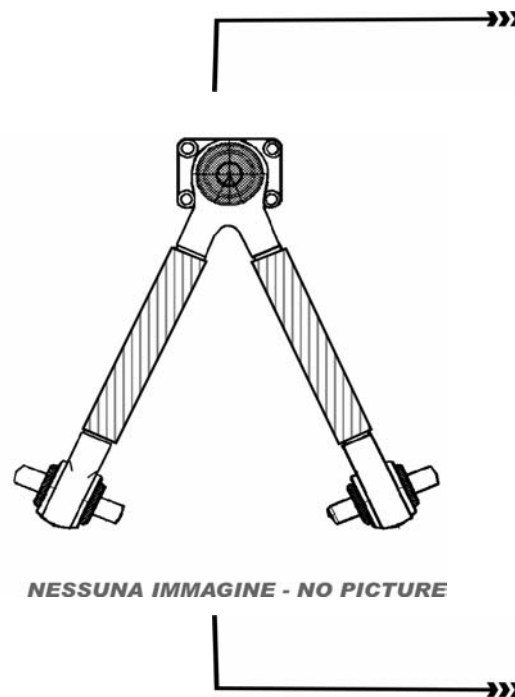

**Kit A**  
**226.096**  
274069

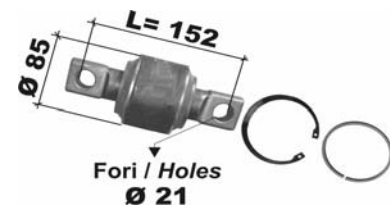

**Kit B**  
**226.011**  
274068

**Models**

**F10 - F12 - F16 / FL7 - FL10 - FL12**

Veicoli con carico sull'assale di 20 TON - Carrello ad uso Cantiere - Sospensione Meccanica

Trucks with Bogie pressure 20 TON - Bogie for building construction - Mechanical Susp.

All original equipment manufacturers' numbers, symbols, pictures, models and description used in this catalogue are for reference only, and it is not implied that any part listed is the product of these manufacturers. Tutti i nostri particolari non sono originali ma con essi intercambiabili. I riferimenti originali, le figure, i modelli sono esposti a semplice titolo indicativo. La nostra produzione riporta il nostro marchio.

CEI no.  
**198.389**

O.E.M. Ref  
1576952

**Barra a V / V-Stay**

Size / Misure  
L = 636 mm  
L 1 = 636 mm  
Tube Ø 58 mm

**Note**

1576952 e' stata sostituita  
dalla 225.043 (1080690 ex  
1606200) + 4 rasamenti  
169.784 (1624343)

1576952 is replaced by  
225.043 (1080690 ex  
1606200) + 4 washer  
169.784 (1624343)



**Kit A W/Pin**

**198.440**

273706

**Kit A W/out Pin**

**226.014**

CEI



**Kit B W/Pin**

**198.461**

273375

**Kit B W/out Pin**

**226.015**

CEI

**Models**

**F10 - F12 - F16 / FL7 - FL10 - FL12 / N10 - N12 / NL10 - NL12**

Veicoli con carico sull'assale di **26-32 TON** - Carrello ad uso Cantiere - **Sosp. Meccanica**

Trucks with Bogie pressure **26-32 TON** - Bogie for building construction - **Mechanical Susp.**

CEI no.  
**225.043**

O.E.M. Ref  
1080690  
1606200  
1509222

**Barra a V / V-Stay**

Size / Misure  
L = 635 mm  
L 1 = 635 mm  
Tube Ø 58 mm

**Note**

Con 4 rasamenti 169.784  
(1624343) puo'  
sostituire la 198.389

With 4 washers 169.784  
(1624343) can be  
replaced the 198.389



**Kit A W/Pin**

**198.440**

273706

**Kit A W/out Pin**

**226.014**

CEI



**Kit B**

**226.064**

276192

**Models**

**F10 - F12 - F16 / FL7 - FL10 - FL12 / N10 - N12 / NL10 - NL12**

Veicoli con carico sull'assale di **26-32 TON** - Carrello ad uso Cantiere - **Sosp. Meccanica**

Trucks with Bogie pressure **26-32 TON** - Bogie for building construction - **Mechanical Susp.**

All original equipment manufacturer's numbers, symbols, pictures, models and description used in this catalogue are for reference only, and it is not implied that any part listed is the product of these manufacturers. Tutti i nostri particolari non sono originali ma con essi intercambiabili. I riferimenti originali, le figure, i modelli sono esposti a semplice titolo indicativo. La nostra produzione riporta il nostro marchio.

CEI no.  
198.631

O.E.M. Ref  
1576953

**Barra a V / V-Stay**

Size / Misure  
L = 650 mm  
L 1 = 650 mm  
Tube Ø 58 mm



**Kit A W/Pin**  
**198.440**  
273706

**Kit A W/out Pin**  
**226.014**  
CEI



**Kit B**  
**198.442**  
274056

**Models**

**FL7 - FL10 - FL12**

Veicoli con carico sull'assale di 26-32 TON - Carrello ad uso Cantiere - Sosp. Meccanica  
Trucks with Bogie pressure 26-32 TON - Bogie for building construction - Mechanical Susp.

CEI no.  
225.159

O.E.M. Ref  
20556590  
3173295

**Barra a V / V-Stay**

Size / Misure

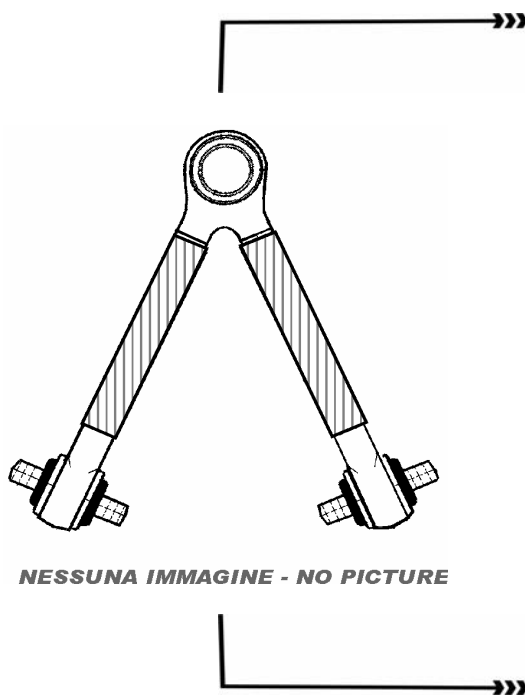

NESSUNA IMMAGINE - NO PICTURE



**Kit A**  
**226.001**  
20554908

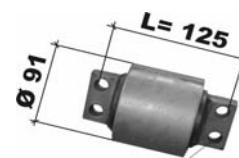

Fori / Holes  
Ø 14  
**Kit B**  
**198.655**  
1598588

**Models**

**F10 - F12 - F16 / FL7 - FL10 - FL12**

Modelli 4x2 con Sospensione Pneumatica  
4x2 Models with Pneumatic Suspension

All original equipment manufacturers numbers, symbols, pictures, models and description used in this catalogue are for reference only, and it is not implied that any part listed is the product of these manufacturers. Tutti i nostri particolari non sono originali ma con essi intercambiabili. I riferimenti originali, le figure, i modelli sono esposti a semplice titolo indicativo. La nostra produzione riporta il nostro marchio.

CEI no.  
**225.051**

O.E.M. Ref  
20556586  
81569994  
3173294  
1628483

**Barra a V / V-Stay**

Size / Misure  
L = 690 mm  
L = 690 mm  
Tube Ø 52 mm



**Kit A**  
**226.001**  
20554908

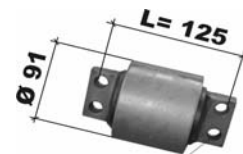

Fori / Holes  
Ø 14

**Kit B**  
**198.655**  
1598588

**Models**

**F10 - F12 - F16 / FL7 - FL10 - FL12**

Modelli 6x2 con **Sospensione Pneumatica**  
6x2 Models with **Pneumatic Suspension**

CEI no.  
**225.160**

O.E.M. Ref  
20556588  
3173290  
1626024

**Barra a V / V-Stay**

Size / Misure  
L = 673 mm  
L = 673 mm  
Tube Ø 48 mm

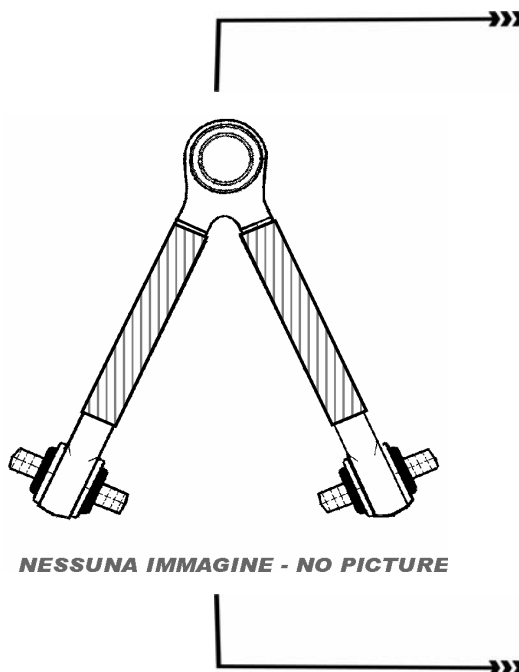

NESSUNA IMMAGINE - NO PICTURE



**Kit A**  
**226.001**  
20554908

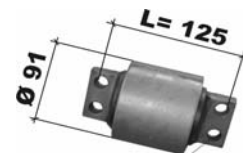

Fori / Holes  
Ø 14

**Kit B**  
**198.655**  
1598588

**Models**

**F10 - F12 / FL10 - FL12**

Modelli con Assale Speciale 19 TON PA e con **Sospensione Pneumatica**  
Models with Special Axle 19 TON PA and **Pneumatic Suspension**

All original equipment manufacturer's numbers, symbols, pictures, models and description used in this catalogue are for reference only, and it is not implied that any part listed is the product of these manufacturers. Tutti i nostri particolari non sono originali ma con essi intercambiabili. I riferimenti originali, le figure, i modelli sono esposti a semplice titolo indicativo. La nostra produzione riporta il nostro marchio.



CEI no.  
225.161

O.E.M. Ref  
20556591  
3173296  
8156996

Barra a V / V-Stay  
Size / Misure

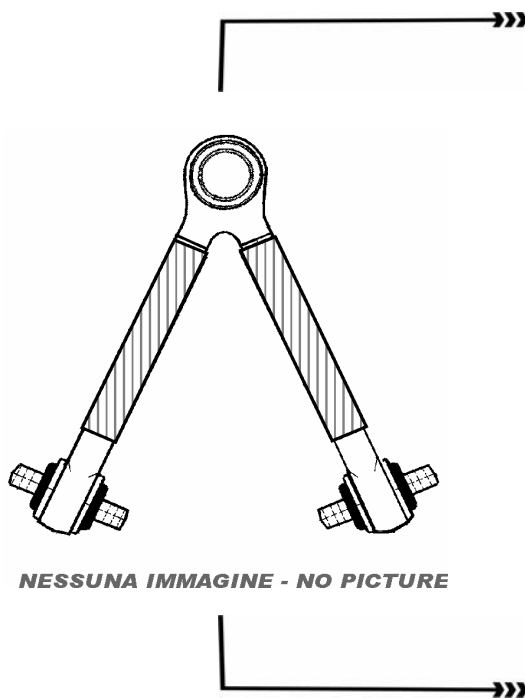

NESSUNA IMMAGINE - NO PICTURE



**Kit A**  
**226.001**  
20554908

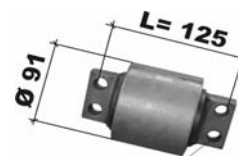

Fori / Holes  
Ø 14

**Kit B**  
**198.655**  
1598588

**Models**

**F10 - F12 - F16 / FL7 - FL10**

Modelli con Ruote Singole sull'asse portante (18 TON) con **Sospensione Meccanica**  
Models with single wheels on trailing axle (18 TON) and **Mechanical Suspension**

CEI no.  
225.162

O.E.M. Ref  
20392649  
1076639  
1629734  
20829503

Barra a V / V-Stay  
Size / Misure  
L = 671 mm  
L1 = 671 mm  
Tube Ø 58 mm

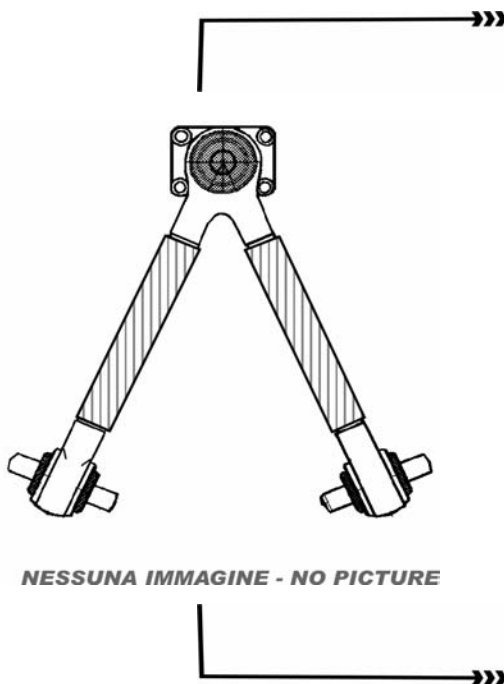

NESSUNA IMMAGINE - NO PICTURE

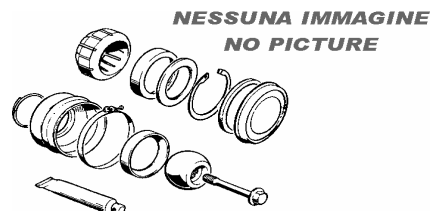

NESSUNA IMMAGINE  
NO PICTURE

**Kit A**  
**226.113**  
3090712



NESSUNA IMMAGINE  
NO PICTURE

**Kit B**  
**226.112**  
3093630

**Models**

**FH12 - FH16 / FM7 - FM9 - FM10 - FM12**

Veicoli a Doppio Ponte 6x4 - 8x4 - **Sospensione Meccanica**  
Trucks with Tandem Axle 6x4 - 8x4 - **Mechanical Suspension**

All original equipment manufacturers' numbers, symbols, pictures, models and description used in this catalogue are for reference only, and it is not implied that any part listed is the product of these manufacturers. Tutti i nostri particolari non sono originali ma con essi intercambiabili. I riferimenti originali, le figure, i modelli sono esposti a semplice titolo indicativo. La nostra produzione riporta il nostro marchio.

CEI no.  
**225.063**

O.E.M. Ref  
20556490  
3173291  
8156991  
1628133

**Barra a V / V-Stay**

Size / Misure  
L = 677 mm  
L = 677 mm  
Tube Ø 50 mm



**Kit A**  
**226.001**  
20554908



Fori / Holes  
Ø 15

**Kit B**  
**226.019**  
1628107

**Models**

**FH12 - FH16 / FM7 - FM10 - FM12**

Veicoli con Assalia a 4 molle d'aria - **Sospensione Pneumatica**  
Trucks with 4 air spring Axles - **Pneumatic Suspension**

CEI no.  
**225.064**

O.E.M. Ref  
20556491  
3173292  
8156992  
1628134

**Barra a V / V-Stay**

Size / Misure  
L = 677 mm  
L = 677 mm  
Tube Ø 50 mm



**Kit A**  
**226.001**  
20554908



Fori / Holes  
Ø 15

**Kit B**  
**226.019**  
1628107

**Models**

**FH12 - FH16 / FM7 - FM10 - FM12**

Veicoli con Assalia a 6/8 molle d'aria - **Sospensione Pneumatica**  
Trucks with 6/8 air spring Axles - **Pneumatic Suspension**

All original equipment manufacturer's numbers, symbols, pictures, models and description used in this catalogue are for reference only, and it is not implied that any part listed is the product of these manufacturers. Tutti i nostri particolari non sono originali ma con essi intercambiabili. I riferimenti originali, le figure, i modelli sono esposti a semplice titolo indicativo. La nostra produzione riporta il nostro marchio.

CEI no.

**225.167**

O.E.M. Ref  
20741695  
20507262  
20741703

**Barra a V / V-Stay**

Size / Misure  
L = 662 mm  
L 1 = 662 mm  
Tube Ø 48 mm



**Kit A**  
**226.111**  
20741710

**Kit B**  
**226.117**  
20547286

**Models**

**FH12 - FH16 / FM7 - FM10 - FM12**

Veicoli a Doppio Ponte 6x4 - 8x4 con Assalia a 8 molle d'aria - **Sospensione Pneumatica**  
Trucks with Tandem Axle 6x4 - 8x4 with 8 air spring Axles - **Pneumatic Suspension**

CEI no.

**225.163**

O.E.M. Ref  
3172829

**Barra a V / V-Stay**

Size / Misure  
L = 677 mm  
L 1 = 677 mm  
Tube Ø 48 mm

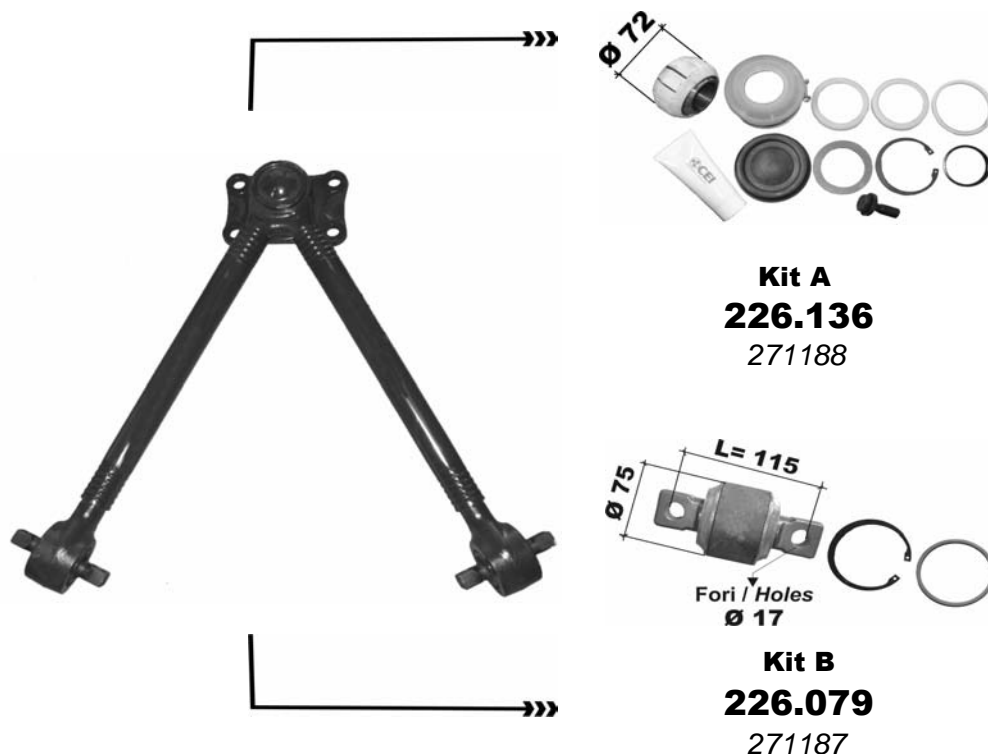

**Kit A**  
**226.136**  
271188

**Kit B**  
**226.079**  
271187

**Models**

**FH12 - FH16 / FM7 - FM10 - FM12**

Veicoli a Doppio Ponte 6x4 - 8x4 con Assalia a 8 molle d'aria - **Sospensione Pneumatica**  
Trucks with Tandem Axle 6x4 - 8x4 with 8 air spring Axles - **Pneumatic Suspension**

All original equipment manufacturers numbers, symbols, pictures, models and description used in this catalogue are for reference only, and it is not implied that any part listed is the product of these manufactures. Tutti i nostri particolari non sono originali ma con essi intercambiabili. I riferimenti originali, le figure, i modelli sono esposti a semplice titolo indicativo. La nostra produzione riporta il nostro marchio.

**CEI no.**  
225.164  
**O.E.M. Ref**  
20382314  
20502944  
1094466

**Barra a V / V-Stay**  
Size / Misure  
L = 642 mm  
L 1 = 642 mm  
Tube Ø 48 mm

In coppia con  
Together with

3172829

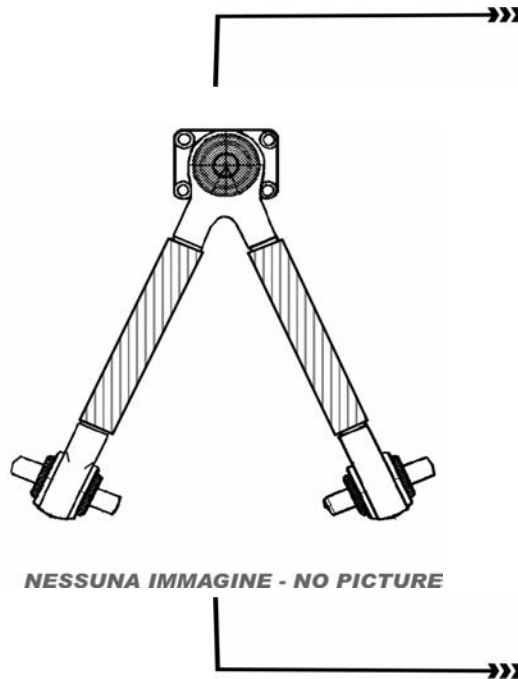

NESSUNA IMMAGINE - NO PICTURE



**Kit A**  
**226.111**  
20741710

NESSUNA IMMAGINE  
NO PICTURE



**Kit B**  
226.110  
3092452

**Models**

**FH12 - FH16 / FM7 - FM10 - FM12**

Veicoli a Doppio Ponte 6x4 - 8x4 con Assalia a 8 molle d'aria - **Sospensione Pneumatica**  
Trucks with Tandem Axle 6x4 - 8x4 with 8 air spring Axles - **Pneumatic Suspension**

**CEI no.**  
225.181  
**O.E.M. Ref**  
20703338  
20556608  
20491771  
20428251

**Barra a V / V-Stay**

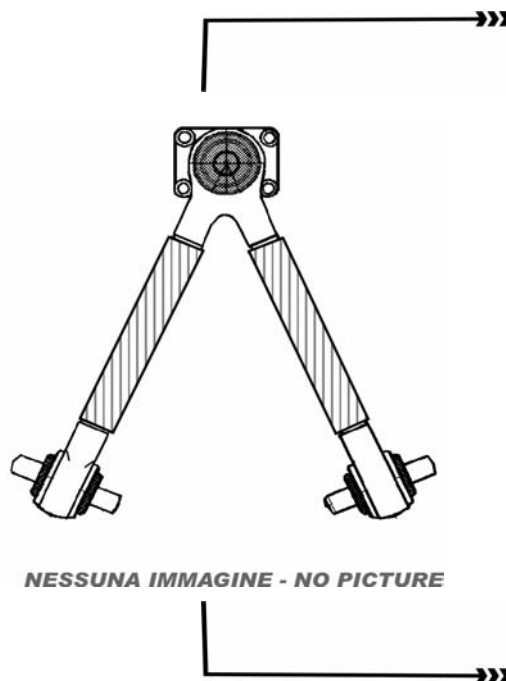

NESSUNA IMMAGINE - NO PICTURE

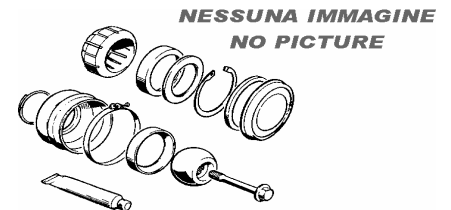

**Kit A**

NESSUNA IMMAGINE  
NO PICTURE



**Kit B**

**Models**

**FH12 - FH16 / FM7 - FM10 - FM12**

Veicoli con assale Pusher fisso o con controllo idraulico  
Trucks with fixed Pusher axle or Hydraulic controlled Pusher axle

All original equipment manufacturer's numbers, symbols, pictures, models and description used in this catalogue are for reference only, and it is not implied that any part listed is the product of these manufacturers. Tutti i nostri particolari non sono originali ma con essi intercambiabili. I riferimenti originali, le figure, i modelli sono esposti a semplice titolo indicativo. La nostra produzione riporta il nostro marchio.

CEI no.

225.182

O.E.M. Ref  
20453123

**Barra 1**  
Dx / Rh

CEI no.

225.182

O.E.M. Ref  
20453123

**Barra 2**  
Sx / Lf

Size / Misure  
L = 449 mm  
L = 449 mm  
Tube Ø 48 mm

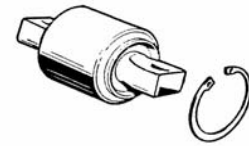
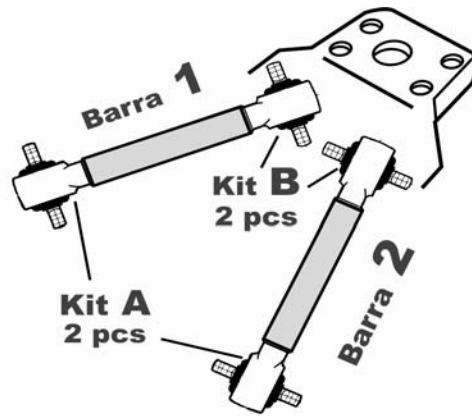

**Kit A**



**Kit B**

**Models**

**FH12 - FH16 / FM7 - FM10 - FM12**

Veicoli con assale tipo RRH-140/160/180/240 (ribassato)

Trucks with axle type RRH-140/160/180/240 (lower frame flange)

All original equipment manufacturers' numbers, symbols, pictures, models and description used in this catalogue are for reference only, and it is not implied that any part listed is the product of these manufacturers.  
Tutti i nostri particolari non sono originali ma con essi intercambiabili. I riferimenti originali, le figure, i modelli sono esposti a semplice titolo indicativo. La nostra produzione riporta il nostro marchio.

CEI no.  
225.129  
O.E.M. Ref  
3944820  
1607079

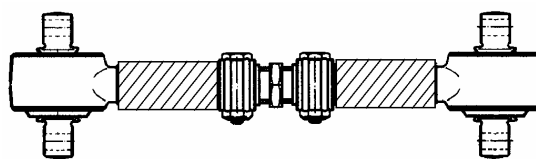

NESSUNA IMMAGINE - NO PICTURE

**Arm End**

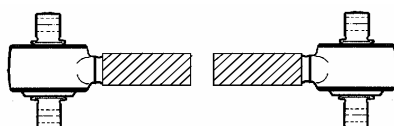

**Barra / Arm**  
**Size / Misure**  
**L = 660 mm**  
**Tube Ø 48 mm**

1590461 / 1590467

**Repair Kit**



**198.411**

274019

**Models**

**F10 - F12 - F16 / FL7 - FL10 - FL12 / N10 - N12 / NL10 - NL12**

**Sospensione Meccanica / Mechanical Suspension**

CEI no.  
225.130  
O.E.M. Ref  
1626958  
1626957

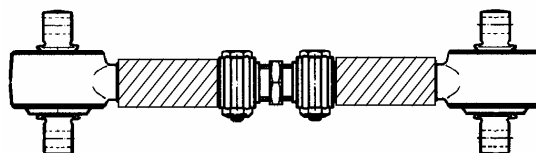

NESSUNA IMMAGINE - NO PICTURE

**Arm End**

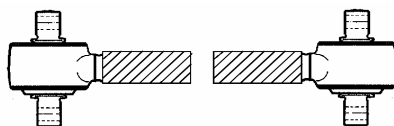

**Barra / Arm**  
**Size / Misure**  
**L = 660 mm**  
**Tube Ø 48 mm**

**Repair Kit**



**198.411**

274019

**Models**

**FH12 - FH16 / FM7 - FM9 - FM10 - FM12**

**Sospensione Meccanica / Mechanical Suspension**

All original equipment manufacturer's numbers, symbols, pictures, models and description used in this catalogue are for reference only, and it is not implied that any part listed is the product of these manufacturers. Tutti i nostri particolari non sono originali ma con essi intercambiabili. I riferimenti originali, le figure, i modelli sono esposti a semplice titolo indicativo. La nostra produzione riporta il nostro marchio.



CEI no.  
225.131

O.E.M. Ref  
1621419  
1608151

Barra / Arm  
Size / Misure  
L = 621 mm  
Tube Ø 48 mm

**Repair Kit**

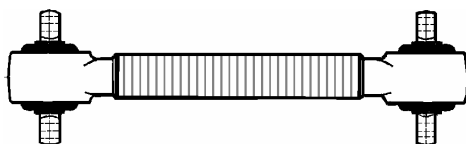

NESSUNA IMMAGINE - NO PICTURE



NESSUNA IMMAGINE  
NO PICTURE

226.114  
#

**Models**

F10 - F12 - F16 / FL7 - FL10 - FL12 / N10 - N12 / NL10 - NL12

FH12 - FH16 / FM7 - FM9 - FM10 - FM12

Sospensione Meccanica / Mechanical Suspension

CEI no.  
**225.053**

O.E.M. Ref  
1082104  
1605035

Barra / Arm  
Size / Misure  
L = 665 mm  
Tube Ø 58 mm



**Repair Kit A**



**198.655**

1598588

**Repair Kit B**



**226.063**

1135080

**Models**

F10 - F12 - F16 / FL7 - FL10 - FL12

FH12 - FH16 / FM7 - FM9 - FM10 - FM12

Sospensione Pneumatica / Pneumatic Suspension

All original equipment manufacturers numbers, symbols, pictures, models and description used in this catalogue are for reference only, and it is not implied that any part listed is the product of these manufactures. Tutti i nostri particolari non sono originali ma con essi intercambiabili. I riferimenti originali, le figure, i modelli sono esposti a semplice titolo indicativo. La nostra produzione riporta il nostro marchio.

CEI no.  
225.132  
O.E.M. Ref  
8152219



Barra / Arm  
Size / Misure

**Repair Kit A**

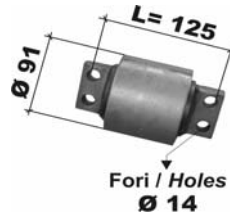

**198.655**  
1598588

**Repair Kit B**



**226.063**  
1135080

**Models**

**F12 - F16 / FL7 - FL10 / FH12 - FH16 / FM7 - FM9 - FM10 - FM12**  
Autocarri con assali Tandem 6x4 - 8x4 / For trucks with tandem Axles 6x4 - 8x4  
Sospensione Pneumatica / Pneumatic Suspension

CEI no.  
225.175  
O.E.M. Ref  
20443044

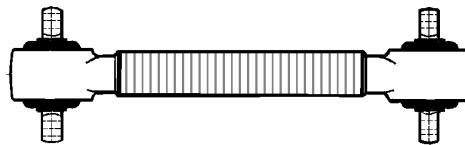

NESSUNA IMMAGINE - NO PICTURE

**Repair Kit**

NESSUNA IMMAGINE  
NO PICTURE



74 85 104 224

Barra / Arm

**Models**

**FH12 - FH16 / FM7 - FM9 - FM10 - FM12**  
Sospensione Pneumatica / Pneumatic Suspension

CEI no.  
225.189  
O.E.M. Ref  
20517494  
20509018  
20410530

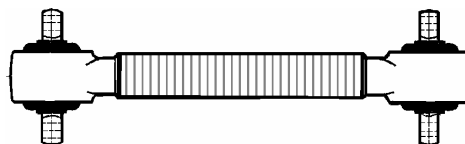

NESSUNA IMMAGINE - NO PICTURE

**Repair Kit**

NESSUNA IMMAGINE  
NO PICTURE



Barra / Arm

**Models**

**FH12 - FH16 / FM7 - FM9 - FM10 - FM12**  
Sospensione Pneumatica / Pneumatic Suspension

All original equipment manufacturer's numbers, symbols, pictures, models and description used in this catalogue are for reference only, and it is not implied that any part listed is the product of these manufacturers. Tutti i nostri particolari non sono originali ma con essi intercambiabili. I riferimenti originali, le figure, i modelli sono esposti a semplice titolo indicativo. La nostra produzione riporta il nostro marchio.

CEI no.

225.190

O.E.M. Ref  
20532931

Barra / Arm

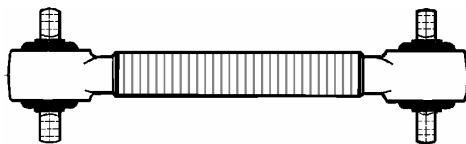

NESSUNA IMMAGINE - NO PICTURE

*Models*

**FH12 - FH16 / FM7 - FM9 - FM10 - FM12**

*Modelli con Bilanciere / Models with Boogie Axle*

**Repair Kit**

NESSUNA IMMAGINE  
NO PICTURE



CEI no.

225.191

O.E.M. Ref  
20532934

Barra / Arm

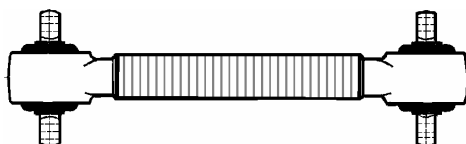

NESSUNA IMMAGINE - NO PICTURE

*Models*

**FH12 - FH16 / FM7 - FM9 - FM10 - FM12**

*Modelli con Bilanciere / Models with Boogie Axle*

**Repair Kit**

NESSUNA IMMAGINE  
NO PICTURE

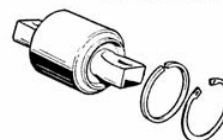

CEI no.

**225.013**

O.E.M. Ref  
99251013  
40371

**Barra a V / V-Stay**

*Size / Misure*

**L = 562,5 mm**

**L 1 = 562,5 mm**

**Tube Ø 50 mm**



**RIMORCHI  
TRAILER**

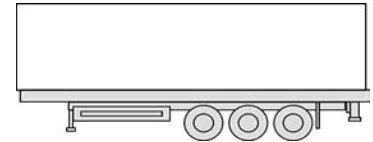

Models

**Applicazioni Speciali - Rimorchi e Terzi Assi**

**Special Applications - Trailers and 3rd Axles**

**(BPW ITALIA-TRASCAR-AUSTERAS CAMPANA)**

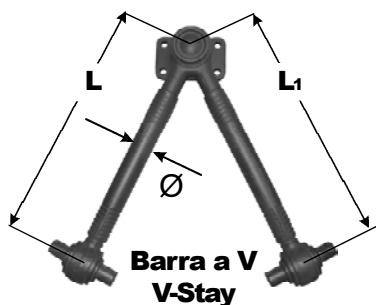

CEI no.	Suitable to :	Descrizione	Description	L	L <sub>1</sub>	Tube
<b>198.573</b>	IVECO	Barra a V	V-Stay	690	658	50
<b>198.695</b>	IVECO	Barra a V	V-Stay	658	690	50
<b>225.050</b>	IVECO	Barra a V	V-Stay	659	659	46
<b>225.192</b>	IVECO	Barra a V	V-Stay	665	665	46
<b>225.001</b>	IVECO	Barra a V	V-Stay	665	665	46
225.027	IVECO	Barra a V	V-Stay	665	665	46
<b>225.048</b>	IVECO	Barra a V	V-Stay	665	665	46
<b>198.572</b>	IVECO	Barra reazione diritta	Reaction rod	582		48
<b>198.641</b>	IVECO	Barra reazione diritta	Reaction rod	582		48
225.178	IVECO	Barra reazione diritta	Reaction rod	594		
<b>225.002</b>	IVECO	Barra reazione diritta	Reaction rod	595		46
<b>225.012</b>	IVECO	Barra reazione diritta	Reaction rod	610		58
225.070	IVECO	Barra reazione diritta	Reaction rod	610		50
225.134	IVECO Bus	Barra a V	V-Stay	660	660	48
225.136	IVECO Bus	Barra a V	V-Stay	686	686	48
<b>225.135</b>	IVECO Bus	Barra a V	V-Stay	703	703	48
225.133	IVECO Bus	Barra a V	V-Stay	873	873	48

All original equipment manufacturers numbers, symbols, pictures, models and description used in this catalogue are for reference only, and it is not implied that any part listed is the product of these manufacturers. Tutti i nostri particolari non sono originali ma con essi intercambiabili. I riferimenti originali, le figure, i modelli sono esposti a semplice titolo indicativo. La nostra produzione riporta il nostro marchio.

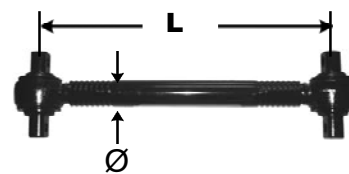
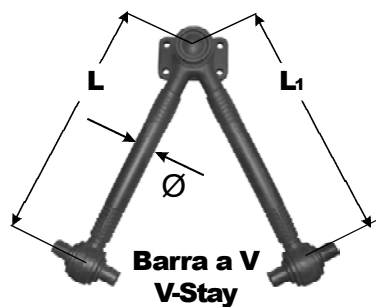
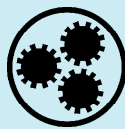

**Barra a V  
V-Stay**

**Barra reazione dritta  
Reaction rod**

CEI no.	Suitable to :	Descrizione	Description	L	L <sub>1</sub>	Tube
225.074	IVECO Bus	Barra reazione dritta	Reaction rod	581		48
225.014	IVECO Bus	Barra reazione dritta	Reaction rod	582		48
225.077	IVECO Bus	Barra reazione dritta	Reaction rod	583		48
225.071	IVECO Bus	Barra reazione dritta	Reaction rod	595		48
225.076	IVECO Bus	Barra reazione dritta	Reaction rod	720		
<b>198.675</b>	IVECO Bus	Barra reazione dritta	Reaction rod	730		48
225.078	IVECO Bus	Barra reazione dritta	Reaction rod	757		48
225.073	IVECO Bus	Barra reazione dritta	Reaction rod	760		48
225.072	IVECO Bus	Barra reazione dritta	Reaction rod	960		48
<b>225.138</b>	DAF	Barra a V	V-Stay	550	550	50
225.173	DAF	Barra reazione dritta	Reaction rod	606		40
225.069	DAF	Barra a V	V-Stay	608	608	50
<b>225.137</b>	DAF	Barra a V	V-Stay	608	608	50
<b>225.139</b>	DAF	Barra a V	V-Stay	608	608	50
225.140	DAF	Barra a V	V-Stay	870	870	48
225.079	DAF	Barra reazione dritta	Reaction rod	390		50
225.082	DAF	Barra reazione dritta	Reaction rod	600		50

All original equipment manufacturers' numbers, symbols, pictures, models and description used in this catalogue are for reference only, and it is not implied that any part listed is the product of these manufacturers. Tutti i nostri particolari non sono originali ma con essi intercambiabili. I riferimenti originali, le figure, i modelli sono esposti a semplice titolo indicativo. La nostra produzione riporta il nostro marchio.



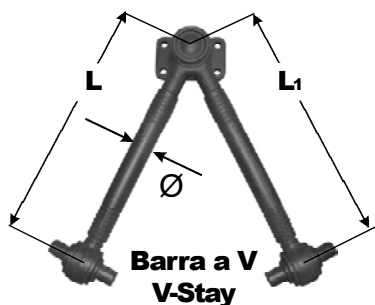

CEI no.	Suitable to :	Descrizione	Description	L	L <sub>1</sub>	Tube
225.083	DAF	Barra reazione diritta	Reaction rod	600		46
225.084	DAF	Barra reazione diritta	Reaction rod	600		48
225.080	DAF	Barra reazione diritta	Reaction rod	605		37
<b>225.081</b>	DAF	Barra reazione diritta	Reaction rod	611		48
225.111	Kass-Setra	Barra reazione diritta	Reaction rod	660		50
225.141	MERCEDES	Barra a V	V-Stay	509	622	56
225.149	MERCEDES	Barra a V	V-Stay	565	565	
225.039	MERCEDES	Barra a V	V-Stay	622	622	48
<b>225.040</b>	MERCEDES	Barra a V	V-Stay	622	622	48
<b>225.058</b>	MERCEDES	Barra a V	V-Stay	622	622	56
<b>225.060</b>	MERCEDES	Barra a V	V-Stay	622	622	48
225.142	MERCEDES	Barra a V	V-Stay	622	509	56
225.148	MERCEDES	Barra a V	V-Stay	622	622	46
<b>198.648</b>	MERCEDES	Barra a V	V-Stay	623	623	60
225.059	MERCEDES	Barra a V	V-Stay	623	623	56
225.143	MERCEDES	Barra a V	V-Stay	623	657	56
225.144	MERCEDES	Barra a V	V-Stay	657	623	56

All original equipment manufacturers numbers, symbols, pictures, models and description used in this catalogue are for reference only, and it is not implied that any part listed is the product of these manufacturers. Tutti i nostri particolari non sono originali ma con essi intercambiabili. I riferimenti originali, le figure, i modelli sono esposti a semplice titolo indicativo. La nostra produzione riporta il nostro marchio.

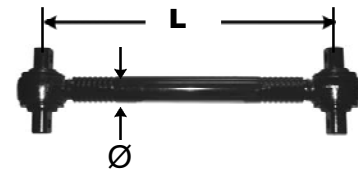
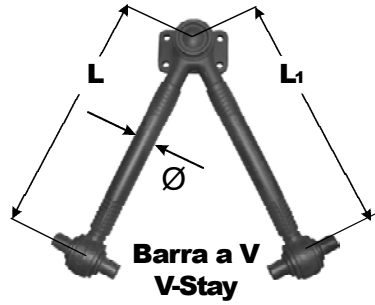

CEI no.	Suitable to :	Descrizione	Description	L	L <sub>1</sub>	Tube
<b>225.147</b>	MERCEDES	Barra a V	V-Stay	667	667	58
225.145	MERCEDES	Barra a V	V-Stay	761	761	46
225.150	MERCEDES	Barra a V	V-Stay	901	901	48
225.151	MERCEDES	Barra a V	V-Stay	901	901	48
225.091	MERCEDES	Barra reazione diritta	Reaction rod	500		50
225.010	MERCEDES	Barra reazione diritta	Reaction rod	522		52
225.098	MERCEDES	Barra reazione diritta	Reaction rod	522		52
225.103	MERCEDES	Barra reazione diritta	Reaction rod	565		50
225.104	MERCEDES	Barra reazione diritta	Reaction rod	565		50
225.088	MERCEDES	Barra reazione diritta	Reaction rod	568		50
225.024	MERCEDES	Barra reazione diritta	Reaction rod	579		58
225.095	MERCEDES	Barra reazione diritta	Reaction rod	579		50
<b>198.643</b>	MERCEDES	Barra reazione diritta	Reaction rod	585		50
225.023	MERCEDES	Barra reazione diritta	Reaction rod	585		50
225.094	MERCEDES	Barra reazione diritta	Reaction rod	585		50
149.074	MERCEDES	Barra reazione diritta	Reaction rod	595		50
189.278	MERCEDES	Barra reazione diritta	Reaction rod	595		50

All original equipment manufacturers' numbers, symbols, pictures, models and description used in this catalogue are for reference only, and it is not implied that any part listed is the product of these manufacturers. Tutti i nostri particolari non sono originali ma con essi intercambiabili. I riferimenti originali, le figure, i modelli sono esposti a semplice titolo indicativo. La nostra produzione riporta il nostro marchio.

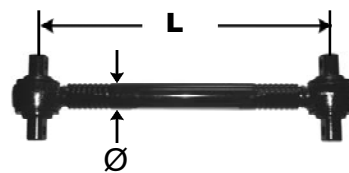
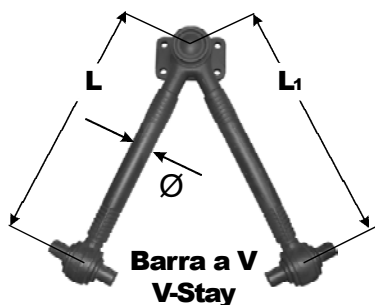

**Barra a V  
V-Stay**

**Barra reazione dritta  
Reaction rod**

CEI no.	Suitable to :	Descrizione	Description	L	L <sub>1</sub>	Tube
225.005	MERCEDES	Barra reazione dritta	Reaction rod	595		62
225.009	MERCEDES	Barra reazione dritta	Reaction rod	595		62
225.085	MERCEDES	Barra reazione dritta	Reaction rod	595		50
225.087	MERCEDES	Barra reazione dritta	Reaction rod	595		50
225.086	MERCEDES	Barra reazione dritta	Reaction rod	610		50
225.011	MERCEDES	Barra reazione dritta	Reaction rod	612		48
225.105	MERCEDES	Barra reazione dritta	Reaction rod	615		52
225.089	MERCEDES	Barra reazione dritta	Reaction rod	627		50
225.007	MERCEDES	Barra reazione dritta	Reaction rod	628		50
225.021	MERCEDES	Barra reazione dritta	Reaction rod	629		58
225.022	MERCEDES	Barra reazione dritta	Reaction rod	629		58
225.092	MERCEDES	Barra reazione dritta	Reaction rod	629		50
225.093	MERCEDES	Barra reazione dritta	Reaction rod	629		50
225.097	MERCEDES	Barra reazione dritta	Reaction rod	635		58
225.090	MERCEDES	Barra reazione dritta	Reaction rod	638		50
225.096	MERCEDES	Barra reazione dritta	Reaction rod	645		58
225.099	MERCEDES	Barra reazione dritta	Reaction rod	652		52

All original equipment manufacturers numbers, symbols, pictures, models and description used in this catalogue are for reference only, and it is not implied that any part listed is the product of these manufacturers. Tutti i nostri particolari non sono originali ma con essi intercambiabili. I riferimenti originali, le figure, i modelli sono esposti a semplice titolo indicativo. La nostra produzione riporta il nostro marchio.

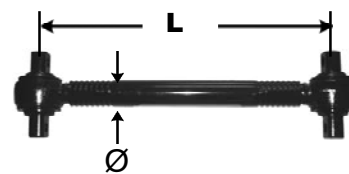
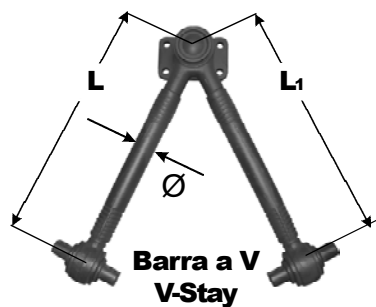

CEI no.	Suitable to :	Descrizione	Description	L	L <sub>1</sub>	Tube
225.109	MERCEDES	Barra reazione dritta	Reaction rod	662		50
225.101	MERCEDES	Barra reazione dritta	Reaction rod	748		50
225.102	MERCEDES	Barra reazione dritta	Reaction rod	748		50
225.110	MERCEDES	Barra reazione dritta	Reaction rod	750		48
225.107	MERCEDES	Barra reazione dritta	Reaction rod	754		58
225.108	MERCEDES	Barra reazione dritta	Reaction rod	755		58
225.100	MERCEDES	Barra reazione dritta	Reaction rod	813		48
225.106	MERCEDES	Barra reazione dritta	Reaction rod	845		60
225.156	MAN	Barra a V	V-Stay	445	445	50
225.176	MAN	Barra a V	V-Stay	572		
<b>198.561</b>	MAN	Barra a V	V-Stay	621	621	58
225.153	MAN	Barra a V	V-Stay	627	627	58
<b>225.154</b>	MAN	Barra a V	V-Stay	627	627	48
<b>225.155</b>	MAN	Barra a V	V-Stay	627	627	48
225.174	MAN	Barra a V	V-Stay	627	627	58
225.183	MAN	Barra a V	V-Stay	642	642	48
225.152	MAN	Barra a V	V-Stay	693	693	46

All original equipment manufacturers' numbers, symbols, pictures, models and description used in this catalogue are for reference only, and it is not implied that any part listed is the product of these manufacturers. Tutti i nostri particolari non sono originali ma con essi intercambiabili. I riferimenti originali, le figure, i modelli sono esposti a semplice titolo indicativo. La nostra produzione riporta il nostro marchio.

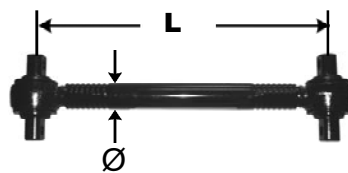
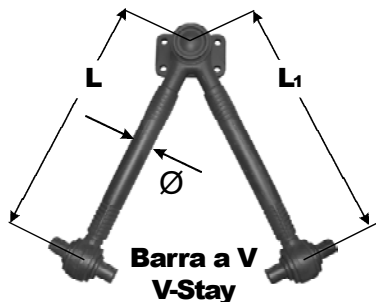

**Barra a V  
V-Stay**

**Barra reazione dritta  
Reaction rod**

CEI no.	Suitable to :	Descrizione	Description	L	L <sub>1</sub>	Tube
<b>225.112</b>	MAN	Barra reazione dritta	Reaction rod	414		50
<b>225.032</b>	MAN	Barra reazione dritta	Reaction rod	455		50
<b>225.006</b>	MAN	Barra reazione dritta	Reaction rod	500		50
<b>225.019</b>	MAN	Barra reazione dritta	Reaction rod	565		50
<b>225.118</b>	MAN	Barra reazione dritta	Reaction rod	566		50
<b>225.008</b>	MAN	Barra reazione dritta	Reaction rod	570		48
<b>225.036</b>	MAN	Barra reazione dritta	Reaction rod	570		48
<b>225.168</b>	MAN	Barra reazione dritta	Reaction rod	570		48
225.116	MAN	Barra reazione dritta	Reaction rod	585		58
<b>225.033</b>	MAN	Barra reazione dritta	Reaction rod	590		48
225.113	MAN	Barra reazione dritta	Reaction rod	595		50
225.115	MAN	Barra reazione dritta	Reaction rod	596		50
225.119	MAN	Barra reazione dritta	Reaction rod	596		48
<b>225.035</b>	MAN	Barra reazione dritta	Reaction rod	661		50
225.177	MAN	Barra reazione dritta	Reaction rod	661		40
225.114	MAN	Barra reazione dritta	Reaction rod	755		50
<b>225.031</b>	MAN	Barra reazione dritta	Reaction rod	762		50

All original equipment manufacturers numbers, symbols, pictures, models and description used in this catalogue are for reference only, and it is not implied that any part listed is the product of these manufacturers. Tutti i nostri particolari non sono originali ma con essi intercambiabili. I riferimenti originali, le figure, i modelli sono esposti a semplice titolo indicativo. La nostra produzione riporta il nostro marchio.

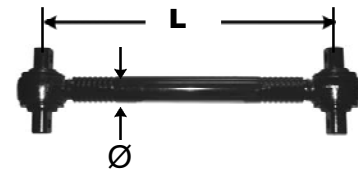
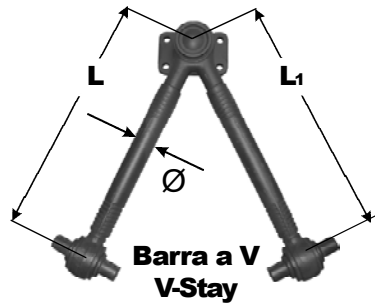

CEI no.	Suitable to :	Descrizione	Description	L	L <sub>1</sub>	Tube
225.117	MAN	Barra reazione diritta	Reaction rod	777		60
225.120	MAN	Barra reazione diritta	Reaction rod	941		60
225.162	RENAULT V.I.	Barra a V	V-Stay	660	660	48
<b>225.167</b>	RENAULT V.I.	Barra a V	V-Stay	662	662	48
225.122	RENAULT V.I.	Barra reazione diritta	Reaction rod	535		50
225.038	RENAULT V.I.	Barra reazione diritta	Reaction rod	550		46
<b>198.645</b>	RENAULT V.I.	Barra reazione diritta	Reaction rod	575		52
<b>225.015</b>	RENAULT V.I.	Barra reazione diritta	Reaction rod	575		62
<b>225.028</b>	RENAULT V.I.	Barra reazione diritta	Reaction rod	575		50
<b>225.061</b>	RENAULT V.I.	Barra reazione diritta	Reaction rod	575		50
225.068	RENAULT V.I.	Barra reazione diritta	Reaction rod	575		48
225.037	RENAULT V.I.	Barra reazione diritta	Reaction rod	692		46
225.179	SCANIA	Barra a V	V-Stay	613	613	46
<b>225.123</b>	SCANIA	Barra reazione diritta	Reaction rod	522		46
225.124	SCANIA	Barra reazione diritta	Reaction rod	568		46
<b>225.125</b>	SCANIA	Barra reazione diritta	Reaction rod	568		46
225.128	SCANIA	Barra reazione diritta	Reaction rod	650		48

All original equipment manufacturers' numbers, symbols, pictures, models and description used in this catalogue are for reference only, and it is not implied that any part listed is the product of these manufacturers. Tutti i nostri particolari non sono originali ma con essi intercambiabili. I riferimenti originali, le figure, i modelli sono esposti a semplice titolo indicativo. La nostra produzione riporta il nostro marchio.



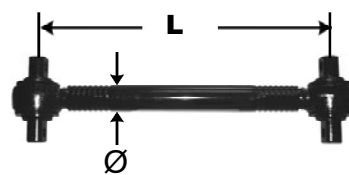
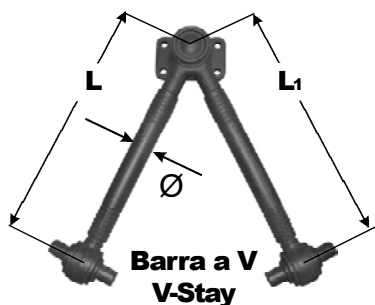

**Barra a V  
V-Stay**

**Barra reazione diritta  
Reaction rod**

CEI no.	Suitable to :	Descrizione	Description	L	L <sub>1</sub>	Tube
225.126	SCANIA	Barra reazione diritta	Reaction rod	705		42
<b>225.043</b>	VOLVO	Barra a V	V-Stay	635	635	58
<b>198.389</b>	VOLVO	Barra a V	V-Stay	636	636	58
225.158	VOLVO	Barra a V	V-Stay	641	641	48
225.164	VOLVO	Barra a V	V-Stay	642	642	48
225.157	VOLVO	Barra a V	V-Stay	644	644	46
198.631	VOLVO	Barra a V	V-Stay	650	650	58
225.162	VOLVO	Barra a V	V-Stay	671	671	58
225.160	VOLVO	Barra a V	V-Stay	673	673	48
<b>225.063</b>	VOLVO	Barra a V	V-Stay	677	677	50
<b>225.064</b>	VOLVO	Barra a V	V-Stay	677	677	50
225.163	VOLVO	Barra a V	V-Stay	677	677	48
<b>225.051</b>	VOLVO	Barra a V	V-Stay	690	690	52
<b>225.167</b>	VOLVO	Barra a V	V-Stay	662	662	48
225.182	VOLVO	Barra reazione diritta	Reaction rod	449	449	48
225.131	VOLVO	Barra reazione diritta	Reaction rod	621		48
225.129	VOLVO	Barra reazione diritta	Reaction rod	660		48

All original equipment manufacturers numbers, symbols, pictures, models and description used in this catalogue are for reference only, and it is not implied that any part listed is the product of these manufacturers. Tutti i nostri particolari non sono originali ma con essi intercambiabili. I riferimenti originali, le figure, i modelli sono esposti a semplice titolo indicativo. La nostra produzione riporta il nostro marchio.

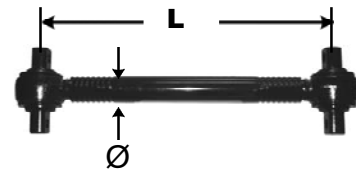
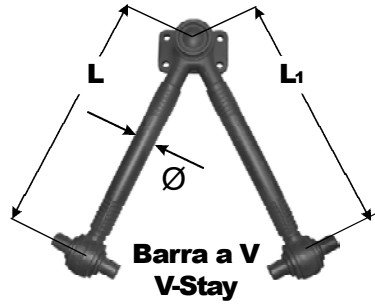

All original equipment manufacturer's numbers, symbols, pictures, models and description used in this catalogue are for reference only, and it is not implied that any part listed is the product of these manufacturers. Tutti i nostri particolari non sono originali ma con essi intercambiabili. I riferimenti originali, le figure, i modelli sono esposti a semplice titolo indicativo. La nostra produzione riporta il nostro marchio.

CEI no.	Suitable to :	Descrizione	Description	L	L <sub>1</sub>	Tube
---------	---------------	-------------	-------------	---	----------------	------

225.130	VOLVO	Barra reazione dritta	Reaction rod	660		48
---------	-------	-----------------------	--------------	-----	--	----

<b>225.053</b>	VOLVO	Barra reazione dritta	Reaction rod	665		58
----------------	-------	-----------------------	--------------	-----	--	----

<b>225.013</b>	BPW	Barra a V	V-Stay	562,5	562,5	50
----------------	-----	-----------	--------	-------	-------	----

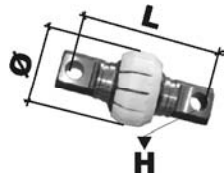

**Kit revisione c/perno**  
**Repair kit rod w/pin**

**Kit revisione c/sfera**  
**Repair kit rod w/ball**

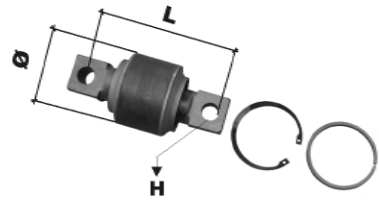

**Kit silentbloc**  
**Silent-bloc Kit**

CEI no.	Descrizione	Description	Ø	H	L
<b>198.612</b>	Kit revisione testina con perno	Repair kit rod w/pin	72	19	130
<b>198.640</b>	Kit revisione testina con perno	Repair kit rod w/pin	80	19	130
<b>226.016</b>	Kit revisione testina con perno	Repair kit rod w/pin	80	19	130
<b>226.031</b>	Kit revisione testina con perno	Repair kit rod w/pin	80	19	145
<b>198.642</b>	Kit revisione testina con perno	Repair kit rod w/pin	80	21	152
<b>226.032</b>	Kit revisione testina con perno	Repair kit rod w/pin	90	21	152
<b>198.461</b>	Kit revisione testina con perno	Repair kit rod w/pin	90	23	152
<b>198.639</b>	Kit revisione testina con sfera	Repair kit rod w/ball	72		
198.689	Kit revisione testina con sfera	Repair kit rod w/ball	72		
<b>226.004</b>	Kit revisione testina con sfera	Repair kit rod w/ball	72		
226.049	Kit revisione testina con sfera	Repair kit rod w/ball	72		
<b>226.111</b>	Kit revisione testina con sfera	Repair kit rod w/ball	72		
<b>226.136</b>	Kit revisione testina con sfera	Repair kit rod w/ball	72		
226.101	Kit revisione testina con sfera	Repair kit rod w/ball	75		
<b>198.681</b>	Kit revisione testina con sfera	Repair kit rod w/ball	80		
<b>198.440</b>	Kit revisione testina con sfera	Repair kit rod w/ball	90		
<b>198.647</b>	Kit revisione testina con sfera	Repair kit rod w/ball	90		

All original equipment manufacturers numbers, symbols, pictures, models and description used in this catalogue are for reference only, and it is not implied that any part listed is the product of these manufacturers. Tutti i nostri particolari non sono originali ma con essi intercambiabili. I riferimenti originali, le figure, i modelli sono esposti a semplice titolo indicativo. La nostra produzione riporta il nostro marchio.

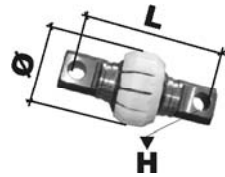

**Kit revisione c/perno**  
**Repair kit rod w/pin**

**Kit revisione c/sfera**  
**Repair kit rod w/ball**

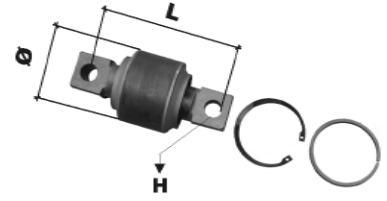

**Kit silentbloc**  
**Silent-bloc Kit**

CEI no.	Descrizione	Description	Ø	H	L
226.096	Kit revisione testina con sfera	Repair kit rod w/ball	90		
226.074	Kit silentbloc	Silent-bloc Kit	67	17	100
<b>226.077</b>	Kit silentbloc	Silent-bloc Kit	67	17	115
<b>226.078</b>	Kit silentbloc	Silent-bloc Kit	75	17	115
<b>226.054</b>	Kit silentbloc	Silent-bloc Kit	75	25	130
226.115	Kit silentbloc	Silent-bloc Kit	75	25	130
<b>226.053</b>	Kit silentbloc	Silent-bloc Kit	75	17	122
<b>226.079</b>	Kit silentbloc	Silent-bloc Kit	75	17	115
<b>226.006</b>	Kit silentbloc	Silent-bloc Kit	75	19	130
<b>226.117</b>	Kit silentbloc	Silent-bloc Kit	75	19	115
<b>226.022</b>	Kit silentbloc	Silent-bloc Kit	75	21	130
<b>226.088</b>	Kit silentbloc	Silent-bloc Kit	75	21	130
<b>226.086</b>	Kit silentbloc	Silent-bloc Kit	75	23	152
226.038	Kit silentbloc	Silent-bloc Kit	82	18,5	130
<b>198.411</b>	Kit silentbloc	Silent-bloc Kit	85	21	130
<b>226.066</b>	Kit silentbloc	Silent-bloc Kit	85	25	152
<b>226.018</b>	Kit silentbloc	Silent-bloc Kit	85	19	130

All original equipment manufacturer's numbers, symbols, pictures, models and description used in this catalogue are for reference only, and it is not implied that any part listed is the product of these manufacturers. Tutti i nostri particolari non sono originali ma con essi intercambiabili. I riferimenti originali, le figure, i modelli sono esposti a semplice titolo indicativo. La nostra produzione riporta il nostro marchio.

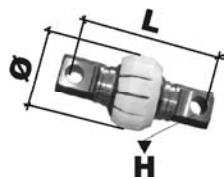

**Kit revisione c/perno**  
**Repair kit rod w/pin**

**Kit revisione c/sfera**  
**Repair kit rod w/ball**

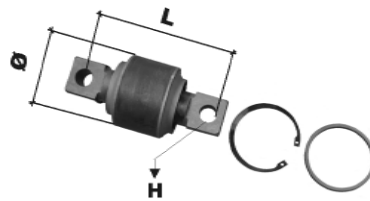

**Kit silentbloc**  
**Silent-bloc Kit**

CEI no.	Descrizione	Description	Ø	H	L
<b>226.050</b>	Kit silentbloc	Silent-bloc Kit	85	19	145
226.097	Kit silentbloc	Silent-bloc Kit	85	19	130
<b>226.011</b>	Kit silentbloc	Silent-bloc Kit	85	21	152
<b>226.052</b>	Kit silentbloc	Silent-bloc Kit	85	21	152
<b>226.072</b>	Kit silentbloc	Silent-bloc Kit	85	21	152
<b>226.073</b>	Kit silentbloc	Silent-bloc Kit	85	21	152
<b>226.067</b>	Kit silentbloc	Silent-bloc Kit	85	23	130
<b>226.070</b>	Kit silentbloc	Silent-bloc Kit	85	23	152
<b>226.075</b>	Kit silentbloc	Silent-bloc Kit	85	25	130
<b>198.655</b>	Kit silentbloc	Silent-bloc Kit	91	14	125
<b>226.019</b>	Kit silentbloc	Silent-bloc Kit	91	15	145
<b>226.064</b>	Kit silentbloc	Silent-bloc Kit	95	23	152
226.126	Kit silentbloc	Silent-bloc Kit	95	23	152
<b>226.025</b>	Kit silentbloc	Silent-bloc Kit	95	21	152
<b>198.442</b>	Kit silentbloc	Silent-bloc Kit	95	23	152
226.033	Kit silentbloc	Silent-bloc Kit	96	18,5	145
<b>226.010</b>	Kit silentbloc	Silent-bloc Kit	96	20,5	145

All original equipment manufacturers numbers, symbols, pictures, models and description used in this catalogue are for reference only, and it is not implied that any part listed is the product of these manufactures. Tutti i nostri particolari non sono originali ma con essi intercambiabili. I riferimenti originali, le figure, i modelli sono esposti a semplice titolo indicativo. La nostra produzione riporta il nostro marchio.

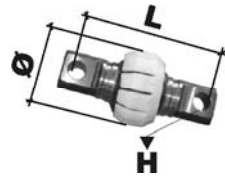

Kit revisione c/sfera  
Repair kit rod w/ball



Kit revisione c/perno  
Repair kit rod w/pin

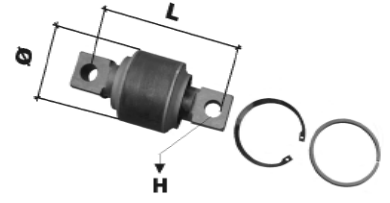

Kit silentbloc  
Silent-bloc Kit

CEI no.

Descrizione

Description

Ø

H

L

**226.069**

Kit silentbloc

Silent-bloc Kit

100

25

152

**226.076**

Kit silentbloc

Silent-bloc Kit

100

25

152

226.039

Kit silentbloc

Silent-bloc Kit

108

21

152

**226.068**

Kit silentbloc

Silent-bloc Kit

108

25

152

**226.063**

Silentbloc

Silent-bloc

91

**226.001**

Silentbloc

Silent-bloc

138

All original equipment manufacturer's numbers, symbols, pictures, models and description used in this catalogue are for reference only, and it is not implied that any part listed is the product of these manufacturers. Tutti i nostri particolari non sono originali ma con essi intercambiabili. I riferimenti originali, le figure, i modelli sono esposti a semplice titolo indicativo. La nostra produzione riporta il nostro marchio.



CEI no.  
**139.428**

O.E.M. Ref  
500343453  
4639392



*Modelli*  
**Buses 370S24/25/27/29/30/35**  
**EuroClass 29 - 35 - 36 - HD**

*Adattabile a / Suitable to*  
**IVECO**

CEI no.  
**226.036**

O.E.M. Ref  
000 350 1505



*Modelli*  
**MK - SK**

*Adattabile a / Suitable to*  
**MERCEDES**

CEI no.  
**117.261**

O.E.M. Ref  
00 00 408 563



*Modelli*  
**C230>340 - CBH280/340 - CLM**  
**G260/290-GBH260/280-TBH260/280**

**"R" Series Up to/Fino a 1992**  
*Adattabile a / Suitable to*  
**Renault V.I.**

CEI no.  
**117.260**

O.E.M. Ref  
00 00 408 52

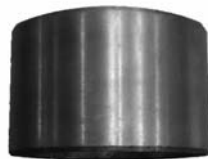

*Modelli*  
**C230>340 - CBH280/340 - CLM**  
**G260/290-GBH260/280-TBH260/280**

**"R" Series Up to/Fino a 1992**  
*Adattabile a / Suitable to*  
**Renault V.I.**

CEI no.  
**189.505**

O.E.M. Ref  
275460



*Modelli*  
**Serie "2" G/P/R/T 92-112-142**  
**Serie "3" G/P/R/T 93-113-143**

*Adattabile a / Suitable to*  
**SCANIA**

CEI no.  
**189.504**

O.E.M. Ref  
283642



*Modelli*  
**Serie "2" G/P/R/T 92-112-142**  
**Serie "3" G/P/R/T 93-113-143**

*Adattabile a / Suitable to*  
**SCANIA**

CEI no.  
**226.009**

O.E.M. Ref  
1368682  
349254



*Modelli*  
**Serie "3" G/P/R/T 93-113-143**  
**Serie "4" C/D/G/L 94-114-124-144**

*Adattabile a / Suitable to*  
**SCANIA**

CEI no.  
**226.007**

O.E.M. Ref  
1368681  
204749



*Modelli*  
**Serie "3" G/P/R/T 93-113-143**  
**Serie "4" C/D/G/L 94-114-124-144**

*Adattabile a / Suitable to*  
**SCANIA**

CEI no.  
**198.451**

O.E.M. Ref  
1586089  
1508080

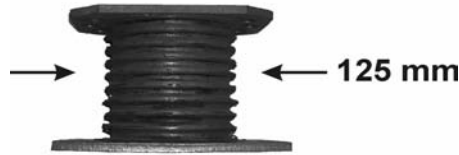

*Fori | Holes : 60 mm - 60 mm*

*Modelli*  
**F10-F12**  
**N10-N12**  
**1st Gen. / 1a Gen.**  
*Adattabile a / Suitable to*  
**VOLVO**

CEI no.  
**139.351**

O.E.M. Ref  
1609657  
1577873

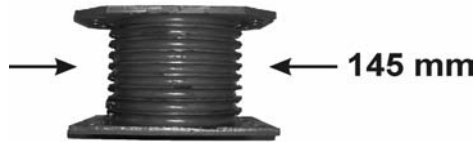

*Fori | Holes : 60 mm - 50 mm*

*Modelli*  
**F10-F12-N10-N12-FL10-FL12**  
**FH12-FH16-FM9-FM10-FM12**  
**2nd Gen. / 2a Gen.**  
*Adattabile a / Suitable to*  
**VOLVO**

CEI no.  
**198.766**

O.E.M. Ref  
20390836  
1629553

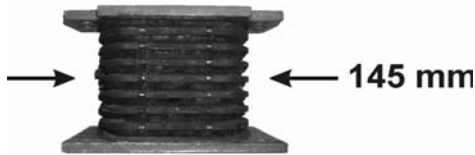

*Fori | Holes : 60 mm - 50 mm*

*Modelli*  
**FL10-FL12**  
**FH12-FH16-FM9-FM10-FM12**  
**3rd Gen. / 3a Gen.**  
*Adattabile a / Suitable to*  
**VOLVO**

CEI no.  
**117.234**

O.E.M. Ref  
1581543



*Modelli*  
**F10-F12-N10-N12-FL10-FL12**  
**FH12-FH16-FM9-FM10-FM12**  
  
*Adattabile a / Suitable to*  
**VOLVO**





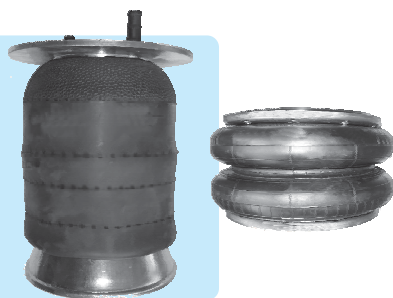









**Torpress**  
*Diapress*







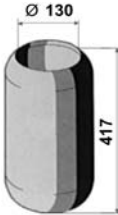



<p>CEI no. <b>260.162</b></p> <p>O.E.M. Ref 41019150 41019149</p>	 <p><i>Models</i> EuroTech - EuroStar - EuroTrakker</p>	<p>Membrana / Bellow <b>1GC 130-30</b></p> <p>OEM Code 206789 7514206789</p>	
<p>CEI no. <b>260.037</b></p> <p>O.E.M. Ref 98445471 93166129</p>	 <p><i>Models</i> TurboDaily (49.12-59.12) - EuroCargo (80Exx-100Exx)</p>	<p>Membrana / Bellow <b>1S 215-22</b></p> <p>OEM Code 206730 (90609) 75010609</p>	
<p>CEI no. <b>260.108</b></p> <p>O.E.M. Ref 500301776</p>	 <p><i>Models</i> EuroCargo (120Exx-130Exx-150Exx)</p>	<p>Membrana / Bellow <b>1S 215-23</b></p> <p>OEM Code 202189 7501202189</p>	
<p>CEI no. <b>260.105</b></p> <p>O.E.M. Ref 41008929 42554430</p>	 <p><i>Models</i> EuroTech - EuroStar - Stralis (190Exx &amp; 440Exx Series)</p>	<p>Membrana / Bellow <b>1S 270-19</b></p> <p>OEM Code 201732</p>	
<p>CEI no. <b>260.093</b></p> <p>O.E.M. Ref 8188526</p>	 <p><i>Models</i> TurboStar (Dal - From 6/92) - EuroTech - EuroStar - Stralis</p>	<p>Membrana / Bellow <b>1S 270-23(C)</b></p> <p>OEM Code 206733 (97619) 75017619</p>	
<p>CEI no. <b>260.163</b></p> <p>O.E.M. Ref 41026256</p> <p><b>ANTERIORE Sinistra</b> <b>FRONT Left</b></p>	 <p><i>Models</i> EuroTech - EuroStar - Stralis (400Exx &amp; 440Exx Series)</p>	<p>Membrana / Bellow <b>1S 270-23</b></p> <p>OEM Code 206790 7501206790</p>	

All original equipment manufacturers numbers, symbols, pictures, models and description used in this catalogue are for reference only, and it is not implied that any part listed is the product of these manufactures. Tutti i nostri particolari non sono originali ma con essi intercambiabili. I riferimenti originali, le figure, i modelli sono esposti a semplice titolo indicativo. La nostra produzione riporta il nostro marchio.

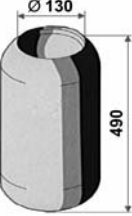
All original equipment manufacturer's numbers, symbols, pictures, models and description used in this catalogue are for reference only, and it is not implied that any part listed is the product of these manufactures. Tutti i nostri particolari non sono originali ma con essi intercambiabili. I riferimenti originali, le figure, i modelli sono esposti a semplice titolo indicativo. La nostra produzione riporta il nostro marchio.

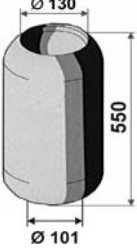
<p>CEI no. <b>260.164</b> O.E.M. Ref 41026257 <b>ANTERIORE Destra</b> <b>FRONT Right</b></p>	 <i>Models</i> EuroTech - EuroStar - Stralis 400E & 440E Series	<p>Membrana / Bellow <b>1S 270-23</b> OEM Code 206791 7501206791</p>	
<p>CEI no. <b>260.165</b> O.E.M. Ref 41026285 <b>POSTERIORE Sinistra</b> <b>REAR Left</b></p>	 <i>Models</i> EuroTech - EuroStar - Stralis 400E & 440E Series	<p>Membrana / Bellow <b>1S 270-23</b> OEM Code 206792 7501206792</p>	
<p>CEI no. <b>260.166</b> O.E.M. Ref 41026286 <b>POSTERIORE Destra</b> <b>REAR Right</b></p>	 <i>Models</i> EuroTech - EuroStar - Stralis 400E & 440E Series	<p>Membrana / Bellow <b>1S 270-23</b> OEM Code 206793 7501206793</p>	
<p>CEI no. <b>260.167</b> O.E.M. Ref 41026270 <b>ANTERIORE Sinistra</b> <b>FRONT Left</b></p>	 <i>Models</i> EuroTech - EuroStar 180E & 190E Series	<p>Membrana / Bellow <b>1S 270-23</b> OEM Code 206794 7501206794</p>	
<p>CEI no. <b>260.168</b> O.E.M. Ref 41026271 <b>ANTERIORE Destra</b> <b>FRONT Right</b></p>	 <i>Models</i> EuroTech - EuroStar 180E & 190E Series	<p>Membrana / Bellow <b>1S 270-23</b> OEM Code 206795 7501206795</p>	
<p>CEI no. <b>260.089</b> O.E.M. Ref 8188539</p>	 <i>Models</i> EuroCargo 170E & 180E Series EuroTech - EuroStar - Stralis 240E & 260E Series	<p>Membrana / Bellow <b>1S 270-25 C</b> OEM Code 97608 75017608</p>	

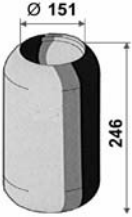

<p>CEI no. <b>260.018</b></p> <p>O.E.M. Ref 4714025 4722525 4735768 4736728</p>	 <p><i>Models</i> TurboStar - TurboTech</p>	<p>Membrana / Bellow <b>1S 285-22</b></p> <p>OEM Code 88786 75018786</p>	
<p>CEI no. <b>260.025</b></p> <p>O.E.M. Ref 4714019</p>	 <p><i>Models</i> TurboStar - TurboTech</p>	<p>Membrana / Bellow <b>1S 285-22</b></p> <p>OEM Code 88817 75018817</p>	
<p>CEI no. <b>260.085</b></p> <p>O.E.M. Ref 8166340</p>	 <p><i>Models</i> EuroStar - EuroTech - Stralis 240E &amp; 260E Series</p>	<p>Membrana / Bellow <b>1S 285-29</b></p> <p>OEM Code 97390 75017390</p>	
<p>CEI no. <b>260.171</b></p> <p>O.E.M. Ref 500364663</p>	 <p><i>Models</i> EuroStar - EuroTech - Stralis 190E &amp; 260E Series</p>	<p>Membrana / Bellow <b>1S 290-30V</b></p> <p>OEM Code 205074 7501205074</p>	
<p>CEI no. <b>260.035</b></p> <p>O.E.M. Ref 4456111 4746728 4746740</p>	 <p><i>Models</i> TurboTech 240 Series</p>	<p>Membrana / Bellow <b>1S 323-23</b></p> <p>OEM Code 89756 75019756</p>	
<p>CEI no. <b>260.041</b></p> <p>O.E.M. Ref 8139068 42555565</p> <p><b>3° Axle Vecchio Tipo</b> <b>3rd Axle Old Type</b></p>	 <p><i>Models</i> EuroStar - EuroTech 240E Series</p>	<p>Membrana / Bellow <b>1S 323-34</b></p> <p>OEM Code 92477 75012477</p>	

All original equipment manufacturers numbers, symbols, pictures, models and description used in this catalogue are for reference only, and it is not implied that any part listed is the product of these manufacturers. Tutti i nostri particolari non sono originali ma con essi intercambiabili. I riferimenti originali, le figure, i modelli sono esposti a semplice titolo indicativo. La nostra produzione riporta il nostro marchio.

CEI no.  
**260.122**

O.E.M. Ref  
41022620

**3° Axle Nuovo Tipo**  
**3rd Axle New Type**

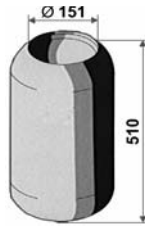

**Models**  
EuroStar - EuroTech - Stralis 240E Series

Membrana / Bellow

**1S 323-36**

OEM Code  
203833  
7501203833



CEI no.  
**260.104**

O.E.M. Ref  
41006926

**Versioni Speciali**  
**Special Applications**

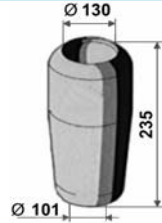

**Models**  
EuroStar - EuroTech - Stralis 190E & 260E Series  
*Sospensione Anteriore per veicoli con assale ribassato*

Membrana / Bellow

**1SC 250-19**

OEM Code  
201727



CEI no.  
**260.091**

O.E.M. Ref  
8137291

**Models**

EuroStar - EuroTech 240E - 400E - 440E Series

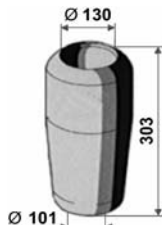

Membrana / Bellow

**1SC 260-30**

OEM Code  
97613  
75017613



CEI no.  
**260.072**

O.E.M. Ref  
98411807

**Models**

EuroCargo 120E - 130E - 150E Series

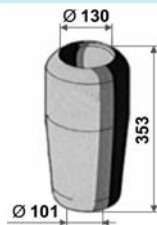

Membrana / Bellow

**1SC 260-32**

OEM Code  
96987  
75016987



CEI no.  
**260.192**

O.E.M. Ref  
41270462

**Models**

EuroTech - EuroStar - Stralis AD/AT 440E-440S

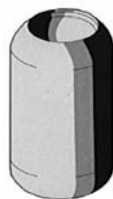

Membrana / Bellow

**1TS 270-23**

OEM Code  
206686

*Nessuna Immagine*  
*No Picture*

CEI no.  
**260.193**

O.E.M. Ref  
41270463

**Models**

EuroTech - EuroStar - Stralis AD/AT 440E-440S

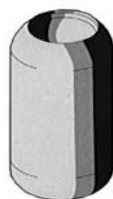

Membrana / Bellow

**1TS 270-23**

OEM Code  
206687

*Nessuna Immagine*  
*No Picture*

CEI no.  
**260.194**

O.E.M. Ref  
41270466

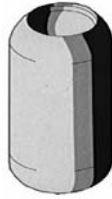

Membrana / Bellow

**1TS 270-23**

OEM Code  
**206685**

*Nessuna Immagine*  
**No Picture**

**Models**  
EuroTech - EuroStar - Stralis AD/AT 440E-440S

CEI no.  
**260.195**

O.E.M. Ref  
41270465

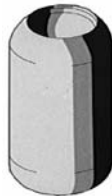

Membrana / Bellow

**1TS 270-23**

OEM Code  
**206684**

*Nessuna Immagine*  
**No Picture**

**Models**  
EuroTech - EuroStar - Stralis AD/AT 440E-440S

CEI no.  
**260.170**

O.E.M. Ref  
41026260



Membrana / Bellow

**1S270-25**

OEM Code  
**206796**

*Nessuna Immagine*  
**No Picture**

**Models**  
EuroCargo 170E - 180E - EuroTech - EuroStar - Stralis AD/AT 240E-260E

All original equipment manufacturers numbers, symbols, pictures, models and description used in this catalogue are for reference only, and it is not implied that any part listed is the product of these manufacturers.  
Tutti i nostri particolari non sono originali ma con essi intercambiabili. I riferimenti originali, le figure, i modelli sono esposti a semplice titolo indicativo. La nostra produzione riporta il nostro marchio.

CEI no.  
**260.033**

O.E.M. Ref  
8194818

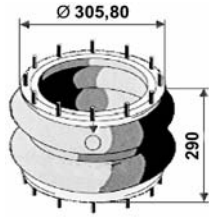

**Models**  
Sollevatore aggiunto - Lifting device

Membrana / Bellow

**21 BR**

OEM Code  
89457  
75009457



CEI no.  
260.080

O.E.M. Ref  
42126126



**Models**  
Sollevatore aggiunto - Lifting device

Membrana / Bellow

**21A BR**

OEM Code  
97300  
75007300



CEI no.  
**260.040**

O.E.M. Ref  
42107588

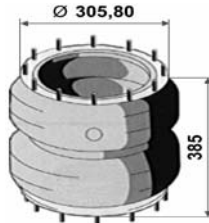

**Sosp. Centrale**  
**Central Susp.**

**Models**  
TurboTech - TurboStar 240 Series

Membrana / Bellow

**21B BR**

OEM Code  
92154  
75002154



CEI no.  
**260.030**

O.E.M. Ref  
42107595

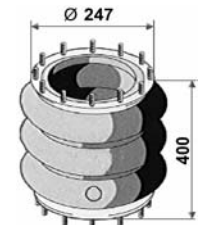

**Sosp. Laterale**  
**Lateral Susp.**

**Models**  
TurboTech - TurboStar 240 Series

Membrana / Bellow

**322 B.R.**

OEM Code  
89413  
75009413



CEI no.  
**260.015**

O.E.M. Ref  
98460983

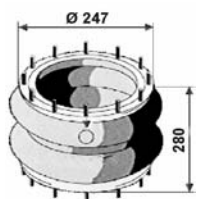

**Models**  
Sollevatore aggiunto - Lifting device

Membrana / Bellow

**22**

OEM Code  
88544



<p>CEI no. <b>260.037</b></p> <p>O.E.M. Ref 93166129 98445471</p>	 <p><b>Models</b> BUS 490 - 590 - 623</p>	<p>Membrana / Bellow</p> <p><b>1S 215-22</b></p> <p>OEM Code 206730 (90609) 75010609</p>	
<p>CEI no. <b>260.113</b></p> <p>O.E.M. Ref 42531994</p>	 <p><b>Models</b> BUS CityClass (Sosp. Posteriore / Rear Susp.)</p>	<p>Membrana / Bellow</p> <p><b>1S 270-20V</b></p> <p>OEM Code 206745 (202773) 206745</p>	
<p>CEI no. <b>260.057</b></p> <p>O.E.M. Ref 4843220</p>	 <p><b>Models</b> BUS TurboCity 480-580-680 (Sosp. Posteriore / Rear Susp.)</p>	<p>Membrana / Bellow</p> <p><b>1S 285-20</b></p> <p>OEM Code 96534 75016354</p>	
<p>CEI no. <b>260.017</b></p> <p>O.E.M. Ref 4703972 4738784 4763694</p>	 <p><b>Models</b> BUS 370 - 421 (Sosp. Posteriore / Rear Susp.)</p>	<p>Membrana / Bellow</p> <p><b>1S 285-25</b></p> <p>OEM Code 88709 75018709</p>	
<p>CEI no. <b>260.020</b></p> <p>O.E.M. Ref 4703904</p>	 <p><b>Models</b> BUS 370 (Sosp. Anteriore / Front Susp.)</p>	<p>Membrana / Bellow</p> <p><b>1S 285-25</b></p> <p>OEM Code 88800 75018800</p>	
<p>CEI no. <b>260.064</b></p> <p>O.E.M. Ref 93195986</p>	 <p><b>Models</b> BUS EuroClass (Sosp. Posteriore / Rear Susp.)</p>	<p>Membrana / Bellow</p> <p><b>1S 285-25</b></p> <p>OEM Code 96825 75016825</p>	

All original equipment manufacturers numbers, symbols, pictures, models and description used in this catalogue are for reference only, and it is not implied that any part listed is the product of these manufacturers. Tutti i nostri particolari non sono originali ma con essi intercambiabili. I riferimenti originali, le figure, i modelli sono esposti a semplice titolo indicativo. La nostra produzione riporta il nostro marchio.



CEI no.  
**260.134**

O.E.M. Ref  
500324098

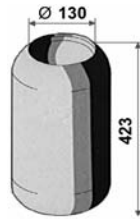

**Models**  
BUS CityClass (Susp. Anteriore / Front Susp.)

Membrana / Bellow

**1S 290-23V**

OEM Code  
204427  
7501204427



CEI no.  
**260.038**

O.E.M. Ref  
93197594  
41822247

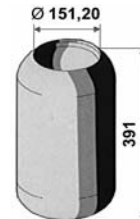

**Models**  
BUS 470 - 570 - 670 (Susp.Ant. E Post. / Front and Rear Susp.)

Membrana / Bellow

**1S 310-28-RF**

OEM Code  
91016  
75011016



CEI no.  
**260.059**

O.E.M. Ref  
4843255  
4847671  
4212432

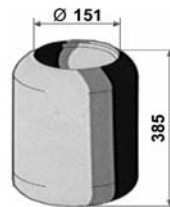

**Models**  
BUS TurboCity 480-580-680 - EuroClass (Susp.Ant. / Front Susp.)

Membrana / Bellow

**1S 323-25**

OEM Code  
96541  
75016541



CEI no.  
**260.070**

O.E.M. Ref  
93195789



**Models**  
BUS EuroClass (Susp.Ant. /Front Susp.)

Membrana / Bellow

**1S 323-25**

OEM Code  
96898  
75016898



CEI no.  
**260.047**

O.E.M. Ref  
42536242

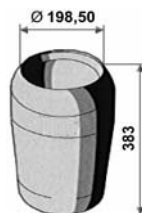

**Models**  
BUS EuroRider - MyWay (Susp. Anteriore / Front Susp.)

Membrana / Bellow

**1SC 360-30**

OEM Code  
92594  
75012594



CEI no.  
**260.006**

O.E.M. Ref  
4680913  
9007195



**Models**  
BUS 315 - 316 - 343 (Anteriore e Posteriore / Front and Rear)

Membrana / Bellow

**1T 252-2**

OEM Code  
86984  
75016984





CEI no.  
**260.008**

O.E.M. Ref  
4650232

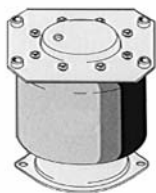

Membrana / Bellow

**1T 252-2**

OEM Code

**87096  
75017096**



**Models**

**BUS 315 - 316 - 343** (Anteriore e Posteriore / Front and Rear)

CEI no.  
**260.037**

O.E.M. Ref  
192709

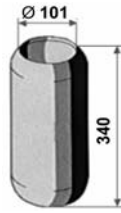

*Models*  
BredaMenariniBus 230

Membrana / Bellow

**1S 215-22**

OEM Code  
206730 (90609)  
75010609



CEI no.  
**260.147**

O.E.M. Ref  
D042807

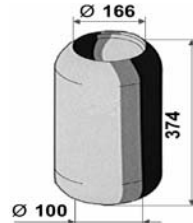

*Models*  
BredaMenariniBus 231

Membrana / Bellow

**1S 215-24**

OEM Code  
204772  
7501204772



CEI no.  
**260.113**

O.E.M. Ref  
D020990

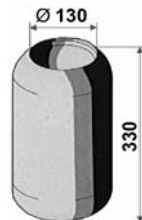

*Models*  
BredaMenariniBus 221 - 321

Membrana / Bellow

**1S 270-20V**

OEM Code  
206745 (202773)  
206745



CEI no.  
**260.023**

O.E.M. Ref  
5001051

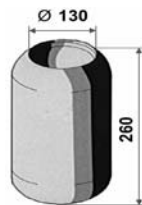

*Models*  
Inbus 150 - 210 - 240 - 2001 - 5001

Membrana / Bellow

**1S 285-18**

OEM Code  
88809  
75018809



CEI no.  
**260.024**

O.E.M. Ref  
001800  
4840001

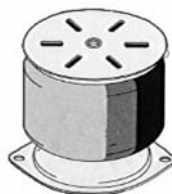

*Models*  
Inbus 150 - 210 - 240 - 2001

Membrana / Bellow

**1S 285-18**

OEM Code  
88811  
75018811



CEI no.  
**260.018**

O.E.M. Ref  
178623  
5001098

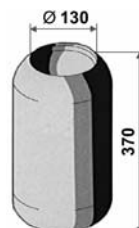











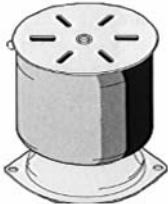

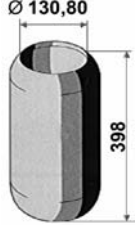
*Models*  
BredaMenariniBus 201 - 201/1LU - Inbus 330

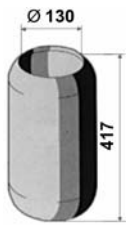
Membrana / Bellow

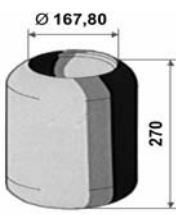
**1S 285-22**

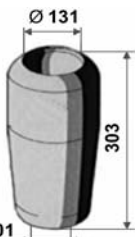
OEM Code  
88786  
75018786

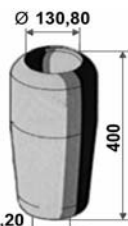

<p>CEI no. <b>260.028</b> O.E.M. Ref 5001043 4840005</p>	 <p><i>Models</i> Inbus 330</p>	<p>Membrana / Bellow <b>1S 285-22</b> OEM Code 89406 75019406</p>	
<p>CEI no. <b>260.044</b> O.E.M. Ref 199196</p>	 <p><i>Models</i> BredaMenariniBus M 220 (Trasporto Urbano / City Bus)</p>	<p>Membrana / Bellow <b>1S 285-24</b> OEM Code 92574 75012574</p>	
<p>CEI no. <b>260.087</b> O.E.M. Ref 178741</p>	 <p><i>Models</i> BredaMenariniBus 101 - 102 - 110 L - 120</p>	<p>Membrana / Bellow <b>1S 285-25C</b> OEM Code 97555 (88787) 75017555</p>	
<p>CEI no. <b>260.027</b> O.E.M. Ref 5001964 S5001098</p>	 <p><i>Models</i> Inbus 330</p>	<p>Membrana / Bellow <b>1S 320-17</b> OEM Code 89405 75019405</p>	
<p>CEI no. <b>260.084</b> O.E.M. Ref 252933</p>	 <p><i>Models</i> BredaMenariniBus 230</p>	<p>Membrana / Bellow <b>1SC 240-30 BB</b> OEM Code 97326 75017326</p>	
<p>CEI no. <b>260.075</b> O.E.M. Ref D031105</p>	 <p><i>Models</i> BredaMenariniBus 240</p>	<p>Membrana / Bellow <b>1SC 250-28</b> OEM Code 97042 75010123</p>	

All original equipment manufacturers numbers, symbols, pictures and description used in this catalogue are for reference only, and it is not implied that any part listed is the product of these manufactures. Tutti i nostri particolari non sono originali ma con essi intercambiabili. I riferimenti originali, le figure, i modelli sono esposti a semplice titolo indicativo. La nostra produzione riporta il nostro marchio.

CEI no.

**260.018**

O.E.M. Ref  
383 327 0001  
621 328 0001

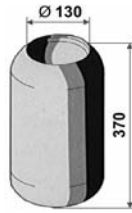

**Models**

BUS LK - MK - SK Chassis 675-676-677 / 619-620 / 655-657

Membrana / Bellow

**1S 285-22**

OEM Code  
88786  
75018786



CEI no.

**260.044**

O.E.M. Ref  
307 327 0001  
307 327 0101  
000 327 0101  
000 327 0201

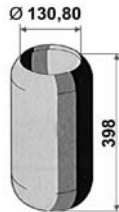

**Models**

BUS O302 - O303 - O309 - O317 - O405 - O407 Chassis 300-301-317-357-600

Membrana / Bellow

**1S 285-24**

OEM Code  
92574  
75012574



CEI no.

**260.087**

O.E.M. Ref  
382 327 7201  
382 327 7301

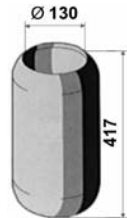

**Models**

BUS O500 Chassis 382-634

Membrana / Bellow

**1S 285-25C**

OEM Code  
97555 (88787)  
75017555



CEI no.

**260.021**

O.E.M. Ref  
387 328 0001  
387 328 0101

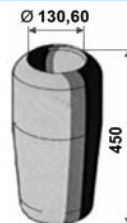

**Models**

NG - MK - SK Chassis 381-385-38-393 7 / 616-617-619-620 / 651-652-653-655

Membrana / Bellow

**1SC 290-30**

OEM Code  
88802  
75018802



CEI no.

260.176

O.E.M. Ref  
942 320 4321  
942 320 0117



**Models (SOSPENSIONI Ant | FRONT Susp.)**

MAXI-ATEGO, ACTROS & NEW ACTROS Chassis 930-934-950-954-957

Membrana / Bellow

**1VSC 300-26**

OEM Code  
206785  
7501206785

*Nessuna Immagine  
No Picture*

All original equipment manufacturers' numbers, symbols, pictures, models and description used in this catalogue are for reference only, and it is not implied that any part listed is the product of these manufacturers. Tutti i nostri particolari non sono originali ma con essi intercambiabili. I riferimenti originali, le figure, i modelli sono esposti a semplice titolo indicativo. La nostra produzione riporta il nostro marchio.

CEI no.  
**260.044**

O.E.M. Ref  
4771441000  
4771143000  
4771170000  
4771359000

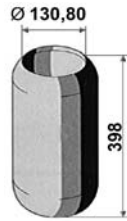

**Models**

BUS S180 - S 200 - S 209 - S 210 - S 211 - S 213 - S 214 - S 215 - S 216 - S 228

Membrana / Bellow

**1S 285-24**

OEM Code

92574

75012574



CEI no.  
**260.038**

O.E.M. Ref  
4711440000  
4731012000  
4731031000

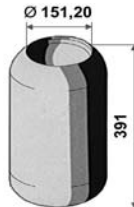

**Models**

BUS S180 - S 200 - S 209 - S 210 - S 211 - S 213 - S 214 - S 215 - S 216 - S 228

Membrana / Bellow

**1S 310-28-RF**

OEM Code

91016

75011016



CEI no.  
**260.011**

O.E.M. Ref  
4731030000  
4731033000



**Models**  
BUS

Membrana / Bellow

**1T 19E-2**

OEM Code

87408

75017408



CEI no.  
**260.040**

O.E.M. Ref  
4731018000

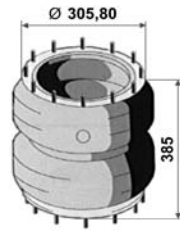

*Models*  
BUS

Membrana / Bellow

**21 B BR**

OEM Code

92154

75002154



CEI no.  
**260.042**

O.E.M. Ref  
4731007000

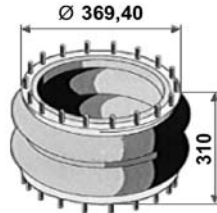

*Models*  
BUS

Membrana / Bellow

**28 BR**

OEM Code











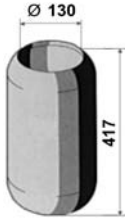

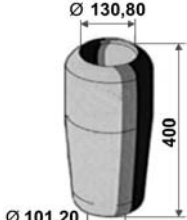
92527

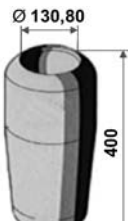
75002527

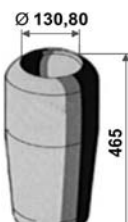

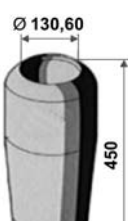
All original equipment manufacturer's numbers, symbols, pictures, models and description used in this catalogue are for reference only, and it is not implied that any part listed is the product of these manufactures.  
Tutti i nostri particolari non sono originali ma con essi intercambiabili. I riferimenti originali, le figure, i modelli sono esposti a semplice titolo indicativo. La nostra produzione riporta il nostro marchio.

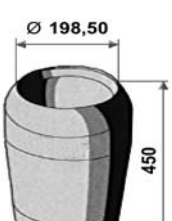

<p><b>CEI no.</b> <b>260.089</b></p> <p><b>O.E.M. Ref</b> 81 43601 0125 81 43601 0106 81 43601 0068</p>	 <p><b>Models</b> F90 - M90 - L2000 - M200 - F2000 Chassis Exx - Fxx - Mxx - Txx</p>	<p>Membrana / Bellow</p> <p><b>1S 270-25C</b></p> <p>OEM Code</p> <p><b>97608</b> <b>75017608</b></p>	
<p><b>CEI no.</b> <b>260.075</b></p> <p><b>O.E.M. Ref</b> 81 43601 0121 81 43601 0099 81 43601 0132 81 43601 0136</p>	 <p><b>Models</b> F90 - M90 - L2000 - M2000 - F2000 Chassis Exx - Fxx - Lxx - Mxx - Txx</p>	<p>Membrana / Bellow</p> <p><b>1SC 250-28</b></p> <p>OEM Code</p> <p><b>97042</b> <b>75010123</b></p>	
<p><b>CEI no.</b> <b>260.076</b></p> <p><b>O.E.M. Ref</b> 81 43601 0150 81 43601 0147 81 43601 0146 81 43601 0120</p>	 <p><b>Models</b> G90 - F90 - M90 - M2000 - F2000 Chassis Exx - Fxx - Lxx - Mxx - Txx</p>	<p>Membrana / Bellow</p> <p><b>1SC 270-28</b></p> <p>OEM Code</p> <p><b>97043</b> <b>75017043</b></p>	
<p><b>CEI no.</b> <b>260.109</b></p> <p><b>O.E.M. Ref</b> 81 43601 0104 81 43601 0140 Sos da / Repl By 81 43601 0150</p>	 <p><b>Models</b> M90 - F90 - F2000 Chassis Fxx - Mxx - Txx</p>	<p>Membrana / Bellow</p> <p><b>1SC 270-30</b></p> <p>OEM Code</p> <p><b>202265</b> <b>75010125</b></p>	
<p><b>CEI no.</b> <b>260.021</b></p> <p><b>O.E.M. Ref</b> 81 43601 0033 81 43601 0036 81 43601 0037 81 43601 0126</p>	 <p><b>Models</b> OLD GENERATION Chassis 470-474-475-504-506-522-526-527-754-930</p>	<p>Membrana / Bellow</p> <p><b>1SC 290-30</b></p> <p>OEM Code</p> <p><b>88802</b> <b>75018802</b></p>	
<p><b>CEI no.</b> <b>260.047</b></p> <p><b>O.E.M. Ref</b> 81 43601 0081 81 43601 0059 81 43601 0113</p>	 <p><b>Models</b> BUS SU/SUE/SL/SG 200 - 202 - 240 - 242 - 280 - 290 - 292 - 322</p>	<p>Membrana / Bellow</p> <p><b>1SC 360-30</b></p> <p>OEM Code</p> <p><b>92594</b> <b>75012594</b></p>	

All original equipment manufacturers numbers, symbols, pictures and description used in this catalogue are for reference only, and it is not implied that any part listed is the product of these manufactures. Tutti i nostri particolari non sono originali ma con essi intercambiabili. I riferimenti originali, le figure, i modelli sono esposti a semplice titolo indicativo. La nostra produzione riporta il nostro marchio.

CEI no.

**260.047**

O.E.M. Ref  
50 00 786 901  
50 00 819 517

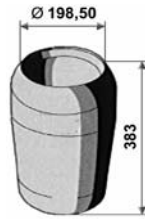

**Models**  
Serie "R" (Fino-Up to 92')

Membrana / Bellow

**1SC 360-30**

OEM Code  
92594  
75012594



CEI no.

**260.011**

O.E.M. Ref  
50 10 130 925  
50 00 790 692



**Models**  
Serie "R" (Fino-Up to 92' + Dal-From 93') - "G" MANAGER - MAGNUM (AE)

Membrana / Bellow

**1T 19E-2**

OEM Code  
87408  
75017408



CEI no.

**260.181**

O.E.M. Ref  
50 10 294 307



**Models**  
PREMIUM - MAGNUM (AE) - KERAX

Membrana / Bellow

**1T 19E-4**

OEM Code  
206779  
7501206779



CEI no.  
**260.096**

O.E.M. Ref  
1107674  
255293



**Models**

Serie 2 (92 / 112 / 142) - Serie 3 (93 / 113 / 143)

Membrana / Bellow

**A.S. E-2 BR**

OEM Code  
97764  
75017764



CEI no.  
**260.159**

O.E.M. Ref  
1440294  
1439284  
1379392  
1379393



**Models**

Serie 4 (94 / 114 / 124 / 144 / 164) - Serie R

Membrana / Bellow

**1T 19E-93**

OEM Code  
206201  
7501206201



All original equipment manufacturers' numbers, symbols, pictures, models and description used in this catalogue are for reference only, and it is not implied that any part listed is the product of these manufacturers.  
Tutti i nostri particolari non sono originali ma con essi intercambiabili. I riferimenti originali, le figure, i modelli sono esposti a semplice titolo indicativo. La nostra produzione riporta il nostro marchio.

CEI no.  
**260.018**

O.E.M. Ref  
1611776

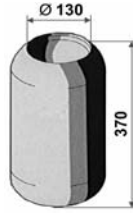

**Models**  
FL7 - F10 - FL10

Membrana / Bellow

**1S 285-22**

OEM Code  
88786  
75018786



CEI no.  
**260.044**

O.E.M. Ref  
6797169  
1590136  
1622116  
1622111

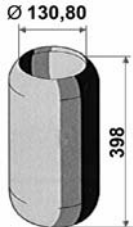

**Models**  
F10 - F12 - F16

Membrana / Bellow

**1S 285-24**

OEM Code  
92574  
75012574



CEI no.  
**260.038**

O.E.M. Ref  
1137888  
3159253  
1137882

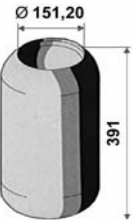

**Models**  
F10 - F12 - F16 BUS B7R - B10M - B12

Membrana / Bellow

**1S 310-28-RF**

OEM Code  
91016  
75011016



CEI no.  
**260.021**

O.E.M. Ref  
1075290  
1622115  
1593842

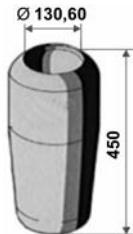

**Models**  
F10 - F12 - F16 - FL6 - FL7 - FL10 - FH12 - FH16 - FM7 - FM10 - FM12

Membrana / Bellow

**1SC 290-30**

OEM Code  
88802  
75018802



CEI no.  
**260.153**

O.E.M. Ref  
1080707



**Models**  
F10 - F12

Membrana / Bellow

**1T 19E-1**

OEM Code  
87413/1  
75010101



CEI no.  
**260.182**

O.E.M. Ref  
20554755  
1076594  
1076595  
8158106











**Models**  
F12 - F16 - FH12 - FH16 - FM7 - FM10 - FM12

Membrana / Bellow

**1TS 300-28**

OEM Code  
206778  
7501206778



<p>CEI no. <b>260.011</b> O.E.M. Ref 448543</p>	  <p><i>Models</i> <b>ACERBI</b></p>	<p>Membrana / Bellow <b>1T 19E-2</b></p> <p>OEM Code <b>87408</b> <b>75017408</b></p>	
<p>CEI no. <b>260.106</b> O.E.M. Ref M001464</p>	  <p><i>Models</i> <b>ACERBI</b></p>	<p>Membrana / Bellow <b>1T 19E-3</b></p> <p>OEM Code <b>201840</b> <b>7501B840</b></p>	
<p>CEI no. <b>260.063</b> O.E.M. Ref 431810</p>	  <p><i>Models</i> <b>ACERBI</b></p>	<p>Membrana / Bellow <b>1T 280-40</b></p> <p>OEM Code <b>96692</b> <b>75016692</b></p>	
<p>CEI no. <b>260.099</b> O.E.M. Ref M001774</p> <p><i>Pistone in COMPOSITO</i> <i>COMPOSITE Piston</i></p>	  <p><i>Models</i> <b>ACERBI</b> <i>(Per modelli dal / For Model from 2/1990)</i></p>	<p>Membrana / Bellow <b>1T 323-40</b></p> <p><b>75016978</b> <b>200751</b> <b>200751</b></p>	

All original equipment manufacturers numbers, symbols, pictures, models and description used in this catalogue are for reference only, and it is not implied that any part listed is the product of these manufactures. Tutti i nostri particolari non sono originali ma con essi intercambiabili. I riferimenti originali, le figure, i modelli sono esposti a semplice titolo indicativo. La nostra produzione riporta il nostro marchio.

CEI no.

**260.183**

O.E.M. Ref  
05.429.40.91.0

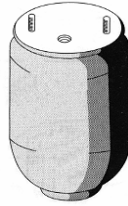

Membrana / Bellow

**1TC 300-30**

OEM Code  
205536  
7501205536



*Models*

BPW 30K (940 MB) Dimensione Ø 300 mm

CEI no.

**260.138**

O.E.M. Ref  
05.429.40.03.0



Membrana / Bellow

**1TC 300-36**

OEM Code  
204466  
7501204466



*Models*

BPW 30 (941 MB) Dimensione Ø 300 mm

CEI no.

**260.150**

O.E.M. Ref  
05.429.41.24.1  
05.429.40.09.1  
05.429.40.52.1  
05.429.41.28.1



Membrana / Bellow

**1TC 300-36**

OEM Code  
205170  
7501205170



*Models*

BPW 30 (941 MB) Pistone Normale / Normal Piston

CEI no.

**260.158**

O.E.M. Ref  
05.429.41.24.1  
05.429.40.09.1  
05.429.40.52.1  
05.429.41.28.1



Membrana / Bellow

**1TC 300-36**

OEM Code  
206356  
7501206356



*Models*

BPW 30 (941 MB) Pistone in Composito / Composite

CEI no.

**260.141**

O.E.M. Ref  
05.429.40.01.0  
05.429.40.02.0



Membrana / Bellow

**1TC 360-45**

OEM Code  
204530  
7501204530



*Models*

BPW 36 (881 MB) Dimensione Ø 360 mm

CEI no.

**260.160**

O.E.M. Ref  
05.429.43.51.0  
05.429.40.61.1  
05.429.40.47.1  
05.429.40.14.1



Membrana / Bellow

**1TC 360-45**

OEM Code  
206357  
7501206357

Nessuna Immagine  
No Picture

*Models*

BPW 36 Dimensione Ø 360 mm

All original equipment manufacturer's numbers, symbols, pictures, models and description used in this catalogue are for reference only, and it is not implied that any part listed is the product of these manufacturers. Tutti i nostri particolari non sono originali ma con essi intercambiabili. I riferimenti originali, le figure, i modelli sono esposti a semplice titolo indicativo. La nostra produzione riporta il nostro marchio.



CEI no.

260.052

O.E.M. Ref  
05.419.00.28.0

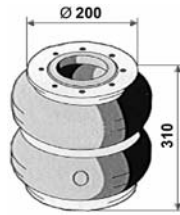

**Models**  
BPW HydroBalg - Pneumatica

Membrana / Bellow

**245**

OEM Code

**93740**  
**75003740**



CEI no.  
**260.153**

O.E.M. Ref  
21208082  
21215632



**Models**  
R.O.R FLEXAIR FL11000L

Membrana / Bellow

**1T 19E-1**

OEM Code  
87413/1  
75010101



CEI no.  
**260.067**

O.E.M. Ref  
21215761  
21208939



**Models**  
R.O.R INDAIR WFL 115 S/T - WFL 128 - WFL 131

Membrana / Bellow

**1T 323-33**

OEM Code  
96873  
75016873



CEI no.  
**260.156**

O.E.M. Ref  
21222442



**Models**  
R.O.R FLEXAIR FL9000 - FL9000 L









Membrana / Bellow

**1TC 300-38**

OEM Code  
205598  
7501205598















All original equipment manufacturer's numbers, symbols, pictures, models and description used in this catalogue are for reference only, and it is not implied that any part listed is the product of these manufactures.  
Tutti i nostri particolari non sono originali ma con essi intercambiabili. I riferimenti originali, le figure, i modelli sono esposti a semplice titolo indicativo. La nostra produzione riporta il nostro marchio.

<p>CEI no. <b>260.096</b></p> <p>O.E.M. Ref 3 229 0006 01 3 229 0005 00 3 229 0013 00 <b>2926 / E4</b></p>	 <p><i>Models</i> SAF</p>	<p>Membrana / Bellow</p> <p><b>A.E. E-2 BR</b></p> <p>OEM Code <b>97764</b> <b>75017764</b></p>	
<p>CEI no. <b>260.153</b></p> <p>O.E.M. Ref 2 229 0002 00</p> <p><b>2918 / E1</b></p>	 <p><i>Models</i> SAF AR112 - AR113</p>	<p>Membrana / Bellow</p> <p><b>1T 19E-1</b></p> <p>OEM Code <b>87413/1</b> <b>75010101</b></p>	
<p>CEI no. <b>260.011</b></p> <p>O.E.M. Ref 2 229 0003 00</p> <p><b>2923 / E2</b></p>	 <p><i>Models</i> SAF AR211 - AR212 - AR213 - AR313 - EM 311 EH/H EO314 EH/H - EU316 EH/H - AR413 - EM411 EH/H - EO414 EH/H - EU416 - EU416 EH/H</p>	<p>Membrana / Bellow</p> <p><b>1T 19E-2</b></p> <p>OEM Code <b>87408</b> <b>75017408</b></p>	
<p>CEI no. <b>260.146</b></p> <p>O.E.M. Ref 3 229 0029 00</p> <p><b>2618 V</b></p>	 <p><i>Models</i> SAF Baukastensystem M - O - U Series / INTRAAX XO-XU Series</p>	<p>Membrana / Bellow</p> <p><b>1T 300-37</b></p> <p>OEM Code <b>206340 (204677)</b> <b>7501206340</b></p>	

All original equipment manufacturers numbers, symbols, pictures, models and description used in this catalogue are for reference only, and it is not implied that any part listed is the product of these manufactures.  
Tutti i nostri particolari non sono originali ma con essi intercambiabili. I riferimenti originali, le figure, i modelli sono esposti a semplice titolo indicativo. La nostra produzione riporta il nostro marchio.

All original equipment manufacturer's numbers, symbols, pictures, models and description used in this catalogue are for reference only, and it is not implied that any part listed is the product of these manufactures. Tutti i nostri particolari non sono originali ma con essi intercambiabili. I riferimenti originali, le figure, i modelli sono esposti a semplice titolo indicativo. La nostra produzione riporta il nostro marchio.

<p><b>CEI no.</b> <b>260.069</b></p> <p>O.E.M. Ref 1006545</p>	 <p><i>Models</i> <b>ZORZI</b></p>	<p>Membrana / Bellow <b>1T 19E-2</b></p> <p>OEM Code <b>96885</b> <b>75016885</b></p>	
<p><b>CEI no.</b> <b>260.053</b></p> <p>O.E.M. Ref 2211401 58050700 112060 128147102 1006553</p>	 <p><i>Models</i> <b>BATTAGLINO - CARDI - ROLFO - VIBERTI - ZORZI</b></p>	<p>Membrana / Bellow <b>1T 19E-2</b></p> <p>OEM Code <b>204371 (93762)</b> <b>7501204371</b></p>	
<p><b>CEI no.</b> <b>260.103</b></p> <p>O.E.M. Ref 11815 112010 1006557</p>	 <p><i>Models</i> <b>OMAR - ROLFO - ZORZI</b></p>	<p>Membrana / Bellow <b>1T 19E-6</b></p> <p>OEM Code <b>201715</b> <b>7501B715</b></p>	
<p><b>CEI no.</b> <b>260.054</b></p> <p>O.E.M. Ref 91619012 42402001 58050600 128147101 1006549</p>	 <p><i>Models</i> <b>BARTOLETTI - BERTOJA - CARDI - VIBERTI - ZORZI</b></p>	<p>Membrana / Bellow <b>1T 280-30</b></p> <p>OEM Code <b>93774</b> <b>75013774</b></p>	
<p><b>CEI no.</b> <b>260.066</b></p> <p>O.E.M. Ref 45402007 58050900 11808 112322 1006551</p>	 <p><i>Models</i> <b>BERTOJA - CARDI - OMAR - ROLFO - ZORZI</b></p>	<p>Membrana / Bellow <b>1T 323-40</b></p> <p>OEM Code <b>96871</b> <b>75016871</b></p>	
<p><b>CEI no.</b> <b>260.065</b></p> <p>O.E.M. Ref 128147109 1006559</p>	 <p><i>Models</i> <b>VIBERTI - ZORZI</b></p>	<p>Membrana / Bellow <b>1T 323-40</b></p> <p>OEM Code <b>96864</b> <b>75016864</b></p>	

CEI no.  
**260.014**

O.E.M. Ref  
91621110  
19141000  
1006508

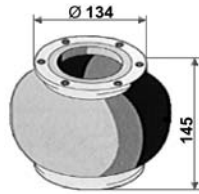

**Models**  
BARTOLETTI - STEFEN - ZORZI

Membrana / Bellow

**110**

OEM Code

**88540**  
**75008540**



CEI no.  
**260.037**

O.E.M. Ref  
577472

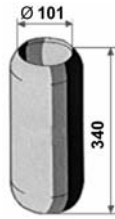

Membrana / Bellow

**1S 215-22**

OEM Code

90609

75010609



**Models**

CARROZZERIA AUTODROMO Bus ALE - TRASFORM. AUTONEGOZIO

CEI no.  
260.057

O.E.M. Ref  
577443

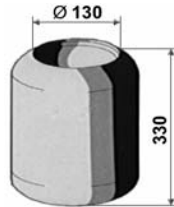

Membrana / Bellow

**1S 285-20**

OEM Code

96534

75016354



**Models**

CARROZZERIA AUTODROMO Bus ALE

All original equipment manufacturer's numbers, symbols, pictures, models and description used in this catalogue are for reference only, and it is not implied that any part listed is the product of these manufactures.  
Tutti i nostri particolari non sono originali ma con essi intercambiabili. I riferimenti originali, le figure, i modelli sono esposti a semplice titolo indicativo. La nostra produzione riporta il nostro marchio.



# O.E.M. References

O.E.M. no.	CEI no.	Pag.	O.E.M. no.	CEI no.	Pag.	O.E.M. no.	CEI no.	Pag.
<i>Adattabile a / Suitable to :</i>			<i>Adattabile a / Suitable to :</i>					
<b>ASTRA</b>			<b>CF GOMMA</b>					
42005	226.033	188	86984	<b>260.006</b>	283	96534	260.057	282
100862	<b>226.010</b>	188	87096	<b>260.008</b>	284	96534	260.057	301
100864		188	87408	<b>260.011</b>	288	96541	<b>260.059</b>	283
101347	See	113251	87408	<b>260.011</b>	291	96692	<b>260.063</b>	294
101348	See	113252	87408	<b>260.011</b>	294	96825	<b>260.064</b>	282
101694	See	113254	87408	<b>260.011</b>	298	96864	<b>260.065</b>	299
101695	See	113253	88540	<b>260.014</b>	300	96871	<b>260.066</b>	299
113251	<b>221.007</b>	112	88544	<b>260.015</b>	281	96873	<b>260.067</b>	297
113252	<b>221.008</b>	112	88709	<b>260.017</b>	282	96885	<b>260.069</b>	299
113253	<b>198.524</b>	112	88786	<b>260.018</b>	278	96898	<b>260.070</b>	283
113254	<b>198.525</b>	112	88786	<b>260.018</b>	285	96987	<b>260.072</b>	279
116740	See	113254	88786	<b>260.018</b>	287	97042	<b>260.075</b>	286
120239	See	113254	88786	<b>260.018</b>	293	97042	<b>260.075</b>	290
<i>Adattabile a / Suitable to :</i>			88800	<b>260.020</b>	282	97043	<b>260.076</b>	290
<b>BREDABUS</b>			88802	<b>260.021</b>	287	97300	260.080	281
000977		113	88802	<b>260.021</b>	290	97326	<b>260.084</b>	286
000978		113	88802	<b>260.021</b>	293	97390	<b>260.085</b>	278
000979		113	88809	<b>260.023</b>	285	97555	<b>260.087</b>	286
000980		113	88811	<b>260.024</b>	285	97555	<b>260.087</b>	287
001800	<b>260.024</b>	285	88817	<b>260.025</b>	278	97608	<b>260.089</b>	277
004204	See	5004204	89405	<b>260.027</b>	286	97608	<b>260.089</b>	290
178623	<b>260.018</b>	285	89406	<b>260.028</b>	286	97613	<b>260.091</b>	279
178741	<b>260.087</b>	286	89413	<b>260.030</b>	281	97764	<b>260.096</b>	292
189716	<b>198.525</b>	113	89457	<b>260.033</b>	281	97764	<b>260.096</b>	298
189717	See	5004204	89756	<b>260.035</b>	278	200751	<b>260.099</b>	294
192709	<b>260.037</b>	285	91016	<b>260.038</b>	283	200751	<b>260.099</b>	299
199196	<b>260.044</b>	286	91016	<b>260.038</b>	288	201715	<b>260.103</b>	299
252933	<b>260.084</b>	286	91016	<b>260.038</b>	293	201727	<b>260.104</b>	279
4840001	See	001800	92154	<b>260.040</b>	281	201732	<b>260.105</b>	276
4840005	See	5001043	92154	<b>260.040</b>	289	201840	260.106	294
5001043	260.028	286	92477	<b>260.041</b>	278	202189	<b>260.108</b>	276
5001051	<b>260.023</b>	285	92527	<b>260.042</b>	289	202265	<b>260.109</b>	290
5001098	See	178623	92574	<b>260.044</b>	286	203833	<b>260.122</b>	279
5001964	<b>260.027</b>	286	92574	<b>260.044</b>	287	204427	<b>260.134</b>	283
5004204	<b>198.524</b>	113	92574	<b>260.044</b>	288	204466	<b>260.138</b>	295
D020990	<b>260.113</b>	285	92574	<b>260.044</b>	293	204530	<b>260.141</b>	295
D031105	<b>260.075</b>	286	92594	<b>260.047</b>	283	204772	<b>260.147</b>	285
D042807	<b>260.147</b>	285	92594	<b>260.047</b>	290	205074	<b>260.171</b>	278
			92594	<b>260.047</b>	291	205170	<b>260.150</b>	295
			93740	260.052	296	205536	<b>260.183</b>	295
			93774	<b>260.054</b>	299	205598	<b>260.156</b>	297
						206201	<b>260.159</b>	292
						206340	<b>260.146</b>	298

Date

2010 / 2011

Table

Index

References **O.E.M.**

O.E.M. no.	CEI no.	Pag.	O.E.M. no.	CEI no.	Pag.	O.E.M. no.	CEI no.	Pag.
206356	<b>260.158</b>	295	0607053	See	696225	1205248	<b>221.030</b>	116
206357	<b>260.160</b>	295	607073	See	1326861	1228110	See	1326861
206730	<b>260.037</b>	276	607451	<b>198.477</b>	114	1228114	See	607451
206730	<b>260.037</b>	282	607452	<b>198.478</b>	114	1228115	See	696225
206730	<b>260.037</b>	285	607453	See	607451	1229944	See	1331925
206730	<b>260.037</b>	301	607981	See	1257890	1257890	<b>198.525</b>	114
206733	<b>260.093</b>	276	607998	<b>198.629</b>	114	1261101	225.079	191
206745	<b>260.113</b>	282	607999	See	1331925	1271124	<b>198.612</b>	191
206745	<b>260.113</b>	285	609634	See	1326861	1283211	See	1351714
206750	<b>260.053</b>	299	609643	See	1326861	1283212	See	1351715
206778	<b>260.182</b>	293	646373	See	1620438	1284860	See	1620438
206779	<b>260.181</b>	291	649819	See	1620437	1286343	See	1353396
206785	260.176	287	655695	See	1620438	1291048	See	1351735
206789	<b>260.162</b>	276	655697	See	1620438	1291060	See	1351734
206790	<b>260.163</b>	276	658102	225.140	191	1294251	225.173	193
206791	<b>260.164</b>	277	658103	225.083	193	1315447	See	607998
206792	<b>260.165</b>	277	658104	225.084	193	1319838	See	607998
206793	<b>260.166</b>	277	681511	230.021	149	1326861	221.019	115
206794	<b>260.167</b>	277	681706	<b>230.022</b>	149	1326896	See	1331925
206795	<b>260.168</b>	277	683470	<b>230.061</b>	150	1331925	<b>198.630</b>	114
206796	<b>260.170</b>	280	683499	<b>230.060</b>	149	1338714	See	607998
87413/1	<b>260.153</b>	293	689747	226.013	191	1351714	<b>220.077</b>	24
87413/1	<b>260.153</b>	297	0689747	See	689747	1351715	<b>220.078</b>	24
			689748	226.087	191	1351716	<b>220.284</b>	25
			689748	226.087	193	1351734	<b>220.150</b>	26
			689749	<b>226.018</b>	193	1351735	<b>220.193</b>	26
			691704	<b>198.639</b>	189	1353396	<b>220.205</b>	26
			691709	<b>198.411</b>	192	1361649	See	1656428
			693778	<b>198.642</b>	191	1361650	See	1656428
			694298	See	1331925	1361651	See	1793875
			694360	See	1331925	1361652	See	1620436
			696205	See	696225	1368270	See	1793875
			696225	<b>198.524</b>	114	1373135	See	607451
			0696225	See	696225	1373137	See	607452
			696226	See	1326861	1376728	<b>226.088</b>	192
			696320	<b>198.440</b>	190	1376729	<b>226.086</b>	189
			696321	<b>198.442</b>	190	1385492	See	1351715
			698450	See	1257890	1385497	See	1351714
			698609	See	1331925	1385499	See	1351734
			698724	<b>226.070</b>	189	1385500	See	1351735
			698724	<b>226.070</b>	190	1389190	221.084	115
			1149907	See	1257890	1390932	See	1793875
			1205215	<b>221.029</b>	116	1401934	See	1407394

Adattabile a / Suitable to :

**DAF**

67303	<b>221.005</b>	116
67389	<b>221.006</b>	116
80521	225.069	189
94038	<b>220.001</b>	25
110196	See	607452
110197	See	607451
267743	225.080	192
276875	See	80521
311300	See	607998
0362413	See	1426101
513757	See	691709
554765	See	94038
586714	See	1326861
586753	See	1331925
606922	<b>221.017</b>	116
606923	<b>221.018</b>	116
607053	See	696225

All original equipment manufacturers' numbers, symbols, pictures, models and description used in this catalogue are for reference only, and it is not implied that any part listed is the product of these manufacturers. Tutti i nostri particolari non sono originali ma con essi intercambiabili. I riferimenti originali, le figure, i modelli sono esposti a semplice titolo indicativo. La nostra produzione riporta il nostro marchio.

# O.E.M. References

O.E.M. no.	CEI no.	Pag.	O.E.M. no.	CEI no.	Pag.	O.E.M. no.	CEI no.	Pag.
1401942	221.082	115	2968584	See	4802444	4663791	<b>198.497</b>	103
1405309	220.213	24	2969507	See	4833826	4663972	<b>198.480</b>	103
1407394	221.083	115	2969808	See	4802443	4663974	<b>198.481</b>	103
1426101	<b>220.214</b>	26	2980129	See	2493782	4664292	198.498	106
1445656	<b>226.056</b>	189	2980323	See	2493781	4664295	<b>198.499</b>	106
1448064	<b>220.283</b>	25	2980883	See	2980884	4664343	198.488	110
1458874	<b>221.087</b>	115	2980884	<b>198.612</b>	174	4664345	<b>198.605</b>	110
1602820	<b>220.281</b>	24	2980884	<b>198.612</b>	179	4664347	<b>198.489</b>	109
1602821	<b>220.282</b>	25	2984061	See	4833826	4664349	198.490	109
1603789	See	1257890	2984511	See	4833828	4664351	See	4732042
1618048	See	1257890	2992185	See	1904698	4664353	See	4732041
1620436	See	1793876	2995709	<b>230.058</b>	147	4664462	198.491	108
1620437	See	1793877	2995710	<b>230.059</b>	147	4664586	198.650	106
1620438	225.082	192	3435788	See	2042912	4665005	<b>198.479</b>	110
1638472	221.088	115	4018036	See	4663787	4665007	198.604	110
1656428	<b>225.081</b>	192	4018037	See	4663791	4665009	198.482	108
1793875	<b>225.137</b>	189	4028250	See	4663972	4665209	198.501	4
1793876	<b>225.139</b>	190	4336779	<b>221.002</b>	107	4665501	198.502	7
1793877	<b>225.138</b>	190	4388159	221.003	107	4666954	See	4732546
ACHF241	See	607998	4456111	See	4746728	4666991	See	4733704
ACHF242	See	1331925	4510017	See	4664349	4666993	See	4733752
ACU9242	See	607451	4510018	See	4664347	4666993	See	4733752
			4510019	See	4664292	4667156	See	4732549
			4514235	See	4732041	4668368	198.487	111
			4514236	See	4732042	4669091	198.507	6
			4520694	See	4669091	4669091	198.507	8
			4520697	See	4664586	4669094	198.508	7
			4520698	See	4669094	4669094	198.508	8
			4523292	See	4664295	4670853	<b>189.324</b>	178
			4536229	See	4668368	4688941	<b>198.602</b>	104
			4544893	See	4664343	4688942	<b>198.603</b>	104
			4545422	<b>198.543</b>	8	4688944	<b>198.553</b>	110
			4546822	See	4573092	4688946	198.554	109
			4562450	See	4664345	4688948	<b>198.485</b>	106
			4573092	198.521	7	4688949	<b>198.486</b>	106
			4579231	<b>198.494</b>	102	4688952	198.520	110
			4579232	<b>198.495</b>	102	4688953	198.519	109
			4582159	See	4664462	4699246	198.505	6
			4624032	See	4732546	4699305	198.506	6
			4626261	See	4670853	4714019	<b>260.025</b>	278
			4639392	See	0343453	4714025	<b>260.018</b>	278
			4646452	See	4665501	4714134	<b>198.572</b>	179
			4663787	<b>198.496</b>	103	4715615	220.011	11

Adattabile a / Suitable to :

**IVECO**

814304	198.551	102
814305	198.552	102
1903652	<b>198.472</b>	107
1904696	<b>230.015</b>	146
1904697	<b>230.016</b>	146
1904698	<b>230.020</b>	148
2460515	<b>198.637</b>	108
2463582	<b>198.636</b>	108
2966252	See	4802443
2966272	See	2493782
2966319	See	4833825
2966321	See	4833825
2966396	See	8558524
2966635	See	4833825
2966688	See	4833827
2966891	See	2493781
2968454	<b>198.639</b>	174

Date

2010 / 2011

Table

Index

References **O.E.M.**

O.E.M. no.	CEI no.	Pag.	O.E.M. no.	CEI no.	Pag.	O.E.M. no.	CEI no.	Pag.
4716271	<b>198.573</b>	174	7567284	221.004	107	41002119	See	1203864
4716799	<b>198.695</b>	174	7693816	See	4336779	41002770	See	1028598
4722525	See	4714025	7984276	See	8558524	41005463	<b>220.014</b>	16
4732041	198.483	109	8121641	See	4688941	41005463	<b>220.014</b>	17
4732042	198.484	109	8122752	See	4802443	41005475	<b>220.139</b>	16
4732546	198.510	9	8122754	See	2493781	41006093	See	1005475
4732549	198.511	9	8122755	See	2493782	41006926	<b>260.104</b>	279
4733704	198.504	6	8123326	See	4688942	41008929	<b>260.105</b>	276
4733704	198.504	8	8123394	See	4833826	41009661	See	8472466
4733752	198.503	5	8132397	See	1005463	41009665	See	1028598
4733752	198.503	7	8137026	See	1028598	41011006	<b>225.012</b>	178
4735768	See	4714025	8137027	See	8472466	41011006	<b>225.012</b>	181
4736728	See	4714025	8137291	<b>260.091</b>	279	41019149	See	1019150
4746728	<b>260.035</b>	278	8139068	<b>260.041</b>	278	41019150	<b>260.162</b>	276
4746740	See	4746728	8166340	<b>260.085</b>	278	41022620	<b>260.122</b>	279
4747960	See	4747961	8188526	<b>260.093</b>	276	41026256	<b>260.163</b>	276
4747961	<b>220.047</b>	11	8188539	<b>260.089</b>	277	41026257	<b>260.164</b>	277
4747961	<b>198.509</b>	12	8190225	See	4802444	41026260	<b>260.170</b>	280
4747961	<b>220.047</b>	12	8193645	See	4833825	41026270	<b>260.167</b>	277
4747961	<b>198.509</b>	13	8193646	See	4833826	41026271	<b>260.168</b>	277
4747961	See	2087842	8193649	<b>221.021</b>	103	41026285	<b>260.165</b>	277
4758192	See	4746728	8194818	<b>260.033</b>	281	41026286	<b>260.166</b>	277
4773359	See	4834037	8558220	<b>198.522</b>	135	41028598	See	1042050
4793166	<b>220.005</b>	11	8558522	<b>198.500</b>	4	41028599	See	1042092
4802443	<b>198.525</b>	105	8558524	<b>198.476</b>	102	41028599	See	4064007
4802444	<b>198.524</b>	105	8558527	<b>198.475</b>	102	41028600	See	1034479
4815933	<b>198.632</b>	10	8558533	See	4833825	41033731	225.065	177
4822407	See	4802444	8558536	See	4833826	41034330	See	0340452
4833820	See	4833827	8559559	<b>198.595</b>	4	41034479	225.027	176
4833821	See	4833828	8567618	198.593	9	41035951	See	8472466
4833822	See	4802443	8570528	<b>198.590</b>	9	41042050	<b>225.001</b>	175
4833825	<b>198.477</b>	104	8580735	See	0337201	41042092	<b>225.050</b>	175
4833826	<b>198.478</b>	104	8582322	See	4833825	41042093	<b>225.192</b>	177
4833827	<b>198.598</b>	105	8582332	See	4688941	41203863	221.039	135
4833828	<b>198.599</b>	105	8582333	See	4688942	41203864	221.040	135
4833829	See	4802443	8582350	See	8567618	41214462	See	8472466
4833830	See	4802444	8590435	<b>198.589</b>	10	41215165	<b>220.208</b>	17
4834037	<b>198.587</b>	10	8590443	See	8591219	41218020	225.166	181
4834039	See	4815933	8591219	<b>198.591</b>	10	41218021	225.165	181
4834041	See	4793166	8591222	See	8558522	41226580	See	1215165
4854871	220.290	17	9009501	See	4579231	41270462	<b>260.192</b>	279
4854874	<b>198.634</b>	14	9009503	See	4579232	41270463	<b>260.193</b>	279
7167757	See	4688941	41002118	See	1203863	41270465	<b>260.195</b>	280

All original equipment manufacturers' numbers, symbols, pictures, models and description used in this catalogue are for reference only, and it is implied that any part listed is the product of these manufacturers. Tutti i nostri particolari non sono originali ma con essi intercambiabili. I riferimenti originali, le figure, i modelli sono esposti a semplice titolo indicativo. La nostra produzione riporta il nostro marchio.

# O.E.M. References

O.E.M. no.	CEI no.	Pag.	O.E.M. no.	CEI no.	Pag.	O.E.M. no.	CEI no.	Pag.
41270466	<b>260.194</b>	280	42489594	See	4802443	93192619	See	2493431
41272429	See	8472466	42491638	See	4802443	93193663	See	3161959
42001325	See	2001326	42491937	<b>221.022</b>	103	93194576	See	4802443
42001326	<b>198.512</b>	12	42491957	See	2489395	93194626	See	8558527
42041107	225.070	178	42493431	<b>226.025</b>	178	93194627	See	8558524
42041107	225.070	180	42493431	<b>226.025</b>	181	93800662	See	1903652
42041327	See	1203863	42493781	<b>198.630</b>	104	93802209	See	0310933
42041328	See	1203864	42493782	<b>198.629</b>	104	93802242	See	3807545
42041835	See	2042950	42534911	<b>221.074</b>	107	93804059	See	1903652
42042912	221.041	135	42535269	190.418	176	93804060	See	0310933
42042950	<b>198.513</b>	12	42535781	<b>226.004</b>	175	93804061	See	3807545
42043912	See	2042950	42535781	<b>226.004</b>	177	93807320	See	3807545
42065332	See	1011006	42554430	See	1008929	93807545	<b>198.474</b>	108
42065332	See	1011006	42555565	See	8139068	93827647	See	2534911
42079852	See	1203864	60115495	See	2463582	98402544	<b>220.183</b>	13
42079853	See	1203863	61590823	See	1595960	98411807	<b>260.072</b>	279
42086458	See	2001326	61590824	See	1595960	98445471	See	3166129
42087841	See	2087842	61590910	198.588	5	98446354	<b>220.013</b>	15
42087842	<b>198.585</b>	11	61591070	See	1595957	98449025	See	8469650
42087842	<b>198.585</b>	13	61591073	See	1595957	98460983	<b>260.015</b>	281
42087842	See	4747961	61595957	<b>198.526</b>	4	98467459	<b>198.633</b>	13
42107588	<b>260.040</b>	281	61595960	<b>198.586</b>	5	98469650	<b>220.138</b>	15
42107595	<b>260.030</b>	281	93161371	<b>198.640</b>	179	98472466	<b>225.002</b>	180
42112249	See	2042912	93161631	See	3161958	98472468	See	1028599
42125057	<b>198.641</b>	179	93161632	See	3161958	98473328	220.136	14
42126126	260.080	281	93161637	See	3192361	98475709	<b>220.135</b>	14
42261056	See	4714025	93161638	See	3162240	98493054	220.137	15
42470862	<b>230.056</b>	146	93161720	226.080	181	500301776	<b>260.108</b>	276
42470863	<b>230.057</b>	147	93161958	See	2535781	500309296	<b>221.055</b>	106
42471013	<b>230.066</b>	148	93161959	<b>190.276</b>	175	500310933	<b>198.473</b>	107
42471014	<b>230.067</b>	148	93161960	<b>226.022</b>	175	500324282	<b>220.280</b>	14
42480023	See	8193649	93161960	<b>226.022</b>	176	500337201	<b>221.020</b>	108
42480024	See	2491937	93161960	<b>226.022</b>	177	500340451	See	1042093
42483386	<b>198.492</b>	105	93162239	226.049	176	500340452	225.178	180
42483520	See	2493781	93162240	See	3162239	500340769	221.056	111
42484886	See	4833825	93162288	226.099	181	500343453	<b>139.428</b>	272
42484887	See	4833826	93163828	See	4802443	500364663	<b>260.171</b>	278
42485718	See	4833827	93166129	<b>260.037</b>	276	500397738	<b>220.140</b>	16
42487165	See	8558527	93190752	See	4802443	500397738	<b>220.140</b>	17
42488269	See	2483386	93192361	<b>226.006</b>	177	504049893	<b>220.209</b>	15
42489395	<b>198.493</b>	105	93192361	<b>226.006</b>	180	5001836092	See	3192361
42489573	See	4802443	93192618	<b>226.011</b>	178	9750079980	See	4336779
42489574	See	4802444	93192618	<b>226.011</b>	180	V8188526	See	8188526

Date

2010 / 2011

Table

Index

References **O.E.M.**

O.E.M. no.	CEI no.	Pag.	O.E.M. no.	CEI no.	Pag.	O.E.M. no.	CEI no.	Pag.
<i>Adattabile a / Suitable to :</i>			4808424	225.076	186	98402544	<b>220.183</b>	21
<b>IVECO BUS</b>			4808425	See	4808424	98420110	220.142	20
2969844	See	42488722	4820894	225.133	182	98420112	See	98420110
2980883	See	2980884	4822291	See	4838587	98445471	See	93166129
2980884	<b>198.612</b>	182	4826513	220.145	22	98467174	See	500343812
2980884	<b>198.612</b>	183	4827082	See	4826513	98487790	225.136	183
4212432	See	4843255	4834037	<b>198.587</b>	18	98488010	225.014	187
4520694	See	4669091	4834041	See	4793166	99432563	See	99484068
4520698	See	4669094	4838587	220.144	22	99455009	See	500336085
4546822	See	4573092	4843220	260.057	282	99484068	225.134	182
4646452	See	4665501	4843255	<b>260.059</b>	283	500308895	See	500336085
4650232	<b>260.008</b>	284	4847671	See	4843255	500311471	220.143	21
4659860	220.002	19	4862449	See	4826513	500324098	<b>260.134</b>	283
4666991	See	4733704	4862451	See	4826513	500328489	225.077	187
4666993	See	4733752	4862493	225.078	187	500336085	220.141	20
4672795	220.023	20	4865483	<b>225.135</b>	183	500343452	226.084	186
4680913	<b>260.006</b>	283	8558522	<b>198.500</b>	18	500343454	139.429	185
4703852	See	4703853	8559559	<b>198.595</b>	18	500343454	139.429	186
4703853	225.072	185	8567618	198.593	18	500343812	226.038	187
4703856	See	500343454	8582350	See	8567618	500359179	220.211	21
4703857	See	4703858	8591222	See	8558522	5000814841	See	42535445
4703858	225.073	185	9007195	See	4680913	5001842823	See	42488722
4703861	See	4759025	41822247	See	93197594	8010000415	See	42542824
4703862	See	4759025	42044493	220.016	20	<i>Adattabile a / Suitable to :</i>		
4703904	<b>260.020</b>	282	42124323	See	4843255	<b>KASS-SETRA</b>		
4703972	<b>260.017</b>	282	42488722	<b>226.018</b>	183	4711440000	<b>260.038</b>	288
4704183	<b>220.206</b>	22	42488722	<b>226.018</b>	187	4731007000	<b>260.042</b>	289
4711073	225.075	186	42530929	226.082	182	4731012000	See	4711440000
4711108	<b>198.566</b>	19	42531994	<b>260.113</b>	282	4731018000	<b>260.040</b>	289
4711109	See	4711108	42535445	226.085	187	4731030000	<b>260.011</b>	288
4738069	<b>198.675</b>	184	42536242	<b>260.047</b>	283	4731031000	See	4711440000
4738784	See	4703972	42542824	220.210	21	4731033000	See	4731030000
4741956	See	4741957	61590823	See	61595960	4771143000	See	4771441000
4741957	220.004	19	61590824	See	61595960	4771170000	See	4771441000
4746348	139.430	185	61591070	See	61595957	4771347000		218
4759023	See	4703853	61591073	See	61595957	4771359000	See	4771441000
4759025	225.071	185	93166129	<b>260.037</b>	282	4771427000	See	4711440000
4759027	See	4703858	93194456	226.081	182	4771441000	<b>260.044</b>	288
4763694	See	4703972	93194457	226.100	182	6851446000	221.093	121
4773359	See	4834037	93194458	<b>226.083</b>	183	6851447000	See	6851533000
4793166	<b>220.005</b>	19	93195789	<b>260.070</b>	283	6851459000	See	6851446000
4804714	225.074	186	93195986	<b>260.064</b>	282	6851475000	See	6851484000
4804716	See	4804714	93197594	<b>260.038</b>	283			

All original equipment manufacturers' numbers, symbols, pictures, models and description used in this catalogue are for reference only, and it is not implied that any part listed is the product of these manufacturers. Tutti i nostri particolari non sono originali ma con essi intercambiabili. I riferimenti originali, le figure, i modelli sono esposti a semplice titolo indicativo. La nostra produzione riporta il nostro marchio.



# O.E.M. References

O.E.M. no.	CEI no.	Pag.	O.E.M. no.	CEI no.	Pag.	O.E.M. no.	CEI no.	Pag.
6851476000	See	6851485000	1139601	<b>198.252</b>	--	1292301	<b>220.037</b>	--
6851478000	See	6851533000	1139801	<b>198.642</b>	--	1292501	<b>220.172</b>	--
6851479000	See	6851446000	1140201	<b>198.630</b>	--	1292801	225.059	--
6851480000	See	6851484000	1140302	<b>198.629</b>	--	1293501	<b>220.038</b>	--
6851481000	See	6851485000	1140801	<b>221.013</b>	--	1293601	<b>220.019</b>	--
6851484000	<b>198.525</b>	121	1141001	<b>220.027</b>	--	1354401	<b>226.036</b>	--
6851485000	<b>198.524</b>	121	1141102	<b>220.028</b>	--	1355001	220.154	--
6851487000	See	6851446000	1142301	<b>198.261</b>	--	1357101	225.009	--
6851516000	<b>198.629</b>	121	1143501	<b>198.536</b>	--	1357301	225.142	--
6851517000	<b>198.630</b>	121	1143801	220.152	--	1477301	221.003	--
6851521001	<b>221.045</b>	122	1143901	<b>220.050</b>	--	1482401	<b>220.079</b>	--
6851522000	See	6851528000	1144001	225.007	--	1685901	221.042	--
6851528000	<b>221.046</b>	122	1145701	<b>220.117</b>	--	1726501	225.089	--
6851531000	See	6851484000	1146502	<b>198.648</b>	--	1780201	<b>220.127</b>	--
6851532000	See	6851446000	1147501	<b>220.032</b>	--	1803901	220.095	--
6851533000	189.287	121	1147701	<b>220.006</b>	--	1842701	220.155	--
6861486000	See	6851533000	1149203	<b>198.524</b>	--	1844701	220.216	--
8226232000	See	8226357000	1150502	<b>198.525</b>	--	1846802	<b>220.098</b>	--
8226232066	See	82262320660	1159101	221.004	--	1847201	<b>226.022</b>	--
8226236058	See	6851485000	1160302	<b>221.002</b>	--	1847501	<b>220.204</b>	--
8226236059	See	6851484000	1160501	<b>220.001</b>	--	1887503	221.035	--
8226241000	See	8226357000	1160601	<b>225.138</b>	--	1891901	<b>220.233</b>	--
8226357000	225.111	218	1160701	<b>221.005</b>	--	1897701	<b>198.634</b>	--
82262320660	<b>226.018</b>	218	1160801	<b>221.006</b>	--	1897801	<b>198.590</b>	--
			1161001	<b>221.017</b>	--	1899002	<b>220.112</b>	--
			1161101	<b>221.018</b>	--	1899101	<b>220.063</b>	--
			1163702	<b>198.472</b>	--	1933001	<b>198.500</b>	--
			1163802	<b>198.473</b>	--	1933901	<b>198.633</b>	--
			1163901	<b>198.474</b>	--	1939001	<b>220.018</b>	--
			1171301	<b>198.612</b>	--	1951401	220.270	--
			1171401	<b>198.587</b>	--	1952101	<b>220.029</b>	--
			1171501	<b>225.001</b>	--	1952501	<b>220.175</b>	--
			1171601	<b>198.512</b>	--	1953901	<b>220.080</b>	--
			1171701	<b>198.513</b>	--	1954002	198.733	--
			1171801	220.016	--	1955501	221.019	--
			1172001	<b>198.585</b>	--	1958401	<b>220.284</b>	--
			1172101	<b>198.602</b>	--	1958501	<b>220.077</b>	--
			1172301	<b>198.486</b>	--	1960701	<b>220.207</b>	--
			1172401	<b>198.566</b>	--	1961301	221.093	--
			1172501	220.004	--	1961901	220.011	--
			1172701	<b>198.598</b>	--	1962101	<b>220.014</b>	--
			1172801	<b>198.599</b>	--	1963001	<b>198.695</b>	--
			1173101	<b>226.006</b>	--	1964501	<b>198.597</b>	--

Adattabile a / Suitable to :  
**LEMFORDER**

Date

2010 / 2011

Table

Index

References **O.E.M.**

O.E.M. no.	CEI no.	Pag.	O.E.M. no.	CEI no.	Pag.	O.E.M. no.	CEI no.	Pag.
1173201	<b>225.002</b>	--	1964701	<b>220.012</b>	--	2088201	<b>198.377</b>	--
1173601	<b>198.675</b>	--	1964801	<b>221.049</b>	--	2089001	<b>220.203</b>	--
1173701	<b>198.573</b>	--	1966301	<b>220.034</b>	--	2089201	<b>220.040</b>	--
1173801	<b>198.641</b>	--	1967501	221.095	--	2091201	<b>221.033</b>	--
1175501	<b>226.018</b>	--	1968101	<b>221.027</b>	--	2099101	<b>220.156</b>	--
1176001	<b>198.561</b>	--	1968201	<b>221.028</b>	--	2100901	<b>220.066</b>	--
1176601	<b>220.007</b>	--	1969901	<b>220.119</b>	--	2101301	225.144	--
1176801	<b>220.009</b>	--	1971501	225.091	--	2104801	225.113	--
1176901	<b>220.039</b>	--	1975101	<b>220.024</b>	--	2116801	<b>225.040</b>	--
1177001	<b>220.287</b>	--	1975301	<b>220.025</b>	--	2128001	<b>220.005</b>	--
1182001	220.174	--	1977701	225.069	--	2128101	220.010	--
1183201	<b>198.639</b>	--	1978401	<b>226.070</b>	--	2129601	221.059	--
1192601	<b>220.021</b>	--	1979101	<b>220.078</b>	--	2129701	221.060	--
1192701	<b>198.690</b>	--	1982001	<b>198.637</b>	--	2135301	225.071	--
1192801	<b>198.596</b>	--	1982101	<b>198.603</b>	--	2140801	<b>220.232</b>	--
1192901	198.658	--	1985701	<b>220.068</b>	--	2141001	<b>220.087</b>	--
1193101	<b>221.047</b>	--	1986101	<b>221.048</b>	--	2141101	<b>220.088</b>	--
1193201	<b>198.680</b>	--	1987301	<b>220.056</b>	--	2141202	<b>220.084</b>	--
1194101	<b>220.062</b>	--	1988001	198.631	--	2144001	<b>221.075</b>	--
1194201	<b>220.003</b>	--	1988401	<b>220.048</b>	--	2155101	226.130	--
1194401	<b>198.626</b>	--	1988801	<b>221.073</b>	--	2170001	<b>226.004</b>	--
1194501	<b>221.001</b>	--	1988901	<b>220.057</b>	--	2180501	<b>220.205</b>	--
1194602	<b>198.624</b>	--	1989501	<b>198.387</b>	--	2203401	220.142	--
1194702	<b>198.625</b>	--	1990401	<b>220.059</b>	--	2205101	<b>226.066</b>	--
1194901	<b>220.202</b>	--	1994701	<b>220.043</b>	--	2205201	<b>226.054</b>	--
1196301	220.055	--	1997101	226.081	--	2208301	<b>220.067</b>	--
1196501	<b>198.691</b>	--	1998901	<b>220.013</b>	--	2209001	226.074	--
1196701	<b>221.015</b>	--	1999101	225.070	--	2223201	<b>198.632</b>	--
1196801	<b>221.016</b>	--	1999501	<b>220.044</b>	--	2225801	220.274	--
1196902	<b>198.623</b>	--	2039601	<b>220.286</b>	--	2229602	<b>220.150</b>	--
1209901	220.061	--	2041201	225.073	--	2230201	225.134	--
1214702	<b>220.058</b>	--	2041502	221.041	--	2230301	226.082	--
1228003	<b>221.045</b>	--	2042301	<b>220.138</b>	--	2231601	225.082	--
1229801	<b>198.653</b>	--	2043001	220.125	--	2231702	<b>225.081</b>	--
1229901	<b>220.008</b>	--	2049701	<b>220.133</b>	--	2252201	<b>225.012</b>	--
1283001	226.129	--	2050001	225.079	--	2252301	225.074	--
1285801	225.150	--	2051401	<b>220.134</b>	--	2252901	225.115	--
1285901	225.151	--	2051601	226.098	--	2254701	<b>198.622</b>	--
1286701	225.088	--	2051701	<b>220.026</b>	--	2266901	225.080	--
1286801	225.090	--	2058601	<b>221.051</b>	--	2270501	<b>225.137</b>	--
1288101	<b>220.030</b>	--	2058701	<b>221.052</b>	--	2279101	<b>220.076</b>	--
1290501	<b>220.031</b>	--	2065701	225.143	--	2279301	<b>220.169</b>	--
1291301	220.151	--	2088101	<b>198.533</b>	--	2280601	<b>221.055</b>	--

All original equipment manufacturers numbers, symbols, pictures, models and description used in this catalogue are for reference only, and it is not implied that any part listed is the product of these manufactures.  
Tutti i nostri particolari non sono originali ma con essi intercambiabili. I riferimenti originali, le figure, i modelli sono esposti a semplice titolo indicativo. La nostra produzione riporta il nostro marchio.

# O.E.M. References

O.E.M. no.	CEI no.	Pag.	O.E.M. no.	CEI no.	Pag.	O.E.M. no.	CEI no.	Pag.
2280701	<b>220.090</b>	--	2383501	<b>226.083</b>	--	2572101	<b>220.181</b>	--
2281401	220.143	--	2383601	<b>226.056</b>	--	2582101	<b>220.131</b>	--
2281701	<b>221.074</b>	--	2383901	226.089	--	2602301	220.218	--
2290401	225.173	--	2384101	226.090	--	2602601	220.219	--
2290501	225.083	--	2397701	<b>220.182</b>	--	2602801	<b>226.001</b>	--
2291501	225.084	--	2398401	<b>220.042</b>	--	2603101	<b>225.058</b>	--
2292501	225.072	--	2398802	<b>220.086</b>	--	2605801	<b>225.167</b>	--
2294101	<b>225.035</b>	--	2398901	<b>220.089</b>	--	2665401	<b>220.208</b>	--
2297601	225.101	--	2399201	<b>220.164</b>	--	2683001	<b>220.214</b>	--
2297701	225.102	--	2406101	<b>198.595</b>	--	2684101	<b>220.282</b>	--
2298601	225.093	--	2423101	220.217	--	2737402	220.022	--
2298701	225.092	--	2423701	<b>220.220</b>	--	2744302	<b>220.102</b>	--
2304201	225.140	--	2423901	<b>220.177</b>	--	2744402	220.162	--
2304901	<b>225.050</b>	--	2424101	<b>220.178</b>	--	2745602	<b>220.288</b>	--
2305101	<b>225.135</b>	--	2424301	<b>220.082</b>	--	2747702	220.265	--
2305201	225.136	--	2424401	<b>220.083</b>	--	2754702	221.071	--
2306501	225.148	--	2427602	<b>220.035</b>	--	2757902	225.187	--
2306601	225.149	--	2430301	220.221	--	2760101	225.176	--
2306902	<b>225.060</b>	--	2435401	220.060	--	2762201	<b>226.086</b>	--
2307001	225.141	--	2438001	<b>220.230</b>	--	2762301	<b>221.058</b>	--
2307701	<b>221.034</b>	--	2459001	<b>220.065</b>	--	2762801	220.225	--
2309401	<b>198.636</b>	--	2459101	<b>220.103</b>	--	2764701	<b>220.168</b>	--
2320601	226.085	--	2459201	<b>220.064</b>	--	2765601	<b>220.140</b>	--
2333401	<b>220.193</b>	--	2480701	226.115	--	2767201	<b>220.280</b>	--
2336101	<b>198.591</b>	--	2481302	<b>198.619</b>	--	2767701	220.257	--
2336401	198.593	--	2491101	<b>220.215</b>	--	2771601	<b>220.166</b>	--
2337201	<b>220.139</b>	--	2504301	<b>225.139</b>	--	2771801	<b>226.088</b>	--
2340501	<b>220.228</b>	--	2505101	<b>226.072</b>	--	2795301	<b>220.159</b>	--
2340701	<b>220.241</b>	--	2508801	225.178	--	2795401	<b>220.226</b>	--
2341701	<b>220.238</b>	--	2508901	225.065	--	2809101	220.276	--
2341801	<b>220.242</b>	--	2510001	<b>220.234</b>	--	2870501	<b>226.068</b>	--
2346402	220.237	--	2514001	<b>220.206</b>	--	2870601	<b>226.067</b>	--
2346501	220.229	--	2514801	225.076	--	2876001	<b>226.117</b>	--
2346601	<b>220.285</b>	--	2515401	<b>220.179</b>	--	2896901	225.184	--
2346901	<b>220.085</b>	--	2515801	<b>226.073</b>	--	2938701	225.179	--
2347001	<b>220.227</b>	--	2520902	<b>225.118</b>	--	2943201	<b>220.158</b>	--
2347601	<b>220.081</b>	--	2527201	<b>220.236</b>	--	2943301	<b>220.092</b>	--
2348201	220.272	--	2529301	<b>226.069</b>	--	2943801	<b>220.110</b>	--
2348701	220.264	--	2531401	<b>225.147</b>	--	2944301	<b>220.160</b>	--
2349501	<b>220.176</b>	--	2536101	220.223	--	2944701	220.252	--
2355301	220.170	--	2539501	<b>220.197</b>	--	2945201	<b>220.105</b>	--
2376301	221.084	--	2544701	<b>220.132</b>	--	2945401	<b>220.187</b>	--
2377501	<b>198.485</b>	--	2572001	<b>220.104</b>	--	2950201	<b>220.163</b>	--

Date

2010 / 2011

Table

Index

References **O.E.M.**

O.E.M. no.	CEI no.	Pag.	O.E.M. no.	CEI no.	Pag.	O.E.M. no.	CEI no.	Pag.
2953901	<b>198.385</b>	--	81 43220 6055	<b>226.018</b>	226	81 43220 6236	<b>225.118</b>	230
2954001	<b>198.386</b>	--	81 43220 6055	<b>226.018</b>	228	81 43220 6244	226.106	230
2965201	225.145	--	81 43220 6055	<b>226.018</b>	231	81 43220 6247	<b>225.112</b>	223
2995401	<b>220.186</b>	--	81 43220 6056 See	81 43220 6052		81 43220 6250	226.097	230
3029001	<b>220.281</b>	--	81 43220 6067 See	81 43220 6092		81 43220 6260	225.120	230
3041601	225.174	--	81 43220 6068 See	81 43220 6092		81 43220 6271	225.176	222
3058501	220.251	--	81 43220 6070 See	81 43220 6093		81 43220 6272 See	81 43220 6236	
3059301	<b>220.196</b>	--	81 43220 6071 See	81 43220 6093		81 43220 6282 See	81 43220 6271	
3068601	225.077	--	81 43220 6072 See	81 43220 6093		81 43220 6283 See	81 43220 6260	
3075101	226.127	--	81 43220 6073 See	81 43220 6055		81 43220 6284 See	81 43220 6260	
3077701	225.078	--	81 43220 6073 See	81 43220 6055		81 43220 6285	226.127	222
3090501	<b>221.014</b>	--	81 43220 6073 See	81 43220 6055		81 43220 6314 See	81 43220 6271	
3091101	<b>198.535</b>	--	81 43220 6083 See	81 43220 6106		81 43220 6319	225.177	229
3091201	<b>198.628</b>	--	81 43220 6084 See	81 43220 6106		81 43220 9092 See	81 43220 6092	
3101101	220.141	--	81 43220 6090 See	81 43220 6092		81 43220 9129 See	81 43220 6129	
3114601	<b>221.020</b>	--	81 43220 6091 See	81 43220 6093		81 43220 9129 See	81 43220 6129	
3114901	220.224	--	81 43220 6092	<b>225.033</b>	228	81 43220 9129 See	81 43220 6129	
3115001	<b>220.184</b>	--	81 43220 6093	225.116	229	81 43220 9140 See	81 43220 6140	
3116801	225.183	--	81 43220 6096 See	81 43220 6129		81 43226 6267 See	81 43220 6236	
3131301	220.246	--	81 43220 6096 See	81 43220 6129		81 43230 6014 See	81 43220 6129	
3188701	225.039	--	81 43220 6096 See	81 43220 6129		81 43230 6014 See	81 43220 6129	
3189501	220.249	--	81 43220 6097 See	81 43220 6129		81 43230 6014 See	81 43220 6129	
3196501	220.275	--	81 43220 6097 See	81 43220 6129		81 43230 6015 See	81 43230 6031	
3341601	<b>220.209</b>	--	81 43220 6097 See	81 43220 6129		81 43230 6018 See	81 43220 6052	
3358401	220.268	--	81 43220 6098 See	81 43220 6129		81 43230 6026 See	81 43220 6052	
3405101	<b>220.283</b>	--	81 43220 6098 See	81 43220 6129		81 43230 6030 See	81 43220 6129	
			81 43220 6098 See	81 43220 6129		81 43230 6030 See	81 43220 6129	
			81 43220 6106	225.117	229	81 43230 6030 See	81 43220 6129	
			81 43220 6108	<b>198.612</b>	227	81 43230 6031	225.113	225
			81 43220 6119 See	81 43220 6093		81 43230 6037	<b>225.006</b>	226
			81 43220 6120 See	81 43220 6092		81 43230 6038 See	81 43230 6039	
			81 43220 6129	<b>225.008</b>	227	81 43230 6039	225.114	225
			81 43220 6129	<b>225.036</b>	228	81 43230 6043	<b>226.016</b>	225
			81 43220 6129	<b>225.168</b>	228	81 43230 6043	<b>226.016</b>	226
			81 43220 6132	226.105	230	81 43230 6049 See	81 43220 6106	
			81 43220 6140	225.115	227	81 43230 6051	226.102	219
			81 43220 6147 See	81 43220 6106		81 43230 6051	226.102	229
			81 43220 6196	225.119	230	81 43230 6068 See	81 43230 6051	
			81 43220 6221 See	81 43270 6096		81 43230 6068 See	81 43230 6051	
			81 43220 6222 See	81 43220 6260		81 43230 6315	226.128	229
			81 43220 6229 See	81 43220 6236		81 43230 9031 See	81 43230 6031	
			81 43220 6232 See	81 43220 6196		81 43230 9037 See	81 43230 6037	
			81 43220 6233 See	81 43220 6196		81 43230 9039 See	81 43230 6039	

Adattabile a / Suitable to :

**M.A.N.**

81 43220 6010 See	81 43220 6052
81 43220 6012 See	81 43220 6052
81 43220 6013 See	81 43220 6052
81 43220 6020 See	81 43220 6052
81 43220 6025	<b>225.032</b> 231
81 43220 6026 See	81 43220 6052
81 43220 6028 See	81 43220 6052
81 43220 6035 See	81 43220 6052
81 43220 6040 See	81 43220 6052
81 43220 6041 See	81 43220 6052
81 43220 6042	<b>225.031</b> 231
81 43220 6043	<b>225.035</b> 231
81 43220 6052	<b>225.019</b> 226

Date

2010 / 2011

Table

Index

# O.E.M. References

O.E.M. no.	CEI no.	Pag.	O.E.M. no.	CEI no.	Pag.	O.E.M. no.	CEI no.	Pag.
81 43270 6030 See	81 43270 6078		81 43270 6121 See	81 43270 6096		81 46610 6305	<b>220.127</b>	43
81 43270 6034 See	81 43270 6078		81 43270 6126	226.126	222	81 46610 6328 See	81 46610 6305	
81 43270 6037 See	81 43270 6039		81 43270 6129	225.183	220	81 46610 6333 See	81 46610 6722	
81 43270 6039	225.156	224	81 43270 6130 See	81 43270 6129		81 46610 6334 See	81 46610 6722	
81 43270 6040	<b>226.025</b>	224	81 43270 6131 See	81 43270 6129		81 46610 6354 See	81 46610 6722	
81 43270 6045 See	81 43270 6040		81 43270 6134	226.125	220	81 46610 6355 See	81 46610 6722	
81 43270 6053	225.152	219	81 43270 9053 See	81 43270 6053		81 46610 6360 See	81 46610 6722	
81 43270 6054 See	81 43270 6078		81 43270 9054 See	81 43270 6078		81 46610 6361 See	81 46610 6722	
81 43270 6055 See	81 43270 6078		81 43270 9056 See	81 43270 6077		81 46610 6692 See	85 46610 6151	
81 43270 6056 See	81 43270 6077		81 43270 9078 See	81 43270 6078		81 46610 6693 See	85 46610 6151	
81 43270 6057 See	81 43270 6078		81 43601 0033 See	81 43601 0036		81 46610 6695 See	85 46610 6151	
81 43270 6064 See	81 43230 6051		81 43601 0036	<b>260.021</b>	290	81 46610 6721 See	81 46610 6722	
81 43270 6064 See	81 43230 6051		81 43601 0037 See	81 43601 0036		81 46610 6722	<b>220.007</b>	48
81 43270 6065	226.103	219	81 43601 0059 See	81 43601 0081		81 46610 6723 See	81 46610 6722	
81 43270 6067 See	81 43270 6077		81 43601 0065 See	81 43601 0121		81 46610 6724 See	85 46610 6102	
81 43270 6074 See	81 43270 6078		81 43601 0068 See	81 43601 0125		81 46610 6725 See	85 46610 6102	
81 43270 6075 See	81 43270 6077		81 43601 0081	<b>260.047</b>	290	81 46610 6753 See	85 46610 6104	
81 43270 6076 See	81 43270 6078		81 43601 0099 See	81 43601 0121		81 46610 6754 See	85 46610 6104	
81 43270 6077	225.153	220	81 43601 0104 See	81 43601 0140		81 46610 6775 See	82 46610 6191	
81 43270 6078	<b>198.561</b>	219	81 43601 0106 See	81 43601 0125		81 46610 6790 See	82 46610 6191	
81 43270 6079	<b>226.064</b>	220	81 43601 0113 See	81 43601 0081		81 46610 6791 See	82 46610 6191	
81 43270 6080 See	81 95301 6132		81 43601 0120 See	81 43601 0150		81 46610 6797 See	82 46610 6191	
81 43270 6080 See	81 95301 6132		81 43601 0121	<b>260.075</b>	290	81 46611 6087 See	81 46611 6197	
81 43270 6080 See	81 95301 6132		81 43601 0125	<b>260.089</b>	290	81 46611 6096 See	81 46611 6197	
81 43270 6080 See	81 95301 6132		81 43601 0126 See	81 43601 0036		81 46611 6097 See	81 46611 6197	
81 43270 6081 See	81 43270 6077		81 43601 0129 See	81 43601 0121		81 46611 6104 See	81 46611 6199	
81 43270 6082 See	81 43270 6078		81 43601 0132 See	81 43601 0121		81 46611 6105 See	81 46611 6199	
81 43270 6087	<b>225.155</b>	223	81 43601 0136 See	81 43601 0121		81 46611 6132 See	81 46611 6197	
81 43270 6088 See	81 43270 6087		81 43601 0140	<b>260.109</b>	290	81 46611 6133 See	81 46611 6197	
81 43270 6094 See	81 43270 6087		81 43601 0146 See	81 43601 0150		81 46611 6134 See	81 46611 6199	
81 43270 6095 See	81 43270 6087		81 43601 0147 See	81 43601 0150		81 46611 6135 See	81 46611 6199	
81 43270 6096	<b>225.154</b>	221	81 43601 0150	<b>260.076</b>	290	81 46611 6137 See	81 46611 6199	
81 43270 6099 See	81 43270 6079		81 44205 6013	<b>230.017</b>	155	81 46611 6138 See	81 46611 6201	
81 43270 6102	225.170	221	81 44205 6018	230.036	155	81 46611 6139 See	81 46611 6201	
81 43270 6105	<b>226.075</b>	221	81 44205 6019	<b>230.063</b>	154	81 46611 6197	<b>220.130</b>	49
81 43270 6105	<b>226.075</b>	223	81 44205 6020	230.035	154	81 46611 6198 See	81 46611 6197	
81 43270 6106 See	81 43270 6102		81 44205 6023	<b>230.037</b>	156	81 46611 6199	<b>220.196</b>	49
81 43270 6108 See	81 43270 6102		81 44205 6030	<b>230.038</b>	156	81 46611 6200 See	81 46611 6199	
81 43270 6110	<b>226.076</b>	223	81 44205 6033	<b>230.062</b>	154	81 46611 6201	220.251	49
81 43270 6114 See	81 43270 6096		81 44205 6034	<b>230.064</b>	155	81 46611 6202 See	81 46611 6201	
81 43270 6117	225.174	222	81 46610 6001 See	85 46610 6102		81 46611 6203 See	81 46611 6201	
81 43270 6118 See	81 43270 6126		81 46610 6216 See	81 46610 6722		81 46611 6205 See	81 46611 6197	
81 43270 6119	<b>226.117</b>	220	81 46610 6301 See	81 46610 6305		81 46611 6206 See	81 46611 6199	

Date

2010 / 2011

Table

Index

References **O.E.M.**

O.E.M. no.	CEI no.	Pag.	O.E.M. no.	CEI no.	Pag.	O.E.M. no.	CEI no.	Pag.
81 46710 6081 See	81 46711 6759		81 46710 6904 See	81 46711 6724		81 95301 6053 See	81 95301 6234	
81 46710 6112 See	81 46710 6354		81 46710 6912 See	81 46711 6736		81 95301 6054 See	81 95301 6237	
81 46710 6122 See	81 46711 6736		81 46711 6724	<b>220.044</b>	50	81 95301 6056	<b>198.630</b>	124
81 46710 6131 See	81 46710 6904		81 46711 6725 See	81 46710 6354		81 95301 6060 See	81 95301 6249	
81 46710 6137 See	81 46711 6759		81 46711 6736	<b>220.287</b>	50	81 95301 6065 See	81 95301 6056	
81 46710 6163 See	81 46710 6354		81 46711 6759	<b>220.039</b>	51	81 95301 6067 See	81 95301 6056	
81 46710 6165 See	81 46710 6354		81 46711 6760 See	81 46711 6759		81 95301 6068 See	81 95301 6163	
81 46710 6167 See	81 46711 6736		81 46711 6761 See	81 46711 6759		81 95301 6074 See	81 95301 6163	
81 46710 6173 See	81 46711 6759		81 46711 6773 See	81 46711 6860		81 95301 6087 See	81 95301 6237	
81 46710 6194 See	81 46711 6736		81 46711 6820 See	81 46710 6354		81 95301 6090 See	81 95301 6234	
81 46710 6195 See	81 46711 6736		81 46711 6858 See	81 46711 6860		81 95301 6091 See	81 95301 6237	
81 46710 6198 See	81 46710 6354		81 46711 6859 See	81 46711 6860		81 95301 6107 See	81 95301 6237	
81 46710 6265 See	81 46710 6904		81 46711 6860	<b>220.197</b>	51	81 95301 6108 See	81 95301 6234	
81 46710 6266 See	81 46710 6904		81 46711 6861 See	81 46711 6860		81 95301 6112 See	81 95301 6274	
81 46710 6294 See	81 46711 6759		81 46711 6863 See	81 46711 6860		81 95301 6120 See	81 95301 6237	
81 46710 6353 See	81 46710 6354		81 46711 6883 See	81 46711 6860		81 95301 6125 See	81 95301 6237	
81 46710 6354	<b>220.009</b>	50	81 46711 6921 See	81 46711 6860		81 95301 6126 See	81 95301 6234	
81 46710 6359 See	81 46710 6904		81 77701 0072 See	81 95301 6288		81 95301 6132	<b>198.440</b>	219
81 46710 6360 See	81 46710 6904		81 77701 0093 See	81 95301 6288		81 95301 6132	<b>198.440</b>	220
81 46710 6361 See	81 46710 6354		81 77701 0096 See	81 95301 6288		81 95301 6132	<b>198.440</b>	221
81 46710 6362 See	81 46710 6904		81 95301 0013 See	81 95301 6163		81 95301 6132	<b>198.440</b>	222
81 46710 6378 See	81 46711 6736		81 95301 0014 See	81 95301 6056		81 95301 6133	<b>198.461</b>	219
81 46710 6379 See	81 46711 6736		81 95301 0015 See	81 95301 6237		81 95301 6134 See	81 95301 0077	
81 46710 6380 See	81 46711 6736		81 95301 0016 See	81 95301 6234		81 95301 6135 See	81 95301 6249	
81 46710 6396 See	81 46710 6904		81 95301 0064 See	81 95301 6056		81 95301 6139 See	81 95301 6222	
81 46710 6397 See	81 46710 6904		81 95301 0068 See	81 95301 6056		81 95301 6140 See	81 95301 6249	
81 46710 6418	<b>220.286</b>	48	81 95301 0074 See	81 95301 6163		81 95301 6141 See	81 95301 0078	
81 46710 6419 See	81 46711 6759		81 95301 0075 See	81 95301 6234		81 95301 6142 See	81 95301 0077	
81 46710 6436	<b>220.234</b>	45	81 95301 0077	<b>221.022</b>	123	81 95301 6143 See	81 95301 6234	
81 46710 6437 See	81 46710 6436		81 95301 0078	<b>221.021</b>	123	81 95301 6149 See	81 95301 6234	
81 46710 6438	<b>220.233</b>	46	81 95301 0079 See	81 95301 6222		81 95301 6152 See	81 95301 6237	
81 46710 6439 See	81 46710 6438		81 95301 0082 See	81 95301 6163		81 95301 6154 See	81 95301 6234	
81 46710 6442	<b>220.232</b>	45	81 95301 0083 See	81 95301 6237		81 95301 6155 See	81 95301 6237	
81 46710 6443 See	81 46710 6442		81 95301 0084 See	81 95301 6234		81 95301 6156 See	81 95301 6234	
81 46710 6444 See	81 46711 6759		81 95301 0087 See	81 95301 6237		81 95301 6157 See	81 95301 6237	
81 46710 6452 See	81 46710 6438		81 95301 0088 See	81 95301 6234		81 95301 6162 See	81 95301 6056	
81 46710 6455 See	81 46710 6436		81 95301 0094 See	81 95301 6274		81 95301 6163	<b>198.629</b>	124
81 46710 6460 See	81 46710 6442		81 95301 6012 See	81 95301 6234		81 95301 6168 See	81 95301 6237	
81 46710 6816 See	81 46710 6904		81 95301 6030 See	81 95301 6237		81 95301 6178 See	81 95301 6234	
81 46710 6830 See	81 46711 6736		81 95301 6043 See	81 95301 6237		81 95301 6179 See	81 95301 6237	
81 46710 6836 See	81 46711 6736		81 95301 6048 See	81 95301 6234		81 95301 6181 See	81 95301 6237	
81 46710 6877 See	81 46711 6759		81 95301 6049 See	81 95301 6234		81 95301 6194 See	81 95301 6234	
81 46710 6879 See	81 46711 6759		81 95301 6050 See	81 95301 6237		81 95301 6222	<b>198.478</b>	123

All original equipment manufacturers numbers, symbols, pictures, models and description used in this catalogue are for reference only, and it is not implied that any part listed is the product of these manufactures. Tutti i nostri particolari non sono originali ma con essi intercambiabili. I riferimenti originali, le figure, i modelli sono esposti a semplice titolo indicativo. La nostra produzione riporta il nostro marchio.



# O.E.M. References

O.E.M. no.	CEI no.	Pag.	O.E.M. no.	CEI no.	Pag.	O.E.M. no.	CEI no.	Pag.
81 95301 6223 See	81 95301 6237		85 46610 6018 See	85 46610 6152		85 46610 6244	220.245	46
81 95301 6224 See	81 95301 6234		85 46610 6019 See	85 46610 6150		85 46610 6245	220.244	47
81 95301 6234	<b>198.525</b>	123	85 46610 6020 See	85 46610 6151		85 46610 6246	220.246	47
81 95301 6237	<b>198.524</b>	123	85 46610 6021 See	85 46610 6140		85 46610 6247	220.247	47
81 95301 6239 See	81 95301 6056		85 46610 6022 See	85 46610 6155		90 80415 3107 See	81 95301 6163	
81 95301 6242 See	81 95301 6274		85 46610 6030 See	85 46610 6102		90 80415 3111 See	81 95301 6056	
81 95301 6249	<b>198.477</b>	123	85 46610 6031 See	85 46610 6104		90 80415 3113 See	81 95301 6163	
81 95301 6272 See	81 95301 6056		85 46610 6032 See	85 46610 6103				
81 95301 6273 See	81 95301 6163		85 46610 6050 See	85 46610 6142				
81 95301 6274	<b>221.033</b>	124	85 46610 6051 See	85 46610 6141				
81 95301 6278 See	81 95301 6234		85 46610 6102	<b>220.207</b>	43			
81 95301 6279 See	81 95301 6237		85 46610 6103	220.231	43			
81 95301 6282 See	81 95301 6056		85 46610 6104	<b>220.156</b>	43			
81 95301 6283 See	81 95301 6163		85 46610 6105 See	85 46610 6141				
81 95301 6284 See	81 95301 6234		85 46610 6107 See	85 46610 6143				
81 95301 6285 See	81 95301 6237		85 46610 6112 See	85 46610 6142				
81 95301 6288	221.086	124	85 46610 6118 See	85 46610 6152				
81 95301 6303 See	81 95301 0077		85 46610 6119 See	85 46610 6150				
81 95301 6304 See	81 95301 0078		85 46610 6121 See	85 46610 6140				
81 95301 6308 See	81 95301 6234		85 46610 6122 See	85 46610 6155				
81 95301 6312	<b>221.062</b>	124	85 46610 6140	<b>220.228</b>	44			
81 95301 6319 See	81 95301 6056		85 46610 6141	<b>220.236</b>	44			
81 95301 6321 See	81 95301 0077		85 46610 6142	<b>220.238</b>	44			
81 95301 6322 See	81 95301 0078		85 46610 6143	220.237	44			
81 95301 6328 See	81 95301 6249		85 46610 6150	<b>220.241</b>	45			
81 95301 6350 See	81 95301 6234		85 46610 6151	<b>220.242</b>	45			
81 95301 6352 See	81 95301 6312		85 46610 6152 See	85 46610 6235				
81 95301 6358 See	81 95301 6249		85 46610 6155	220.229	46			
81 95301 6360 See	81 95301 6056		85 46610 6162	220.249	47			
81 95302 0041 See	81 43220 6055		85 46610 6163	220.248	48			
81 95302 0041 See	81 43220 6055		85 46610 6166	220.250	48			
81 95302 0041 See	81 43220 6055		85 46610 6201 See	85 46610 6102				
81 95302 0042 See	81 43220 6055		85 46610 6202 See	85 46610 6103				
81 95302 0042 See	81 43220 6055		85 46610 6203 See	85 46610 6104				
81 95302 0042 See	81 43220 6055		85 46610 6205 See	85 46610 6141				
81 96401 0152	226.104	229	85 46610 6207 See	85 46610 6143				
81 99164 8156 See	81 43230 6039		85 46610 6212 See	85 46610 6142				
81 99805 1662 See	81 46611 6201		85 46610 6218 See	85 46610 6152				
82 46610 6191	<b>220.285</b>	49	85 46610 6221 See	85 46610 6140				
85 46610 6003 See	85 46610 6103		85 46610 6222 See	85 46610 6155				
85 46610 6005 See	85 46610 6141		85 46610 6231 See	85 46610 6141				
85 46610 6006 See	85 46610 6104		85 46610 6234 See	85 46610 6142				
85 46610 6012 See	85 46610 6142		85 46610 6235	<b>220.230</b>	46			

## Adattabile a / Suitable to : MERCEDES

000 327 0101	See	307 327 0001
000 327 0201	See	307 327 0001
000 330 0035	See	302 330 0335
000 330 0148	See	302 330 0335
000 330 0235	See	000 330 8635
000 330 0248	See	001 330 0135
000 330 0310	226.095	201
000 330 0310	226.095	202
000 330 0335	See	000 330 8535
000 330 0410	226.094	201
000 330 0410	226.094	202
000 330 0611	226.098	217
000 330 0635	See	000 330 8535
000 330 0707	<b>226.018</b>	217
000 330 0735	See	000 330 8635
000 330 1235	See	000 330 9935
000 330 1335	See	000 330 9835
000 330 1411	226.074	214
000 330 1411	226.074	216
000 330 1435	See	000 330 9535
000 330 1535	See	000 330 9535
000 330 1711	226.131	214
000 330 1935	See	001 330 2735
000 330 2410	See	000 330 8535
000 330 2835	See	001 330 2635
000 330 2935	See	001 330 2735
000 330 3135	See	001 330 0335
000 330 3235	See	001 330 0135
000 330 3335	See	000 330 9635
000 330 4035	See	001 330 2635
000 330 4135	See	001 330 2735
000 330 5835	See	001 330 0135
000 330 6735	See	000 330 8535

Date

2010 / 2011

Table

Index

References **O.E.M.**

O.E.M. no.	CEI no.	Pag.	O.E.M. no.	CEI no.	Pag.	O.E.M. no.	CEI no.	Pag.
000 330 6835	See	000 330 8635	000 350 0613	<b>226.011</b>	209	000 460 2748	See	000 460 2648
000 330 7135	See	000 330 9535	000 350 0613	<b>226.011</b>	210	000 460 2848	See	001 460 2248
000 330 7235	See	000 330 9635	000 350 0613	<b>226.011</b>	212	000 460 2948	See	001 460 7748
000 330 7335	See	001 330 0135	000 350 0613	<b>226.011</b>	213	000 460 3448	See	000 460 3548
000 330 7535	See	000 330 9935	000 350 1013	226.013	204	000 460 3548	<b>198.524</b>	118
000 330 7635	See	000 330 9835	000 350 1505	<b>226.036</b>	272	000 460 5748	<b>221.046</b>	119
000 330 7735	See	001 330 2635	000 350 1705	<b>226.056</b>	194	000 460 5848	See	001 460 0548
000 330 7835	See	001 330 2735	000 350 1705	<b>226.056</b>	195	000 460 6048	See	000 460 5748
000 330 8135	See	001 330 0335	000 350 1705	<b>226.056</b>	196	000 460 6148	See	001 460 0548
000 330 8535	<b>221.022</b>	117	000 350 1805	<b>226.072</b>	194	000 460 6848	See	000 460 5748
000 330 8635	<b>221.021</b>	117	000 350 1805	<b>226.072</b>	195	000 460 6948	See	001 460 0548
000 330 8735	See	000 330 8535	000 350 1805	<b>226.072</b>	196	000 460 7048	See	000 460 5748
000 330 8835	See	000 330 8635	000 350 1905	226.130	212	000 460 7105	See	001 460 6705
000 330 9335	See	000 330 9535	000 350 2005	See	000 350 4705	000 460 7148	See	001 460 0548
000 330 9435	See	000 330 9635	000 350 2105	See	000 350 4605	000 460 7205	See	001 460 6705
000 330 9535	<b>198.477</b>	118	000 350 2205	<b>226.054</b>	198	000 460 7248	See	000 330 8535
000 330 9635	<b>198.478</b>	118	000 350 2205	<b>226.054</b>	199	000 460 7548	See	000 460 5748
000 330 9735	See	000 330 9935	000 350 2305	<b>226.066</b>	197	000 460 7748	221.059	117
000 330 9835	<b>198.476</b>	117	000 350 2305	<b>226.066</b>	198	000 460 7848	221.060	117
000 330 9935	<b>198.475</b>	117	000 350 2305	<b>226.066</b>	201	000 460 8348	See	001 330 0135
000 338 2129	See	000 330 9535	000 350 2405	See	000 350 4905	000 460 8948	See	001 460 2248
000 338 2410	See	000 330 8535	000 350 2505	226.115	201	000 460 9205	See	000 460 9305
000 338 3410	See	001 330 0135	000 350 2705	<b>226.073</b>	215	000 460 9248	See	001 460 2948
000 338 3429	See	000 330 9935	000 350 3105	See	000 350 2305	000 460 9305	<b>220.084</b>	35
000 338 3529	See	000 330 9935	000 350 3205	See	000 350 2205	000 460 9505	See	001 460 7105
000 338 3629	See	000 330 9535	000 350 3305	226.091	197	000 460 9805	<b>220.040</b>	31
000 338 4929	See	001 330 2635	000 350 3505	See	000 350 4905	000 460 9905	See	000 460 9805
000 338 5029	See	001 330 2735	000 350 3605	<b>226.068</b>	200	000 463 2229	See	001 330 0135
000 350 0105	See	000 350 0405	000 350 3705	<b>226.067</b>	199	000 463 3229	See	000 330 8535
000 350 0113	226.039	208	000 350 3705	<b>226.067</b>	200	000 463 3429	See	001 330 0135
000 350 0113	226.039	210	000 350 4605	226.090	197	000 463 3529	See	001 330 0135
000 350 0205	226.129	211	000 350 4605	226.090	200	000 586 0632	<b>198.252</b>	203
000 350 0213	See	000 586 1433	000 350 4705	226.089	197	000 586 0632	<b>198.252</b>	204
000 350 0305	See	000 586 1433	000 350 4705	226.089	200	000 586 1135	See	000 350 0613
000 350 0405	<b>198.647</b>	194	000 350 4805	See	000 350 3305	000 586 1235	See	000 350 0413
000 350 0405	<b>198.647</b>	195	000 350 4905	<b>226.069</b>	199	000 586 1433	<b>198.642</b>	194
000 350 0413	<b>226.025</b>	209	000 460 0148	See	000 460 2648	000 586 1433	<b>198.642</b>	195
000 350 0413	<b>226.025</b>	210	000 460 0348	See	001 460 2248	000 586 1433	<b>198.642</b>	205
000 350 0413	<b>226.025</b>	211	000 460 0648	See	000 460 3548	000 586 1433	<b>198.642</b>	206
000 350 0505	See	000 586 1433	000 460 0948	See	001 460 2248	000 586 1433	<b>198.642</b>	207
000 350 0506	See	000 330 0707	000 460 1048	See	001 460 7748	000 586 1433	<b>198.642</b>	211
000 350 0613	<b>226.011</b>	204	000 460 1248	See	000 460 3548	000 586 1433	<b>198.642</b>	213
000 350 0613	<b>226.011</b>	208	000 460 2648	189.287	119	000 586 1533	<b>198.644</b>	194

All original equipment manufacturers numbers, symbols, pictures, models and description used in this catalogue are for reference only, and it is not implied that any part listed is the product of these manufactures.  
Tutti i nostri particolari non sono originali ma con essi intercambiabili. I riferimenti originali, le figure, i modelli sono esposti a semplice titolo indicativo. La nostra produzione riporta il nostro marchio.

# O.E.M. References

O.E.M. no.	CEI no.	Pag.	O.E.M. no.	CEI no.	Pag.	O.E.M. no.	CEI no.	Pag.
000 586 1533	<b>198.644</b>	195	001 460 3648	See	000 460 3548	002 460 6405	See	001 460 9805
000 586 1533	<b>198.644</b>	205	001 460 3848	<b>221.058</b>	119	002 460 7505	See	003 460 4405
000 586 1533	<b>198.644</b>	206	001 460 4148	See	001 330 0135	002 460 7605	See	003 460 4405
000 586 1533	<b>198.644</b>	207	001 460 4248	<b>221.034</b>	118	002 460 7705	<b>220.185</b>	35
000 586 1833	See	000 350 0405	001 460 4348	See	302 330 0335	002 460 7805	See	002 460 7705
001 330 0035	See	000 330 9835	001 460 4448	See	001 330 0135	002 460 9005	220.222	38
001 330 0135	<b>198.630</b>	118	001 460 4848	See	001 460 3848	002 460 9105	See	002 460 9005
001 330 0235	See	001 330 0135	001 460 5048	See	001 460 4248	002 460 9205	See	002 460 9305
001 330 0335	<b>221.057</b>	119	001 460 5105	See	001 460 8105	002 460 9305	220.224	38
001 330 0435	See	001 330 0335	001 460 5148	See	001 460 3848	003 460 4405	<b>220.184</b>	35
001 330 1835	<b>198.485</b>	120	001 460 6705	<b>220.059</b>	35	003 460 5105	See	002 460 7705
001 330 2135	See	001 330 2635	001 460 6905	See	000 460 9305	300 460 0405	See	300 460 0505
001 330 2235	See	001 330 2735	001 460 7005	See	001 460 0705	300 460 0505	<b>220.028</b>	38
001 330 2635	<b>221.013</b>	120	001 460 7105	<b>220.227</b>	38	300 460 0605	See	300 460 0705
001 330 2735	<b>221.014</b>	120	001 460 7648	See	000 460 5748	300 460 0705	<b>220.027</b>	39
001 330 4035	See	001 330 2635	001 460 7748	<b>198.525</b>	118	301 460 0505	See	300 460 0505
001 330 6635	See	302 330 0335	001 460 7848	See	000 460 3548	302 330 0035	See	302 330 0335
001 330 6735	See	001 330 0135	001 460 7948	See	001 460 0548	302 330 0135	See	302 330 0335
001 330 8835	See	302 330 0335	001 460 8105	220.221	37	302 330 0235	See	302 330 0335
001 460 0305	See	001 460 0405	001 460 8348	See	001 330 0135	302 330 0335	<b>198.629</b>	119
001 460 0405	<b>220.030</b>	31	001 460 8448	See	001 330 0135	305 460 0305	See	300 460 0705
001 460 0448	See	000 460 5748	001 460 8548	See	001 460 4248	307 327 0001	<b>260.044</b>	287
001 460 0548	<b>221.045</b>	119	001 460 8648	See	001 460 3848	307 327 0101	See	307 327 0001
001 460 0705	<b>220.081</b>	36	001 460 9805	<b>220.085</b>	36	343 320 1632	149.074	203
001 460 0805	See	001 460 0705	001 460 9905	See	001 460 9805	343 320 1732	189.278	203
001 460 0848	See	001 460 2248	002 330 1535	See	001 330 0135	343 320 1832	225.085	204
001 460 1148	See	000 460 5748	002 460 1405	<b>220.153</b>	31	343 586 0032	<b>198.261</b>	203
001 460 1248	See	001 460 2248	002 460 1605	See	002 460 1405	343 586 0032	<b>198.261</b>	204
001 460 1348	See	001 460 0548	002 460 4305	<b>220.082</b>	36	344 330 7135	See	000 330 9535
001 460 1448	See	000 460 3548	002 460 4405	See	002 460 4305	350 330 7035	See	001 330 0135
001 460 1748	See	000 460 5748	002 460 4505	See	002 460 4605	350 330 7135	See	302 330 0335
001 460 1848	See	001 460 7748	002 460 4605	<b>220.181</b>	34	350 330 7203	See	393 330 0303
001 460 2048	See	000 460 7848	002 460 4705	See	002 460 4805	356 330 0003	220.154	39
001 460 2148	See	000 460 7748	002 460 4805	<b>220.083</b>	36	356 330 0103	220.155	39
001 460 2248	<b>221.033</b>	120	002 460 4905	See	002 460 5005	356 330 1410	See	613 330 0010
001 460 2348	See	000 460 3548	002 460 5005	<b>220.132</b>	34	356 330 1510	See	613 330 0110
001 460 2448	See	000 460 5748	002 460 5105	See	002 460 5205	357 333 0205	225.110	217
001 460 2548	See	001 460 0548	002 460 5205	<b>220.226</b>	37	357 333 0605	See	357 333 0905
001 460 2905	<b>220.119</b>	32	002 460 5905	See	002 460 6005	357 333 0905	225.109	217
001 460 2948	<b>221.061</b>	120	002 460 6005	220.225	37	371 330 7003	See	393 330 0303
001 460 3005	See	001 460 2905	002 460 6105	See	002 460 6205	381 350 0206	225.087	205
001 460 3148	See	001 330 0135	002 460 6205	220.223	37	381 350 0306	See	385 350 0206
001 460 3448	See	001 330 0135	002 460 6305	See	001 460 9805	381 350 0606	See	653 350 0106

Date

2010 / 2011

Table

Index

References **O.E.M.**

O.E.M. no.	CEI no.	Pag.	O.E.M. no.	CEI no.	Pag.	O.E.M. no.	CEI no.	Pag.
382 327 7201	<b>260.087</b>	287	395 320 1432	225.090	207	625 330 2503	<b>220.042</b>	40
382 327 7301	See	382 327 7201	395 320 1532	225.007	206	625 350 0106	See	659 350 1906
383 327 0001	<b>260.018</b>	287	395 350 0006	See	659 350 3406	625 460 2505	<b>220.172</b>	30
383 350 0006	See	381 350 0206	395 350 0206	See	659 350 0106	647 460 0005	See	647 460 0105
383 350 0105	See	658 350 0005	395 350 0706	See	659 350 0406	647 460 0105	<b>198.535</b>	28
383 460 0605	See	383 460 4405	395 350 1106	See	659 350 0906	647 460 0105	<b>198.535</b>	30
383 460 0805	See	383 460 4505	395 350 1206	See	659 350 0906	652 350 0306	225.010	212
383 460 1405	See	383 460 4405	395 350 1306	See	659 350 1606	653 350 0005	See	654 350 0105
383 460 1605	See	383 460 4505	613 330 0003	See	356 330 0003	653 350 0006	See	385 350 0006
383 460 2305	See	383 460 4405	613 330 0010	225.150	201	653 350 0105	See	654 350 0105
383 460 2405	See	383 460 4505	613 330 0103	See	356 330 0103	653 350 0106	225.098	211
383 460 4405	<b>198.536</b>	27	613 330 0110	225.151	202	653 350 0205	See	654 350 0105
383 460 4505	<b>220.031</b>	27	617 460 2005	See	617 460 3405	653 350 0305	225.144	196
385 350 0006	225.091	207	617 460 2405	See	617 460 3405	653 350 0405	225.143	196
385 350 0106	225.086	204	617 460 3405	<b>220.035</b>	29	653 353 0005	See	658 350 0005
385 350 0206	225.011	204	619 460 2505	See	619 460 2905	654 350 0105	225.059	195
387 328 0001	See	387 328 0101	619 460 2905	<b>220.117</b>	31	654 350 0305	See	654 350 0105
387 328 0101	<b>260.021</b>	287	619 460 5205	See	619 460 2905	654 350 0406	See	654 350 0506
387 460 0005	See	387 460 4805	620 330 0003	See	620 330 0503	654 350 0506	225.099	212
387 460 0405	See	620 460 3705	620 330 0503	<b>220.043</b>	40	654 352 0005	See	654 350 0506
387 460 0605	See	387 460 4405	620 330 0603	See	620 330 0503	655 330 0019		151
387 460 0705	See	647 460 0105	620 350 0006	See	620 350 0106	655 330 0119		151
387 460 1405	See	647 460 0105	620 350 0106	225.005	213	655 330 0319		152
387 460 3205	See	647 460 0105	620 460 0005	See	620 460 3705	655 330 0419		152
387 460 3305	See	647 460 0105	620 460 0405	See	620 460 3005	655 330 0519		152
387 460 4405	220.152	27	620 460 0805	See	620 460 3005	655 330 0619		152
387 460 4505	See	387 460 4405	620 460 2005	See	620 460 3705	655 350 0006	<b>198.643</b>	213
387 460 4805	220.151	27	620 460 2805	See	620 460 3705	655 350 0305	See	658 350 0005
387 460 4905	See	387 460 4805	620 460 2905	See	620 460 3005	655 350 0306	225.009	213
387 460 5005	See	620 460 3705	620 460 3005	<b>220.037</b>	30	655 350 0506	See	655 350 0306
389 320 0732	See	655 350 0006	620 460 3705	<b>198.628</b>	30	656 350 0005	See	658 350 0205
393 320 0132	See	655 350 0006	621 328 0001	See	383 327 0001	656 350 0006	See	655 350 0006
393 320 0232	225.089	206	624 350 0006	See	659 350 3406	658 350 0005	<b>198.648</b>	194
393 330 0003	See	393 330 0303	624 350 0106	See	659 350 1206	658 350 0006	See	655 350 0006
393 330 0203	See	393 330 0303	624 350 0306	225.093	208	658 350 0105	225.141	194
393 330 0303	<b>220.050</b>	39	624 350 0406	See	659 350 1506	658 350 0205	225.142	195
393 330 0403	See	393 330 0303	624 350 0506	See	659 350 1606	658 350 0206	See	655 350 0006
393 350 5205	See	658 350 0005	624 350 0606	225.092	208	659 350 0106	225.094	209
393 350 5305	See	658 350 0005	625 330 0903	See	625 330 1203	659 350 0406	225.023	209
393 350 5405	See	658 350 0005	625 330 1203	220.125	42	659 350 0906	225.097	211
393 350 5505	See	658 350 0005	625 330 1503	See	625 330 2503	659 350 1006	See	659 350 1606
395 320 0132	225.088	205	625 330 1603	See	625 330 2503	659 350 1106	See	659 350 3406
395 320 0332	See	385 350 0106	625 330 2403	See	625 330 2503	659 350 1206	225.095	210

All original equipment manufacturers' numbers, symbols, pictures, models and description used in this catalogue are for reference only, and it is not implied that any part listed is the product of these manufactures.  
Tutti i nostri particolari non sono originali ma con essi intercambiabili. I riferimenti originali, le figure, i modelli sono esposti a semplice titolo indicativo. La nostra produzione riporta il nostro marchio.

# O.E.M. References

O.E.M. no.	CEI no.	Pag.	O.E.M. no.	CEI no.	Pag.	O.E.M. no.	CEI no.	Pag.
659 350 1406	See	624 350 0306	941 330 0007	225.106	216	945 330 0203	<b>220.089</b>	41
659 350 1506	225.021	209	941 330 0011	225.107	216	945 330 0303	See	945 330 0203
659 350 1606	225.022	208	941 330 0103	<b>220.086</b>	41	945 330 0403	See	945 330 0103
659 350 1706	See	624 350 0606	941 330 0203	See	941 330 0103	945 330 0503	See	945 330 0203
659 350 1906	225.096	210	941 330 0303	See	941 330 0103	945 330 0603	See	945 330 0103
659 350 2406	See	659 350 0106	942 320 0117	See	942 320 4321	945 350 0105	See	948 350 2505
659 350 2706	See	659 350 0406	942 320 4321	260.176	287	947 350 0005	See	948 350 2405
659 350 3206	See	659 350 0906	942 326 0150	226.093	198	947 350 0105	<b>225.040</b>	198
659 350 3306	See	659 350 1606	942 326 0250	226.092	198	947 350 0505	225.149	201
659 350 3406	225.024	210	942 330 0003	See	942 330 0103	947 350 0705	See	947 350 0105
659 350 3506	See	659 350 1206	942 330 0019		152	947 350 0905	See	948 350 3005
659 350 3706	See	624 350 0306	942 330 0103	<b>220.087</b>	42	947 350 1005	See	947 350 0105
659 350 3806	See	659 350 1506	942 330 0119		152	948 350 0405	See	948 350 3005
659 350 3906	See	659 350 1606	942 330 0203	See	942 330 0103	948 350 0605	See	948 350 2405
659 350 4006	See	624 350 0606	942 330 0219		153	948 350 0805	See	948 350 1205
659 350 4206	See	659 350 1906	942 330 0319		153	948 350 0905	See	948 350 2305
667 460 1505	See	667 460 1705	942 330 0419		153	948 350 1005	See	948 350 2505
667 460 1705	<b>220.215</b>	32	942 330 0503	See	942 330 0903	948 350 1205	225.103	215
673 460 0205	See	673 460 0605	942 330 0519		153	948 350 1305	See	948 350 2405
673 460 0405	See	673 460 0605	942 330 0603	See	942 330 0903	948 350 1705	See	948 350 2205
673 460 0605	<b>220.032</b>	28	942 330 0703	See	942 330 0103	948 350 2005	See	948 350 2405
673 460 0805	See	673 460 0605	942 330 0803	See	949 330 0203	948 350 2205	<b>225.058</b>	199
675 460 1005	See	675 460 2205	942 330 0903	<b>220.090</b>	41	948 350 2305	<b>225.147</b>	200
675 460 1205	See	675 460 3005	942 330 1103	See	942 330 0103	948 350 2405	<b>225.104</b>	215
675 460 1605	See	675 460 2205	942 332 0006		151	948 350 2505	225.105	215
675 460 1805	See	675 460 3005	942 332 0006		152	948 350 3005	<b>225.060</b>	199
675 460 2205	<b>220.006</b>	28	942 332 0006		152	949 330 0203	<b>220.164</b>	40
675 460 2405	See	675 460 3005	942 332 1606		152	949 330 0203	<b>220.164</b>	41
675 460 2805	See	675 460 2205	942 332 1906		153	949 330 0303	See	949 330 0203
675 460 3005	<b>220.038</b>	28	942 350 0105	See	942 350 1105	949 330 0903	See	949 330 0203
676 460 0105	See	676 460 1105	942 350 0205	225.146	198	970 330 0003	<b>220.182</b>	40
676 460 0605	See	676 460 1105	942 350 0505	See	942 350 1205	970 330 0103	See	970 330 0003
676 460 1105	<b>220.019</b>	29	942 350 0805	See	942 350 1205	970 330 0203	See	970 330 0003
676 460 1505	See	676 460 1105	942 350 1005	See	947 350 0105	970 330 0303	See	970 330 0003
676 460 1905	See	676 460 2105	942 350 1105	225.148	200	970 330 0403	See	970 330 0003
676 460 2105	220.216	29	942 350 1205	225.039	197	970 332 0406		151
676 460 3105	220.217	29	944 330 0203	See	625 330 1203	970 460 0705	<b>220.177</b>	32
698 460 3748	See	000 460 3548	944 350 0005	See	947 350 0105	970 460 0905	See	970 460 0705
901 333 0627	See	901 333 1127	944 350 0305	See	947 350 0105	972 330 0211	225.101	214
901 333 0727	See	901 333 1127	944 350 0505	See	948 350 3005	972 330 0311	225.102	214
901 333 1127	221.035	120	945 330 0003	See	945 330 0103	972 460 1005	See	972 460 1205
901 333 1227	See	901 333 1127	945 330 0011	225.108	216	972 460 1205	<b>220.220</b>	33
941 330 0003	See	941 330 0103	945 330 0103	<b>220.088</b>	42	972 460 1405	<b>220.178</b>	32

Date

2010 / 2011

Table

Index

O.E.M. no.	CEI no.	Pag.	O.E.M. no.	CEI no.	Pag.	O.E.M. no.	CEI no.	Pag.
972 460 1605	See	972 460 1405	00 23 123 275	225.122	233	50 00 814 096	<b>221.021</b>	125
972 460 1805	<b>220.179</b>	33	50 00 242 159	See	00 03 406 212	50 00 814 097	See	50 01 860 123
972 460 2005	See	972 460 1805	50 00 288 360	See	50 01 858 773	50 00 819 365	<b>226.053</b>	236
972 460 2805	<b>220.180</b>	34	50 00 288 361	See	50 01 858 774	50 00 819 365	<b>226.053</b>	237
974 330 0107	225.100	214	50 00 288 362	<b>221.051</b>	129	50 00 819 413	<b>198.644</b>	234
974 350 0005	See	974 350 0505	50 00 288 363	<b>221.052</b>	129	50 00 819 517	See	50 00 786 901
974 350 0405	See	974 350 0505	50 00 288 366	221.076	129	50 00 823 228	226.060	233
974 350 0505	225.145	197	50 00 288 367	221.077	129	50 00 823 947	See	50 00 823 997
974 460 0005	220.218	34	50 00 295 214	See	00 03 406 212	50 00 823 987	<b>198.477</b>	126
974 460 0405	See	974 460 2205	50 00 295 215	See	50 01 834 533	50 00 823 997	<b>198.478</b>	126
974 460 0605	See	974 460 0005	50 00 336 305	<b>230.008</b>	157	50 00 869 572	See	50 10 207 726
974 460 0805	See	974 460 2205	50 00 336 306	<b>230.009</b>	157	50 00 869 573	See	50 10 207 727
974 460 1005	See	974 460 1205	50 00 352 082	See	50 00 541 230	50 00 874 577	See	50 10 130 453
974 460 1205	<b>220.131</b>	33	50 00 352 083	See	50 00 541 230	50 01 014 345	<b>226.031</b>	234
974 460 2205	220.219	33	50 00 446 680	220.157	52	50 01 014 424	<b>198.674</b>	233
975 332 0606		151	50 00 541 230	220.093	52	50 01 823 278	226.107	235
976 460 0205	See	974 460 2205	50 00 556 940	198.654	161	50 01 823 280	<b>226.032</b>	235
<i>Adattabile a / Suitable to :</i>			50 00 559 335	See	50 00 823 987	50 01 825 687	See	50 00 823 987
<b>RENAULT V.I.</b>			50 00 559 336	See	50 00 823 997	50 01 831 473	See	00 03 406 212
00 00 408 526	<b>117.260</b>	272	50 00 590 236	<b>198.525</b>	126	50 01 831 481	See	50 01 832 580
00 00 408 563	<b>117.261</b>	272	50 00 725 267	See	50 10 144 552	50 01 831 526	<b>226.050</b>	234
00 00 712 758	See	50 10 130 453	50 00 725 268	See	50 10 144 554	50 01 832 579	<b>198.486</b>	128
00 03 401 165	See	50 00 288 362	50 00 745 719	See	50 10 144 556	50 01 832 580	<b>198.485</b>	128
00 03 401 169	See	50 00 590 236	50 00 748 784	See	50 10 130 453	50 01 832 581	See	50 01 858 774
00 03 401 170	<b>198.524</b>	126	50 00 748 868	See	50 10 130 453	50 01 832 582	221.063	127
00 03 401 206	See	50 01 832 579	50 00 761 670	See	50 10 207 725	50 01 834 533	<b>198.629</b>	127
00 03 401 207	See	50 01 832 580	50 00 786 527	See	50 10 207 725	50 01 836 297	See	00 03 401 170
00 03 406 169	See	50 00 590 236	50 00 786 901	<b>260.047</b>	291	50 01 836 298	See	50 00 590 236
00 03 406 212	<b>198.630</b>	127	50 00 787 304	See	50 10 144 552	50 01 842 337	<b>226.052</b>	234
00 03 406 213	See	50 01 834 533	50 00 787 472	See	50 10 130 483	50 01 842 337	<b>226.052</b>	235
00 03 406 218	See	50 01 834 533	50 00 790 692	See	50 10 130 925	50 01 844 135	See	50 00 814 096
00 03 406 236	See	50 00 590 236	50 00 791 330	See	50 10 144 556	50 01 844 136	See	50 00 814 097
00 03 406 242	See	50 00 823 987	50 00 793 641	<b>230.011</b>	157	50 01 847 436	221.066	125
00 03 406 251	See	50 00 590 236	50 00 793 828	<b>230.004</b>	159	50 01 847 437	221.065	125
00 03 406 252	See	50 00 814 097	50 00 793 849	<b>230.002</b>	160	50 01 850 549	See	00 03 406 212
00 03 406 253	See	00 03 406 212	50 00 794 185	<b>230.010</b>	158	50 01 850 550	See	50 01 834 533
00 03 406 254	See	50 00 590 236	50 00 794 319	<b>230.001</b>	159	50 01 851 800	221.067	126
00 03 406 260	See	50 00 590 236	50 00 794 320	<b>198.676</b>	159	50 01 852 263	See	50 01 834 533
00 03 406 261	See	50 00 590 236	50 00 804 824	See	50 00 590 236	50 01 852 264	221.068	127
00 03 486 218	See	50 01 834 533	50 00 807 553	See	50 00 814 096	50 01 852 452	221.054	127
00 23 123 247	See	50 10 130 453	50 00 807 554	See	50 00 814 097	50 01 855 584	See	50 01 832 582
00 23 123 253	See	50 10 094 941	50 00 808 789	<b>107.127</b>	233	50 01 858 756	221.069	125
			50 00 812 483	See	00 03 406 212	50 01 858 757	221.070	125

Date

2010 / 2011

Table

Index



# O.E.M. References

O.E.M. no.	CEI no.	Pag.	O.E.M. no.	CEI no.	Pag.	O.E.M. no.	CEI no.	Pag.
50 01 858 763	221.078	128	50 10 144 549	See	50 10 144 552	50 10 557 523	220.257	60
50 01 858 773	<b>198.657</b>	126	50 10 144 551	See	50 10 144 556	50 10 557 524	220.266	62
50 01 858 774	<b>198.666</b>	127	50 10 144 552	See	74 85 114 927	50 10 566 048	<b>220.101</b>	63
50 01 860 123	<b>221.022</b>	125	50 10 144 554	See	74 85 120 948	50 10 566 058	<b>220.110</b>	63
50 01 860 124	See	50 00 814 096	50 10 144 556	220.010	55	50 10 566 059	<b>220.288</b>	64
50 01 868 363	220.278	65	50 10 144 557	See	50 10 144 556	50 10 566 062	<b>220.105</b>	63
50 01 868 366	220.279	65	50 10 145 581	See	50 10 566 058	50 10 566 063	See	50 10 439 021
50 01 868 374	220.253	60	50 10 151 529	See	50 10 207 725	50 10 566 064	220.277	64
50 01 868 375	220.254	61	50 10 160 453	See	50 10 130 453	50 10 600 487	220.267	62
50 01 868 376	220.255	61	50 10 164 533	225.121	233	50 10 630 617	<b>220.103</b>	58
50 01 868 377	220.256	61	50 10 207 725	<b>220.026</b>	63	50 10 630 820	See	50 10 630 821
50 01 868 382	220.258	58	50 10 207 726	225.038	236	50 10 630 821	<b>220.289</b>	65
50 01 868 383	220.259	58	50 10 207 727	225.037	237	55 16 017 400	See	50 00 541 230
50 01 868 384	220.260	58	50 10 229 242	See	50 10 488 052	55 16 017 831	See	50 00 541 230
50 01 868 385	220.261	59	50 10 239 340	<b>220.025</b>	56	58 10 112 248	220.161	55
50 01 868 386	220.262	59	50 10 239 386	See	50 10 239 340	74 20 443 044	225.175	236
50 01 868 419	220.263	59	50 10 239 387	220.162	56	74 20 532 931	225.190	236
50 10 013 397	See	50 10 207 727	50 10 259 241	220.252	62	74 20 547 286	<b>226.117</b>	232
50 10 013 398	See	50 10 207 726	50 10 294 199	<b>220.091</b>	53	74 20 702 096		236
50 10 037 602	See	50 10 130 456	50 10 294 287	<b>220.065</b>	57	74 20 741 703	<b>225.167</b>	232
50 10 037 603	See	50 10 130 456	50 10 294 288	<b>220.064</b>	57	74 20 741 710	<b>226.111</b>	232
50 10 060 764	<b>220.068</b>	59	50 10 294 289	See	50 10 630 617	74 20 761 145	220.268	62
50 10 064 641	See	50 10 094 941	50 10 294 307	<b>260.181</b>	291	74 20 829 503	225.162	232
50 10 092 170	See	50 10 144 556	50 10 294 502	<b>220.102</b>	57	74 20 840 815		232
50 10 092 191	See	50 10 144 556	50 10 294 720	220.265	57	74 20 840 820		232
50 10 094 838	<b>198.645</b>	233	50 10 305 367	See	50 10 488 167	74 85 104 224		236
50 10 094 838	See	50 10 094 941	50 10 308 082	See	50 10 566 059	74 85 114 925	220.060	56
50 10 094 839	<b>225.015</b>	235	50 10 308 215	See	50 10 566 058	74 85 114 926	<b>198.653</b>	56
50 10 094 840	225.068	235	50 10 383 203	<b>220.163</b>	60	74 85 114 927	<b>220.008</b>	55
50 10 094 941	<b>198.645</b>	234	50 10 383 410	220.100	53	74 85 114 936	<b>220.024</b>	52
50 10 104 289	See	50 10 207 725	50 10 389 262	<b>225.028</b>	234	74 85 120 948	220.061	55
50 10 104 465	See	50 00 819 365	50 10 439 021	<b>220.187</b>	64	74 85 120 949	See	50 10 144 556
50 10 130 344	<b>220.112</b>	60	50 10 439 022	<b>220.186</b>	64	77 01 011 412	See	50 00 590 236
50 10 130 393	See	74 85 114 936	50 10 439 023	See	50 10 566 062	77 01 016 946	See	00 03 406 212
50 10 130 451	See	74 85 114 925	50 10 467 915	<b>225.061</b>	235			
50 10 130 453	See	74 85 114 926	50 10 488 052	<b>220.098</b>	61			
50 10 130 456	<b>220.063</b>	52	50 10 488 146	<b>220.160</b>	54			
50 10 130 483	220.022	54	50 10 488 164	<b>220.158</b>	53			
50 10 130 739	See	50 10 239 340	50 10 488 165	<b>220.092</b>	53			
50 10 130 740	See	50 10 239 387	50 10 488 166	<b>220.159</b>	54			
50 10 130 925	<b>260.011</b>	291	50 10 488 167	<b>220.104</b>	54			
50 10 138 060	See	50 10 130 453	50 10 530 366	225.049	234			
50 10 138 446	See	50 10 130 453	50 10 557 243	See	50 10 060 764			

Adattabile a / Suitable to :

**SCANIA**

204749	See	1368681
243664	See	350270
255293	See	1107674
273621	See	1368682
275460	<b>189.505</b>	272

Date

2010 / 2011

Table

Index

References **O.E.M.**

O.E.M. no.	CEI no.	Pag.	O.E.M. no.	CEI no.	Pag.	O.E.M. no.	CEI no.	Pag.
278663	See	352635	550729	See	550730	1384027	See	1769597
278664	See	352635	550730	<b>198.619</b>	163	1384897	<b>189.403</b>	135
278665	<b>198.596</b>	66	550731	<b>230.040</b>	164	1384898	<b>189.402</b>	135
278666	See	278665	550732	<b>198.377</b>	163	1385251	See	1409918
283642	<b>189.504</b>	272	550733	<b>198.533</b>	163	1393298	225.127	240
283783	See	1738380	550800	<b>226.077</b>	239	1395614	See	1734019
283784	See	1358793	550800	<b>226.077</b>	240	1395614	See	1897333
291395	See	291396	550800	<b>226.077</b>	241	1399180	225.124	239
291396	<b>198.597</b>	66	550806	<b>226.078</b>	239	1405343	230.041	166
300308	See	1369917	550807	226.108	240	1409918	See	1897335
305319	See	1384897	550808	226.109	240	1428347	<b>225.125</b>	239
305320	See	1384898	638862	<b>226.018</b>	243	1428347	<b>225.125</b>	241
306913	See	1369917	639287	See	638862	1428349	<b>225.123</b>	239
306981	<b>220.012</b>	66	1104335	See	638862	1428349	<b>225.123</b>	240
310979	<b>221.048</b>	131	1107674	<b>260.096</b>	292	1439284	See	1440294
310980	<b>221.049</b>	131	1112023	220.264	67	1440028	See	1722582
328702	See	382780	1112511	<b>220.134</b>	69	1440029	See	1740364
345124	220.270	68	1300284	<b>220.133</b>	68	1440294	<b>260.159</b>	292
349254	See	1368682	1304569	See	1369919	1444472	226.132	238
350270	<b>221.047</b>	136	1304571	<b>198.690</b>	69	1464611	225.126	240
352635	198.658	66	1305012	See	1324483	1485758	See	1486757
352645	See	1337366	1324483	<b>220.165</b>	69	1486756	225.186	242
352646	See	1337367	1326775	See	1428349	1486757	225.187	242
370875	See	1369919	1337366	221.042	130	1486758	225.184	241
371451	See	1384897	1337367	221.019	130	1498131	226.134	241
371452	See	1384898	1353445	See	1464611	1498131	226.134	242
381339	See	1304571	1356055	See	1768898	1501030	See	1409918
382774	See	1369917	1357674	See	1738379	1722582	225.179	238
382780	220.272	68	1358792	See	1738380	1722753	226.135	241
389151	220.271	68	1358793	<b>198.525</b>	130	1722753	226.135	242
390784	<b>198.680</b>	67	1361413	See	1395614	1723895	See	1409918
395009	See	1738380	1368681	<b>226.007</b>	273	1734019	<b>220.176</b>	70
395010	See	1358793	1368682	<b>226.009</b>	272	1737683	See	1409918
465816	See	489987	1369411	See	1409918	1738379	<b>221.075</b>	130
466801	See	489987	1369917	220.095	67	1738380	<b>198.524</b>	130
489987	225.128	243	1369919	<b>220.021</b>	67	1738381	See	1358793
550257	<b>230.005</b>	165	1379071	See	1768898	1740364	225.180	238
550284	<b>230.013</b>	165	1379072	See	1769597	1761964	226.133	238
550711	See	550733	1379178	See	1409918	1767328	See	1358793
550713	See	550732	1379392	See	1440294	1768898	See	1847311
550714	See	550732	1379393	See	1440294	1769597	See	1847312
550722	<b>230.039</b>	164	1379423	See	1393298	1782019	225.185	241
550723	See	550733	1384025	See	1768898	1782023	225.188	242

All original equipment manufacturers numbers, symbols, pictures, models and description used in this catalogue are for reference only, and it is not implied that any part listed is the product of these manufactures.  
Tutti i nostri particolari non sono originali ma con essi intercambiabili. I riferimenti originali, le figure, i modelli sono esposti a semplice titolo indicativo. La nostra produzione riporta il nostro marchio.

# O.E.M. References

O.E.M. no.	CEI no.	Pag.	O.E.M. no.	CEI no.	Pag.	O.E.M. no.	CEI no.	Pag.
1847311	<b>220.079</b>	69	1075255	See	3173759	1587103	See	1586089
1847312	<b>220.066</b>	70	1075290	<b>260.021</b>	293	1588017	See	85114142
1897335	<b>220.067</b>	70	1075663	See	3988704	1588017	See	1626492
1953248	See	638862	1075664	See	20393063	1588263	See	1626493
			1076594	See	20554755	1590068	225.157	244
			1076595	See	20554755	1590136	See	6797169
			1076639	See	20392649	1592939	<b>220.062</b>	72
			1080690	<b>225.043</b>	245	1592939	<b>220.062</b>	76
			1080707	<b>260.153</b>	293	1592940	<b>220.003</b>	72
			1080786	<b>220.166</b>	72	1592940	<b>220.003</b>	77
			1080786	<b>220.166</b>	77	1593842	See	1075290
			1082104	<b>225.053</b>	254	1598588	<b>198.655</b>	246
			1083744	<b>220.175</b>	75	1598588	<b>198.655</b>	247
			1083745	220.274	76	1598588	<b>198.655</b>	248
			1088299	220.171	76	1598588	<b>198.655</b>	254
			1094466	See	20382314	1598588	<b>198.655</b>	255
			1131741	See	1699400	1599175	See	1626671
			1131742	See	1699401	1605035	See	1082104
			1131744	See	1698840	1606277	See	1626493
			1134445	See	6797169	1606283	<b>198.691</b>	74
			1135080	<b>226.063</b>	254	1606284	220.055	75
			1135080	<b>226.063</b>	255	1606552	225.158	244
			1137882	See	1137888	1607079	See	3944820
			1137888	<b>260.038</b>	293	1608151	See	1621419
			1505758	See	1698847	1609657	139.351	273
			1505759	See	1698846	1610074	See	1626750
			1507822	See	1698847	1610338	See	1626751
			1507823	See	1698846	1611776	<b>260.018</b>	293
			1507826	See	1695776	1613351	See	1626671
			1508080	See	1586089	1613562	See	1626749
			1509222	See	1080690	1621419	225.131	254
			1517279	See	1698190	1622111	See	6797169
			1517439	See	1698190	1622115	See	1075290
			1517440	See	1698191	1622116	See	6797169
			1517444	See	1698191	1624464	220.167	74
			1527234	<b>221.043</b>	136	1624464	220.167	81
			1576092	See	1606283	1626024	See	20556588
			1576093	See	1606284	1626492	220.174	80
			1576952	<b>198.389</b>	245	1626493	<b>198.622</b>	80
			1576953	198.631	246	1626671	<b>220.080</b>	81
			1577873	See	1609657	1626749	<b>220.018</b>	76
			1581543	<b>117.234</b>	273	1626750	198.733	75
			1586089	<b>198.451</b>	273	1626751	<b>198.623</b>	74

Adattabile a / Suitable to :

**VOLVO**

270911 See 3090267

270912 See 3090266

270920 **230.042** 167

271141 See 3090267

271142 See 3090266

271187 **226.079** 244

271187 **226.079** 250

271188 **226.136** 244

271188 **226.136** 250

273373 See 274019

273375 **198.461** 245

273706 **198.440** 245

273706 **198.440** 246

274019 **198.411** 253

274056 **198.442** 246

274068 **226.011** 244

274069 226.096 244

275988 226.114 254

276014 See 276029

276015 See 3090267

276023 See 3090266

276024 See 3090267

276029 **198.387** 167

276030 See 3090267

276031 See 3090266

276032 See 3090267

276191 See 273706

276192 **226.064** 245

276193 **230.044** 167

382613 **221.024** 136

382745 See 1527234

1071344 **220.202** 71

1075005 **220.029** 78

1075006 See 85114190

1075153 See 20393061

Date

2010 / 2011

Table

Index

References **O.E.M.**

O.E.M. no.	CEI no.	Pag.	O.E.M. no.	CEI no.	Pag.	O.E.M. no.	CEI no.	Pag.
1626896	See	20392649	3092472	<b>221.027</b>	133	6885513	See	273375
1626957	See	1626958	3093544	See	20741710	6889478	See	1698847
1626958	225.130	253	3093630	226.112	248	6889479	See	1698846
1628107	<b>226.019</b>	249	3093647	221.071	134	6889481	See	1698840
1628133	See	20556490	3093731	<b>230.043</b>	170	6889482	See	1695776
1628134	See	20556491	3098332	221.089	134	6889509	See	274019
1628483	See	3173294	3110001	See	3092471	6889512	See	273706
1628636	<b>220.048</b>	77	3110002	See	3092472	8151413	See	1609657
1629553	See	20390836	3124480	<b>220.204</b>	71	8152219	225.132	255
1629734	See	20392649	3127737	See	1071344	8153931	220.173	79
1668638	See	1527234	3159253	See	1137888	8154809	220.273	75
1695511	See	1698190	3172829	225.163	250	8156657	See	20393059
1695585	See	1695776	3173290	See	20556588	8156991	See	20556490
1695689	See	1698839	3173291	See	20556490	8156992	See	20556491
1695690	See	1697247	3173292	See	20556491	8156996	See	20556591
1695776	<b>198.626</b>	133	3173294	See	20556586	8158106	See	20554755
1696057	See	1697247	3173295	See	20556590	20375555	See	20393186
1696900	See	1699400	3173296	See	20556591	20382314	225.164	251
1696901	See	1699401	3173759	<b>226.001</b>	246	20390745	See	21106936
1696919	<b>198.475</b>	132	3173759	<b>226.001</b>	247	20390746	See	21106968
1696920	<b>198.476</b>	132	3173759	<b>226.001</b>	248	20390836	<b>198.766</b>	273
1697247	<b>221.073</b>	133	3173759	<b>226.001</b>	249	20392649	225.162	248
1698047	See	3098332	3944820	225.129	253	20393059	220.170	73
1698190	<b>198.478</b>	132	3986452	See	20393186	20393059	220.170	79
1698191	<b>198.477</b>	132	3988695	See	20393061	20393061	<b>220.076</b>	72
1698532	See	1698846	3988697	See	20393061	20393061	<b>220.076</b>	77
1698533	See	1698847	3988698	See	20393059	20393063	<b>220.056</b>	74
1698557	See	1695776	3988700	See	20393059	20393063	<b>220.056</b>	80
1698558	See	1698840	3988701	See	20393063	20393069	<b>220.034</b>	73
1698839	221.095	133	3988704	See	20393069	20393069	<b>220.034</b>	78
1698840	<b>221.001</b>	133	3988965	See	3092472	20393186	See	21106930
1698846	<b>198.624</b>	132	3988968	See	3092471	20393187	See	21406952
1698847	<b>198.625</b>	132	4941233	See	274019	20400909	See	3124480
1699400	<b>221.015</b>	134	6777855	See	3124480	20400941	<b>220.058</b>	71
1699401	<b>221.016</b>	134	6790572	See	20400941	20400944	See	1071344
3090266	<b>198.386</b>	169	6791948	See	3124480	20410530	See	20517494
3090267	<b>198.385</b>	168	6797169	<b>260.044</b>	293	20428251	See	20703338
3090712	226.113	248	6799189	<b>220.203</b>	71	20443044	225.175	255
3090727	See	3092472	6869744	See	1698840	20453123	225.182	252
3090728	See	3092471	6882111	See	1695776	20491771	See	20703338
3092452	226.110	251	6882112	See	1698840	20502944	See	20382314
3092467	<b>230.045</b>	169	6884001	See	1698847	20507262	See	20741695
3092471	<b>221.028</b>	133	6884002	See	1698846	20509018	See	20517494

All original equipment manufacturers' numbers, symbols, pictures, models and description used in this catalogue are for reference only, and it is not implied that any part listed is the product of these manufactures. Tutti i nostri particolari non sono originali ma con essi intercambiabili. I riferimenti originali, le figure, i modelli sono esposti a semplice titolo indicativo. La nostra produzione riporta il nostro marchio.

# O.E.M. References

O.E.M. no.	CEI no.	Pag.	O.E.M. no.	CEI no.	Pag.	O.E.M. no.	CEI no.	Pag.
20517494	225.189	255						
20522934	225.191	256						
20532931	225.190	256						
20547286	<b>226.117</b>	250						
20554755	<b>260.182</b>	293						
20554908	See	3173759						
20556490	<b>225.063</b>	249						
20556491	<b>225.064</b>	249						
20556586	<b>225.051</b>	247						
20556588	225.160	247						
20556590	225.159	246						
20556591	225.161	248						
20556608	See	20703338						
20703338	225.181	251						
20741695	<b>225.167</b>	250						
20741703	See	20507262						
20741710	<b>226.111</b>	250						
20741710	<b>226.111</b>	251						
20751021	<b>230.076</b>	170						
20829503	See	20392649						
21106930	<b>220.169</b>	73						
21106930	<b>220.169</b>	79						
21106936	<b>220.168</b>	73						

Adattabile a / Suitable to :

**Z.F.**

0501 203 819	See	0501 204 714
0501 204 714	<b>189.401</b>	137
0501 206 799	<b>189.403</b>	137
0501 206 800	<b>189.402</b>	137
0732 107 001	See	0501 204 714

Date

2010 / 2011

Table

Index

CEI no.	Adattabile a	O.E.M. no.	Pag.	CEI no.	Adattabile a	O.E.M. no.	Pag.
107.127	RENAULT V.I.	50 00 808 789	233	198.442	VOLVO	274056	246
117.234	VOLVO	1581543	273	198.451	VOLVO	1586089	273
117.260	RENAULT V.I.	00 00 408 526	272	198.461	MAN	81 95301 6133	219
117.261	RENAULT V.I.	00 00 408 563	272	198.461	VOLVO	273375	245
139.351	VOLVO	1609657	273	198.472	IVECO	1903652	107
139.428	IVECO	500343453	272	198.473	IVECO	500310933	107
139.429	IVECO BUS	500343454	185	198.474	IVECO	93807545	108
139.429	IVECO BUS	500343454	186	198.475	IVECO	8558527	102
139.430	IVECO BUS	4746348	185	198.475	MERCEDES	000 330 9935	117
149.074	MERCEDES	343 320 1632	203	198.475	VOLVO	1696919	132
189.278	MERCEDES	343 320 1732	203	198.476	IVECO	8558524	102
189.287	KASSBOHRER-SETRA	6851533000	121	198.476	MERCEDES	000 330 9835	117
189.287	MERCEDES	000 460 2648	119	198.476	VOLVO	1696920	132
189.324	IVECO	4670853	178	198.477	DAF	607451	114
189.401	Z.F.	0501 204 714	137	198.477	IVECO	4833825	104
189.402	SCANIA	1384898	135	198.477	MAN	81 95301 6249	123
189.402	Z.F.	0501 206 800	137	198.477	MERCEDES	000 330 9535	118
189.403	SCANIA	1384897	135	198.477	RENAULT V.I.	50 00 823 987	126
189.403	Z.F.	0501 206 799	137	198.477	VOLVO	1698191	132
189.504	SCANIA	283642	272	198.478	DAF	607452	114
189.505	SCANIA	275460	272	198.478	IVECO	4833826	104
190.276	IVECO	93161959	175	198.478	MAN	81 95301 6222	123
190.418	IVECO	42535269	176	198.478	MERCEDES	000 330 9635	118
198.252	MERCEDES	000 586 0632	203	198.478	RENAULT V.I.	50 00 823 997	126
198.252	MERCEDES	000 586 0632	204	198.478	VOLVO	1698190	132
198.261	MERCEDES	343 586 0032	203	198.479	IVECO	4665005	110
198.261	MERCEDES	343 586 0032	204	198.480	IVECO	4663972	103
198.377	SCANIA	550732	163	198.481	IVECO	4663974	103
198.385	VOLVO	3090267	168	198.482	IVECO	4665009	108
198.386	VOLVO	3090266	169	198.483	IVECO	4732041	109
198.387	VOLVO	276029	167	198.484	IVECO	4732042	109
198.389	VOLVO	1576952	245	198.485	IVECO	4688948	106
198.411	DAF	691709	192	198.485	MERCEDES	001 330 1835	120
198.411	DAF	691709	192	198.485	RENAULT V.I.	50 01 832 580	128
198.411	VOLVO	274019	253	198.486	IVECO	4688949	106
198.440	DAF	696320	190	198.486	RENAULT V.I.	50 01 832 579	128
198.440	MAN	81 95301 6132	219	198.487	IVECO	4668368	111
198.440	MAN	81 95301 6132	220	198.488	IVECO	4664343	110
198.440	MAN	81 95301 6132	221	198.489	IVECO	4664347	109
198.440	MAN	81 95301 6132	222	198.490	IVECO	4664349	109
198.440	VOLVO	273706	245	198.491	IVECO	4664462	108
198.440	VOLVO	273706	246	198.492	IVECO	42483386	105
198.442	DAF	696321	190	198.493	IVECO	42489395	105

All original equipment manufacturers' numbers, symbols, pictures, models and description used in this catalogue are for reference only, and it is not implied that any part listed is the product of these manufacturers. Tutti i nostri particolari non sono originali ma con essi intercambiabili. I riferimenti originali, le figure, i modelli sono esposti a semplice titolo indicativo. La nostra produzione riporta il nostro marchio.

Date

2010 / 2011

Table

Index



# CEI Index

CEI no.	Adattabile a	O.E.M. no.	Pag.	CEI no.	Adattabile a	O.E.M. no.	Pag.
198.494	IVECO	4579231	102	198.525	KASSBOHRER-SETRA	6851484000	121
198.495	IVECO	4579232	102	198.525	MAN	81 95301 6234	123
198.496	IVECO	4663787	103	198.525	MERCEDES	001 460 7748	118
198.497	IVECO	4663791	103	198.525	RENAULT V.I.	50 00 590 236	126
198.498	IVECO	4664292	106	198.525	SCANIA	1358793	130
198.499	IVECO	4664295	106	198.526	IVECO	61595957	4
198.500	IVECO	8558522	4	198.533	SCANIA	550733	163
198.500	IVECO BUS	8558522	18	198.535	MERCEDES	647 460 0105	28
198.501	IVECO	4665209	4	198.535	MERCEDES	647 460 0105	30
198.502	IVECO	4665501	7	198.536	MERCEDES	383 460 4405	27
198.503	IVECO	4733752	5	198.543	IVECO	4545422	8
198.503	IVECO	4733752	7	198.551	IVECO	814304	102
198.504	IVECO	4733704	6	198.552	IVECO	814305	102
198.504	IVECO	4733704	8	198.553	IVECO	4688944	110
198.505	IVECO	4699246	6	198.554	IVECO	4688946	109
198.506	IVECO	4699305	6	198.561	MAN	81 43270 6078	219
198.507	IVECO	4669091	6	198.566	IVECO BUS	4711108	19
198.507	IVECO	4669091	8	198.568	VOLVO	CEI 198568	168
198.508	IVECO	4669094	7	198.569	VOLVO	CEI 198569	169
198.508	IVECO	4669094	8	198.570	VOLVO	CEI 198570	168
198.509	IVECO	4747961	12	198.572	IVECO	4714134	179
198.509	IVECO	4747961	13	198.573	IVECO	4716271	174
198.510	IVECO	4732546	9	198.585	IVECO	42087842	11
198.511	IVECO	4732549	9	198.585	IVECO	42087842	13
198.512	IVECO	42001326	12	198.586	IVECO	61595960	5
198.513	IVECO	42042950	12	198.587	IVECO	4834037	10
198.519	IVECO	4688953	109	198.587	IVECO BUS	4834037	18
198.520	IVECO	4688952	110	198.588	IVECO	61590910	5
198.521	IVECO	4573092	7	198.589	IVECO	8590435	10
198.522	IVECO	8558220	135	198.590	IVECO	8570528	9
198.524	ASTRA	113253	112	198.591	IVECO	8591219	10
198.524	BREDA BUS	5004204	113	198.593	IVECO	8567618	9
198.524	DAF	696225	114	198.593	IVECO BUS	8567618	18
198.524	IVECO	4802444	105	198.595	IVECO	8559559	4
198.524	KASSBOHRER-SETRA	6851485000	121	198.595	IVECO BUS	8559559	18
198.524	MAN	81 95301 6237	123	198.596	SCANIA	278665	66
198.524	MERCEDES	000 460 3548	118	198.597	SCANIA	291396	66
198.524	RENAULT V.I.	00 03 401 170	126	198.598	IVECO	4833827	105
198.524	SCANIA	1738380	130	198.599	IVECO	4833828	105
198.525	ASTRA	113254	112	198.602	IVECO	4688941	104
198.525	BREDA BUS	189716	113	198.603	IVECO	4688942	104
198.525	DAF	1257890	114	198.604	IVECO	4665007	110
198.525	IVECO	4802443	105	198.605	IVECO	4664345	110

Date

2010 / 2011

Table

Index

CEI no.	Adattabile a	O.E.M. no.	Pag.	CEI no.	Adattabile a	O.E.M. no.	Pag.
198.612	DAF	1271124	191	198.643	MERCEDES	655 350 0006	213
198.612	IVECO	2980884	174	198.644	DAF	CEI 198644	191
198.612	IVECO	2980884	179	198.644	MERCEDES	000 586 1533	194
198.612	IVECO BUS	2980884	182	198.644	MERCEDES	000 586 1533	195
198.612	IVECO BUS	2980884	183	198.644	MERCEDES	000 586 1533	205
198.612	MAN	81 43220 6108	227	198.644	MERCEDES	000 586 1533	206
198.619	SCANIA	550730	163	198.644	MERCEDES	000 586 1533	207
198.622	VOLVO	1626493	80	198.644	RENAULT V.I.	50 00 819 413	234
198.623	VOLVO	1626751	74	198.644	IVECO	CEI 198644	179
198.624	VOLVO	1698846	132	198.644	IVECO BUS	CEI 198644	184
198.625	VOLVO	1698847	132	198.645	RENAULT V.I.	50 10 094 838	233
198.626	VOLVO	1695776	133	198.645	RENAULT V.I.	50 10 094 941	234
198.628	MERCEDES	620 460 3705	30	198.647	MERCEDES	000 350 0405	194
198.629	DAF	607998	114	198.647	MERCEDES	000 350 0405	195
198.629	IVECO	42493782	104	198.648	MERCEDES	658 350 0005	194
198.629	KASSBOHRER-SETRA	6851516000	121	198.650	IVECO	4664586	106
198.629	MAN	81 95301 6163	124	198.653	RENAULT V.I.	74 85 114 926	56
198.629	MERCEDES	302 330 0335	119	198.654	RENAULT V.I.	50 00 556 940	161
198.629	RENAULT V.I.	50 01 834 533	127	198.655	VOLVO	1598588	246
198.630	DAF	1331925	114	198.655	VOLVO	1598588	247
198.630	IVECO	42493781	104	198.655	VOLVO	1598588	248
198.630	KASSBOHRER-SETRA	6851517000	121	198.655	VOLVO	1598588	254
198.630	MAN	81 95301 6056	124	198.655	VOLVO	1598588	255
198.630	MERCEDES	001 330 0135	118	198.657	RENAULT V.I.	50 01 858 773	126
198.630	RENAULT V.I.	00 03 406 212	127	198.658	SCANIA	352635	66
198.631	VOLVO	1576953	246	198.666	RENAULT V.I.	50 01 858 774	127
198.632	IVECO	4815933	10	198.674	RENAULT V.I.	50 01 014 424	233
198.633	IVECO	98467459	13	198.675	IVECO BUS	4738069	184
198.634	IVECO	4854874	14	198.676	RENAULT V.I.	50 00 794 320	159
198.636	IVECO	2463582	108	198.680	SCANIA	390784	67
198.637	IVECO	2460515	108	198.681	IVECO BUS	CEI 198681	184
198.639	DAF	691704	189	198.689	IVECO BUS	CEI 198689	184
198.639	IVECO	2968454	174	198.690	SCANIA	1304571	69
198.640	IVECO	93161371	179	198.691	VOLVO	1606283	74
198.641	IVECO	42125057	179	198.695	IVECO	4716799	174
198.642	DAF	693778	191	198.699	DAF	CEI 198699	191
198.642	MERCEDES	000 586 1433	194	198.699	MAN	CEI 198699	227
198.642	MERCEDES	000 586 1433	195	198.699	IVECO	CEI 198699	174
198.642	MERCEDES	000 586 1433	205	198.699	IVECO	CEI 198699	179
198.642	MERCEDES	000 586 1433	206	198.699	IVECO BUS	CEI 198699	182
198.642	MERCEDES	000 586 1433	207	198.699	IVECO BUS	CEI 198699	183
198.642	MERCEDES	000 586 1433	211	198.699	IVECO BUS	CEI 198699	184
198.642	MERCEDES	000 586 1433	213	198.733	VOLVO	1626750	75

All original equipment manufacturers numbers, symbols, pictures, models and description used in this catalogue are for reference only, and it is not implied that any part listed is the product of these manufacturers. Tutti i nostri particolari non sono originali ma con essi intercambiabili. I riferimenti originali, le figure, i modelli sono esposti a semplice titolo indicativo. La nostra produzione riporta il nostro marchio.

# CEI Index

CEI no.	Adattabile a	O.E.M. no.	Pag.	CEI no.	Adattabile a	O.E.M. no.	Pag.
<b>198.766</b>	VOLVO	20390836	273	<b>220.044</b>	MAN	81 46711 6724	50
<b>198.968</b>	IVECO	CEI 198968	176	<b>220.047</b>	IVECO	4747961	11
<b>220.001</b>	DAF	94038	25	<b>220.047</b>	IVECO	4747961	12
220.002	IVECO BUS	4659860	19	<b>220.048</b>	VOLVO	1628636	77
<b>220.003</b>	VOLVO	1592940	72	<b>220.050</b>	MERCEDES	393 330 0303	39
<b>220.003</b>	VOLVO	1592940	77	220.055	VOLVO	1606284	75
220.004	IVECO BUS	4741957	19	<b>220.056</b>	VOLVO	20393063	74
<b>220.005</b>	IVECO	4793166	11	<b>220.056</b>	VOLVO	20393063	80
<b>220.005</b>	IVECO BUS	4793166	19	<b>220.057</b>	VOLVO	85114190	80
<b>220.006</b>	MERCEDES	675 460 2205	28	<b>220.058</b>	VOLVO	20400941	71
<b>220.007</b>	MAN	81 46610 6722	48	<b>220.059</b>	MERCEDES	001 460 6705	35
<b>220.008</b>	RENAULT V.I.	74 85 114 927	55	220.060	RENAULT V.I.	74 85 114 925	56
<b>220.009</b>	MAN	81 46710 6354	50	220.061	RENAULT V.I.	74 85 120 948	55
220.010	RENAULT V.I.	50 10 144 556	55	<b>220.062</b>	VOLVO	1592939	72
220.011	IVECO	4715615	11	<b>220.062</b>	VOLVO	1592939	76
<b>220.012</b>	SCANIA	306981	66	<b>220.063</b>	RENAULT V.I.	50 10 130 456	52
<b>220.013</b>	IVECO	98446354	15	<b>220.064</b>	RENAULT V.I.	50 10 294 288	57
<b>220.014</b>	IVECO	41005463	16	<b>220.065</b>	RENAULT V.I.	50 10 294 287	57
<b>220.014</b>	IVECO	41005463	17	<b>220.066</b>	SCANIA	1847312	70
220.016	IVECO BUS	42044493	20	<b>220.067</b>	SCANIA	1897335	70
<b>220.018</b>	VOLVO	1626749	76	<b>220.068</b>	RENAULT V.I.	50 10 060 764	59
<b>220.019</b>	MERCEDES	676 460 1105	29	<b>220.076</b>	VOLVO	20393061	72
<b>220.021</b>	SCANIA	1369919	67	<b>220.076</b>	VOLVO	20393061	77
220.022	RENAULT V.I.	50 10 130 483	54	<b>220.077</b>	DAF	1351714	24
220.023	IVECO BUS	4672795	20	<b>220.078</b>	DAF	1351715	24
<b>220.024</b>	RENAULT V.I.	74 85 114 936	52	<b>220.079</b>	SCANIA	1847311	69
<b>220.025</b>	RENAULT V.I.	50 10 239 340	56	<b>220.080</b>	VOLVO	1626671	81
<b>220.026</b>	RENAULT V.I.	50 10 207 725	63	<b>220.081</b>	MERCEDES	001 460 0705	36
<b>220.027</b>	MERCEDES	300 460 0705	39	<b>220.082</b>	MERCEDES	002 460 4305	36
<b>220.028</b>	MERCEDES	300 460 0505	38	<b>220.083</b>	MERCEDES	002 460 4805	36
<b>220.029</b>	VOLVO	1075005	78	<b>220.084</b>	MERCEDES	000 460 9305	35
<b>220.030</b>	MERCEDES	001 460 0405	31	<b>220.085</b>	MERCEDES	001 460 9805	36
<b>220.031</b>	MERCEDES	383 460 4505	27	<b>220.086</b>	MERCEDES	941 330 0103	41
<b>220.032</b>	MERCEDES	673 460 0605	28	<b>220.087</b>	MERCEDES	942 330 0103	42
<b>220.034</b>	VOLVO	20393069	73	<b>220.088</b>	MERCEDES	945 330 0103	42
<b>220.034</b>	VOLVO	20393069	78	<b>220.089</b>	MERCEDES	945 330 0203	41
<b>220.035</b>	MERCEDES	617 460 3405	29	<b>220.090</b>	MERCEDES	942 330 0903	41
<b>220.037</b>	MERCEDES	620 460 3005	30	<b>220.091</b>	RENAULT V.I.	50 10 294 199	53
<b>220.038</b>	MERCEDES	675 460 3005	28	<b>220.092</b>	RENAULT V.I.	50 10 488 165	53
<b>220.039</b>	MAN	81 46711 6759	51	220.093	RENAULT V.I.	50 00 541 230	52
<b>220.040</b>	MERCEDES	000 460 9805	31	220.095	SCANIA	1369917	67
<b>220.042</b>	MERCEDES	625 330 2503	40	<b>220.098</b>	RENAULT V.I.	50 10 488 052	61
<b>220.043</b>	MERCEDES	620 330 0503	40	220.100	RENAULT V.I.	50 10 383 410	53

Date

2010 / 2011

Table

Index

CEI no.	Adattabile a	O.E.M. no.	Pag.	CEI no.	Adattabile a	O.E.M. no.	Pag.
<b>220.101</b>	RENAULT V.I.	50 10 566 048	63	<b>220.164</b>	MERCEDES	949 330 0203	41
<b>220.102</b>	RENAULT V.I.	50 10 294 502	57	<b>220.165</b>	SCANIA	1324483	69
<b>220.103</b>	RENAULT V.I.	50 10 630 617	58	<b>220.166</b>	VOLVO	1080786	72
<b>220.104</b>	RENAULT V.I.	50 10 488 167	54	<b>220.166</b>	VOLVO	1080786	77
<b>220.105</b>	RENAULT V.I.	50 10 566 062	63	<i>220.167</i>	VOLVO	1624464	74
<b>220.110</b>	RENAULT V.I.	50 10 566 058	63	<i>220.167</i>	VOLVO	1624464	81
<b>220.112</b>	RENAULT V.I.	50 10 130 344	60	<b>220.168</b>	VOLVO	21106936	73
<b>220.117</b>	MERCEDES	619 460 2905	31	<b>220.168</b>	VOLVO	21106936	78
<b>220.119</b>	MERCEDES	001 460 2905	32	<b>220.169</b>	VOLVO	21106930	73
<i>220.125</i>	MERCEDES	625 330 1203	42	<b>220.169</b>	VOLVO	21106930	79
<b>220.127</b>	MAN	81 46610 6305	43	<i>220.170</i>	VOLVO	20393059	73
<b>220.130</b>	MAN	81 46611 6197	49	<i>220.170</i>	VOLVO	20393059	79
<b>220.131</b>	MERCEDES	974 460 1205	33	<i>220.171</i>	VOLVO	1088299	76
<b>220.132</b>	MERCEDES	002 460 5005	34	<b>220.172</b>	MERCEDES	625 460 2505	30
<b>220.133</b>	SCANIA	1300284	68	<i>220.173</i>	VOLVO	8153931	79
<b>220.134</b>	SCANIA	1112511	69	<i>220.174</i>	VOLVO	1626492	80
<b>220.135</b>	IVECO	98475709	14	<b>220.175</b>	VOLVO	1083744	75
<i>220.136</i>	IVECO	98473328	14	<b>220.176</b>	SCANIA	1734019	70
<i>220.137</i>	IVECO	98493054	15	<b>220.177</b>	MERCEDES	970 460 0705	32
<b>220.138</b>	IVECO	98469650	15	<b>220.178</b>	MERCEDES	972 460 1405	32
<b>220.139</b>	IVECO	41005475	16	<b>220.179</b>	MERCEDES	972 460 1805	33
<b>220.140</b>	IVECO	500397738	16	<b>220.180</b>	MERCEDES	972 460 2805	34
<b>220.140</b>	IVECO	500397738	17	<b>220.181</b>	MERCEDES	002 460 4605	34
<i>220.141</i>	IVECO BUS	500336085	20	<b>220.182</b>	MERCEDES	970 330 0003	40
<i>220.142</i>	IVECO BUS	98420110	20	<b>220.183</b>	IVECO	98402544	13
<i>220.143</i>	IVECO BUS	500311471	21	<b>220.183</b>	IVECO BUS	98402544	21
<i>220.144</i>	IVECO BUS	4838587	22	<b>220.184</b>	MERCEDES	003 460 4405	35
<i>220.145</i>	IVECO BUS	4826513	22	<b>220.185</b>	MERCEDES	002 460 7705	35
<b>220.150</b>	DAF	1351734	26	<b>220.186</b>	RENAULT V.I.	50 10 439 022	64
<i>220.151</i>	MERCEDES	387 460 4805	27	<b>220.187</b>	RENAULT V.I.	50 10 439 021	64
<i>220.152</i>	MERCEDES	387 460 4405	27	<b>220.193</b>	DAF	1351735	26
<b>220.153</b>	MERCEDES	002 460 1405	31	<b>220.196</b>	MAN	81 46611 6199	49
<i>220.154</i>	MERCEDES	356 330 0003	39	<b>220.197</b>	MAN	81 46711 6860	51
<i>220.155</i>	MERCEDES	356 330 0103	39	<b>220.202</b>	VOLVO	1071344	71
<b>220.156</b>	MAN	85 46610 6104	43	<b>220.203</b>	VOLVO	6799189	71
<i>220.157</i>	RENAULT V.I.	50 00 446 680	52	<b>220.204</b>	VOLVO	3124480	71
<b>220.158</b>	RENAULT V.I.	50 10 488 164	53	<b>220.205</b>	DAF	1353396	26
<b>220.159</b>	RENAULT V.I.	50 10 488 166	54	<b>220.206</b>	IVECO BUS	4704183	22
<b>220.160</b>	RENAULT V.I.	50 10 488 146	54	<b>220.207</b>	MAN	85 46610 6102	43
<i>220.161</i>	RENAULT V.I.	58 10 112 248	55	<b>220.208</b>	IVECO	41215165	17
<i>220.162</i>	RENAULT V.I.	50 10 239 387	56	<b>220.209</b>	IVECO	504049893	15
<b>220.163</b>	RENAULT V.I.	50 10 383 203	60	<i>220.210</i>	IVECO BUS	42542824	21
<b>220.164</b>	MERCEDES	949 330 0203	40	<i>220.211</i>	IVECO BUS	500359179	21

All original equipment manufacturers numbers, symbols, pictures, models and description used in this catalogue are for reference only, and it is not implied that any part listed is the product of these manufactures. Tutti i nostri particolari non sono originali ma con essi intercambiabili. I riferimenti originali, le figure, i modelli sono esposti a semplice titolo indicativo. La nostra produzione riporta il nostro marchio.

# CEI Index

CEI no.	Adattabile a	O.E.M. no.	Pag.	CEI no.	Adattabile a	O.E.M. no.	Pag.
220.213	DAF	1405309	24	220.260	RENAULT V.I.	50 01 868 384	58
<b>220.214</b>	DAF	1426101	26	220.261	RENAULT V.I.	50 01 868 385	59
<b>220.215</b>	MERCEDES	667 460 1705	32	220.262	RENAULT V.I.	50 01 868 386	59
220.216	MERCEDES	676 460 2105	29	220.263	RENAULT V.I.	50 01 868 419	59
220.217	MERCEDES	676 460 3105	29	220.264	SCANIA	1112023	67
220.218	MERCEDES	974 460 0005	34	220.265	RENAULT V.I.	50 10 294 720	57
220.219	MERCEDES	974 460 2205	33	220.266	RENAULT V.I.	50 10 557 524	62
<b>220.220</b>	MERCEDES	972 460 1205	33	220.267	RENAULT V.I.	50 10 600 487	62
220.221	MERCEDES	001 460 8105	37	220.268	RENAULT V.I.	74 20 761 145	62
220.222	MERCEDES	002 460 9005	38	220.270	SCANIA	345124	68
220.223	MERCEDES	002 460 6205	37	220.271	SCANIA	389151	68
220.224	MERCEDES	002 460 9305	38	220.272	SCANIA	382780	68
220.225	MERCEDES	002 460 6005	37	220.273	VOLVO	8154809	75
<b>220.226</b>	MERCEDES	002 460 5205	37	220.274	VOLVO	1083745	76
<b>220.227</b>	MERCEDES	001 460 7105	38	220.275	VOLVO	21106968	78
<b>220.228</b>	MAN	85 46610 6140	44	220.276	VOLVO	21406952	79
220.229	MAN	85 46610 6155	46	220.277	RENAULT V.I.	50 10 566 064	64
<b>220.230</b>	MAN	85 46610 6235	46	220.278	RENAULT V.I.	50 01 868 363	65
220.231	MAN	85 46610 6103	43	220.279	RENAULT V.I.	50 01 868 366	65
<b>220.232</b>	MAN	81 46710 6442	45	<b>220.280</b>	IVECO	500324282	14
<b>220.233</b>	MAN	81 46710 6438	46	<b>220.281</b>	DAF	1602820	24
<b>220.234</b>	MAN	81 46710 6436	45	<b>220.282</b>	DAF	1602821	25
<b>220.236</b>	MAN	85 46610 6141	44	<b>220.283</b>	DAF	1448064	25
220.237	MAN	85 46610 6143	44	<b>220.284</b>	DAF	1351716	25
<b>220.238</b>	MAN	85 46610 6142	44	<b>220.285</b>	MAN	82 46610 6191	49
<b>220.241</b>	MAN	85 46610 6150	45	<b>220.286</b>	MAN	81 46710 6418	48
<b>220.242</b>	MAN	85 46610 6151	45	<b>220.287</b>	MAN	81 46711 6736	50
220.244	MAN	85 46610 6245	47	<b>220.288</b>	RENAULT V.I.	50 10 566 059	64
220.245	MAN	85 46610 6244	46	<b>220.289</b>	RENAULT V.I.	50 10 630 821	65
220.246	MAN	85 46610 6246	47	220.290	IVECO	4854871	17
220.247	MAN	85 46610 6247	47	<b>221.001</b>	VOLVO	1698840	133
220.248	MAN	85 46610 6163	48	<b>221.002</b>	IVECO	4336779	107
220.249	MAN	85 46610 6162	47	221.003	IVECO	4388159	107
220.250	MAN	85 46610 6166	48	221.004	IVECO	7567284	107
220.251	MAN	81 46611 6201	49	<b>221.005</b>	DAF	67303	116
220.252	RENAULT V.I.	50 10 259 241	62	<b>221.006</b>	DAF	67389	116
220.253	RENAULT V.I.	50 01 868 374	60	<b>221.007</b>	ASTRA	113251	112
220.254	RENAULT V.I.	50 01 868 375	61	<b>221.008</b>	ASTRA	113252	112
220.255	RENAULT V.I.	50 01 868 376	61	<b>221.013</b>	MERCEDES	001 330 2635	120
220.256	RENAULT V.I.	50 01 868 377	61	<b>221.014</b>	MERCEDES	001 330 2735	120
220.257	RENAULT V.I.	50 10 557 523	60	<b>221.015</b>	VOLVO	1699400	134
220.258	RENAULT V.I.	50 01 868 382	58	<b>221.016</b>	VOLVO	1699401	134
220.259	RENAULT V.I.	50 01 868 383	58	<b>221.017</b>	DAF	606922	116

Date

2010 / 2011

Table

Index

CEI no.	Adattabile a	O.E.M. no.	Pag.	CEI no.	Adattabile a	O.E.M. no.	Pag.
<b>221.018</b>	DAF	606923	116	<b>221.062</b>	MAN	81 95301 6312	124
221.019	DAF	1326861	115	221.063	RENAULT V.I.	50 01 832 582	127
221.019	SCANIA	1337367	130	221.065	RENAULT V.I.	50 01 847 437	125
<b>221.020</b>	IVECO	500337201	108	221.066	RENAULT V.I.	50 01 847 436	125
<b>221.021</b>	IVECO	8193649	103	221.067	RENAULT V.I.	50 01 851 800	126
<b>221.021</b>	MAN	81 95301 0078	123	221.068	RENAULT V.I.	50 01 852 264	127
<b>221.021</b>	MERCEDES	000 330 8635	117	221.069	RENAULT V.I.	50 01 858 756	125
<b>221.021</b>	RENAULT V.I.	50 00 814 096	125	221.070	RENAULT V.I.	50 01 858 757	125
<b>221.022</b>	IVECO	42491937	103	221.071	VOLVO	3093647	134
<b>221.022</b>	MAN	81 95301 0077	123	<b>221.073</b>	VOLVO	1697247	133
<b>221.022</b>	MERCEDES	000 330 8535	117	<b>221.074</b>	IVECO	42534911	107
<b>221.022</b>	RENAULT V.I.	50 01 860 123	125	<b>221.075</b>	SCANIA	1738379	130
<b>221.024</b>	VOLVO	382613	136	221.076	RENAULT V.I.	50 00 288 366	129
<b>221.027</b>	VOLVO	3092472	133	221.077	RENAULT V.I.	50 00 288 367	129
<b>221.028</b>	VOLVO	3092471	133	221.078	RENAULT V.I.	50 01 858 763	128
<b>221.029</b>	DAF	1205215	116	221.082	DAF	1401942	115
<b>221.030</b>	DAF	1205248	116	221.083	DAF	1407394	115
<b>221.033</b>	MAN	81 95301 6274	124	221.084	DAF	1389190	115
<b>221.033</b>	MERCEDES	001 460 2248	120	221.086	MAN	81 95301 6288	124
<b>221.034</b>	MERCEDES	001 460 4248	118	<b>221.087</b>	DAF	1458874	115
221.035	MERCEDES	901 333 1127	120	221.088	DAF	1638472	115
221.039	IVECO	41203863	135	221.089	VOLVO	3098332	134
221.040	IVECO	41203864	135	221.093	KASSBOHRER-SETRA	6851446000	121
221.041	IVECO	42042912	135	221.095	VOLVO	1698839	133
221.042	SCANIA	1337366	130	<b>225.001</b>	IVECO	41042050	175
<b>221.043</b>	VOLVO	1527234	136	<b>225.002</b>	IVECO	98472466	180
<b>221.045</b>	KASSBOHRER-SETRA	6851521001	122	225.005	MERCEDES	620 350 0106	213
<b>221.045</b>	MERCEDES	001 460 0548	119	<b>225.006</b>	MAN	81 43230 6037	226
<b>221.046</b>	KASSBOHRER-SETRA	6851528000	122	225.007	MERCEDES	395 320 1532	206
<b>221.046</b>	MERCEDES	000 460 5748	119	<b>225.008</b>	MAN	81 43220 6129	227
<b>221.047</b>	SCANIA	350270	136	225.009	MERCEDES	655 350 0306	213
<b>221.048</b>	SCANIA	310979	131	225.010	MERCEDES	652 350 0306	212
<b>221.049</b>	SCANIA	310980	131	225.011	MERCEDES	385 350 0206	204
<b>221.051</b>	RENAULT V.I.	50 00 288 362	129	<b>225.012</b>	IVECO	41011006	178
<b>221.052</b>	RENAULT V.I.	50 00 288 363	129	<b>225.012</b>	IVECO	41011006	181
221.054	RENAULT V.I.	50 01 852 452	127	225.014	IVECO BUS	98488010	187
<b>221.055</b>	IVECO	500309296	106	<b>225.015</b>	RENAULT V.I.	50 10 094 839	235
221.056	IVECO	500340769	111	<b>225.019</b>	MAN	81 43220 6052	226
<b>221.057</b>	MERCEDES	001 330 0335	119	225.021	MERCEDES	659 350 1506	209
<b>221.058</b>	MERCEDES	001 460 3848	119	225.022	MERCEDES	659 350 1606	208
221.059	MERCEDES	000 460 7748	117	225.023	MERCEDES	659 350 0406	209
221.060	MERCEDES	000 460 7848	117	225.024	MERCEDES	659 350 3406	210
<b>221.061</b>	MERCEDES	001 460 2948	120	225.027	IVECO	41034479	176

All original equipment manufacturers' numbers, symbols, pictures, models and description used in this catalogue are for reference only, and it is not implied that any part listed is the product of these manufacturers. Tutti i nostri particolari non sono originali ma con essi intercambiabili. I riferimenti originali, le figure, i modelli sono esposti a semplice titolo indicativo. La nostra produzione riporta il nostro marchio.



# CEI Index

CEI no.	Adattabile a	O.E.M. no.	Pag.	CEI no.	Adattabile a	O.E.M. no.	Pag.
<b>225.028</b>	RENAULT V.I.	50 10 389 262	234	<b>225.087</b>	MERCEDES	381 350 0206	205
<b>225.031</b>	MAN	81 43220 6042	231	<b>225.088</b>	MERCEDES	395 320 0132	205
<b>225.032</b>	MAN	81 43220 6025	231	<b>225.089</b>	MERCEDES	393 320 0232	206
<b>225.033</b>	MAN	81 43220 6092	228	<b>225.090</b>	MERCEDES	395 320 1432	207
<b>225.035</b>	MAN	81 43220 6043	231	<b>225.091</b>	MERCEDES	385 350 0006	207
<b>225.036</b>	MAN	81 43220 6129	228	<b>225.092</b>	MERCEDES	624 350 0606	208
<b>225.037</b>	RENAULT V.I.	50 10 207 727	237	<b>225.093</b>	MERCEDES	624 350 0306	208
<b>225.038</b>	RENAULT V.I.	50 10 207 726	236	<b>225.094</b>	MERCEDES	659 350 0106	209
<b>225.039</b>	MERCEDES	942 350 1205	197	<b>225.095</b>	MERCEDES	659 350 1206	210
<b>225.040</b>	MERCEDES	947 350 0105	198	<b>225.096</b>	MERCEDES	659 350 1906	210
<b>225.043</b>	VOLVO	1080690	245	<b>225.097</b>	MERCEDES	659 350 0906	211
<b>225.048</b>	IVECO	CEI 225048	176	<b>225.098</b>	MERCEDES	653 350 0106	211
<b>225.049</b>	RENAULT V.I.	50 10 530 366	234	<b>225.099</b>	MERCEDES	654 350 0506	212
<b>225.050</b>	IVECO	41042092	175	<b>225.100</b>	MERCEDES	974 330 0107	214
<b>225.051</b>	VOLVO	20556586	247	<b>225.101</b>	MERCEDES	972 330 0211	214
<b>225.053</b>	VOLVO	1082104	254	<b>225.102</b>	MERCEDES	972 330 0311	214
<b>225.058</b>	MERCEDES	948 350 2205	199	<b>225.103</b>	MERCEDES	948 350 1205	215
<b>225.059</b>	MERCEDES	654 350 0105	195	<b>225.104</b>	MERCEDES	948 350 2405	215
<b>225.060</b>	MERCEDES	948 350 3005	199	<b>225.105</b>	MERCEDES	948 350 2505	215
<b>225.061</b>	RENAULT V.I.	50 10 467 915	235	<b>225.106</b>	MERCEDES	941 330 0007	216
<b>225.063</b>	VOLVO	20556490	249	<b>225.107</b>	MERCEDES	941 330 0011	216
<b>225.064</b>	VOLVO	20556491	249	<b>225.108</b>	MERCEDES	945 330 0011	216
<b>225.065</b>	IVECO	41033731	177	<b>225.109</b>	MERCEDES	357 333 0905	217
<b>225.068</b>	RENAULT V.I.	50 10 094 840	235	<b>225.110</b>	MERCEDES	357 333 0205	217
<b>225.069</b>	DAF	80521	189	<b>225.111</b>	KASSBOHRER-SETRA	8226357000	218
<b>225.070</b>	IVECO	42041107	178	<b>225.112</b>	MAN	81 43220 6247	223
<b>225.070</b>	IVECO	42041107	180	<b>225.113</b>	MAN	81 43230 6031	225
<b>225.071</b>	IVECO BUS	4759025	185	<b>225.114</b>	MAN	81 43230 6039	225
<b>225.072</b>	IVECO BUS	4703853	185	<b>225.115</b>	MAN	81 43220 6140	227
<b>225.073</b>	IVECO BUS	4703858	185	<b>225.116</b>	MAN	81 43220 6093	229
<b>225.074</b>	IVECO BUS	4804714	186	<b>225.117</b>	MAN	81 43220 6106	229
<b>225.075</b>	IVECO BUS	4711073	186	<b>225.118</b>	MAN	81 43220 6236	230
<b>225.076</b>	IVECO BUS	4808424	186	<b>225.119</b>	MAN	81 43220 6196	230
<b>225.077</b>	IVECO BUS	500328489	187	<b>225.120</b>	MAN	81 43220 6260	230
<b>225.078</b>	IVECO BUS	4862493	187	<b>225.121</b>	RENAULT V.I.	50 10 164 533	233
<b>225.079</b>	DAF	1261101	191	<b>225.122</b>	RENAULT V.I.	00 23 123 275	233
<b>225.080</b>	DAF	267743	192	<b>225.123</b>	SCANIA	1428349	239
<b>225.081</b>	DAF	1656428	192	<b>225.123</b>	SCANIA	1428349	240
<b>225.082</b>	DAF	1620438	192	<b>225.124</b>	SCANIA	1399180	239
<b>225.083</b>	DAF	658103	193	<b>225.125</b>	SCANIA	1428347	239
<b>225.084</b>	DAF	658104	193	<b>225.125</b>	SCANIA	1428347	241
<b>225.085</b>	MERCEDES	343 320 1832	204	<b>225.126</b>	SCANIA	1464611	240
<b>225.086</b>	MERCEDES	385 350 0106	204	<b>225.127</b>	SCANIA	1393298	240

Date

2010 / 2011

Table

Index

CEI no.	Adattabile a	O.E.M. no.	Pag.	CEI no.	Adattabile a	O.E.M. no.	Pag.
225.128	SCANIA	489987	243	225.170	MAN	81 43270 6102	221
225.129	VOLVO	3944820	253	225.173	DAF	1294251	193
225.130	VOLVO	1626958	253	225.174	MAN	81 43270 6117	222
225.131	VOLVO	1621419	254	225.175	RENAULT V.I.	74 20 443 044	236
225.132	VOLVO	8152219	255	225.175	VOLVO	20443044	255
225.133	IVECO BUS	4820894	182	225.176	MAN	81 43220 6271	222
225.134	IVECO BUS	99484068	182	225.177	MAN	81 43220 6319	229
<b>225.135</b>	IVECO BUS	4865483	183	225.178	IVECO	500340452	180
225.136	IVECO BUS	98487790	183	225.179	SCANIA	1722582	238
<b>225.137</b>	DAF	1793875	189	225.180	SCANIA	1740364	238
<b>225.138</b>	DAF	1793877	190	225.181	VOLVO	20703338	251
<b>225.139</b>	DAF	1793876	190	225.182	VOLVO	20453123	252
225.140	DAF	658102	191	225.183	MAN	81 43270 6129	220
225.141	MERCEDES	658 350 0105	194	225.184	SCANIA	1486758	241
225.142	MERCEDES	658 350 0205	195	225.185	SCANIA	1782019	241
225.143	MERCEDES	653 350 0405	196	225.186	SCANIA	1486756	242
225.144	MERCEDES	653 350 0305	196	225.187	SCANIA	1486757	242
225.145	MERCEDES	974 350 0505	197	225.188	SCANIA	1782023	242
225.146	MERCEDES	942 350 0205	198	225.189	VOLVO	20517494	255
<b>225.147</b>	MERCEDES	948 350 2305	200	225.190	RENAULT V.I.	74 20 532 931	236
225.148	MERCEDES	942 350 1105	200	225.190	VOLVO	20532931	256
225.149	MERCEDES	947 350 0505	201	225.191	VOLVO	20522934	256
225.150	MERCEDES	613 330 0010	201	<b>225.192</b>	IVECO	41042093	177
225.151	MERCEDES	613 330 0110	202	<b>226.001</b>	VOLVO	3173759	246
225.152	MAN	81 43270 6053	219	<b>226.001</b>	VOLVO	3173759	247
225.153	MAN	81 43270 6077	220	<b>226.001</b>	VOLVO	3173759	248
<b>225.154</b>	MAN	81 43270 6096	221	<b>226.001</b>	VOLVO	3173759	249
<b>225.155</b>	MAN	81 43270 6087	223	<b>226.004</b>	IVECO	42535781	175
225.156	MAN	81 43270 6039	224	<b>226.004</b>	IVECO	42535781	177
225.157	VOLVO	1590068	244	<b>226.006</b>	IVECO	93192361	177
225.158	VOLVO	1606552	244	<b>226.006</b>	IVECO	93192361	180
225.159	VOLVO	20556590	246	<b>226.007</b>	SCANIA	1368681	273
225.160	VOLVO	20556588	247	<b>226.009</b>	SCANIA	1368682	272
225.161	VOLVO	20556591	248	<b>226.010</b>	ASTRA	100862	188
225.162	RENAULT V.I.	74 20 829 503	232	<b>226.011</b>	IVECO	93192618	178
225.162	VOLVO	20392649	248	<b>226.011</b>	IVECO	93192618	180
225.163	VOLVO	3172829	250	<b>226.011</b>	MERCEDES	000 350 0613	204
225.164	VOLVO	20382314	251	<b>226.011</b>	MERCEDES	000 350 0613	208
225.165	IVECO	41218021	181	<b>226.011</b>	MERCEDES	000 350 0613	209
225.166	IVECO	41218020	181	<b>226.011</b>	MERCEDES	000 350 0613	210
<b>225.167</b>	RENAULT V.I.	74 20 741 703	232	<b>226.011</b>	MERCEDES	000 350 0613	212
<b>225.167</b>	VOLVO	20741695	250	<b>226.011</b>	MERCEDES	000 350 0613	213
<b>225.168</b>	MAN	81 43220 6129	228	<b>226.011</b>	VOLVO	274068	244

All original equipment manufacturers' numbers, symbols, pictures, models and description used in this catalogue are for reference only, and it is not implied that any part listed is the product of these manufactures. Tutti i nostri particolari non sono originali ma con essi intercambiabili. I riferimenti originali, le figure, i modelli sono esposti a semplice titolo indicativo. La nostra produzione riporta il nostro marchio.

Date

2010 / 2011

Table

Index

# CEI Index

CEI no.	Adattabile a	O.E.M. no.	Pag.	CEI no.	Adattabile a	O.E.M. no.	Pag.
226.013	DAF	689747	191	226.049	IVECO	93162239	176
226.013	MERCEDES	000 350 1013	204	<b>226.050</b>	RENAULT V.I.	50 01 831 526	234
226.014	DAF	CEI 226014	190	<b>226.052</b>	RENAULT V.I.	50 01 842 337	234
226.014	MAN	CEI 226014	219	<b>226.052</b>	RENAULT V.I.	50 01 842 337	235
226.014	MAN	CEI 226014	220	<b>226.053</b>	RENAULT V.I.	50 00 819 365	236
226.014	MAN	CEI 226014	221	<b>226.053</b>	RENAULT V.I.	50 00 819 365	237
226.014	MAN	CEI 226014	222	<b>226.054</b>	MERCEDES	000 350 2205	198
226.014	VOLVO	CEI 226014	245	<b>226.054</b>	MERCEDES	000 350 2205	199
226.014	VOLVO	CEI 226014	246	<b>226.056</b>	DAF	1445656	189
<b>226.015</b>	MAN	CEI 226015	219	<b>226.056</b>	MERCEDES	000 350 1705	194
<b>226.015</b>	VOLVO	CEI 226015	245	<b>226.056</b>	MERCEDES	000 350 1705	195
<b>226.016</b>	MAN	81 43230 6043	225	<b>226.056</b>	MERCEDES	000 350 1705	196
<b>226.016</b>	MAN	81 43230 6043	226	226.060	RENAULT V.I.	50 00 823 228	233
226.017	MERCEDES	CEI 226017	194	<b>226.063</b>	DAF		193
226.017	MERCEDES	CEI 226017	195	<b>226.063</b>	VOLVO	1135080	254
<b>226.018</b>	DAF	689749	193	<b>226.063</b>	VOLVO	1135080	255
<b>226.018</b>	IVECO BUS	42488722	183	<b>226.064</b>	MAN	81 43270 6079	220
<b>226.018</b>	IVECO BUS	42488722	187	<b>226.064</b>	VOLVO	276192	245
<b>226.018</b>	KASSBOHRER-SETRA	82262320660	218	<b>226.066</b>	MERCEDES	000 350 2305	197
<b>226.018</b>	MAN	81 43220 6055	226	<b>226.066</b>	MERCEDES	000 350 2305	198
<b>226.018</b>	MAN	81 43220 6055	228	<b>226.066</b>	MERCEDES	000 350 2305	201
<b>226.018</b>	MAN	81 43220 6055	231	<b>226.067</b>	MERCEDES	000 350 3705	199
<b>226.018</b>	MERCEDES	000 330 0707	217	<b>226.067</b>	MERCEDES	000 350 3705	200
<b>226.018</b>	SCANIA	638862	243	<b>226.068</b>	MERCEDES	000 350 3605	200
<b>226.019</b>	VOLVO	1628107	249	<b>226.069</b>	MERCEDES	000 350 4905	199
226.020	MAN	CEI 226020	225	<b>226.070</b>	DAF	698724	189
226.020	MAN	CEI 226020	226	<b>226.070</b>	DAF	698724	190
<b>226.022</b>	IVECO	93161960	175	<b>226.072</b>	MERCEDES	000 350 1805	194
<b>226.022</b>	IVECO	93161960	176	<b>226.072</b>	MERCEDES	000 350 1805	195
<b>226.022</b>	IVECO	93161960	177	<b>226.072</b>	MERCEDES	000 350 1805	196
<b>226.025</b>	IVECO	42493431	178	<b>226.073</b>	MERCEDES	000 350 2705	215
<b>226.025</b>	IVECO	42493431	181	226.074	MERCEDES	000 330 1411	214
<b>226.025</b>	MAN	81 43270 6040	224	226.074	MERCEDES	000 330 1411	216
<b>226.025</b>	MERCEDES	000 350 0413	209	<b>226.075</b>	MAN	81 43270 6105	221
<b>226.025</b>	MERCEDES	000 350 0413	210	<b>226.075</b>	MAN	81 43270 6105	223
<b>226.025</b>	MERCEDES	000 350 0413	211	<b>226.076</b>	MAN	81 43270 6110	223
<b>226.031</b>	RENAULT V.I.	50 01 014 345	234	<b>226.077</b>	SCANIA	550800	239
<b>226.032</b>	RENAULT V.I.	50 01 823 280	235	<b>226.077</b>	SCANIA	550800	240
226.033	ASTRA	42005	188	<b>226.077</b>	SCANIA	550800	241
<b>226.036</b>	MERCEDES	000 350 1505	272	<b>226.078</b>	SCANIA	550806	239
226.038	IVECO BUS	500343812	187	<b>226.079</b>	VOLVO	271187	244
226.039	MERCEDES	000 350 0113	208	<b>226.079</b>	VOLVO	271187	250
226.039	MERCEDES	000 350 0113	210	226.080	IVECO	93161720	181

Date

2010 / 2011

Table

Index

CEI no.	Adattabile a	O.E.M. no.	Pag.	CEI no.	Adattabile a	O.E.M. no.	Pag.
226.081	IVECO BUS	93194456	182	<b>226.117</b>	RENAULT V.I.	74 20 547 286	232
226.082	IVECO BUS	42530929	182	<b>226.117</b>	VOLVO	20547286	250
<b>226.083</b>	IVECO BUS	93194458	183	226.125	MAN	81 43270 6134	220
226.084	IVECO BUS	500343452	186	226.126	MAN	81 43270 6126	222
226.085	IVECO BUS	42535445	187	226.127	MAN	81 43220 6285	222
<b>226.086</b>	DAF	1376729	189	226.128	MAN	81 43230 6315	229
226.087	DAF	689748	191	226.129	MERCEDES	000 350 0205	211
226.087	DAF	689748	193	226.130	MERCEDES	000 350 1905	212
<b>226.088</b>	DAF	1376728	192	226.131	MERCEDES	000 330 1711	214
226.089	MERCEDES	000 350 4705	197	226.132	SCANIA	1444472	238
226.089	MERCEDES	000 350 4705	200	226.133	SCANIA	1761964	238
226.090	MERCEDES	000 350 4605	197	226.134	SCANIA	1498131	241
226.090	MERCEDES	000 350 4605	200	226.134	SCANIA	1498131	242
226.091	MERCEDES	000 350 3305	197	226.135	SCANIA	1722753	241
226.092	MERCEDES	942 326 0250	198	226.135	SCANIA	1722753	242
226.093	MERCEDES	942 326 0150	198	<b>226.136</b>	VOLVO	271188	244
226.094	MERCEDES	000 330 0410	201	<b>226.136</b>	VOLVO	271188	250
226.094	MERCEDES	000 330 0410	202	<b>230.001</b>	RENAULT V.I.	50 00 794 319	159
226.095	MERCEDES	000 330 0310	201	<b>230.002</b>	RENAULT V.I.	50 00 793 849	160
226.095	MERCEDES	000 330 0310	202	<b>230.004</b>	RENAULT V.I.	50 00 793 828	159
226.096	VOLVO	274069	244	<b>230.005</b>	SCANIA	550257	165
226.097	MAN	81 43220 6250	230	230.006	SCANIA	CEI230006	164
226.098	MERCEDES	000 330 0611	217	<b>230.008</b>	RENAULT V.I.	50 00 336 305	157
226.099	IVECO	93162288	181	<b>230.009</b>	RENAULT V.I.	50 00 336 306	157
226.100	IVECO BUS	93194457	182	<b>230.010</b>	RENAULT V.I.	50 00 794 185	158
226.102	MAN	81 43230 6051	219	<b>230.011</b>	RENAULT V.I.	50 00 793 641	157
226.102	MAN	81 43230 6051	229	<b>230.012</b>	RENAULT V.I.	CEI230012	160
226.103	MAN	81 43270 6065	219	<b>230.013</b>	SCANIA	550284	165
226.104	MAN	81 96401 0152	229	<b>230.014</b>	RENAULT V.I.	CEI230014	160
226.105	MAN	81 43220 6132	230	<b>230.015</b>	IVECO	1904696	146
226.106	MAN	81 43220 6244	230	<b>230.016</b>	IVECO	1904697	146
226.107	RENAULT V.I.	50 01 823 278	235	<b>230.017</b>	MAN	81 44205 6013	155
226.108	SCANIA	550807	240	230.018	SCANIA	CEI230018	165
226.109	SCANIA	550808	240	230.019	SCANIA	CEI230019	166
226.110	VOLVO	3092452	251	<b>230.020</b>	IVECO	1904698	148
<b>226.111</b>	RENAULT V.I.	74 20 741 710	232	230.021	DAF	681511	149
<b>226.111</b>	VOLVO	20741710	250	<b>230.022</b>	DAF	681706	149
<b>226.111</b>	VOLVO	20741710	251	230.035	MAN	81 44205 6020	154
226.112	VOLVO	3093630	248	230.036	MAN	81 44205 6018	155
226.113	VOLVO	3090712	248	<b>230.037</b>	MAN	81 44205 6023	156
226.114	VOLVO	275988	254	<b>230.038</b>	MAN	81 44205 6030	156
226.115	MERCEDES	000 350 2505	201	<b>230.039</b>	SCANIA	550722	164
<b>226.117</b>	MAN	81 43270 6119	220	<b>230.040</b>	SCANIA	550731	164

All original equipment manufacturers' numbers, symbols, pictures and description used in this catalogue are for reference only, and it is not implied that any part listed is the product of these manufacturers. Tutti i nostri particolari non sono originali ma con essi intercambiabili. I riferimenti originali, le figure, i modelli sono esposti a semplice titolo indicativo. La nostra produzione riporta il nostro marchio.

# CEI Index

CEI no.	Adattabile a	O.E.M. no.	Pag.	CEI no.	Adattabile a	O.E.M. no.	Pag.
230.041	SCANIA	1405343	166	260.015	CF GOMMA	88544	281
230.042	VOLVO	270920	167	260.015	IVECO	98460983	281
230.043	VOLVO	3093731	170	260.017	CF GOMMA	88709	282
230.044	VOLVO	276193	167	260.017	IVECO BUS	4703972	282
230.045	VOLVO	3092467	169	260.018	BREDA BUS	178623	285
230.056	IVECO	42470862	146	260.018	CF GOMMA	88786	278
230.057	IVECO	42470863	147	260.018	CF GOMMA	88786	285
230.058	IVECO	2995709	147	260.018	CF GOMMA	88786	287
230.059	IVECO	2995710	147	260.018	CF GOMMA	88786	293
230.060	DAF	683499	149	260.018	IVECO	4714025	278
230.061	DAF	683470	150	260.018	MERCEDES	383 327 0001	287
230.062	MAN	81 44205 6033	154	260.018	VOLVO	1611776	293
230.063	MAN	81 44205 6019	154	260.020	CF GOMMA	88800	282
230.064	MAN	81 44205 6034	155	260.020	IVECO BUS	4703904	282
230.065	VOLVO	85108338	170	260.021	CF GOMMA	88802	287
230.066	IVECO	42471013	148	260.021	CF GOMMA	88802	290
230.067	IVECO	42471014	148	260.021	CF GOMMA	88802	293
230.068	MERCEDES	CEI 230068	151	260.021	MAN	81 43601 0036	290
230.069	MERCEDES	CEI 230069	152	260.021	MERCEDES	387 328 0101	287
230.070	MERCEDES	CEI 230070	152	260.021	VOLVO	1075290	293
230.071	MERCEDES	CEI 230071	152	260.023	BREDA BUS	5001051	285
230.072	MERCEDES	CEI 230072	153	260.023	CF GOMMA	88809	285
230.073	MERCEDES	CEI 230073	153	260.024	BREDA BUS	001800	285
230.074	MERCEDES	CEI 230074	151	260.024	CF GOMMA	88811	285
230.075	MERCEDES	CEI 230075	151	260.025	CF GOMMA	88817	278
230.076	VOLVO	20751021	170	260.025	IVECO	4714019	278
230.077	VOLVO	CEI 230077	171	260.027	BREDA BUS	5001964	286
230.078	RENAULT V.I.	CEI 230078	158	260.027	CF GOMMA	89405	286
230.079	RENAULT V.I.	CEI 230079	158	260.028	BREDA BUS	5001043	286
230.080	RENAULT V.I.	CEI 230080	161	260.028	CF GOMMA	89406	286
230.081	RENAULT V.I.	CEI 230081	161	260.030	CF GOMMA	89413	281
230.082	RENAULT V.I.	CEI 230082	162	260.030	IVECO	42107595	281
260.006	CF GOMMA	86984	283	260.033	CF GOMMA	89457	281
260.006	IVECO BUS	4680913	283	260.033	IVECO	8194818	281
260.008	CF GOMMA	87096	284	260.035	CF GOMMA	89756	278
260.008	IVECO BUS	4650232	284	260.035	IVECO	4746728	278
260.011	CF GOMMA	87408	288	260.037	BREDA BUS	192709	285
260.011	CF GOMMA	87408	291	260.037	CF GOMMA	206730	276
260.011	CF GOMMA	87408	294	260.037	CF GOMMA	206730	282
260.011	CF GOMMA	87408	298	260.037	CF GOMMA	206730	285
260.011	KASSBOHRER-SETRA	4731030000	288	260.037	CF GOMMA	206730	301
260.011	RENAULT V.I.	50 10 130 925	291	260.037	IVECO	93166129	276
260.014	CF GOMMA	88540	300	260.037	IVECO BUS	93166129	282

Date

2010 / 2011

Table

Index

CEI no.	Adattabile a	O.E.M. no.	Pag.	CEI no.	Adattabile a	O.E.M. no.	Pag.
260.038	CF GOMMA	91016	283	260.070	CF GOMMA	96898	283
260.038	CF GOMMA	91016	288	260.070	IVECO BUS	93195789	283
260.038	CF GOMMA	91016	293	260.072	CF GOMMA	96987	279
260.038	IVECO BUS	93197594	283	260.072	IVECO	98411807	279
260.038	KASSBOHRER-SETRA	4711440000	288	260.075	BREDA BUS	D031105	286
260.038	VOLVO	1137888	293	260.075	CF GOMMA	97042	286
260.040	CF GOMMA	92154	281	260.075	CF GOMMA	97042	290
260.040	CF GOMMA	92154	289	260.075	MAN	81 43601 0121	290
260.040	IVECO	42107588	281	260.076	CF GOMMA	97043	290
260.040	KASSBOHRER-SETRA	4731018000	289	260.076	MAN	81 43601 0150	290
260.041	CF GOMMA	92477	278	260.080	CF GOMMA	97300	281
260.041	IVECO	8139068	278	260.080	IVECO	42126126	281
260.042	CF GOMMA	92527	289	260.084	BREDA BUS	252933	286
260.042	KASSBOHRER-SETRA	4731007000	289	260.084	CF GOMMA	97326	286
260.044	BREDA BUS	199196	286	260.085	CF GOMMA	97390	278
260.044	CF GOMMA	92574	286	260.085	IVECO	8166340	278
260.044	CF GOMMA	92574	287	260.087	BREDA BUS	178741	286
260.044	CF GOMMA	92574	288	260.087	CF GOMMA	97555	286
260.044	CF GOMMA	92574	293	260.087	CF GOMMA	97555	287
260.044	KASSBOHRER-SETRA	4771441000	288	260.087	MERCEDES	382 327 7201	287
260.044	MERCEDES	307 327 0001	287	260.089	CF GOMMA	97608	277
260.044	VOLVO	6797169	293	260.089	CF GOMMA	97608	290
260.047	CF GOMMA	92594	283	260.089	IVECO	8188539	277
260.047	CF GOMMA	92594	290	260.089	MAN	81 43601 0125	290
260.047	CF GOMMA	92594	291	260.091	CF GOMMA	97613	279
260.047	IVECO BUS	42536242	283	260.091	IVECO	8137291	279
260.047	MAN	81 43601 0081	290	260.093	CF GOMMA	206733	276
260.047	RENAULT V.I.	50 00 786 901	291	260.093	IVECO	8188526	276
260.052	CF GOMMA	93740	296	260.096	CF GOMMA	97764	292
260.053	CF GOMMA	206750	299	260.096	CF GOMMA	97764	298
260.054	CF GOMMA	93774	299	260.096	SCANIA	1107674	292
260.057	CF GOMMA	96534	282	260.099	CF GOMMA	200751	294
260.057	CF GOMMA	96534	301	260.099	CF GOMMA	200751	299
260.057	IVECO BUS	4843220	282	260.103	CF GOMMA	201715	299
260.059	CF GOMMA	96541	283	260.104	CF GOMMA	201727	279
260.059	IVECO BUS	4843255	283	260.104	IVECO	41006926	279
260.063	CF GOMMA	96692	294	260.105	CF GOMMA	201732	276
260.064	CF GOMMA	96825	282	260.105	IVECO	41008929	276
260.064	IVECO BUS	93195986	282	260.106	CF GOMMA	201840	294
260.065	CF GOMMA	96864	299	260.108	CF GOMMA	202189	276
260.066	CF GOMMA	96871	299	260.108	IVECO	500301776	276
260.067	CF GOMMA	96873	297	260.109	CF GOMMA	202265	290
260.069	CF GOMMA	96885	299	260.109	MAN	81 43601 0140	290

All original equipment manufacturers numbers, symbols, pictures, models and description used in this catalogue are for reference only, and it is not implied that any part listed is the product of these manufactures. Tutti i nostri particolari non sono originali ma con essi intercambiabili. I riferimenti originali, le figure, i modelli sono esposti a semplice titolo indicativo. La nostra produzione riporta il nostro marchio.

Date

2010 / 2011

Table

Index



# CEI Index

CEI no.	Adattabile a	O.E.M. no.	Pag.	CEI no.	Adattabile a	O.E.M. no.	Pag.
260.113	BREDA BUS	D020990	285	260.181	CF GOMMA	206779	291
260.113	CF GOMMA	206745	282	260.181	RENAULT V.I.	50 10 294 307	291
260.113	CF GOMMA	206745	285	260.182	CF GOMMA	206778	293
260.113	IVECO BUS	42531994	282	260.182	VOLVO	20554755	293
260.122	CF GOMMA	203833	279	260.183	CF GOMMA	205536	295
260.122	IVECO	41022620	279	260.192	IVECO	41270462	279
260.134	CF GOMMA	204427	283	260.193	IVECO	41270463	279
260.134	IVECO BUS	500324098	283	260.194	IVECO	41270466	280
260.138	CF GOMMA	204466	295	260.195	IVECO	41270465	280
260.141	CF GOMMA	204530	295				
260.146	CF GOMMA	206340	298				
260.147	BREDA BUS	D042807	285				
260.147	CF GOMMA	204772	285				
260.150	CF GOMMA	205170	295				
260.153	CF GOMMA	87413/1	293				
260.153	CF GOMMA	87413/1	297				
260.153	CF GOMMA	87413/1	298				
260.153	VOLVO	1080707	293				
260.156	CF GOMMA	205598	297				
260.158	CF GOMMA	206356	295				
260.159	CF GOMMA	206201	292				
260.159	SCANIA	1440294	292				
260.160	CF GOMMA	206357	295				
260.162	CF GOMMA	206789	276				
260.162	IVECO	41019150	276				
260.163	CF GOMMA	206790	276				
260.163	IVECO	41026256	276				
260.164	CF GOMMA	206791	277				
260.164	IVECO	41026257	277				
260.165	CF GOMMA	206792	277				
260.165	IVECO	41026285	277				
260.166	CF GOMMA	206793	277				
260.166	IVECO	41026286	277				
260.167	CF GOMMA	206794	277				
260.167	IVECO	41026270	277				
260.168	CF GOMMA	206795	277				
260.168	IVECO	41026271	277				
260.170	CF GOMMA	206796	280				
260.170	IVECO	41026260	280				
260.171	CF GOMMA	205074	278				
260.171	IVECO	500364663	278				
260.176	CF GOMMA	206785	287				
260.176	MERCEDES	942 320 4321	287				

Date

2010 / 2011

Table

Index

**Ai Clienti / Importatori / Distributori prodotti C.E.I. S.p.A.:**

**“CONFORMITA’ A LEGGI E/O REGOLAMENTI SPECIFICI DELLA NAZIONE IMPORTATRICE”**

*C.E.I. S.p.A. assicura che i propri prodotti sono conformi alle Leggi e Regolamenti del Mercato Europeo e declina ogni responsabilità per applicazioni soggette a Leggi e Regolamenti specifici del Paese importatore, lasciando allo stesso la responsabilità di verificare la conformità del prodotto C.E.I. S.p.A. ai vincoli cogenti di Leggi e/o Regolamenti locali.*

*C.E.I. S.p.A. si dichiara disponibile, su richiesta del cliente, a valutare la possibilità di adeguare i propri prodotti ad eventuali specifiche esigenze che ci venissero sottoposte.*

**To Customer / Importers / Distributors of CEI Spa products :**

**“COMPLIANCE WITH LAWS AND/OR SPECIFIC REGULATIONS OF THE IMPORT COUNTRY”**

*C.E.I. S.p.A. ensures that its products conform to the laws and regulations of the European Community and declines any responsibility for applications subject to specific laws and regulations of the import country which is responsible to ascertain the conformity of CEI S.p.A. products to the local laws and/or regulations in force.*

*C.E.I. S.p.A. is available to evaluate the possibility of adapting its products for specific applications on request, should the need arise from any customer.*

**Aux clients / importateurs / distributeurs produits C.E.I. S.p.A.**

**“CONFORMITE AUX LOIS ET/OU REGLEMENTS SPECIFIQUES DU PAYS IMPORTATEUR “**

*La maison C.E.I. S.p.A. assure que ses produits sont conformes aux lois et règlements de la Communauté Européenne et décline toute responsabilité pour d'applications assujetties aux lois et règlements spécifiques du pays importateur , en laissant aux mêmes la responsabilité de vérifier la conformité du produit CEI aux obligations de lois et/ou règlements en vigueur propres du pays .*

*La maison C.E.I. S.p.A. se déclare disposée, sur requête du client, à évaluer la possibilité de conformer ses produits à d'éventuelles exigences spécifiques qui soient demandées.*

**A los clientes/importadores/distribidores del los productos CEI S.p.A.**

**“CONFORMIDAD A LAS LEYES Y/O LAS REGLAMENTACIONES ESPECIFICAS DE LA NACION IMPORTADORA “**

*CEI S.p.A certifica que sus productos están conformes con la leyes y las reglamentaciones del Mercado Europeo y declina cada responsabilidad por aplicaciones sujetas a leyes y reglamentaciones específicos del país importador, dejando al mismo la responsabilidad de averiguar la conformidad del producto CEI con los vinculos en vigencia de leyes y/o reglamentaciones locales.*

*CEI está disponible, bajo petición del cliente a evaluar la posibilidad de conformar sus productos con eventuales exigencias específicas.*

**C.E.I. COSTRUZIONE EMILIANA INGRANAGGI S.p.A**

VIA EMILIA, 239 - P.O.BOX 180  
40011 ANZOLA DELL'EMILIA, BOLOGNA, ITALY  
Tel. 39 051 6506200  
Fax 39 051 733832  
Fax Export 39 051 734128  
<http://www.cei.it>  
export e-mail [export@cei.it](mailto:export@cei.it)  
Italy e-mail [italia@cei.it](mailto:italia@cei.it)

